

**SONY**

# User Guide

Personal Computer  
**VGN-N100 Series**



# Contents

Before Use .....	6
Documentation .....	6
Ergonomic Considerations .....	8
Getting Started .....	10
Locating Controls and Ports .....	11
About the Indicator Lights .....	16
Connecting a Power Source .....	17
Using the Battery Pack .....	19
Shutting Down Your Computer Safely .....	24
Using Your VAIO Computer .....	25
Using the Keyboard .....	26
Using the Touch Pad .....	28
Using the Optical Disc Drive .....	29
Using the ExpressCard Module .....	40
Using the Memory Stick Media .....	43
Using Other Memory Cards .....	48
Using the Internet.....	51
Using Wireless LAN (WLAN) .....	52

Using Peripheral Devices .....	61
Connecting External Speakers .....	62
Connecting an External Display .....	63
Selecting Display Modes.....	66
Using the Multiple Monitors Function .....	67
Connecting an External Microphone .....	69
Connecting a Universal Serial Bus (USB) Device.....	70
Connecting a Printer .....	73
Connecting an i.LINK Device .....	74
Connecting to a Network (LAN) .....	76
Customizing Your VAIO Computer .....	77
Setting the Password .....	78
Setting Up Your Computer with VAIO Central .....	81
Using the Power Saving Modes.....	82
Managing Power with VAIO Power Management.....	87
Upgrading Your VAIO Computer.....	89
Adding and Removing Memory.....	90

Precautions .....	96
On Handling the LCD Screen .....	97
On Using the Power Source .....	98
On Handling Your Computer .....	99
On Handling Floppy Disks .....	101
On Handling Discs .....	102
On Using the Battery Pack.....	103
On Using Headphones.....	104
On Handling Memory Stick Media.....	105
On Handling the Hard Disk .....	106
Troubleshooting .....	107
Computer .....	108
System Security .....	115
Battery.....	117
Internet.....	119
Networking .....	121
Optical Discs .....	124
Display .....	129
Printing.....	131
Microphone .....	132
Mouse .....	133
Speakers.....	134
Touch Pad.....	135
Keyboard.....	136

Floppy Disks .....	137
Audio/Video.....	138
Memory Stick Media .....	139
Peripherals.....	140
Support Options .....	141
Sony Support Information .....	141
Program Support Information.....	145

## Before Use

Congratulations on your purchase of this Sony VAIO® computer, and welcome to the on-screen User Guide. Sony has combined leading-edge technology in audio, video, computing, and communications to provide state-of-the-art personal computing.

## Documentation

Your documentation includes printed information and user guides to read on your VAIO computer.

### Printed Documentation

- Welcome mat** — Contains an overview of connections, setting up information, etc.
- Safety Information** — Contains safety guidelines and owner information.

## Non-printed Documentation

- ❑ **User Guide** (this manual) — Contains features of your computer. It also includes information about the software programs included with your computer, as well as information on solving common problems.

- ❑ **Specifications** — The online **Specifications** describe the hardware and software configuration of your VAIO computer.

To view the online **Specifications**:

- 1 Connect to the Internet.
- 2 Go to the Sony online support Web site at <http://esupport.sony.com/EN/VAIO/> for customers in USA, at <http://www.sony.ca/support> for customers in Canada, at <http://esupport.sony.com/ES/VAIO/> for customers in Latin American countries or areas, or at <http://esupport.sony.com/ES/VAIO/BR/> for customers in Brazil.

- ❑ **VAIO Recovery Guide** — Provides information about restoring individual software programs, software drivers, and drive partition(s) or your entire hard disk drive to the original factory installed settings.

To access this on-screen guide:

- 1 Click **Start**, point to **All Programs**, and click **VAIO Support Central**.
- 2 Click **VAIO Documentation**.
- 3 Click **VAIO Recovery Guide**.

- ❑ **MCE Guide** (Selected models only) — Provides information about using the **Windows XP Media Center Edition** operating system.

To access this on-screen guide:

- 1 Click **Start**, point to **All Programs**, and click **VAIO Support Central**.
- 2 Click **VAIO Documentation**.
- 3 Click **MCE Guide**.

## Ergonomic Considerations

You will be using your computer as a portable device in a variety of environments. Whenever possible, you should attempt to take account of the following ergonomic considerations to both stationary and portable environments:

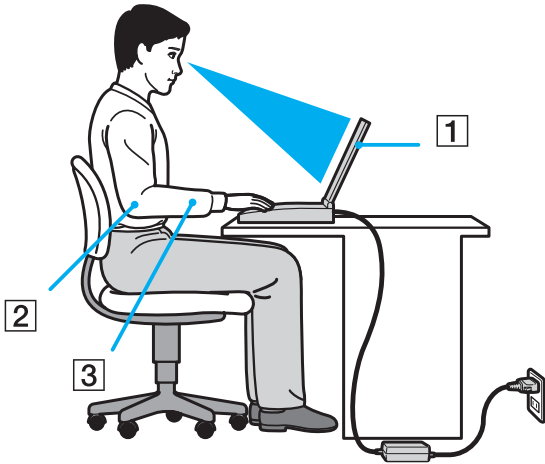

- ❑ **Position of your computer** – Place the computer directly in front of you (1). Keep your forearms horizontal (2), with your wrists in a neutral, comfortable position (3) while using the keyboard, touch pad, or external mouse. Let your upper arms hang naturally at your sides. Have breaks during sessions with your computer. Excessive use of the computer may strain muscles or tendons.
- ❑ **Furniture and posture** – Sit in a chair with good back support. Adjust the level of the chair so your feet are flat on the floor. A footrest may make you more comfortable. Sit in a relaxed, upright posture and avoid slouching forward or leaning far backwards.



- ❑ **Viewing angle of the computer's display** – Use the display's tilting feature to find the best position. You can reduce eye strain and muscle fatigue by adjusting the tilt of the display to the proper position. Adjust the brightness setting of the display as well.
- ❑ **Lighting** – Choose a location where windows and lights do not create glare and reflection on the display. Use indirect lighting to avoid bright spots on the display. You can also purchase accessories for your display that help reduce glare. Proper lighting adds to your comfort and work effectiveness.
- ❑ **Positioning an external display** – When using an external display, set the display at a comfortable viewing distance. Make sure the display screen is at eye level or slightly lower when you are sitting in front of the monitor.

# Getting Started

This section describes how to get started with using your VAIO computer.

**!** Before starting your computer for the first time, do not connect any new hardware that did not originally come with your computer. Make sure to start up your computer with only the supplied accessories connected and set up your system. Upon completion, connect one device (for example, a printer, an external hard disk drive, a scanner, and so on) at a time, following the manufacturer's instructions.

- ❑ **Locating Controls and Ports** ([page 11](#))
- ❑ **About the Indicator Lights** ([page 16](#))
- ❑ **Connecting a Power Source** ([page 17](#))
- ❑ **Using the Battery Pack** ([page 19](#))
- ❑ **Shutting Down Your Computer Safely** ([page 24](#))

# Locating Controls and Ports

Take a moment to identify the controls and ports shown on the following pages.

## Front

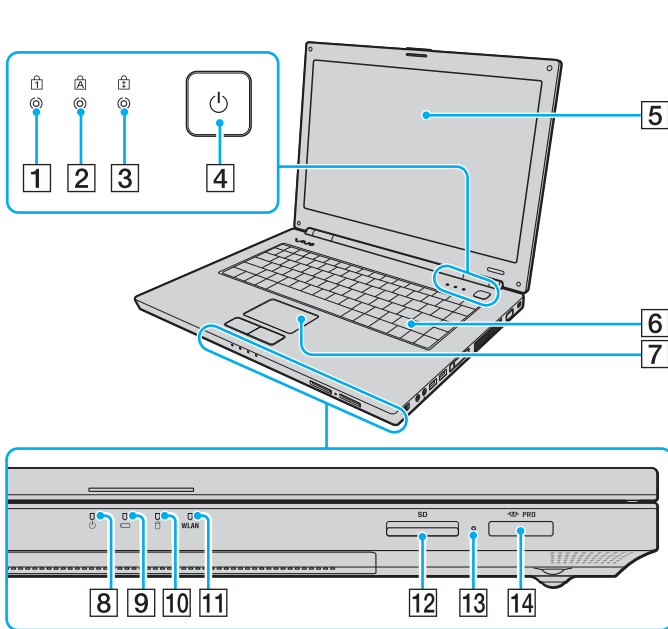

- 1 Num lock indicator (page 16)
- 2 Caps lock indicator (page 16)
- 3 Scroll lock indicator (page 16)
- 4 Power button
- 5 LCD screen (page 97)
- 6 Keyboard (page 26)
- 7 Touch pad (page 28)
- 8 Power indicator (page 16)
- 9 Battery indicator (page 16)
- 10 Hard disk drive indicator (page 16)
- 11 **WLAN** (Wireless LAN) indicator (page 16)
- 12 **SD** memory card slot (page 48)
- 13 Media Access indicator (page 16)
- 14 Memory Stick PRO/Duo media slot\* (page 45)

\* Your computer supports Memory Stick PRO media and Memory Stick Duo media with high speed and high capacity capabilities.

## Back

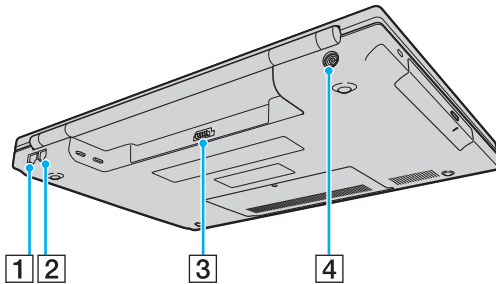

- 1 Network (Ethernet) port ([page 76](#))
- 2 Modem port ([page 51](#))
- 3 Battery connector ([page 19](#))
- 4 **DC IN** port ([page 17](#))

## Right

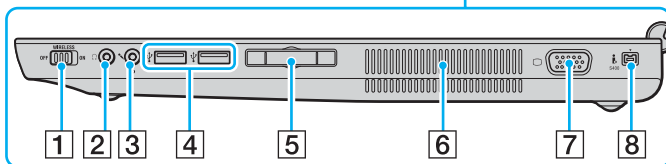
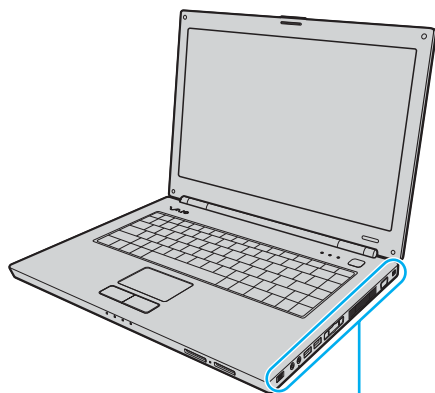

- 1 **WIRELESS** switch ([page 52](#))
- 2 Headphones jack ([page 62](#))
- 3 Microphone jack ([page 69](#))
- 4 Hi-Speed USB (USB 2.0) ports\*<sup>1</sup> ([page 70](#))
- 5 ExpressCard™/34 slot\*<sup>2</sup> ([page 40](#))
- 6 Air vents
- 7 Monitor (VGA) port ([page 63](#))
- 8 i.LINK (IEEE 1394) S400 port ([page 74](#))

\*1 Supports high-/full-/low- speeds.

\*2 Referred to as the ExpressCard slot hereinafter.

## Left

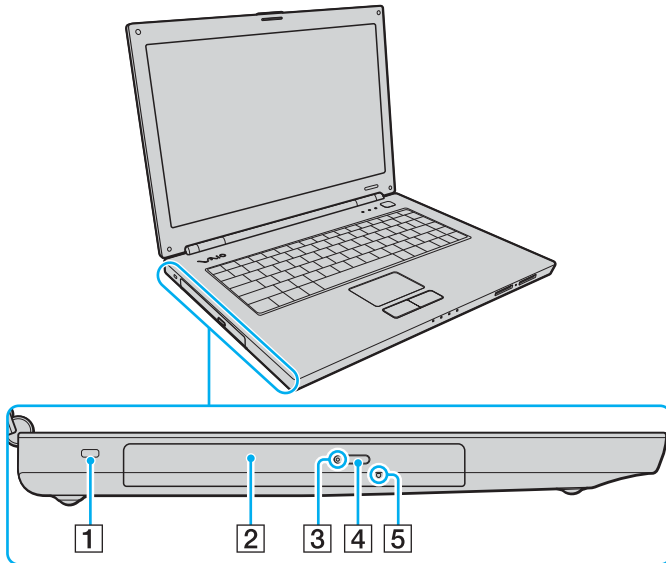

- 1 Security slot
- 2 Optical disc drive ([page 29](#))
- 3 Optical disc drive indicator ([page 16](#))
- 4 Drive eject button ([page 29](#))
- 5 Manual eject hole ([page 124](#))



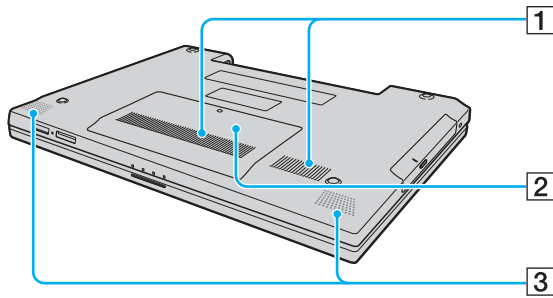



## Bottom



- 1 Air vents
- 2 Memory module compartment cover ([page 92](#))
- 3 Built-in speakers

## About the Indicator Lights

Your computer is equipped with the following indicator lights.

Indicator	Functions
Power 	Illuminates when the power of the computer is on, blinks when the computer is in Standby mode, and turns off when the computer is in Hibernate mode or off.
Battery 	Illuminates when the computer is using battery power, blinks when the battery pack is running out of power, and double-blinks when the battery pack is charging.
Media Access	Illuminates when data is read from or written to a memory card. (Do not enter Standby mode or turn off the computer when this indicator is on.) When the indicator is off, the memory card is not being used.
Optical disc drive	Illuminates when data is read from or written to the optical disc. When the indicator is off, the optical disc is not being used.
Hard disk drive 	Illuminates when data is read from or written to the hard disk. Do not enter Standby mode or turn off the computer when this indicator is on.
Num lock 	Press the <b>Num Lk</b> key to activate the numeric keypad. Press it a second time to deactivate the numeric keypad. The numeric keypad is not active when the indicator is off.
Caps lock 	Press the <b>Caps Lock</b> key to type letters in uppercase. Letters appear in lowercase if you press the <b>Shift</b> key while the indicator is on. Press the key a second time to turn off the indicator. Normal typing resumes when the Caps lock indicator is off.
Scroll lock 	Press the <b>Scr Lk</b> key to change how you scroll the display. Normal scrolling resumes when the Scroll lock indicator is off. The <b>Scr Lk</b> key functions differently depending on the program you are using and does not work with all programs.
<b>WLAN</b>	Illuminates when the wireless LAN function is running.



## Connecting a Power Source

You can use either an AC adapter or a rechargeable battery pack as a power source for your computer.

### Using the AC Adapter



Use your computer only with the supplied AC adapter.

The supplied AC adapter has an attachment on its plug to avoid accidental disconnection.

#### To use the AC adapter

- 1 Plug one end of the power cord (1) into the AC adapter (3).
- 2 Plug the other end of the power cord into an AC outlet (2).
- 3 Plug the cable attached to the AC adapter (3) into the **DC IN** port (4) on the computer, while fitting the extension of the plug attachment on the bottom of the computer as illustrated below.

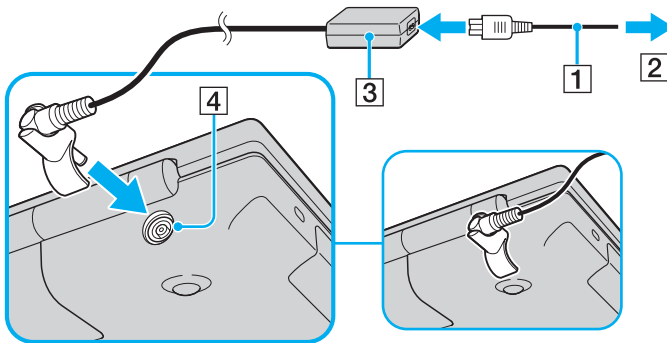



To disconnect your computer completely from AC power, unplug the AC adapter.

Make sure that the AC outlet is easily accessible.

If you do not use your computer for a long period of time, place the computer into Hibernate mode. See **Using Hibernate Mode (page 85)**. This power saving mode saves the time of shutting down or resuming.

The plug attachment can be detached and reattached with the plug in the reversed direction.

## Using the Battery Pack

The battery pack supplied with your computer is not fully charged at the time of purchase.

### Installing the Battery Pack

To install the battery pack

- 1 Turn off the computer and close the LCD screen lid.
- 2 Slide the battery lock switch (1) to the **UNLOCK** position.

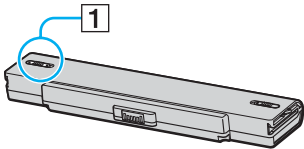

- 3 Slide the battery pack into the battery compartment until it clicks into place.

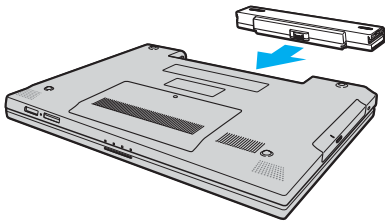

- 4 Slide the battery lock switch (1) to the **LOCK** position to secure the battery pack on the computer.



When your computer is directly connected to AC power and has a battery pack installed, it uses power from the AC outlet.

! This computer is designed to operate only with genuine Sony batteries.

## Charging the Battery Pack

The battery pack supplied with your computer is not fully charged at the time of purchase.

To charge the battery pack

- 1 Install the battery pack.
- 2 Connect the AC adapter to the computer.  
The computer automatically charges the battery pack (the battery indicator light flashes in a double blink pattern as the battery pack charges). When the battery pack is about 85% charged, the battery indicator turns off.

Battery indicator light status	Meaning
On	The computer is using battery power.
Blinks	The battery pack is running out of power.
Double blinks	The battery pack is charging.
Off	The computer is using AC power.



When the battery pack is running out of power, both the battery and power indicator lights blink.

Keep the battery pack in your computer while it is directly connected to AC power. The battery pack continues to charge while you are using the computer.

If the battery level falls below 10%, you should either attach the AC adapter to recharge the battery pack or shut down your computer and install a fully charged battery pack.

The battery pack supplied with your computer is a lithium ion battery pack and can be recharged any time. Charging a partially discharged battery pack does not affect battery life.

The battery indicator light is on while you use the battery pack as a power source. When battery life is nearly depleted, both the battery and power indicator lights start flashing.

For some software applications and some peripheral devices, your computer may not enter Hibernate mode even when battery life is low. To avoid loss of data when using battery power, you should save your data frequently and manually activate a power management mode, such as Standby or Hibernate. If the battery pack wears out when the computer enters Standby mode, you will lose any unsaved data. Going back to the previous work state is impossible. To avoid loss of data, you should save your data frequently.

When your computer is directly connected to AC power and has a battery pack installed, it uses power from the AC outlet.

## Removing the Battery Pack

! You may lose data if you remove the battery pack while your computer is on and not connected to the AC adapter or if you remove the battery pack while the computer is in Standby mode.

To remove the battery pack

- 1 Turn off the computer and close the LCD screen lid.
- 2 Slide the battery lock switch (1) to the **UNLOCK** position.

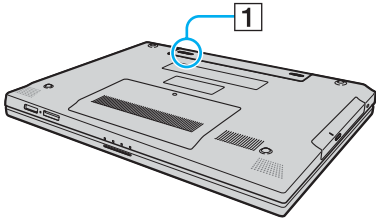

- 3 Slide and hold the battery release latch (2) and slide the battery pack away from the computer.

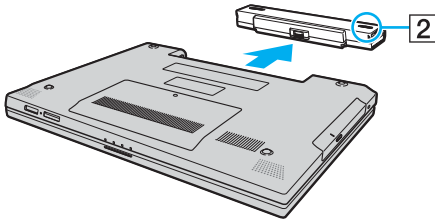

## Shutting Down Your Computer Safely

To avoid losing unsaved data, be sure to shut down your computer properly, as described below.

To shut down your computer

- 1 Turn off any peripherals connected to the computer.
- 2 Click **Start** and then **Turn Off Computer**.  
The **Turn off computer** window appears.
- 3 Click **Turn Off**.
- 4 Respond to any prompts warning you to save documents or to consider other users and wait for the computer to turn off automatically.  
The power indicator light turns off.



# Using Your VAIO Computer

This section describes how to get the most out of using your computer.

- ❑ **Using the Keyboard** ([page 26](#))
- ❑ **Using the Touch Pad** ([page 28](#))
- ❑ **Using the Optical Disc Drive** ([page 29](#))
- ❑ **Using the ExpressCard Module** ([page 40](#))
- ❑ **Using the Memory Stick Media** ([page 43](#))
- ❑ **Using Other Memory Cards** ([page 48](#))
- ❑ **Using the Internet** ([page 51](#))
- ❑ **Using Wireless LAN (WLAN)** ([page 52](#))







## Using the Keyboard

Your keyboard is very similar to a desktop computer keyboard, but has additional keys that perform model-specific tasks.

### Combinations and Functions with the Fn Key



Some functions are not available before Windows is launched.

Combinations/Feature	Functions
<b>Fn +  (F2):</b> speaker switch	Turns on and off the built-in speakers and the headphones.
<b>Fn +  (F3/F4):</b> speaker volume	Adjusts the built-in speaker volume. To increase volume, press <b>Fn+F4</b> and then <b>↑</b> or <b>→</b> , or keep pressing <b>Fn+F4</b> . To decrease volume, press <b>Fn+F3</b> and then <b>↓</b> or <b>←</b> , or keep pressing <b>Fn+F3</b> .
<b>Fn +  (F5/F6):</b> brightness control	Adjusts the LCD brightness of your computer screen. To increase lightness intensity, press <b>Fn+F6</b> and then <b>↑</b> or <b>→</b> , or keep pressing <b>Fn+F6</b> . To decrease lightness intensity, press <b>Fn+F5</b> and then <b>↓</b> or <b>←</b> , or keep pressing <b>Fn+F5</b> .
<b>Fn +  /  (F7):</b> display output	Toggles among your computer screen, an external display, and simultaneous output to both.
<b>Fn +  (F10):</b> zoom	Changes the screen resolution to magnify/restore your computer's screen view.  The magnified view is not as clear as the standard view, as it is implemented by applying a lower resolution to the computer screen with a higher resolution. This key combination may not work with graphic images as it magnifies the screen view by changing the resolution. The location and size of software windows may change when the screen view is magnified or the standard view is restored because pressing this key combination changes the resolution. When your computer's screen view is magnified, switching the view to the external display disables the function and restores the standard view.

Combinations/Feature	Functions
Fn +  (F12): Hibernate	<p>Provides for the lowest level of power consumption. When you execute this command, the states of the system and the peripheral devices are written to the hard disk and the system power is turned off. To return the system to its original state, use the power button to turn on the power.</p> <p>For details on power management, see <b>Using the Power Saving Modes</b> (<a href="#">page 82</a>).</p>

## Using the Touch Pad

You can point to, select, drag, and scroll objects on the screen using the touch pad.

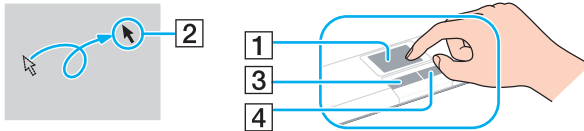

Action	Description
Point	Slide one finger on the touch pad (1) to place the pointer (2) on an item or object.
Click	Press the left button (3) once.
Double-click	Press the left button twice.
Right-click	Press the right button (4) once. In many applications, this action displays a shortcut menu.
Drag	Slide one finger on the touch pad while pressing the left button.
Scroll	Move your finger along the right edge of the touch pad to scroll vertically. Move your finger along the bottom to scroll horizontally (the scroll function is available only with applications that support a touch pad scroll feature).

## Using the Optical Disc Drive

Your computer is equipped with an optical disc drive.

To insert a disc

- 1 Turn on the computer.
- 2 Press the drive eject button (1) to open the drive.  
The tray slides out.
- 3 Place a disc in the middle of the tray with the label side facing upward and gently push it until the disc clicks into place.

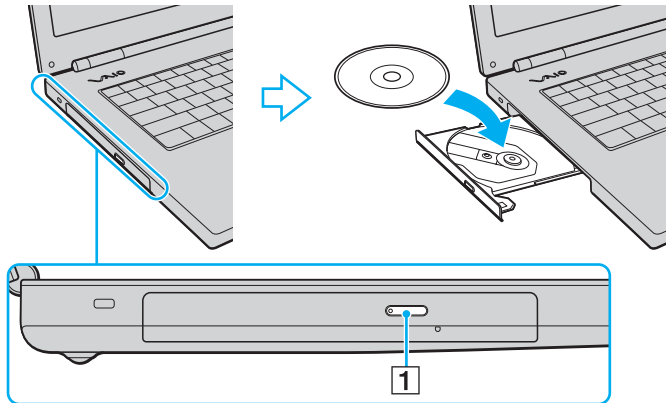

#### 4 Close the tray by pushing it in gently.



Do not remove the optical disc when your computer is in a power saving mode (Standby or Hibernate). Doing so may cause the computer to malfunction.



If you plan to use an external optical disc drive, connect the drive before you launch any preinstalled CD/DVD program.

## Reading and Writing Optical Discs

Your computer plays and records CDs and DVDs, depending on the model you purchased. Check your specifications for the type of optical disc drive installed on your model. Use the table below to see which types of media your optical disc drive supports.

PR: playable and recordable  
 P: playable but not recordable  
 -: not playable nor recordable

	CD-ROM	Video CD	Music CD	CD Extra	CD-R/RW	DVD-ROM	DVD-Video	DVD-R/RW	DVD+R/RW	DVD+R DL	DVD-R DL	DVD-RAM
DVD±RW/±R DL/RAM	P	P	P	P	PR	P	P	PR <sup>*1 *2</sup>	PR	PR <sup>*5</sup>	PR <sup>*6</sup>	PR <sup>*3 *4</sup>
DVD±RW/+R DL/RAM	P	P	P	P	PR	P	P	PR <sup>*1 *2</sup>	PR	PR <sup>*5</sup>	P	PR <sup>*3 *4</sup>
DVD±RW (Supporting DVD±R DL)	P	P	P	P	PR	P	P	PR <sup>*1 *2</sup>	PR	PR <sup>*5</sup>	PR <sup>*6</sup>	-
DVD±RW (Supporting DVD+R DL)	P	P	P	P	PR	P	P	PR <sup>*1 *2</sup>	PR	PR <sup>*5</sup>	P	-
CD-RW/DVD-ROM	P	P	P	P	PR	P	P	P	P	P	P	-
DVD-ROM	P	P	P	P	P	P	P	P	P	P	P	-

<sup>\*1</sup> Supports writing data to DVD-R discs compliant with DVD-R for General Version 2.0/2.1.

<sup>\*2</sup> Supports writing data to DVD-RW discs compliant with DVD-RW Version 1.1/1.2.

<sup>\*3</sup> The DVD±RW/RAM disc drive on your computer does not support the DVD-RAM cartridge. Use non-cartridge discs or discs with removable cartridge.

<sup>\*4</sup> Writing data to single-sided DVD-RAM discs (2.6 GB) compliant with DVD-RAM Version 1.0 is not supported.  
 DVD-RAM Version 2.2/12X-SPEED DVD-RAM Revision 5.0 disc is not supported.

<sup>\*5</sup> Writing data to DVD+R DL (Double Layer) discs is available only on discs supporting DVD+R DL (Double Layer) recording.

<sup>\*6</sup> Writing data to DVD-R DL (Dual Layer) discs is available only on discs supporting DVD-R DL (Dual Layer) recording.



PR: playable and recordable  
 P: playable but not recordable  
 -: not playable nor recordable

	CD-ROM	Video CD	Music CD	CD Extra	CD-R/RW	DVD-ROM	DVD-Video	BD-ROM	DVD-R/RW	DVD+R/RW	DVD+R DL	DVD-R DL	DVD-RAM	BD-R <sup>*9</sup> /RE <sup>*10</sup>
Blu-ray Disc Drive	P	P	P	P	PR <sup>*8</sup>	P	P	P	PR <sup>*1</sup> *2	PR	PR <sup>*5</sup>	PR <sup>*6</sup>	PR <sup>*6</sup>	PR <sup>*7</sup>

<sup>\*7</sup> Supports writing data to BD-R Version 1.1 discs (single-layer discs with the capacity of 25 GB, dual-layer discs with the capacity of 50 GB) and BD-RE Version 2.1 discs (single-layer discs with the capacity of 25 GB, dual-layer discs with the capacity of 50 GB). The Blu-ray Disc drive on your computer does not support BD-RE Version 1.0 discs and Blu-ray cartridge discs.

<sup>\*8</sup> Writing data to Ultra Speed CD-RW discs is not supported.

<sup>\*9</sup> BD-R stands for Blu-ray Disc-Recordable in Version 1.1 format.

<sup>\*10</sup> BD-RE stands for Blu-ray Disc-Rewritable in Version 2.1 format.

**!**  
 This product is designed to playback discs that conform to the Compact Disc Digital Audio standard specifications (CD Standard). A DualDisc is a two sided disc product which mates DVD recorded material on one side with digital audio material on the other side. Please be aware that the audio side (non-DVD side) of a DualDisc may not play on this product because it does not conform to the CD Standard.

Due to the multiple formats of discs now available, when buying pre-recorded or blank discs for use with a VAIO computer, be sure to read the notices on the disc packaging carefully to check both playback and recording compatibility with your computer's optical disc drives. Sony does NOT guarantee the compatibility of VAIO CD drives with discs that are not compliant with the official "CD" format standard (or "DVD" standard in relation to DVD drives). USING NON-COMPLIANT DISCS CAN CAUSE FATAL DAMAGE TO YOUR VAIO PC OR CREATE SOFTWARE CONFLICTS AND CAUSE SYSTEM HANGING. For inquiries about disc formats, contact the individual publisher of the pre-recorded disc or the manufacturer of the recordable disc.



8cm disc writing is not supported.

## Notes on writing data to a disc

- ❑ To make data on a disc readable on the optical disc drive, you need to close the session before you eject it. To complete this process, follow the instructions included with your software.
- ❑ Only use circular discs. Do not use discs in any other shape (star, heart, card, etc.), as this may damage the optical disc drive.
- ❑ Do not strike or shake your computer while writing data to a disc.
- ❑ Deactivate the screen saver and exit anti-virus software before writing data to a disc.
- ❑ Do not use memory-resident utility software while writing data to a disc. This may cause your computer to malfunction.
- ❑ When using your software application to burn discs, make sure you exit and close all other applications.
- ❑ Never touch the surface of the disc. Fingerprints and dust on the surface of a disc may cause writing errors.
- ❑ Do not switch power modes while using the preinstalled software and while using the CD burning software.
- ❑ Never affix an adhesive label to discs. This will affect the use of the disc irreparably.
- ❑ Connect and use the AC adapter to power your computer or make sure your battery pack is at least 50 percent charged.
- ❑ Some DVD players and computer's DVD drives may not be able to play DVDs created on applicable models using the **VAIO Zone** software.
- ❑ Use only Sony Value-added software when writing to CD/DVD media. (Ex: **Click to DVD**)  
Other software programs may not be fully compatible and errors may result.

## Notes on playing DVDs

To achieve optimum performance when playing DVDs, you should follow these recommendations.

- ❑ You can play DVDs using the optical disc drive and the DVD playback software, such as **VAIO Zone** or **WinDVD**. See the help file on such software for details.
- ❑ Close all open applications before playing a DVD movie.
- ❑ Do not use memory-resident utility software to speed up disc access when playing a DVD. This may cause your computer to malfunction.
- ❑ Deactivate the screen saver and exit anti-virus software before playing a disc.
- ❑ Some discs recorded at 20 or 24 bits may produce noise while playing. If you have audio devices connected, this may damage your hearing and the speakers. Reduce the volume before playing a DVD.
- ❑ Do not switch to power saving modes while your computer is playing a DVD.
- ❑ Region code indicators are labeled on the DVDs to indicate in which region and on what type of player you can play the disc. If the DVD is labeled "all," this means that you can play this DVD in most regions of the world. If the region code of your residence area is different from the label on the DVD disc or on the packaging, you cannot play the disc on your computer.

**!** You can change the DVD region code only a limited number of times. When you have exceeded this number, the drive's DVD region code is permanently assigned and you will not be able to change it again. Reconfiguring your computer does not reset this count.

If you change the DVD region code while the **WinDVD** software is running, restart the software or eject the disc and re-insert it to make the new setting effective.

- ❑ If your computer has the Wireless LAN functionality and Wireless LAN is activated, playing DVDs may cause some interruptions in audio and video.

- ❑ When you are playing a DVD (video or audio) and you want to remove a USB device, such as USB-compatible speakers, make sure you stop the DVD first. Removing a USB-compatible device during DVD (video or audio) playback may cause a malfunction.

## Playing CDs

To play an audio CD

- 1 Insert a disc into the optical disc drive.
- 2 If nothing appears on the desktop, then click **Start**, point to **All Programs**, and click to start the desired CD software, such as the **SonicStage** software.

If the **Audio CD** window appears, click to select an option.

## Copying Files to CDs

To copy files to a disc

**!** Do not strike or shake your computer while writing data to a disc.

- 1 Insert a blank disc into the optical disc drive.  
If the **CD Drive** window appears, click **Take no action** and then click **OK**.
- 2 Right-click **Start** and then click **Explore**.
- 3 In the **Folders** panel on the left, locate the file(s) or folder(s) you want to copy, right-click the file(s) or folder(s), point to **Send To**, and then click the optical disc drive\* name.
- 4 Close the window.
- 5 Click **Start** and then **My Computer**.
- 6 Click the optical disc drive icon under **Devices with Removable Storage**. A new window appears with the file(s) or folder(s) you want to copy listed under **Files Ready to Be Written to the CD**.
- 7 In the **CD Writing Tasks** box, click **Write these files to CD**.
- 8 Follow the instructions in the **CD Writing Wizard**.

\* The read/write drive letter designation may vary, depending on your system's hardware configuration.

## Playing DVDs

To play a DVD

- 1 Close all running software applications.
- 2 Insert a DVD into the optical disc drive.
- 3 If nothing appears on the desktop, then click **Start**, point to **All Programs**, and click to start the desired DVD software to play the DVD.

For instructions on how to use the software, see the help file on your DVD software.

## Copying Files to DVDs

To copy files to a disc

- 1 Connect the AC adapter to the computer.
- 2 Insert a disc into the optical disc drive.
- 3 If nothing appears on the desktop, then click **Start**, point to **All Programs**, and click to start the DVD software you want to use.

For instructions on how to use the software, see the help file on your DVD software.

## Using the ExpressCard Module

Your computer is equipped with either a Universal ExpressCard slot\* or an ExpressCard™/34 slot\* for transferring data among digital cameras, camcorders, music players, and other audio/video devices. The former can accommodate either an ExpressCard™/34 (34 mm wide) or ExpressCard™/54 (54 mm wide) module\* as shown below; and the latter, an ExpressCard™/34 module\* only.

- ExpressCard™/34 module\*



- ExpressCard™/54 module\*



Your computer is equipped with an ExpressCard™/34 slot\*.

\* Hereinafter, referred to as the ExpressCard slot and the ExpressCard module.



## Inserting an ExpressCard Module



Use care when inserting or removing the ExpressCard module from the slot. Do not force it in or out of the slot.



You do not need to shut down your computer before inserting or removing the ExpressCard module.

### To insert an ExpressCard module

- 1 Carefully slide the ExpressCard module (1) into the slot until it clicks into place. Do not force it into the slot.

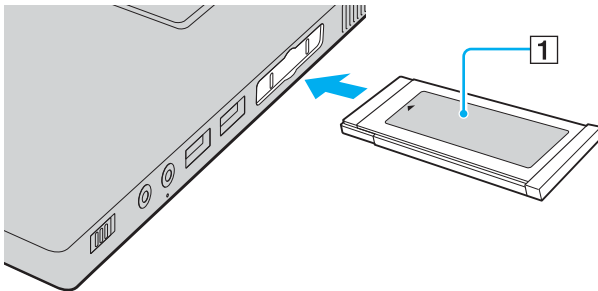

If the module or adapter does not go into the slot easily, remove it gently and verify you are inserting it in the proper direction.

Make sure you use the most recent software driver provided by the ExpressCard module manufacturer.

## Removing an ExpressCard Module

Follow the steps below to remove the ExpressCard module while your computer is on. If it is not removed properly, your system may not work properly.

To remove an ExpressCard module



To remove an ExpressCard module when your computer is off, skip steps 1 to 6.

- 1 Double-click the **Safely Remove Hardware** icon on the taskbar.  
The **Safely Remove Hardware** window appears.
- 2 Select the hardware you want to unplug.
- 3 Click **Stop**.  
The **Stop a Hardware Device** window appears.
- 4 Confirm that the device can be safely removed from the system.
- 5 Click **OK**.  
A window appears, explaining that it is safe to remove the device.
- 6 Click **Close**.
- 7 Push in the ExpressCard module toward the computer to pop it out.
- 8 Gently take hold of the ExpressCard module and pull it out of the slot.

## Using the Memory Stick Media

Your computer supports the Memory Stick media. Memory Stick media is a compact, portable, and versatile IC recording media especially designed for exchanging and sharing digital data with compatible products, such as digital cameras, mobile phones and other devices. Because it is removable, it can be used for external data storage.

For the latest information on Memory Stick media, visit the Sony online support Web site at:

<http://esupport.sony.com/EN/VAIO/> for customers in USA,

<http://www.sony.ca/support> for customers in Canada,

<http://esupport.sony.com/ES/VAIO/> for customers in Latin American countries or areas, or

<http://esupport.sony.com/ES/VAIO/BR/> for customers in Brazil.



Your computer has been tested and found compatible with the Sony branded Memory Stick media with capacity of up to 4 GB that are available as of May 2006. However, not all Memory Stick media that meet the same conditions as the compatible media are guaranteed of compatibility.

Inserting a Memory Stick media with multiple conversion adapters is not guaranteed of compatibility.

MagicGate is the general name of the copyright protection technology developed by Sony. Use a Memory Stick media with the MagicGate logo to use this feature.

## Write-protecting a Memory Stick Media

Some versions of Memory Stick media are designed with an erasure prevention switch to protect valuable data from accidental erasure or overwriting.

Move the tab horizontally or vertically to set or release write-protection. When the erasure prevention switch is off, data can be saved on the Memory Stick media. When the erasure prevention switch is on, data can be read from but not saved on the Memory Stick media.

! Be sure to use a fine-tipped object to move the tab on the Memory Stick Duo media.

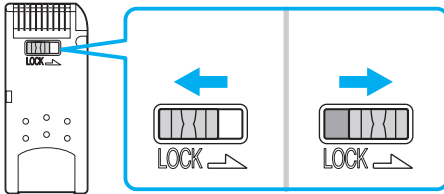

## Inserting a Memory Stick Media

To insert a Memory Stick media

- 1 Locate the Memory Stick PRO/Duo media slot.
- 2 Hold the Memory Stick media with the arrow facing upward and pointing toward the Memory Stick PRO/Duo media slot.
- 3 Carefully slide the Memory Stick media into the slot until it clicks into place.  
The Memory Stick media is automatically detected by your system and appears in your **My Computer** window as a local drive, under the appropriate letter (depending on the configuration of the computer).

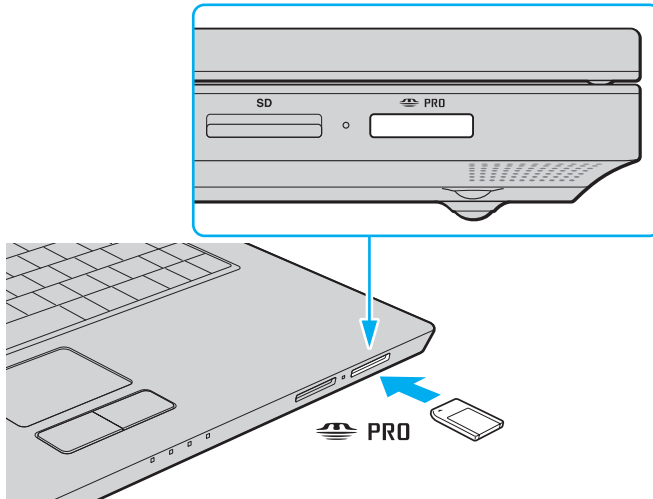

! Be sure to hold the Memory Stick media with the arrow pointing in the correct direction as you insert it into the slot. To avoid damaging your computer or the Memory Stick media, do not force the Memory Stick media into the slot if you cannot insert it smoothly.

Do not insert more than one Memory Stick media into the slot. Inserting the media improperly may damage your computer.



Your computer supports Memory Stick Duo media and is equipped with the Memory Stick PRO/Duo slot that is compatible with both standard- and duo-size media. For more information on the Memory Stick Duo media, visit the Memory Stick web site at <http://www.memorystick.com/en/>.

You can insert a Memory Stick Duo media directly into the slot.

## To view the contents of the Memory Stick media

- 1 Click **Start** and then **My Computer** to open the **My Computer** window.
- 2 Double-click the Memory Stick media icon to view the list of data files saved in the Memory Stick media.

## To format a Memory Stick media

Use the **Memory Stick Formatter** software. See the help file on the **Memory Stick Formatter** software for details.

! Formatting the Memory Stick media erases the entire data on the media. Avoid accidental erasure of your valuable data.

Do not remove the Memory Stick media from the slot while formatting the media. This could cause a malfunction.

Be sure to use the preinstalled **Memory Stick Formatter** software to format a Memory Stick media. In case the media is formatted with the formatting function of the Windows operating system, the media cannot be recognized by other Memory Stick devices.

## Removing a Memory Stick Media

To remove a Memory Stick media

- 1 Check that the Media Access indicator is off.
- 2 Push the Memory Stick media in toward the computer.  
The Memory Stick media ejects.
- 3 Pull the Memory Stick media out of the slot.

**!**  
Always remove the Memory Stick media gently, or it may pop out unexpectedly.

Do not remove the Memory Stick media while the Media Access indicator is turned on. If you do, you may lose data. Large volumes of data may take time to load, so be sure the indicator is off before removing the Memory Stick media.

## Using Other Memory Cards

In addition to the Memory Stick PRO/Duo media slot, your computer is equipped with an **SD** memory card slot to accommodate other memory cards. You can use this slot to transfer data among digital cameras, camcorders, music players, and other audio/video devices.

### Before You Use Memory Cards

The **SD** memory card slot on your computer supports the following memory cards:

- MultiMediaCard (MMC)
- Secure Digital (SD)

For the latest information on compatible memory cards, visit the Sony online support Web site regularly.

**!** Always insert the correct memory card into the **SD** memory card slot.

SDHC memory cards are not supported.

Do not attempt to insert a memory card or memory card adapter of a different type into the slot. An incompatible memory card or memory card adapter may be difficult to remove from the slot and can cause damage to your computer.

Use care when inserting or removing a memory card from the slot. Do not force the memory card in or out of the slot.

The **SD** memory card slot on your computer does not support the high-speed data transfer feature of the SD memory card.

Your computer has been tested and found compatible only with major memory card media available as of May 2006. However, not all memory card media that meet the same conditions as the compatible media are guaranteed of compatibility.



## Inserting a Memory Card

To insert a memory card

- 1 Locate the **SD** memory card slot.
- 2 Hold the memory card with the arrow facing upward and pointing toward the memory card slot.

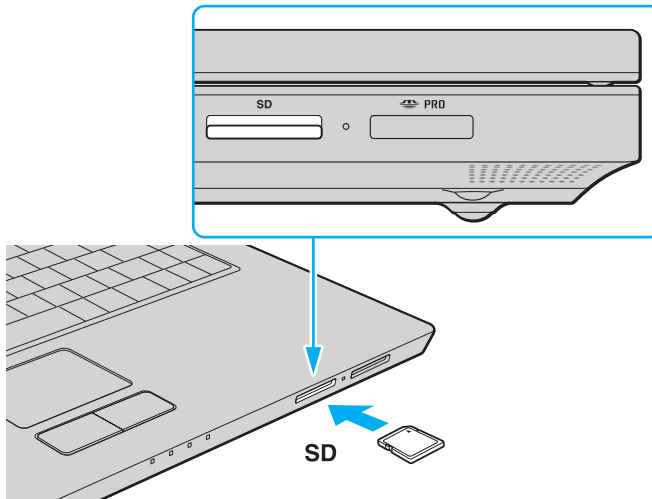

- 3 Carefully slide the memory card into the slot until it clicks into place.  
Do not force the card into the slot.



If the memory card does not go into the slot easily, remove it gently and verify you are inserting it in the proper direction.

## Removing a Memory Card

! Do not remove a memory card while the Media Access indicator light is on. The card or its data may become damaged.

### To remove a memory card

- 1 Check that the Media Access indicator is off.
- 2 Press the extended part of the memory card, causing it to extend out from the slot.
- 3 When the card extends, carefully pull it out of the slot.

## Using the Internet

### Setting Up a Dial-up Internet Connection

Before you can connect to the Internet, you need to connect your computer to a telephone line with a telephone cable (may not supplied). Once you have set up your telephone cable connection, you're ready to connect to the Internet.

To connect a telephone cable

- 1 Plug one end of the phone cable (1) into the modem port  on the computer.
- 2 Plug the other end into the wall jack (2).

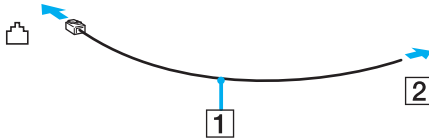

 Your computer does not work with party lines, cannot be connected to a coin-operated telephone, and may not work with multiple telephone lines or a private branch exchange (PBX). Some of these connections may result in excess electrical current and could cause a malfunction in the internal modem.

If you connect a telephone cable coming through a splitter, the modem or connected device may not work properly.

To set up a dial-up connection to the Internet

- 1 Click **Start**, point to **All Programs, Accessories, Communications**, and click **New Connection Wizard**. The **New Connection Wizard** appears.
- 2 Click **Next**. If the **Location Information** window appears, follow the on-screen instructions.
- 3 If it is not already selected, click to select **Connect to the Internet**, and click **Next**.
- 4 Follow the on-screen instructions.

## Using Wireless LAN (WLAN)

Using the Sony Wireless LAN (WLAN), all your digital devices with built-in WLAN functionality communicate freely with each other through a powerful network. A WLAN is a network in which a user can connect to a local area network (LAN) through a wireless (radio) connection. So there is no need anymore to pull cables or wires through walls and ceilings.

The Sony WLAN supports all normal Ethernet activities, but with the added benefits of mobility and roaming. You can still access information, Internet/intranet and network resources, even in the middle of a meeting, or as you move from one place to another.

You can communicate without an access point, which means that you can communicate between a limited number of computers (ad-hoc). Or you can communicate through an access point, which allows you to create a full infrastructure network (infrastructure).



In some countries, using WLAN products may be restricted by the local regulations (e.g. limited number of channels). Therefore, before activating the WLAN functionality, read the **Safety Information** carefully.

WLAN uses the IEEE 802.11a<sup>\*</sup>/b/g standard, which specifies the used technology. The standard includes the encryption methods: Wired Equivalent Privacy (WEP), which is a security protocol, Wi-Fi Protected Access 2 (WPA2), and Wi-Fi Protected Access (WPA). Proposed jointly by the IEEE and Wi-Fi Alliance, both WPA2 and WPA are specifications of standards based, interoperable security enhancements that increase the level of data protection and access control for existing Wi-Fi networks. WPA has been designed to be forward compatible with the IEEE 802.11i specification. It utilizes the enhanced data encryption TKIP (Temporal Key Integrity Protocol) in addition to user authentication using 802.1X and EAP (Extensible Authentication Protocol). Data encryption protects the vulnerable wireless link between clients and access points. Besides that, there are other typical LAN security mechanisms to ensure privacy, such as: password protection, end-to-end encryption, virtual private networks, and authentication. WPA2, the second generation of WPA, provides stronger data protection and network access control and is also designed to secure all versions of 802.11 devices, including 802.11b, 802.11a, and 802.11g, multi-band and multi-mode. In addition, based on the ratified IEEE 802.11i standard, WPA2 provides government grade security by implementing the National Institute of Standards and Technology (NIST) FIPS 140-2 compliant AES encryption algorithm and 802.1X-based authentication. WPA2 is backward compatible with WPA.

\* See the online **Specifications** to see whether your model supports the IEEE 802.11a standard.

Wireless LAN devices using the IEEE 802.11a standard and the ones using the IEEE 802.11b or g standard cannot communicate because the frequencies are different.

IEEE 802.11b: The standard speed is 11 Mbps, or about 30 to 100 times faster than a standard dial up.

IEEE 802.11a/g: The standard speed is 54 Mbps, or about 5 times faster than a Wireless LAN device using the IEEE 802.11b standard.

The 2.4 GHz bandwidth used by wireless LAN compatible devices is also used by other various devices. Although technologies to minimize interference from other devices that use the same bandwidth are employed on wireless LAN compatible devices, such interference may cause lower communication speed, narrower communication range, or broken wireless connections.

The communication speed varies depending on the distance between communication devices, existence of obstacles between such devices, the device configuration, the radio conditions, and the software in use. In addition, communications may be cut off depending on the radio conditions.

The communication range varies depending on the actual distance between communication devices, existence of obstacles between such devices, the radio conditions, the ambient environment that includes existence of walls and materials of such walls, and the software in use.

Deploying IEEE 802.11b and IEEE 802.11g products on the same wireless network may reduce the communication speed due to radio interference. Taking this into consideration, the IEEE 802.11g products are designed to reduce the communication speed to ensure communications with IEEE 802.11b products.

When the communication speed is not as fast as expected, changing the wireless channel on the access point may increase the communication speed.

## Communicating without an Access Point (Ad-hoc)

An ad-hoc network is a network in which a local network is created only by the wireless devices themselves, with no other central controller or access point. Each device communicates directly with other devices in the network. You can set up an ad-hoc network easily at home.

- If the Wireless connection is initiated by the VAIO computer, channel 11 will be selected.
- If the Wireless connection is initiated by peer Wireless LAN equipment, the Wireless LAN communication will make use of the channel selected by the peer Wireless LAN equipment.

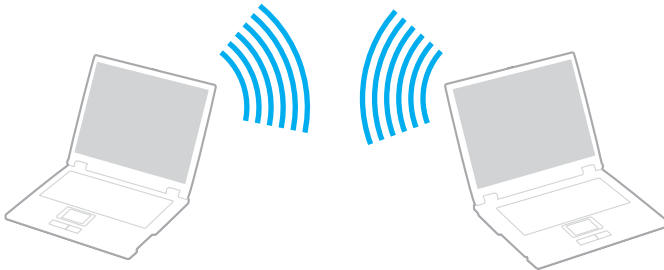



To communicate without an access point (ad-hoc)

- 1 Turn on the **WIRELESS** or **WIRELESS LAN** switch.

The **WLAN** indicator lights up.

Except in Peru and Venezuela, you cannot select the 5 GHz bandwidth, which is used for the IEEE 802.11a standard, on ad-hoc networks.

On models that support the Bluetooth functionality\*<sup>1</sup> and/or the IEEE 802.11a/b/g standard\*<sup>1</sup>, double-click  (  /  ) on the taskbar to display the **Wireless Device Switch** window. Select your desired wireless option(s) and click **OK**.

- 2 Click **Start** and then **Control Panel**.

- 3 Click **Network and Internet Connections**.

- 4 Click **Network Connections**.

The **Network Connections** window appears.

- 5 Right-click **Wireless Network Connection**, then click **Properties**.

The **Wireless Network Connection Properties** window appears.

- 6 Select the **Wireless Networks** tab.

- 7 Click the **Add...** button.

The **Wireless network properties** window appears.

- 8 Enter a network name (SSID)\*<sup>2</sup>.

You can choose a 32-digit alphanumeric name.

- 9 Select **Open** from the **Network Authentication** drop-down box.

- 10 Select **WEP** from the **Data Encryption** drop-down box.

- 11 Deselect the **The key is provided for me automatically** option button.

Some information becomes visible.

12 Enter the network key<sup>\*2</sup>.

The network key should be 5 or 13 alphanumeric characters or 10 or 26 hexadecimal<sup>\*3</sup> characters long. You can choose whichever you want.

13 Enter exactly the same network key again for confirmation.

14 Select the check box **This is a computer-to-computer (ad hoc) network; wireless access points are not used** at the bottom of the window.

15 Click **OK**.

Your network name appears in the **Preferred networks**.

16 Click **Advanced**.

The **Advanced** window appears.

17 Select the **Computer-to-computer (ad hoc) networks only** option button.

18 Click **Close**.

19 Click **OK**.

The computer is ready to communicate with another computer.

\*1 See the online **Specifications** to see whether your model supports the Bluetooth functionality and/or the IEEE 802.11a/b/g standard.

\*2 If you want to communicate between two or more computers, you need to configure all these computers in the exact same way. This means that you need to enter the same network name and the same network key on all computers as on the first computer you configure.

\*3 Hexadecimal: a number representation using the digits 0-9, with their usual meaning, and the letters A-F (or a-f) to represent hexadecimal digits with values of (decimal) 10 to 15.



An ad-hoc network does not support WPA.



To disconnect from a computer-to-computer (ad-hoc) network

- 1 Click **Start** and then **Control Panel**.
- 2 Click **Network and Internet Connections**.
- 3 Click **Network Connections**.  
The **Network Connections** window appears.
- 4 In the right panel under **LAN or High-Speed Internet**, right-click **Wireless Network Connection**.
- 5 Click **Properties**.  
The **Wireless Network Connection Properties** window appears.
- 6 On the **Wireless Networks** tab, click **Advanced**.  
The **Advanced** window appears.
- 7 Click to select **Any available network (access point preferred)**, and click **Close**.
- 8 Click **OK**.
- 9 Close the **Network Connections** window.
- 10 Turn off the **WIRELESS** or **WIRELESS LAN** switch.

## Communicating with an Access Point (Infrastructure)

An infrastructure network is a network that extends an existing wired local network to wireless devices by providing an access point, for example the Sony Access Point. The access point bridges the wireless and wired LAN and acts as a central controller for the Wireless LAN. The access point coordinates transmission and reception from multiple wireless devices within a specific range.

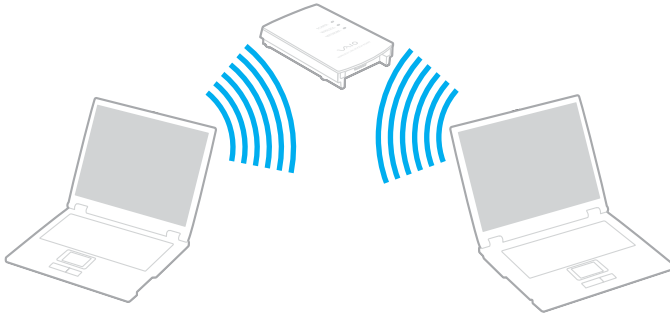

The access point will select which channel to use on an infrastructure network.

! For details on how to select the channel that will be used by the access point, see the manual that came with your access point.



## To connect to a wireless network

- 1 Make sure an access point is set up.  
See the manual that came with your access point for more information.
- 2 Turn on the **WIRELESS** or **WIRELESS LAN** switch.  
The **WLAN** indicator lights up.

On models that support the Bluetooth functionality\* and/or the IEEE 802.11a/b/g standard\*, double-click  (  /  ) on the taskbar to display the **Wireless Device Switch** window. Select your desired wireless option(s) and click **OK**.



- 3 Click **Start** and then **Control Panel**.
- 4 Click **Network and Internet Connections**.
- 5 Click **Network Connections**.
- 6 In the right panel under **LAN or High-Speed Internet**, double-click **Wireless Network Connection**.  
The **Wireless Network Connection** window appears.
- 7 Follow the on-screen instructions.

\* See the online **Specifications** to see whether your model supports the Bluetooth functionality and/or the IEEE 802.11a/b/g standard.

## To connect to a wireless network (models with the Wireless Setup Utility software only)

Use the **Wireless Setup Utility** software to guide you through the set up process and provide you with more detailed information about wireless connections.

- 1 Make sure an access point is set up.  
See the manual that came with your access point for more information.
- 2 Turn on the **WIRELESS** or **WIRELESS LAN** switch.  
The **WLAN** indicator lights up.

On models that support the Bluetooth functionality\* and/or the IEEE 802.11a/b/g standard\*, double-click  (  /  ) on the taskbar to display the **Wireless Device Switch** window. Select your desired wireless option(s) and click **OK**.

- 3 Click **Start**, point to **All Programs**, and click **Wireless Setup Utility**.  
The **Wireless Setup Utility** appears.
- 4 Follow the on-screen instructions.

\* See the online **Specifications** to see whether your model supports the Bluetooth functionality and/or the IEEE 802.11a/b/g standard.

## To disconnect from a wireless network

Turn off the **WIRELESS** or **WIRELESS LAN** switch.

! Turning off the wireless LAN functionality while accessing remote documents, files, or resources may result in data loss.



For WPA-PSK or WPA2-PSK authentication, you must enter a network key of 8 to 64 alphanumeric characters long.

# Using Peripheral Devices

You can add functionality to your computer by using the various ports on the computer.

- ❑ **Connecting External Speakers** ([page 62](#))
- ❑ **Connecting an External Display** ([page 63](#))
- ❑ **Selecting Display Modes** ([page 66](#))
- ❑ **Using the Multiple Monitors Function** ([page 67](#))
- ❑ **Connecting an External Microphone** ([page 69](#))
- ❑ **Connecting a Universal Serial Bus (USB) Device** ([page 70](#))
- ❑ **Connecting a Printer** ([page 73](#))
- ❑ **Connecting an i.LINK Device** ([page 74](#))
- ❑ **Connecting to a Network (LAN)** ([page 76](#))

## Connecting External Speakers

You can enhance the sound quality of your computer by connecting external speakers.

To connect external speakers

- 1 Plug the speaker cable (1) into the headphones jack (2) .
- 2 Plug the other end of the speaker cable to the external speaker (3).
- 3 Turn down the volume of the speakers before you turn them on.

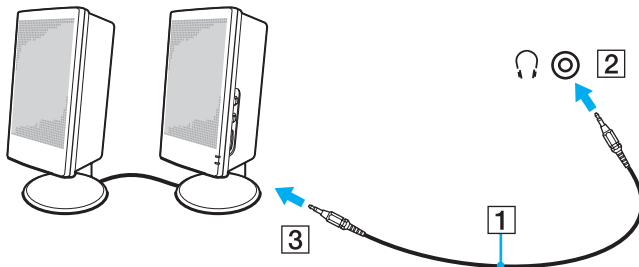

Make sure your speakers are designed for computer use.



Do not place floppy disks on the speakers; their magnetic field may damage the data on the disks.

## Connecting an External Display

You can connect an external display to your computer. For example, you can use the computer with a computer display or a projector.



Connect the power cord after connecting all other cables.

Connected external displays are used as secondary screens.

On Windows systems only, you can also use an external display to set up multiple monitors.

## Connecting a Computer Display

You can connect a computer display (monitor) directly to your computer.

To connect a computer display

- 1 If necessary, plug one end of the display's power cord (1) into your display, and the other end into an AC outlet.
- 2 Plug the display cable (2) (not supplied) into the monitor (VGA) port (3) on the computer.

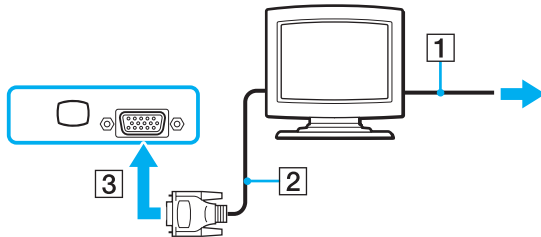

## Connecting a Multimedia Computer Display

You can connect a multimedia computer display that includes built-in speakers and a microphone directly to your computer.

To connect a multimedia computer display

- 1 Plug the power cord of your multimedia computer display (1) into an AC outlet.
- 2 Plug the display cable (2) (not supplied) into the monitor (VGA) port (3) □ on the computer.
- 3 Plug the speaker cable (4) into the headphones jack (5) 🎧 on the computer.
- 4 Plug the microphone cable (6) into the microphone jack (7) 🎤 on the computer.

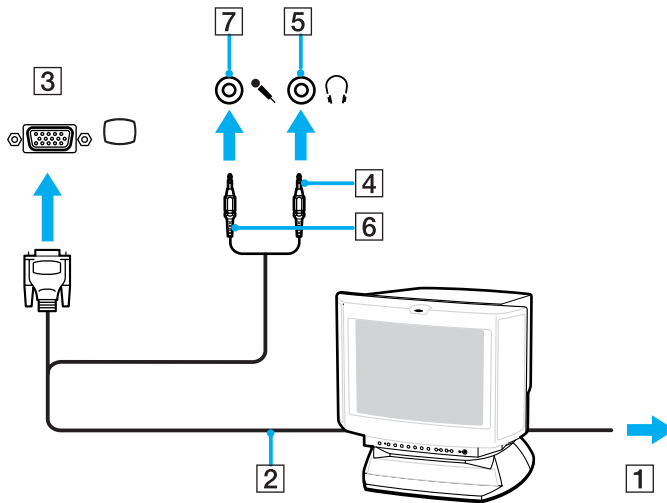



## Connecting a Projector

You can connect a projector (for example, the Sony LCD projector) directly to your computer.

To connect a projector

- 1 Connect the power cord (1) of your projector into an AC outlet.
- 2 Plug an RGB signal cable (2) (not supplied) into the monitor (VGA) port (3) □ on the computer.
- 3 Plug an audio cable (4) (not supplied) into the headphones jack (5) ♪.
- 4 Plug the RGB signal cable and the audio cable into the jack and port on the projector (6).

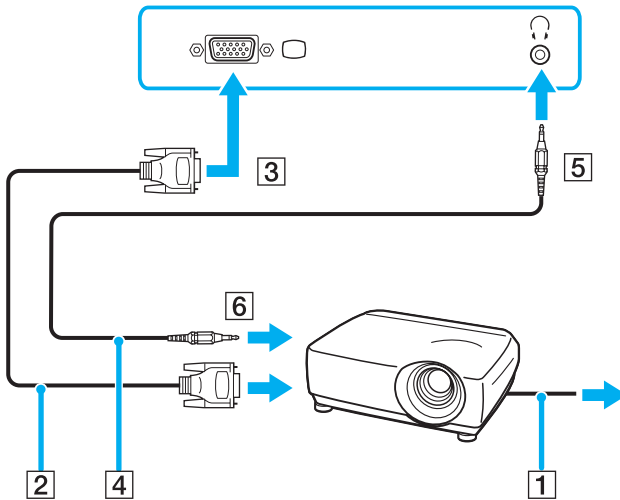

## Selecting Display Modes

You can select which display to be used as the primary monitor when an external display (desktop monitor, etc.) is connected to your computer.

If you want to work on your computer screen and the external display at the same time, see **Using the Multiple Monitors Function (page 67)** for more information.

To select a display

- 1 Right-click on the desktop to display the context menu.
- 2 Click the menu item for graphic properties.
- 3 Follow the on-screen instructions to change the settings.



You may not be able to display the same contents on your computer screen and the external display or projector at the same time, depending on the type of your external display or projector.

Before turning on your computer, turn on the peripheral devices.

## Using the Multiple Monitors Function

The Multiple Monitors function allows you to distribute portions of your desktop across separate displays. For example, if you have an external display attached to the monitor (VGA) port, your computer screen and the external display can function as a single desktop.

You can move the cursor from one display to the other. This allows you to drag objects, such as an open application window or a toolbar, from one display to the other.

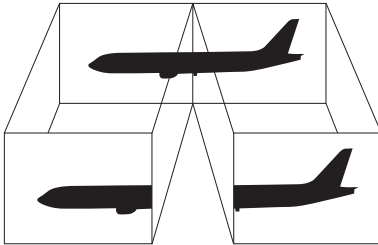

Your external display may not support the Multiple Monitors function.

Certain software applications may not be compatible with Multiple Monitors settings.

Make sure that your computer does not enter Standby or Hibernate mode while you are using Multiple Monitors mode; otherwise the computer may not return to Normal mode.

If you set different colors on each display, do not divide one single window on two displays; otherwise your software may not work properly.

Set fewer colors or a lower resolution for each display.

## To select the Multiple Monitors mode

- 1 Right-click on the desktop to display the context menu.
- 2 Click the menu item for graphic properties.
- 3 Follow the on-screen instructions to change the settings.



Additionally, you can set the display colors and resolution for each display and customize the Multiple Monitors mode.

## Connecting an External Microphone

If you need to use a sound input device (for example, to chat over the Internet) you need to plug in an external microphone.

To connect an external microphone

Plug the microphone cable (1) into the microphone jack (2) .

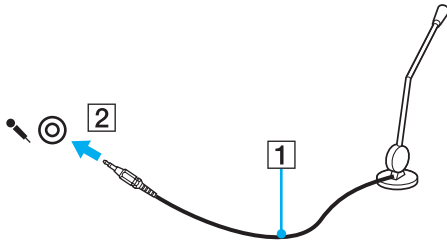

Make sure your microphone is designed for computer use.

## Connecting a Universal Serial Bus (USB) Device

To prevent your computer and/or USB devices from damage, observe the following:

- ❑ When moving the computer with USB devices connected, avoid any shock or force to the USB ports.
- ❑ Do not put the computer into a bag or carrying case when it has USB devices connected.

### Connecting a USB Mouse

To connect a USB mouse

- 1 Choose the USB port (1)  you prefer to use.
  - 2 Plug the USB mouse cable (2) into the USB port.
- You can now use your USB mouse (3).

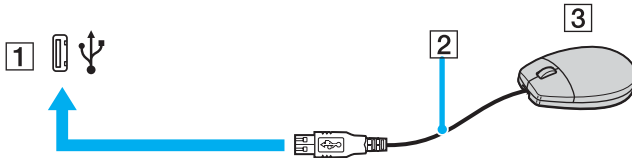

The VAIO USB mouse software driver is preinstalled on your computer. As a result, you only need to plug the USB mouse into the USB port and you can start working.

## Connecting a USB Floppy Disk Drive

You can purchase a USB floppy disk drive and connect it to your computer.

To connect a USB floppy disk drive

- 1 Choose the USB port (1)  you prefer to use.
  - 2 Plug the USB floppy disk drive cable (2) into the USB port.
- Your USB floppy disk drive (3) is now ready for use.

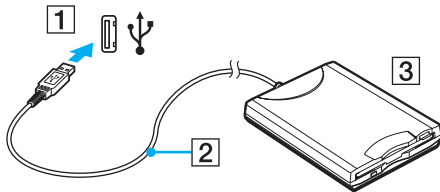

**!** When using a USB floppy disk drive, do not apply force on the USB port. This may cause a malfunction.

## Disconnecting a USB floppy disk drive

You can disconnect a USB floppy disk drive when your computer is on or off. Disconnecting the drive when the computer is in a power saving mode (Standby or Hibernate) may cause the computer to malfunction.

If the computer is off, you can unplug the USB cable directly from the computer.

### To disconnect a USB floppy disk drive

- 1 Close all programs accessing the floppy disk drive.
- 2 Double-click the **Safely Remove Hardware** icon on the taskbar.  
The **Safely Remove Hardware** window appears.
- 3 Select the floppy disk drive you want to unplug.
- 4 Click **Stop**.  
The **Stop a Hardware device** window appears.
- 5 Make sure the floppy disk drive is selected, and click **OK**.  
A message appears stating it is now safe to remove the hardware device.
- 6 Click **Close** to close the **Safely Remove Hardware** window.
- 7 Disconnect the floppy disk drive from the computer.



## Connecting a Printer

You can connect a Windows-compatible printer to your computer to print documents.

### Connecting a Printer Using the USB Port

You can connect a USB printer compatible with your version of Windows to the computer.

To connect a printer using the USB port

- 1 Plug the power cord (1) of your printer into an AC outlet.
- 2 Choose the USB port (3)  you prefer to use.
- 3 Plug one end of a USB printer cable (2) (not supplied) into the USB port and the other end to your printer.

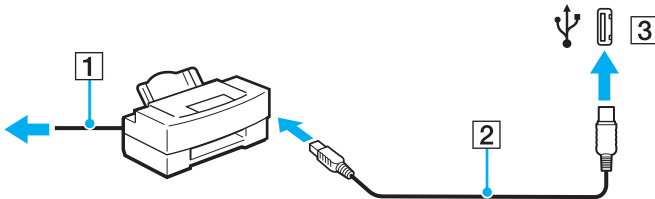

## Connecting an i.LINK Device

### Notes on connecting i.LINK devices

- ❑ Your computer is equipped with an i.LINK port, which you can use to connect to an i.LINK device such as a digital video camcorder or to connect two VAIO computers in order to copy, delete or edit files.
- ❑ The i.LINK port on your computer does not supply power to external devices generally powered by i.LINK ports.
- ❑ The i.LINK port supports transfer rates up to 400 Mbps; however, the actual transfer rate depends on the transfer rate of the external device.
- ❑ i.LINK cables compatible with your computer include cables with the following part numbers:  
VMC-IL4415 (a 1.5 meter cable with a 4-pin connector at each end) and VMC-IL4408 Series (a 0.8 meter cable with a 4-pin connector at each end).
- ❑ The optional i.LINK cables may not be available, depending on the country or area of your residency.
- ❑ An i.LINK connection with other compatible devices is not fully guaranteed.
- ❑ The i.LINK connection varies depending on the software applications, operating system, and i.LINK-compatible devices you use. See the manual that came with your software for more information.
- ❑ Check the working conditions and OS compatibility of i.LINK-compatible PC peripherals (for example, an HDD or a CD-RW drive) before you connect them to your computer.

## Connecting a Digital Video Camcorder

To connect a digital video camcorder

- 1 Plug one end of an i.LINK cable (1) (not supplied) into the i.LINK port (2) on the computer and the other end into the DV In/Out ports (3) on the digital video camcorder.
- 2 Launch the **DVgate Plus** software.

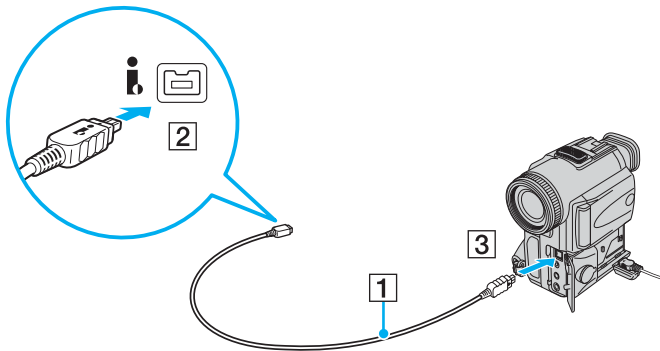

On Sony digital video cameras, ports labeled **DV Out**, **DV In/Out**, or **i.LINK** are i.LINK-compatible.

The Sony digital video camcorder shown here is an example; your digital video camcorder may need to be connected differently.

You cannot access the pictures stored on a Memory Stick media when using an i.LINK connection.

## Connecting to a Network (LAN)

You can connect your computer to 100BASE-TX/10BASE-T-type networks with an Ethernet network cable. Connect one end of a network cable (not supplied) to the network (Ethernet) port on the computer and the other end to your network. For detailed settings and devices needed to connect to the network, ask your network administrator.

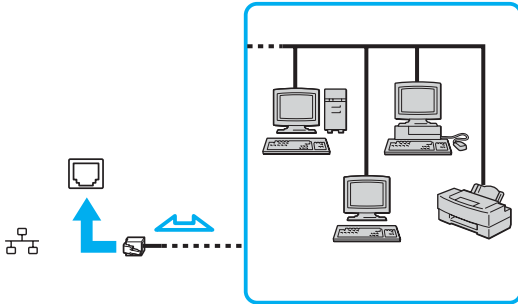

Your computer can be connected to the network with the default settings.



Telephone lines cannot be connected to the network (LAN) connector on your computer.

If the network (LAN) connector is connected to the telephone lines mentioned below, high electric current to the connector may cause damage, overheating, or fire.

- Home (intercom speakerphone) or business-use telephone lines (multi-line business telephone)
- Public telephone subscriber line
- PBX (private branch exchange)

Do not plug a telephone cable into the network port.

# Customizing Your VAIO Computer

This section briefly describes how to change the main settings of your computer. Among other things, you will learn how to use and customize the look of your Sony software and utilities, etc.

- ❑ **Setting the Password** ([page 78](#))
- ❑ **Setting Up Your Computer with VAIO Central** ([page 81](#))
- ❑ **Using the Power Saving Modes** ([page 82](#))
- ❑ **Managing Power with VAIO Power Management** ([page 87](#))

## Setting the Password

Use one of the BIOS functions to set the password.

Once you have set the password, you will have to enter the password after the VAIO logo appears to start your computer. The power-on password will allow you to protect your computer from unauthorized access.

## Adding the Power-on Password

The power-on password is provided to protect your computer from unauthorized access.

There are two types of the power-on password: machine password and user password. The machine password is provided for users with administrator rights on the computer to change all the setup options on the BIOS setup screen, as well as to start the computer. The user password is provided for other ordinary users to allow for changing some of the BIOS setup options, as well as starting the computer. To set the user password, you must first set the machine password.

**!** Once you have set the power-on password, you cannot start your computer without entering the password. Make sure not to forget the password. Write down your password and keep it safe and private from other people.

If you forget the power-on password and need assistance to reset it, a password reset fee will be charged, and your computer may need to be sent in for depot service for password reset.

## To add the power-on password

- 1 Turn on the computer.
- 2 Press the **F2** key when the VAIO logo appears.  
The BIOS setup screen appears. If not, restart the computer and press the **F2** key several times when the VAIO logo appears.
- 3 Press the **←** or **→** key to select **Security** to display the **Security** tab, select **Set Machine Password**, and then press the **Enter** key.
- 4 On the password entry screen, enter the password twice and press the **Enter** key.  
The password can be up to 32 alphanumeric characters (including spaces) long.
- 5 At the confirmation prompt, press the **Enter** key.



The following is to configure your computer to prompt password entry when you turn it on or display the BIOS setup screen.

- 6 Select **Password when Power On** under **Security**.  
Press the space bar to change the setting from **Disabled** to **Enabled**.
- 7 Press the **←** or **→** key to select **Exit**, select **Exit (Save Changes)** or **Exit Setup**, and then press the **Enter** key.  
On the **Setup Confirmation** screen, make sure that **Yes** is selected and then press the **Enter** key.

## Changing/Removing the Power-on Password

To change or remove the power-on password

- 1 Turn on the computer.
- 2 Press the **F2** key when the VAIO logo appears.  
The BIOS setup screen appears. If not, restart the computer and press the **F2** key several times when the VAIO logo appears.
- 3 Enter the current password for **Enter Password** and press the **Enter** key.
- 4 Press the **←** or **→** key to select **Security** to display the **Security** tab, select **Set Machine Password**, and then press the **Enter** key.
- 5 On the password entry screen, enter the current password once and a new password twice, and then press the **Enter** key.  
To remove the password, leave the **Enter New Password** and **Confirm New Password** fields blank and press the **Enter** key.  
When confirmation to save the changes is prompted, press the **Enter** key.
- 6 Press the **←** or **→** key to select **Exit**, select **Exit (Save Changes)** or **Exit Setup**, and then press the **Enter** key.  
On the **Setup Confirmation** screen, confirm that **Yes** is selected and then press the **Enter** key.



## Setting Up Your Computer with VAIO Central

The **VAIO Central** utility allows you to consult system information and specify preferences for system behavior.

To use VAIO Central

- 1 Click **Start**, point to **All Programs**, and click **VAIO Central**.  
The **VAIO Central** window appears.
- 2 Select the desired control item and change the settings.
- 3 Once finished, click **OK**.  
The setting of the desired item has been changed.



Some of the control items will not be visible if you open **VAIO Central** as a limited user.

## Using the Power Saving Modes

When you use a battery pack as the power source for your computer, you can take advantage of power management settings to conserve battery life. In addition to the normal operating mode, which allows you to turn off specific devices, your computer has two distinct power saving modes: Standby and Hibernate. When using battery power, you should be aware that the computer will automatically enter Hibernate mode if the remaining battery charge becomes short, regardless of the power management setting you select.

To set the timer for the computer to automatically enter Standby or Hibernate mode after a certain period of time, click **Start** and **Control Panel**. Click **Performance and Maintenance** and **Power Options**, and then change the settings under **Power Schemes**.

! If the battery level falls below 10 percent, you should either attach the AC adapter to recharge the battery pack or shut down your computer and install a fully charged battery pack.

## Using Normal Mode

This is the normal state of the computer when it is in use. The green power indicator light is on in this mode. To save power while not working, you can turn off a specific device such as the LCD screen or the hard disk.

## Using Standby Mode

Standby mode turns off the LCD screen and places the hard disk and the CPU into a low power consumption mode. The amber power light flashes in this mode.

To activate Standby mode

- 1 Click **Start** and then **Turn Off Computer**.
- 2 Click **Stand By**.

To return to Normal mode

Press any key.

! If you press and hold the power button for more than four seconds, your computer will turn off automatically. You will lose any unsaved data.



When your computer is in Standby mode, you cannot insert a disc.

Your computer comes out of Standby mode quicker than out of Hibernate mode.

Standby mode uses more power than Hibernate mode.

! If the battery runs down while your computer is in Standby mode, you will lose any unsaved data. Going back to the previous work state is impossible. To avoid loss of data, you should save your data frequently.

If the computer is not used for 25 minutes, it will enter Standby mode. To avoid this, you can change the Standby mode settings.

To change the Standby mode settings

- 1 Click **Start** and then **Control Panel**.
- 2 Click **Performance and Maintenance**.
- 3 Click **Power Options**.  
The **Power Options Properties** window appears.
- 4 Select the **Power Schemes** tab.
- 5 Change the **System Standby** settings.

## Using Hibernate Mode

In Hibernate mode, the state of the system is saved on the hard disk and power is turned off. Even when the battery runs down, no data will be lost. The power indicator light is off in this mode.

To activate Hibernate mode

Press the **Fn+F12** keys.

The **Hibernating** screen appears and the computer enters Hibernate mode.

Alternatively,

- 1 Click **Start** and then **Turn Off Computer**.
- 2 Click **Hibernate**.

To return to Normal mode

Press the power button.

The computer returns to its previous state.

! If you press and hold the power button for more than four seconds, your computer will turn off automatically.



If you do not use your computer for a long period of time, place the computer into Hibernate mode. This power saving mode saves you the time of shutting down or resuming.

When your computer is in Hibernate mode, you cannot insert a disc.

Hibernate mode requires more time than Standby mode to be activated.

It takes more time to return to Normal mode from Hibernate mode than from Standby mode.

Hibernate mode uses less power than Standby mode.



Do not move your computer before its power indicator light turns off.

## Managing Power with VAIO Power Management

Power management helps you set up power schemes for running on AC power or batteries to suit your requirements for power consumption.

**VAIO Power Management** is a software application developed exclusively for VAIO computers. With this software application, you can enhance the Windows power management functions to ensure better operations of your computer and longer battery life. For more information on **VAIO Power Management**, see the help file on the **VAIO Power Management** software.

### Activating VAIO Power Management

When you start the computer, a power status icon appears on the taskbar. This icon indicates what kind of power source you are using at that time, for example, AC power. Double-click this icon to display the window, showing your power status.

**VAIO Power Management** functionalities are added to the Windows **Power Options Properties**.

To activate VAIO Power Management

- 1 Click **Start** and then **Control Panel**.
- 2 Click **Performance and Maintenance**.
- 3 Click **Power Options**.  
The **Power Options Properties** window appears.
- 4 Select the **VAIO Power Management** tab.

To restore the default settings

- 1 On the **VAIO Power Management** tab, click **Advanced**.  
The **VAIO Power Management** window appears.
- 2 Follow the on-screen instructions to change the settings.

## Activating VAIO Power Management Power Schemes

**VAIO Power Management** provides several predefined power schemes. Each power scheme consists of a group of power management settings that are designed to meet specific power management goals, ranging from maximum power management to no power management.

To activate a VAIO Power Management power scheme

- 1 Click **Start** and then **Control Panel**.
- 2 Click **Performance and Maintenance**.
- 3 Click **Power Options**.  
The **Power Options Properties** window appears.
- 4 Select the tab for power scheme settings.
- 5 Select a power scheme from the drop-down list.
- 6 If you now select the **VAIO Power Management** tab, you see that the selected power scheme appears on the tab.
- 7 If necessary, you can change the items in the list, for example, the LCD brightness of your computer screen.
- 8 Click **OK**.  
The power scheme has been activated.



You must have administrator rights on your computer to set up a power scheme.



## Upgrading Your VAIO Computer

Your computer and memory modules use high precision components and electronic connectors technology. To avoid the invalidation of your guarantee due to mishandling, we recommend that:

- You contact your dealer to install a new memory module.
- You do not install it yourself, if you are not familiar with upgrading memory on a computer.
- You do not touch the connectors or open the memory module compartment cover.

For the type of module and the amount of memory installed on your model, refer to the online **Specifications**.

For assistance, contact an authorized Sony Service Center. To find the nearest center or agent, visit the Sony online support Web site.

## Adding and Removing Memory

If you want to expand the functionality of your computer, you can increase the memory by installing optional memory modules. Before you upgrade your computer's memory, read the notes and procedures in the following pages. The number of available slots depends on the configuration of your model.

### Notes on adding/removing memory modules

- ❑ Be careful when changing memory. Improper installation of memory modules may cause damage to your system. This damage may void your manufacturer's warranty.
- ❑ Only use memory modules that are compatible with your computer. If a memory module is not detected by the computer or Windows becomes unstable, contact your sales dealer or the manufacturer of your memory module.
- ❑ Electrostatic discharge can damage electronic components. Before touching a memory module, ensure the following:
  - ❑ The procedures described in this document assume familiarity with the general terminology associated with personal computers and with the safety practices and regulatory compliance required for using and modifying electronic equipment.
  - ❑ Turn off your computer and disconnect the system from its power source (that is, battery pack or AC adapter) and from any telecommunication links, networks, or modems before you open the computer. Failure to do so may result in personal injury or equipment damage.
  - ❑ Electrostatic Discharge (ESD) can damage memory modules and other components. Install the memory module only at an ESD workstation. If such a station is not available, do not work in a carpeted area, and do not handle materials that produce or hold static electricity (cellophane wrappers, for example). Ground yourself by maintaining contact with an unpainted metal portion of the chassis while performing the procedure.
  - ❑ Do not open the memory module package before you are ready to change the module. The package protects the module from ESD.

- Use the special bag delivered with the memory module or wrap the module in aluminum foil to protect it from electrostatic discharge.
- Introducing any liquids, foreign substances, or objects into the memory module slots or other internal components of your computer will result in damage to the computer and any repair costs will not be covered by the warranty.
- Do not place the memory module in a location subject to:
  - Heat sources such as radiators or air ducts
  - Direct sunlight
  - Excessive dust
  - Mechanical vibration or shock
  - Strong magnets or speakers that are not magnetically shielded
  - Ambient temperature of more than 95°F (35°C) or less than 41°F (5°C)
  - High humidity
- Handle the memory module with care. To avoid injuries to your hands and fingers, do not touch the edges of the components and circuit boards inside your computer.

## Removing and Installing a Memory Module

To change or add a memory module

- 1 Shut down the computer and disconnect all peripheral devices.
- 2 Unplug the computer and remove the battery pack.
- 3 Wait until the computer cools down.
- 4 Unscrew the screw (indicated by the arrow below) on the bottom of the computer and remove the memory module compartment cover.

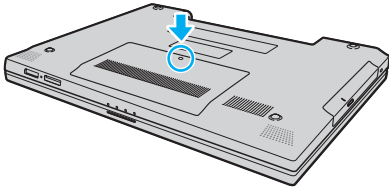

- 5 Touch a metal object (such as the connector panel on the back of the computer) to discharge static electricity.

6 Remove the memory module:

- ❑ Pull the latches in the direction of the arrows (1).  
The memory module is released.

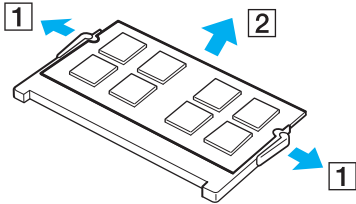

- ❑ Make sure that the memory module tilts up and then pull it out in the direction of the arrow (2).

7 Remove the new memory module from its packaging.

- 8 Slide the memory module into the memory module slot and push it in until it clicks into place.

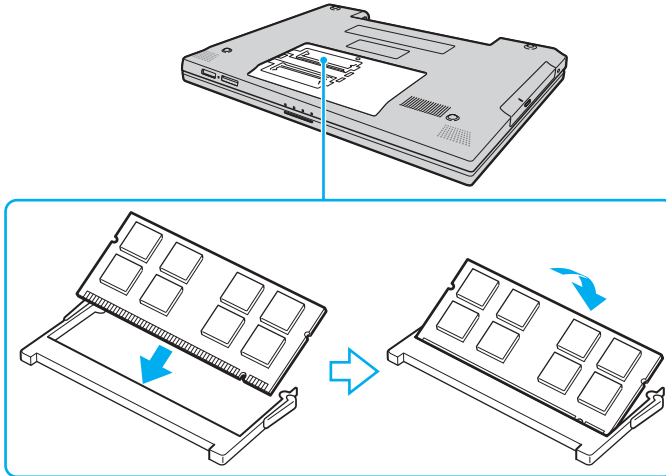

**!** Do not touch any other components on the motherboard.

Do not damage the insulation sheet equipped for module protection.

- 9 Replace the memory module compartment cover.
- 10 Tighten the screw on the bottom of the computer.
- 11 Reinstall the battery pack and turn on the computer.

## Viewing the Amount of Memory

To view the amount of memory

- 1 Turn on the computer.
- 2 Click **Start**, point to **All Programs**, and click **VAIO Central**.
- 3 Click the **System Information** tab in the **VAIO Central** window.
- 4 Double-click the **System Information** folder.
- 5 Double-click the **System Information** icon.

You can view the amount of system memory. If the additional memory does not appear, repeat the whole procedure and restart the computer.

# Precautions

This section describes safety guidelines and precautions to help you protect your computer from potential damage.

- ❑ **On Handling the LCD Screen** ([page 97](#))
- ❑ **On Using the Power Source** ([page 98](#))
- ❑ **On Handling Your Computer** ([page 99](#))
- ❑ **On Handling Floppy Disks** ([page 101](#))
- ❑ **On Handling Discs** ([page 102](#))
- ❑ **On Using the Battery Pack** ([page 103](#))
- ❑ **On Using Headphones** ([page 104](#))
- ❑ **On Handling Memory Stick Media** ([page 105](#))
- ❑ **On Handling the Hard Disk** ([page 106](#))



## On Handling the LCD Screen

- ❑ Do not leave the LCD screen facing the sun. This could damage the LCD screen. Be careful when using your computer near a window.
- ❑ Do not scratch the LCD screen or exert pressure on it. This could cause a malfunction.
- ❑ Using your computer in low temperature conditions may produce a residual image on the LCD screen. This is not a malfunction. When the computer returns to normal temperature, the screen returns to normal.
- ❑ A residual image may appear on the LCD screen if the same image is displayed for a long period of time. The residual image disappears in a while. You can use a screen saver to prevent residual images.
- ❑ The LCD screen becomes warm during operation. This is normal and does not indicate a malfunction.
- ❑ The LCD screen is manufactured using high-precision technology. You may, however, see tiny black points and/or bright points (red, blue, or green) that continuously appear on the LCD screen. This is a normal result of the manufacturing process and does not indicate a malfunction.
- ❑ Avoid rubbing the LCD screen. This could damage the screen. Use a soft, dry cloth to wipe the LCD screen.

## On Using the Power Source

- ❑ See the online **Specifications** to check the power operation of your model.
- ❑ Do not share the AC outlet with other power-consuming equipment, such as a photocopier or shredder.
- ❑ You can purchase a power strip with a surge protector. This device prevents damage to your computer caused by sudden power surges, in an electrical storm, for example.
- ❑ Do not place heavy objects on the power cord.
- ❑ To disconnect the cord, pull it out by the plug. Never pull the cord itself.
- ❑ Unplug your computer from the AC outlet if you are not planning to use the computer for a long period of time.
- ❑ Make sure that the AC outlet is easily accessible.
- ❑ When the AC adapter is not used, unplug it from the AC outlet.
- ❑ Use the AC adapter supplied with your computer or genuine Sony products. Do not use any other AC adapter as it may cause a malfunction.

## On Handling Your Computer

- ❑ Clean the cabinet with a soft cloth, which is dry or lightly moistened with a mild detergent solution. Do not use any type of abrasive pad, scouring powder, or solvent such as alcohol or benzene, as these may damage the finish of your computer.
- ❑ If you drop a solid object or any liquid onto your computer, shut down the computer and then unplug it. You may want to have the computer checked by qualified personnel before operating it again.
- ❑ Do not drop your computer or place any objects on top of the computer.
- ❑ Do not place your computer in a location subject to:
  - ❑ Heat sources, such as radiators or air ducts
  - ❑ Direct sunlight
  - ❑ Excessive dust
  - ❑ Moisture or rain
  - ❑ Mechanical vibration or shock
  - ❑ Strong magnets or speakers that are not magnetically shielded
  - ❑ Ambient temperature of more than 95°F (35°C) or less than 41°F (5°C)
  - ❑ High humidity
- ❑ Do not place electronic equipment near your computer. The electromagnetic field of the computer may cause a malfunction.
- ❑ Provide adequate air circulation to prevent internal heat from building up. Do not place your computer on porous surfaces such as rugs or blankets, or near material such as curtains or draperies that may block its air vents.
- ❑ Your computer uses high-frequency radio signals and may cause interference to radio or TV reception. If this occurs, relocate the computer a suitable distance away from the set.

- ❑ Use only specified peripheral equipment and interface cables; otherwise, problems may occur.
- ❑ Do not use cut or damaged connection cables.
- ❑ If your computer is brought directly from a cold location to a warm one, moisture may condense inside the computer. In this case, allow at least one hour before turning on the computer. If any problems occur, unplug the computer and contact an authorized Sony Service Center. To find the nearest center or agent, visit the Sony online support Web site.
- ❑ Make sure you disconnect the power cord before cleaning your computer.
- ❑ To avoid losing data if your computer is damaged, back up your data regularly.
- ❑ Do not exert pressure on the LCD screen or its edges when opening the LCD screen lid or lifting your computer. The LCD screen may be sensitive to pressure or added stress and exerting pressure may damage the screen or cause the screen to malfunction. To open the computer, hold the base with one hand and gently lift the LCD screen lid with the other. To carry the computer, make sure to hold the computer with both hands.

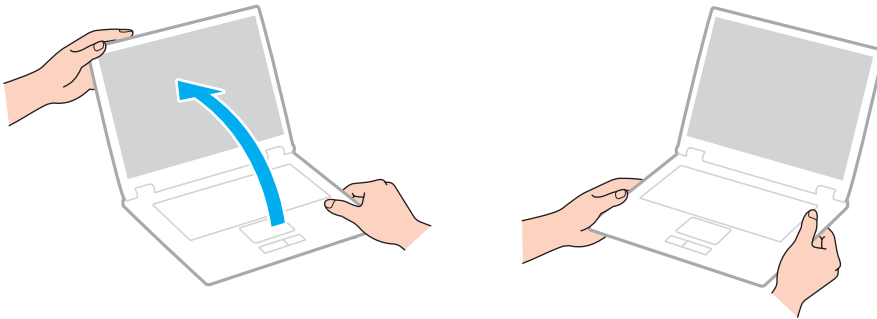

- ❑ Use a carrying case specially designed to carry your computer.

## On Handling Floppy Disks

- ❑ Do not open the shutter manually or touch the surface of the floppy disk.
- ❑ Keep floppy disks away from magnets.
- ❑ Keep floppy disks away from direct sunlight and other sources of heat.
- ❑ Keep floppy disks away from any liquid. Do not let them get wet. When you are not using your floppy disk, always remove it from the floppy disk drive and use a storage case.
- ❑ If the floppy disk comes with an adhesive label, make sure that the label is properly affixed. If the edge of the label is curled up, the label may stick to the inside of the floppy disk drive and cause a malfunction or damage your floppy disk.

## On Handling Discs

- ❑ Do not touch the surface of the disc.
- ❑ Do not drop or bend the disc.
- ❑ Fingerprints and dust on the surface of a disc may cause read errors. Always hold the disc by its edges and central hole, as shown below:

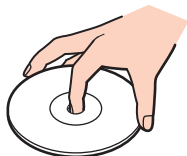

- ❑ Proper care of the disc is essential to its continuous reliability. Do not use solvents (such as benzine, thinner, alcohol, commercially available cleaners, or anti-static spray) which may cause damage to the disc.
- ❑ For normal cleaning, hold the disc by its edge and use a soft cloth to wipe the surface from the center out.
- ❑ If the disc is badly soiled, moisten a soft cloth with water, wring it out well, and use it to wipe the surface of the disc from the center out. Wipe off any remaining moisture with a dry soft cloth.
- ❑ Never affix an adhesive label on discs. This will affect the use of the disc irreparably.

## On Using the Battery Pack

- ❑ Do not leave battery packs in temperatures above 140°F (60°C), such as in a car parked in the sun or under direct sunlight.
- ❑ Battery life is shorter in a cold environment. This is due to decreased battery efficiency at low temperatures.
- ❑ Charge battery packs at temperatures between 50°F to 86°F (10°C to 30°C). Lower temperatures require longer charging time.
- ❑ This computer is designed to operate only with genuine Sony batteries.
- ❑ While the battery pack is in use or being charged, heat builds up in the battery pack. This is normal and is not cause for concern.
- ❑ Keep the battery pack away from all sources of heat.
- ❑ Keep the battery pack dry.
- ❑ Do not open or try to disassemble the battery pack.
- ❑ Do not expose the battery pack to any mechanical shock.
- ❑ If you are not using your computer for a long period of time, remove the battery pack from the computer to prevent damage to the battery pack.
- ❑ If, after fully charging the battery pack, the battery power is still low, the battery pack may be reaching the end of its life and should be replaced.
- ❑ You do not need to discharge the battery pack before recharging.
- ❑ If you have not used the battery pack for a considerable amount of time, recharge the battery pack.

## On Using Headphones

- ❑ **Road safety** – Do not use headphones while driving, cycling, or operating any motorized vehicle. It may create a traffic hazard and is illegal in some areas. It can also be potentially dangerous to play loud music while walking, especially at pedestrian crossings.
- ❑ **Preventing hearing damage** – Avoid using headphones at high volume. Hearing experts advise against continuous, loud and extended play. If you experience a ringing in your ears, reduce the volume or discontinue use.



## On Handling Memory Stick Media

- Do not use the media in a location subject to static electricity or electrical noise.
- Do not touch the Memory Stick media connector with your finger or metallic objects.
- Use only the adhesive label supplied with the Memory Stick media as a label.
- Do not bend, drop, or apply strong shock to the Memory Stick media.
- Do not disassemble or modify Memory Stick media.
- Do not let Memory Stick media get wet.
- Do not use or store Memory Stick media in a location subject to:
  - Extremely high temperatures, such as in a car parked in the sun
  - Direct sunlight
  - High humidity
  - Corrosive substances
- Use the storage case supplied with the Memory Stick media.
- Be sure to make a backup copy of your valuable data.
- Keep the Memory Stick media out of reach of children. There is a risk of swallowing the media.
- When using the Memory Stick Duo media, do not use a fine-tipped pen to write on the label adhered to the Memory Stick Duo media. Exerting pressure on the media may damage internal components.

## On Handling the Hard Disk

The hard disk has a high storage density and reads or writes data in a short time. However, it can be easily damaged by mechanical vibration, shock, or dust.

Although the hard disk has the internal safety device to prevent losing data due to mechanical vibration, shock or dust, you should be careful when handling your computer.

### To avoid damaging your hard disk

- Do not subject your computer to sudden movements.
- Keep your computer away from magnets.
- Do not place your computer in a location subject to mechanical vibration or in an unstable position.
- Do not move your computer while the power is on.
- Do not turn off the power or restart your computer while reading or writing data to the hard disk.
- Do not use your computer in a place subject to extreme changes in temperature.



If the hard disk is damaged, the data cannot be restored.

# Troubleshooting

This section describes how to solve common problems you might encounter when using your computer. Many problems have simple solutions. Try these suggestions before visiting the Sony online support Web site at <http://esupport.sony.com/EN/VAIO/> for customers in USA, at <http://www.sony.ca/support> for customers in Canada, at <http://esupport.sony.com/ES/VAIO/> for customers in Latin American countries or areas, or at <http://esupport.sony.com/ES/VAIO/BR/> for customers in Brazil.

- Computer (page 108)**
- System Security (page 115)**
- Battery (page 117)**
- Internet (page 119)**
- Networking (page 121)**
- Optical Discs (page 124)**
- Display (page 129)**
- Printing (page 131)**
- Microphone (page 132)**
- Mouse (page 133)**
- Speakers (page 134)**
- Touch Pad (page 135)**
- Keyboard (page 136)**
- Floppy Disks (page 137)**
- Audio/Video (page 138)**
- Memory Stick Media (page 139)**
- Peripherals (page 140)**

## Computer

### What should I do if my computer does not start?

- Make sure your computer is securely plugged into a power source and turned on. Make sure the power indicator shows the power is on.
- Make sure the battery pack is installed properly and charged.
- Make sure the floppy disk drive (if applicable) is empty.
- If your computer is plugged into a power strip or uninterruptible power supply (UPS), make sure the power strip or UPS is plugged into a power source and turned on.
- If you are using an external display, make sure it is plugged into a power source and turned on. Make sure the brightness and contrast controls are adjusted correctly. See the manual that came with your display for more information.
- Disconnect the AC adapter and remove the battery pack. Wait three to five minutes. Reattach the AC adapter and reinstall the battery pack, and press the power button to turn on your computer.
- Condensation may cause your computer to malfunction. If this occurs, do not use the computer for at least one hour.
- Remove any extra memory modules you may have inserted since purchase.
- Check that you are using the supplied Sony AC adapter. For your safety, use only genuine Sony rechargeable battery packs and AC adapter, which are supplied by Sony for your VAIO computer.

## What should I do if a BIOS error appears when I turn on my computer?

If the message "Press <F1> to resume, <F2> to setup" appears at the bottom of your computer screen, follow these steps:

- 1 Press the **F2** key.  
The BIOS setup screen appears.
- 2 Set the date (month/day/year). Press the **Enter** key.
- 3 Press the **↓** key to select **System Time**, and then set the time (hour: minute: second). Press the **Enter** key.
- 4 Press the **→** key to select the **Exit** tab, and then press the **F9** key.  
The message **Load default configuration now?** appears.
- 5 Select **Yes**, and press the **Enter** key.
- 6 Select **Exit (Save Changes)** or **Exit Setup**, and press the **Enter** key.  
The message **Save configuration changes and exit now?** appears.
- 7 Select **Yes**, and press the **Enter** key.  
Your computer restarts.

If this occurs frequently, contact an authorized Sony Service Center. To find the nearest center or agent, visit the Sony online support Web site.

## What should I do if the power indicator (Green) lights but my computer screen stays blank?

Follow these steps:

- 1 Press and hold the power button for more than four seconds to check that the power indicator goes out. Then turn on your computer again.
- 2 If your computer screen still stays blank, unplug the AC adapter, remove the battery pack, and leave the computer for about a minute. Then plug in the AC adapter, install the battery pack, and turn on the computer again.

## What should I do if my computer or software stops responding?

- ❑ It is best to turn off your computer using the **Turn Off Computer** option on the Microsoft Windows **Start** menu, located on the taskbar. Using other methods, including those listed below, may result in loss of unsaved data.
- ❑ Click **Start**, point to **Turn Off Computer**, and then click **Turn Off**.
- ❑ If your computer does not turn off, press the **Ctrl+Alt+Delete** keys simultaneously. When the **Windows Task Manager** window appears, click **Turn Off** from the **Shut Down** menu.  
When the **Windows Security** window appears, click **Shut Down**.
- ❑ If your computer still does not turn off, press and hold the power button until the computer turns off.
- ❑ If your computer stops responding while playing a CD or DVD, press the **Ctrl+Alt+Delete** keys simultaneously. You can turn off the computer from **Windows Task Manager**.

! Pressing the **Ctrl+Alt+Delete** keys simultaneously or turning off your computer with the power button may cause loss of data.

- ❑ Remove the AC adapter and battery pack.
- ❑ Try reinstalling the software.
- ❑ Contact the software publisher or designated provider for technical support.

## Why doesn't my computer enter Standby or Hibernate mode?

Your computer may become unstable if the operating mode is changed before the computer completely enters Standby or Hibernate.

To restore your computer to normal operating stability

- 1 Close all open programs.
- 2 Click **Start, Turn Off Computer**, and then **Restart**.
- 3 If your computer does not restart, press the **Ctrl+Alt+Delete** keys simultaneously.  
In the **Windows Task Manager** window, select **Restart** from the **Shut Down** menu to restart the computer.
- 4 If this procedure does not work, press and hold the power button until the computer turns off.

## What should I do if the battery indicator is flashing and my computer does not start?

- This symptom could be due to the battery pack not being installed properly. To resolve this symptom, turn off your computer and remove the battery pack. Then install the battery pack to the computer again. For details, see **Installing the Battery Pack (page 19)**.
- If the symptom persists after performing the above, it means the installed battery pack is not compatible. Remove the battery pack and contact an authorized Sony Service Center. To find the nearest center or agent, visit the Sony online support Web site.

## What should I do if a message window, notifying of incompatibility or improper installation of the battery pack, appears and my computer enters Hibernate mode?

- ❑ This symptom could be due to the battery pack not being installed properly. To resolve this symptom, turn off your computer and remove the battery pack. Then install the battery pack to the computer again. For details, see **Installing the Battery Pack (page 19)**.
- ❑ If the symptom persists after performing the above, it means the installed battery pack is not compatible. Remove the battery pack and contact an authorized Sony Service Center. To find the nearest center or agent, visit the Sony online support Web site.

## Why does the System Properties window display a slower CPU speed than the maximum?

This is normal. Because your computer's CPU utilizes a type of CPU speed controlling technology for power conservation purposes, System Properties may display the CPU's current speed instead of the maximum speed.

## What should I do if Windows does not start, showing a message, when I start my computer?

If you enter a wrong power-on password three times consecutively, the **Enter Onetime Password** message appears. If you enter a wrong power-on password three times consecutively again, the **System Disabled** message appears and Windows will not start. Press and hold the power button for more than four seconds to check that the power indicator goes off. Wait for 10 or 15 seconds, then restart your computer and enter the correct password. When entering the password, check that the Num lock indicator and Caps lock indicator are off. If any are lit, press the **Num Lk** key or the **Caps Lock** key to turn off the indicator before entering the password.



## What should I do if my game software does not work or it keeps crashing?

- ❑ Check the web site of the game if there are any patches or updates to download.
- ❑ Make sure you have installed the latest video driver.
- ❑ On some VAIO models, the graphics memory is shared with the system. The optimal graphic performance in this case is not guaranteed.

## What should I do if I cannot remember the BIOS password?

If you have forgotten the BIOS password, contact an authorized Sony Service Center to reset it. A reset fee will be charged. To find the nearest center or agent, visit the Sony online support Web site.

## Why does it take time before my computer starts?

If Norton Internet Security's Personal Firewall is active, it may take some time before the desktop screen appears due to network security checkups.

## Why doesn't my computer screen turn off when the time selected for the automatic turn-off action has passed?

The originally selected VAIO's screen saver disables the timer setting, which you can select using the Windows power options, for your computer screen to turn off.

Change the originally selected VAIO's screen saver.

## What should I do if I cannot boot my computer from the USB floppy disk drive connected to the computer?

To boot your computer from the USB floppy disk drive, you need to change the boot device.

Turn on your computer and press the **F11** key when the VAIO logo appears.

## How can I change the volume of the startup sound?

To change the startup sound volume

- 1 Press the **F2** key.  
The BIOS setup screen appears.
- 2 Press the **←** or **→** key to select **Advanced**.
- 3 Press the **↑** or **↓** key to select **Speaker Volume** and press the **Enter** key.
- 4 Press the **↑** or **↓** key to select the speaker volume at startup and press the **Enter** key.
- 5 Press the **←** or **→** key to select **Exit**, select **Exit (Save Changes)** or **Exit Setup**, and then press the **Enter** key.  
The message **Save configuration changes and exit now?** appears.
- 6 Select **Yes** and press the **Enter** key.  
Your computer restarts and you will hear the startup sound at the specified volume level.



You can also show/hide the VAIO animation logo at startup. On the screen that is displayed after step 2 above, select **VAIO Animation Logo** or **Show VAIO Animation Logo** and press the **Enter** key to proceed with the setting. Hiding the VAIO animation logo will also turn off the startup sound.

## System Security

This section provides information about keeping your computer operating smoothly and protecting against potential threats to the computer's security.

### How can I protect my computer against security threats, such as viruses?

The Microsoft Windows operating system is preinstalled on your computer. The best way to protect your computer against security threats, such as viruses, is to download and install the latest Windows updates regularly.

You can get important Windows updates by doing one of the following:

- ❑ The **Automatic Updates** feature — This feature automatically searches for and delivers updates directly to your computer whenever it is connected to the Internet.
- ❑ The Windows Updates web site — This site enables you to download computer updates without turning on the **Automatic Updates** feature.



Your computer must be connected to the Internet before you can receive updates.

### To use the Automatic Updates feature

- 1 Connect to the Internet.
- 2 Click the **Automatic Updates** icon on the taskbar.
- 3 Follow the on-screen instructions to set up automatic or scheduled updates.

To visit the Windows Updates web site

- 1 Connect to the Internet.
- 2 Type **<http://windowsupdate.microsoft.com/>** in the address bar of your browser.  
The **Microsoft Windows Update** and **Security Warning** windows appear.
- 3 In the **Security Warning** window, start installation and run **Windows Update**.
- 4 In the **Microsoft Windows Update** window, select an installation type, and follow the on-screen instructions.

## How do I keep my antivirus software updated?

You can keep the **Norton Internet Security** software program current with the latest updates from Symantec Corporation.

To download and install the latest security update

- 1 Double-click the **Norton Internet Security** icon on the taskbar. If you have not previously registered the antivirus software, a series of information wizards appears.
  - 1 Follow the on-screen instructions to complete each wizard.
  - 2 Double-click the **Norton Internet Security** icon again.  
The **Norton Internet Security** window appears.  
If you have previously registered this antivirus software, the **Norton Internet Security** window automatically appears.
- 2 Follow the on-screen instructions to select and download updates.

## Battery

### How do I find the battery charging status?

See **Charging the Battery Pack** ([page 21](#)).

### When is my computer using AC power?

When your computer is directly connected to the AC adapter, it uses AC power, even if the battery pack is installed.

### When should I recharge the battery pack?

- When the battery level falls below 10 percent.
- When both the battery and power indicators blink.
- When you have not used the battery pack for a long period of time.

### When should I replace the battery pack?

If the battery power is still low after charging it, the battery pack may be reaching the end of its life and should be replaced.

### Should I be concerned that the installed battery pack is warm?

No, it is normal for the battery pack to be warm when it is powering your computer.

## Can my computer enter Hibernate mode while using battery power?

Your computer can enter Hibernate mode while using battery power, but some software programs and peripheral devices prevent the system from entering Hibernate mode. If you are using a program that prevents the system from entering Hibernate mode, save your data frequently to avoid losing data. See **Using Hibernate Mode (page 85)** for information on how you can manually activate Hibernate mode.

## Why doesn't my computer enter Hibernate mode?

You may first need to enable Hibernate mode. Follow these steps:

- 1 Click **Start** and then **Control Panel**.
- 2 Click **Performance and Maintenance**.
- 3 Click **Power Options**.  
The **Power Options Properties** window appears.
- 4 Select the **Hibernate** tab.
- 5 Click to check the box next to **Enable hibernation**.

## Internet

### What should I do if my modem does not work?

- Make sure the telephone cable is securely plugged into the modem port on your computer and the wall jack.
- Make sure the telephone cable is working. Plug the cable into an ordinary telephone and listen for a dial tone.
- Make sure the telephone number the program is dialing is correct.
- Make sure the software you are using is compatible with your computer's modem. (All preinstalled Sony programs are compatible.)
- Make sure the modem is the only device connected to your telephone line.
- Follow these steps to check the settings:
  - 1** Click **Start** and then **Control Panel**.
  - 2** Click **Printers and Other Hardware**.
  - 3** Click **Phone and Modem Options**.
  - 4** On the **Modems** tab, check that your modem is listed.
  - 5** On the **Dialing Rules** tab, check the location information is correct.

## Why is my modem connection slow?

Your computer is equipped with a V.92/ V.90 compatible modem. Many factors may influence modem connection speed, including telephone line noise or compatibility with telephone equipment, such as fax machines or other modems. If you think your modem is not connecting properly to other PC-based modems, fax machines, or your Internet Service Provider (ISP), do any of the following:

- Ask your telephone company to verify your telephone line is free of any line noise.
- If your problem is fax-related, make sure there are no problems with the fax machine you are calling and that it is compatible with fax modems.
- If you are having a problem connecting with your ISP, make sure the ISP is not experiencing technical problems.
- If you have a second telephone line, try connecting the modem to that line.



## Networking

### What should I do if my computer cannot connect to a wireless LAN access point?

- Connection availability is affected by distance and obstructions. You may need to move your computer away from obstructions or closer to any access point you may be using.
- Make sure the **WIRELESS** or **WIRELESS LAN** switch is on and the **WLAN** indicator is lit on your computer.
- Make sure power to the access point is on.
- Follow these steps to check the settings:
  - 1 Click **Start** and then **Control Panel**.
  - 2 Click **Network and Internet Connections**.
  - 3 Click **Network Connections**.
  - 4 Right-click **Wireless Network Connection**.
  - 5 Click **Properties**.
  - 6 Click the **Wireless Networks** tab.
  - 7 Click **View Wireless Networks** to see that your access point is selected.
- Make sure the encryption key is correct.

### What should I do if I cannot access the Internet?

- Check the access point settings. See the manual that came with your access point for more information.
- Make sure your computer and the access point are connected to one another.
- Move your computer away from obstructions or closer to any access point you may be using.
- Make sure your computer is properly configured for Internet access.

## Why is the data transfer speed slow?

- The wireless LAN data transfer speed is affected by distance and obstructions between devices and access points. Other factors include device configurations, radio conditions, and software compatibility. To maximize the data transfer speed, move your computer away from obstructions or closer to any access point you may be using.
- If you are using a wireless LAN access point, the device may be temporarily overloaded depending on how many other devices are communicating via the access point.
- If your access point interferes with other access points, change the access point channel. See the manual that came with your access point for more information.

## How do I avoid data transfer interruptions?

- When your computer is connected to an access point, data transfer interruptions may occur when using large files or if the computer is in close proximity to microwaves and cordless telephones.
- Move your computer closer to the access point.
- Make sure the access point connection is intact.
- Change the access point channel. See the manual that came with your access point for more information.

## What are channels?

- ❑ Wireless LAN communication occurs on divided frequency bands known as channels. Third-party wireless LAN access point channels may be preset to different channels from Sony devices.
- ❑ If you are using a wireless LAN access point, see connectivity information contained in the manual that came with your access point.

## Why does the network connection stop when I change the encryption key?

Two computers with built-in wireless LAN may lose a peer-to-peer network connection if the encryption key is changed. You can either change the encryption key back to the original profile or re-enter the key on both computers so the key matches.

## Optical Discs

### Why does my computer freeze when I try to read a disc?

The disc that your computer is trying to read may be dirty or damaged. Follow these steps:

- 1 Restart the computer by clicking **Start, Turn Off Computer,** and **Restart.**
- 2 Eject the disc from the optical disc drive.
- 3 Examine the disc for dirt or damage. If the disc is dirty, see **On Handling Discs (page 102)** for instructions on how to clean it.

### What should I do if the drive tray does not open?

- Make sure your computer is on.
- Press the drive eject button.
- If the drive eject button does not work, click **Start** and then **My Computer**. Right-click the optical disc drive icon, and select **Eject** from the shortcut menu.
- If none of the above options work, insert a thin, straight object (such as a paper clip) in the manual eject hole near the drive eject button.
- Try restarting your computer.

## What should I do if I cannot play a CD or DVD properly on my computer?

- ❑ Make sure the disc was inserted into the optical disc drive with the label facing upward.
- ❑ Make sure the necessary program(s) is installed according to the manufacturer's instructions.
- ❑ If a CD or DVD is dirty or damaged, your computer will stop responding. Follow these steps:
  - 1 Restart the computer by pressing the **Ctrl+Alt+Delete** keys, and selecting **Restart** from the **Shut Down** menu of the **Windows Task Manager** window.
  - 2 Remove the CD or DVD from the optical disc drive.
  - 3 Check the disc for dirt or damage. If you need to clean the disc, see **On Handling Discs (page 102)** for instructions.
- ❑ If you are playing a CD or DVD and cannot hear sound, do any of the following:
  - ❑ Double-click the **Volume** icon on the taskbar, and click to cancel the **Master Volume Mute All** and **Wave Mute** check boxes.
  - ❑ Check the volume setting in the audio mixer.
  - ❑ If you are using external speakers, check the volume settings on the speakers and the connections between the speakers and your computer.
  - ❑ Make sure the CD audio feature is enabled and the correct driver software is installed. Follow these steps:
    - 1 Click **Start** and then **Control Panel**.
    - 2 Click **Performance and Maintenance**.
    - 3 Click **System**.  
The **System Properties** window appears.
    - 4 Select the **Hardware** tab, and click **Device Manager** in the **Device Manager** box.  
A window with a listing of your computer's hardware devices appears.  
If an "X" or an exclamation point appears on the listed device, you may need to enable the device or reinstall the drivers.

- 5 Double-click the optical disc drive device to open the submenu.
  - 6 Double-click the listed drive, and select the **Properties** tab.
  - 7 Click to select the **Enable digital CD audio for this CD-ROM device** check box, if it is not selected. You can confirm the driver software by selecting the **Driver** tab, and clicking **Driver Details**.
  - 8 Click **OK** to close the window.
- Make sure an adhesive label is not affixed to a CD or DVD. Adhesive labels can come off while the disc is in the optical disc drive and damage the drive or cause it to malfunction.
  - If a region code warning appears, the disc may be incompatible with the optical disc drive. Check the DVD package to make sure the region code is compatible with the optical disc drive.
  - If you notice condensation on your computer, do not use the computer for at least one hour. Condensation can cause the computer to malfunction.
  - Make sure your computer is running on AC power supply and try the disc again.

## What should I do if I cannot write data to CD media?

- Do not launch any software application or allow any to launch automatically, not even a screen saver.
- Do not use the keyboard.
- Do not use a CD-R/RW disc that has an adhesive label affixed to it. This could cause a write error or other damage.

## What should I do if I cannot write data to DVD media?

- Make sure you are using the correct DVD recordable media.
- Check which DVD recordable format is compatible with your computer's built-in DVD recorder. Note the possibility that some brands of DVD recordable media do not work.

## What should I do if I cannot write data to DVD-RAM media using Windows functions?

This Q & A entry applies to selected models only. See the online **Specifications** to find the type of your optical disc drive, and then **Reading and Writing Optical Discs (page 31)** to find about the supported disc media.

Follow these steps to change the settings:

- 1 Click **Start** and then **My Computer**.
- 2 Right-click the optical disc drive icon and select **Properties**.
- 3 Click the **Recording** tab.
- 4 Click to cancel the **Enable CD recording on this drive** check box.
- 5 Click **OK**.

**!** Canceling the **Enable CD recording on this drive** check box disables writing data to CD-R and CD-RW discs. To write data to such discs, make sure to select this check box.

You cannot add data to DVD-RAM discs with data already written by the **Roxio DigitalMedia** software due to difference in disc formatting. Attempt to add data to such a disc will re-format the disc, resulting in loss of the entire written data.



## Display

### Why did my computer screen go blank?

- ❑ Your computer screen may go blank if the computer has lost power or has entered a power saving mode (Standby or Hibernate). If the computer is in LCD (Video) Standby mode, press any key to activate the computer screen. See **Using the Power Saving Modes (page 82)** for more information.
- ❑ Make sure your computer is securely plugged into a power source and turned on. Make sure the power indicator shows the power is on.
- ❑ If your computer is using battery power, make sure the battery pack is installed properly and is charged. See **Using the Battery Pack (page 19)** for more information.
- ❑ If the display mode is set to external display, press the **Fn+F7** keys. See **Combinations and Functions with the Fn Key (page 26)** for more information.

### Why doesn't my computer screen display a video?

If the external display is selected for the display output and the external display is disconnected, you cannot display a video on your computer screen. Stop video playback, change the display output to the computer screen, and then restart video playback. See **Selecting Display Modes (page 66)**. Alternatively, you can press the **Fn+F7** keys to change the display output. See **Combinations and Functions with the Fn Key (page 26)** for more information.

### What should I do if my computer screen is dark?

Press the **Fn+F6** keys to brighten your computer screen.

## What should I do if the LCD brightness of my computer screen changes?

The LCD brightness setting, adjusted with the **Fn+F5/F6** keys, is temporary and this adjustment is overridden by the setting on the **VAIO Power Management** tab when another power scheme is selected. To save this preference for the brightness, follow these steps:



To do the following procedure, you must have administrator rights on your computer.

- 1 Click **Start** and then **Control Panel**.
- 2 Click **Performance and Maintenance**.
- 3 Click **Power Options**.
- 4 Select the tab for power scheme settings.
- 5 Select the desired power scheme from the drop-down list.
- 6 On the **VAIO Power Management** tab, select **No change** for **LCD Brightness**.
- 7 Click **OK**.

The preference for the LCD brightness adjusted with the **Fn+F5/F6** keys is saved and the brightness of your computer screen remains unchanged regardless of operating conditions.

## What should I do if the external display stays blank?

If you cannot change the display output with the **Fn+F7** keys, you need to change the settings for the external display with **VAIO Central**. To change the settings, launch the **VAIO Central**, select the control item for the external display, and then cancel the check box for enabling the automatic function to select the external display for the output. Then, try the **Fn+F7** keys to change the display output.

# Printing

## What should I do if I cannot print a document?

- ❑ Make sure your printer is on, and the printer cable is securely connected to the ports on the printer and computer.
- ❑ Make sure your printer is compatible with the Windows operating system installed on your computer.
- ❑ You may need to install the printer driver software before you use your printer. See the manual that came with your printer for more information.
- ❑ If your printer is not functioning after your computer resumes from a power saving mode (Standby or Hibernate), then restart the computer.
- ❑ If the bidirectional communication functions are provided with your printer, disabling the functions on your computer may enable printing. Follow these steps:
  - 1 Click **Start** and then **Control Panel**.
  - 2 Click **Printers and Other Hardware**.
  - 3 Click **Printers and Faxes**.
  - 4 Right-click the printer icon and select **Properties**.
  - 5 Click the **Ports** tab.
  - 6 Click to cancel the **Enable bidirectional support** check box.
  - 7 Click **OK**.

This change to the settings disables the bidirectional communication functions of the printer, such as data transfer, status monitoring, and remote panel.

## Microphone

### What should I do if my microphone does not work?

If you are using an external microphone, make sure the microphone is turned on and is properly plugged into the microphone jack on your computer.

## Mouse

### What should I do if my computer does not recognize my mouse?

- Make sure your mouse is securely plugged into the port.
- Restart your computer with your mouse connected.

### What should I do if the pointer does not move when I use my mouse?

- Make sure another mouse is not connected.
- If you are playing a disc, press the **Ctrl+Alt+Delete** keys simultaneously to stop playback and restart your computer.
- If the pointer still does not move, do any of the following:
  - Press the **Ctrl+Alt+Delete** keys simultaneously.  
In the **Windows Task Manager** window, select **Restart** from the **Shut Down** menu to restart your computer.
  - Press and hold the power button for more than four seconds. When your computer turns off, wait for 10 to 15 seconds and then press the power button again to restart the computer.

## Speakers

### What should I do if my speakers do not work?

- Make sure your speakers are properly connected and the volume is turned up loud enough to hear sound.
- Make sure your speakers are designed for computer use.
- If your speakers have a muting button, set the button to off.
- If you have connected an audio cable to the headphones jack, disconnect the cable and use the speaker cable supplied with your speakers.
- If you are using battery power, make sure the battery pack is installed properly and is charged.
- If your speakers require external power, make sure the speakers are connected to a power source. See the manual that came with your speakers for more information.

### What should I do if I cannot hear sound from my speakers?

- If your computer is using battery power, make sure the battery pack is properly installed and is charged.
- If you are using a program that has its own volume control, make sure the volume control is properly set. See the program's help file for more information.
- Make sure the speaker volume is turned up loud enough and the audio option is enabled.
- Check the volume controls in Windows.

## Touch Pad

### What should I do if the touch pad does not work?

- ❑ You may have disabled the touch pad without connecting a mouse to your computer. See [Using the Touch Pad \(page 28\)](#).
- ❑ Restart your computer.  
Press the **Ctrl+Alt+Delete** keys simultaneously.  
In the **Windows Task Manager** window, select **Restart** from the **Shut Down** menu to restart the computer.
- ❑ If the pointer does not move while playing a disc, press the **Ctrl+Alt+Delete** keys simultaneously to stop playback and restart your computer.
- ❑ If the problem persists, make sure a mouse is not connected.

### How do I change the left and right button assignments?

If your computer is interpreting a single-click as a double-click, you may want to change the button assignments. Follow these steps:

- 1 Click **Start** and then **Control Panel**.
- 2 Click **Printers and Other Hardware**.
- 3 Click **Mouse**.
- 4 Click the **Buttons** tab.
- 5 Select your preferences in the **Button Selection** box, and then click **Apply** to apply your settings.  
You may need to press the **Tab** key and the **↑** and **↓** keys to make your selections.
- 6 Click **OK** to close the window.

## Keyboard

### What should I do if the keyboard configuration is wrong?

- ❑ The language layout of your computer's keyboard is labeled on the packaging box. If you choose a different regional keyboard when you complete the Windows setup, the key configuration will be mismatched.
- ❑ To change the keyboard configuration, follow these steps:
  - 1 Click **Start** and then **Control Panel**
  - 2 Click **Date, Time, Language and Regional Options**, and click **Regional and Language Options**.
  - 3 Change the settings as desired.

### What should I do if I cannot enter certain characters with the keyboard?

If you cannot enter **U, I, O, P, J, K, L, M**, and so on, the **Num Lk** key may be activated. Check that the Num lock indicator is off. If the Num lock indicator is on, press the **Num Lk** key to turn it off before entering these characters.



## Floppy Disks

### Why doesn't the Safely Remove Hardware icon appear on the taskbar when the drive is connected?

Your computer does not recognize the floppy disk drive. First, make sure the USB cable is properly connected to the USB port. If you need to secure the connection, wait a few moments for the computer to recognize the drive. If the icon still does not appear, follow these steps:

- 1 Close all programs that are accessing the floppy disk drive.
- 2 Wait for the LED indicator on the floppy disk drive to turn off.
- 3 Push the eject button to remove the disk, and disconnect the USB floppy disk drive from your computer.
- 4 Reconnect the floppy disk drive by inserting the USB connector (with the USB icon facing upward) into the USB port.
- 5 Restart the computer by clicking **Start, Turn Off Computer**, and then **Restart**.

### What should I do if I cannot write data to a floppy disk?

- Make sure the floppy disk is properly inserted in the drive.
- If the disk is inserted properly and you are still unable to write data to it, the disk may be full or write-protected. You can either use a floppy disk that is not write-protected or disable the write-protect feature.

## Audio/Video

### What should I do if I cannot use my DV camcorder?

If the message appears to indicate DV equipment seems to be disconnected or turned off, the i.LINK cable may not be securely plugged into the ports on your computer or camcorder. Unplug the connectors, and plug them in again. See **Connecting an i.LINK Device (page 74)** for more information.



i.LINK is a trademark of Sony used only to designate that a product contains an IEEE 1394 connection. The procedure to establish an i.LINK connection may vary, depending on a software application, an operating system, and a compatible i.LINK device. Not all products with an i.LINK connection can communicate with each other. See the manual that came with your compatible i.LINK device for more information on operating conditions and proper connection. Before connecting compatible i.LINK PC peripherals to your system, such as a CD-RW or hard disk drive, confirm their operating system compatibility and required operating conditions.

## Memory Stick Media

### What should I do if I cannot open my image files?

You may need to reformat your Memory Stick media.

Formatting Memory Stick media erases all data, including music data previously saved on it. Before you reformat Memory Stick media, back up important data and confirm that the media does not contain files you want to keep.

- 1 Copy the data from the Memory Stick media onto your computer's hard disk to save data or images.
- 2 Format the Memory Stick media using the **Memory Stick Formatter** software preinstalled on your computer. For instructions about formatting a Memory Stick media, see the help file on the **Memory Stick Formatter** software.

### Why can't I save music files onto my Memory Stick media?

Copyright protected music cannot be checked out to any Memory Stick media other than those with the MagicGate logo.

! Use of recorded music requires permission from the copyright holders.

Sony is not responsible for music files that cannot be recorded from a CD or downloaded from other sources.

### Can I copy images from a digital camera using Memory Stick media?

Yes, and you can view video clips that you have recorded with Memory Stick media-compatible digital cameras.

## Peripherals

### What should I do if I cannot connect a USB device?

- ❑ If applicable, check the USB device is turned on and using its own power supply. For example, if you are using a digital camera, check the battery is charged. If you are using a printer, check the power cable is connected properly to the AC outlet.
- ❑ Try using another USB port on your computer. The driver could be installed to the specific port you used the first time you connected the device.
- ❑ See the manual that came with your USB device for more information. You may need to install software before you connect the device.
- ❑ Try connecting a simple, low-powered device such as a mouse to test if the port is working at all.
- ❑ USB hubs may prevent a device from working because of the distribution of power. We recommend you connect the device directly to your computer without a hub.

# Support Options

The section contains information on where to go for answers to questions about your computer and the preinstalled software.

## Sony Support Information

See the following sources for answers in the sequence listed below.

### 1 VAIO Computer Documentation

This on-screen **User Guide** (this manual) and the printed **Welcome mat** provide detailed information on how to maximize your computer's capabilities and solve common problems.

### 2 Program Guides and Help Files

The preinstalled programs on your computer may be supplied with individual help guides. These guides are stored on the hard disk as on-screen help files. You can find the help files from the help menu under the specific program.

### 3 Operating System Online Support

Your computer comes preinstalled with a Microsoft Windows operating system. For operating system support, you can visit Microsoft customer support at: <http://support.microsoft.com/directory/>.

### 4 Sony Computing Support

This service provides instant access to information on commonly encountered problems. Type a description of the problem and the Knowledge Database searches for the corresponding solutions online. You can visit the Sony online support Web site at <http://esupport.sony.com/EN/VAIO/> for customers in USA, at <http://www.sony.ca/support> for customers in Canada, at <http://esupport.sony.com/ES/VAIO/> for customers in Latin American countries or areas, or at <http://esupport.sony.com/ES/VAIO/BR/> for customers in Brazil.

## 5 VAIO Update

When your computer is connected to the Internet, **VAIO Update** automatically notifies you when critical software and security information is posted on the support web site. Click the **VAIO Update** notice to open the VAIO Support Web site and view the information.

## For users in Latin American countries or areas

### Customer Information Center

If you do not find the information you are looking for at our site, you may call Sony directly. In order to receive the fastest and most efficient services, please have the following information readily available:

**1** Your VAIO computer model

You can find it at the lower right corner of the display on the laptop, and in the same place on the front panel of the CPU on the desktop.

**2** Your computer's serial number

You can find it on the back or bottom of the laptop or on the back of the desktop; the serial number is the last 7 digits of the number below the barcode.

**3** The operating system on your computer

**4** The hardware component or the software program that is causing you the problem

**5** A brief description of the problem

In order to contact a Sony technical support representative, please call the following numbers:

In Argentina:

(011) 6770-SONY (7669)

In Mexico:

In Mexico City: 5002-9819

In the Mexican Republic: 01-800-759-7669

In Colombia:

01-800-550-7000

In Peru:

0-801-1-7000 or 511-6100

In Chile:

Sony answers: 800-261-800

From cellular phones: 02-754-6333

In Venezuela:

0-800-1-SONY-00 (0-800-1-7669-00)

In Panama:

800-2050

In Brazil:

(11) 3677-1080



## Program Support Information

Depending on the computer model and particular configuration you purchased, your computer may not include all of the software programs listed below.

Contacts for Sony software products are listed below:

- For users in USA  
Web Site <http://esupport.sony.com/EN/VAIO/>  
Telephone 888-4-SONY-PC (888-476-6972)
- For users in Canada  
Web Site <http://www.sony.ca/support>  
Telephone 888-4-SONY-PC (888-476-6972)
- For users in Latin American countries or areas  
Web Site <http://esupport.sony.com/ES/VAIO/>
- For users in Brazil  
Web Site <http://esupport.sony.com/ES/VAIO/BR/>

For contacts about third-party software products, see the following.

### **Adobe® Photoshop® Elements, Premiere®, Reader®**

Adobe Systems Inc.

- For users in USA and Canada  
Web Site <http://www.adobe.com/support>  
Telephone 800-685-3652

**America Online® (Dial-Up)**

America Online, Inc.

- For users in USA and Canada  
Web Site <http://www.aol.com>

**AOL® Music Now**

America Online, Inc.

- For users in USA and Canada  
Web Site <http://www.premiumservices.aol.com>

**AOL® Explorer**

America Online, Inc.

- For users in USA and Canada  
Web Site <http://www.aol.com>

**AOL® Toolbar**

America Online, Inc.

- For users in USA and Canada  
Web Site <http://help.aol.com/help>

**AOL® Instant Messenger™**

America Online, Inc.

- For users in USA and Canada  
Web Site <http://www.aim.com>

**Ask Search Assistant**

Ask Jeeves, Inc.

For contacts about the software, see **Program Support Information (page 145)**.

**Ask Toolbar**

Ask Jeeves, Inc.

For contacts about the software, see **Program Support Information (page 145)**.

**Bluetooth® Utility**

TOSHIBA Corporation

For contacts about the software, see **Program Support Information (page 145)**.

**Cingular Connection Manager**

Cingular Wireless

For contacts about the software, see **Program Support Information (page 145)**.

### Click to DVD® software

Sony Electronics Inc.

At the touch of a button, Click to DVD software allows you to automatically burn DVDs from a digital video (DV) device. Create DVDs by capturing video content straight from a DV device or by importing video from stored files — and you can also edit the video. Create DVD photo albums and slide shows with picture files or by importing pictures from a digital still camera. What's more, you can give a professional look to your DVDs by adding chapter menus, backgrounds, and menu screens. You are only a few clicks away from your own DVDs!

For contacts about the software, see **Program Support Information** (page 145).

### Digital Imaging Starter Edition

Microsoft Corp.

- For users in USA and Canada  
Web Site <http://support.microsoft.com>

### DISCover™ My Games™

DISCover

- For users in USA and Canada  
Web Site <http://www.discoverconsole.com>

### DVgate Plus™ software

Sony Electronics Inc.

Connect a compatible digital video camera to your computer's i.LINK port and capture video clips and still images. Edit clips from your video, add new clips, and combine clips into new movie segments. Save your movies back to your digital video camera or in a variety of popular file formats.

For contacts about the software, see **Program Support Information (page 145)**.

### Image Converter 2 Plus

Sony Electronics Inc.

Image Converter 2 Plus allows you to easily convert movie and picture files on your computer to your Memory Stick® media.

For contacts about the software, see **Program Support Information (page 145)**.

### InstantOn

InterVideo, Inc.

- For users in USA and Canada  
Web Site <http://www.intervideo.com/jsp/Support.jsp>

### Intel® PROSet

Intel Corporation

- For users in USA and Canada  
Web Site [http://www.intel.com/network/connectivity/products/wireless/proset/proset\\_software.htm](http://www.intel.com/network/connectivity/products/wireless/proset/proset_software.htm)

**Microsoft® Office Basic Edition, Office Professional Edition, Office Small Business Edition**

Microsoft Corp.

- For users in USA and Canada  
Web Site <http://support.microsoft.com>

**60-Day Trial Version of Microsoft® Office 2003**

! The Microsoft Office 2003 60-Day Trial software included with this computer system is intended for evaluation purposes only. The software has been installed and you must activate the software before you can use it. Product activation procedures will be detailed during initial launch of the software; activation requires Internet access. This software has an expiration date of 60 days from the date of first use, at which time the software will operate under reduced-functionality mode, limiting end-user options and operations.

Microsoft Corp.

- For users in USA and Canada  
Web Site <http://support.microsoft.com>

**Microsoft® Internet Explorer, Movie Maker, Media Player, Works**

Microsoft Corp.

- For users in USA and Canada  
Web Site <http://support.microsoft.com>

## Netscape® Browser

America Online, Inc.

- For users in USA and Canada  
Web Site <http://browser.netscape.com>

## Norton Internet Security™

Symantec Corporation

- For users in USA and Canada  
Web Site <http://www.symantec.com/techsupp>

## PenPlus for VAIO®

Sony Electronics Inc.

PenPlus for VAIO will allow you to write or draw directly on the screen with the stylus or create "sticky note" reminders. For contacts about the software, see **Program Support Information (page 145)**.

## Protector Suite QL

Sony Electronics Inc.

Protector Suite QL Edition allows you to easily setup your fingerprint sensor that comes with your computer. Protector Suite QL supports fingerprint logon, fast user switching, file encryption, registering forms and more. For contacts about the software, see **Program Support Information (page 145)**.

**Quicken® New User Edition**

Intuit Inc.

- For users in USA and Canada  
Web Site <http://www.intuit.com/support/quicken/>

**ROXIO DigitalMedia®**

Sonic Solutions

- For users in USA and Canada  
Web Site <http://support.sonic.com/>

**SmartDraw® Suite Edition 30 day trial**

SmartDraw.com

- For users in USA and Canada  
Web Site <http://www.smartdraw.com/support/index.htm>

**SmartWi™ Connection Utility**

Sony Electronics Inc.

SmartWi Connection Utility allows you to easily switch between the various wireless components (Wireless LAN, Wireless WAN, and Bluetooth technology connectivity) that came with your computer.

For contacts about the software, see **Program Support Information (page 145)**.



### **SonicStage® software**

Sony Electronics Inc.

The SonicStage jukebox software program gives you all the tools you need to manage music on your computer. SonicStage software supports high-quality digital audio storage, a sleek player skin design, and audio CD burning capability.

For contacts about the software, see **Program Support Information (page 145)**.

### **SonicStage Mastering Studio™ software**

Sony Electronics Inc.

Use SonicStage Mastering Studio software to record songs from analog records or cassette tapes into your computer and output them to CDs, DVDs, or audio files in WAV format.

For contacts about the software, see **Program Support Information (page 145)**.

### **System Mechanic® 6**

iolo technologies®, LLC

- For users in USA and Canada

Web Site <http://www.iolo.com/contactus.cfm>

### **Trend Micro™ Anti-Spyware**

Trend Micro, Inc.

- For users in USA and Canada

Web Site <http://kb.trendmicro.com/search/default.asp>

### **Ulead BD DiscRecorder for VAIO® computers**

Ulead Systems, Inc.

For questions and technical assistance, please check the help and the readme files.

### **VAIO® Action Setup**

Sony Electronics Inc.

VAIO Action Setup manages the settings for your computer's shortcut keys.

For contacts about the software, see **Program Support Information** ([page 145](#)).

### **VAIO® Back-up Utility**

Sony Electronics Inc.

For contacts about the software, see **Program Support Information** ([page 145](#)).

### **VAIO® Camera Capture Utility**

Sony Electronics Inc.

VAIO Camera Capture Utility is provided for capturing still images and movies with the external camera connected to a USB port or an i.LINK port on your computer or with the built-in MOTION EYE camera on your computer.

For contacts about the software, see **Program Support Information** ([page 145](#)).

### **VAIO® Camera Utility**

Sony Electronics Inc.

VAIO Camera Utility provides you with various video quality settings when using the internal camera.

For contacts about the software, see **Program Support Information** ([page 145](#)).

### **VAIO® Central**

Sony Electronics Inc.

VAIO Central provides a central location that gathers resources to configure your VAIO computer and view your computer's configuration and specifications.

For contacts about the software, see **Program Support Information** ([page 145](#)).

### **VAIO® Diagnostic**

Sony Electronics Inc.

For contacts about the software, see **Program Support Information** ([page 145](#)).

### **VAIO® Edit Component**

Sony Electronics Inc.

VAIO Edit Component provides enhanced editing functionality when using Adobe Premiere Pro or Adobe Premiere Elements on your VAIO computer.

For contacts about the software, see **Program Support Information** ([page 145](#)).

### **VAIO® HDD Protection**

Sony Electronics Inc.

VAIO HDD Protection allows you to customize your settings for protecting your hard disk against shock hazards. For contacts about the software, see **Program Support Information (page 145)**.

### **VAIO Media™ software**

Sony Electronics Inc.

VAIO Media™ software brings multimedia to your network, enabling you to share music, video, and still image files between your VAIO® computers. You can set up one or more VAIO computers as "media servers," which store your multimedia files and make them available to other compatible VAIO computers on your wired or wireless network. For contacts about the software, see **Program Support Information (page 145)**.

### **VAIO® Security Center**

Sony Electronics Inc.

Sony cares about your VAIO personal computer. The VAIO Security Center highlights some of the security features your machine includes. For contacts about the software, see **Program Support Information (page 145)**.

## VAIO® Support Central

Sony Electronics Inc.

VAIO Support Central provides an easy to navigate solution to common support needs, such as VAIO Documentation, product specifications, serial number, model name, service tag information, survey, registration, etc.

For contacts about the software, see **Program Support Information (page 145)**.

## VAIO® Touch Launcher

Sony Electronics Inc.

VAIO Touch Launcher allows you to run an application program or change the sound/display settings with the buttons on the launcher window.

For contacts about the software, see **Program Support Information (page 145)**.

## VAIO® Update

Sony Electronics Inc.

The VAIO Update utility helps you keep your VAIO® computer up to date by regularly checking the Sony online support Web site for important software updates and information for your specific VAIO computer model.

For contacts about the software, see **Program Support Information (page 145)**.

## VAIO Zone™ software

Sony Electronics Inc.

VAIO Zone software provides an effortless way to browse and enjoy pictures, music, and video files on your computer, all through an elegant, next-generation interface. You can even enjoy media content stored on other VAIO® computers on your network. On VAIO computer models with a recordable DVD drive, VAIO Zone enables you to record video and slide shows of pictures to DVD. On VAIO computer models with a built-in TV tuner, VAIO Zone includes a complete personal video recorder, enabling you to record TV programs and burn them to DVD.

For contacts about the software, see **Program Support Information (page 145)**.

## WinDVD® software for VAIO® computers

InterVideo, Inc.

- ❑ For users in USA and Canada  
Web site <http://www.intervideo.com/jsp/Support.jsp>  
Telephone 510-651-0888

## Wireless Setup Utility

Sony Electronics Inc.

The Wireless Setup Utility walks you through setting up your wireless network connection and offers useful diagnostic tests to help keep your wireless network running smoothly.

For contacts about the software, see **Program Support Information (page 145)**.

**Xdrive™**

America Online, Inc.

- For users in USA and Canada

Web Site <http://www.xdrive.com/support>

**Zoom Utility**

Sony Electronics Inc.

The Zoom Utility will allow you to magnify a portion of the screen.

For contacts about the software, see **Program Support Information (page 145)**.





## Free Manuals Download Website

<http://myh66.com>

<http://usermanuals.us>

<http://www.somanuals.com>

<http://www.4manuals.cc>

<http://www.manual-lib.com>

<http://www.404manual.com>

<http://www.luxmanual.com>

<http://aubethermostatmanual.com>

Golf course search by state

<http://golfingnear.com>

Email search by domain

<http://emailbydomain.com>

Auto manuals search

<http://auto.somanuals.com>

TV manuals search

<http://tv.somanuals.com>