

SONY

User Guide

Personal Computer
VGN-SZ300 Series



Contents

Before Use	6
Documentation	6
Ergonomic Considerations	8
Getting Started	10
Locating Controls and Ports	11
About the Indicator Lights	17
Connecting a Power Source	19
Using the Battery Pack	20
Shutting Down Your Computer Safely	25
Using Your VAIO Computer	26
Using the Keyboard	27
Using the Touch Pad	29
Using Special-function Buttons	30
Using the Built-in MOTION EYE Camera.....	31
Using the Optical Disc Drive	32
Using PC Cards	43
Using the ExpressCard Module	46
Using the Memory Stick Media	50
Using Other Memory Cards	55
Using the Internet.....	58
Using Wireless LAN (WLAN)	59
Using the Bluetooth Functionality	69

Using Peripheral Devices	76
Connecting a Docking Station	77
Connecting External Speakers	86
Connecting an External Display	87
Selecting Display Modes	91
Using the Multiple Monitors Function	92
Connecting an External Microphone	94
Connecting a Universal Serial Bus (USB) Device	95
Connecting a Printer	98
Connecting an i.LINK Device	99
Connecting to a Network (LAN)	101
Customizing Your VAIO Computer	103
Selecting Performance Modes	104
Setting the Password	105
Using Fingerprint Authentication	114
Using Trusted Platform Module (TPM)	132
Setting Up Your Computer with VAIO Central	137
Using the Power Saving Modes	138
Managing Power with VAIO Power Management	143
Protecting the Hard Disk	146
Upgrading Your VAIO Computer	147
Adding and Removing Memory	148

Precautions	155
On Handling the LCD Screen	156
On Using the Power Source	157
On Handling Your Computer.....	158
On Using the Built-in MOTION EYE Camera.....	160
On Handling Floppy Disks	160
On Handling Discs	161
On Using the Battery Pack.....	162
On Using Headphones.....	163
On Handling Memory Stick Media.....	164
On Handling the Hard Disk	165
On Handling the Memory Card Adapter.....	166
Troubleshooting	167
Computer	169
System Security	177
Battery.....	179
Built-in MOTION EYE Camera.....	181
Internet.....	184
Networking	186
Bluetooth Technology	189
Optical Discs	193
Display	198
Printing.....	200
Microphone	201

Mouse	202
Speakers	203
Touch Pad.....	204
Keyboard.....	205
Floppy Disks	206
PC Cards	207
Audio/Video.....	208
Memory Stick Media	209
Peripherals.....	210
Docking Station.....	211
Support Options	212
Sony Support Information	212
Program Support Information.....	215

Before Use

Congratulations on your purchase of this Sony VAIO® computer, and welcome to the on-screen User Guide. Sony has combined leading-edge technology in audio, video, computing, and communications to provide state-of-the-art personal computing.

Documentation

Your documentation includes printed information and user guides to read on your VAIO computer.

Printed Documentation

- Welcome mat** — Contains an overview of connections, setting up information, etc.
- Safety Information** — Contains safety guidelines and owner information.

Non-printed Documentation

- ❑ **User Guide** (this manual) — Contains features of your computer. It also includes information about the software programs included with your computer, as well as information on solving common problems.

- ❑ **Specifications** — The online **Specifications** describe the hardware and software configuration of your VAIO computer.

To view the online **Specifications**:

- 1 Connect to the Internet.
- 2 Go to the Sony online support Web site at <http://esupport.sony.com/EN/VAIO/> for customers in USA, at <http://www.sony.ca/support> for customers in Canada, at <http://esupport.sony.com/ES/VAIO/> for customers in Latin American countries or areas, or at <http://esupport.sony.com/ES/VAIO/BR/> for customers in Brazil.

- ❑ **VAIO Recovery Guide** — Provides information about restoring individual software programs, software drivers, and drive partition(s) or your entire hard disk drive to the original factory installed settings.

To access this on-screen guide:

- 1 Click **Start**, point to **All Programs**, and click **VAIO Support Central**.
- 2 Click **VAIO Documentation**.
- 3 Click **VAIO Recovery Guide**.

- ❑ **SmartWi™ Connection Utility Guide** (Selected models only) — Provides information about setting up Bluetooth, Wireless LAN, and Wireless WAN functionalities.

To access this on-screen guide:

- 1 Click **Start**, point to **All Programs**, and click **VAIO Support Central**.
- 2 Click **VAIO Documentation**.
- 3 Click **SmartWi Connection Utility Guide**.

Ergonomic Considerations

You will be using your computer as a portable device in a variety of environments. Whenever possible, you should attempt to take account of the following ergonomic considerations to both stationary and portable environments:

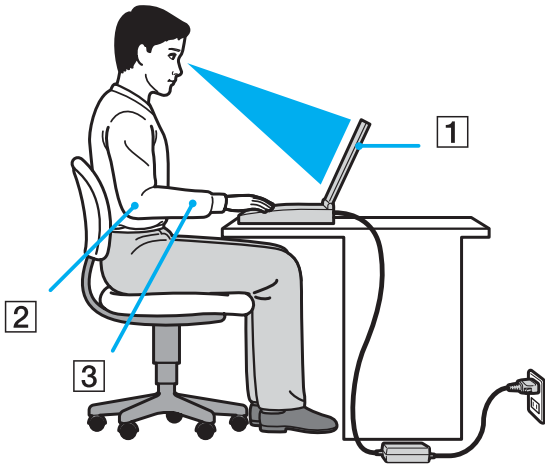

- ❑ **Position of your computer** – Place the computer directly in front of you (1). Keep your forearms horizontal (2), with your wrists in a neutral, comfortable position (3) while using the keyboard, touch pad, or external mouse. Let your upper arms hang naturally at your sides. Have breaks during sessions with your computer. Excessive use of the computer may strain muscles or tendons.
- ❑ **Furniture and posture** – Sit in a chair with good back support. Adjust the level of the chair so your feet are flat on the floor. A footrest may make you more comfortable. Sit in a relaxed, upright posture and avoid slouching forward or leaning far backwards.

- ❑ **Viewing angle of the computer's display** – Use the display's tilting feature to find the best position. You can reduce eye strain and muscle fatigue by adjusting the tilt of the display to the proper position. Adjust the brightness setting of the display as well.
- ❑ **Lighting** – Choose a location where windows and lights do not create glare and reflection on the display. Use indirect lighting to avoid bright spots on the display. You can also purchase accessories for your display that help reduce glare. Proper lighting adds to your comfort and work effectiveness.
- ❑ **Positioning an external display** – When using an external display, set the display at a comfortable viewing distance. Make sure the display screen is at eye level or slightly lower when you are sitting in front of the monitor.

Getting Started

This section describes how to get started with using your VAIO computer.

! Before starting your computer for the first time, do not connect any new hardware that did not originally come with your computer. Make sure to start up your computer with only the supplied accessories connected and set up your system. Upon completion, connect one device (for example, a printer, an external hard disk drive, a scanner, and so on) at a time, following the manufacturer's instructions.

- ❑ **Locating Controls and Ports** ([page 11](#))
- ❑ **About the Indicator Lights** ([page 17](#))
- ❑ **Connecting a Power Source** ([page 19](#))
- ❑ **Using the Battery Pack** ([page 20](#))
- ❑ **Shutting Down Your Computer Safely** ([page 25](#))

Locating Controls and Ports

Take a moment to identify the controls and ports shown on the following pages.

! Please note that the illustrations in this manual may not necessarily apply to your model.

Front

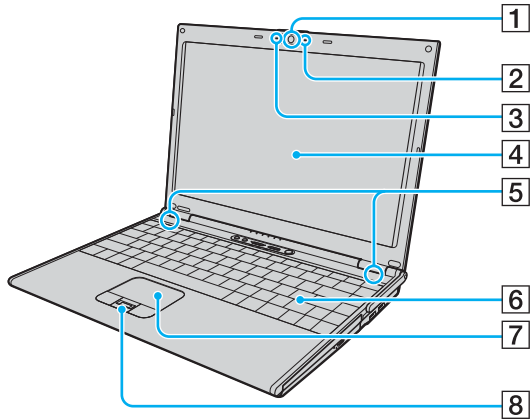

- 1 Built-in MOTION EYE camera* ([page 31](#))
- 2 Built-in MOTION EYE camera indicator* ([page 17](#))
- 3 Built-in microphone (monaural)*
- 4 LCD screen ([page 156](#))
- 5 Built-in speakers
- 6 Keyboard ([page 27](#))
- 7 Touch pad ([page 29](#))
- 8 Fingerprint sensor* ([page 114](#))

* On selected models only.

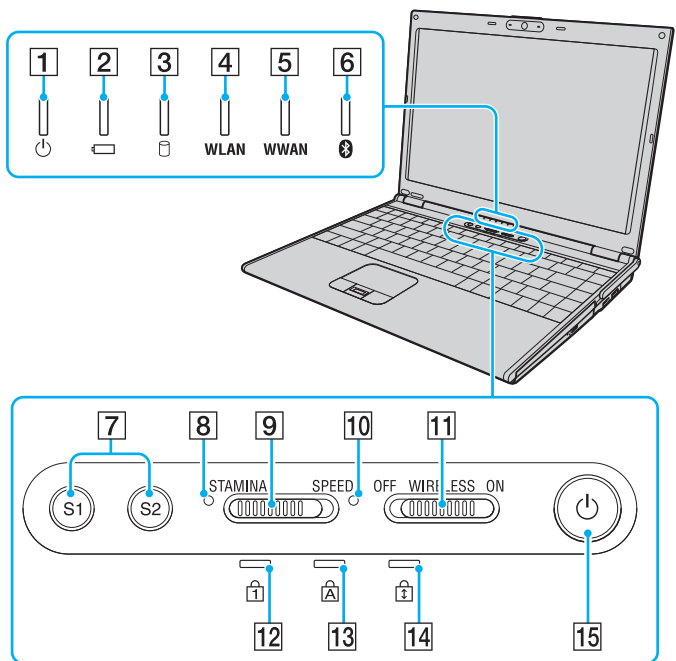

- 1 Power indicator (page 17)
 - 2 Battery indicator (page 17)
 - 3 Hard disk drive indicator (page 17)
 - 4 **WLAN** (Wireless LAN) indicator (page 17)
 - 5 **WWAN** (Wireless WAN) indicator* (page 17)
 - 6 Bluetooth indicator* (page 17)
 - 7 **S1/S2** buttons (page 30)
 - 8 **STAMINA** mode indicator (page 17)
 - 9 Performance selector switch (page 104)
 - 10 **SPEED** mode indicator (page 17)
 - 11 **WIRELESS** switch (page 59)
 - 12 Num lock indicator (page 17)
 - 13 Caps lock indicator (page 17)
 - 14 Scroll lock indicator (page 17)
 - 15 Power button
- * On selected models only.

Back

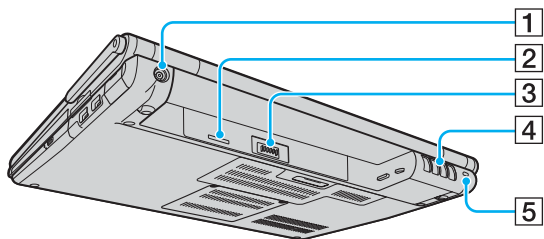

1 DC IN port ([page 19](#))

2 SIM card slot*

See the **SmartWi Connection Utility Guide** for more information.

3 Battery connector ([page 20](#))

4 Air vents

5 Security slot

* On selected models only.

Right

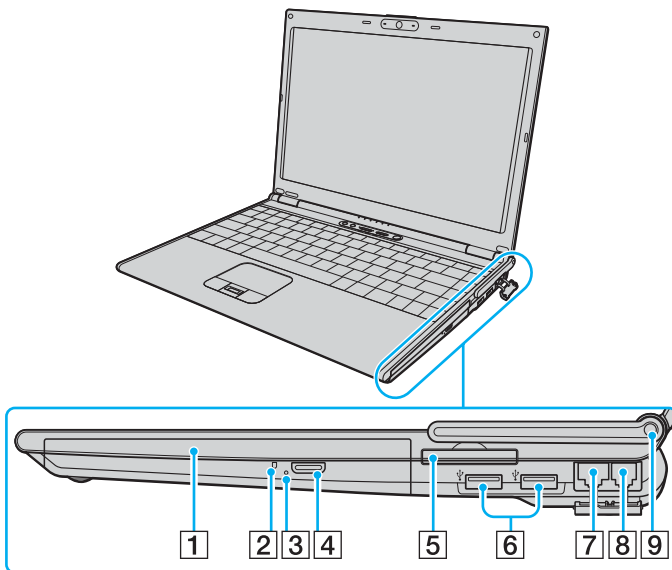

- 1 Optical disc drive ([page 32](#))
- 2 Optical disc drive indicator ([page 17](#))
- 3 Manual eject hole ([page 193](#))
- 4 Drive eject button ([page 32](#))
- 5 ExpressCard™/34 slot^{*1} ([page 46](#))
- 6 Hi-Speed USB (USB 2.0) ports^{*2} ([page 95](#))
- 7 Network (Ethernet) port ([page 101](#))
- 8 Modem port ([page 58](#))
- 9 WWAN antenna^{*3} ([page 59](#))

*1 Referred to as the ExpressCard slot hereinafter.

*2 Supports high-/full-/low- speeds.

*3 On selected models only.

Left

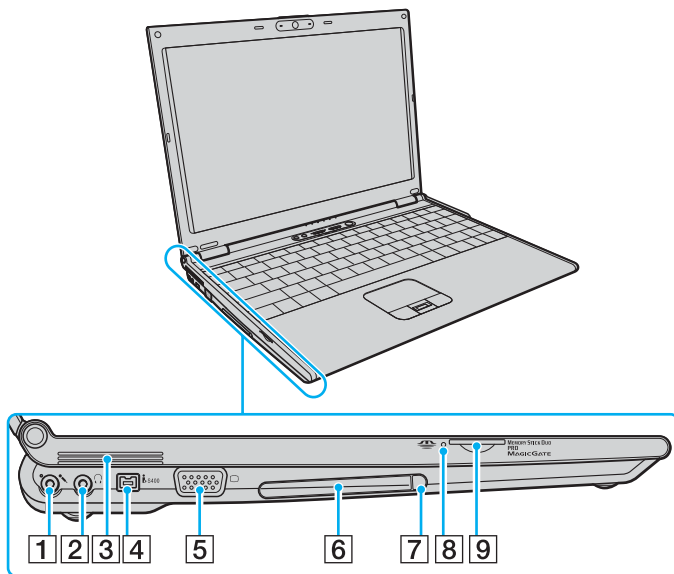

- 1 Microphone jack ([page 94](#))
 - 2 Headphones jack ([page 86](#))
 - 3 Air vents
 - 4 i.LINK (IEEE 1394) S400 port ([page 99](#))
 - 5 Monitor (VGA) port ([page 88](#))
 - 6 PC Card slot ([page 43](#))
 - 7 PC Card release button ([page 45](#))
 - 8 Memory Stick Duo/PRO Duo media indicator ([page 17](#))
 - 9 Memory Stick Duo/PRO Duo media slot* ([page 52](#))
- * Your computer supports Memory Stick Duo media and Memory Stick PRO Duo media with high speed and high capacity capabilities.



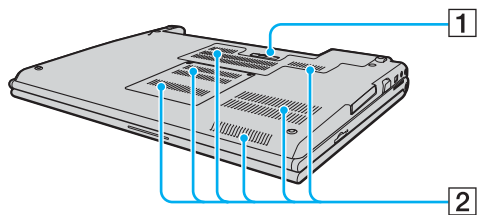



Bottom





- 1 Docking station connector ([page 78](#))
- 2 Air vents

About the Indicator Lights

Your computer is equipped with the following indicator lights.

Indicator	Functions
Power 	Illuminates when the power of the computer is on, blinks when the computer is in Standby mode, and turns off when the computer is in Hibernate mode or off.
Battery 	Illuminates when the computer is using battery power, blinks when the battery pack is running out of power, and double-blinks when the battery pack is charging.
Memory Stick Duo/PRO Duo media 	Illuminates when data is read from or written to the Memory Stick media in the Memory Stick Duo/PRO Duo slot. (Do not enter Standby mode or turn off the computer when this indicator is on.) When the indicator is off, the Memory Stick media is not being used.
Built-in MOTION EYE camera *	Illuminates while the built-in MOTION EYE camera is in use.
Optical disc drive	Illuminates when data is read from or written to the optical disc. When the indicator is off, the optical disc is not being used.
STAMINA mode	Illuminates when the computer is in STAMINA mode to conserve battery power.
SPEED mode	Illuminates when the computer is in SPEED mode to provide faster performance.
Hard disk drive 	Illuminates when data is read from or written to the hard disk. Do not enter Standby mode or turn off the computer when this indicator is on.
Num lock 	Press the Num Lk key to activate the numeric keypad. Press it a second time to deactivate the numeric keypad. The numeric keypad is not active when the indicator is off.
Caps lock 	Press the Caps Lock key to type letters in uppercase. Letters appear in lowercase if you press the Shift key while the indicator is on. Press the key a second time to turn off the indicator. Normal typing resumes when the Caps lock indicator is off.

Indicator	Functions
Scroll lock 	Press the Scr Lk key to change how you scroll the display. Normal scrolling resumes when the Scroll lock indicator is off. The Scr Lk key functions differently depending on the program you are using and does not work with all programs.
Bluetooth technology  *	Illuminates when the WIRELESS switch is set to ON and Bluetooth technology is enabled.
WIRELESS LAN	Illuminates when the wireless LAN function is running.
WIRELESS WAN*	Illuminates when the wireless WAN function is enabled.

* On selected models only.

Connecting a Power Source

You can use either an AC adapter or a rechargeable battery pack as a power source for your computer.

Using the AC Adapter



Use your computer only with the supplied AC adapter.

To use the AC adapter

- 1 Plug one end of the power cord (1) into the AC adapter (3).
- 2 Plug the other end of the power cord into an AC outlet (2).
- 3 Plug the cable attached to the AC adapter (3) into the **DC IN** port (4) on the computer or on the optional docking station.

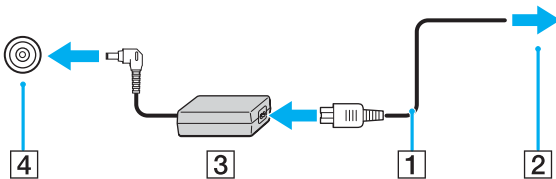

! The shape of the DC In plug varies depending on the AC adapter.



To disconnect your computer completely from AC power, unplug the AC adapter.

Make sure that the AC outlet is easily accessible.

If you do not use your computer for a long period of time, place the computer into Hibernate mode. See **Using Hibernate Mode (page 141)**. This power saving mode saves the time of shutting down or resuming.

Using the Battery Pack

The battery pack supplied with your computer is not fully charged at the time of purchase.

Installing the Battery Pack

To install the battery pack

- 1 Turn off the computer and close the LCD screen lid.
- 2 Slide the battery lock switch (1) to the **UNLOCK** position.

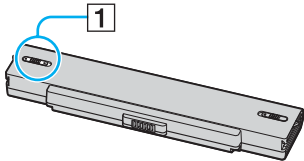

- 3 Slide the battery pack into the battery compartment until it clicks into place.

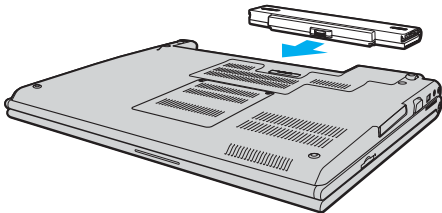

- 4 Slide the battery lock switch (1) to the **LOCK** position to secure the battery pack on the computer.



When your computer is directly connected to AC power and has a battery pack installed, it uses power from the AC outlet.



This computer is designed to operate only with genuine Sony batteries.

Charging the Battery Pack

The battery pack supplied with your computer is not fully charged at the time of purchase.

To charge the battery pack

- 1 Install the battery pack.
- 2 Connect the AC adapter to the computer.
The computer automatically charges the battery pack (the battery indicator light flashes in a double blink pattern as the battery pack charges). When the battery pack is about 85% charged, the battery indicator turns off.

Battery indicator light status	Meaning
On	The computer is using battery power.
Blinks	The battery pack is running out of power.
Double blinks	The battery pack is charging.
Off	The computer is using AC power.



When the battery pack is running out of power, both the battery and power indicator lights blink.

Keep the battery pack in your computer while it is directly connected to AC power. The battery pack continues to charge while you are using the computer.

If the battery level falls below 10%, you should either attach the AC adapter to recharge the battery pack or shut down your computer and install a fully charged battery pack.

The battery pack supplied with your computer is a lithium ion battery pack and can be recharged any time. Charging a partially discharged battery pack does not affect battery life.

The battery indicator light is on while you use the battery pack as a power source. When battery life is nearly depleted, both the battery and power indicator lights start flashing.

For some software applications and some peripheral devices, your computer may not enter Hibernate mode even when battery life is low. To avoid loss of data when using battery power, you should save your data frequently and manually activate a power management mode, such as Standby or Hibernate. If the battery pack wears out when the computer enters Standby mode, you will lose any unsaved data. Going back to the previous work state is impossible. To avoid loss of data, you should save your data frequently.

When your computer is directly connected to AC power and has a battery pack installed, it uses power from the AC outlet.

Removing the Battery Pack

! You may lose data if you remove the battery pack while your computer is on and not connected to the AC adapter or if you remove the battery pack while the computer is in Standby mode.

To remove the battery pack

- 1 Turn off the computer and close the LCD screen lid.
- 2 Slide the battery lock switch (1) to the **UNLOCK** position.

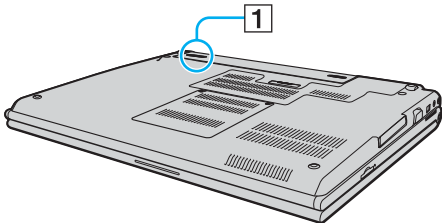

- 3 Slide and hold the battery release latch (2) and slide the battery pack away from the computer.

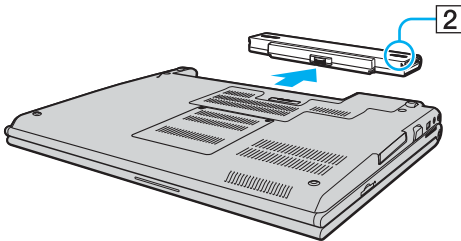

Shutting Down Your Computer Safely

To avoid losing unsaved data, be sure to shut down your computer properly, as described below.

To shut down your computer

- 1 Turn off any peripherals connected to the computer.
- 2 Click **Start** and then **Turn Off Computer**.
The **Turn off computer** window appears.
- 3 Click **Turn Off**.
- 4 Respond to any prompts warning you to save documents or to consider other users and wait for the computer to turn off automatically.
The power indicator light turns off.

Using Your VAIO Computer

This section describes how to get the most out of using your computer.

- ❑ **Using the Keyboard** ([page 27](#))
- ❑ **Using the Touch Pad** ([page 29](#))
- ❑ **Using Special-function Buttons** ([page 30](#))
- ❑ **Using the Built-in MOTION EYE Camera** ([page 31](#))
- ❑ **Using the Optical Disc Drive** ([page 32](#))
- ❑ **Using PC Cards** ([page 43](#))
- ❑ **Using the ExpressCard Module** ([page 46](#))
- ❑ **Using the Memory Stick Media** ([page 50](#))
- ❑ **Using Other Memory Cards** ([page 55](#))
- ❑ **Using the Internet** ([page 58](#))
- ❑ **Using Wireless LAN (WLAN)** ([page 59](#))
- ❑ **Using the Bluetooth Functionality** ([page 69](#))





Using the Keyboard



Your keyboard is very similar to a desktop computer keyboard, but has additional keys that perform model-specific tasks.

Combinations and Functions with the Fn Key



Some functions are not available before Windows is launched.

Combinations/Feature	Functions
Fn + F1 : wireless switching*	Toggles among Bluetooth, Wireless LAN, and Wireless WAN functionalities.
Fn +  (F2) : speaker switch	Turns on and off the built-in speakers and the headphones.
Fn +  (F3/F4) : volume	Adjusts the volume level. To increase volume, press Fn+F4 and then ↑ or → , or keep pressing Fn+F4 . To decrease volume, press Fn+F3 and then ↓ or ← , or keep pressing Fn+F3 .
Fn +  (F5/F6) : brightness control	Adjusts the LCD brightness of your computer screen. To increase lightness intensity, press Fn+F6 and then ↑ or → , or keep pressing Fn+F6 . To decrease lightness intensity, press Fn+F5 and then ↓ or ← , or keep pressing Fn+F5 .
Fn +  /  (F7) : display output	Toggles among your computer screen, an external display, and simultaneous output to both.

Combinations/Feature	Functions
Fn +  (F10): zoom	<p>Changes the screen resolution to magnify/restore your computer's screen view.</p> <p> The magnified view is not as clear as the standard view, as it is implemented by applying a lower resolution to the computer screen with a higher resolution. This key combination may not work with graphic images as it magnifies the screen view by changing the resolution. The location and size of software windows may change when the screen view is magnified or the standard view is restored because pressing this key combination changes the resolution. When your computer's screen view is magnified, switching the view to the external display disables the function and restores the standard view.</p>
Fn +  (F12): Hibernate	<p>Provides for the lowest level of power consumption. When you execute this command, the states of the system and the peripheral devices are written to the hard disk and the system power is turned off. To return the system to its original state, use the power button to turn on the power.</p> <p>For details on power management, see Using the Power Saving Modes (page 138).</p>

* On selected models only.

Using the Touch Pad

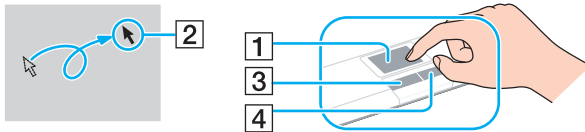

The keyboard contains a cursor-pointing device, the touch pad (1). You can point to, select, drag, and scroll objects on the screen using the touch pad.



Action	Description
Point	Slide one finger on the touch pad to place the pointer (2) on an item or object.
Click	Press the left button (3) once.
Double-click	Press the left button twice.
Right-click	Press the right button (4) once. In many applications, this action displays a shortcut menu.
Drag	Slide one finger on the touch pad while pressing the left button.
Scroll	<p>Move your finger along the right edge of the touch pad to scroll vertically. Move your finger along the bottom to scroll horizontally (the scroll function is available only with applications that support a touch pad scroll feature).</p> <p> On the models with the fingerprint sensor, you can also use the sensor for vertical scrolling while the Scroll lock indicator is lit. Press the Fn+Scr Lk keys to turn on and off the indicator.</p>

Using Special-function Buttons

Your computer is equipped with special buttons to help you use specific functions of the computer.

Special-function button	Functions
S1/S2 buttons  	By default, the S1 button turns the volume on and off and the S2 button lowers the CPU speed to reduce the fan noise. You can change these button assignments on the window for changing the S button assignments. To display this window, press and hold either button or launch and navigate through VAIO Central .

Using the Built-in MOTION EYE Camera

Your computer may be equipped with a built-in MOTION EYE camera. See the online **Specifications** to find whether your model is equipped with the built-in MOTION EYE camera.

The built-in MOTION EYE camera adds video functionality to instant messaging software and video editing software, for example **Windows Messenger** and **Windows MovieMaker**.

Turning on the computer activates the built-in MOTION EYE camera, so the computer is ready for a video conference using such software.

Note that launching or exiting your instant messaging or video editing software does not activate or deactivate the built-in MOTION EYE camera, respectively. Make sure that the camera is activated before using the software.



The built-in MOTION EYE camera cannot be shared by more than one software application. If another software application is using the camera, exit the application before using the built-in MOTION EYE camera.



The viewer window may show some noises, for example horizontal streaks, if you view a rapid-moving object. This is normal and does not indicate a malfunction.

Using the Optical Disc Drive

Your computer is equipped with an optical disc drive.

To insert a disc

- 1 Turn on the computer.
- 2 Press the drive eject button (1) to open the drive.
The tray slides out.
- 3 Place a disc in the middle of the tray with the label side facing upward and gently push it until the disc clicks into place.

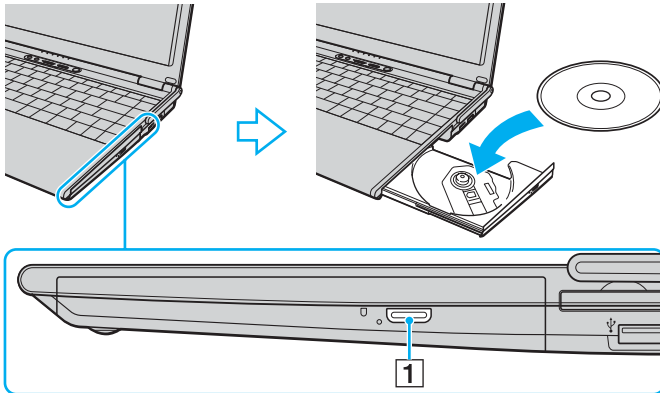

4 Close the tray by pushing it in gently.



Do not remove the optical disc when your computer is in a power saving mode (Standby or Hibernate). Doing so may cause the computer to malfunction.



If you plan to use an external optical disc drive, connect the drive before you launch any preinstalled CD/DVD program.

Reading and Writing Optical Discs

Your computer plays and records CDs and DVDs, depending on the model you purchased. Check your specifications for the type of optical disc drive installed on your model. Use the table below to see which types of media your optical disc drive supports.

PR: playable and recordable
 P: playable but not recordable
 -: not playable nor recordable

	CD-ROM	Video CD	Music CD	CD Extra	CD-R/RW	DVD-ROM	DVD-Video	DVD-R/RW	DVD+R/RW	DVD+R DL	DVD-R DL	DVD-RAM
DVD±RW/±R DL/RAM	P	P	P	P	PR	P	P	PR ^{*1 *2}	PR	PR ^{*5}	PR ^{*6}	PR ^{*3 *4}
DVD±RW/+R DL/RAM	P	P	P	P	PR	P	P	PR ^{*1 *2}	PR	PR ^{*5}	P	PR ^{*3 *4}
DVD±RW (Supporting DVD±R DL)	P	P	P	P	PR	P	P	PR ^{*1 *2}	PR	PR ^{*5}	PR ^{*6}	-
DVD±RW (Supporting DVD+R DL)	P	P	P	P	PR	P	P	PR ^{*1 *2}	PR	PR ^{*5}	P	-
CD-RW/DVD-ROM	P	P	P	P	PR	P	P	P	P	P	P	-
DVD-ROM	P	P	P	P	P	P	P	P	P	P	P	-

^{*1} Supports writing data to DVD-R discs compliant with DVD-R for General Version 2.0/2.1.

^{*2} Supports writing data to DVD-RW discs compliant with DVD-RW Version 1.1/1.2.

^{*3} The DVD±RW/RAM disc drive on your computer does not support the DVD-RAM cartridge. Use non-cartridge discs or discs with removable cartridge.

^{*4} Writing data to single-sided DVD-RAM discs (2.6 GB) compliant with DVD-RAM Version 1.0 is not supported.
 DVD-RAM Version 2.2/12X-SPEED DVD-RAM Revision 5.0 disc is not supported.

^{*5} Writing data to DVD+R DL (Double Layer) discs is available only on discs supporting DVD+R DL (Double Layer) recording.

^{*6} Writing data to DVD-R DL (Dual Layer) discs is available only on discs supporting DVD-R DL (Dual Layer) recording.

PR: playable and recordable
 P: playable but not recordable
 -: not playable nor recordable

	CD-ROM	Video CD	Music CD	CD Extra	CD-R/RW	DVD-ROM	DVD-Video	BD-ROM	DVD-R/RW	DVD+R/RW	DVD+R/DL	DVD-R/DL	DVD-RAM	BD-R ^{*9} /RE ^{*10}
Blu-ray Disc Drive	P	P	P	P	PR ^{*8}	P	P	P	PR ^{*1} *2	PR	PR ^{*5}	PR ^{*6}	PR ^{*6}	PR ^{*7}

^{*7} Supports writing data to BD-R Version 1.1 discs (single-layer discs with the capacity of 25 GB, dual-layer discs with the capacity of 50 GB) and BD-RE Version 2.1 discs (single-layer discs with the capacity of 25 GB, dual-layer discs with the capacity of 50 GB). The Blu-ray disc drive on your computer does not support BD-RE Version 1.0 discs and Blu-ray cartridge discs.

^{*8} Writing data to Ultra Speed CD-RW discs is not supported.

^{*9} BD-R stands for Blu-ray Disc-Recordable in Version 1.1 format.

^{*10} BD-RE stands for Blu-ray Disc-Rewritable in Version 2.1 format.

!
 This product is designed to playback discs that conform to the Compact Disc Digital Audio standard specifications (CD Standard). A DualDisc is a two sided disc product which mates DVD recorded material on one side with digital audio material on the other side. Please be aware that the audio side (non-DVD side) of a DualDisc may not play on this product because it does not conform to the CD Standard.

!
 Due to the multiple formats of discs now available, when buying pre-recorded or blank discs for use with a VAIO computer, be sure to read the notices on the disc packaging carefully to check both playback and recording compatibility with your computer's optical disc drives. Sony does NOT guarantee the compatibility of VAIO CD drives with discs that are not compliant with the official "CD" format standard (or "DVD" standard in relation to DVD drives). **USING NON-COMPLIANT DISCS CAN CAUSE FATAL DAMAGE TO YOUR VAIO PC OR CREATE SOFTWARE CONFLICTS AND CAUSE SYSTEM HANGING.** For inquiries about disc formats, contact the individual publisher of the pre-recorded disc or the manufacturer of the recordable disc.



Supports 8cm disc reading, but not 8cm disc writing.

Notes on writing data to a disc

- ❑ To make data on a disc readable on the optical disc drive, you need to close the session before you eject it. To complete this process, follow the instructions included with your software.
- ❑ Only use circular discs. Do not use discs in any other shape (star, heart, card, etc.), as this may damage the optical disc drive.
- ❑ Do not strike or shake your computer while writing data to a disc.
- ❑ Deactivate the screen saver and exit anti-virus software before writing data to a disc.
- ❑ Do not use memory-resident utility software while writing data to a disc. This may cause your computer to malfunction.
- ❑ When using your software application to burn discs, make sure you exit and close all other applications.
- ❑ Never touch the surface of the disc. Fingerprints and dust on the surface of a disc may cause writing errors.
- ❑ Do not switch power modes while using the preinstalled software and while using the CD burning software.
- ❑ Never affix an adhesive label to discs. This will affect the use of the disc irreparably.
- ❑ Connect and use the AC adapter to power your computer or make sure your battery pack is at least 50 percent charged.
- ❑ Some DVD players and computer's DVD drives may not be able to play DVDs created on applicable models using the **VAIO Zone** software.
- ❑ Use only Sony Value-added software when writing to CD/DVD media. (Ex: **Click to DVD**)
Other software programs may not be fully compatible and errors may result.

Notes on playing DVDs

To achieve optimum performance when playing DVDs, you should follow these recommendations.

- ❑ You can play DVDs using the optical disc drive and the DVD playback software, such as **VAIO Zone** or **WinDVD**. See the help file on such software for details.
- ❑ Close all open applications before playing a DVD movie.
- ❑ Do not use memory-resident utility software to speed up disc access when playing a DVD. This may cause your computer to malfunction.
- ❑ Deactivate the screen saver and exit anti-virus software before playing a disc.
- ❑ Some discs recorded at 20 or 24 bits may produce noise while playing. If you have audio devices connected, this may damage your hearing and the speakers. Reduce the volume before playing a DVD.
- ❑ Do not switch to power saving modes while your computer is playing a DVD.
- ❑ Region code indicators are labeled on the DVDs to indicate in which region and on what type of player you can play the disc. If the DVD is labeled "all," this means that you can play this DVD in most regions of the world. If the region code of your residence area is different from the label on the DVD disc or on the packaging, you cannot play the disc on your computer.

! You can change the DVD region code only a limited number of times. When you have exceeded this number, the drive's DVD region code is permanently assigned and you will not be able to change it again. Reconfiguring your computer does not reset this count.

If you change the DVD region code while the **WinDVD** software is running, restart the software or eject the disc and re-insert it to make the new setting effective.

- ❑ If your computer has the Wireless LAN functionality and Wireless LAN is activated, playing DVDs may cause some interruptions in audio and video.
- ❑ When you are playing a DVD (video or audio) and you want to remove a USB device, such as USB-compatible speakers, make sure you stop the DVD first. Removing a USB-compatible device during DVD (video or audio) playback may cause a malfunction.

Playing CDs

To play an audio CD

- 1 Insert a disc into the optical disc drive.
- 2 If nothing appears on the desktop, then click **Start**, point to **All Programs**, and click to start the desired CD software, such as the **SonicStage** software.

If the **Audio CD** window appears, click to select an option.

Copying Files to CDs

To copy files to a disc

! Do not strike or shake your computer while writing data to a disc.

- 1 Insert a blank disc into the optical disc drive.
If the **CD Drive** window appears, click **Take no action** and then click **OK**.
- 2 Right-click **Start** and then click **Explore**.
- 3 In the **Folders** panel on the left, locate the file(s) or folder(s) you want to copy, right-click the file(s) or folder(s), point to **Send To**, and then click the optical disc drive* name.
- 4 Close the window.
- 5 Click **Start** and then **My Computer**.
- 6 Click the optical disc drive icon under **Devices with Removable Storage**. A new window appears with the file(s) or folder(s) you want to copy listed under **Files Ready to Be Written to the CD**.
- 7 In the **CD Writing Tasks** box, click **Write these files to CD**.
- 8 Follow the instructions in the **CD Writing Wizard**.

* The read/write drive letter designation may vary, depending on your system's hardware configuration.

Playing DVDs

To play a DVD

- 1 Close all running software applications.
- 2 Insert a DVD into the optical disc drive.
- 3 If nothing appears on the desktop, then click **Start**, point to **All Programs**, and click to start the desired DVD software to play the DVD.

For instructions on how to use the software, see the help file on your DVD software.

Copying Files to DVDs

The DVD writing function is available on selected models only. See the online **Specifications** to find the type of your optical disc drive, and then **Reading and Writing Optical Discs (page 34)** to find about the supported disc media.

To copy files to a disc

- 1 Connect the AC adapter to the computer.
- 2 Insert a disc into the optical disc drive.
- 3 If nothing appears on the desktop, then click **Start**, point to **All Programs**, and click to start the DVD software you want to use.

For instructions on how to use the software, see the help file on your DVD software.

Using PC Cards

PC Cards allow you to connect portable external devices to your computer.

Inserting a PC Card

! Some PC Cards or their functions may not be compatible with your computer.

You do not need to shut down your computer before inserting or removing a PC Card.

To insert a PC Card

- 1 Push the PC Card release button so that the release button pops out.
- 2 Push the PC Card release button a second time so that the PC Card slot protector pops out.
- 3 Gently take hold of the protector and pull it out of the slot.
- 4 Insert the PC Card into the PC Card slot with the front label facing upward.
- 5 Gently push the PC Card into the slot.
The PC Card is automatically detected by your system.
The **Safely Remove Hardware** icon appears on the taskbar.

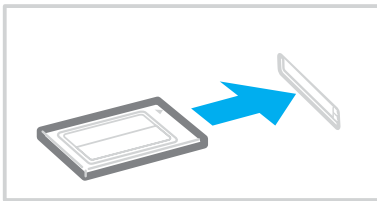

! Insert the PC Card slot protector to protect against debris entering the slot when not using a PC Card. Before moving your computer, make sure to insert the PC Card slot protector into the slot.

 Some devices may not function properly if you continually switch to Normal mode from Standby mode or Hibernate mode. For some PC Cards, if you alternate between Normal mode and Standby or Hibernate mode while the card is inserted, you may find that a device connected to your system is not recognized. Restart your system to correct the problem. Restarting will restore the original state of your computer.

While the card is inserted, your computer may not enter Hibernate power management mode. It may enter Standby mode. We recommend that you remove the card before the computer enters Hibernate mode.

Make sure you use the most recent software driver provided by the PC Card manufacturer.

If an "!" mark appears on the **Device Manager** tab in the **System Properties** window, remove the software driver and then reinstall it.

Do not force a PC Card into the slot. It may damage the connector pins. If you have difficulty inserting a PC Card, check that you are inserting the PC Card in the correct direction. See the manual that came with your PC Card for more information.

Removing a PC Card

Follow the steps below to remove the PC Card while your computer is on. If it is not removed properly, your system may not work properly.

To remove a PC Card



To remove a PC Card when your computer is off, skip steps 1 to 6.

- 1 Double-click the **Safely Remove Hardware** icon on the taskbar.
The **Safely Remove Hardware** window appears.
- 2 Select the hardware you want to unplug.
- 3 Click **Stop**.
The **Stop a Hardware Device** window appears.
- 4 Confirm that the device can be safely removed from the system.
- 5 Click **OK**.
A window appears, explaining that it is safe to remove the device.
- 6 Click **Close**.
- 7 Push the PC Card release button so that the release button pops out.
- 8 Push the PC Card release button a second time so that the PC Card pops out.
- 9 Gently take hold of the Card and pull it out of the slot.
- 10 If the PC Card release button is still out, push it back in.

Using the ExpressCard Module

Your computer is equipped with either a Universal ExpressCard slot* or an ExpressCard™/34 slot* for transferring data among digital cameras, camcorders, music players, and other audio/video devices. The former can accommodate either an ExpressCard™/34 (34 mm wide) or ExpressCard™/54 (54 mm wide) module* as shown below; and the latter, an ExpressCard™/34 module* only.

- ExpressCard™/34 module*



- ExpressCard™/54 module*

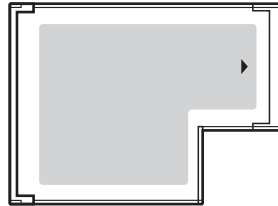

Your computer is equipped with an ExpressCard™/34 slot*.

* Hereinafter, referred to as the ExpressCard slot and the ExpressCard module.

Inserting an ExpressCard Module



Your computer is delivered with a slot protector in the ExpressCard slot. Remove the slot protector before you use the slot for the first time.

Use care when inserting or removing the ExpressCard module from the slot. Do not force it in or out of the slot.



You do not need to shut down your computer before inserting or removing the ExpressCard module.

To insert an ExpressCard module

- 1 Push the ExpressCard slot protector to pop it out.
- 2 Gently take hold of the ExpressCard slot protector and pull it out of the slot.
- 3 Hold the ExpressCard module with the arrow facing upward and pointing toward the ExpressCard slot.
- 4 Carefully slide the ExpressCard module (1) into the slot until it clicks into place.
Do not force it into the slot.

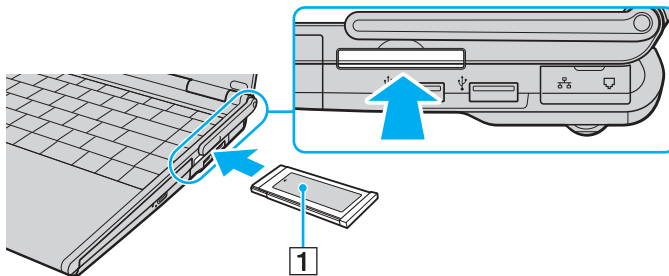

! Insert the ExpressCard slot protector to protect against debris entering the slot when not using an ExpressCard module. Before moving your computer, make sure to insert the ExpressCard slot protector into the slot.



If the module or adapter does not go into the slot easily, remove it gently and verify you are inserting it in the proper direction.

Make sure you use the most recent software driver provided by the ExpressCard module manufacturer.

Removing an ExpressCard Module

Follow the steps below to remove the ExpressCard module while your computer is on. If it is not removed properly, your system may not work properly.

To remove an ExpressCard module



To remove an ExpressCard module when your computer is off, skip steps 1 to 6.

- 1 Double-click the **Safely Remove Hardware** icon on the taskbar.
The **Safely Remove Hardware** window appears.
- 2 Select the hardware you want to unplug.
- 3 Click **Stop**.
The **Stop a Hardware Device** window appears.
- 4 Confirm that the device can be safely removed from the system.
- 5 Click **OK**.
A window appears, explaining that it is safe to remove the device.
- 6 Click **Close**.
- 7 Push in the ExpressCard module toward the computer to pop it out.
- 8 Gently take hold of the ExpressCard module and pull it out of the slot.

Using the Memory Stick Media

Your computer supports the Memory Stick media. Memory Stick media is a compact, portable, and versatile IC recording media especially designed for exchanging and sharing digital data with compatible products, such as digital cameras, mobile phones and other devices. Because it is removable, it can be used for external data storage.

For the latest information on Memory Stick media, visit the Sony online support Web site at:

<http://esupport.sony.com/EN/VAIO/> for customers in USA,

<http://www.sony.ca/support> for customers in Canada,

<http://esupport.sony.com/ES/VAIO/> for customers in Latin American countries or areas, or

<http://esupport.sony.com/ES/VAIO/BR/> for customers in Brazil.



Your computer has been tested and found compatible with the Sony branded Memory Stick media with capacity of up to 4 GB that are available as of May 2006. However, not all Memory Stick media that meet the same conditions as the compatible media are guaranteed of compatibility.

Inserting a Memory Stick media with multiple conversion adapters is not guaranteed of compatibility.

MagicGate is the general name of the copyright protection technology developed by Sony. Use a Memory Stick media with the MagicGate logo to use this feature.

Write-protecting a Memory Stick Media

Some versions of Memory Stick media are designed with an erasure prevention switch to protect valuable data from accidental erasure or overwriting.

Move the tab horizontally or vertically* to set or release write-protection. When the erasure prevention switch is off, data can be saved on the Memory Stick media. When the erasure prevention switch is on, data can be read from but not saved on the Memory Stick media.



Be sure to use a fine-tipped object to move the tab on the Memory Stick Duo media.

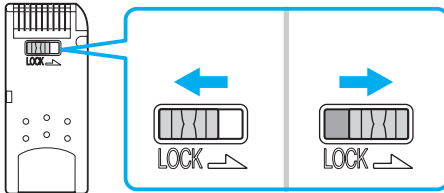

* Some versions of Memory Stick media do not have an erasure prevention switch.

Inserting a Memory Stick Media

There are two ways you can insert a Memory Stick media into your computer.

- ❑ Using the Memory Stick Duo/PRO Duo media slot
The Memory Stick media slot accommodates a small-size Memory Stick media: Memory Stick Duo or Memory Stick PRO Duo media.
- ❑ Using the ExpressCard slot
To insert a standard-size Memory Stick media, use the ExpressCard slot. To do this, you need the supplied memory card adapter. See **Using the ExpressCard Module (page 46)** and **Using Other Memory Cards (page 55)** for more information.

To insert a Memory Stick media using the Memory Stick Duo/PRO Duo media slot

- 1 Hold the Memory Stick media with the arrow facing upward and pointing toward the Memory Stick Duo/PRO Duo media slot.
- 2 Carefully slide the Memory Stick media into the slot until it clicks into place.
The Memory Stick media is automatically detected by your system and appears in your **My Computer** window as a local drive, under the appropriate letter (depending on the configuration of the computer).

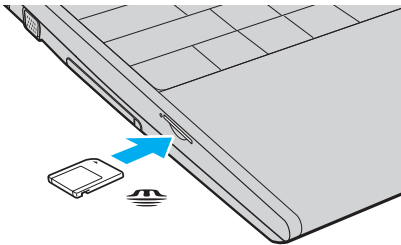

! Be sure to hold the Memory Stick media with the arrow pointing in the correct direction as you insert it into the slot. To avoid damaging your computer or the Memory Stick media, do not force the Memory Stick media into the slot if you cannot insert it smoothly.

Do not insert more than one Memory Stick media into the slot. Inserting the media improperly may damage your computer.



Your computer supports Memory Stick Duo media and is equipped with the Memory Stick Duo/PRO Duo slot that is only compatible with the duo-size media. For more information on the Memory Stick Duo media, visit the Memory Stick web site at <http://www.memorystick.com/en/>.

To view the contents of the Memory Stick media

- 1 Click **Start** and then **My Computer** to open the **My Computer** window.
- 2 Double-click the Memory Stick media icon to view the list of data files saved in the Memory Stick media.

To format a Memory Stick media

Use the **Memory Stick Formatter** software. See the help file on the **Memory Stick Formatter** software for details.

! Formatting the Memory Stick media erases the entire data on the media. Avoid accidental erasure of your valuable data.

Do not remove the Memory Stick media from the slot while formatting the media. This could cause a malfunction.

Be sure to use the preinstalled **Memory Stick Formatter** software to format a Memory Stick media. In case the media is formatted with the formatting function of the Windows operating system, the media cannot be recognized by other Memory Stick devices.

Removing a Memory Stick Media

To remove a Memory Stick media from the Memory Stick Duo/PRO Duo media slot

- 1 Check that the Memory Stick Duo/PRO Duo media indicator is off.
- 2 Push the Memory Stick media in toward the computer.
The Memory Stick media ejects.
- 3 Pull the Memory Stick media out of the slot.



Always remove the Memory Stick media gently, or it may pop out unexpectedly.

Do not remove the Memory Stick media while the Memory Stick Duo/PRO Duo media indicator is turned on. If you do, you may lose data. Large volumes of data may take time to load, so be sure the indicator is off before removing the Memory Stick media.

Using Other Memory Cards

Your computer is delivered with the memory card adapter for the ExpressCard slot to support the following memory cards besides the ExpressCard module:

- Standard-size Memory Stick and Memory Stick PRO
- Secure Digital (SD)
- MultiMediaCard (MMC)
- xD-Picture Card

! The MagicGate feature of the Memory Stick media and the Memory Stick PRO media is not supported.

The copyright protection and high-speed data transfer features of the SD memory card are not supported.

SDHC memory cards are not supported.

As for the Memory Stick PRO media, only Sony branded media is recommended to use with the adapter.

Your computer has been tested and found compatible only with major memory card media available as of May 2006. However, not all memory card media that meet the same conditions as the compatible media are guaranteed of compatibility.

Inserting a Memory Card

To insert a memory card to the memory card adapter

- 1 Insert any one of the memory cards (2) to the memory card adapter (1).

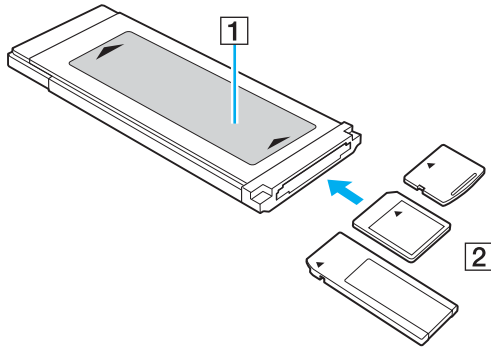

! Make sure to insert a memory card into the memory card adapter in the correct direction to avoid possible damage to the memory card adapter.

- 2 See **Inserting an ExpressCard Module** (page 47) to insert the memory card adapter into the ExpressCard slot.

Removing a Memory Card

To remove a memory card from the memory card adapter

See **Removing an ExpressCard Module (page 49)** to remove the memory card adapter from the ExpressCard slot. Then, firmly grasp the extended part of the memory card and carefully pull it out of the memory card adapter.

Using the Internet

Setting Up a Dial-up Internet Connection

Before you can connect to the Internet, you need to connect your computer to a telephone line with a telephone cable (may not supplied). Once you have set up your telephone cable connection, you're ready to connect to the Internet.

To connect a telephone cable

- 1 Plug one end of the phone cable (1) into the modem port  on the computer.
- 2 Plug the other end into the wall jack (2).

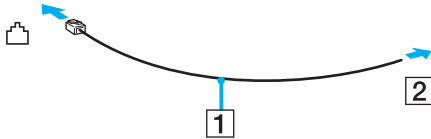

 Your computer does not work with party lines, cannot be connected to a coin-operated telephone, and may not work with multiple telephone lines or a private branch exchange (PBX). Some of these connections may result in excess electrical current and could cause a malfunction in the internal modem.

If you connect a telephone cable coming through a splitter, the modem or connected device may not work properly.

To set up a dial-up connection to the Internet

- 1 Click **Start**, point to **All Programs, Accessories, Communications**, and click **New Connection Wizard**. The **New Connection Wizard** appears.
- 2 Click **Next**. If the **Location Information** window appears, follow the on-screen instructions.
- 3 If it is not already selected, click to select **Connect to the Internet**, and click **Next**.
- 4 Follow the on-screen instructions.

Using Wireless LAN (WLAN)

Using the Sony Wireless LAN (WLAN), all your digital devices with built-in WLAN functionality communicate freely with each other through a powerful network. A WLAN is a network in which a user can connect to a local area network (LAN) through a wireless (radio) connection. So there is no need anymore to pull cables or wires through walls and ceilings.

The Sony WLAN supports all normal Ethernet activities, but with the added benefits of mobility and roaming. You can still access information, Internet/intranet and network resources, even in the middle of a meeting, or as you move from one place to another.

You can communicate without an access point, which means that you can communicate between a limited number of computers (ad-hoc). Or you can communicate through an access point, which allows you to create a full infrastructure network (infrastructure).

- ❑ Wireless WAN model users
Please see the **SmartWi Connection Utility Guide** for setting up Wireless LAN and Wireless WAN functionalities.
- ❑ Other model users
Please see the following for setting up Wireless LAN functionality.



In some countries, using WLAN products may be restricted by the local regulations (e.g. limited number of channels). Therefore, before activating the WLAN functionality, read the **Safety Information** carefully.

WLAN uses the IEEE 802.11a^{*} /b/g standard, which specifies the used technology. The standard includes the encryption methods: Wired Equivalent Privacy (WEP), which is a security protocol, Wi-Fi Protected Access 2 (WPA2), and Wi-Fi Protected Access (WPA). Proposed jointly by the IEEE and Wi-Fi Alliance, both WPA2 and WPA are specifications of standards based, interoperable security enhancements that increase the level of data protection and access control for existing Wi-Fi networks. WPA has been designed to be forward compatible with the IEEE 802.11i specification. It utilizes the enhanced data encryption TKIP (Temporal Key Integrity Protocol) in addition to user authentication using 802.1X and EAP (Extensible Authentication Protocol). Data encryption protects the vulnerable wireless link between clients and access points. Besides that, there are other typical LAN security mechanisms to ensure privacy, such as: password protection, end-to-end encryption, virtual private networks, and authentication. WPA2, the second generation of WPA, provides stronger data protection and network access control and is also designed to secure all versions of 802.11 devices, including 802.11b, 802.11a, and 802.11g, multi-band and multi-mode. In addition, based on the ratified IEEE 802.11i standard, WPA2 provides government grade security by implementing the National Institute of Standards and Technology (NIST) FIPS 140-2 compliant AES encryption algorithm and 802.1X-based authentication. WPA2 is backward compatible with WPA.

* See the online **Specifications** to see whether your model supports the IEEE 802.11a standard.

Wireless LAN devices using the IEEE 802.11a standard and the ones using the IEEE 802.11b or g standard cannot communicate because the frequencies are different.

IEEE 802.11b: The standard speed is 11 Mbps, or about 30 to 100 times faster than a standard dial up.

IEEE 802.11a/g: The standard speed is 54 Mbps, or about 5 times faster than a Wireless LAN device using the IEEE 802.11b standard.

The 2.4 GHz bandwidth used by wireless LAN compatible devices is also used by other various devices. Although technologies to minimize interference from other devices that use the same bandwidth are employed on wireless LAN compatible devices, such interference may cause lower communication speed, narrower communication range, or broken wireless connections.

The communication speed varies depending on the distance between communication devices, existence of obstacles between such devices, the device configuration, the radio conditions, and the software in use. In addition, communications may be cut off depending on the radio conditions.

The communication range varies depending on the actual distance between communication devices, existence of obstacles between such devices, the radio conditions, the ambient environment that includes existence of walls and materials of such walls, and the software in use.

Deploying IEEE 802.11b and IEEE 802.11g products on the same wireless network may reduce the communication speed due to radio interference. Taking this into consideration, the IEEE 802.11g products are designed to reduce the communication speed to ensure communications with IEEE 802.11b products.

When the communication speed is not as fast as expected, changing the wireless channel on the access point may increase the communication speed.

Communicating without an Access Point (Ad-hoc)

An ad-hoc network is a network in which a local network is created only by the wireless devices themselves, with no other central controller or access point. Each device communicates directly with other devices in the network. You can set up an ad-hoc network easily at home.

- If the Wireless connection is initiated by the VAIO computer, channel 11 will be selected.
- If the Wireless connection is initiated by peer Wireless LAN equipment, the Wireless LAN communication will make use of the channel selected by the peer Wireless LAN equipment.

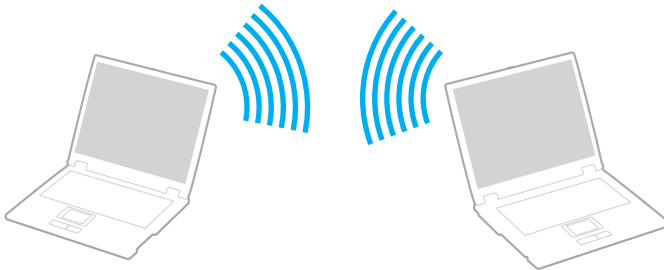



To communicate without an access point (ad-hoc)

- 1 Turn on the **WIRELESS** or **WIRELESS LAN** switch.

The WIRELESS LAN indicator lights up.

Except in Peru and Venezuela, you cannot select the 5 GHz bandwidth, which is used for the IEEE 802.11a standard, on ad-hoc networks.

On models that support the Bluetooth functionality*¹ and/or the IEEE 802.11a/b/g standard*¹, double-click  ( / ) on the taskbar to display the **Wireless Device Switch** window. Select your desired wireless option(s) and click **OK**.

- 2 Click **Start** and then **Control Panel**.

- 3 Click **Network and Internet Connections**.

- 4 Click **Network Connections**.

The **Network Connections** window appears.

- 5 Right-click **Wireless Network Connection**, then click **Properties**.

The **Wireless Network Connection Properties** window appears.

- 6 Select the **Wireless Networks** tab.

- 7 Click the **Add...** button.

The **Wireless network properties** window appears.

- 8 Enter a network name (SSID)*².

You can choose a 32-digit alphanumeric name.

- 9 Select **Open** from the **Network Authentication** drop-down box.

- 10 Select **WEP** from the **Data Encryption** drop-down box.

- 11 Deselect the **The key is provided for me automatically** option button.

Some information becomes visible.

12 Enter the network key^{*2}.

The network key should be 5 or 13 alphanumeric characters or 10 or 26 hexadecimal^{*3} characters long. You can choose whichever you want.

13 Enter exactly the same network key again for confirmation.

14 Select the check box **This is a computer-to-computer (ad hoc) network; wireless access points are not used** at the bottom of the window.

15 Click **OK**.

Your network name appears in the **Preferred networks**.

16 Click **Advanced**.

The **Advanced** window appears.

17 Select the **Computer-to-computer (ad hoc) networks only** option button.

18 Click **Close**.

19 Click **OK**.

The computer is ready to communicate with another computer.

*1 See the online **Specifications** to see whether your model supports the Bluetooth functionality and/or the IEEE 802.11a/b/g standard.

*2 If you want to communicate between two or more computers, you need to configure all these computers in the exact same way. This means that you need to enter the same network name and the same network key on all computers as on the first computer you configure.

*3 Hexadecimal: a number representation using the digits 0-9, with their usual meaning, and the letters A-F (or a-f) to represent hexadecimal digits with values of (decimal) 10 to 15.



An ad-hoc network does not support WPA.

To disconnect from a computer-to-computer (ad-hoc) network

- 1 Click **Start** and then **Control Panel**.
- 2 Click **Network and Internet Connections**.
- 3 Click **Network Connections**.
The **Network Connections** window appears.
- 4 In the right panel under **LAN or High-Speed Internet**, right-click **Wireless Network Connection**.
- 5 Click **Properties**.
The **Wireless Network Connection Properties** window appears.
- 6 On the **Wireless Networks** tab, click **Advanced**.
The **Advanced** window appears.
- 7 Click to select **Any available network (access point preferred)**, and click **Close**.
- 8 Click **OK**.
- 9 Close the **Network Connections** window.
- 10 Turn off the **WIRELESS** or **WIRELESS LAN** switch.

Communicating with an Access Point (Infrastructure)

An infrastructure network is a network that extends an existing wired local network to wireless devices by providing an access point, for example the Sony Access Point. The access point bridges the wireless and wired LAN and acts as a central controller for the Wireless LAN. The access point coordinates transmission and reception from multiple wireless devices within a specific range.



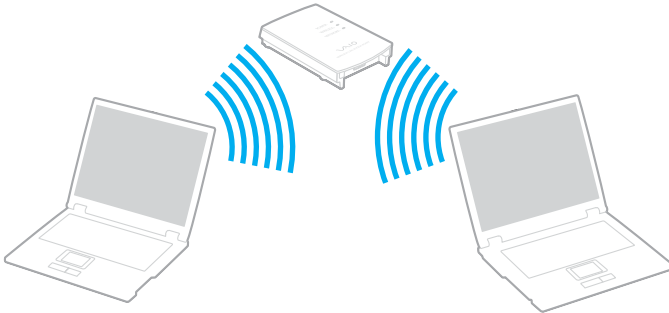

The access point will select which channel to use on an infrastructure network.

! For details on how to select the channel that will be used by the access point, see the manual that came with your access point.



To connect to a wireless network

- 1 Make sure an access point is set up.
See the manual that came with your access point for more information.
- 2 Turn on the **WIRELESS** or **WIRELESS LAN** switch.
The WIRELESS LAN indicator lights up.

On models that support the Bluetooth functionality* and/or the IEEE 802.11a/b/g standard*, double-click  ( /  / ) on the taskbar to display the **Wireless Device Switch** window. Select your desired wireless option(s) and click **OK**.



- 3 Click **Start** and then **Control Panel**.
- 4 Click **Network and Internet Connections**.
- 5 Click **Network Connections**.
- 6 In the right panel under **LAN or High-Speed Internet**, double-click **Wireless Network Connection**.
The **Wireless Network Connection** window appears.
- 7 Follow the on-screen instructions.

* See the online **Specifications** to see whether your model supports the Bluetooth functionality and/or the IEEE 802.11a/b/g standard.

To connect to a wireless network (models with the Wireless Setup Utility software only)

Use the **Wireless Setup Utility** software to guide you through the set up process and provide you with more detailed information about wireless connections.

- 1 Make sure an access point is set up.
See the manual that came with your access point for more information.
- 2 Turn on the **WIRELESS** or **WIRELESS LAN** switch.
The WIRELESS LAN indicator lights up.

On models that support the Bluetooth functionality* and/or the IEEE 802.11a/b/g standard*, double-click  ( / ) on the taskbar to display the **Wireless Device Switch** window. Select your desired wireless option(s) and click **OK**.

- 3 Click **Start**, point to **All Programs**, and click **Wireless Setup Utility**.
The **Wireless Setup Utility** appears.
- 4 Follow the on-screen instructions.

* See the online **Specifications** to see whether your model supports the Bluetooth functionality and/or the IEEE 802.11a/b/g standard.

To disconnect from a wireless network

Turn off the **WIRELESS** or **WIRELESS LAN** switch.

! Turning off the wireless LAN functionality while accessing remote documents, files, or resources may result in data loss.



For WPA-PSK or WPA2-PSK authentication, you must enter a network key of 8 to 64 alphanumeric characters long.



Using the Bluetooth Functionality

The Bluetooth functionality is available on selected models only. See the online **Specifications** to see whether your model supports the Bluetooth functionality.

You can establish wireless communication between your computer and other Bluetooth devices such as another computer or a mobile phone. You can transfer data between these devices without cables and up to 33 feet (10 meters) range in open space.

- Wireless WAN model users
Please see the **SmartWi Connection Utility Guide** for setting up Bluetooth functionality.
- Other model users
Please see the following for setting up Bluetooth functionality.

To connect to a Bluetooth device

- 1 Turn on the **WIRELESS** switch.
- 2 Double-click  ( / ) on the taskbar to display the **Wireless Device Switch** window.
- 3 Select the **Enable Bluetooth Device** option.
- 4 Click **OK**.

Notes on using the Bluetooth functionality

- ❑ The data transfer rate varies, depending on the following conditions:
 - ❑ Obstacles, such as walls, located between devices
 - ❑ Distance between devices
 - ❑ Material used in walls
 - ❑ Proximity to microwaves and cordless telephones
 - ❑ Radio frequency interference and other environmental conditions
 - ❑ Device configuration
 - ❑ Type of software application
 - ❑ Type of operating system
 - ❑ Use of both Wireless LAN and Bluetooth functionalities at the same time on your computer
 - ❑ Size of file being exchanged
- ❑ Note that due to limitations of the Bluetooth standard, large files may occasionally be corrupted during continuous transfer due to electromagnetic interference from the environment.
- ❑ All Bluetooth devices must be certified to make sure that the applicable standard requirements are maintained. Even if standards are met, individual device performance, specifications, and operation procedures can vary. Data exchange may not be possible in all situations.
- ❑ As general characteristics of Bluetooth technology, video and audio may go out of synchronization if you play videos on your computer with audio output from the connected Bluetooth device.

- ❑ The 2.4 GHz band, with which Bluetooth devices or wireless LAN devices work, is used by various devices. Bluetooth devices use the technology to minimize the interference from other devices that use the same wave length. Simultaneous use of the Bluetooth functionality and wireless communication devices, however, may cause radio interference and result in poorer communication speeds and distances than the standard values.
- ❑ The Bluetooth functionality may not work depending on the third party devices or the software version used by third party companies.
- ❑ As general characteristics of Bluetooth technology, connecting multiple Bluetooth devices to your computer may cause bandwidth congestion, resulting in poor performance of the devices.

Bluetooth Security

The Bluetooth wireless technology has an authentication function, which allows you to determine with whom you choose to communicate. With the authentication function, you can avoid any anonymous Bluetooth device to access your computer.

The first time two Bluetooth devices communicate, a common passkey (a password required for authentication) should be determined for both devices to be registered. Once a device is registered, there is no need to re-enter the passkey.



The passkey can be different each time, but must be the same at both ends.

For certain devices, such as a mouse, no passkey can be entered.

Communicating with Another Bluetooth Device

You can connect your computer to a Bluetooth device such as another computer, a mobile phone, a PDA, a headset, a mouse, or a digital camera without the use of any cables.

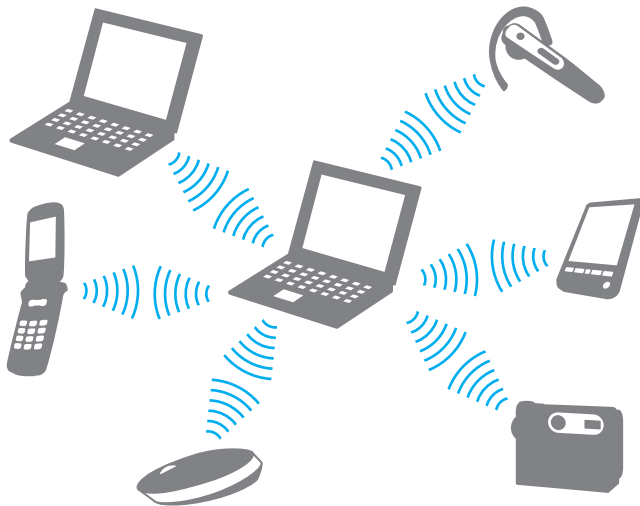

To communicate with another Bluetooth device

To communicate with another Bluetooth device, you need first to set up the Bluetooth functionality. For setting up and using the Bluetooth functionality, see the help file on the Bluetooth utility software.

To see the help file

- 1 Right-click the Bluetooth icon  on the taskbar, and select **Help** from the menu.

Stopping the Bluetooth Connection

To stop the Bluetooth connection, turn off the **WIRELESS** switch. The Bluetooth indicator turns off.

Using the Bluetooth Headset

The Bluetooth headset is available as an optional accessory. It will come in handy during a video conference over the Internet using instant messaging software, for example **Windows Messenger**. For details on using the Bluetooth headset, see the manual that came with your Bluetooth headset.

To connect the headset with your computer

- 1 Press and hold the headset power button for at least five seconds to turn on the Bluetooth headset.
- 2 Press and hold the volume buttons for at least five seconds until the indicator light blinks in red and green.
- 3 Right-click the Bluetooth icon  on the taskbar and select **Bluetooth Settings** from the menu. The **Bluetooth Settings** window appears and **Add New Connection Wizard** automatically starts.
- 4 If the **Add New Connection Wizard** window does not appear, click **New Connection**. The **Add New Connection Wizard** window appears.
- 5 Select **Express Mode [Recommended]** and then click **Next**. The wizard searches for Bluetooth devices in range and lists available devices, if any.
- 6 Select **HBH-608** and then click **Next**. The **Bluetooth Manager-Bluetooth Security** window appears when a connection is established.
- 7 Enter "0000" for **Bluetooth Passkey (PIN)** and then click **OK**.
- 8 Press the headset power button.
- 9 Click **Finish**. The headset icon appears in the **Bluetooth Settings** window.
- 10 Click the headset icon and then press the headset power button. The computer should now be ready to communicate with the Bluetooth headset.

To disconnect the headset from your computer

- 1 Right-click the Bluetooth icon  on the taskbar and select **Bluetooth Settings** from the menu. The **Bluetooth Settings** window appears.
- 2 Select **HBH-608**, click **Next**, and select **Disconnect** from the **Bluetooth** menu.
- 3 Click **Yes**.

Using Peripheral Devices

You can add functionality to your computer by using the various ports on the computer.

- ❑ **Connecting a Docking Station** ([page 77](#))
- ❑ **Connecting External Speakers** ([page 86](#))
- ❑ **Connecting an External Display** ([page 87](#))
- ❑ **Selecting Display Modes** ([page 91](#))
- ❑ **Using the Multiple Monitors Function** ([page 92](#))
- ❑ **Connecting an External Microphone** ([page 94](#))
- ❑ **Connecting a Universal Serial Bus (USB) Device** ([page 95](#))
- ❑ **Connecting a Printer** ([page 98](#))
- ❑ **Connecting an i.LINK Device** ([page 99](#))
- ❑ **Connecting to a Network (LAN)** ([page 101](#))

Connecting a Docking Station

Attaching a docking station enables you to connect additional peripherals to your computer, such as a printer and an external display.

A docking station is not supplied with your computer and is available as an optional accessory.

Locating Ports on the Docking Station

Back

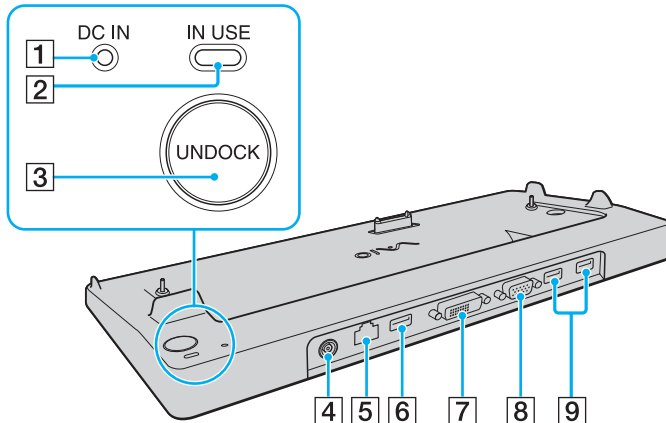

- 1** **DC IN** indicator
Illuminates when the docking station is powered.
 - 2** **IN USE** indicator ([page 82](#))
 - 3** **UNDOCK** button ([page 82](#))
 - 4** **DC IN** port ([page 19](#))
 - 5** Network (Ethernet) port (1000BASE-T / 100BASE-TX / 10BASE-T) ([page 101](#))
 - 6** Hi-Speed USB (USB 2.0) port* ([page 95](#))
 - 7** **DVI-D** port ([page 88](#))
 - 8** **MONITOR** (VGA) port ([page 88](#))
 - 9** Hi-Speed USB (USB 2.0) ports* ([page 95](#))
- * Supports high-/full-/low- speeds.

! The docking station can be powered only through the AC adapter supplied with your computer. Do not unplug the AC adapter from the docking station and the AC outlet while using the docking station; this may cause data damage or hardware malfunctions.

Attaching Your Computer to the Docking Station

! When your computer has no battery pack installed, do not attach the computer to the docking station.

To attach your computer to the docking station

! To prevent loss of unsaved data, be sure to turn off your computer before attaching it to the docking station.

- 1 Disconnect all peripherals from the computer.
- 2 Plug the power cord (1) into the AC adapter (2) and an AC outlet.
- 3 Plug the cable attached to the AC adapter (2) into the **DC IN** port (3) on the docking station (4).

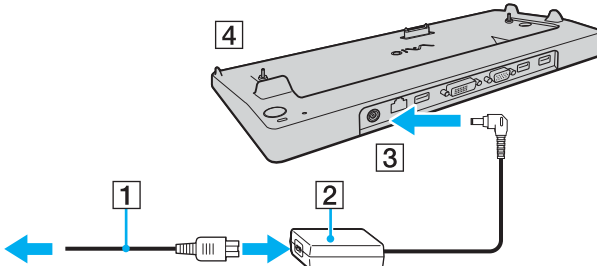

- 4 Slide open the docking station connector cover on the bottom of the computer.

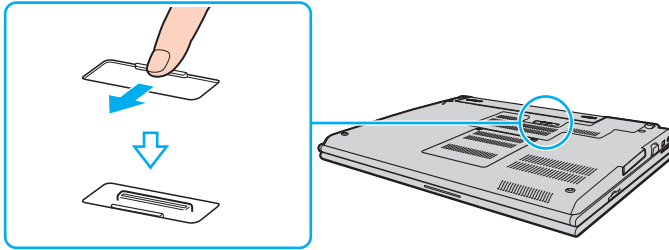

- 5 Align the rear bottom corners and the left side of the computer with the guides on the docking station.

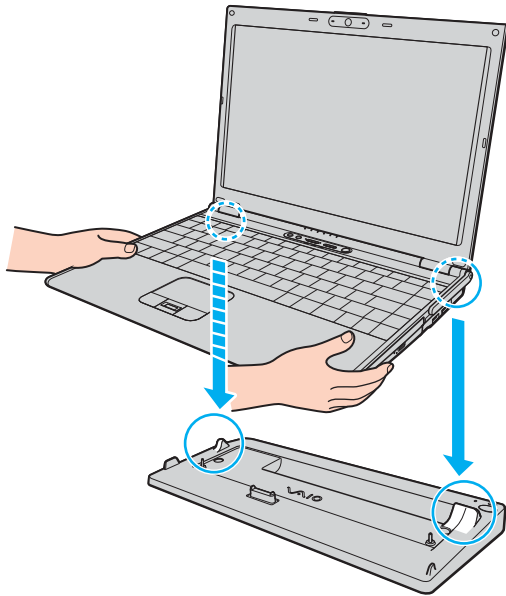

- 6 Gently push down the computer until it clicks into place.

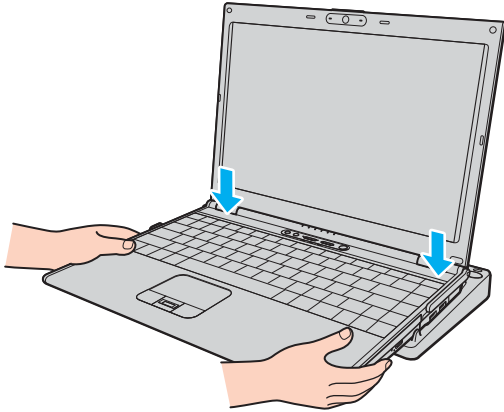

- 7 Turn on the computer.

! Use the AC adapter supplied with your computer.

Do not move your computer while attached to the docking station; this may detach the docking station and cause damage to the docking station and the computer.

Disconnecting Your Computer from the Docking Station



To prevent loss of unsaved data, be sure to turn off your computer before disconnecting it from the docking station.

Be sure that no devices connected to the docking station are in use before disconnecting your computer.

Do not disconnect your computer from the docking station when the **IN USE** indicator is lit. Disconnecting the computer while the **IN USE** indicator is lit may result in loss of unsaved data or a failure of the computer.

When the battery pack is running out of power, disconnecting your computer from the docking station may result in loss of unsaved data.

Do not disconnect your computer from the docking station during video playback. Be sure to close video playback software before disconnection.

Once you have completed the steps in **To disconnect your computer from the docking station (page 83)**, make sure to place your computer off the docking station. Use of the computer still on the docking station may cause unstable operations.

To disconnect your computer from the docking station

- 1 Press the **UNDOCK** button (1) and wait until the **IN USE** indicator (2) turns off.

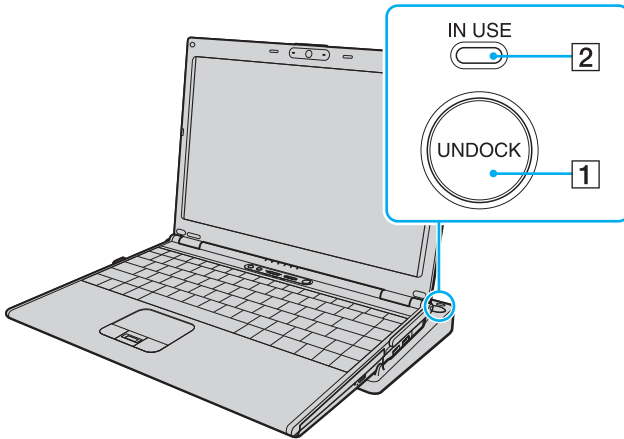

If the **IN USE** indicator is unlit, you do not have to press the **UNDOCK** button.

Pressing the **UNDOCK** button while your computer is in a power saving mode returns the computer to Normal mode first, and then initiates the disconnection process.



Once you have placed your computer back in Normal mode, make sure to place your computer off the docking station. Use of the computer still on the docking station may cause unstable operations.

- 2 Lift the computer away from the docking station.

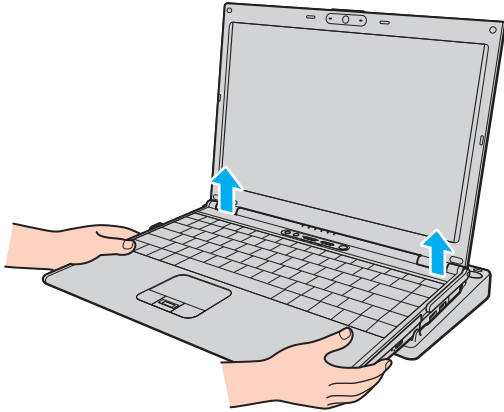

- 3 Close the docking station connector cover on the bottom of the computer.

Alternatively, you can disconnect the computer from the docking station as follows:

- 1 Click **Start** and then **Undock Computer**.
- 2 Make sure that a message balloon appears and the **IN USE** indicator turns off; and then lift the computer away from the docking station.
- 3 Close the docking station connector cover on the bottom of the computer.



It is extremely important to close the docking station connector cover after disconnecting your computer from the docking station. If the cover is left open, dust may get inside and damage the computer.

To disconnect the docking station completely from AC power, unplug the AC adapter.

Connecting External Speakers

You can enhance the sound quality of your computer by connecting external speakers.

To connect external speakers

- 1 Plug the speaker cable (1) into the headphones jack (2) 🎧.
- 2 Plug the other end of the speaker cable to the external speaker (3).
- 3 Turn down the volume of the speakers before you turn them on.

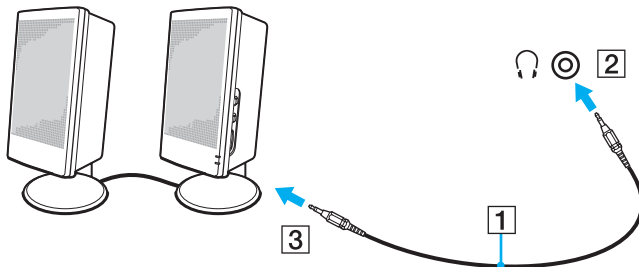

Make sure your speakers are designed for computer use.



Do not place floppy disks on the speakers; their magnetic field may damage the data on the disks.

Connecting an External Display

You can connect an external display to your computer. For example, you can use the computer with a computer display or a projector.



Connect the power cord after connecting all other cables.

Connected external displays are used as secondary screens.

On Windows systems only, you can also use an external display to set up multiple monitors.

Connecting a Computer Display

You can connect a computer display (monitor) either directly to your computer or via the optional docking station.

To connect a computer display

- 1 If necessary, plug one end of the display's power cord (1) into your display, and the other end into an AC outlet.
- 2 If you want to connect a VGA monitor, plug the display cable (2) (not supplied) into the monitor (VGA) port (3) on the computer or on the docking station.
- 3 If you want to connect a TFT/DVI monitor, plug the display cable (not supplied) into the **DVI-D** port on the docking station.

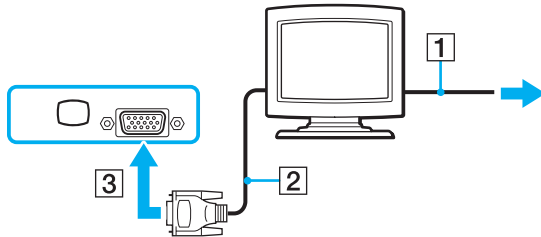

 DVI-D stands for Digital Visual Interface - Digital. It is a type of DVI connector that supports only digital video signals (no analog video signals). It has 24 pins.



A DVI-I connector (Digital Visual Interface - Integrated) supports digital video and analog video signals. It has 29 pins.

! You can use a TFT/DVI monitor only when your computer is in SPEED mode. See **Selecting Performance Modes** (page 104) for mode selection.

Connecting a Multimedia Computer Display

You can connect a multimedia computer display that includes built-in speakers and a microphone directly to your computer or via the optional docking station.

To connect a multimedia computer display

- 1 Plug the power cord of your multimedia computer display (1) into an AC outlet.
- 2 Plug the display cable (2) (not supplied) into the monitor (VGA) port (3)  on the computer or on the docking station.
- 3 Plug the speaker cable (4) into the headphones jack (5)  on the computer.
- 4 Plug the microphone cable (6) into the microphone jack (7)  on the computer.

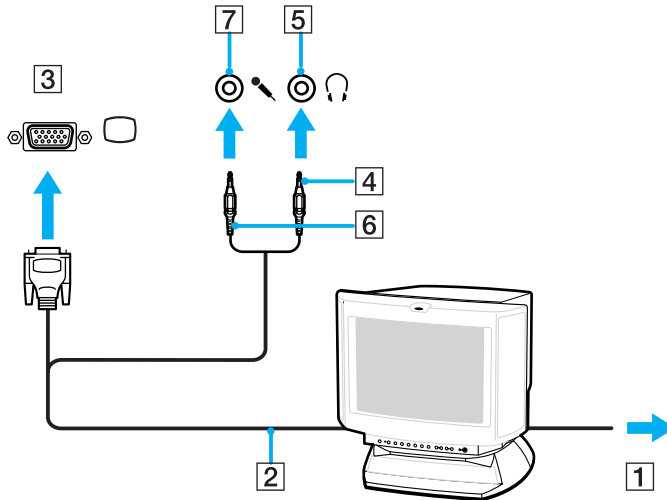

Connecting a Projector

You can connect a projector (for example, the Sony LCD projector) directly to your computer or via the optional docking station.

To connect a projector

- 1 Connect the power cord (1) of your projector into an AC outlet.
- 2 Plug an RGB signal cable (2) (not supplied) into the monitor (VGA) port (3) on the computer or on the docking station.
- 3 Plug an audio cable (4) (not supplied) into the headphones jack (5) on the computer or on the docking station.
- 4 Plug the RGB signal cable and the audio cable into the jack and port on the projector (6).

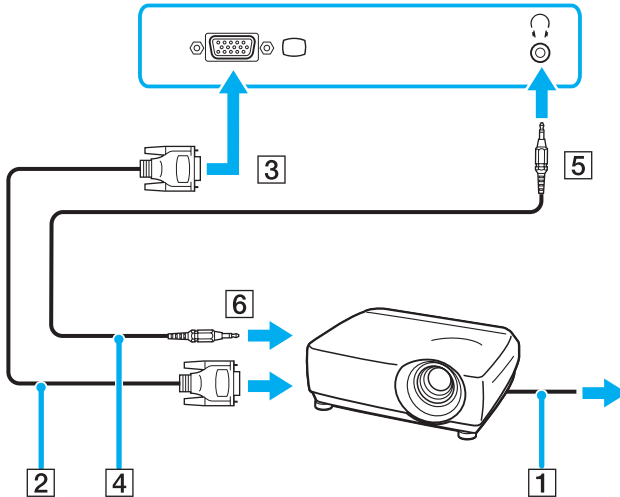

Selecting Display Modes

You can select which display to be used as the primary monitor when an external display (desktop monitor, etc.) is connected to your computer.

If you want to work on your computer screen and the external display at the same time, see **Using the Multiple Monitors Function (page 92)** for more information.

To select a display

When using the Intel Graphics Media Accelerator (STAMINA mode)

- 1 Right-click on the desktop to display the context menu.
- 2 Click the menu item for graphic properties.
- 3 Follow the on-screen instructions to change the settings.



You may not be able to display the same contents on your computer screen and the external display or projector at the same time, depending on the type of your external display or projector.

Before turning on your computer, turn on the peripheral devices.

When using the NVIDIA video controller (SPEED mode)

- 1 Right-click on the desktop and select **NVIDIA Control Panel** from the menu.
- 2 Click the **Display** icon.
- 3 Click **Change Display Configuration**.
- 4 Follow the on-screen instructions to change the settings.



For selecting a video controller, see **Selecting Performance Modes (page 104)**.

Using the Multiple Monitors Function

The Multiple Monitors function allows you to distribute portions of your desktop across separate displays. For example, if you have an external display attached to the monitor (VGA) port, your computer screen and the external display can function as a single desktop.

You can move the cursor from one display to the other. This allows you to drag objects, such as an open application window or a toolbar, from one display to the other.

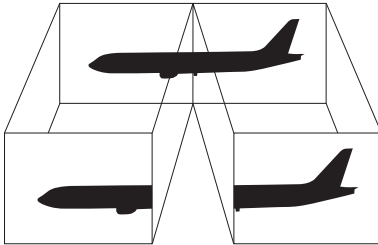

Your external display may not support the Multiple Monitors function.

Certain software applications may not be compatible with Multiple Monitors settings.

Make sure that your computer does not enter Standby or Hibernate mode while you are using Multiple Monitors mode; otherwise the computer may not return to Normal mode.

If you set different colors on each display, do not divide one single window on two displays; otherwise your software may not work properly.

Set fewer colors or a lower resolution for each display.

To select the Multiple Monitors mode

When using the Intel Graphics Media Accelerator (STAMINA mode)

- 1 Right-click on the desktop to display the context menu.
- 2 Click the menu item for graphic properties.
- 3 Follow the on-screen instructions to change the settings.

When using the NVIDIA video controller (SPEED mode)

- 1 Right-click on the desktop and select **NVIDIA Control Panel** from the menu.
- 2 Click the **Display** icon.
- 3 Click **Change Display Configuration**.
- 4 Follow the on-screen instructions to change the settings.



For selecting a video controller, see **Selecting Performance Modes (page 104)**.

You can also change one of the **S** button assignments to activate the Multiple Monitors mode with the corresponding **S** button. To change the **S** button assignments, press and hold any **S** button to display the window for changing the assignment. For details on the **S** buttons, see **Using Special-function Buttons (page 30)**.



Additionally, you can set the display colors and resolution for each display and customize the Multiple Monitors mode.

Connecting an External Microphone

If you need to use a sound input device (for example, to chat over the Internet) you need to plug in an external microphone.

To connect an external microphone

Plug the microphone cable (1) into the microphone jack (2) .

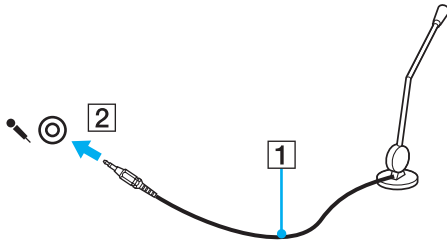

Make sure your microphone is designed for computer use.

Connecting a Universal Serial Bus (USB) Device

To prevent your computer and/or USB devices from damage, observe the following:

- ❑ When moving the computer with USB devices connected, avoid any shock or force to the USB ports.
- ❑ Do not put the computer into a bag or carrying case when it has USB devices connected.

Connecting a USB Mouse

To connect a USB mouse

- 1 Choose the USB port (1)  you prefer to use.
- 2 Plug the USB mouse cable (2) into the USB port.
- You can now use your USB mouse (3).

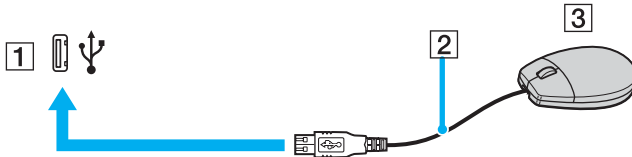

The VAIO USB mouse software driver is preinstalled on your computer. As a result, you only need to plug the USB mouse into the USB port and you can start working.

Connecting a USB Floppy Disk Drive

You can purchase a USB floppy disk drive and connect it to your computer.

To connect a USB floppy disk drive

- 1 Choose the USB port (1)  you prefer to use.
- 2 Plug the USB floppy disk drive cable (2) into the USB port.
Your USB floppy disk drive (3) is now ready for use.

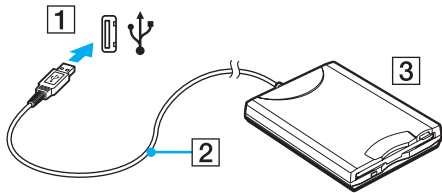

! When using a USB floppy disk drive, do not apply force on the USB port. This may cause a malfunction.

Disconnecting a USB floppy disk drive

You can disconnect a USB floppy disk drive when your computer is on or off. Disconnecting the drive when the computer is in a power saving mode (Standby or Hibernate) may cause the computer to malfunction.

If the computer is off, you can unplug the USB cable directly from the computer.

To disconnect a USB floppy disk drive

- 1 Close all programs accessing the floppy disk drive.
- 2 Double-click the **Safely Remove Hardware** icon on the taskbar.
The **Safely Remove Hardware** window appears.
- 3 Select the floppy disk drive you want to unplug.
- 4 Click **Stop**.
The **Stop a Hardware device** window appears.
- 5 Make sure the floppy disk drive is selected, and click **OK**.
A message appears stating it is now safe to remove the hardware device.
- 6 Click **Close** to close the **Safely Remove Hardware** window.
- 7 Disconnect the floppy disk drive from the computer.

Connecting a Printer

You can connect a Windows-compatible printer to your computer to print documents.

Connecting a Printer Using the USB Port

You can connect a USB printer compatible with your version of Windows to the computer.

To connect a printer using the USB port

- 1 Plug the power cord (1) of your printer into an AC outlet.
- 2 Choose the USB port (3) you prefer to use.
- 3 Plug one end of a USB printer cable (2) (not supplied) into the USB port and the other end to your printer.

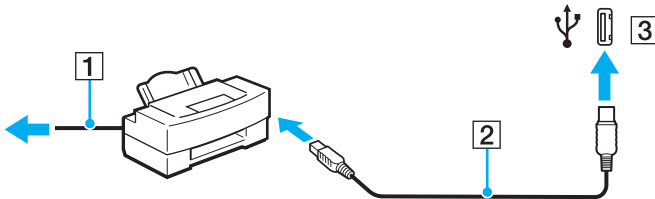

Connecting an i.LINK Device

Notes on connecting i.LINK devices

- ❑ Your computer is equipped with an i.LINK port, which you can use to connect to an i.LINK device such as a digital video camcorder or to connect two VAIO computers in order to copy, delete or edit files.
- ❑ The i.LINK port on your computer does not supply power to external devices generally powered by i.LINK ports.
- ❑ The i.LINK port supports transfer rates up to 400 Mbps; however, the actual transfer rate depends on the transfer rate of the external device.
- ❑ i.LINK cables compatible with your computer include cables with the following part numbers:
VMC-IL4415 (a 1.5 meter cable with a 4-pin connector at each end) and VMC-IL4408 Series (a 0.8 meter cable with a 4-pin connector at each end).
- ❑ The optional i.LINK cables may not be available, depending on the country or area of your residency.
- ❑ An i.LINK connection with other compatible devices is not fully guaranteed.
- ❑ The i.LINK connection varies depending on the software applications, operating system, and i.LINK-compatible devices you use. See the manual that came with your software for more information.
- ❑ Check the working conditions and OS compatibility of i.LINK-compatible PC peripherals (for example, an HDD or a CD-RW drive) before you connect them to your computer.

Connecting a Digital Video Camcorder

To connect a digital video camcorder

- 1 Plug one end of an i.LINK cable (1) (not supplied) into the i.LINK port (2) on the computer and the other end into the DV In/Out ports (3) on the digital video camcorder.
- 2 Launch the **DVgate Plus** software.

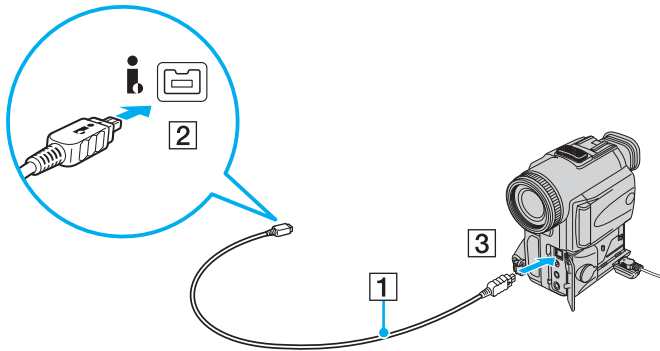

On Sony digital video cameras, ports labeled **DV Out**, **DV In/Out**, or **i.LINK** are i.LINK-compatible.

The Sony digital video camcorder shown here is an example; your digital video camcorder may need to be connected differently.

You cannot access the pictures stored on a Memory Stick media when using an i.LINK connection.

Connecting to a Network (LAN)

You can connect your computer to 1000BASE-T*/100BASE-TX/10BASE-T-type networks with an Ethernet network cable. Connect one end of a network cable (not supplied) to the network (Ethernet) port on the computer or the optional docking station and the other end to your network. For detailed settings and devices needed to connect to the network, ask your network administrator.

* Available only via the network (Ethernet) port on the optional docking station.

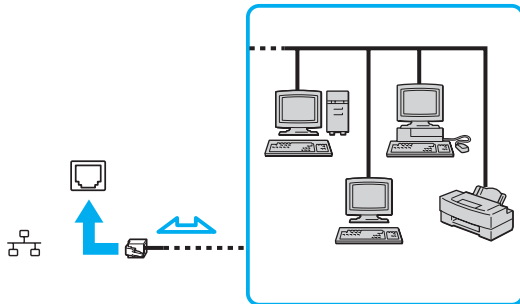

Your computer can be connected to the network with the default settings.

When your computer is attached to the optional docking station, you need to select which network (Ethernet) port to use. Follow the on-screen instructions.

! Telephone lines cannot be connected to the network (LAN) connector on your computer. If the network (LAN) connector is connected to the telephone lines mentioned below, high electric current to the connector may cause damage, overheating, or fire.

- Home (intercom speakerphone) or business-use telephone lines (multi-line business telephone)
- Public telephone subscriber line
- PBX (private branch exchange)

! Do not plug a telephone cable into the network port.

Customizing Your VAIO Computer

This section briefly describes how to change the main settings of your computer. Among other things, you will learn how to use and customize the look of your Sony software and utilities, etc.

- ❑ **Selecting Performance Modes** ([page 104](#))
- ❑ **Setting the Password** ([page 105](#))
- ❑ **Using Fingerprint Authentication** ([page 114](#))
- ❑ **Using Trusted Platform Module (TPM)** ([page 132](#))
- ❑ **Setting Up Your Computer with VAIO Central** ([page 137](#))
- ❑ **Using the Power Saving Modes** ([page 138](#))
- ❑ **Managing Power with VAIO Power Management** ([page 143](#))
- ❑ **Protecting the Hard Disk** ([page 146](#))

Selecting Performance Modes

Your computer is equipped with the performance selector switch (1) to select a performance mode for lower power consumption or faster performance.

! Once you have changed the performance mode with the performance selector switch, you must restart your computer to place it into the selected mode. A window appears to prompt you for computer restart.

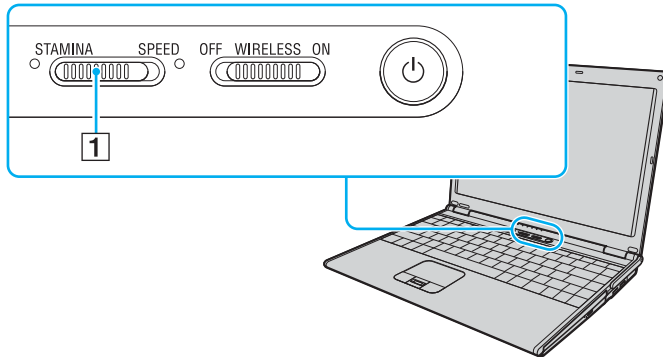

- STAMINA** mode
Uses the Intel Graphics Media Accelerator to conserve battery power.
- SPEED** mode
Uses the NVIDIA video controller to provide faster performance.



You can find the current performance mode by the lit indicator on either side of the performance selector switch.

Setting the Password

In addition to the Windows password, you can use BIOS functions to set two types of passwords to protect your computer: power-on password and hard disk password.

Once you have set the power-on password, you will have to enter the password after the VAIO logo appears to start your computer. The power-on password will allow you to protect your computer from unauthorized access.

The hard disk password provides additional security for the data stored on your hard disk. If you set the hard disk password, no other users will be able to access the data without knowing the password, even if the hard disk is installed in another computer.

Adding the Power-on Password

The power-on password is provided to protect your computer from unauthorized access.

There are two types of the power-on password: machine password and user password. The machine password is provided for users with administrator rights on the computer to change all the setup options on the BIOS setup screen, as well as to start the computer. The user password is provided for other ordinary users to allow for changing some of the BIOS setup options, as well as starting the computer. To set the user password, you must first set the machine password.

! Once you have set the power-on password, you cannot start your computer without entering the password. Make sure not to forget the password. Write down your password and keep it safe and private from other people.

If you forget the power-on password and need assistance to reset it, a password reset fee will be charged, and your computer may need to be sent in for depot service for password reset.



If you have set the power-on password in conjunction with the fingerprint authentication functionality, you can substitute fingerprint recognition for password entry when turning on your computer. For more information, see **Using Fingerprint Authentication (page 114)**.

To add the power-on password

- 1 Turn on the computer.
- 2 Press the **F2** key when the VAIO logo appears.
The BIOS setup screen appears. If not, restart the computer and press the **F2** key several times when the VAIO logo appears.
- 3 Press the **←** or **→** key to select **Security** to display the **Security** tab, select **Set Machine Password**, and then press the **Enter** key.
- 4 On the password entry screen, enter the password twice and press the **Enter** key.
The password can be up to 32 alphanumeric characters (including spaces) long.
- 5 At the confirmation prompt, press the **Enter** key.



The following is to configure your computer to prompt password entry when you turn it on or display the BIOS setup screen.

- 6 Select **Password when Power ON** under **Security**.
Press the space bar to change the setting from **Disabled** to **Enabled**.
- 7 Press the **←** or **→** key to select **Exit**, select **Exit (Save Changes)** or **Exit Setup**, and then press the **Enter** key.
On the **Setup Confirmation** screen, make sure that **Yes** is selected and then press the **Enter** key.

Changing/Removing the Power-on Password

To change or remove the power-on password

- 1 Turn on the computer.
- 2 Press the **F2** key when the VAIO logo appears.
The BIOS setup screen appears. If not, restart the computer and press the **F2** key several times when the VAIO logo appears.
- 3 Enter the current password for **Enter Password** and press the **Enter** key.
- 4 Press the **←** or **→** key to select **Security** to display the **Security** tab, select **Set Machine Password**, and then press the **Enter** key.
- 5 On the password entry screen, enter the current password once and a new password twice, and then press the **Enter** key.
To remove the password, leave the **Enter New Password** and **Confirm New Password** fields blank and press the **Enter** key.
When confirmation to save the changes is prompted, press the **Enter** key.
- 6 Press the **←** or **→** key to select **Exit**, select **Exit (Save Changes)** or **Exit Setup**, and then press the **Enter** key.
On the **Setup Confirmation** screen, confirm that **Yes** is selected and then press the **Enter** key.

Adding the Hard Disk Password

The hard disk password provides additional security for the data stored on your hard disk. If you enable the hard disk password, this adds an extra level of security.

When adding the hard disk password, you must set both the master and user passwords. The master password is provided for users with administrator rights on the computer to reset the user password on the BIOS setup screen. The user password is provided to lock your hard disk. Once you set the user password, you will have to enter the password along with the power-on password (if set), after the VAIO logo appears.



You cannot start your computer with the master password.

If you forget the master password or the keyboard fails, which is critical to password entry, no bypass is possible and the data stored in the hard disk will not be accessible. There is NO RESET of this password. You will have to replace the hard disk at your own expense and lose all the data stored in the original hard disk. Make sure to write down the master password and keep it safe and private from other people.



If you have set the hard disk password in conjunction with the fingerprint authentication functionality, you can substitute fingerprint recognition for password entry when turning on your computer. For more information, see **Using Fingerprint Authentication** (page 114).

To add the hard disk password

- 1 Turn on the computer.
 - 2 Press the **F2** key when the VAIO logo appears.
The BIOS setup screen appears. If not, restart the computer and press the **F2** key several times when the VAIO logo appears.
-  If you have set the power-on password, enter your power-on password.
- 3 Press the **←** or **→** key to select **Security** to display the **Security** tab, select **Hard Disk Password**, and then press the **Enter** key.
The password entry screen appears.
 - 4 Select **Enter Master and User Passwords** and press the **Enter** key.
 - 5 Select **Continue** on the warning screen and press the **Enter** key.
 - 6 Enter the master password twice and press the **Enter** key.
The password should be up to 32 alphanumeric characters (including spaces) long.
 - 7 Enter the user password twice and press the **Enter** key.
The password should be up to 32 alphanumeric characters (including spaces) long.
 - 8 Press the **Enter** key when the **Setup Notice** message appears.
 - 9 Press the **Esc** key.
 - 10 Press the **←** or **→** key to select **Exit**, select **Exit Setup**, and then press the **Enter** key.
On the **Setup Confirmation** screen, make sure that **Yes** is selected and then press the **Enter** key.

Changing the Hard Disk Password

To change the hard disk password

- 1 Turn on the computer.
- 2 Press the **F2** key when the VAIO logo appears.
The BIOS setup screen appears. If not, restart the computer and press the **F2** key several times when the VAIO logo appears.



If you have set the power-on password, enter your power-on password.

- 3 Press the **←** or **→** key to select **Security** to display the **Security** tab, select **Hard Disk Password**, and then press the **Enter** key.
The password entry screen appears.
- 4 Select **Change Master Password** or **Change User Password** and press the **Enter** key.
- 5 Enter the current password once and then a new password twice.
- 6 Press the **Enter** key.
- 7 Press the **Enter** key when the success message appears.
- 8 Press the **Esc** key.
- 9 Press the **←** or **→** key to select **Exit**, select **Exit Setup**, and then press the **Enter** key.
On the **Setup Confirmation** screen, make sure that **Yes** is selected and then press the **Enter** key.

Removing the Hard Disk Password

To remove the hard disk password

- 1 Turn on the computer.
- 2 Press the **F2** key when the VAIO logo appears.
The BIOS setup screen appears. If not, restart the computer and press the **F2** key several times when the VAIO logo appears.



If you have set the power-on password, enter your power-on password.

- 3 Press the **←** or **→** key to select **Security** to display the **Security** tab, select **Hard Disk Password**, and then press the **Enter** key.
The password entry screen appears.
- 4 Select **Enter Master and User Password** and press the **Enter** key.
- 5 Enter the current password for **Enter Current Hard Disk Master Password** and press the **Enter** key, leaving everything else blank.
- 6 Press the **Enter** key when the success message appears.
- 7 Press the **Esc** key.
- 8 Press the **←** or **→** key to select **Exit**, select **Exit Setup**, and then press the **Enter** key.
On the **Setup Confirmation** screen, make sure that **Yes** is selected and then press the **Enter** key.

Adding the Windows Password

The Windows password comes in handy when you have to share a single computer with other people. By setting the Windows password, you can protect your user account from unauthorized access.

Entry of the Windows password will be prompted after you select your user account.

! Make sure not to forget the password. Write down your password and keep it safe and private from other people.

 If you have set the Windows password in conjunction with the fingerprint authentication functionality, you can substitute fingerprint recognition for password entry when turning on your computer. For more information, see **Using Fingerprint Authentication (page 114)**.

To add the Windows password

- 1 Click **Start** and then **Control Panel**.
- 2 Click the **User Accounts** icon.
- 3 Click your user account under **or pick an account to change**.
- 4 Click **Create a password**.
- 5 In the **Type a new password** and **Type the new password again to confirm** fields, enter the password for your account.
- 6 Click **Create Password**.

 See **Help and Support Center** for more information on the Windows password.

Changing/Removing the Windows Password

To change the Windows password

- 1 Click **Start** and then **Control Panel**.
- 2 Click the **User Accounts** icon.
- 3 Click your user account under **or pick an account to change**.
- 4 Click **Change my password**.
- 5 Enter the current password under **Type your current password**.
- 6 Enter a new password under **Type a new password** and the same password under **Type the new password again to confirm**.
- 7 Click **Change Password**.

To remove the password

- 1 Click **Start** and then **Control Panel**.
- 2 Click the **User Accounts** icon.
- 3 Click your user account under **or pick an account to change**.
- 4 Click **Remove my password**.
- 5 Enter the current password that you want to remove.
- 6 Click **Remove Password**.

Using Fingerprint Authentication

Your computer may be equipped with a fingerprint sensor to provide you with additional convenience. A small horizontal bar located between the left and right touch-pad buttons is the sensor of the fingerprint reader and will be referred to as the fingerprint sensor hereinafter.

See the online **Specifications** to see whether your model is equipped with the fingerprint sensor.

Once you have registered your fingerprint(s), the fingerprint authentication functionality offers:

- A substitute for password entry
You can log onto your password-protected system without entering the power-on, hard disk, and Windows passwords. If you share a computer with other people, you can skip user selection as well.
- Quick web-site access
Once you have registered your user information (user accounts, passwords, etc.) for web sites in the password bank, you can substitute fingerprint authentication for entering required information and access the password-protected web sites.
- Access to the encrypted (locked) **My Safe** folder
The **My Safe** folder is provided to protect your data against unauthorized access. With the fingerprint authentication functionality, you can decrypt (unlock) this folder to access your data.
- Quick application access
Once you have assigned an application to your finger, you can then swipe the finger across the fingerprint sensor to launch the assigned application.

Precautions on Using Fingerprint Authentication

- ❑ The fingerprint authentication technology does not assure 100% verification. Sony assumes no liabilities for any problems and damages arising out of your use of or inability to use the fingerprint sensor.
- ❑ The fingerprint authentication technology does not assure complete protection of your data and hardware. Sony assumes no liabilities for any problems and damages arising out of your use of or inability to use the fingerprint sensor.
- ❑ The fingerprint recognition rate depends on your operating conditions and varies among individuals as well.
- ❑ Make sure to make a backup copy of the data stored on the hard disk, especially in the **My Safe** folder, before sending your computer for repair. Sony assumes no liabilities for any loss or modification of your data that might have occurred during the course of repair.
- ❑ The hard disk may be initialized and returned after the repair work and, in such a case, you will not be able to restore your fingerprint templates.
- ❑ The maintenance and management of data concerning fingerprint authentication must be carried out at your own risk. Sony assumes no liabilities for any defects arising out of your data maintenance and management.
- ❑ When enrolling your fingerprint(s), keep the following in mind:
 - ❑ Enroll more than one fingerprint in case of inability to recognize the fingerprint due to injury.
 - ❑ You may not be able to enroll your fingerprint(s) due to some biological factors.
 - ❑ Up to 10 fingerprints can be enrolled per person.
Note that up to 21 fingerprints can be enrolled on a first-come, first-served basis for logging on to your system using the Boot Security functionality. If you share your computer with other people, you may not be able to use your enrolled fingerprint to log on to your system.

- When swiping your finger across the fingerprint sensor, keep the following in mind:
 - Place your fingertip flat in the center of the fingerprint sensor.
 - Scan your fingerprint from the top joint of the finger to the fingertip.
 - Swipe your finger perpendicularly across the fingerprint sensor.
 - Keep your finger in contact with the fingerprint sensor while swiping.
 - Let the fingerprint sensor take about one second to scan your fingerprint.
- It may be hard to enroll or recognize your fingerprint if your finger is:
 - dry or wet
 - wrinkled
 - injured
 - dirty
- The soiled fingerprint sensor may cause poor recognition performance.
 - Wipe off the fingerprint sensor regularly with a soft cloth.
 - Use a lens cleaning cloth when the fingerprint sensor is extremely soiled.
 - Blow off dust with an air blower or a soft brush.

Enrolling a Fingerprint

To use the fingerprint authentication functionality, you must enroll your fingerprint(s) in your computer.



Set the Windows password on your computer before enrollment. See **Adding the Windows Password (page 112)** for the detailed instructions.

To enroll a fingerprint



Up to 21 fingerprints can be enrolled on a first-come, first-served basis for logging on to your system using the Boot Security functionality. If you share your computer with other people, you may not be able to use your enrolled fingerprint to log on to your system.

- 1 Click **Start**, point to **All Programs** and **Protector Suite QL**, and then click **Welcome**. The **Welcome** window appears.
- 2 Click **Enroll now**.



If the Windows password is not set on your computer, password registration will be prompted.

- 1 Click **OK** on the prompt window.
- 2 Click **Yes** for confirmation.
- 3 Enter your password twice and click **OK**.
- 3 Click **Next**.
- 4 Enter the Windows password and click **Next**.
- 5 Select the **Run interactive tutorial** check box and click **Next**.
- 6 Read the tutorial information and click **Next**.

- Swipe your finger across the fingerprint sensor four times to perform a swipe test, and then click **Next**. The **Enrollment** window appears.

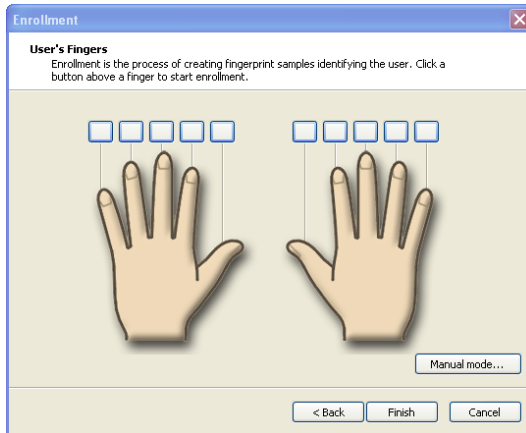

See **To scan a fingerprint (page 119)** for the scan procedure.

- Click on the finger of which fingerprint you want to enroll.
- Swipe the finger across the fingerprint sensor three times.
- Click **Finish**.



To enroll more fingerprints, repeat steps 7 and 8 above.

If enrollment scan fails in step 8 above, click **Manual mode** and follow the on-screen instructions to try manual mode enrollment.

To edit or add fingerprint templates, right-click the **Protector Suite QL** icon on the taskbar.

To scan a fingerprint

- 1 Place the top joint of your finger on the fingerprint sensor (1).

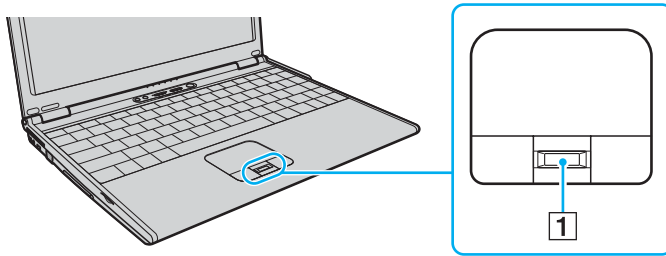

Place your fingertip flat in the center of the fingerprint sensor.

- 2 Swipe your finger perpendicularly across the fingerprint sensor.

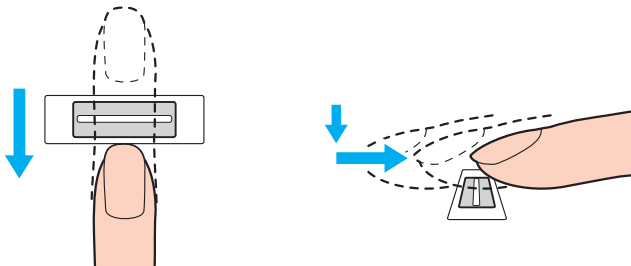

Keep your finger in contact with the fingerprint sensor while swiping.

Fingerprint enrollment may fail if you move your finger too fast or too slow. Take about one second to swipe your finger across the sensor.

Logging Onto Your System

To use the fingerprint authentication functionality in place of password entry to log onto your system, you need to set the power-on, hard disk, and Windows passwords and configure your computer for fingerprint authentication.

For setting the power-on, hard disk, and Windows passwords, see **Setting the Password (page 105)**.

To log onto Windows

If your fingerprints are enrolled for your user account, you will be able to substitute fingerprint recognition for password entry when logging on to Windows.

- 1 Swipe the finger with the enrolled fingerprint across the fingerprint sensor when the Windows log-on window appears. Window is launched.



You can log onto to your user account just by swiping the finger with the enrolled fingerprint even if your computer is shared by multiple users.

To configure the computer for fingerprint authentication

- 1 Swipe the finger with the enrolled fingerprint across the fingerprint sensor to display the **Protector Suite QL** menu.
- 2 Select **Settings**.
The **Protector Suite QL** window appears.
- 3 Click the **Boot Security** tab.



The **Boot Security** tab is not displayed if you have not set the power-on and hard disk passwords in advance.

- 4 Select the **Enable boot security** check box and the **Automatic logon after boot verification** check box, and then click **OK**.



With the **Automatic logon after boot verification** check box selected, you can start your system and launch Windows by swiping your finger only once.

If only the **Enable boot security** check box has been selected, you will be prompted to swipe your finger or enter the password before Windows is launched.

To log onto the system using the Boot Security functionality

- 1 Turn on the computer.
The authentication window appears following the VAIO logo.
- 2 Swipe the finger with the enrolled fingerprint across the fingerprint sensor.
Windows is launched.



Alternatively, you can press the **Esc** key and enter your password.

If only the **Enable boot security** check box has been selected in step 4 in **To configure the computer for fingerprint authentication (page 120)**, you will be prompted to swipe your finger or enter the password before Windows is launched.



Up to 21 fingerprints can be enrolled on a first-come, first-served basis for logging on to your system using the Boot Security functionality. If you share your computer with other people, you may not be able to use your enrolled fingerprint to log on to your system.

Using the Password Bank

Once you have registered your user information (user accounts, passwords, etc.) for web sites in the password bank, you can substitute fingerprint authentication for entering required information and access the password-protected web sites.

Adding an Entry to the Password Bank

To access a password-protected web site using the fingerprint authentication functionality, you need to add a password bank entry for the web site.

To add an entry to the password bank

- 1 Visit the desired password-protected web site to display the user account and password entry window.
- 2 Enter your user information (user account, password, etc.).
- 3 Swipe the finger with the enrolled fingerprint across the fingerprint sensor to display the **Protector Suite QL** menu.
- 4 Select **Register Window**.
- 5 Click **Continue** on the displayed window.

Upon completion, a message balloon appears at the title bar.

To view or edit the entry, click **Registration Details** on the message balloon.



Never add TPM passwords (see **Using Trusted Platform Module (TPM)** ([page 132](#))) to the password bank.

Using a Password Bank Entry to Access a Web Site

Once you have added an entry to the password bank, you can use it to access the corresponding password-protected web site.

To access a password-protected web site

- 1 Visit the desired password-protected web site to display the user account and password entry window. A message balloon appears to indicate that you have a password bank entry for the site.
- 2 Swipe the finger with the enrolled fingerprint across the fingerprint sensor.
- 3 Click **Yes** on the confirmation window.
If a security warning window appears, click **Yes** or **OK** to proceed.



You can always enter your user information that has been registered in the password bank to access password-protected web sites.

Importing/Exporting Password Bank Entries

You can export/import entries to/from the password bank for a backup or recovery purpose.

To export an entry

- 1 Swipe the finger with the enrolled fingerprint across the fingerprint sensor to display the **Protector Suite QL** menu.
- 2 Select **Settings**.
The **Protector Suite QL** window appears.
- 3 Click the **Registrations** tab.
- 4 Select the desired entry name from the list and click **Export**.
- 5 Enter a file name and click **Save**.
- 6 Enter a password twice and click **OK**.
- 7 Click **OK**.

To import an entry

- 1 Swipe the finger with the enrolled fingerprint across the fingerprint sensor to display the **Protector Suite QL** menu.
- 2 Select **Settings**.
The **Protector Suite QL** window appears.
- 3 Click the **Registrations** tab.
- 4 Click **Import**.
- 5 Select an exported file and click **Open**.
- 6 Enter the password that you used for export and click **OK**.
- 7 Click **OK**.

Using the My Safe Folder

The encrypted **My Safe** folder is provided to protect your data against unauthorized access. With the fingerprint authentication functionality, you can decrypt (unlock) this folder to access your data.

Note that you need to initialize and create the folder before you use the **My Safe** folder for the first time.

To show the My Safe icon on the desktop

- 1 Swipe the finger with the enrolled fingerprint across the fingerprint sensor to display the **Protector Suite QL** menu.
- 2 Select **Settings**.
The **Protector Suite QL** window appears.
- 3 Click the **My Safe** tab.
- 4 Click to select the **Show My Safe icon on Desktop** check box, and then click **OK**.

To initialize the My Safe folder

- 1 Double-click the **My Safe** icon on the desktop.
- 2 Swipe the finger with the enrolled fingerprint across the fingerprint sensor.
- 3 Click **Next**.
- 4 Enter a backup password twice and click **Next**.
The password should be at least 8 alphanumeric characters long.



You will need the backup password if the fingerprint sensor fails. Without the backup password, you will not be able to restore your data in the **My Safe** folder. Make sure to write down the backup password and keep it safe and private from other people.

- 5 Specify the folder size and click **Finish**.
The **My Safe** folder opens.



The maximum size of the **My Safe** folder is 2 GB.

To lock the My Safe folder

Right-click the **My Safe** icon on the desktop and select **Lock My Safe** from the **Protector Suite QL** menu.

The **My Safe** folder is locked against unauthorized access.

To unlock the My Safe folder

- 1 Right-click the **My Safe** icon on the desktop and select **Unlock My Safe** from the **Protector Suite QL** menu.
- 2 Swipe the finger with the enrolled fingerprint across the fingerprint sensor.
The **My Safe** folder will stay unlocked until you lock it again or restart the computer.

To resize the My Safe folder



The maximum size of the **My Safe** folder is 2 GB.

- 1** Swipe the finger with the enrolled fingerprint across the fingerprint sensor to display the **Protector Suite QL** menu.
- 2** Select **Settings**.
The **Protector Suite QL** window appears.
- 3** Click the **My Safe** tab.
- 4** Click **Change Size**.
The window for changing the folder size appears.



If the **My Safe** folder is unlocked when you click **Change Size** in step 4, the window for locking the folder will appear. Click **OK** to lock the **My Safe** folder and close the window.

- 5** Change the folder size and click **OK**.
- 6** Click **OK** on the **Protect Suite QL** window.

Using the Application Launcher

The application launcher feature is available on your computer for launching your preferred application (executable file) that is assigned to one of your fingers with the enrolled fingerprint. Once you have assigned an application to your finger, you can then swipe the finger across the fingerprint sensor to launch the assigned application and eliminate tiresome menu selections.

Assigning an Application to Your Finger

To use the application launcher feature, you must assign an application to your individual fingers in advance.

To assign an application to your finger

- 1 Swipe the finger with the enrolled fingerprint across the fingerprint sensor to display the **Protector Suite QL** menu.
- 2 Select **Settings**.
The **Protector Suite QL** window appears.
- 3 Click the **Applications** tab.
- 4 Click **Add**.
The **Applications** window appears.



To add an assignment, you need at least two enrolled fingers left unassigned.

To display the **Protector Suite QL** menu in Step 1 above, you need at least one enrolled finger kept unassigned.

- 5 Select one of your enrolled fingers and assign an application, and then click **OK**.
The **Protector Suite QL** window appears.
- 6 Click **OK**.

Launching an Application with Your Finger

Swipe your finger with your desired application assignment across the fingerprint sensor to launch the corresponding application.

! Swiping the finger with no application assignment across the fingerprint sensor will display the **Protector Suite QL** menu.

Changing an Application Assignment to Your Finger

To change an application assignment to your finger

- 1 Swipe the finger with the enrolled fingerprint across the fingerprint sensor to display the **Protector Suite QL** menu.
- 2 Select **Settings**.
The **Protector Suite QL** window appears.
- 3 Click the **Applications** tab.
- 4 Select the desired finger and click **Edit**.
The **Applications** window appears.
- 5 Change its assignment and click **OK**.
The **Protector Suite QL** window appears.
- 6 Click **OK**.

Removing an Application Assignment to Your Finger

To remove an application assignment to your finger

- 1 Swipe the finger with the enrolled fingerprint across the fingerprint sensor to display the **Protector Suite QL** menu.
- 2 Select **Settings**.
The **Protector Suite QL** window appears.
- 3 Click the **Applications** tab.
- 4 Select the desired finger and click **Delete**.

Erasing the Enrolled Fingerprints

Before disposing of your computer or transferring it to a third person, it is strongly recommended you erase the fingerprints data enrolled on the fingerprint sensor after erasing the data stored on your hard disk.

To erase the enrolled fingerprints

- 1 Turn on the computer.
- 2 Press the **F2** key when the VAIO logo appears.
The BIOS setup screen appears. If not, restart the computer and press the **F2** key several times when the VAIO logo appears.
- 3 Press the **←** or **→** key to select **Security** to display the **Security** tab.
- 4 Press the **↓** key to select **Clear Fingerprint Data** and press the **Enter** key.
The fingerprint data enrolled on the fingerprint sensor is erased automatically after your system restarts.

Using Trusted Platform Module (TPM)

The embedded Trusted Platform Module (TPM) provides your computer with basic security functions. In combination with the TPM, you can encrypt and decrypt your data to strengthen computer security against inappropriate access.

TPMs are defined by Trusted Computing Group (TCG) and also called security chips.

See the online **Specifications** to see whether your model is equipped with the TPM.

Precautions on Using the TPM

- ❑ Although your computer is provided with the latest TPM security functions, these functions do not assure complete protection of your data and hardware. Sony Corporation assumes no liabilities for any problems and damages arising out of your use of the functions.
- ❑ After you have installed the Infineon TPM Professional Package, you need to set a few TPM passwords on your computer. Without these passwords, you will not be able to restore any TPM-protected data. Make sure to write down the passwords and keep them safe and private from other people.
- ❑ Make sure to make backup copies of the latest emergency recovery archive file and the latest emergency recovery token file and keep them safe and private from other people before sending your computer for repair. The data stored in the TPM that are embedded on the motherboard may be lost or corrupted during the course of repair.
- ❑ During the course of repair, the TPM may be replaced even if there are no problems with the modules. In such a case, use the backup copies of the emergency recovery archive file and the emergency recovery token file to restore the TPM configuration.
- ❑ Make sure to make a backup copy of the data stored on the hard disk before sending your computer for repair. The hard disk may be initialized and returned after the repair work and, in such a case, you will not be able to restore the data on the hard disk using the backup copies of the emergency recovery archive file and the emergency recovery token file.
- ❑ The maintenance and management of TPM-protected data must be carried out at your own risk. Sony Corporation assumes no liabilities for any defects arising out of your data maintenance and management.

Important Notice

- ❑ Do not encrypt the **Documents and Settings** folder.
Encrypting the files in the folders containing basic user keys and others, which are listed later in this section, using the Encrypting File System (EFS) will disable you to launch your TPM software successfully and decrypt the encrypted data if:
 - ❑ The TPM software has been installed.
 - ❑ The platform has been initialized.
 - ❑ The EFS functionality has been enabled in user initialization process.

With the default settings, the files in the folders below are prevented from encrypting by having system attributes. Do not change the system attributes of the files in the folders below.

- ❑ Folders containing basic user keys and others
 - C:\Documents and Settings\All Users\Application Data\Infineon\TPM Software 2.0\BackupData
 - C:\Documents and Settings\All Users\Application Data\Infineon\TPM Software 2.0\PlatformKeyData
 - C:\Documents and Settings\All Users\Application Data\Infineon\TPM Software 2.0\RestoreData
 - C:\Documents and Settings\<account>\Application Data\Infineon\TPM Software 2.0\UserKeyData(All folders are invisible by default.)

In addition, encrypting the following folder will disable you to log onto your system.
C:\Documents and Settings\<account>\Local Settings (invisible by default)

- ❑ Encrypting the archive, backup, and token files will disable emergency restoration.
Encrypting the password reset token and secret files will disable password reset.

- Do not encrypt the following folders and files. There will be no way to restore the following folders and files or the archive, backup, token, password reset token and secret files of your TPM software if you carelessly encrypt them. Sony Corporation assumes no liability for any troubles and damages arising out of your careless encryption of such folders and files.
 - Automatic backup file
 - Default file name: SPSystemBackup.xml
 - Default path: None (Clicking **Browse** displays the **My Documents\Security Platform** window.)
 - Storage folder for automatic backup data
 - Default file name: SPSystemBackup
 - The folder is created as the subfolder for the SPSystemBackup.xml file.
 - Token file for decryption
 - Default file name: SPEmRecToken.xml
 - Default path: Removable media (FD, USB memory, etc.)
 - Password reset token file
 - Default file name: SPPwdResetToken.xml
 - Default path: Removable media (FD, USB memory, etc.)
 - Password reset secret file
 - Default file name: SPPwdResetSecret.xml
 - Default path: Removable media (FD, USB memory, etc.)
 - Key and certificate backup file
 - Default file name: SpBackupArchive.xml
 - Default path: None (Clicking **Browse** displays the **My Documents\Security Platform** window.)
 - PSD backup file
 - Default file name: SpPSDBackup.fsb
 - Default path: None (Clicking **Browse** displays the **My Documents\Security Platform** window.)

Configuring the TPM

To use the embedded TPM, you need to:

- 1 Enable the TPM on the BIOS setup screen.
- 2 Install the Infineon TPM Professional Package.
- 3 Initialize and configure the TPM.

Enabling the TPM on the BIOS setup screen

To enable the TPM

- 1 Turn on your computer.
- 2 Press the **F2** key when the VAIO logo appears.
The BIOS setup screen appears. If not, restart the computer and press the **F2** key several times when the VAIO logo appears.
- 3 Press the **←** or **→** key to select **Security** and then select **Enabled** for **Trusted Platform Support** on the **Security** tab.
- 4 Press the **←** or **→** key to select **Exit** and then **Exit Setup**; and press the **Enter** key.

!
Before enabling the TPM, make sure to set the power-on and hard disk passwords to protect against unauthorized modification of the TPM configuration.

If the TPM is enabled, it will take longer before the VAIO logo appears due to security checks at computer startup.



You can also disable the TPM and clear the TPM configuration on the BIOS setup screen. Note that you will not be able to access any TPM-protected data if you clear the TPM ownership. Before clearing the TPM configuration, make sure to make backup copies of the TPM-protected data.

Installing the Infineon TPM Professional Package

Read the Readme.txt in the **C:\infineon\Readme** folder. Then, double-click **C:\Infineon\setup.exe** to install the package. To install this package, you must have administrator rights on the computer.

Initializing and configuring the TPM

See the online documentation for detailed information. To open the documentation, click **Start**, point to **All Programs** and **Infineon Security Platform Solution**, and click **Help on Security Platform**.

! The maintenance and management of TPM-protected data must be carried out at your own risk. Sony Corporation assumes no liabilities for any defects arising out of your data maintenance and management.

Setting Up Your Computer with VAIO Central

The **VAIO Central** utility allows you to consult system information and specify preferences for system behavior.

To use VAIO Central

- 1 Click **Start**, point to **All Programs**, and click **VAIO Central**.
The **VAIO Central** window appears.
- 2 Select the desired control item and change the settings.
- 3 Once finished, click **OK**.
The setting of the desired item has been changed.



Some of the control items will not be visible if you open **VAIO Central** as a limited user.

Using the Power Saving Modes

When you use a battery pack as the power source for your computer, you can take advantage of power management settings to conserve battery life. In addition to the normal operating mode, which allows you to turn off specific devices, your computer has two distinct power saving modes: Standby and Hibernate. When using battery power, you should be aware that the computer will automatically enter Hibernate mode if the remaining battery charge becomes short, regardless of the power management setting you select.

To set the timer for the computer to automatically enter Standby or Hibernate mode after a certain period of time, click **Start** and **Control Panel**. Click **Performance and Maintenance** and **Power Options**, and then change the settings under **Power Schemes**.

! If the battery level falls below 10 percent, you should either attach the AC adapter to recharge the battery pack or shut down your computer and install a fully charged battery pack.

Using Normal Mode

This is the normal state of the computer when it is in use. The green power indicator light is on in this mode. To save power while not working, you can turn off a specific device such as the LCD screen or the hard disk.

Using Standby Mode

Standby mode turns off the LCD screen and places the hard disk and the CPU into a low power consumption mode. The amber power light flashes in this mode.

To activate Standby mode

- 1 Click **Start** and then **Turn Off Computer**.
- 2 Click **Stand By**.

To return to Normal mode

Press any key.

! If you press and hold the power button for more than four seconds, your computer will turn off automatically. You will lose any unsaved data.



When your computer is in Standby mode, you cannot insert a disc.

Your computer comes out of Standby mode quicker than out of Hibernate mode.

Standby mode uses more power than Hibernate mode.

You can use **VAIO Central** to configure your computer to return to Normal mode when you open the LCD screen lid. This power resuming preference will be lost if you remove both the AC adapter and the battery pack. See **Setting Up Your Computer with VAIO Central** ([page 137](#)).

! If the battery runs down while your computer is in Standby mode, you will lose any unsaved data. Going back to the previous work state is impossible. To avoid loss of data, you should save your data frequently.

If the computer is not used for 25 minutes, it will enter Standby mode. To avoid this, you can change the Standby mode settings.

To change the Standby mode settings

- 1 Click **Start** and then **Control Panel**.
- 2 Click **Performance and Maintenance**.
- 3 Click **Power Options**.
The **Power Options Properties** window appears.
- 4 Select the **Power Schemes** tab.
- 5 Change the **System Standby** settings.

Using Hibernate Mode

In Hibernate mode, the state of the system is saved on the hard disk and power is turned off. Even when the battery runs down, no data will be lost. The power indicator light is off in this mode.

To activate Hibernate mode

Press the **Fn+F12** keys.

The **Hibernating** screen appears and the computer enters Hibernate mode.

Alternatively,

- 1 Click **Start** and then **Turn Off Computer**.
- 2 Click **Hibernate**.

To return to Normal mode

Press the power button.

The computer returns to its previous state.

! If you press and hold the power button for more than four seconds, your computer will turn off automatically.



If you do not use your computer for a long period of time, place the computer into Hibernate mode. This power saving mode saves you the time of shutting down or resuming.

When your computer is in Hibernate mode, you cannot insert a disc.

Hibernate mode requires more time than Standby mode to be activated.

It takes more time to return to Normal mode from Hibernate mode than from Standby mode.

Hibernate mode uses less power than Standby mode.

You can use **VAIO Central** to configure your computer to return to Normal mode when you open the LCD screen lid. This power resuming preference will be lost if you remove both the AC adapter and the battery pack. See **Setting Up Your Computer with VAIO Central** ([page 137](#)).



Do not move your computer before its power indicator light turns off.

Managing Power with VAIO Power Management

Power management helps you set up power schemes for running on AC power or batteries to suit your requirements for power consumption.

VAIO Power Management is a software application developed exclusively for VAIO computers. With this software application, you can enhance the Windows power management functions to ensure better operations of your computer and longer battery life. For more information on **VAIO Power Management**, see the help file on the **VAIO Power Management** software.

Activating VAIO Power Management

When you start the computer, a power status icon appears on the taskbar. This icon indicates what kind of power source you are using at that time, for example, AC power. Double-click this icon to display the window, showing your power status.

VAIO Power Management functionalities are added to the Windows **Power Options Properties**.

To activate VAIO Power Management

- 1 Click **Start** and then **Control Panel**.
- 2 Click **Performance and Maintenance**.
- 3 Click **Power Options**.
The **Power Options Properties** window appears.
- 4 Select the **VAIO Power Management** tab.

To restore the default settings

- 1 On the **VAIO Power Management** tab, click **Advanced**.
The **VAIO Power Management** window appears.
- 2 Follow the on-screen instructions to change the settings.

Activating VAIO Power Management Power Schemes

VAIO Power Management provides several predefined power schemes. Each power scheme consists of a group of power management settings that are designed to meet specific power management goals, ranging from maximum power management to no power management.

To activate a VAIO Power Management power scheme

- 1 Click **Start** and then **Control Panel**.
- 2 Click **Performance and Maintenance**.
- 3 Click **Power Options**.
The **Power Options Properties** window appears.
- 4 Select the tab for power scheme settings.
- 5 Select a power scheme from the drop-down list.
- 6 If you now select the **VAIO Power Management** tab, you see that the selected power scheme appears on the tab.
- 7 If necessary, you can change the items in the list, for example, the LCD brightness of your computer screen.
- 8 Click **OK**.
The power scheme has been activated.



You must have administrator rights on your computer to set up a power scheme.

VAIO Power Management Viewer

To start VAIO Power Management Viewer

Click  on the **VAIO Power Management** tab.

Alternatively, you can use **VAIO Central** to start **VAIO Power Management Viewer**. Double-click the **Power Management** folder on the **System Information** tab in the **VAIO Central** window, and then double-click the **VAIO Power Management Viewer** icon. For launching **VAIO Central**, see **Setting Up Your Computer with VAIO Central** ([page 137](#)).

To change the power scheme

Select the desired power scheme from the drop-down list on **VAIO Power Management Viewer**.

To view performance with the power scheme modified with VAIO Power Management

When both **VAIO Power Management** and **VAIO Power Management Viewer** are running, **VAIO Power Management Viewer** shows performance with the power scheme that was modified with **VAIO Power Management**.



Use **VAIO Power Management** to set up or modify the power scheme.

Protecting the Hard Disk

Your computer has the **VAIO HDD Protection** utility preinstalled for customizing your settings for protecting your hard disk drive against shock hazards. You can select the sensitivity level of the built-in shock sensor to set the appropriate protection level.

Activating VAIO HDD Protection

To protect your hard disk drive against shock hazards, you must first activate **VAIO HDD Protection**.

To activate VAIO HDD Protection

- 1 Click **Start**, point to **All Programs**, and click **VAIO Central**.
- 2 Double-click **Security** on the **System Information** tab and then **Hard Disk Drive Protection Settings**. The setup window appears.
- 3 Select the **Activate hard disk drive protection** check box.
- 4 Select one of the desired sensitivity level.
- 5 Click **OK**.
For more information, click **Help** on the setup window to open the help file.

! **VAIO HDD Protection** is designed to minimize possibilities of damage to hard disk drives and user data. It does not assure 100% data protection under any circumstances.

Hard disk drive protection is disabled before Windows launch and during a shift to Hibernate or Standby mode, system recovery, and system shutdown.

Upgrading Your VAIO Computer

Your computer and memory modules use high precision components and electronic connectors technology. To avoid the invalidation of your guarantee due to mishandling, we recommend that:

- You contact your dealer to install a new memory module.
- You do not install it yourself, if you are not familiar with upgrading memory on a computer.
- You do not touch the connectors or open the memory module compartment cover.

For the type of module and the amount of memory installed on your model, refer to the online **Specifications**.

For assistance, contact an authorized Sony Service Center. To find the nearest center or agent, visit the Sony online support Web site.

Adding and Removing Memory

If you want to expand the functionality of your computer, you can increase the memory by installing optional memory modules. Before you upgrade your computer's memory, read the notes and procedures in the following pages. The number of available slots depends on the configuration of your model.

Notes on adding/removing memory modules

- ❑ Be careful when changing memory. Improper installation of memory modules may cause damage to your system. This damage may void your manufacturer's warranty.
- ❑ Only use memory modules that are compatible with your computer. If a memory module is not detected by the computer or Windows becomes unstable, contact your sales dealer or the manufacturer of your memory module.
- ❑ Electrostatic discharge can damage electronic components. Before touching a memory module, ensure the following:
 - ❑ The procedures described in this document assume familiarity with the general terminology associated with personal computers and with the safety practices and regulatory compliance required for using and modifying electronic equipment.
 - ❑ Turn off your computer and disconnect the system from its power source (that is, battery pack or AC adapter) and from any telecommunication links, networks, or modems before you open the computer. Failure to do so may result in personal injury or equipment damage.
 - ❑ Electrostatic Discharge (ESD) can damage memory modules and other components. Install the memory module only at an ESD workstation. If such a station is not available, do not work in a carpeted area, and do not handle materials that produce or hold static electricity (cellophane wrappers, for example). Ground yourself by maintaining contact with an unpainted metal portion of the chassis while performing the procedure.
 - ❑ Do not open the memory module package before you are ready to change the module. The package protects the module from ESD.

- Use the special bag delivered with the memory module or wrap the module in aluminum foil to protect it from electrostatic discharge.
- Introducing any liquids, foreign substances, or objects into the memory module slots or other internal components of your computer will result in damage to the computer and any repair costs will not be covered by the warranty.
- Do not place the memory module in a location subject to:
 - Heat sources such as radiators or air ducts
 - Direct sunlight
 - Excessive dust
 - Mechanical vibration or shock
 - Strong magnets or speakers that are not magnetically shielded
 - Ambient temperature of more than 95°F (35°C) or less than 41°F (5°C)
 - High humidity
- Handle the memory module with care. To avoid injuries to your hands and fingers, do not touch the edges of the components and circuit boards inside your computer.

Removing and Installing a Memory Module

To change or add a memory module

- 1 Shut down the computer and disconnect all peripheral devices.
- 2 Unplug the computer and remove the battery pack.
- 3 Wait until the computer cools down.
- 4 Unscrew the screws (indicated by the arrows below) on the bottom of the computer and remove the memory module compartment cover.

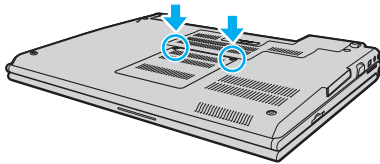

- 5 Touch a metal object (such as the connector panel on the back of the computer) to discharge static electricity.

- 6 Grasp the insulation sheet (1) tab and flip open the sheet.

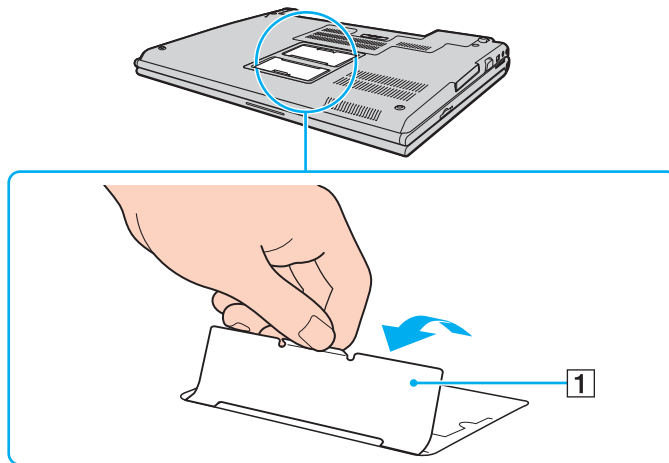

! The insulation sheet is equipped for module protection. Do not pull it too hard to damage the sheet.

7 Remove the memory module:

- Pull the latches in the direction of the arrows (1).
The memory module is released.

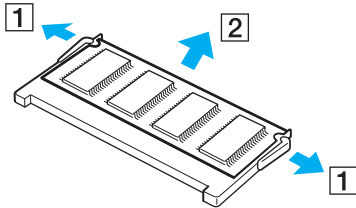

- Make sure that the memory module tilts up and then pull it out in the direction of the arrow (2).

8 Remove the new memory module from its packaging.

- Slide the memory module into the memory module slot and push it in until it clicks into place.

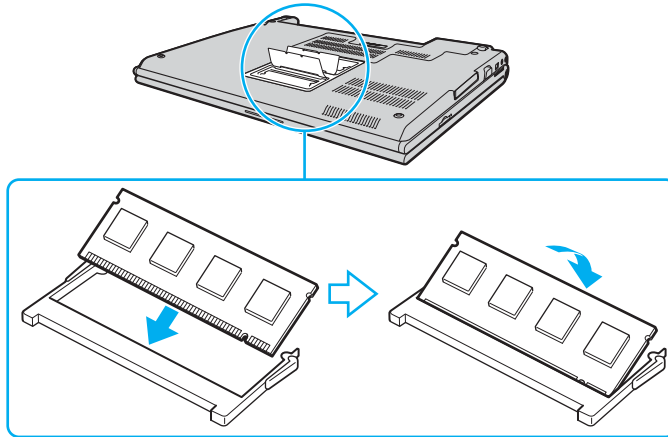

! Do not touch any other components on the motherboard.

Do not damage the insulation sheet equipped for module protection.

- Replace the memory module compartment cover.
- Tighten the screws on the bottom of the computer.
- Reinstall the battery pack and turn on the computer.

Viewing the Amount of Memory

To view the amount of memory

- 1 Turn on the computer.
- 2 Click **Start**, point to **All Programs**, and click **VAIO Central**.
- 3 Click the **System Information** tab in the **VAIO Central** window.
- 4 Double-click the **System Information** folder.
- 5 Double-click the **System Information** icon.

You can view the amount of system memory. If the additional memory does not appear, repeat the whole procedure and restart the computer.

Precautions

This section describes safety guidelines and precautions to help you protect your computer from potential damage.

- ❑ **On Handling the LCD Screen** ([page 156](#))
- ❑ **On Using the Power Source** ([page 157](#))
- ❑ **On Handling Your Computer** ([page 158](#))
- ❑ **On Using the Built-in MOTION EYE Camera** ([page 160](#))
- ❑ **On Handling Floppy Disks** ([page 160](#))
- ❑ **On Handling Discs** ([page 161](#))
- ❑ **On Using the Battery Pack** ([page 162](#))
- ❑ **On Using Headphones** ([page 163](#))
- ❑ **On Handling Memory Stick Media** ([page 164](#))
- ❑ **On Handling the Hard Disk** ([page 165](#))
- ❑ **On Handling the Memory Card Adapter** ([page 166](#))

On Handling the LCD Screen

- ❑ Do not leave the LCD screen facing the sun. This could damage the LCD screen. Be careful when using your computer near a window.
- ❑ Do not scratch the LCD screen or exert pressure on it. This could cause a malfunction.
- ❑ Using your computer in low temperature conditions may produce a residual image on the LCD screen. This is not a malfunction. When the computer returns to normal temperature, the screen returns to normal.
- ❑ A residual image may appear on the LCD screen if the same image is displayed for a long period of time. The residual image disappears in a while. You can use a screen saver to prevent residual images.
- ❑ The LCD screen becomes warm during operation. This is normal and does not indicate a malfunction.
- ❑ The LCD screen is manufactured using high-precision technology. You may, however, see tiny black points and/or bright points (red, blue, or green) that continuously appear on the LCD screen. This is a normal result of the manufacturing process and does not indicate a malfunction.
- ❑ Avoid rubbing the LCD screen. This could damage the screen. Use a soft, dry cloth to wipe the LCD screen.

On Using the Power Source

- ❑ See the online **Specifications** to check the power operation of your model.
- ❑ Do not share the AC outlet with other power-consuming equipment, such as a photocopier or shredder.
- ❑ You can purchase a power strip with a surge protector. This device prevents damage to your computer caused by sudden power surges, in an electrical storm, for example.
- ❑ Do not place heavy objects on the power cord.
- ❑ To disconnect the cord, pull it out by the plug. Never pull the cord itself.
- ❑ Unplug your computer from the AC outlet if you are not planning to use the computer for a long period of time.
- ❑ Make sure that the AC outlet is easily accessible.
- ❑ When the AC adapter is not used, unplug it from the AC outlet.
- ❑ Use the AC adapter supplied with your computer or genuine Sony products. Do not use any other AC adapter as it may cause a malfunction.

On Handling Your Computer

- ❑ Clean the cabinet with a soft cloth, which is dry or lightly moistened with a mild detergent solution. Do not use any type of abrasive pad, scouring powder, or solvent such as alcohol or benzene, as these may damage the finish of your computer.
- ❑ If you drop a solid object or any liquid onto your computer, shut down the computer and then unplug it. You may want to have the computer checked by qualified personnel before operating it again.
- ❑ Do not drop your computer or place any objects on top of the computer.
- ❑ Do not place your computer in a location subject to:
 - ❑ Heat sources, such as radiators or air ducts
 - ❑ Direct sunlight
 - ❑ Excessive dust
 - ❑ Moisture or rain
 - ❑ Mechanical vibration or shock
 - ❑ Strong magnets or speakers that are not magnetically shielded
 - ❑ Ambient temperature of more than 95°F (35°C) or less than 41°F (5°C)
 - ❑ High humidity
- ❑ Do not place electronic equipment near your computer. The electromagnetic field of the computer may cause a malfunction.
- ❑ Provide adequate air circulation to prevent internal heat from building up. Do not place your computer on porous surfaces such as rugs or blankets, or near material such as curtains or draperies that may block its air vents.
- ❑ Your computer uses high-frequency radio signals and may cause interference to radio or TV reception. If this occurs, relocate the computer a suitable distance away from the set.

- ❑ Use only specified peripheral equipment and interface cables; otherwise, problems may occur.
- ❑ Do not use cut or damaged connection cables.
- ❑ If your computer is brought directly from a cold location to a warm one, moisture may condense inside the computer. In this case, allow at least one hour before turning on the computer. If any problems occur, unplug the computer and contact an authorized Sony Service Center. To find the nearest center or agent, visit the Sony online support Web site.
- ❑ Make sure you disconnect the power cord before cleaning your computer.
- ❑ To avoid losing data if your computer is damaged, back up your data regularly.
- ❑ Do not exert pressure on the LCD screen or its edges when opening the LCD screen lid or lifting your computer. The LCD screen may be sensitive to pressure or added stress and exerting pressure may damage the screen or cause the screen to malfunction. To open the computer, hold the base with one hand and gently lift the LCD screen lid with the other. To carry the computer, make sure to hold the computer with both hands.

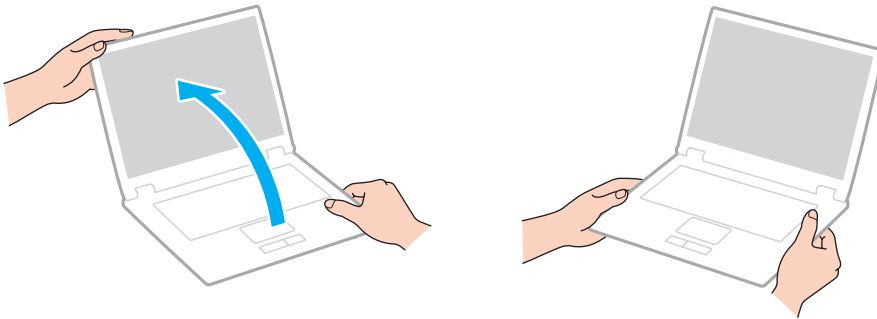

- ❑ Use a carrying case specially designed to carry your computer.

On Using the Built-in MOTION EYE Camera

- ❑ Do not touch the front mirror plate over the lens of the built-in MOTION EYE camera, as it may make scratches on the plate and such scratches will appear on the captured images.
- ❑ Do not let the direct sunlight get into the scope of the built-in MOTION EYE camera regardless of your computer's power state, as it may cause a malfunction of the camera.
- ❑ The built-in MOTION EYE camera is disabled while videos or still images are imported from an i.LINK-compatible device connected to the i.LINK port.
- ❑ Clean the front mirror plate over the lens of the built-in MOTION EYE camera with a blower brush or a soft brush. If the lens is extremely dirty, wipe it off with a soft dry cloth. Do not rub the plate, as it is force-sensitive.

On Handling Floppy Disks

- ❑ Do not open the shutter manually or touch the surface of the floppy disk.
- ❑ Keep floppy disks away from magnets.
- ❑ Keep floppy disks away from direct sunlight and other sources of heat.
- ❑ Keep floppy disks away from any liquid. Do not let them get wet. When you are not using your floppy disk, always remove it from the floppy disk drive and use a storage case.
- ❑ If the floppy disk comes with an adhesive label, make sure that the label is properly affixed. If the edge of the label is curled up, the label may stick to the inside of the floppy disk drive and cause a malfunction or damage your floppy disk.

On Handling Discs

- ❑ Do not touch the surface of the disc.
- ❑ Do not drop or bend the disc.
- ❑ Fingerprints and dust on the surface of a disc may cause read errors. Always hold the disc by its edges and central hole, as shown below:

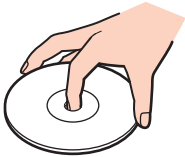

- ❑ Proper care of the disc is essential to its continuous reliability. Do not use solvents (such as benzine, thinner, alcohol, commercially available cleaners, or anti-static spray) which may cause damage to the disc.
- ❑ For normal cleaning, hold the disc by its edge and use a soft cloth to wipe the surface from the center out.
- ❑ If the disc is badly soiled, moisten a soft cloth with water, wring it out well, and use it to wipe the surface of the disc from the center out. Wipe off any remaining moisture with a dry soft cloth.
- ❑ Never affix an adhesive label on discs. This will affect the use of the disc irreparably.

On Using the Battery Pack

- ❑ Do not leave battery packs in temperatures above 140°F (60°C), such as in a car parked in the sun or under direct sunlight.
- ❑ Battery life is shorter in a cold environment. This is due to decreased battery efficiency at low temperatures.
- ❑ Charge battery packs at temperatures between 50°F to 86°F (10°C to 30°C). Lower temperatures require longer charging time.
- ❑ This computer is designed to operate only with genuine Sony batteries.
- ❑ While the battery pack is in use or being charged, heat builds up in the battery pack. This is normal and is not cause for concern.
- ❑ Keep the battery pack away from all sources of heat.
- ❑ Keep the battery pack dry.
- ❑ Do not open or try to disassemble the battery pack.
- ❑ Do not expose the battery pack to any mechanical shock.
- ❑ If you are not using your computer for a long period of time, remove the battery pack from the computer to prevent damage to the battery pack.
- ❑ If, after fully charging the battery pack, the battery power is still low, the battery pack may be reaching the end of its life and should be replaced.
- ❑ You do not need to discharge the battery pack before recharging.
- ❑ If you have not used the battery pack for a considerable amount of time, recharge the battery pack.

On Using Headphones

- ❑ **Road safety** – Do not use headphones while driving, cycling, or operating any motorized vehicle. It may create a traffic hazard and is illegal in some areas. It can also be potentially dangerous to play loud music while walking, especially at pedestrian crossings.
- ❑ **Preventing hearing damage** – Avoid using headphones at high volume. Hearing experts advise against continuous, loud and extended play. If you experience a ringing in your ears, reduce the volume or discontinue use.

On Handling Memory Stick Media

- Do not use the media in a location subject to static electricity or electrical noise.
- Do not touch the Memory Stick media connector with your finger or metallic objects.
- Use only the adhesive label supplied with the Memory Stick media as a label.
- Do not bend, drop, or apply strong shock to the Memory Stick media.
- Do not disassemble or modify Memory Stick media.
- Do not let Memory Stick media get wet.
- Do not use or store Memory Stick media in a location subject to:
 - Extremely high temperatures, such as in a car parked in the sun
 - Direct sunlight
 - High humidity
 - Corrosive substances
- Use the storage case supplied with the Memory Stick media.
- Be sure to make a backup copy of your valuable data.
- Keep the Memory Stick media out of reach of children. There is a risk of swallowing the media.
- When using the Memory Stick Duo media, do not use a fine-tipped pen to write on the label adhered to the Memory Stick Duo media. Exerting pressure on the media may damage internal components.

On Handling the Hard Disk

The hard disk has a high storage density and reads or writes data in a short time. However, it can be easily damaged by mechanical vibration, shock, or dust.

Although the hard disk has the internal safety device to prevent losing data due to mechanical vibration, shock or dust, you should be careful when handling your computer.

To avoid damaging your hard disk

- Do not subject your computer to sudden movements.
- Keep your computer away from magnets.
- Do not place your computer in a location subject to mechanical vibration or in an unstable position.
- Do not move your computer while the power is on.
- Do not turn off the power or restart your computer while reading or writing data to the hard disk.
- Do not use your computer in a place subject to extreme changes in temperature.



If the hard disk is damaged, the data cannot be restored.

On Handling the Memory Card Adapter

- Do not touch the memory card adapter connector with your finger or metallic objects.
- Use only the adhesive label exclusively designed for the memory card adapter as a label.
- Do not bend, drop, or apply strong shock to the memory card adapter.
- Do not disassemble or modify the memory card adapter.
- Do not let the memory card adapter get wet.
- Do not use or store the memory card adapter in a location subject to:
 - Extremely high temperatures, such as in a car parked in the sun
 - Direct sunlight
 - High humidity
 - Corrosive substances
- Use the storage case supplied with the memory card adapter.

Troubleshooting

This section describes how to solve common problems you might encounter when using your computer. Many problems have simple solutions. Try these suggestions before visiting the Sony online support Web site at <http://esupport.sony.com/EN/VAIO/> for customers in USA, at <http://www.sony.ca/support> for customers in Canada, at <http://esupport.sony.com/ES/VAIO/> for customers in Latin American countries or areas, or at <http://esupport.sony.com/ES/VAIO/BR/> for customers in Brazil.

- Computer (page 169)**
- System Security (page 177)**
- Battery (page 179)**
- Built-in MOTION EYE Camera (page 181)**
- Internet (page 184)**
- Networking (page 186)**
- Bluetooth Technology (page 189)**
- Optical Discs (page 193)**
- Display (page 198)**
- Printing (page 200)**
- Microphone (page 201)**
- Mouse (page 202)**
- Speakers (page 203)**
- Touch Pad (page 204)**
- Keyboard (page 205)**
- Floppy Disks (page 206)**

- ❑ **PC Cards** ([page 207](#))
- ❑ **Audio/Video** ([page 208](#))
- ❑ **Memory Stick Media** ([page 209](#))
- ❑ **Peripherals** ([page 210](#))
- ❑ **Docking Station** ([page 211](#))

Computer

What should I do if my computer does not start?

- Make sure your computer is securely plugged into a power source and turned on. Make sure the power indicator shows the power is on.
- Make sure the battery pack is installed properly and charged.
- Make sure the floppy disk drive (if applicable) is empty.
- If your computer is plugged into a power strip or uninterruptible power supply (UPS), make sure the power strip or UPS is plugged into a power source and turned on.
- If you are using an external display, make sure it is plugged into a power source and turned on. Make sure the brightness and contrast controls are adjusted correctly. See the manual that came with your display for more information.
- Disconnect the AC adapter and remove the battery pack. Wait three to five minutes. Reattach the AC adapter and reinstall the battery pack, and press the power button to turn on your computer.
- Condensation may cause your computer to malfunction. If this occurs, do not use the computer for at least one hour.
- Remove any extra memory modules you may have inserted since purchase.
- Check that you are using the supplied Sony AC adapter. For your safety, use only genuine Sony rechargeable battery packs and AC adapter, which are supplied by Sony for your VAIO computer.

What should I do if a BIOS error appears when I turn on my computer?

If the message "Press <F1> to resume, <F2> to setup" appears at the bottom of your computer screen, follow these steps:

- 1 Press the **F2** key.
The BIOS setup screen appears.
- 2 Set the date (month/day/year). Press the **Enter** key.
- 3 Press the **↓** key to select **System Time**, and then set the time (hour: minute: second). Press the **Enter** key.
- 4 Press the **→** key to select the **Exit** tab, and then press the **F9** key.
The message **Load default configuration now?** appears.
- 5 Select **Yes**, and press the **Enter** key.
- 6 Select **Exit (Save Changes)** or **Exit Setup**, and press the **Enter** key.
The message **Save configuration changes and exit now?** appears.
- 7 Select **Yes**, and press the **Enter** key.
Your computer restarts.

If this occurs frequently, contact an authorized Sony Service Center. To find the nearest center or agent, visit the Sony online support Web site.

What should I do if the power indicator (Green) lights but my computer screen stays blank?

Follow these steps:

- 1 Press and hold the power button for more than four seconds to check that the power indicator goes out. Then turn on your computer again.
- 2 If your computer screen still stays blank, unplug the AC adapter, remove the battery pack, and leave the computer for about a minute. Then plug in the AC adapter, install the battery pack, and turn on the computer again.

What should I do if my computer or software stops responding?

- ❑ It is best to turn off your computer using the **Turn Off Computer** option on the Microsoft Windows **Start** menu, located on the taskbar. Using other methods, including those listed below, may result in loss of unsaved data.
- ❑ Click **Start**, point to **Turn Off Computer**, and then click **Turn Off**.
- ❑ If your computer does not turn off, press the **Ctrl+Alt+Delete** keys simultaneously. When the **Windows Task Manager** window appears, click **Turn Off** from the **Shut Down** menu.
When the **Windows Security** window appears, click **Shut Down**.
- ❑ If your computer still does not turn off, press and hold the power button until the computer turns off.
- ❑ If your computer stops responding while playing a CD or DVD, press the **Ctrl+Alt+Delete** keys simultaneously. You can turn off the computer from **Windows Task Manager**.

!
Pressing the **Ctrl+Alt+Delete** keys simultaneously or turning off your computer with the power button may cause loss of data.

- ❑ Remove the AC adapter and battery pack.
- ❑ Try reinstalling the software.
- ❑ Contact the software publisher or designated provider for technical support.

Why doesn't my computer enter Standby or Hibernate mode?

Your computer may become unstable if the operating mode is changed before the computer completely enters Standby or Hibernate.

To restore your computer to normal operating stability

- 1 Close all open programs.
- 2 Click **Start, Turn Off Computer**, and then **Restart**.
- 3 If your computer does not restart, press the **Ctrl+Alt+Delete** keys simultaneously.
In the **Windows Task Manager** window, select **Restart** from the **Shut Down** menu to restart the computer.
- 4 If this procedure does not work, press and hold the power button until the computer turns off.

What should I do if the battery indicator is flashing and my computer does not start?

- This symptom could be due to the battery pack not being installed properly. To resolve this symptom, turn off your computer and remove the battery pack. Then install the battery pack to the computer again. For details, see **Installing the Battery Pack (page 20)**.
- If the symptom persists after performing the above, it means the installed battery pack is not compatible. Remove the battery pack and contact an authorized Sony Service Center. To find the nearest center or agent, visit the Sony online support Web site.

What should I do if a message window, notifying of incompatibility or improper installation of the battery pack, appears and my computer enters Hibernate mode?

- ❑ This symptom could be due to the battery pack not being installed properly. To resolve this symptom, turn off your computer and remove the battery pack. Then install the battery pack to the computer again. For details, see **Installing the Battery Pack (page 20)**.
- ❑ If the symptom persists after performing the above, it means the installed battery pack is not compatible. Remove the battery pack and contact an authorized Sony Service Center. To find the nearest center or agent, visit the Sony online support Web site.

Why does the System Properties window display a slower CPU speed than the maximum?

This is normal. Because your computer's CPU utilizes a type of CPU speed controlling technology for power conservation purposes, System Properties may display the CPU's current speed instead of the maximum speed.

What should I do if Windows does not start, showing a message, when I start my computer?

If you enter a wrong power-on password three times consecutively, the **Enter Onetime Password** message appears. If you enter a wrong power-on password three times consecutively again, the **System Disabled** message appears and Windows will not start. Press and hold the power button for more than four seconds to check that the power indicator goes off. Wait for 10 or 15 seconds, then restart your computer and enter the correct password. When entering the password, check that the Num lock indicator and Caps lock indicator are off. If any are lit, press the **Num Lk** key or the **Caps Lock** key to turn off the indicator before entering the password.

What should I do if my game software does not work or it keeps crashing?

- Check the web site of the game if there are any patches or updates to download.
- Make sure you have installed the latest video driver.
- On some VAIO models, the graphics memory is shared with the system. The optimal graphic performance in this case is not guaranteed.

What should I do if I cannot remember the BIOS password?

If you have forgotten the BIOS password, contact an authorized Sony Service Center to reset it. A reset fee will be charged. To find the nearest center or agent, visit the Sony online support Web site.

Why does it take time before my computer starts?

- If Norton Internet Security's Personal Firewall is active, it may take some time before the desktop screen appears due to network security checkups.
- If the TPM is enabled, it will take longer before the VAIO logo appears due to security checks at computer startup.

Why doesn't my computer screen turn off when the time selected for the automatic turn-off action has passed?

The originally selected VAIO's screen saver disables the timer setting, which you can select using the Windows power options, for your computer screen to turn off.

Change the originally selected VAIO's screen saver.

How can I change the boot device order?

You can use one of the BIOS functions to change the boot device order. Follow these steps:

- 1 Turn on your computer.
- 2 Press the **F2** key when the VAIO logo appears.
The BIOS setup screen appears. If not, restart the computer and press the **F2** key several times when the VAIO logo appears.
- 3 Press the **←** or **→** key to select **Boot**.
- 4 Press the **↑** or **↓** key to select the drive of which boot device order you want to change.
- 5 Press the **-** key or the **Shift + =** keys to change the boot device order.
Your computer will boot from the drive with the highest boot device order.
- 6 Press the **←** or **→** key to select **Exit**, select **Exit Setup**, and then press the **Enter** key.
On the **Setup Confirmation** screen, make sure **Yes** is selected and then press the **Enter** key.

What should I do if I cannot boot my computer from the USB floppy disk drive connected to the computer?

To boot your computer from the USB floppy disk drive, you need to change the boot device.

Turn on your computer and press the **F11** key when the VAIO logo appears.

How can I change the volume of the startup sound?

To change the startup sound volume

- 1 Press the **F2** key.
The BIOS setup screen appears.
- 2 Press the **←** or **→** key to select **Advanced**.
- 3 Press the **↑** or **↓** key to select **Speaker Volume** and press the **Enter** key.
- 4 Press the **↑** or **↓** key to select the speaker volume at startup and press the **Enter** key.
- 5 Press the **←** or **→** key to select **Exit**, select **Exit (Save Changes)** or **Exit Setup**, and then press the **Enter** key.
The message **Save configuration changes and exit now?** appears.
- 6 Select **Yes** and press the **Enter** key.
Your computer restarts and you will hear the startup sound at the specified volume level.



You can also show/hide the VAIO animation logo at startup. On the screen that is displayed after step 2 above, select **VAIO Animation Logo** or **Show VAIO Animation Logo** and press the **Enter** key to proceed with the setting. Hiding the VAIO animation logo will also turn off the startup sound.

System Security

This section provides information about keeping your computer operating smoothly and protecting against potential threats to the computer's security.

How can I protect my computer against security threats, such as viruses?

The Microsoft Windows operating system is preinstalled on your computer. The best way to protect your computer against security threats, such as viruses, is to download and install the latest Windows updates regularly.

You can get important Windows updates by doing one of the following:

- The **Automatic Updates** feature — This feature automatically searches for and delivers updates directly to your computer whenever it is connected to the Internet.
- The Windows Updates web site — This site enables you to download computer updates without turning on the **Automatic Updates** feature.



Your computer must be connected to the Internet before you can receive updates.

To use the Automatic Updates feature

- 1 Connect to the Internet.
- 2 Click the **Automatic Updates** icon on the taskbar.
- 3 Follow the on-screen instructions to set up automatic or scheduled updates.

To visit the Windows Updates web site

- 1 Connect to the Internet.
- 2 Type **<http://windowsupdate.microsoft.com/>** in the address bar of your browser. The **Microsoft Windows Update** and **Security Warning** windows appear.

- 3 In the **Security Warning** window, start installation and run **Windows Update**.
- 4 In the **Microsoft Windows Update** window, select an installation type, and follow the on-screen instructions.

How do I keep my antivirus software updated?

You can keep the **Norton Internet Security** software program current with the latest updates from Symantec Corporation.

To download and install the latest security update

- 1 Double-click the **Norton Internet Security** icon on the taskbar. If you have not previously registered the antivirus software, a series of information wizards appears.
 - 1 Follow the on-screen instructions to complete each wizard.
 - 2 Double-click the **Norton Internet Security** icon again.
The **Norton Internet Security** window appears.
If you have previously registered this antivirus software, the **Norton Internet Security** window automatically appears.
- 2 Follow the on-screen instructions to select and download updates.

Battery

How do I find the battery charging status?

See **Charging the Battery Pack** ([page 22](#)).

When is my computer using AC power?

When your computer is directly connected to the AC adapter, it uses AC power, even if the battery pack is installed.

When should I recharge the battery pack?

- When the battery level falls below 10 percent.
- When both the battery and power indicators blink.
- When you have not used the battery pack for a long period of time.

When should I replace the battery pack?

If the battery power is still low after charging it, the battery pack may be reaching the end of its life and should be replaced.

Should I be concerned that the installed battery pack is warm?

No, it is normal for the battery pack to be warm when it is powering your computer.

Can my computer enter Hibernate mode while using battery power?

Your computer can enter Hibernate mode while using battery power, but some software programs and peripheral devices prevent the system from entering Hibernate mode. If you are using a program that prevents the system from entering Hibernate mode, save your data frequently to avoid losing data. See **Using Hibernate Mode (page 141)** for information on how you can manually activate Hibernate mode.

Why doesn't my computer enter Hibernate mode?

You may first need to enable Hibernate mode. Follow these steps:

- 1 Click **Start** and then **Control Panel**.
- 2 Click **Performance and Maintenance**.
- 3 Click **Power Options**.
The **Power Options Properties** window appears.
- 4 Select the **Hibernate** tab.
- 5 Click to check the box next to **Enable hibernation**.

Built-in MOTION EYE Camera

Why does the viewer window show no images or poor-quality images?

- The built-in MOTION EYE camera cannot be shared by more than one software application. If another software application is using the camera, exit the application before using the built-in MOTION EYE camera.
- The video memory of your computer may have become insufficient for displaying images from the built-in MOTION EYE camera. Lowering the resolution or reducing the colors of the LCD screen might help.
- The viewer window may show some noises, for example horizontal streaks, if you view a rapid-moving object. This is normal and does not indicate a malfunction.
- If the problem persists, restart your computer.

Why are captured images poor in quality?

- The images captured under the fluorescent lamp may show reflection of the light.
- A dark portion in captured images may appear as a noise.
- If the front mirror plate over the lens is dirty, you cannot take a clear shot. Clean the lens. See **On Using the Built-in MOTION EYE Camera (page 160)**.

Why do captured images contain dropped frames and audio interruptions?

- The effect settings on your software application may have caused dropped frames. See the help file on your software application for more information.
- There may be more software applications running than your computer can handle. Exit the applications that you are not currently using.
- The power management function of your computer may have been activated. Check the CPU performance.

Why does movie playback show dropped frames when my computer is running on the battery?

The battery pack is running out of power. Connect your computer to an AC power source.

Why do the images captured by the built-in MOTION EYE camera flicker?

This problem occurs when you use the camera under fluorescent lights due to the mismatch between lighting output frequency and shutter speed.

To reduce flicker noise, change the pointing direction of the camera or the brightness of camera images. In some software applications, you can set an appropriate value to one of the camera properties (e.g. **LightSource**, **Flickness**, etc.) to eliminate flicker noise.

Why is the video input from the built-in MOTION EYE camera suspended for a few seconds?

The video input may be suspended for a few seconds if:

- a shortcut key with the **Fn** key is used.
- the CPU load increases.

This is normal and does not indicate a malfunction.

Why can't I use the built-in MOTION EYE camera?

- ❑ The built-in MOTION EYE camera cannot be shared by more than one software application. If another software application is using the camera, exit the application before using the built-in MOTION EYE camera.
- ❑ If the problem persists, you must reinstall the driver software for the camera. Follow these steps:
 - 1 Click **Start** and then **Control Panel**.
 - 2 Click the **Performance and Maintenance** icon.
 - 3 Click the **System** icon.
 - 4 Click **Device Manager** on the **Hardware** tab.
 - 5 Double-click **Imaging devices**.
 - 6 Right-click **Sony Visual Communication Camera VGP-VCC2** and click **Update Driver**.

What should I do if my computer becomes unstable when it enters Standby or Hibernate mode while the built-in MOTION EYE camera is in use?

- ❑ Do not place your computer into Standby or Hibernate mode while you are using the built-in MOTION EYE camera.
- ❑ If your computer automatically enters Standby or Hibernate mode, change the corresponding power saving mode setting. For changing the setting, see **Using the Power Saving Modes (page 138)**.

Internet

What should I do if my modem does not work?

- Make sure the telephone cable is securely plugged into the modem port on your computer and the wall jack.
- Make sure the telephone cable is working. Plug the cable into an ordinary telephone and listen for a dial tone.
- Make sure the telephone number the program is dialing is correct.
- Make sure the software you are using is compatible with your computer's modem. (All preinstalled Sony programs are compatible.)
- Make sure the modem is the only device connected to your telephone line.
- Follow these steps to check the settings:
 - 1 Click **Start** and then **Control Panel**.
 - 2 Click **Printers and Other Hardware**.
 - 3 Click **Phone and Modem Options**.
 - 4 On the **Modems** tab, check that your modem is listed.
 - 5 On the **Dialing Rules** tab, check the location information is correct.

Why is my modem connection slow?

Your computer is equipped with a V.92/ V.90 compatible modem. Many factors may influence modem connection speed, including telephone line noise or compatibility with telephone equipment, such as fax machines or other modems. If you think your modem is not connecting properly to other PC-based modems, fax machines, or your Internet Service Provider (ISP), do any of the following:

- Ask your telephone company to verify your telephone line is free of any line noise.
- If your problem is fax-related, make sure there are no problems with the fax machine you are calling and that it is compatible with fax modems.
- If you are having a problem connecting with your ISP, make sure the ISP is not experiencing technical problems.
- If you have a second telephone line, try connecting the modem to that line.

Networking

What should I do if my computer cannot connect to a wireless LAN access point?

- Connection availability is affected by distance and obstructions. You may need to move your computer away from obstructions or closer to any access point you may be using.
- Make sure the **WIRELESS** or **WIRELESS LAN** switch is on and the WIRELESS LAN indicator is lit on your computer.
- Make sure power to the access point is on.
- Follow these steps to check the settings:
 - 1 Click **Start** and then **Control Panel**.
 - 2 Click **Network and Internet Connections**.
 - 3 Click **Network Connections**.
 - 4 Right-click **Wireless Network Connection**.
 - 5 Click **Properties**.
 - 6 Click the **Wireless Networks** tab.
 - 7 Click **View Wireless Networks** to see that your access point is selected.
- Make sure the encryption key is correct.

What should I do if I cannot access the Internet?

- Check the access point settings. See the manual that came with your access point for more information.
- Make sure your computer and the access point are connected to one another.
- Move your computer away from obstructions or closer to any access point you may be using.
- Make sure your computer is properly configured for Internet access.

Why is the data transfer speed slow?

- ❑ The wireless LAN data transfer speed is affected by distance and obstructions between devices and access points. Other factors include device configurations, radio conditions, and software compatibility. To maximize the data transfer speed, move your computer away from obstructions or closer to any access point you may be using.
- ❑ If you are using a wireless LAN access point, the device may be temporarily overloaded depending on how many other devices are communicating via the access point.
- ❑ If your access point interferes with other access points, change the access point channel. See the manual that came with your access point for more information.

How do I avoid data transfer interruptions?

- ❑ When your computer is connected to an access point, data transfer interruptions may occur when using large files or if the computer is in close proximity to microwaves and cordless telephones.
- ❑ Move your computer closer to the access point.
- ❑ Make sure the access point connection is intact.
- ❑ Change the access point channel. See the manual that came with your access point for more information.

What are channels?

- ❑ Wireless LAN communication occurs on divided frequency bands known as channels. Third-party wireless LAN access point channels may be preset to different channels from Sony devices.
- ❑ If you are using a wireless LAN access point, see connectivity information contained in the manual that came with your access point.

Why does the network connection stop when I change the encryption key?

Two computers with built-in wireless LAN may lose a peer-to-peer network connection if the encryption key is changed. You can either change the encryption key back to the original profile or re-enter the key on both computers so the key matches.

Bluetooth Technology

What should I do if other Bluetooth devices cannot discover my computer?

- Make sure both devices have the Bluetooth functionality enabled.
- If the Bluetooth indicator is off, turn on the **WIRELESS** switch.
- You cannot use the Bluetooth functionality when your computer is in a power saving mode. Return to Normal mode, then turn on the **WIRELESS** switch.
- Your computer and the device may be too far apart. Wireless Bluetooth technology works best when the devices are within 33 feet (10 meters) of each other.

Why can't my computer discover other Bluetooth devices?

If the connected device is also connected to other devices, it may not appear in the Bluetooth utility software or you may not be able to communicate with the device.

What should I do if I cannot find the Bluetooth device with which I want to communicate?

- Check that the Bluetooth functionality of the device with which you want to communicate is on. See the other device's manual for more information.
- If the device with which you want to communicate is already communicating with another Bluetooth device, it may not be found or it may not be able to communicate with your computer.
- To allow other Bluetooth devices to communicate with your computer, right-click the Bluetooth icon  on the taskbar and select **Options** from the menu to open the **Options** window. Then, check if proper security modes are selected on the **Security** tab. For details on the security modes, see the help file on the Bluetooth utility software. For more information on the Bluetooth Device window, see **Communicating with Another Bluetooth Device (page 72)**.

What should I do if other Bluetooth devices cannot connect to my computer?

- ❑ Make sure the other device is authenticated.
- ❑ Your computer may not allow connections from other devices. To enable Bluetooth device connections, follow these steps:
 - 1 Right-click the Bluetooth icon  on the taskbar.
 - 2 Select **Options** from the menu.
The **Options** window appears.
 - 3 Check if **Standard** or **Low** is selected for the Bluetooth security level on the **Security** tab.
If a custom Bluetooth security level is selected, click the **Default level** button.
 - 4 Click **OK**.
- ❑ The data transfer distance can be shorter than 33 feet (10 meters) depending on existing obstacles between the two devices, on radio wave quality, and on the operating system or the software in use. Move your computer and Bluetooth devices closer to each other.
- ❑ If the device with which you want to communicate is already communicating with another Bluetooth device, it may not be found or it may not be able to communicate with your computer.
- ❑ Check that the Bluetooth functionality of the device with which you want to communicate is on. See the other device's manual for more information.

Why is my Bluetooth connection slow?

- ❑ The data transfer speed depends on the obstacles and/or the distance between the two devices, on the radio wave quality, and on the operating system or the software in use. Move your computer and Bluetooth devices closer to each other.
- ❑ The 2.4 GHz radio frequency used by Bluetooth and wireless LAN devices is also used by other devices. Bluetooth devices incorporate technology that minimizes interference from other devices using the same wavelength, however, communication speed and connection range may be reduced. Interference from other devices may also stop communication altogether.
- ❑ Connection availability is affected by distance and obstructions. You may need to move your computer away from obstructions or closer to the device to which it is connected.
- ❑ Identify and remove obstacles between your computer and the device to which it is connected.
- ❑ Note that due to limitations of the Bluetooth standard, large files may occasionally be corrupted during continuous transfer due to electromagnetic interference from the environment.

Why does the message requesting authentication appear?

The target Bluetooth-enabled device is requesting connection authentication. Mutual authentication is required to enable Bluetooth communications with this device.

Why can't I connect to service supported by the target Bluetooth device?

Connection is only possible for services also supported by the computer with the Bluetooth functionality. For more details, see the help file on the Bluetooth utility software.

Can I use a device with Bluetooth technology on airplanes?

With Bluetooth technology, your computer transmits a radio frequency of 2.4 GHz. Sensitive locations, such as hospitals and airplanes, may have restrictions on use of Bluetooth devices, due to radio interference. Check with facility staff to see if use of the Bluetooth functionality on the computer is permitted.

Why can't I connect to a Bluetooth device by specifying its IP address on a Personal Area Network (PAN)?

The Bluetooth utility software uses Dynamic Host Configuration Protocol (DHCP) to assign IP addresses to active wireless devices. If you specify a fixed IP address for the device to which you want to connect, the utility cannot assign a dynamic IP address to the device and fails. Do not specify IP addresses when using a PAN.

Why can't I use the Bluetooth functionality when I log on to my computer as a limited user?

The Bluetooth functionality may not be available to users with limited rights on your computer. Log on to the computer as a user with administrator rights.

Why can't I connect to a Bluetooth device in Personal Area Network User mode?

If the device to which you want to connect supports Bluetooth communication in Personal Area Network User mode only, you cannot establish a connection from your computer.

Why can't I use the Bluetooth utility software when I switch a user?

If you switch a user without logging off from your system, the Bluetooth utility software will not work successfully. Make sure to log off before switching a user. To log off from your system, click **Start** and then **Log Off**.

Optical Discs

Why does my computer freeze when I try to read a disc?

The disc that your computer is trying to read may be dirty or damaged. Follow these steps:

- 1 Restart the computer by clicking **Start, Turn Off Computer,** and **Restart.**
- 2 Eject the disc from the optical disc drive.
- 3 Examine the disc for dirt or damage. If the disc is dirty, see **On Handling Discs (page 161)** for instructions on how to clean it.

What should I do if the drive tray does not open?

- Make sure your computer is on.
- Press the drive eject button.
- If the drive eject button does not work, click **Start** and then **My Computer**. Right-click the optical disc drive icon, and select **Eject** from the shortcut menu.
- If none of the above options work, insert a thin, straight object (such as a paper clip) in the manual eject hole near the drive eject button.
- Try restarting your computer.

What should I do if I cannot play a CD or DVD properly on my computer?

- ❑ Make sure the disc was inserted into the optical disc drive with the label facing upward.
- ❑ Make sure the necessary program(s) is installed according to the manufacturer's instructions.
- ❑ If a CD or DVD is dirty or damaged, your computer will stop responding. Follow these steps:
 - 1 Restart the computer by pressing the **Ctrl+Alt+Delete** keys, and selecting **Restart** from the **Shut Down** menu of the **Windows Task Manager** window.
 - 2 Remove the CD or DVD from the optical disc drive.
 - 3 Check the disc for dirt or damage. If you need to clean the disc, see **On Handling Discs (page 161)** for instructions.
- ❑ If you are playing a CD or DVD and cannot hear sound, do any of the following:
 - ❑ Double-click the **Volume** icon on the taskbar, and click to cancel the **Master Volume Mute All** and **Wave Mute** check boxes.
 - ❑ Check the volume setting in the audio mixer.
 - ❑ If you are using external speakers, check the volume settings on the speakers and the connections between the speakers and your computer.
 - ❑ Make sure the CD audio feature is enabled and the correct driver software is installed. Follow these steps:
 - 1 Click **Start** and then **Control Panel**.
 - 2 Click **Performance and Maintenance**.
 - 3 Click **System**.
The **System Properties** window appears.
 - 4 Select the **Hardware** tab, and click **Device Manager** in the **Device Manager** box.
A window with a listing of your computer's hardware devices appears.
If an "X" or an exclamation point appears on the listed device, you may need to enable the device or reinstall the drivers.

- 5 Double-click the optical disc drive device to open the submenu.
 - 6 Double-click the listed drive, and select the **Properties** tab.
 - 7 Click to select the **Enable digital CD audio for this CD-ROM device** check box, if it is not selected. You can confirm the driver software by selecting the **Driver** tab, and clicking **Driver Details**.
 - 8 Click **OK** to close the window.
- Make sure an adhesive label is not affixed to a CD or DVD. Adhesive labels can come off while the disc is in the optical disc drive and damage the drive or cause it to malfunction.
 - If a region code warning appears, the disc may be incompatible with the optical disc drive. Check the DVD package to make sure the region code is compatible with the optical disc drive.
 - If you notice condensation on your computer, do not use the computer for at least one hour. Condensation can cause the computer to malfunction.
 - Make sure your computer is running on AC power supply and try the disc again.

What should I do if I cannot write data to CD media?

- Do not launch any software application or allow any to launch automatically, not even a screen saver.
- Do not use the keyboard.
- Do not use a CD-R/RW disc that has an adhesive label affixed to it. This could cause a write error or other damage.

What should I do if I cannot write data to DVD media?

This Q & A entry applies to selected models only. See the online **Specifications** to find the type of your optical disc drive, and then **Reading and Writing Optical Discs (page 34)** to find about the supported disc media.

- Make sure you are using the correct DVD recordable media.
- Check which DVD recordable format is compatible with your computer's built-in DVD recorder. Note the possibility that some brands of DVD recordable media do not work.

What should I do if I cannot write data to DVD-RAM media using Windows functions?

This Q & A entry applies to selected models only. See the online **Specifications** to find the type of your optical disc drive, and then **Reading and Writing Optical Discs (page 34)** to find about the supported disc media.

Follow these steps to change the settings:

- 1 Click **Start** and then **My Computer**.
- 2 Right-click the optical disc drive icon and select **Properties**.
- 3 Click the **Recording** tab.
- 4 Click to cancel the **Enable CD recording on this drive** check box.
- 5 Click **OK**.

! Canceling the **Enable CD recording on this drive** check box disables writing data to CD-R and CD-RW discs. To write data to such discs, make sure to select this check box.

You cannot add data to DVD-RAM discs with data already written by the **Roxio DigitalMedia** software due to difference in disc formatting. Attempt to add data to such a disc will re-format the disc, resulting in loss of the entire written data.

Display

Why did my computer screen go blank?

- ❑ Your computer screen may go blank if the computer has lost power or has entered a power saving mode (Standby or Hibernate). If the computer is in LCD (Video) Standby mode, press any key to activate the computer screen. See **Using the Power Saving Modes (page 138)** for more information.
- ❑ Make sure your computer is securely plugged into a power source and turned on. Make sure the power indicator shows the power is on.
- ❑ If your computer is using battery power, make sure the battery pack is installed properly and is charged. See **Using the Battery Pack (page 20)** for more information.
- ❑ If the display mode is set to external display, press the **Fn+F7** keys. See **Combinations and Functions with the Fn Key (page 27)** for more information.

Why doesn't my computer screen display a video?

If the external display is selected for the display output and the external display is disconnected, you cannot display a video on your computer screen. Stop video playback, change the display output to the computer screen, and then restart video playback. See **Selecting Display Modes (page 91)**. Alternatively, you can press the **Fn+F7** keys to change the display output. See **Combinations and Functions with the Fn Key (page 27)** for more information.

What should I do if my computer screen is dark?

Press the **Fn+F6** keys to brighten your computer screen.

What should I do if the LCD brightness of my computer screen changes?

The LCD brightness setting, adjusted with the **Fn+F5/F6** keys, is temporary and this adjustment is overridden by the setting on the **VAIO Power Management** tab when another power scheme is selected. To save this preference for the brightness, follow these steps:



To do the following procedure, you must have administrator rights on your computer.

- 1 Click **Start** and then **Control Panel**.
- 2 Click **Performance and Maintenance**.
- 3 Click **Power Options**.
- 4 Select the tab for power scheme settings.
- 5 Select the desired power scheme from the drop-down list.
- 6 On the **VAIO Power Management** tab, select **No change** for **LCD Brightness**.
- 7 Click **OK**.

The preference for the LCD brightness adjusted with the **Fn+F5/F6** keys is saved and the brightness of your computer screen remains unchanged regardless of operating conditions.

What should I do if the external display stays blank?

If you cannot change the display output with the **Fn+F7** keys, you need to change the settings for the external display with **VAIO Central**. To change the settings, launch the **VAIO Central**, select the control item for the external display, and then cancel the check box for enabling the automatic function to select the external display for the output. Then, try the **Fn+F7** keys to change the display output.

Printing

What should I do if I cannot print a document?

- Make sure your printer is on, and the printer cable is securely connected to the ports on the printer and computer.
- Make sure your printer is compatible with the Windows operating system installed on your computer.
- You may need to install the printer driver software before you use your printer. See the manual that came with your printer for more information.
- If your printer is not functioning after your computer resumes from a power saving mode (Standby or Hibernate), then restart the computer.
- If the bidirectional communication functions are provided with your printer, disabling the functions on your computer may enable printing. Follow these steps:
 - 1 Click **Start** and then **Control Panel**.
 - 2 Click **Printers and Other Hardware**.
 - 3 Click **Printers and Faxes**.
 - 4 Right-click the printer icon and select **Properties**.
 - 5 Click the **Ports** tab.
 - 6 Click to cancel the **Enable bidirectional support** check box.
 - 7 Click **OK**.

This change to the settings disables the bidirectional communication functions of the printer, such as data transfer, status monitoring, and remote panel.

Microphone

What should I do if my microphone does not work?

If you are using an external microphone, make sure the microphone is turned on and is properly plugged into the microphone jack on your computer.

Mouse

What should I do if my computer does not recognize my mouse?

- Make sure your mouse is securely plugged into the port.
- Restart your computer with your mouse connected.

What should I do if the pointer does not move when I use my mouse?

- Make sure another mouse is not connected.
- If you are playing a disc, press the **Ctrl+Alt+Delete** keys simultaneously to stop playback and restart your computer.
- If the pointer still does not move, do any of the following:
 - Press the **Ctrl+Alt+Delete** keys simultaneously.
In the **Windows Task Manager** window, select **Restart** from the **Shut Down** menu to restart your computer.
 - Press and hold the power button for more than four seconds. When your computer turns off, wait for 10 to 15 seconds and then press the power button again to restart the computer.

Speakers

What should I do if my speakers do not work?

- Make sure your speakers are properly connected and the volume is turned up loud enough to hear sound.
- Make sure your speakers are designed for computer use.
- If your speakers have a muting button, set the button to off.
- If you have connected an audio cable to the headphones jack, disconnect the cable and use the speaker cable supplied with your speakers.
- If you are using battery power, make sure the battery pack is installed properly and is charged.
- If your speakers require external power, make sure the speakers are connected to a power source. See the manual that came with your speakers for more information.

What should I do if I cannot hear sound from my speakers?

- If your computer is using battery power, make sure the battery pack is properly installed and is charged.
- If you are using a program that has its own volume control, make sure the volume control is properly set. See the program's help file for more information.
- Make sure the speaker volume is turned up loud enough and the audio option is enabled.
- Check the volume controls in Windows.
- If **Audio/Modem** is disabled on **VAIO Power Management** power scheme settings, enable the option. See **Activating VAIO Power Management Power Schemes (page 144)** for the procedure.

Touch Pad

What should I do if the touch pad does not work?

- You may have disabled the touch pad without connecting a mouse to your computer. See [Using the Touch Pad \(page 29\)](#).
- Restart your computer.
Press the **Ctrl+Alt+Delete** keys simultaneously.
In the **Windows Task Manager** window, select **Restart** from the **Shut Down** menu to restart the computer.
- If the pointer does not move while playing a disc, press the **Ctrl+Alt+Delete** keys simultaneously to stop playback and restart your computer.
- If the problem persists, make sure a mouse is not connected.

How do I change the left and right button assignments?

If your computer is interpreting a single-click as a double-click, you may want to change the button assignments. Follow these steps:

- 1 Click **Start** and then **Control Panel**.
- 2 Click **Printers and Other Hardware**.
- 3 Click **Mouse**.
- 4 Click the **Buttons** tab.
- 5 Select your preferences in the **Button Selection** box, and then click **Apply** to apply your settings.
You may need to press the **Tab** key and the **↑** and **↓** keys to make your selections.
- 6 Click **OK** to close the window.

Keyboard

What should I do if the keyboard configuration is wrong?

- ❑ The language layout of your computer's keyboard is labeled on the packaging box. If you choose a different regional keyboard when you complete the Windows setup, the key configuration will be mismatched.
- ❑ To change the keyboard configuration, follow these steps:
 - 1 Click **Start** and then **Control Panel**
 - 2 Click **Date, Time, Language and Regional Options**, and click **Regional and Language Options**.
 - 3 Change the settings as desired.

What should I do if I cannot enter certain characters with the keyboard?

If you cannot enter **U, I, O, P, J, K, L, M**, and so on, the **Num Lk** key may be activated. Check that the Num lock indicator is off. If the Num lock indicator is on, press the **Num Lk** key to turn it off before entering these characters.

Floppy Disks

Why doesn't the Safely Remove Hardware icon appear on the taskbar when the drive is connected?

Your computer does not recognize the floppy disk drive. First, make sure the USB cable is properly connected to the USB port. If you need to secure the connection, wait a few moments for the computer to recognize the drive. If the icon still does not appear, follow these steps:

- 1 Close all programs that are accessing the floppy disk drive.
- 2 Wait for the LED indicator on the floppy disk drive to turn off.
- 3 Push the eject button to remove the disk, and disconnect the USB floppy disk drive from your computer.
- 4 Reconnect the floppy disk drive by inserting the USB connector (with the USB icon facing upward) into the USB port.
- 5 Restart the computer by clicking **Start, Turn Off Computer**, and then **Restart**.

What should I do if I cannot write data to a floppy disk?

- Make sure the floppy disk is properly inserted in the drive.
- If the disk is inserted properly and you are still unable to write data to it, the disk may be full or write-protected. You can either use a floppy disk that is not write-protected or disable the write-protect feature.

PC Cards

What should I do if my PC Card does not work?

- ❑ Make sure the PC Card is inserted properly. See **Inserting a PC Card (page 43)** for more information.
- ❑ Make sure the PC Card is compatible with the Microsoft Windows operating system installed on your computer.
- ❑ See the manual that came with your PC Card for more information. You may need to install driver software if you are not using a Sony PC Card.

Why doesn't my computer recognize attached devices?

For some PC Cards, if you alternate between Normal mode and Standby or Hibernate mode while the card is inserted into the PC Card slot, your computer may not recognize the PC Card or the connected device. Restart the computer.

Why can't I insert my PC Card?

- ❑ Make sure you are inserting the card correctly. See **Inserting a PC Card (page 43)** for more information.
- ❑ You may not be able to use some PC Cards or some functions of the PC Card on your computer. See the manual that came with your PC Card for more information.

Audio/Video

What should I do if I cannot use my DV camcorder?

If the message appears to indicate DV equipment seems to be disconnected or turned off, the i.LINK cable may not be securely plugged into the ports on your computer or camcorder. Unplug the connectors, and plug them in again. See **Connecting an i.LINK Device (page 99)** for more information.



i.LINK is a trademark of Sony used only to designate that a product contains an IEEE 1394 connection. The procedure to establish an i.LINK connection may vary, depending on a software application, an operating system, and a compatible i.LINK device. Not all products with an i.LINK connection can communicate with each other. See the manual that came with your compatible i.LINK device for more information on operating conditions and proper connection. Before connecting compatible i.LINK PC peripherals to your system, such as a CD-RW or hard disk drive, confirm their operating system compatibility and required operating conditions.

Memory Stick Media

What should I do if I cannot open my image files?

You may need to reformat your Memory Stick media.

Formatting Memory Stick media erases all data, including music data previously saved on it. Before you reformat Memory Stick media, back up important data and confirm that the media does not contain files you want to keep.

- 1 Copy the data from the Memory Stick media onto your computer's hard disk to save data or images.
- 2 Format the Memory Stick media using the **Memory Stick Formatter** software preinstalled on your computer. For instructions about formatting a Memory Stick media, see the help file on the **Memory Stick Formatter** software.

Why can't I save music files onto my Memory Stick media?

Copyright protected music cannot be checked out to any Memory Stick media other than those with the MagicGate logo.

! Use of recorded music requires permission from the copyright holders.

Sony is not responsible for music files that cannot be recorded from a CD or downloaded from other sources.

Can I copy images from a digital camera using Memory Stick media?

Yes, and you can view video clips that you have recorded with Memory Stick media-compatible digital cameras.

Peripherals

What should I do if I cannot connect a USB device?

- ❑ If applicable, check the USB device is turned on and using its own power supply. For example, if you are using a digital camera, check the battery is charged. If you are using a printer, check the power cable is connected properly to the AC outlet.
- ❑ Try using another USB port on your computer. The driver could be installed to the specific port you used the first time you connected the device.
- ❑ See the manual that came with your USB device for more information. You may need to install software before you connect the device.
- ❑ Try connecting a simple, low-powered device such as a mouse to test if the port is working at all.
- ❑ USB hubs may prevent a device from working because of the distribution of power. We recommend you connect the device directly to your computer without a hub.

Docking Station

Why can't I use my TFT/DVI monitor connected to the DVI-D port?

The DVI-D port on the docking station is disabled when your computer is in STAMINA mode. Change the performance mode to SPEED mode and restart the computer. See **Selecting Performance Modes (page 104)** for mode selection.

Why does an error message appear when I press the UNDOCK button or select Undock Computer from the Start menu?

- ❑ When any device inserted or connected to the docking station is in use, you cannot disconnect your computer from the docking station. Save unsaved data, exit applications using such devices, and then try again.
If the above does not work, shut down your computer and disconnect it from the docking station.
- ❑ Make sure to return to the original log-on user before disconnecting your computer from the docking station. An attempt to disconnect it as any other user may cause malfunctions.
For switching users, see **Help and Support Center**.

Support Options

The section contains information on where to go for answers to questions about your computer and the preinstalled software.

Sony Support Information

See the following sources for answers in the sequence listed below.

1 VAIO Computer Documentation

This on-screen **User Guide** (this manual) and the printed **Welcome mat** provide detailed information on how to maximize your computer's capabilities and solve common problems.

2 Program Guides and Help Files

The preinstalled programs on your computer may be supplied with individual help guides. These guides are stored on the hard disk as on-screen help files. You can find the help files from the help menu under the specific program.

3 Operating System Online Support

Your computer comes preinstalled with a Microsoft Windows operating system. For operating system support, you can visit Microsoft customer support at: <http://support.microsoft.com/directory/>.

4 Sony Computing Support

This service provides instant access to information on commonly encountered problems. Type a description of the problem and the Knowledge Database searches for the corresponding solutions online. You can visit the Sony online support Web site at <http://esupport.sony.com/EN/VAIO/> for customers in USA, at <http://www.sony.ca/support> for customers in Canada, at <http://esupport.sony.com/ES/VAIO/> for customers in Latin American countries or areas, or at <http://esupport.sony.com/ES/VAIO/BR/> for customers in Brazil.

5 VAIO Update

When your computer is connected to the Internet, **VAIO Update** automatically notifies you when critical software and security information is posted on the support web site. Click the **VAIO Update** notice to open the VAIO Support web site and view the information.

For users in Latin American countries or areas

Customer Information Center

If you do not find the information you are looking for at our site, you may call Sony directly. In order to receive the fastest and most efficient services, please have the following information readily available:

1 Your VAIO computer model

You can find it at the lower right corner of the display on the laptops, and in the same place on the front panel of the CPU on the desktops.

2 Your computer's serial number

You can find it on the back or bottom of the laptop or on the back of the desktop; the serial number is the last 7 digits of the number below the barcode.

3 The operating system on your computer

4 The hardware component or the software program that is causing you the problem

5 A brief description of the problem

In order to contact a Sony technical support representative, please call the following numbers:

In Argentina:

(011) 6770-SONY (7669)

In Mexico:

In Mexico City: 5002-9819

In the Mexican Republic: 01-800-759-7669

In Colombia:

01-800-550-7000

In Peru:

0-801-1-7000 or 511-6100

In Chile:

Sony answers: 800-261-800

From cellular phones: 02-754-6333

In Venezuela:

0-800-1-SONY-00 (0-800-1-7669-00)

In Panama:

800-2050

In Brazil:

(11) 3677-1080

Program Support Information

Depending on the computer model and particular configuration you purchased, your computer may not include all of the software programs listed below.

Contacts for Sony software products are listed below:

- For users in USA
Web Site <http://esupport.sony.com/EN/VAIO/>
Telephone 888-4-SONY-PC (888-476-6972)
- For users in Canada
Web Site <http://www.sony.ca/support>
Telephone 888-4-SONY-PC (888-476-6972)
- For users in Latin American countries or areas
Web Site <http://esupport.sony.com/ES/VAIO/>
- For users in Brazil
Web Site <http://esupport.sony.com/ES/VAIO/BR/>

For contacts about third-party software products, see the following.

Adobe® Photoshop® Elements, Premiere®, Reader®

Adobe Systems Inc.

- For users in USA and Canada
Web Site <http://www.adobe.com/support>
Telephone 800-685-3652

America Online® (Dial-Up)

America Online, Inc.

- For users in USA and Canada
Web Site <http://www.aol.com>

AOL® Music Now

America Online, Inc.

- For users in USA and Canada
Web Site <http://www.premiumservices.aol.com>

AOL® Explorer

America Online, Inc.

- For users in USA and Canada
Web Site <http://www.aol.com>

AOL® Toolbar

America Online, Inc.

- For users in USA and Canada
Web Site <http://help.aol.com/help>

AOL® Instant Messenger™

America Online, Inc.

- For users in USA and Canada
Web Site <http://www.aim.com>

Ask Search Assistant

Ask Jeeves, Inc.

For contacts about the software, see **Program Support Information (page 215)**.

Ask Toolbar

Ask Jeeves, Inc.

For contacts about the software, see **Program Support Information (page 215)**.

Bluetooth® Utility

TOSHIBA Corporation

For contacts about the software, see **Program Support Information (page 215)**.

Cingular Connection Manager

Cingular Wireless

For contacts about the software, see **Program Support Information (page 215)**.

Click to DVD[®] software

Sony Electronics Inc.

At the touch of a button, Click to DVD software allows you to automatically burn DVDs from a digital video (DV) device. Create DVDs by capturing video content straight from a DV device or by importing video from stored files — and you can also edit the video. Create DVD photo albums and slide shows with picture files or by importing pictures from a digital still camera. What's more, you can give a professional look to your DVDs by adding chapter menus, backgrounds, and menu screens. You are only a few clicks away from your own DVDs!

For contacts about the software, see **Program Support Information** ([page 215](#)).

Digital Imaging Starter Edition

Microsoft Corp.

- For users in USA and Canada
Web Site <http://support.microsoft.com>

DISCover[™] My Games[™]

DISCover

- For users in USA and Canada
Web Site <http://www.discoverconsole.com>

DVgate Plus™ software

Sony Electronics Inc.

Connect a compatible digital video camera to your computer's i.LINK port and capture video clips and still images. Edit clips from your video, add new clips, and combine clips into new movie segments. Save your movies back to your digital video camera or in a variety of popular file formats.

For contacts about the software, see **Program Support Information (page 215)**.

Image Converter 2 Plus

Sony Electronics Inc.

Image Converter 2 Plus allows you to easily convert movie and picture files on your computer to your Memory Stick® media.

For contacts about the software, see **Program Support Information (page 215)**.

InstantOn

InterVideo, Inc.

- For users in USA and Canada
Web Site <http://www.intervideo.com/jsp/Support.jsp>

Intel® PROSet

Intel Corporation

- For users in USA and Canada
Web Site http://www.intel.com/network/connectivity/products/wireless/proset/proset_software.htm

Microsoft® Office Basic Edition, Office Professional Edition, Office Small Business Edition

Microsoft Corp.

- For users in USA and Canada
Web Site <http://support.microsoft.com>

60-Day Trial Version of Microsoft® Office 2003

! The Microsoft Office 2003 60-Day Trial software included with this computer system is intended for evaluation purposes only. The software has been installed and you must activate the software before you can use it. Product activation procedures will be detailed during initial launch of the software; activation requires Internet access. This software has an expiration date of 60 days from the date of first use, at which time the software will operate under reduced-functionality mode, limiting end-user options and operations.

Microsoft Corp.

- For users in USA and Canada
Web Site <http://support.microsoft.com>

Microsoft® Internet Explorer, Movie Maker, Media Player, Works

Microsoft Corp.

- For users in USA and Canada
Web Site <http://support.microsoft.com>

MobiTV®

MobiTV, Inc.

- For users in USA and Canada
Customer Support contact info:
Web Site www.mobitv.com/pctv/sv/faq
Telephone 877-795-5300

Netscape® Browser

America Online, Inc.

- For users in USA and Canada
Web Site <http://browser.netscape.com>

Norton Internet Security™

Symantec Corporation

- For users in USA and Canada
Web Site <http://www.symantec.com/techsupp>

PenPlus for VAIO®

Sony Electronics Inc.

PenPlus for VAIO will allow you to write or draw directly on the screen with the stylus or create "sticky note" reminders. For contacts about the software, see **Program Support Information (page 215)**.

Protector Suite QL

Sony Electronics Inc.

Protector Suite QL Edition allows you to easily setup your fingerprint sensor that comes with your computer. Protector Suite QL supports fingerprint logon, fast user switching, file encryption, registering forms and more.

For contacts about the software, see **Program Support Information (page 215)**.

Quicken® New User Edition

Intuit Inc.

- For users in USA and Canada
Web Site <http://www.intuit.com/support/quicken/>

ROXIO DigitalMedia®

Sonic Solutions

- For users in USA and Canada
Web Site <http://support.sonic.com/>

SmartDraw® Suite Edition 30 day trial

SmartDraw.com

- For users in USA and Canada
Web Site <http://www.smartdraw.com/support/index.htm>

SmartWi™ Connection Utility

Sony Electronics Inc.

SmartWi Connection Utility allows you to easily switch between the various wireless components (Wireless LAN, Wireless WAN, and Bluetooth technology connectivity) that came with your computer.

For contacts about the software, see **Program Support Information** ([page 215](#)).

SonicStage® software

Sony Electronics Inc.

The SonicStage jukebox software program gives you all the tools you need to manage music on your computer. SonicStage software supports high-quality digital audio storage, a sleek player skin design, and audio CD burning capability.

For contacts about the software, see **Program Support Information** ([page 215](#)).

SonicStage Mastering Studio™ software

Sony Electronics Inc.

Use SonicStage Mastering Studio software to record songs from analog records or cassette tapes into your computer and output them to CDs, DVDs, or audio files in WAV format.

For contacts about the software, see **Program Support Information** ([page 215](#)).

System Mechanic® 6

iolo technologies®, LLC

- ❑ For users in USA and Canada
Web Site <http://www.iolo.com/contactus.cfm>

Trend Micro™ Anti-Spyware

Trend Micro, Inc.

- ❑ For users in USA and Canada
Web Site <http://kb.trendmicro.com/search/default.asp>

Ulead BD DiscRecorder for VAIO® computers

Ulead Systems, Inc.

For questions and technical assistance, please check the help and the readme files.

VAIO® Action Setup

Sony Electronics Inc.

VAIO Action Setup manages the settings for your computer's shortcut keys.

For contacts about the software, see **Program Support Information (page 215)**.

VAIO® Back-up Utility

Sony Electronics Inc.

For contacts about the software, see **Program Support Information** ([page 215](#)).

VAIO® Camera Capture Utility

Sony Electronics Inc.

VAIO Camera Capture Utility is provided for capturing still images and movies with the external camera connected to a USB port or an i.LINK port on your computer or with the built-in MOTION EYE camera on your computer.

For contacts about the software, see **Program Support Information** ([page 215](#)).

VAIO® Camera Utility

Sony Electronics Inc.

VAIO Camera Utility provides you with various video quality settings when using the internal camera.

For contacts about the software, see **Program Support Information** ([page 215](#)).

VAIO® Central

Sony Electronics Inc.

VAIO Central provides a central location that gathers resources to configure your VAIO computer and view your computer's configuration and specifications.

For contacts about the software, see **Program Support Information** ([page 215](#)).

VAIO® Diagnostic

Sony Electronics Inc.

For contacts about the software, see **Program Support Information** ([page 215](#)).

VAIO® Edit Component

Sony Electronics Inc.

VAIO Edit Component provides enhanced editing functionality when using Adobe Premiere Pro or Adobe Premiere Elements on your VAIO computer.

For contacts about the software, see **Program Support Information** ([page 215](#)).

VAIO® HDD Protection

Sony Electronics Inc.

VAIO HDD Protection allows you to customize your settings for protecting your hard disk against shock hazards.

For contacts about the software, see **Program Support Information** ([page 215](#)).

VAIO Media™ software

Sony Electronics Inc.

VAIO Media™ software brings multimedia to your network, enabling you to share music, video, and still image files between your VAIO® computers. You can set up one or more VAIO computers as "media servers," which store your multimedia files and make them available to other compatible VAIO computers on your wired or wireless network.

For contacts about the software, see **Program Support Information** ([page 215](#)).

VAIO® Security Center

Sony Electronics Inc.

Sony cares about your VAIO personal computer. The VAIO Security Center highlights some of the security features your machine includes.

For contacts about the software, see **Program Support Information** ([page 215](#)).

VAIO® Support Central

Sony Electronics Inc.

VAIO Support Central provides an easy to navigate solution to common support needs, such as VAIO Documentation, product specifications, serial number, model name, service tag information, survey, registration, etc.

For contacts about the software, see **Program Support Information** ([page 215](#)).

VAIO® Touch Launcher

Sony Electronics Inc.

VAIO Touch Launcher allows you to run an application program or change the sound/display settings with the buttons on the launcher window.

For contacts about the software, see **Program Support Information** ([page 215](#)).

VAIO® Update

Sony Electronics Inc.

The VAIO Update utility helps you keep your VAIO® computer up to date by regularly checking the Sony online support Web site for important software updates and information for your specific VAIO computer model.

For contacts about the software, see **Program Support Information (page 215)**.

VAIO Zone™ software

Sony Electronics Inc.

VAIO Zone software provides an effortless way to browse and enjoy pictures, music, and video files on your computer, all through an elegant, next-generation interface. You can even enjoy media content stored on other VAIO® computers on your network. On VAIO computer models with a recordable DVD drive, VAIO Zone enables you to record video and slide shows of pictures to DVD. On VAIO computer models with a built-in TV tuner, VAIO Zone includes a complete personal video recorder, enabling you to record TV programs and burn them to DVD.

For contacts about the software, see **Program Support Information (page 215)**.

WinDVD® software for VAIO® computers

InterVideo, Inc.

- For users in USA and Canada

Web site <http://www.intervideo.com/jsp/Support.jsp>

Telephone 510-651-0888

Wireless Setup Utility

Sony Electronics Inc.

The Wireless Setup Utility walks you through setting up your wireless network connection and offers useful diagnostic tests to help keep your wireless network running smoothly.

For contacts about the software, see **Program Support Information (page 215)**.

Xdrive™

America Online, Inc.

For users in USA and Canada

Web Site <http://www.xdrive.com/support>

Zoom Utility

Sony Electronics Inc.

The Zoom Utility will allow you to magnify a portion of the screen.

For contacts about the software, see **Program Support Information (page 215)**.



Free Manuals Download Website

<http://myh66.com>

<http://usermanuals.us>

<http://www.somanuals.com>

<http://www.4manuals.cc>

<http://www.manual-lib.com>

<http://www.404manual.com>

<http://www.luxmanual.com>

<http://aubethermostatmanual.com>

Golf course search by state

<http://golfingnear.com>

Email search by domain

<http://emailbydomain.com>

Auto manuals search

<http://auto.somanuals.com>

TV manuals search

<http://tv.somanuals.com>