

Home Audio Docking System

Operating Instructions

FST-GTK2i

FST-GTK1i

RDH-GTK1i



WARNING

To reduce the risk of fire or electric shock, do not expose this apparatus to rain or moisture.

To reduce the risk of fire, do not cover the ventilation opening of the apparatus with newspapers, tablecloths, curtains, etc.

Do not place the naked flame sources such as lighted candles on the apparatus.

To reduce the risk of fire or electric shock, do not expose this apparatus to dripping or splashing, and do not place objects filled with liquids, such as vases, on the apparatus.

Do not expose batteries or apparatus with battery-installed to excessive heat such as sunshine, fire or the like.

Do not install the appliance in a confined space, such as a bookcase or built-in cabinet.

As the main plug is used to disconnect the unit from the mains, connect the unit to an easily accessible AC outlet. Should you notice an abnormality in the unit, disconnect the main plug from the AC outlet immediately.

The unit is not disconnected from the mains as long as it is connected to the AC outlet, even if the unit itself has been turned off.

The main switch is located on the rear exterior.

WARNING, heavy equipment. Use care when handling as it may cause injury.

For customers in the United States

Owner's Record

The model and serial numbers are located on the rear of the unit. Record these numbers in the space provided below. Refer to them whenever you call upon your Sony dealer regarding this product.

Model No. _____ Serial No. _____

These following indications are located on the rear exterior.



This symbol is intended to alert the user to the presence of uninsulated “dangerous voltage” within the product’s enclosure that may be of sufficient magnitude to constitute a risk of electric shock to persons.



This symbol is intended to alert the user to the presence of important operating and maintenance (servicing) instructions in the literature accompanying the appliance.

The following FCC statement applies only to the version of this model manufactured for sale in the U.S.A. Other versions may not comply with FCC technical regulations.

NOTE

This equipment has been tested and found to comply with the limits for a Class B digital device, pursuant to Part 15 of the FCC Rules. These limits are designed to provide reasonable protection against harmful interference in a residential installation. This equipment generates, uses, and can radiate radio frequency energy and, if not installed and used in accordance with the instructions, may cause harmful interference to radio communications. However, there is no guarantee that interference will not occur in a particular installation.

If this equipment does cause harmful interference to radio or television reception, which can be determined by turning the equipment off and on, the user is encouraged to try to correct the interference by one or more of the following measures:

- Reorient or relocate the receiving antenna.
- Increase the separation between the equipment and receiver.
- Connect the equipment into an outlet on a circuit different from that to which the receiver is connected.
- Consult the dealer or an experienced radio/TV technician for help.

CAUTION

You are cautioned that any changes or modifications not expressly approved in this manual could void your authority to operate this equipment.

Important Safety Instructions

- 1) Read these instructions.
- 2) Keep these instructions.
- 3) Heed all warnings.
- 4) Follow all instructions.
- 5) Do not use this apparatus near water.
- 6) Clean only with dry cloth.
- 7) Do not block any ventilation openings. Install in accordance with the manufacturer's instructions.

- 8) Do not install near any heat sources such as radiators, heat registers, stoves, or other apparatus (including amplifiers) that produce heat.
- 9) Do not defeat the safety purpose of the polarized or grounding-type plug. A polarized plug has two blades with one wider than the other. A grounding type plug has two blades and a third grounding prong. The wide blade or the third prong are provided for your safety. If the provided plug does not fit into your outlet, consult an electrician for replacement of the obsolete outlet.
- 10) Protect the power cord from being walked on or pinched particularly at plugs, convenience receptacles, and the point where they exit from the apparatus.
- 11) Only use attachments/accessories specified by the manufacturer.
- 12) Use only with the cart, stand, tripod, bracket, or table specified by the manufacturer, or sold with the apparatus. When a cart is used, use caution when moving the cart/apparatus combination to avoid injury from tip-over.



- 13) Unplug this apparatus during lightning storms or when unused for long periods of time.
- 14) Refer all servicing to qualified service personnel. Servicing is required when the apparatus has been damaged in any way, such as power-supply cord or plug is damaged, liquid has been spilled or objects have fallen into the apparatus, the apparatus has been exposed to rain or moisture, does not operate normally, or has been dropped.

Continued 

For customers in Australia



**Disposal of Old
Electrical &
Electronic
Equipment
(Applicable in the
European Union and
other European
countries with
separate collection
systems)**

On copyrights

iPod is a trademark of Apple Inc., registered in the U.S. and other countries.

“Made for iPod” means that an electronic accessory has been designed to connect specifically to iPod and has been certified by the developer to meet Apple performance standards.

Apple is not responsible for the operation of this device or its compliance with safety and regulatory standards.

“WALKMAN” and “WALKMAN” logo are registered trademarks of Sony Corporation.

MICROVAULT is a trademark of Sony Corporation.

MPEG Layer-3 audio coding technology and patents licensed from Fraunhofer IIS and Thomson.

Windows Media is a registered trademark of Microsoft Corporation in the United States and/or other countries.

All other trademarks and registered trademarks are trademarks or registered trademarks of their respective holders. In this manual, TM and [®] marks are not specified.

Table of Contents

Guide to parts and controls 5

Getting Started

Hooking up the system
securely 9

Operations

Listening to the radio 12
Listening to music of a USB
device 13
Playing the iPod 15
Using optional audio
components 16
Adjusting the sound 17
Controlling the Speaker Light
Illumination 17
Changing the display 18

Additional Information

Troubleshooting 18
Messages 22
Precautions 23
Specifications 23
Compatible USB devices with this
unit 26
Compatible iPod models with this
unit 27

Guide to parts and controls

This manual mainly explains operations using the buttons on the remote, but the same operations can also be performed using the buttons on the unit having the same or similar names.

Unit

- Front and back view

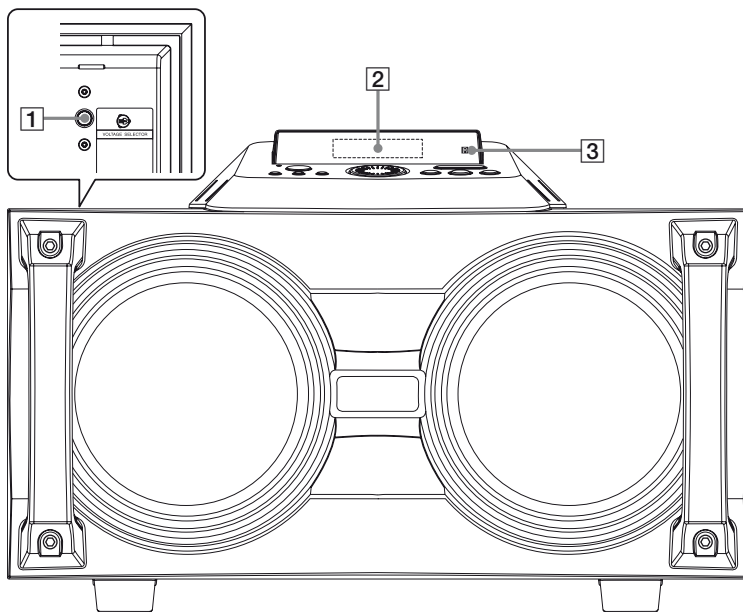

Continued 

- Top view

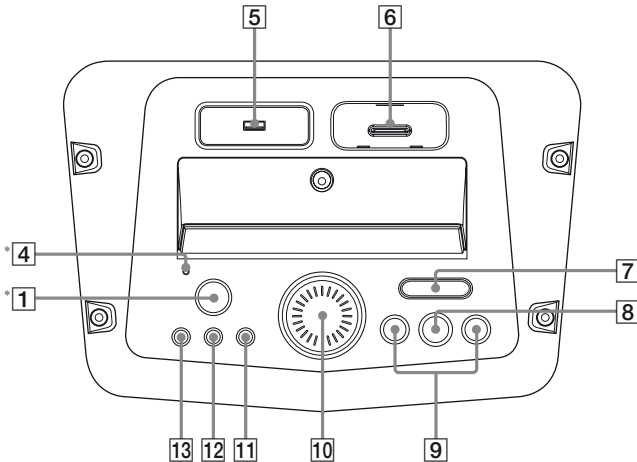

* Except North American model

- 1** On back panel: **POWER**
(page 10, 18, 19, 20, 21, 22)
Press to turn on or off the AC power.

Status of the **POWER** button



The unit is turned off.



(North American model)

The unit is turned on.

(Other models)

The unit is in standby mode.

On top panel: **I/⏻** (on/standby)
(except North American model)
(page 10, 19, 22)

Press to turn on the unit or set it to
standby mode.

- 2** Display (page 18)
3 Remote sensor (page 19)

- 4** Standby indicator (except North
American model)
Lights up when the unit is in standby
mode.

- 5**  (USB) port (page 13, 14, 19,
20, 22)
Connect an optional USB device.

- 6** iPod connector (page 11, 15, 16)
Place an optional iPod to listen to
audio contents stored in the iPod.

- 7** **FUNCTION** (page 12, 14, 15, 16)
Press to select a function.

- 8**  (play/pause) (page 12, 14,
15, 16, 20, 22)
Press to start or pause playback.
Press and hold to stop USB playback
or turn off the iPod.

- 9** ◀◀/▶▶ (rewind/fast forward) (page 14, 15)
Hold down to find a point in a track or file during playback.

◀◀/▶▶ (go backward/go forward) (page 14, 15)
Press to select a track or file.

TUNING +/- (page 12)
Press to tune in the station you want.

- 10** VOLUME (page 12, 14, 15, 16, 19)
Turn to adjust the volume.

- 11** SPEAKER LIGHT (North American model only) (page 17)
Press to turn on or off the speaker light when the unit is turned on.

DEMO/SPEAKER LIGHT (Other models) (page 17, 18)
Press to turn on or off the demo mode when the unit is in standby mode. Press to turn on or off the speaker light when the unit is turned on.

- 12** GROOVE (page 17, 22)
Press to reinforce the bass.
- 13** PRESET EQ (page 12, 17)
Press to select a preset sound effect.

Remote

- RM-AMU098 (North American model only)
- RM-AMU092 (Other models)

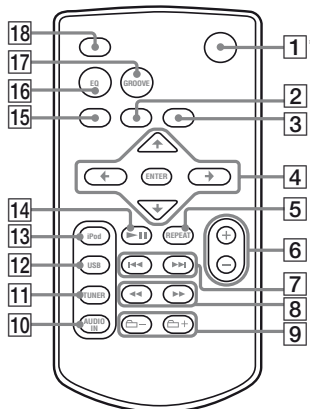



* RM-AMU092 only

- 1** I/⏻ (on/standby) (RM-AMU092 only) (page 10, 19)
Press to turn on the unit or set it to the standby mode.
- 2** TUNING MODE (page 12, 13)
Press to select the tuning mode.
- 3** FM MODE (page 12, 21)
Press to select the FM reception mode (monaural or stereo).
- 4** ⬆/⬇/⬅/➡, MENU (page 16)
Press to select the menu items on the iPod.
- ENTER (page 13, 16)
Press to enter the settings.
- 5** REPEAT (page 14)
Press to listen to a USB device, a folder, a single track or file repeatedly.

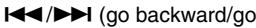
Continued ➤

- 6** VOLUME +/- (page 12, 14, 15, 16, 19)
Press to adjust the volume.
- 7**  (go backward/go forward) (page 14, 15)
Press to select a track or file.

+/- (tuning) (page 12, 13)
Press to tune in the station you want.
- 8**  (rewind/fast forward) (page 14, 15)
Hold down to find a point in a track or file during playback.
- 9**  +/- (page 14)
Press to select a folder.
- 10** AUDIO IN (page 16)
Press to select the AUDIO IN function.
- 11** TUNER/BAND (page 12)
Press to select the TUNER function.
Press to select the FM or AM band.
- 12** USB (page 14)
Press to select the USB function.
- 13** iPod (page 15)
Press to select the iPod function.
- 14**  (play/pause) (page 14, 15, 16, 20)
Press to start or pause playback.
Press and hold to stop USB playback or turn off the iPod.
- 15** TUNER MEMORY (page 12, 13)
Press to preset the radio station.
- 16** EQ (page 17)
Press to select a preset sound effect.
- 17** GROOVE (page 17)
Press to reinforce the bass.
- 18** DISPLAY (page 18)
Press to change the information on the display.

Hooking up the system securely

- Rear panel

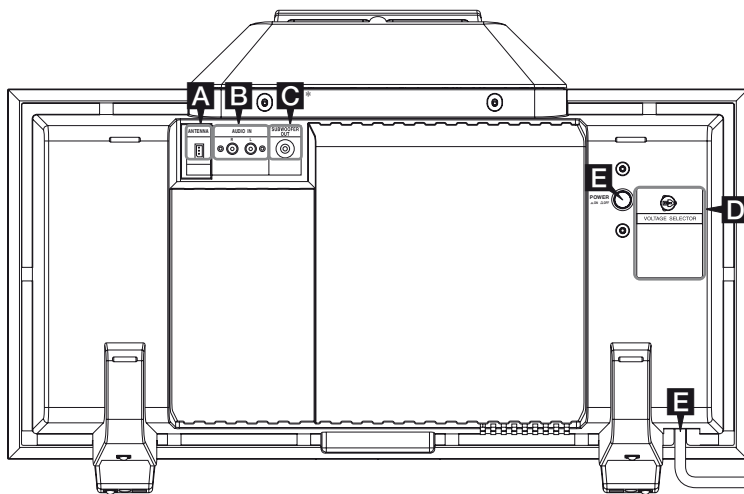

* FST-GTK2i only

A Antennas

Find a location and an orientation that provide good reception, and then set up the antennas.

Keep the antennas away from the power cord, the USB cable, the iPod and the subwoofer cable (FST-GTK2i only) to avoid picking up noise.

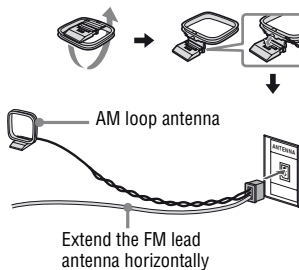

Continued 

B AUDIO IN L/R jacks

Use an audio cord (not supplied) to connect the audio output of the optional audio component to these jacks. You can then output audio through this unit.

C SUBWOOFER OUT jack (FST-GTK2i only)

Use a supplied subwoofer cable to connect the SUBWOOFER OUT jack on the unit and INPUT jack on the subwoofer.

Notes

- Be sure to use only the supplied subwoofer and subwoofer cable.
- Be sure to connect the subwoofer cable securely and correctly to the unit and the subwoofer.
- Do not connect other component to this jack.

D VOLTAGE SELECTOR

For models equipped with a voltage selector, set VOLTAGE SELECTOR to the local power line voltage. Depending on the model, the VOLTAGE SELECTOR may differ.

E Power

Connect the power cord to a wall outlet. Press the POWER on the back panel to turn on the AC power.

If the supplied adaptor on the plug does not fit your wall outlet, detach it from the plug (only for models equipped with an adaptor).

(Except North American model)

The demonstration appears in the display. When you press **I/⏻**, the unit turns on and the demonstration automatically ends.

Using the subwoofer

(FST-GTK2i only)

You can use the subwoofer to enhance the bass.

Make sure the subwoofer cable is connected before using the subwoofer.

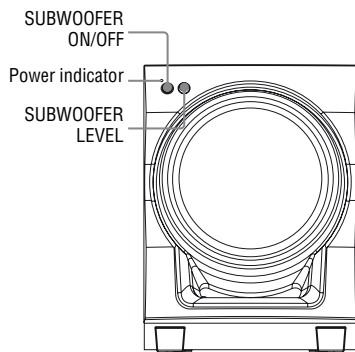

- 1** Connect the power cord of the subwoofer to a wall outlet.
- 2** Press SUBWOOFER ON/OFF on the subwoofer.
The subwoofer turns on and the power indicator lights up.
- 3** Turn SUBWOOFER LEVEL on the subwoofer to adjust the level.

Notes

- Place the subwoofer vertically to obtain a better bass reproduction.
- Position the subwoofer
 - on a solid floor where resonance is unlikely to occur.
 - at least a few centimeters away from the wall.
 - away from the center of the room or place a bookshelf against a wall, to avoid generating a standing wave.

Inserting the iPod Dock Adapter

Insert the iPod Dock Adapter (not supplied) into the iPod connector on the unit before you connect the iPod. Use a Dock Adapter supplied with your iPod. Otherwise, a compatible Dock Adapter will need to be purchased separately from Apple Inc.

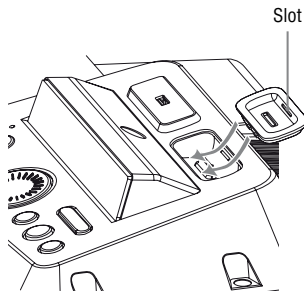

To remove the iPod Dock Adapter, pull it up with your fingernail or a flat object using the slot inside the adapter.

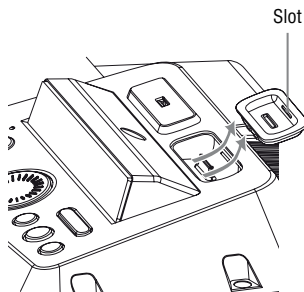

Using the remote

Slide and remove the battery compartment lid, and insert the two supplied R03 (size AAA) batteries,  side first, matching the polarities shown below.

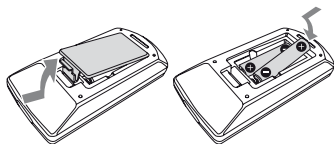

Notes

- Do not mix an old battery with a new one or mix different types of batteries.
- If you do not use the remote for a long period of time, remove the batteries to avoid damage from battery leakage and corrosion.
- With normal use, the batteries should last for about six months. When the remote no longer operates the unit, replace both batteries with new ones.
- Batteries installed devices shall not be exposed to excessive heat such as sunshine, fire or the like.

Operations

Listening to the radio

1 Select FM or AM band.

Press TUNER/BAND (or FUNCTION on the unit) repeatedly.

2 Perform tuning.

For automatic scanning

Press TUNING MODE repeatedly until "AUTO" lights up in the display, and then press +/- (or TUNING +/- on the unit).

Scanning stops automatically when a station is tuned in, and then "TUNED" and "ST" (for FM stereo programs only) lights up in the display.



If "TUNED" does not light up and the scanning does not stop, press +/- (or TUNING +/- on the unit) to stop scanning, then perform manual tuning.

For manual tuning

Press TUNING MODE repeatedly until "AUTO" and "PRESET" disappear from the display, and then press +/- (or TUNING +/- on unit) repeatedly to tune in the station you want.

3 Adjust the volume.

Press VOLUME +/- (or turn VOLUME on the unit).

To change the AM tuning interval

The factory setting for AM tuning interval is 9 kHz (or 10 kHz for some areas).

Use the buttons on the unit for the operation.

1 Press FUNCTION repeatedly to select AM band.

2 Press and hold ►|| and PRESET EQ at the same time for about 5 seconds.

"9K STEP" or "10K STEP" appears in the display.

When you change the interval, all the AM preset stations are erased.

Tip

To improve broadcast reception, adjust the supplied antennas.

To reduce static noise on a weak FM stereo station

Press FM MODE repeatedly until "MONO" lights up in the display.

There will be no stereo effect, but the reception will improve.

Presetting radio stations

You can preset your favourite radio stations and tune them in instantly by selecting the corresponding preset number.

Use the buttons on the remote for this operation.

1 Tune in the station you want.

2 Press TUNER MEMORY.

A preset number flashes in the display. The stations are stored from preset number 1.



Preset number

3 Press +/- repeatedly to select the preset number you want.

If another station is already assigned to the selected preset number, the station is replaced by the new station.

4 Press ENTER.

“COMPLETE” appears in the display. The station is stored.

5 Repeat steps 1 to 4 to store other stations.

You can preset up to 20 FM and 10 AM stations.

6 To call up a preset radio station, press TUNING MODE repeatedly until “PRESET” lights up in the display. Then, press +/- repeatedly to select the preset number you want.

To cancel presetting

Press TUNER MEMORY.

Listening to music of a USB device

You can listen to music stored in the USB device by connecting it to the  (USB) port on the unit.

The audio formats that can be played back by this unit are as follows:

MP3*/WMA*/AAC*

* Files with copyright protection (Digital Rights Management) cannot be played back by this unit. Files downloaded from an online music store may not be played back by this unit.

Before using the USB device with this unit

- See “Compatible USB devices with this unit” (page 26) for a list of USB devices that can be connected to this unit.
- Operation may not always be ensured even when using these USB devices.
- When USB cable connection is necessary, connect the USB cable supplied with the USB device to be connected. Refer to the operating instructions supplied with the USB device to be connected for details on the operation method.
- Do not connect the unit and the USB device through a USB hub.
- When the USB device is connected, “READING” appears and “USB MEMORY” lights up in the display.
- It may take about 10 seconds before “READING” appears depending on the type of USB device connected.
- When the USB device is connected, the unit reads all the files on the USB device. If there are many folders or files on the USB device, it may take a long time to finish reading the USB device.
- The unit can recognize up to
 - 100 folders (including “ROOT” folder).
 - 100 audio files for each folder.
 - 8 folder levels (tree structure of files, including “ROOT” folder).

The maximum number of audio files and folders may vary depending on the file and folder structure.

Do not save other types of files or unnecessary folders on a USB device.

Continued 

- Compatibility with all encoding/writing softwares, recording devices, and recording media cannot be guaranteed. Incompatible USB device may produce noise or interrupted audio or may not play at all.

1 Press USB (or FUNCTION on the unit repeatedly).

2 Connect an optional USB device to the  (USB) port on the unit.

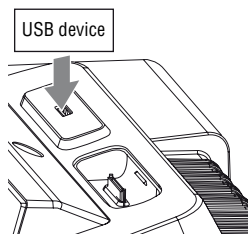













When the USB device is connected, the display changes as follows:
“READING” → “1”

3 Press  to start playback.

4 Press VOLUME +/- (or turn VOLUME on the unit) to adjust the volume.

Other operations

To	Do this
Pause playback	Press  . To resume playback, press the button again*.
Stop playback	Press and hold  for 2 seconds or more. Resume play is canceled.
Select a folder	Press  +/- repeatedly.
Select a file	Press   (or   on the unit) repeatedly.

To	Do this
Find a point in a file	Hold down   (or   on the unit) during playback, and release the button at the point you want.
Select Repeat Play	Press REPEAT repeatedly until “REP”, “  REP” or “REP1” lights up in the display.

* When playing a VBR (variable bit rate) audio file, the unit may resume playback from a different point.

Notes on the USB device

- Some time may be needed to start playback when:
 - the folder structure is complex.
 - the memory capacity is excessive.
- This unit does not necessarily support all the functions provided in a connected USB device.
- The playback order for the unit may differ from the playback order of the connected USB device.
- Folders that have no audio files are skipped.
- The unit can play the following format of audio files:
 - MP3 with file extension “.mp3”.
 - AAC with file extension “.m4a”, “.3gp”, “.mp4”.
 - Windows Media Audio (WMA) with file extension “.wma”.
 If the audio files have the above file extension but are not the respective formats, the unit may produce noise or may malfunction.
- When playing a very long track, some operations may cause playback delay.

Note on Repeat Play

All files on a USB device are repeated until you pause or stop playback.

Playing the iPod

You can listen to audio contents stored in the iPod on this unit.

Update your iPod with the latest software before using it.

1 Press iPod (or FUNCTION on the unit repeatedly).

2 Place the iPod.

Note

If your iPod has a protect case, we recommend you to remove the protect case before you place the iPod onto the unit.

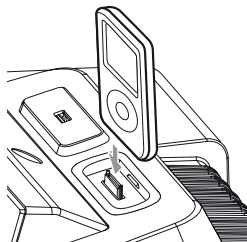

3 Press ►|| to start playback.

4 Press VOLUME +/- (or turn VOLUME on the unit) to adjust the volume.

Notes

- When you connect an iPod to the unit, the iPod is automatically turned on if the unit is turned on.
- When placing or removing the iPod
 - handle the iPod in the same angle as that of the iPod connector on the unit and do not twist or sway the iPod to prevent connector damage.
 - brace the unit with one hand and take care not to press the controls of the iPod by mistake.
- Before carrying the unit, be sure to disconnect the iPod.
- Before disconnecting the iPod, pause playback.

- Depending on the connected iPod, you may not be able to use ◀◀ or ▶▶ while playing video. In this case, you can fast rewind or fast forward by holding down ◀◀ or ▶▶.
- To change the volume level, use VOLUME +/- (or turn VOLUME on the unit). The volume level does not change even if adjusted on the iPod.
- This iPod connector is designed for iPod only. Do not connect any other portable audio players to the iPod connector.
- To use an iPod, refer to the operating instructions of your iPod.
- Sony cannot accept responsibility in the event that data recorded to iPod is lost or damage when using an iPod with this unit.
- Some iPod operations may not be performed using buttons on the unit or remote.
- Depending on the connected iPod, operations may differ.

Other operations

You can control your iPod using the buttons on the remote or unit. The following buttons have the similar function with the buttons on the iPod (except for iPod Touch).

To	Do this
Pause playback	Press ► . To resume playback, press the button again.
Select a track or chapter of audiobook/podcast	Press ◀◀ or ▶▶ (or ◀◀◀◀ or ▶▶▶▶ on the unit) repeatedly.
Locate a point while listening to the music (fast forward/fast rewind)	Hold down ◀◀ or ▶▶ (or ◀◀◀◀ or ▶▶▶▶ on the unit) during playback, then release it at the point you want.
Locate a point while viewing the iPod display (except for iPod Touch)	Hold down ◀◀ or ▶▶ (or ◀◀◀◀ or ▶▶▶▶ on the unit) when playback is paused, then release it at the point you want.

Continued 

To	Do this
Select the iPod menu item	Press MENU and \uparrow/\downarrow to select a menu, then press ENTER or \rightarrow .
	Note You can confirm menu and item selections on the iPod display during operation.
Return to previous menu	Press MENU or \leftarrow .
Turn off the iPod	Hold down $\blacktriangleright\parallel$.

Tip

Press and hold \uparrow or \downarrow on the remote has the similar function of turning the Click Wheel on the iPod counterclockwise or clockwise.

To use the unit as a battery charger

You can use the unit as a battery charger for the iPod when the unit is on. The charging begins when the iPod is placed on the iPod connector. The charging status appears in the iPod display. For details, refer to the operating instructions of your iPod.

To stop charging the iPod

Remove the iPod.

Using optional audio components

You can enjoy the sound from an optional audio component through the speakers of this unit.

Be sure to turn off the power of the component before making any connections.

For details, refer to the operating instructions supplied with the connected component.

- 1 Connect an optional audio component to the AUDIO IN L/R jacks using an audio cord (not supplied).**
- 2 Turn on the unit and the connected component.**
- 3 Press VOLUME – repeatedly (or turn VOLUME on the unit counterclockwise) to turn down the volume.**
- 4 Press AUDIO IN (or FUNCTION on the unit repeatedly).**
- 5 Start playing the connected component.**
The sound from the connected component is output from the speakers of this unit.
- 6 Press VOLUME +/- (or turn VOLUME on the unit) to adjust the volume.**

Adjusting the sound

To add a sound effect

To	Do this
Reinforce the bass and create a more powerful sound	Press GROOVE repeatedly to select "GROOVE"*.
Select the preset sound effect	Press EQ (or PRESET EQ on the unit) repeatedly to select the preset effect you want. The preset effect name appears in the display. To cancel the effect, press EQ (or PRESET EQ on the unit) repeatedly to select "FLAT".

* The volume switches to power mode and the equalizer curve changes.

Controlling the Speaker Light Illumination

You can turn on or off the speaker light when the unit is turned on.

Use the button on the unit for the operation.

(North American model only)
Press SPEAKER LIGHT repeatedly.

(Other models)
Press DEMO/SPEAKER LIGHT repeatedly.

Each time you press the button, the display changes as follows:

LIGHT ON* ↔ OFF

* The speaker light will create lighting effect according to the music source.

Changing the display

Changing the display mode

(Except North American model)
Press DEMO/SPEAKER LIGHT on the unit repeatedly while the unit is in standby mode.

Demonstration

The demo display appears and the speaker light flashes even when the unit is set to standby mode.

No display

The demo display and speaker light are turned off.

Viewing the display information

Press DISPLAY repeatedly while the unit is turned on.

You can view the USB device information as follows:

- track or file number
- track name (“🎵”)
- file name (“📄”)
- artist name (“👤”)
- album name (“📀”)
- folder name (“📁”)

Notes on the display information

- Characters that cannot be displayed appear as “-”.
- The following are not displayed correctly:
 - elapsed playing time of a file encoded using a VBR (variable bit rate).
 - folder and file names that do not follow either the ISO9660 Level 1, Level 2 or Joliet in the expansion format.

Additional Information

Troubleshooting

Should you encounter a problem with your system, do the following:

- 1 Make sure the power cord and subwoofer cable (FST-GTK2i only) are connected correctly and firmly.
- 2 Find your problem in the troubleshooting checklist below and take the indicated corrective action.

If the problem persists after doing all of the above, consult your nearest Sony dealer.

Note that if service personnel changes some parts during repair, these parts may be retained.

If “PROTECT” appears on the display

Immediately press POWER on the back panel to turn off the unit and unplug the power cord. Then perform the following items.

- Remove anything that is blocking the ventilation hole.
- If your unit has a voltage selector, set the voltage selector to the correct voltage.
- Disconnect the USB device and iPod.
- Disconnect audio cord from the AUDIO IN L/R jacks.

After checking the above items and fixing any problems, plug in the power cord again and turn on the unit. If the “PROTECT” still appears, or if the cause of the problem cannot be found even after checking all the above items, consult your nearest Sony dealer.

General

(Except North American model)

The display starts flashing as soon as you plug in the power cord even though you have not pressed I/⏻ to turn on the unit.

- The demonstration mode started. Press I/⏻ (page 10).

There is no sound.

- Make sure you press the POWER on the back panel.
- Press VOLUME + repeatedly (turn VOLUME clockwise on the unit).

There is severe hum or noise.

- Move the unit away from the source of noise.
- Connect the unit to a different wall outlet.
- Install a noise filter (commercially available) to the power cord.
- Turn off surrounding electrical equipment.

The remote does not function.

- Remove the obstacles between the remote and the unit.
- Move the remote closer to the unit.
- Point the remote at the unit's sensor.
- Replace the batteries.
- Move the unit away from the fluorescent light.
- Place the USB device and iPod to the port/connector firmly.

(FST-GTK2i only)

There is no sound from the subwoofer.

- Adjust the subwoofer level to the appropriate level.
- Check that the subwoofer cable and power cord are connected securely and correctly.
- Make sure you have turned on the subwoofer by pressing SUBWOOFER ON/OFF on the subwoofer.

USB device

Are you using a supported USB device?

- If you connect an unsupported USB device, the following problems may occur. See "Compatible USB devices with this unit" (page 26) for the supported device types.
 - The USB device is not recognized.
 - File or folder names are not displayed on this unit.
 - Playback is not possible.
 - The sound skips.
 - There is noise.
 - A distorted sound is output.

"OVER CURRENT" appears.

- A problem has been detected with the level of electrical current from the ⚡ (USB) port. Press POWER on the back panel to turn off the unit and remove the USB device from the ⚡ (USB) port. Make sure there is no problem with the USB device. If this display pattern persists, contact your nearest Sony dealer.

There is no sound.

- The USB device is not connected correctly. Press POWER on the back panel to turn off the unit and reconnect the USB device, then turn on the unit and check if "USB MEMORY" lights up in the display.

There is noise, skipping, or distorted sound.

- Press POWER on the back panel to turn off the unit and reconnect the USB device, then turn on the unit.
- The music data itself contains noise, or the sound is distorted.

Continued 

The USB device cannot be connected into the  (USB) port.

- The USB device is being connected backwards. Connect the USB device in the correct orientation.

“READING” is displayed for an extended time, or it takes a long time before playback starts.

- The reading process can take a long time in the following cases.
 - There are many folders or files on the USB device.
 - The file structure is extremely complex.
 - The memory capacity is excessive.
 - The internal memory is fragmented.Thus, we recommend following these guidelines.
 - Total folders on USB device: 100 or less (including “ROOT” folder)
 - Total files per folder: 100 or less

Erroneous display.

- The data stored in the USB device may have been corrupted.
- The character codes that can be displayed by this unit are as follows:
 - Upper cases (A to Z)
 - Numbers (0 to 9)
 - Symbols (' < > * + , - . / @ [\] _ `)Other characters may not be displayed correctly.

The USB device is not recognized.

- Press POWER on the back panel to turn off the unit and reconnect the USB device, then turn on the unit.
- Connect the supported USB device (page 26).
- The USB device does not work properly. Refer to the USB device operating instruction on how to deal with this problem.

Playback does not start.

- Press POWER on the back panel to turn off the unit and reconnect the USB device, then turn on the unit.
- Connect the supported USB device (page 26).
- Press  to start playback.

Audio file cannot be played back.

- MP3 files in MP3 PRO format cannot be played back.
- The audio file is a multiple track audio file.
- Some AAC files may not be played back correctly.
- WMA files in Windows Media Audio Lossless and Professional format cannot be played back.
- USB device formatted with file systems other than FAT16 or FAT32 are unsupported.*
- If you use partitioned USB device, only audio files on the first partition can be played back.
- Playback is possible up to 8 levels (including “ROOT” folder).
- The number of folders has exceeded 100 (including “ROOT” folder).
- The number of files in a folder has exceeded 100.
- Files that are encrypted or protected by passwords, etc. cannot be played back.

* This unit supports FAT16 and FAT32, but some USB device may not support all of these FAT. For details, refer to the operating instruction of each USB device or contact the manufacturer.

iPod

If the iPod does not operate properly, check that you have removed the protect case of the iPod. If the problem persists, use the following troubleshooting guide to remedy the problem.

There is no sound.

- Make sure the iPod is connected securely.
- Make sure the iPod is playing music.
- Adjust the volume.
- Depending on the contents of the iPod, it may take time to start playback.
- You are using an unsupported iPod. See “Compatible iPod models with this unit” (page 27) for the supported device types.

The sound is distorted.

- Reduce the volume.
- Set the “EQ” setting of the iPod to “Off” or “Flat”.

The iPod cannot be operated.

- Disconnect the iPod and connect the iPod again.
- You are using an unsupported iPod. See “Compatible iPod models with this unit” (page 27) for the supported device types.

The iPod cannot be charged.

- Make sure you press the POWER on the back panel.
- Make sure the iPod is connected securely.

“OVER CURRENT” appears.

- A problem has been detected with the level of electrical current from the iPod. Press POWER on the back panel to turn off the unit and remove the iPod. Make sure there is no problem with the iPod. If this display pattern persists, contact your nearest Sony dealer.

Tuner

Severe hum or noise, or stations cannot be received. (“TUNED” or “ST” flashes in the display)

- Set the proper band and frequency (page 12).
- Connect the antenna properly (page 9).
- Find a location and an orientation that provide good reception, then set up the antenna again.
- The supplied FM lead antenna receives signals along its entire length, so make sure you extend it fully.
- Keep the antennas away from the power cord, the USB cable, the iPod and subwoofer cable (FST-GTK2i only) to avoid picking up noise.
- Consult your nearest Sony dealer if the supplied AM antenna has come off the plastic stand.
- Turn off nearby electrical equipment.

A stereo FM program cannot be received in stereo.

- Press FM MODE repeatedly until “MONO” disappears from the display.

Optional components

There is no sound.

- See general item “There is no sound.” (page 19) and check the condition of the unit.
- Connect the component properly (page 9) while checking:
 - if the cords are connected properly.
 - if the cord plugs are firmly inserted all the way.
- Turn on the connected component.
- Refer to the operating instructions supplied with the connected component and start playing.

Continued 

To reset the unit to factory settings

If the unit still does not operate properly after performing the above measures or other troubles not described above occur, reset the unit as follows:

Use the buttons on the unit for the operation.

- 1 Press POWER on the back panel to turn off the AC power.
- 2 Press POWER again to turn on the AC power.
- 3 (Except North American model) Press I/⏻ to turn on the unit.
- 4 Press and hold ►|| and GROOVE at the same time for about 5 seconds.
“RESET” appears in the display.

The unit is reset to the factory settings. You need to readjust all the settings you made, such as the preset stations.

Messages

One of the following messages may appear or flash in the display during operation.

COMPLETE

The radio preset operation ended normally.

DEVICE ERROR

The memory of the USB device could not be recognized (page 19).

NoDEVICE

No USB device is connected.

NO TRACK

No playable audio file is loaded in the unit.

NO ARTIST

Playable file on the USB device do not has artist information.

NOT SUPPORT

An unsupported USB device is connected, an unknown device is connected, or the USB device is connected through a USB hub (page 26).

OVER CURRENT

An over current from the  (USB) port or iPod was detected.

PROTECT

The following causes can be considered:

- The ventilation holes may be blocked.
- The voltage selector may not be set to the correct local power line voltage.

See “If “PROTECT” appears on the display” (page 18) to check what to do if this message appears.

READING

The unit is reading information of the USB device.

Precautions

On safety

- Completely disconnect the power cord (mains lead) from the wall socket (mains) if it is not going to be used for an extended period of time. When unplugging the unit, always grip the plug. Never pull the cord itself.
- Should any solid object or liquid get into the system, unplug the system, and have it checked by qualified personnel before operating it again.
- (For customers in United States and Canada only)
One blade of the plug is wider than other for the purpose of safety and will fit to the wall outlet only one way. If you are unable to insert the plug fully into the outlet, contact your dealer.
- The AC power cord can be changed only by a qualified service facility.

On placement

- Do not place the system in an inclined position or in locations that are extremely hot, cold, dusty, dirty, or humid or lacking adequate ventilation, or subject to vibration, direct sunlight or a bright light.
- Be careful when placing the unit or subwoofer on surfaces that have been specially treated (for example, with wax, oil, polish) as staining or discoloration of the surface may result.

On heat buildup

- Heat buildup on the unit during operation is normal and is not a cause for alarm.
- Do not touch the cabinet if it has been used continuously at a high volume because the cabinet may have become hot.
- Do not obstruct the ventilation holes.

On the speaker system

This speaker system is not magnetically shielded, and the picture on nearby TV sets may become magnetically distorted. In this situation, turn off the TV, wait 15 to 30 minutes, and turn it back on. If there is no improvement, move the speakers far away from the TV.

Cleaning the cabinet

Clean this system with a soft cloth slightly moistened with a mild detergent solution. Do not use any type of abrasive pad, scouring powder, or solvent, such as thinner, benzene, or alcohol.

Specifications

AUDIO POWER SPECIFICATIONS

POWER OUTPUT AND TOTAL HARMONIC DISTORTION:

RDH-GTK1i USA model only

With 6-ohm loads, both channels driven, from 120 Hz – 10 kHz; rated 30 watts per channel minimum RMS power, with no more than 0.7% total harmonic distortion from 250 miliwatts to rated output.

Amplifier section

FST-GTK2i

The following are measured at
AC 127 V, 60 Hz

Front speaker:

Power Output (rated)

35 W + 35 W (at 6 Ω , 1 kHz, 1% THD)

RMS output power (reference)

110 W + 110 W (per channel at 6 Ω ,
1 kHz)

Subwoofer:

RMS output power (reference)

230 W (8 Ω , 100 Hz)

FST-GTK1i and RDH-GTK1i

North American model only

The following are measured at
AC 120 V, 60 Hz

Front speaker:

RMS output power (reference)

110 W + 110 W (per channel at 6 Ω ,
1 kHz)

Continued 

Brazilian model only

The following are measured at
AC 127 V or 220 V, 60 Hz

Front speaker:

RMS output power (reference)
75 W + 75 W (per channel at 6 Ω ,
1 kHz, 10% THD)

Other models

The following are measured at

Mexican model:
AC 127 V, 60 Hz

Other models:
AC 120, 220, 240 V, 50/60 Hz

Front speaker:

Power Output (rated)
35 W + 35 W (at 6 Ω , 1 kHz, 1% THD)

RMS output power (reference)
110 W + 110 W (per channel at 6 Ω ,
1 kHz)

Input

AUDIO IN L/R:
Voltage 1 V, impedance 47 kilohms

Output

SUBWOOFER OUT (FST-GTK2i only)

Tuner section

FM stereo, FM/AM superheterodyne tuner

Antenna:
FM lead antenna
AM loop antenna

FM tuner section

Tuning range
North American and Brazilian models:
87.5 MHz – 108.0 MHz (100 kHz step)
Other models:
87.5 MHz – 108.0 MHz (50 kHz step)

Intermediate frequency
225 kHz

AM tuner section

Tuning range

Pan American and Oceanian models:
530 kHz – 1,710 kHz (with 10 kHz
tuning interval)

531 kHz – 1,710 kHz (with 9 kHz
tuning interval)

Other models:
530 kHz – 1,610 kHz (with 10 kHz
tuning interval)

531 kHz – 1,602 kHz (with 9 kHz
tuning interval)

Intermediate frequency
53 kHz

USB section

Supported bit rate*
MP3 (MPEG 1 Audio Layer-3):
32 kbps – 320 kbps, VBR
WMA: 48 kbps – 192 kbps
AAC: 48 kbps – 320 kbps
* Compatibility with all encoding/
writing software, recording devices
and recording media cannot be
guaranteed.

Sampling frequencies
MP3 (MPEG 1 Audio Layer-3):
32 kHz/44.1 kHz/48 kHz
WMA: 44.1 kHz
AAC: 44.1 kHz

Transfer speed
Full-speed
Supported USB device
Mass Storage Class

Maximum current
500 mA

iPod section

DC5V 500 mA MAX

Speakers

Unit

HCD-GTK2i (for FST-GTK2i)/

HCD-GTK1i (for FST-GTK1i/

RDH-GTK1i)

Speaker system

2-way, coaxial

Speaker unit

Woofer: 160 mm (6 1/2 in), cone type

Tweeter: 40 mm (1 5/8 in), cone type

Rated impedance

6 ohms

Subwoofer

SA-WGTK2i (for FST-GTK2i)

Subwoofer system

1-way, 1-driver, Bass reflex

Speaker unit

Subwoofer: 200 mm (8 in), cone type

Rated impedance

8 ohms

General

Power requirements

North American model: AC 120 V,

60 Hz

Oceanian model: AC 230 V – 240 V,

50/60 Hz

Mexican model: AC 127 V, 60 Hz

Brazilian model: AC 127 V or 220 V,

60 Hz, adjustable with voltage selector

Argentina model: AC 220 V, 50/60 Hz

Other models: AC 120 V, 220 V or

230 V – 240 V, 50/60 Hz, adjustable

with voltage selector

Power consumption

HCD-GTK2i/HCD-GTK1i: 150 W

SA-WGTK2i: 200 W

Dimensions (w/h/d) (Approx.)

HCD-GTK2i/HCD-GTK1i:

600 mm × 385 mm × 395 mm

(23 5/8 in × 15 1/4 in × 15 5/8 in)

SA-WGTK2i:

320 mm × 435 mm × 420 mm

(12 5/8 in × 17 1/4 in × 16 5/8 in)

Mass (Approx.)

HCD-GTK2i/HCD-GTK1i:

12.5 kg (27 lb 9 oz)

SA-WGTK2i:

11.5 kg (25 lb 6 oz)

Supplied accessories

Remote Commander:

- RM-AMU098 (North American model only) (1)

- RM-AMU092 (other models) (1)

FM lead/AM loop antenna (1)

R03 (size AAA) batteries (2)

Subwoofer cable (FST-GTK2i only) (1)

Design and specifications are subject to change without notice.

Compatible USB devices with this unit

You can use the following Sony USB devices on this unit. Other USB devices cannot be used on this unit.

Verified Sony USB device

Product name	Model name
Walkman®	NWZ-B133 / B135 / B133F / B135F
	NWZ-B142 / B143 / B142F / B143F
	NWD-E023F / E025F
	NWZ-E435F / E436F / E438F
	NWZ-E343 / E344 / E345
	NWZ-S636F / S638F / S639F
	NWZ-S736F / S738F / S739F
	NWZ-A726 / A728 / A729 / A726B / A728B
	NWZ-A826 / A828 / A829
	NWZ-W202
	NWZ-X1050 / X1060
	NWZ-S744 / S745
	NWZ-E443 / E444 / E445
	NWZ-S544 / S545
	NWZ-A845 / A846 / A847
	NWZ-W252 / W253
NWZ-B152F / B153F	

Product name	Model name
IC Recorder	ICD-UX71 / UX81 / UX91
	ICD-SX68 / SX78 / SX88
	ICD-SX700 / SX800 / SX900
	ICD-UX200 / UX300 / UX400
	ICD-SX750 / SX850 / SX950
MICROVAULT	USM1GL / 2GL / 4GL / 8GL / 16GL
	USM1GLX / 2GLX / 4GLX / 8GLX / 16GLX

Notes

- The unit is unable to read data in NTFS format.
- The unit is unable to read data other than that saved in the first partition of a hard disk drive.
- Do not use USB devices other than these USB devices. Operation of models not listed here is not guaranteed.
- Operation may not always be ensured even when using these USB devices.
- Some of these USB devices may not be available for purchase in certain areas.
- When formatting the above models, be sure to format using the model itself or the dedicated formatting software for that model.
- Please do not connect iPod to USB port.
- When connecting a USB device to the unit, be sure to connect after the display "Creating Library" or "Creating Database" on the USB device has disappeared.

Compatible iPod models with this unit

You can use the following iPod models on this unit. Update your iPod with the latest software before using it.



iPod nano
5th generation
(video camera)



iPod touch
2nd generation



iPod nano
4th generation
(video)



iPod touch
1st generation



iPod nano
3rd generation
(video)



iPod classic



iPod nano
2nd generation
(aluminum)



iPod
5th generation
(video)



iPod nano
1st generation



iPod
4th generation
(color display)



iPod
4th generation



iPod mini

Notes

- This unit is designed for iPod only. You cannot connect any other portable audio players.
- Sony cannot accept responsibility in the event that data recorded to iPod is lost or damaged when using an iPod connected to this unit.
- Use a Dock Adapter supplied with your iPod. Otherwise, a compatible Dock Adapter will need to be purchased separately from Apple Inc.
- This product has been designed specifically to work with iPod and has been certified to meet Apple performance standards.
- This unit is not compatible with iPhone.



* 4 1 8 6 8 7 2 1 1 * (2)

Free Manuals Download Website

<http://myh66.com>

<http://usermanuals.us>

<http://www.somanuals.com>

<http://www.4manuals.cc>

<http://www.manual-lib.com>

<http://www.404manual.com>

<http://www.luxmanual.com>

<http://aubethermostatmanual.com>

Golf course search by state

<http://golfingnear.com>

Email search by domain

<http://emailbydomain.com>

Auto manuals search

<http://auto.somanuals.com>

TV manuals search

<http://tv.somanuals.com>