

SONY

3-756-465-22 (1)

CD Radio Cassette-Corder

CFD-10
CFD-12

Operating Instructions

COMPACT
disc
DIGITAL AUDIO

MEGA BASS

© 1993 by Sony Corporation

WARNING

To prevent fire or shock hazard, do not expose the unit to rain or moisture.

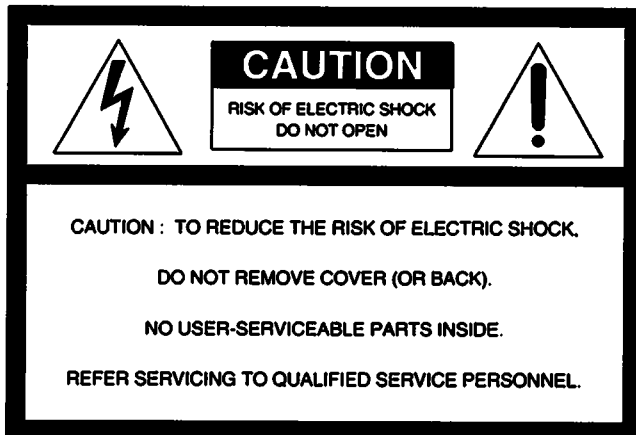

This symbol is intended to alert the user to the presence of uninsulated "dangerous voltage" within the product's enclosure that may be of sufficient magnitude to constitute a risk of electric shock to persons.



This symbol is intended to alert the user to the presence of important operating and maintenance (servicing) instructions in the literature accompanying the appliance.

CAUTION

The use of optical instruments with this product will increase eye hazard.

For customers in Canada

To prevent electric shock, do not use this polarized AC plug with an extension cord, receptacle or other outlet unless the blades can be fully inserted to prevent blade exposure.

Information

For customers in the United States

This equipment has been tested and found to comply with the limits for a Class B digital device, pursuant to Part 15 of the FCC Rules. These limits are designed to provide reasonable protection against harmful interference in a residential installation. This equipment generates, uses, and can radiate radio frequency energy and, if not installed and used in accordance with the instructions, may cause harmful interference to radio communications. However, there is no guarantee that interference will not occur in a particular installation. If this equipment does cause harmful interference to radio or television reception, which can be determined by turning the equipment off and on, the user is encouraged to try to correct the interference by one or more of the following measures:

- Reorient or relocate the receiving antenna.
- Increase the separation between the equipment and receiver.
- Connect the equipment into an outlet on a circuit different from that to which the receiver is connected.
- Consult the dealer or an experienced radio/TV technician for help.

You are cautioned that any changes or modifications not expressly approved in this manual could void your authority to operate this equipment.

Owner's Record

The model and serial numbers are located at the bottom of the CD radio cassette-corder. Record these numbers in the spaces provided below. Refer to these numbers whenever you call your Sony dealer regarding this product.

Model No. _____ Serial No. _____

Table of Contents

About This Manual 4
Precautions 4

Setting Up

Choosing Power Sources 5
Adjusting the Sound Emphasis 5

Operations

Listening to the Radio 6
Playing a CD (normal play) 7
Playing Specific Tracks 8
Playing the Beginning of Each Track (intro scan) 8
Playing Tracks Repeatedly 9
Playing Tracks in the Desired Order (program play) 10
Playing a Tape 11
Recording 11
Setting Up a P-A System 12

For Your Information

Maintenance 13
Specifications 14
Troubleshooting Guide 15

About This Manual

Thank you for purchasing the Sony CFD-10/12 CD Radio Cassette-Corder. The instructions in this manual are for the CFD-10 and CFD-12. Before you start reading, check your model number. The CFD-12 is the model used for illustration purposes. The difference between the CFD-10 and the CFD-12 is that the CFD-12 has the MEGA BASS feature. This difference in operation is clearly indicated in the text, for example, "CFD-12 only".

Differences in appearance

CFD-10

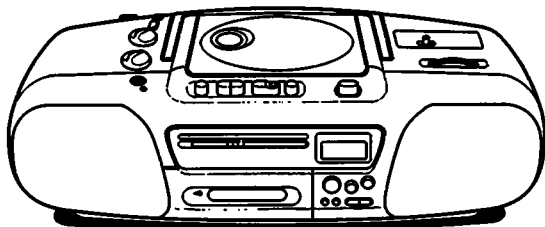

CFD-12

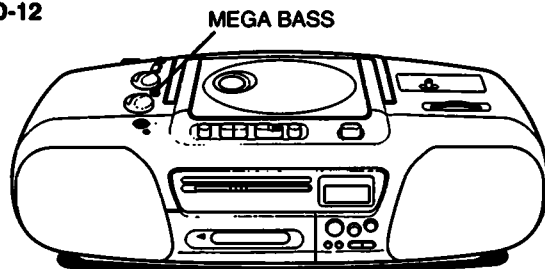

Precautions

On power sources

- For AC operation, use the supplied AC power cord; do not use any other type.
- For battery operation, use six size D (R20) batteries.
- Unplug the unit from the wall outlet when it is not to be used for an extended period of time.
- When the operational batteries are not to be used, remove them to avoid damage that can be caused by battery leakage or corrosion.
- The nameplate indicating operating voltage, power consumption, etc. is located at the bottom.

On safety

- As the laser beam used in the CD player section is harmful to the eyes, do not attempt to disassemble the casing. Refer servicing to qualified personnel only.
- Should any solid object or liquid fall into the unit, unplug the unit, and have it checked by qualified personnel before operating it any further.

On placement

- Do not leave the unit in a location near heat sources, or in a place subject to direct sunlight, excessive dust or mechanical shock.

On operation

- If the unit is brought directly from a cold to a warm location, or is placed in a very damp room, moisture may condense on the lens inside the CD player section. Should this occur, the player will not operate properly. In this case, remove the CD and wait about an hour for the moisture to evaporate.
- If the unit has not been used for a long time, set it in the playback mode to warm it up for a few minutes before inserting a CD or cassette.

Note on using a cassette with more than 90 minutes of play time

The use of a cassette with more than 90 minutes of play time is not recommended except for long, continuous recording or playback.

If you have any questions or problems concerning your unit, please consult your nearest Sony dealer.

Choosing Power Sources

The CD cassette-corder has two separate power sources. Use the AC power source (house current) whenever you record because recording consumes the most power. Use six size D (R20) batteries when the CD cassette-corder becomes a portable.

Operating the player on AC power

Insert one end of the supplied power cord to the AC IN socket located at the rear of the player ❶ and the other end to the wall outlet ❷.

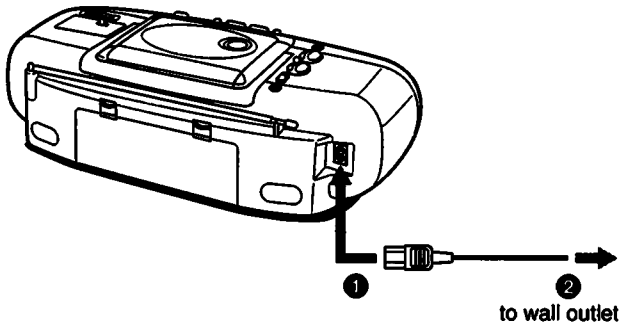

Operating the player on batteries

To play your CD cassette-corder on batteries, the AC power cord must be disconnected from the unit. Unplug the unit and insert six size D (R20) batteries (not supplied) in the compartment.

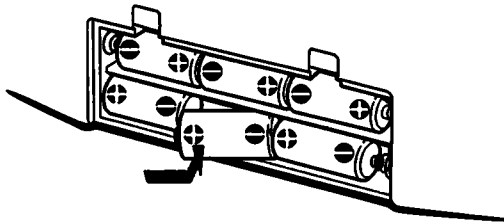

When to replace the batteries

Replace the batteries when the OPR/BATT indicator dims or when the unit stops operating.

When the batteries are weak, replace all the batteries with new ones.

Adjusting the Sound Emphasis

When playing CDs, tapes, or radio programs, use the MEGA BASS button (CFD-12 only) to reinforce the bass sound. You can also adjust the tone.

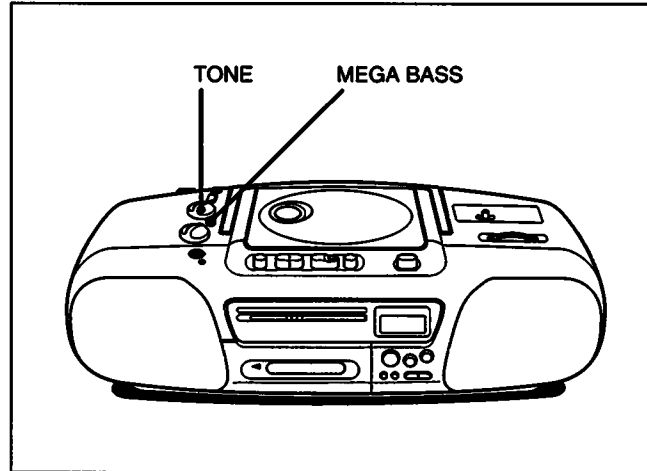

To adjust the tone

Turn the TONE control.

Turn the control clockwise to enhance the high tone and counterclockwise to enhance the low tone.

To reinforce the bass sound (CFD-12 only)

Press MEGA BASS.

To resume sound, press MEGA BASS again.

Note on MEGA BASS

The MEGA BASS system contains the Dynamic Bass Boost (DBB) circuit. The DBB varies the amount of boost in the low frequency range depending on the volume control, producing a deep and powerful bass sound. It is most effective at low volume level.

Listening to the Radio

Whenever you want to listen to the radio, set the FUNCTION selector to RADIO.

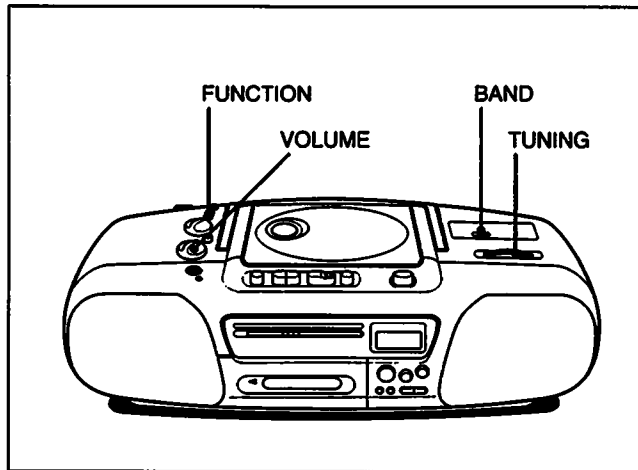

- 1** Set FUNCTION to RADIO.

- 2** Set BAND to AM or FM.

- 3** Turn TUNING to tune in a radio station.

If the received FM stereo is too weak, the reception becomes monaural.

- 4** Turn VOLUME to adjust the volume.

To turn off the radio

Set the FUNCTION selector to TAPE.

To improve broadcast reception

Reorient the antenna (for FM) or the unit itself (for AM).

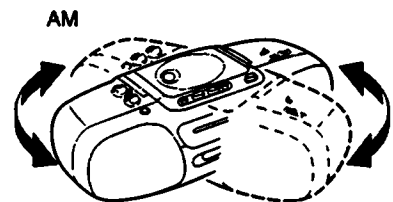
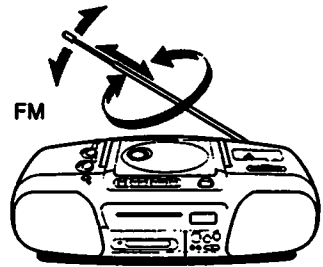

Playing a CD (normal play)

You can play 12 cm (5 inch) and 8 cm (3 inch) CDs without an adaptor.

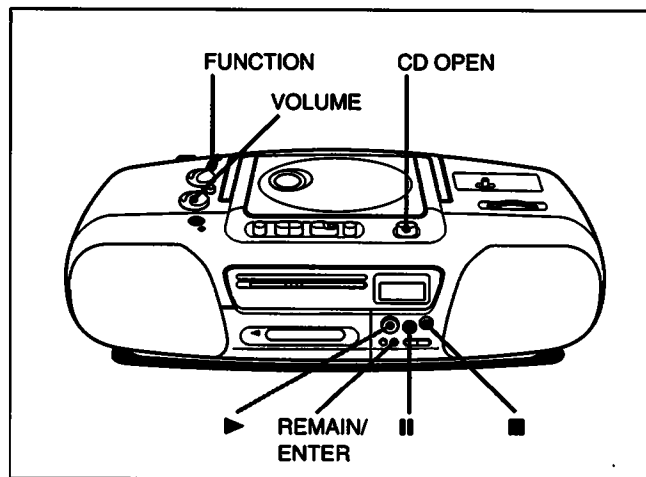

- 1 Set **FUNCTION** to CD.
If there is no disc in the compartment "00" appears in the display window.

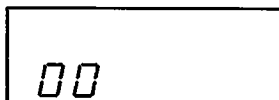

- 2 Press **CD OPEN** to open the disc compartment.

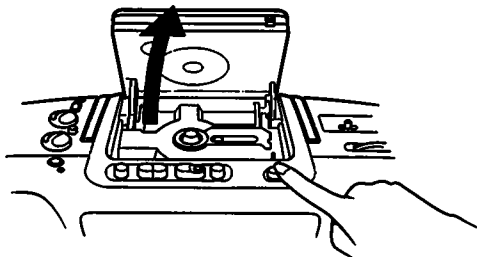

- 3 Holding the CD by the edge, place the CD in the disc compartment with the label side up.



- 4 Close the compartment lid.
The number of tracks on the disc and the total playing time appear in the display window.

- 5 Press **▶** (play).
The CD player will play all the tracks once. The track number and playing time appear in the display window.

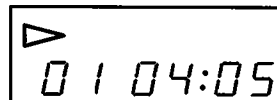

Between tracks, the remaining time before the next track is displayed.

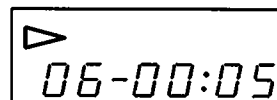

- 6 Turn **VOLUME** to adjust the volume.
(Be careful not to turn up the volume excessively while listening to a portion with very low audio input. If you do, the speakers may be damaged when a peak level plays.)

To	Press
Stop play	■
Pause	
Resume play after pause	
Remove the CD	First ■, then CD OPEN
Turn off the power	Set FUNCTION to TAPE

Checking the remaining time

To display	Press
Remaining time on the current track	REMAIN/ENTER once during playing

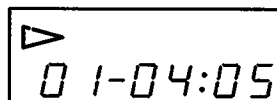

Remaining time on the CD and the number of tracks left	REMAIN/ENTER twice during playing
--	-----------------------------------

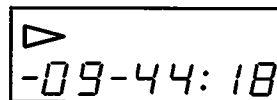

Notes

- If the disc has more than 21 tracks, the remaining time appears as "-----".
- During repeat play or program play, the remaining time in the disc cannot be displayed even if you press **REMAIN/ENTER**.

Playing Specific Tracks

You can find the beginning of a track or a point in a track while the player is playing or paused. Find a particular track by specifying the track number.

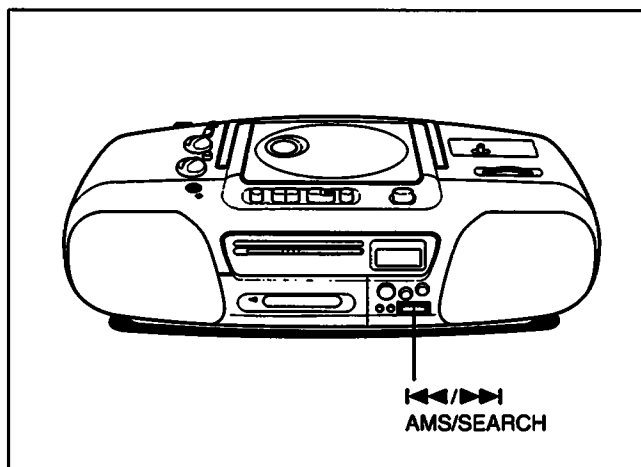

To find the beginning of a track

To find	Press*
the beginning of the current track	◀◀ once
the beginning of the previous tracks	◀◀ repeatedly
the beginning of the next track	▶▶ once
the beginning of the succeeding tracks	▶▶ repeatedly

* If one of the following indications is displayed, press the ■ (stop) button to clear the indication: INTRO, REPEAT 1, REPEAT ALL, REPEAT SHUFFLE, REPEAT PGM MEM, PGM MEM.

To find a point in a track

To Search	Press down
by listening for the point you want to hear	◀◀ or ▶▶ in play mode
by observing the time counter	◀◀ or ▶▶ in pause mode

Playing the Beginning of Each Track (intro scan)

You can sample the first 10 seconds of each track on a CD.

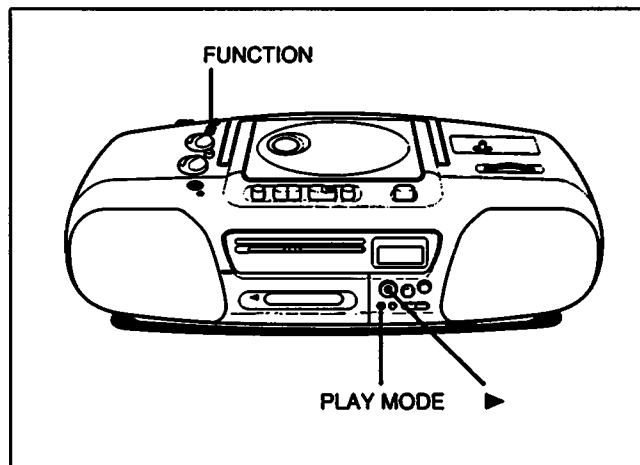

1 Set FUNCTION to CD.

2 Press PLAY MODE once to display "INTRO" while the player is stopped.



3 Press ▶ (play).
The first track plays for ten seconds. The player then skips to the next track to be played.

To start playing a track

Press ▶ (play) again.

To cancel intro scan

Press any button for CD operation except REMAIN/ENTER and PAUSE.

Playing Tracks Repeatedly

You can play tracks repeatedly in normal, shuffle or program play (page 10) modes. In shuffle play, the tracks play in a different order each time. Repeat only one track or all the tracks.

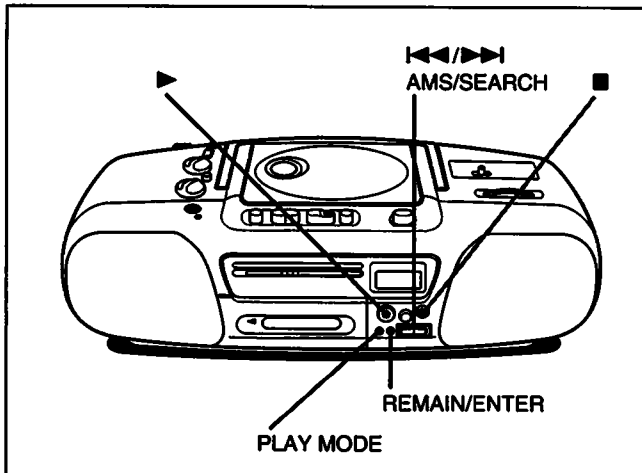

Repeating a single track

- 1 Press PLAY MODE until "REPEAT 1" appears in the display window.

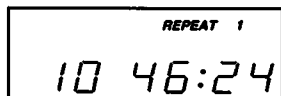

- 2 Choose the track you would like repeated with \lll/\ggg AMS/SEARCH.

- 3 Press \blacktriangleright (play).
The track selected plays repeatedly.

Repeating all the tracks

- 1 Press PLAY MODE until "REPEAT ALL" appears in the display window.



- 2 Press \blacktriangleright (play).
The player begins playing at the first track. When all the tracks have played once, the player starts playing from the first track again.

Repeating tracks in random order

- 1 Press PLAY MODE until "REPEAT SHUFFLE" appears in the display window.

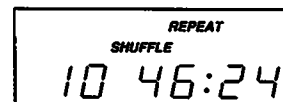

- 2 Press \blacktriangleright (play).
The player plays all the tracks repeatedly in different orders.

Note

When you press \lll , the CD returns to the beginning of the current track only.

Repeating programmed tracks

- 1 Press PLAY MODE until "REPEAT PGM MEM" appears in the display window.



- 2 Choose a track with \lll/\ggg AMS/SEARCH.

- 3 Press REMAIN/ENTER to store the track.

- 4 Repeat steps 2 and 3 to program tracks in the order you want them played.
Up to 34 tracks can be programmed.

- 5 Press \blacktriangleright (play).
"MEM" disappears from the display window and play starts.

To	Press
Stop play	\blacksquare (stop)
Cancel repeat play	PLAY MODE until no indication appears in the display window

Playing Tracks in the Desired Order (program play)

Program the CD cassette-corder to play tracks in any order you choose.

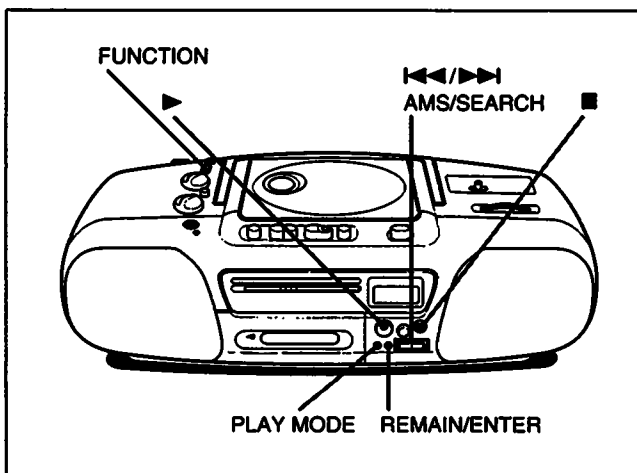

1 Set FUNCTION to CD.

2 Press PLAY MODE until "PGM MEM" appears in the display window.

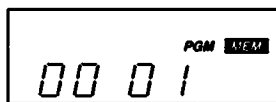

3 Choose a track with I◀▶I AMS/SEARCH.

4 Press REMAIN/ENTER to store the track.

5 Repeat steps 3 and 4 to program tracks in the order you want them played.
Up to 34 tracks can be programmed.

6 Press ▶ (play).
"MEM" disappears from the display window and play starts.

To	Press
Stop play	■ (stop)
Cancel program play	PLAY MODE until no indication appears in the display window

To change the order of the tracks

To change the order of the tracks, you must erase the current program and create a new one.

To erase the current program

Press ■ (stop) once or open the disc compartment if the CD is stopped. The current program will be erased.

Follow the steps in *Playing tracks in the Desired Order* to create a new program.

Playing a Tape

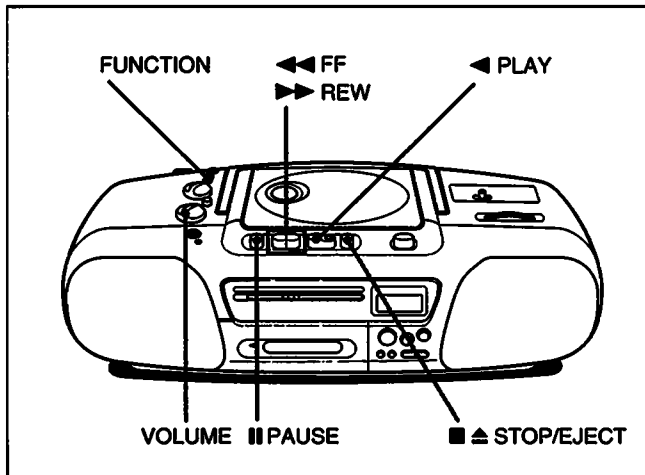

1 Set FUNCTION to TAPE.

2 Press ■▲ STOP/EJECT to open the tape compartment. Insert a recorded tape with the side you want to play facing forward. Close the compartment.

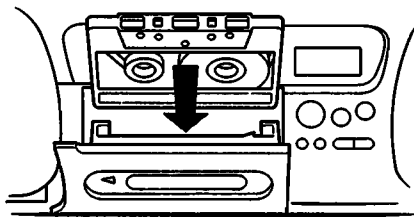

3 Press ◀ PLAY to start playing.

4 Turn VOLUME to adjust the volume.

To	Press
Stop play	■▲ STOP/EJECT
Pause	PAUSE
Resume play after pause	PAUSE
Fast forward*	◀◀ FF
Rewind*	▶▶ REW
Remove the cassette	■▲ STOP/EJECT

* For the side facing forward.

Recording

Whenever you record, we recommend you operate the CD cassette-corder on house current instead of using batteries because recording consumes a lot of battery power. We recommend you use TYPE I (normal) tape (printed on the tape cassette).

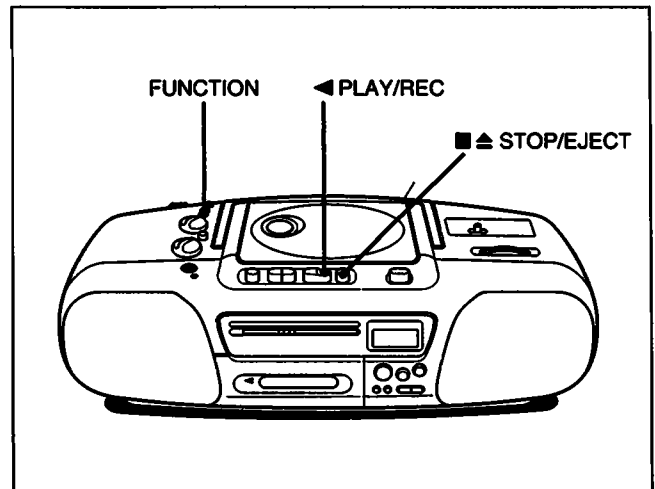

1 Set FUNCTION to RADIO or CD.

To record from	Do
the radio	Tune in the desired radio station.
a CD	Insert the CD.

2 Press ■▲ STOP/EJECT and put a blank tape into the tape compartment with the side you want to record on facing forward.

3 Press REC.
◀ PLAY will depress automatically and recording starts.

The recording level is adjusted automatically

Adjusting the volume, tone or MEGA BASS (CFD-12 only) will not affect the recording level.

To stop recording

Press ■▲ STOP/EJECT.

Continued on next page.

Saving a tape permanently

To prevent a tape from being accidentally recorded over, break off the cassette tab from side A or B as illustrated. If you later want to reuse the tape for recording, cover the broken tab with adhesive tape.

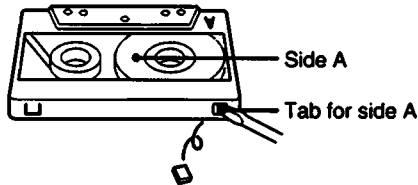

To erase a recording

- 1 Disconnect the microphone if connected at the (microphone) jack.
- 2 Set FUNCTION to TAPE.
- 3 Press REC.

You can use the CD cassette-corder as a public address system. Also mix sounds by adding your voice or other audio through the microphone as you record. Use a monaural microphone with mini-plug (not supplied).

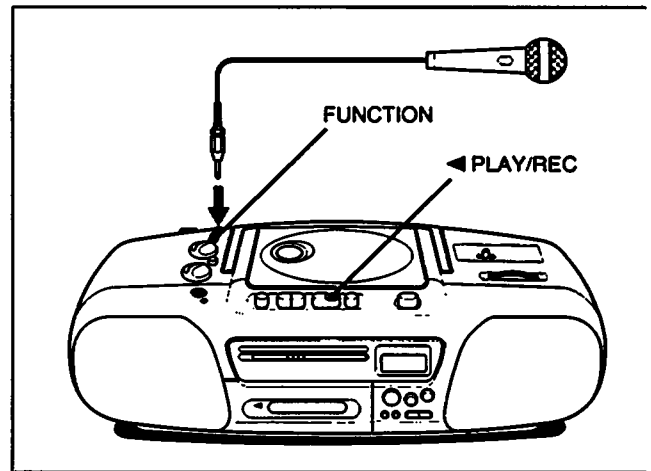

- 1 Plug the microphone into the (microphone) jack and turn on the microphone .

- 2 Set FUNCTION to choose a sound source.

To	Set to
Use the CD cassette-corder as a public address system	CD
Mix sound	CD, TAPE or RADIO

- 3 Sing or speak into the microphone and adjust the volume.

To record mixed sounds

Insert a tape (TYPE I) and press REC. The recording level is adjusted automatically.

Notes on the microphone

If acoustic feedback (howling) occurs, turn down the volume or move the microphone away from the speakers. We do not recommend you use a microphone that has an echo function.

Maintenance

Cleaning the lens

If the lens becomes dirty, it may cause a skipping of sound during CD operation. Clean with a commercially available blower.

Cleaning the tape heads and tape path

Contaminated heads cause poor recording or sound drop-out in playback. We recommend cleaning after every 10 hours of operation. To make the best possible recording, however, you should clean all surfaces over which tape travels before each recording.

Wipe the heads, the pinch roller and the capstan with a cleaning swab slightly moistened with cleaning fluid or alcohol.

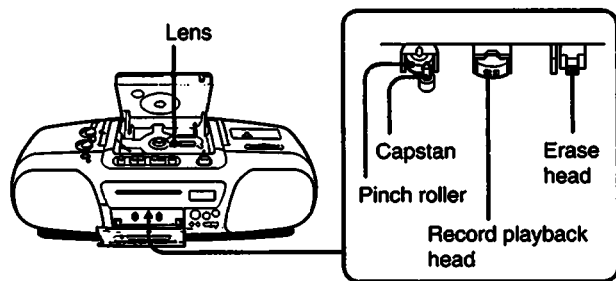

After cleaning the heads, roller and the tape path, insert a tape when the areas cleaned are completely dry.

Demagnetizing the tape heads

After 20 to 30 hours of use, enough residual magnetism will have built up on the heads to begin to cause loss of high frequency sound and hiss. At this time, you should demagnetize the heads and all metal parts in the tape path with a commercially available tape head demagnetizer.

Cleaning the cabinet

Clean the cabinet, panel and controls with a soft cloth slightly moistened with a mild detergent solution. Do not use any type of abrasive pad, scouring powder or solvent, such as alcohol or benzene.

Notes on Compact Discs

- Before playing, clean the CD with a cleaning cloth. Wipe the CD from the center out.



- Do not use solvents such as benzene, thinner, commercially available cleaners or anti-static spray intended for vinyl LPs.
- Do not expose the CD to direct sunlight or heat sources such as hot air ducts, nor leave it in a car parked in direct sunlight as there can be a considerable rise in temperature inside the car.
- After playing, store the CD in its case.

If there is a scratch, dirt or fingerprints on the CD, it may cause tracking error.

Specifications

AUDIO POWER SPECIFICATIONS

POWER OUTPUT AND TOTAL HARMONIC DISTORTION

With 3.2-ohm loads, both channels driven from 150-10,000 Hz; rated 2.3 W per channel-minimum RMS power, with no more than 10 % total harmonic distortion in AC operation.

Other Specifications

CD player section

System	Compact disc digital audio system
Laser diode properties	Material: GaAlAs Wave length: 780 nm Emission duration: Continuous Laser output: Less than 44.6 μ W (This output is the value measured at a distance of about 200 mm from the objective lens surface on the optical pick-up block.)
Spindle speed	200 r/min (rpm) to 500 r/min (rpm) (CLV)
Error correction	Sony Refined Super Strategy Cross Interleave Reed Solomon Code
Number of channels	2
Frequency response	20–20,000 Hz \pm 2 dB
Wow and flutter	Below measurable limit

Radio section

Frequency range	FM: 87.6–108 MHz AM: 530–1,710 kHz
Antennas	FM: Telescopic antenna AM: Built-in ferrite bar antenna

Cassette-corder section

Recording system	4-track 2-channel stereo
Frequency response	TYPE I (normal) cassette: 70–10,000 Hz

General

Speaker	Full range: 10 cm dia., 3.2 ohms cone type
Inputs	Mixing microphone input jack (minijack): Sensitivity 2.5 mV For low impedance microphone
Outputs	Headphones jack (stereo minijack) For 16–68 ohms impedance headphones
Power output (excluding US model)	2.3 W + 2.3 W (at 3.2 ohms, 10% harmonic in DC operation)

Power requirements	240 V AC, 50 Hz (Australian model) 120 V AC, 60 Hz (Other models) DC 9 V, 6 size D (R20) batteries												
Power consumption	20 W												
Battery life	For CD radio cassette-corder: <table><thead><tr><th></th><th>FM recording</th><th>Tape playback</th><th>CD playback</th></tr></thead><tbody><tr><td>Sony SUM-1 (NS)</td><td>approx. 13.5 h</td><td>approx. 7.5 h</td><td>approx. 2.5 h</td></tr><tr><td>Sony Alkaline AM1</td><td>approx. 19 h</td><td>approx. 12 h</td><td>approx. 4.5 h</td></tr></tbody></table>		FM recording	Tape playback	CD playback	Sony SUM-1 (NS)	approx. 13.5 h	approx. 7.5 h	approx. 2.5 h	Sony Alkaline AM1	approx. 19 h	approx. 12 h	approx. 4.5 h
	FM recording	Tape playback	CD playback										
Sony SUM-1 (NS)	approx. 13.5 h	approx. 7.5 h	approx. 2.5 h										
Sony Alkaline AM1	approx. 19 h	approx. 12 h	approx. 4.5 h										

Dimensions	Approx. 501.5 \times 156 \times 238 mm (w/h/d) (19 $\frac{1}{2}$ \times 6 $\frac{1}{4}$ \times 9 $\frac{1}{2}$ in.) incl. projecting parts
Mass	4.4 kg (9 lb 11 oz) (incl. batteries)
Supplied accessories	AC power cord (1)

Design and specifications subject to change without notice.

Optional accessories

Sony DYNAMIC MICROPHONE series
Sony MDR stereo headphone series
Head demagnetizer HE-5C
CD cleaner XP-CD7

Troubleshooting Guide

Symptom

Remedy

General

- The power does not come on.
 - Connect the AC power cord securely.
 - Insert the batteries with the correct polarity, *p. 5*.
 - Replace the batteries with new ones if they are weak, *p. 5*.
 - There's no audio.
 - Make sure the FUNCTION selector is set to the function you want to operate.
 - Adjust the volume.
 - Unplug the headphones when listening through speakers.
-

Radio

- The audio is weak or poor quality.
 - Replace all the batteries with new ones if they are weak, *p. 5*.
 - Move the unit away from the TV.
 - The picture of the TV is unstable.
 - If you are listening to an FM program near the TV with an indoor antenna, move the unit away from the TV.
-

CD Player

- The CD does not play.
 - Make sure the disc compartment is closed.
 - Place the CD with the label facing up.
 - Clean the CD, *p. 13*.
 - Take out the CD and leave the disc compartment open for about an hour to dry moisture condensation.
 - Make sure the FUNCTION selector is set to CD.
 - The sound drops out.
 - Reduce the volume.
 - Clean the CD, or replace it if the CD is badly damaged.
 - Place the player in a location free from vibration.
-

Tape Player

- The tape does not move when you press an operation button.
 - Close the cassette compartment.
- The REC button does not function.
 - Make sure the safety tab of the cassette is in place, *p. 12*.
 - Make sure the FUNCTION selector is set to CD or RADIO.
- The tape does not erase completely.
 - Clean the erasing heads.
 - Replace all the batteries with new one if they are weak, *p. 5*.
- The tape does not record.
 - Make sure the tape is inserted properly.
 - Make sure the safety tab of the cassette is in place, *p. 12*.
- The audio is weak.
 - Clean the heads, pinch roller and capstan, *p. 13*.
- The audio quality is poor.
 - Demagnetize the heads using a demagnetizer, *p. 13*.

Free Manuals Download Website

<http://myh66.com>

<http://usermanuals.us>

<http://www.somanuals.com>

<http://www.4manuals.cc>

<http://www.manual-lib.com>

<http://www.404manual.com>

<http://www.luxmanual.com>

<http://aubethermostatmanual.com>

Golf course search by state

<http://golfingnear.com>

Email search by domain

<http://emailbydomain.com>

Auto manuals search

<http://auto.somanuals.com>

TV manuals search

<http://tv.somanuals.com>