

# *FM/AM Portable CD Player*

---

## Operating Instructions

### **About the area code**

The area code of the location in which you purchased the CD player is shown on upper left of the bar code label on the package.

For accessories supplied with your CD player, check the area code of your model and see "Accessories (supplied/optional)."



*D-FJ61  
D-FJ65*

## **WARNING**

*To prevent fire or shock hazard, do not expose the unit to rain or moisture.*

*To avoid electrical shock, do not open the cabinet. Refer servicing to qualified personnel only.*

### **CAUTION**

The use of optical instruments with this product will increase eye hazard.

Certain countries may regulate disposal of the battery used to power this product. Please consult with your local authority.

# Table of Contents

## Getting started

Locating the Controls .....	4
-----------------------------	---

## Playing a CD

1. Connect your CD player. ....	6
2. Insert a CD. ....	6
3. Play a CD. ....	6

## Playback options

Playing tracks repeatedly (Repeat play) ....	10
Playing a single track (Single play) .....	10
Playing tracks in random order (Shuffle play) .....	10
Playing tracks in your favorite order (PGM play) .....	11

## Using the radio

Listening to the radio .....	12
Presetting radio stations .....	14
Playing preset radio stations .....	15
Changing the tuning interval .....	15

## Available features

G-PROTECTION function .....	16
Emphasizing the bass sound (SOUND) ....	16
Protecting your hearing (AVLS) .....	17
Locking the controls (HOLD) .....	17
Turning off the operation beep sound .....	18

## Connecting your CD player

Connecting a stereo system .....	19
Using your CD player in a car .....	20

## Connecting a power source

Using the rechargeable batteries .....	21
Using dry batteries .....	23
Notes on the power source .....	23

## Additional information

Precautions .....	24
Maintenance .....	24
Troubleshooting .....	25
Specifications .....	27
Accessories (supplied/optional) .....	29

# Getting started

## Locating the Controls

For details, see pages in parentheses.

### CD player (front)

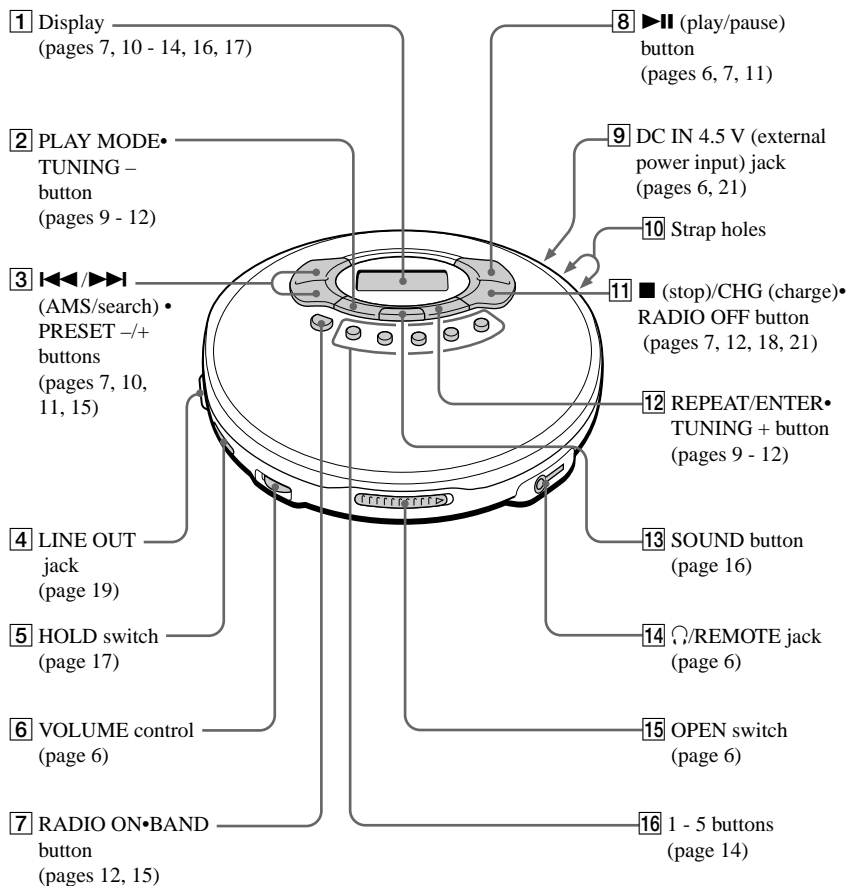

## CD player (inside)

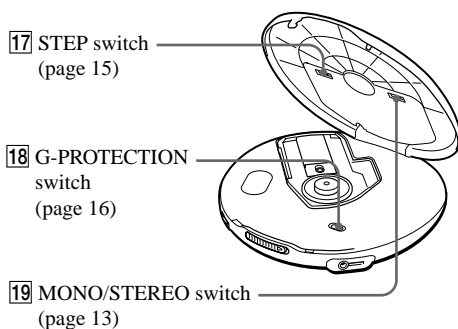

## CD player (rear)

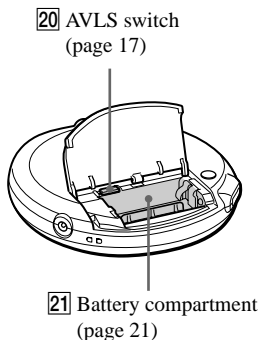

## Remote control (D-FJ65 only)

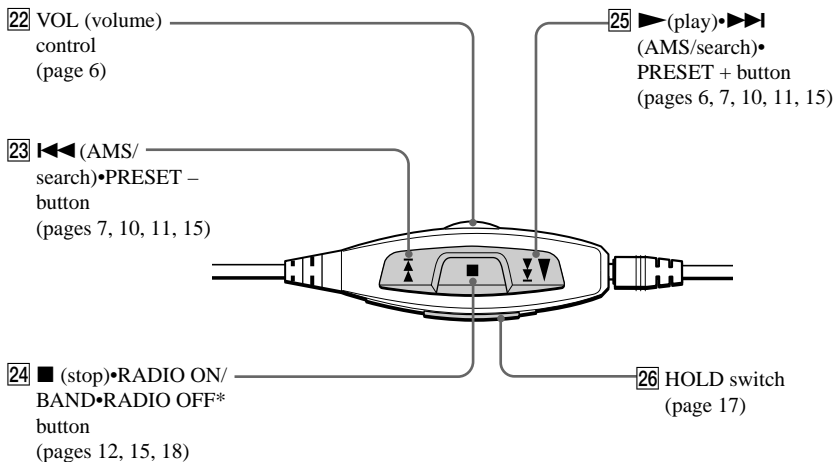

\* To turn off the radio, hold down until the frequency disappears from the display.

**Note**

Use only the supplied remote control. You cannot operate this CD player with the remote control supplied with other CD players.

# Playing a CD

You can also use rechargeable batteries, dry batteries and a car battery as a power source.

## 1. Connect your CD player.

- 1 Connect the AC power adaptor.
- 2 Connect the headphones/earphones.

For models supplied with the remote control.

- Connect the plug of the headphones/earphones to the remote control.
- Connect the headphones/earphones to the remote control firmly. A loose connection may cause noise during playback.

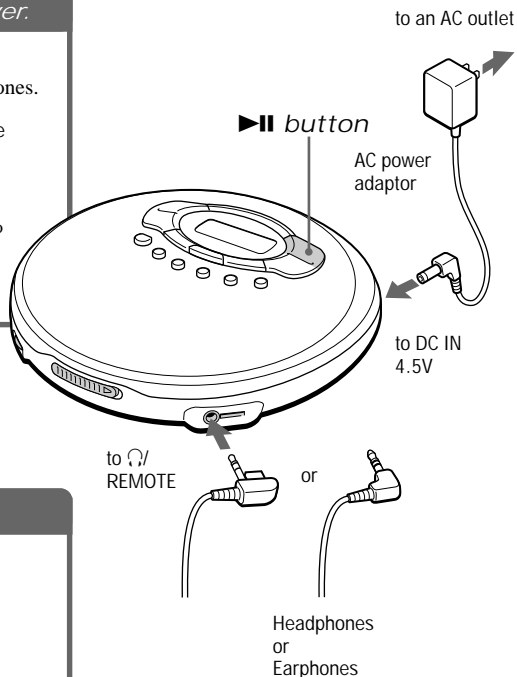

## 2. Insert a CD.

- 1 Slide OPEN and raise the lid.

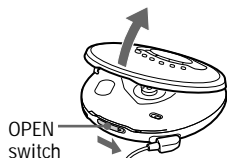

- 2 Place the CD on the tray and close the lid.

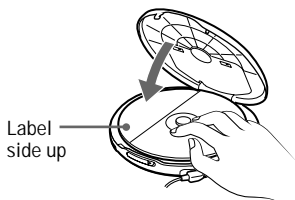

## 3. Play a CD.

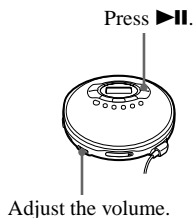

To	Press
Play/Pause (pause only available on the CD player)	▶   (▶ for the remote control)
Stop	■/CHG (■ for the remote control)* <sup>2</sup>
Find the beginning of the current track (AMS* <sup>1</sup> )	◀◀ once quickly* <sup>2</sup>
Find the beginning of the previous tracks (AMS)	◀◀ repeatedly* <sup>2</sup>
Find the beginning of the next track (AMS)	▶▶ once quickly* <sup>2</sup>
Find the beginning of the succeeding tracks (AMS)	▶▶ repeatedly* <sup>2</sup>
Go backwards quickly	Hold down ◀◀* <sup>2</sup>
Go forward quickly	Hold down ▶▶* <sup>2</sup>

\*<sup>1</sup> Automatic Music Sensor

\*<sup>2</sup> These operations can be done during both play and pause.

You can operate your CD player as shown in the above table by using the controls on the CD player or remote control.

### About the display

- When you press ▶|| (▶ for the remote control) after changing the CD or turning off and on the player, the total number of tracks in the CD and total playing time appear for about two seconds.
- During play, the track number and the elapsed playing time of the current track appear.
- Between tracks, the time to the beginning of the next track appears with the “-” indication.
- During pause, the elapsed playing time flashes.

### Setting the maximum volume level

(D-FJ65 only)

1 Set VOL (volume) on the remote control to maximum.

2 Adjust the volume on the CD player to the level that you want it to be. This level becomes the maximum volume for the remote control.

### If the volume level does not increase

Is AVLS set to “LIMIT”? Set AVLS to “NORM.” For details, see “Protecting your hearing (AVLS).”

(Continued)

### *Playback starts from the point you stopped*

Your CD player can recall the playback point where you stopped and then resume playing from the same place (resume function). There is no ON/OFF switch of the resume function on this CD player.

### *Removing the CD*

Remove the CD while pressing the pivot in the center of the tray.

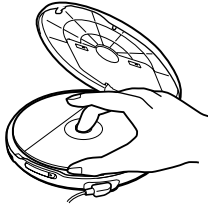



# Playback options

You can enjoy various ways of playback using PLAY MODE and REPEAT/ENTER.

## PLAY MODE button

Each time you press the button, you can change the playback mode.

"No indication"  
(Normal play)



"1"  
(Play a single track)



"SHUF"  
(Play tracks in random order)



"PGM"  
(Play tracks in your favorite order)

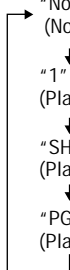

## REPEAT/ENTER button

### REPEAT

You can repeat play that is selected using PLAY MODE.

### ENTER

You can select tracks for PGM play mode.

◀◀/▶▶  
buttons

▶▶ button

■/CHG button

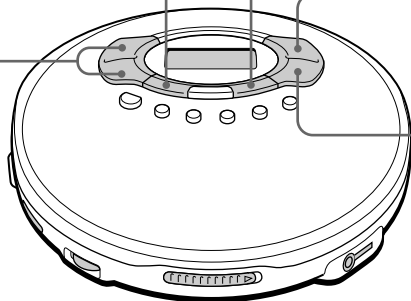

---

## *Playing tracks repeatedly* (Repeat play)

You can play tracks repeatedly in normal, single, shuffle and PGM play modes.



---

**During playback, press REPEAT/ENTER.**



---

### **Note on**

During Repeat play, you can locate the first track after the last track by pressing  repeatedly. You can also locate the last track after first track by pressing  repeatedly.

---

## *Playing a single track* (Single play)

**During playback, press PLAY MODE repeatedly until "1" appears.**

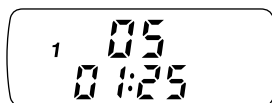

---

## *Playing tracks in random order* (Shuffle play)

**During playback, press PLAY MODE repeatedly until "SHUF" appears.**

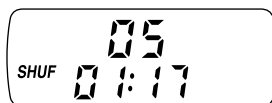

## Playing tracks in your favorite order (PGM play)

You can program the CD player to play up to 64 tracks in your favorite order.

- 1** During playback, press **PLAY MODE** repeatedly until “PGM” appears.

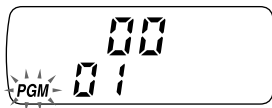

- 2** Press **◀◀** or **▶▶** to select a track.

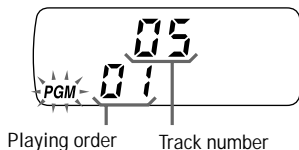

- 3** Press **REPEAT/ENTER** to enter the selected track.  
“00” appears and the playing order increases by one.

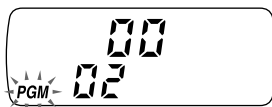

- 4** Repeat steps 2 and 3 to select the tracks in your favorite order.

- 5** Press **▶||** to start the PGM play.

### To check the program

#### During programming:

Press **REPEAT/ENTER** repeatedly before step 5.

#### During the PGM play:

Press **PLAY MODE** repeatedly until “PGM” flashes, then press **REPEAT/ENTER**. Each time you press **REPEAT/ENTER**, the track number appears.

#### Notes

- When you finish entering the 64th track in step 3, the first selected track appears in the display.
- If you select more than 64 tracks, the first selected tracks are erased.

# Using the radio

Once you've preset the stations, you can easily tune in the station by pressing one of the 1 - 5 buttons.

---

## Listening to the radio

You can enjoy FM and AM programs.

---

**1** Press **RADIO ON•BAND** to turn on the radio.

---

**2** Press **RADIO ON•BAND** until the band you want appears.

Each time you press the button, the display changes as follows:

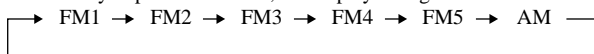

---

**3** Press **TUNING +** or **-** to tune in the station you want and adjust the volume.



---

### To turn off the radio

Press **■/CHG•RADIO OFF**. (Hold down **■•RADIO ON/BAND•RADIO OFF** on the remote control.)

### To tune in the station quickly

Hold down **TUNING +** or **-** in step 3 until the frequency digits begin to change in the display. The CD player automatically scans the radio frequencies and stops when it finds a clear station.

## To improve broadcast reception

For FM, extend the headphones/earphones cord.



For AM, reorient the CD player itself.

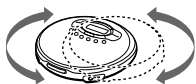

### Note

Keep the headphones/earphones connected to the /REMOTE jack of the CD player even when listening to the FM program through the speakers connected to the LINE OUT jack of the CD player. The headphones/earphones cord works as the FM antenna.

## If it is hard to hear the FM broadcast

Set the MONO/STEREO switch to "MONO" using a pointed material.

The noise will be reduced but the radio will play in monaural.

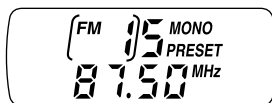

## When listening to the radio on batteries

If you connect the external power source plug to the DC IN 4.5 V jack of your CD player, the CD player will turn off. Turn it on by pressing RADIO ON•BAND to continue listening to it.

---

## Presetting radio stations

You can store radio stations into the CD player's memory. You can preset up to 30 stations, 5 for each band (FM1 - 5 and AM) in any order.

---

### 1 Tune in the station you want.

---

### 2 Hold down one of the 1 - 5 buttons that you want to preset the new station on for more than 2 seconds.

When the station is preset successfully, the beep sounds and the indication "PRESET" appears in the display. The new station replaces the old one.

FM:

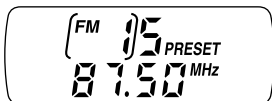

AM:

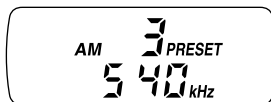

---

### To cancel all preset stations

1 Disconnect the power source (AC power adaptor, rechargeable batteries or alkaline batteries).

2 While you press and hold down RADIO ON•BAND, connect the AC power adaptor again.

The indications in the display keep flashing until all preset stations are cleared, then stop flashing and disappear from the display.

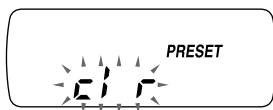

---

## *Playing preset radio stations*

You can tune in the station easily by pressing one of the 1 - 5 buttons.

---

**1** Press **RADIO ON•BAND** (**RADIO ON/BAND** on the remote control) to select the band.

---

**2** Press one of the 1 - 5 buttons or **PRESET + or -** (**PRESET + or -** on the remote control) to tune in a stored station.

---

---

## *Changing the tuning interval*

When using the CD player abroad, change the AM tuning interval, if necessary. Set the STEP switch (inside the lid) to "9 kHz" or "10 kHz" using a pointed material.

9 kHz area: Asia and Europe

10 kHz area: the U.S. A., Canada and South America

### **Notes**

- The interval will not change until you once turn off the radio and then turn it on again.
- After changing the tuning interval, you need to preset radio stations again.

---

## G-PROTECTION function

The G-PROTECTION function has been developed to provide excellent protection against sound skipping while jogging. This function provides a higher level of shock protection than the traditional one. While jogging, be sure to hold your CD player with the OPEN switch facing upward.

---

**Set G-PROTECTION (under the lid) to "ON."**



---

## To turn off the G-PROTECTION function

Set G-PROTECTION to "OFF."

### Note

Sound may skip if:

- the CD player receives stronger continuous shock than expected or
- a dirty or scratched CD is played.

---

## Emphasizing the bass sound (SOUND)

You can emphasize the bass-boosted sound.

---

**Press SOUND to select "BASS ■" or "BASS ■■."**

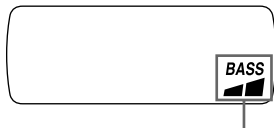
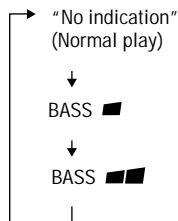

The selected sound mode is displayed.

"BASS ■■" enhances the bass sound more than "BASS ■".

---

### Note

If the sound is distorted when using the SOUND function, turn down the volume.



---

## Protecting your hearing (AVLS)

The AVLS (Automatic Volume Limiter System) function keeps down the maximum volume to protect your hearing.

---

### Set AVLS (in the battery compartment) to "LIMIT."

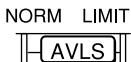

Displayed when "LIMIT" is selected and AVLS function is working.

---

### To turn off the AVLS function

Set AVLS to "NORM."

---

---

## Locking the controls (HOLD)

You can lock the controls on your CD player to prevent accidental button presses.

---

### Slide HOLD in the direction of the arrow.

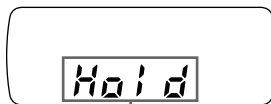
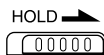

Displayed when the HOLD function is working.

---

You can use the HOLD function with both the CD player and remote control. You can still operate your CD player using the remote control when HOLD on the remote control is set to off.

---

### To unlock the controls

Slide HOLD in the opposite direction of the arrow.

---

---

## *Turning off the operation beep sound*

You can turn off the beep sound that is heard from your headphones/earphones when you operate your CD player.

---

**1 Remove the power source (AC power adaptor, rechargeable batteries or dry batteries) from the CD player.**

---

**2 Connect the power source while pressing ■/CHG on the CD player or ■ on the remote control.**

---

### **To turn on the beep sound**

Remove the power source and then connect the power source without pressing ■/CHG or ■.

## Connecting a stereo system

You can listen to CDs through a stereo system and record CDs on a cassette tape. For details, see the instruction manual that comes with the connected device.

Be sure to turn off all connected devices before making connections.

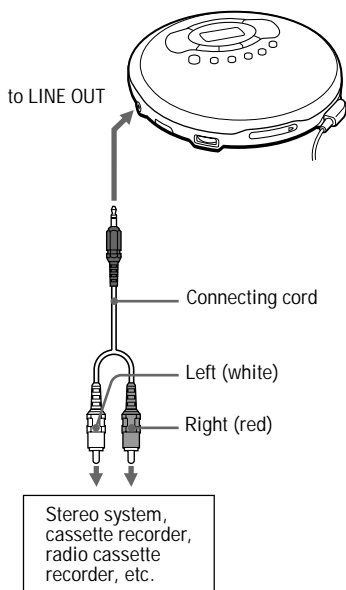

### Notes

- Before you play a CD, turn down the volume of the connected device to avoid damaging the connected speakers.
- Use the AC power adaptor for recording. If you use the rechargeable batteries or dry batteries as a power source, batteries may become completely depleted during recording.
- Adjust the volume properly on the connected device so that the sound will not be distorted.

### When using the connecting cord

- If the sound is distorted, connect the device to the  $\Omega$ /REMOTE jack.
- The SOUND function does not work.
- The output level of the  $\Omega$ /REMOTE jack decreases.

---

## *Using your CD player in a car*

You can use your CD player in a car by connecting it to the car cassette deck.

You cannot use the car mount plate for this CD player.

When you use your CD player in a car, install it securely in a location that does not interfere with your driving.

### **Optional car accessory needed**

To connect your CD player to a car cassette deck, you need the following car accessories in "Accessories (supplied/optional)":

- Car battery cord, and
- Car connecting pack\*

For details, see the instruction manuals that come with the optional accessories.

\* Noise may be heard if you use an optional connecting cord. It is recommended that you use a Sony car connecting pack to reduce noise.

### **Switched ignition function (when using the car battery cord)**

With this feature, your CD player stops automatically when you turn off the car engine (turn off the ignition key) even if the batteries are inserted in the CD player. This function is invalid depending on the car models.

#### **Note**

Use only the car battery cord listed in "Accessories (supplied/optional)." If you use any other car battery cord, a heat, smoke or malfunction may occur.

## ► Connecting a power source

You can use the following power sources:

- Rechargeable batteries
- AC power adaptor (see “Playing a CD”)
- LR6 (size AA) alkaline batteries

For the battery life and charging time of the rechargeable batteries, see “Specifications.”

## Using the rechargeable batteries

Charge the rechargeable batteries before using them for the first time. You can use only the following rechargeable batteries for your CD player.

- NC-WMAA
- NH-WM2AA

### 1 Open the battery compartment lid.

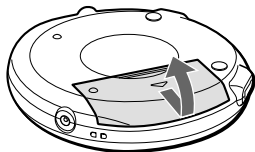

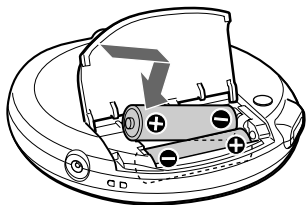

(rear)

### 2 Insert two rechargeable batteries by matching the ⊕ to the diagram in the battery compartment and close the lid.

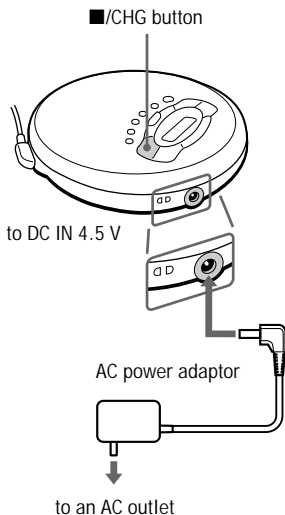

### 3 Connect the AC power adaptor to the DC IN 4.5 V jack of your CD player and an AC outlet, then press ■/CHG to start charging.



The CD player charges the batteries. The “CHG” indicator turns on in the display, and the indicator sections of  light up in succession. When the batteries are completely charged, the “CHG” and  indicators turn off.

If you press ■/CHG after the charge has already been completed, the  indicator flashes and “Full” appears in the display.

### 4 Disconnect the AC power adaptor.

(Continued)

## Using the rechargeable batteries

### To remove the rechargeable batteries

Remove the batteries as illustrated below.

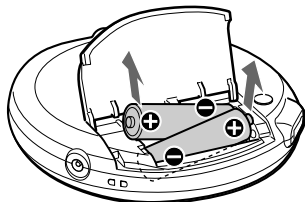

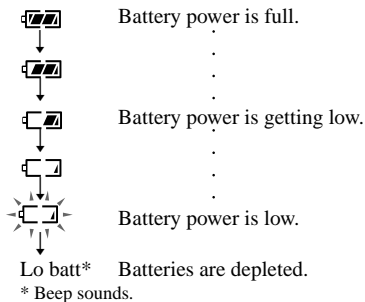

### When to charge the rechargeable batteries

You can check the remaining power of the batteries in the display.



To keep the original battery capacity for a long time, charge the batteries only when they are completely depleted.

### Notes

- The indicator sections of  roughly shows the remaining battery power. One section does not always indicate one-fourth of the battery power.
- Depending on operating conditions, the indicator sections of  may increase or decrease.

### When to replace the rechargeable batteries

If the battery life becomes shorter by about half, replace the batteries with new rechargeable batteries.

### Note on the rechargeable batteries

If the battery is new or has not been used for a long time, it may not be charged completely until you charge and discharge it several times.

### Note on carrying the rechargeable batteries

Use the supplied battery carrying case to prevent unexpected heat. If the rechargeable batteries and the metallic objects are contacted, heat or fire may occur due to a short circuit.

### To attach the battery compartment lid

If the battery compartment lid is detached by an accidental drop, excessive force, etc., attach it as illustrated below.

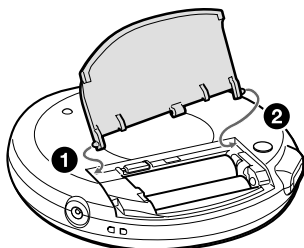

## Using dry batteries

Use only the following dry battery type for your CD player:

- LR6 (size AA) alkaline batteries

### Note

Be sure to remove the AC power adaptor when using the dry batteries.

**1** Open the battery compartment lid.

**2** Insert two LR6 (size AA) batteries by matching the  $\oplus$  to the diagram in the battery compartment.

### To remove the batteries

Remove the batteries in the same way as rechargeable batteries.

### When to replace the batteries

You can check the remaining power of the batteries in the display.

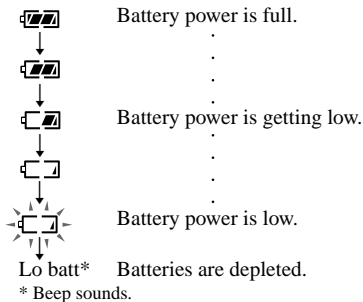

When the batteries are depleted, replace both batteries with new ones.

## Notes on the power source

Disconnect all power sources when the CD player is not used.

### On AC power adaptor

- Use only the AC power adaptor supplied or recommended in “Accessories (supplied/ optional).” Do not use any other AC power adaptor. It may cause a malfunction.

Polarity of the plug



- When disconnecting the AC power adaptor from the AC outlet, grasp the adaptor itself. Do not pull it by the cord.
- Do not touch the AC power adaptor with wet hands.

### On rechargeable batteries and dry batteries

- Do not charge the dry batteries.
- Do not throw the batteries into fire.
- Do not carry the batteries with coins or other metallic objects. It can generate heat if the positive and negative terminals of the battery are accidentally contacted by a metallic object.
- Do not mix rechargeable batteries with dry batteries.
- Do not mix new batteries with old ones.
- Do not use different types of batteries together.
- When the batteries are not to be used for a long time, remove them.
- If battery leakage occurs, wipe off any deposit in the battery compartment, and install new batteries. In case the deposit adheres to you, wash it off thoroughly.

---

## Precautions

### On safety

- Should any solid objects or liquid fall into the CD player, unplug it and have it checked by qualified personnel before operating it any further.
- Do not put any foreign objects in the DC IN 4.5 V (external power input) jack.

### On the CD player

- Keep the lens on the CD player clean and do not touch it. If you do so, the lens may be damaged and the CD player will not operate properly.
- Do not put any heavy object on top of the CD player. The CD player and the CD may be damaged.
- Do not leave the CD player in a location near heat sources, or in a place subject to direct sunlight, excessive dust or sand, moisture, rain, mechanical shock, unlevelled surface, or in a car with its windows closed.
- If the CD player causes interference to the radio or television reception, turn off the CD player or move it away from the radio or television.

### On handling CDs

- To keep the CD clean, handle it by its edge. Do not touch the surface.
- Do not stick paper or tape onto the CD.

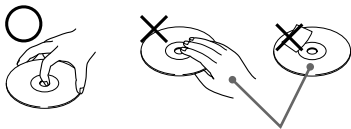

Not these ways

- Do not expose the CD to direct sunlight or heat sources such as hot air ducts. Do not leave the CD in a car parked under direct sunlight.

### On headphones/earphones

#### Road safety

Do not use headphones/earphones while driving, cycling, or operating any motorized vehicle. It may create a traffic hazard and is illegal in some areas. It can also be potentially dangerous to play your headsets at high volume while walking, especially at pedestrian crossings. You should exercise extreme caution or discontinue use in potentially hazardous situations.

#### Preventing hearing damage

Avoid using headphones/earphones at high volume. Hearing experts advise against continuous, loud and extended play. If you experience a ringing in your ears, reduce volume or discontinue use.

#### Consideration for others

Keep the volume at a moderate level. This will allow you to hear outside sounds and to be considerate to the people around you.

---

## Maintenance

### To clean the casing

Use a soft cloth slightly moistened in water or a mild detergent solution. Do not use alcohol, benzine or thinner.



## Troubleshooting

Should any problem persist after you have checked these symptoms, consult your nearest Sony dealer.

### CD player

Symptom	Cause and/or corrective actions
The volume does not increase even if the VOLUME control is adjusted to the maximum level.	<ul style="list-style-type: none"><li>→ Set the AVLS switch to "NORM." (page 17)</li><li>→ The headphones/earphones are connected to the LINE OUT jack. Connect them to the /REMOTE jack. (page 6)</li><li>→ The connecting cord is connected to the LINE OUT jack. (page 19)</li></ul>
No sound, or noise is heard.	<ul style="list-style-type: none"><li>→ Connect the plugs firmly. (page 6)</li><li>→ Plugs are dirty. Clean the plugs with a dry soft cloth periodically.</li></ul>
The playing time is too short when powered with the dry batteries.	<ul style="list-style-type: none"><li>→ Check that you are using alkaline batteries and not manganese batteries. (page 23)</li><li>→ Replace the batteries with new LR6 (size AA) alkaline batteries. (page 23)</li></ul>
The playing time is too short when powered with the rechargeable batteries.	<ul style="list-style-type: none"><li>→ Charge and discharge the rechargeable batteries several times. (pages 21, 22)</li></ul>
When you press <b>▶  </b> , "Lo batt" or "00" appears in the display. The CD does not play.	<ul style="list-style-type: none"><li>→ The rechargeable batteries are used up completely. Charge the batteries. (pages 21, 22)</li><li>→ Replace the batteries with new LR6 (size AA) alkaline batteries. (page 23)</li></ul>
"Hi dc In" appears in the display.	<ul style="list-style-type: none"><li>→ Use only the AC power adaptor or car battery cord in "Accessories (supplied/optional)." (page 29)</li><li>→ Remove all power sources, then insert the batteries or connect the AC power adaptor again. (pages 6, 21, 22, 23)</li></ul>
The CD does not play or "no DISC" appears in the display when a CD is placed in the CD player.	<ul style="list-style-type: none"><li>→ The CD is dirty or defective. (page 24)</li><li>→ Check that the CD is inserted with the label side up. (page 6)</li><li>→ Moisture condensation has occurred. Leave the CD player aside for several hours until the moisture evaporates.</li><li>→ Close the lid of the battery compartment firmly. (page 21)</li><li>→ Make sure the batteries are inserted correctly. (pages 21 - 23)</li><li>→ Connect the AC power adaptor to an AC outlet securely. (page 6)</li></ul>
"Hold" appears in the display when you press a button, and the CD does not play.	<ul style="list-style-type: none"><li>→ The buttons are locked. Slide the HOLD switch back. (page 17)</li></ul>
Cannot adjust the volume with the VOLUME control on the CD player.	<ul style="list-style-type: none"><li>→ The CD player is connected to an audio device. Adjust the volume using the volume control on the connected device. (page 19)</li></ul>
The CD player does not start charging.	<ul style="list-style-type: none"><li>→ During stop, press <b>■</b>/CHG. (page 21)</li></ul>

(Continued)

## Radio

Symptom	Cause and/or corrective actions
The audio is weak or has poor quality.	<ul style="list-style-type: none"><li>→ Charge the rechargeable batteries. (pages 21, 22)</li><li>→ Replace the batteries with new LR6 (size AA) alkaline batteries. (page 23)</li><li>→ Move the CD player away from the TV.</li></ul>

# Specifications

## CD player

### System

Compact disc digital audio system

### Laser diode properties

Material: GaAlAs

Wavelength:  $\lambda = 780$  nm

Emission duration: Continuous

Laser output: Less than 44.6  $\mu$ W

(This output is the value measured at a distance of 200 mm from the objective lens surface on the optical pick-up block with 7 mm aperture.)

### D-A conversion

1-bit quartz time-axis control

### Frequency response

20 - 20 000 Hz  $\pm 1$  dB (measured by EIAJ CP-307)

### Output (at 4.5 V input level)

Line output (stereo minijack)

Output level 0.7 V rms at 47 k $\Omega$

Recommended load impedance over 10 k $\Omega$

Headphones (stereo minijack)

Approx. 5 mW + Approx. 5 mW at 16  $\Omega$

(Approx. 1 mW + Approx. 1 mW at 16  $\Omega$ )\*

\*For the customers in France

## Radio

### Frequency range (STEP switch)

9 kHz step:

FM: 87.5 - 108.0 MHz

AM: 531 - 1 710 kHz

10 kHz step:

FM: 87.5 - 108.0 MHz

AM: 530 - 1 710 kHz

### Antenna

FM: Headphones/earphones cord antenna

AM: Built-in ferrite bar antenna

## General

### Power requirements

For the area code of the model you purchased, check the upper left side of the bar code on the package.

- Two Sony NC-WMAA rechargeable batteries: 2.4 V DC
- Sony NH-WM2AA rechargeable batteries: 2.4 V DC
- Two LR6 (size AA) batteries: 3 V DC
- AC power adaptor (DC IN 4.5 V jack):  
U2/CA2/E92/MX2 model: 120 V, 60 Hz  
CED/CET/CEW/CEX/CE7/EE/EE1/E13/G5/G6/G7/G8 model:  
220 - 230 V, 50/60 Hz  
CEK/3CE7 model: 230 - 240 V, 50 Hz  
EA3 model: 110 - 240 V, 50/60 Hz  
AU2 model: 240 V, 50 Hz  
JE.W/E33 model: 100 - 240 V, 50/60 Hz  
HK2 model: 220 V, 50/60 Hz  
AR1/CN2 model: 220 V, 50 Hz
- Sony DCC-E345 car battery cord for use on car battery: 4.5 V DC

(Continued)

---

## Specifications

### Battery life\* (approx. hours)

(When you use the CD player on a flat and stable surface.)

Playing time varies depending on how the CD player is used.

When using	G-PROTECTION		RADIO on
	on	off	
Two NC-WMAA (charged for about 3 hours**)	8	7	17
NH-WM2AA (charged for about 4 hours**)	18	15	38
Two Sony alkaline batteries LR6SG	32	28	66

\* Measured value by the standard of EIAJ  
(Electronic Industries Association of Japan).

\*\* Charging time varies depending on how the  
rechargeable battery is used.

### Operating temperature

5°C - 35°C (41°F - 95°F)

### Dimensions (w/h/d) (excluding projecting parts and controls)

Approx. 131 × 30 × 136 mm

(5 1/4 × 1 3/16 × 5 3/8 in.)

### Mass (excluding accessories)

Approx. 200 g (7.1 oz.)

Design and specifications are subject to change  
without notice.

## Accessories (supplied/optional)

### Supplied accessories

For the area code of the location in which you purchased the CD player, check the upper left side of the bar code on the package.

	D-F161	D-F165
AC power adaptor (1)	○	○
Headphones/earphones with remote control (1)	—	○
Headphones/earphones (1)	○	—
Rechargeable batteries (2)	—	○
Battery carrying case (1)	—	○

### Optional accessories

AC power adaptor	AC-E45HG
Active speaker system	SRS-T1 SRS-Z500
Car battery cord	DCC-E345
Car battery cord with car connecting pack	DCC-E34CP
Car connecting pack	CPA-9C
Connecting cord	RK-G129HG RK-G136HG
Rechargeable battery	NH-WM2AA
Earphones	MDR-E848LP MDR-EX70LP
Headphones	MDR-A44L MDR-A110LP

### When connecting optional headphones/earphones to the supplied remote control

Use only headphones with stereo mini plugs. You cannot use headphones with micro plugs.

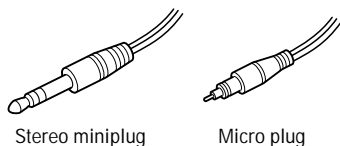

Your dealer may not handle some of the above listed accessories. Please ask the dealer for detailed information about the accessories in your country.





---

Sony  line <http://www.world.sony.com/>

---

Sony Corporation

Download from [Www.Somanuals.com](http://www.Somanuals.com). All Manuals Search And Download.



## Free Manuals Download Website

<http://myh66.com>

<http://usermanuals.us>

<http://www.somanuals.com>

<http://www.4manuals.cc>

<http://www.manual-lib.com>

<http://www.404manual.com>

<http://www.luxmanual.com>

<http://aubethermostatmanual.com>

Golf course search by state

<http://golfingnear.com>

Email search by domain

<http://emailbydomain.com>

Auto manuals search

<http://auto.somanuals.com>

TV manuals search

<http://tv.somanuals.com>