

Portable CD Player

Operating Instructions

About the area code

The area code of the location in which you purchased the CD player is shown on upper left of the bar code label on the package.

For accessories supplied with your CD player, check the area code of your model and see "Accessories (supplied/optional)."



"WALKMAN" is a trademark of Sony Corporation.

D-SJ301

WARNING

To prevent fire or shock hazard, do not expose the unit to rain or moisture.

Do not install the appliance in a confined space, such as a bookcase or built-in cabinet.

To prevent fire, do not cover the ventilation of the apparatus with newspapers, tablecloths, curtains, etc. And don't place lighted candles on the apparatus.

To prevent fire or shock hazard, do not place objects filled with liquids, such as vases, on the apparatus.

CAUTION

The use of optical instruments with this product will increase eye hazard.

Certain countries may regulate disposal of the battery used to power this product. Please consult with your local authority.

CAUTION

- INVISIBLE LASER RADIATION
WHEN OPEN
- DO NOT STARE INTO BEAM OR
VIEW DIRECTLY WITH OPTICAL
INSTRUMENTS

 The CE mark is valid only for products marketed in the European Union.

For the customers in Australia

The supply cord of the AC power adaptor cannot be replaced; if the cord is damaged, the AC power adaptor should be discarded.

Table of Contents

Getting started

Locating the controls	4
-----------------------------	---

Playing a CD

1. Connect your CD player.	6
2. Insert a CD.	6
3. Play a CD.	7

Playback options

Playing tracks repeatedly (Repeat play)	10
Playing a single track (Single play)	10
Playing tracks in random order (Shuffle play)	10
Playing tracks in your favorite order (PGM play)	11

Available features

G-PROTECTION function	12
Emphasizing the bass sound (SOUND)	12
Protecting your hearing (AVLS)	13
Locking the controls (HOLD)	13
Turning off the operation beep sound	14

Connecting your CD player

Connecting a stereo system	15
----------------------------------	----

Connecting to a power source

Using the rechargeable batteries	16
Using dry batteries	18
Notes on the power source	18

Additional information

Precautions	19
Maintenance	20
Troubleshooting	21
Specifications	23
Accessories (supplied/optional) ..	Back cover

Getting started

Locating the controls

For details, see pages in parentheses.

CD player (front)

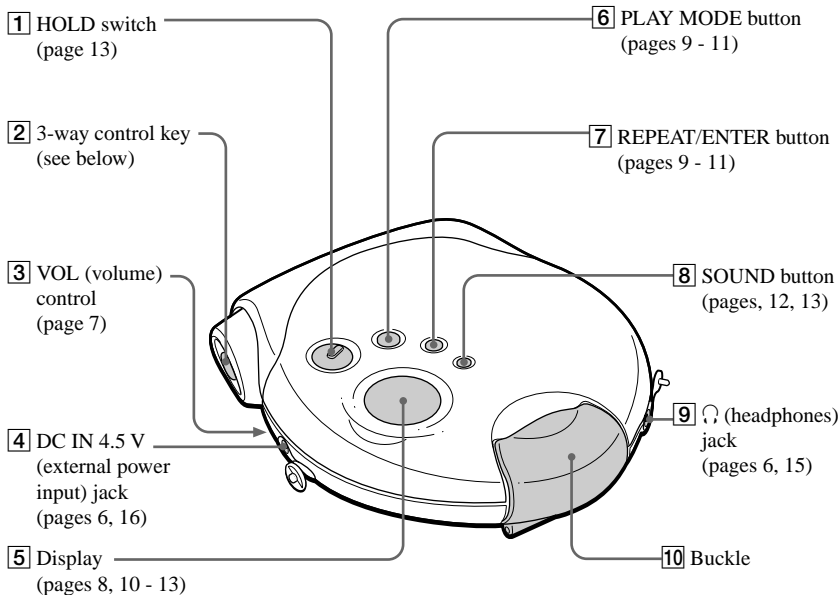

2 3-way control key

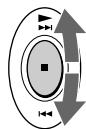

Push toward
▶▶▶▶ or
◀◀◀◀.

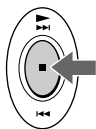

Press ■/CHG.

▶▶▶▶: Play/AMS/search
(pages 6, 7, 11)

◀◀◀◀: AMS/search (pages 7, 11)

■/CHG: stop/charge
(pages 7, 14, 16)

CD player (inside)

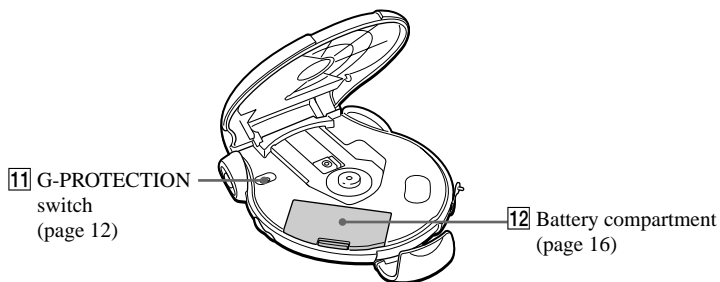

Using the hand strap

While jogging, use the supplied hand strap.

1 Pass the strap through the hooks.

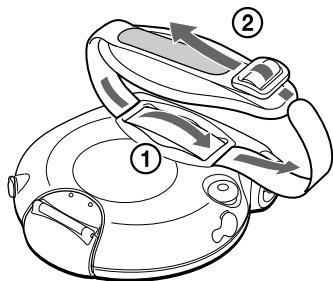

2 Put your hand between the player and the strap, then adjust the length of the strap and fix it using the Velcro tapes.

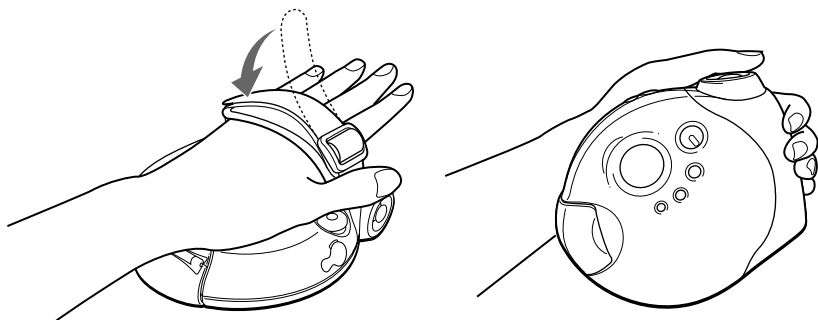

Playing a CD

You can also use rechargeable batteries and dry batteries as a power source.

1. Connect your CD player.

- 1 Connect the AC power adaptor.
- 2 Connect the headphones/earphones.

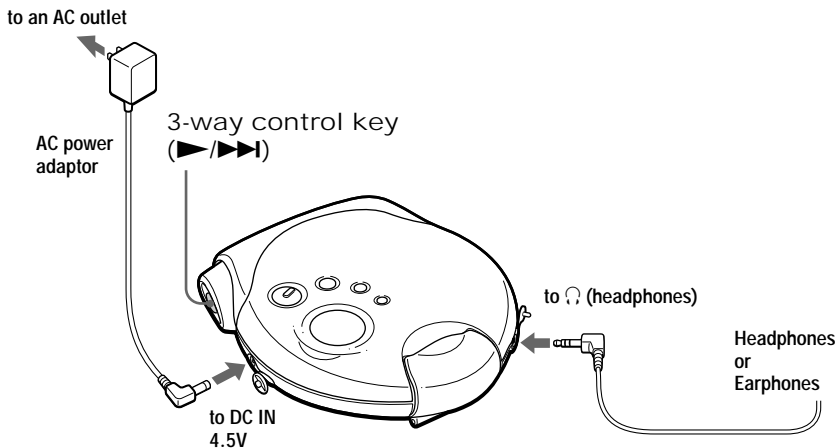

2. Insert a CD.

- 1 Unfasten the buckle.
- 2 Open the lid.
- 3 Fit the CD on the pivot and close the lid.
- 4 While holding the lid closed, fasten the buckle securely.

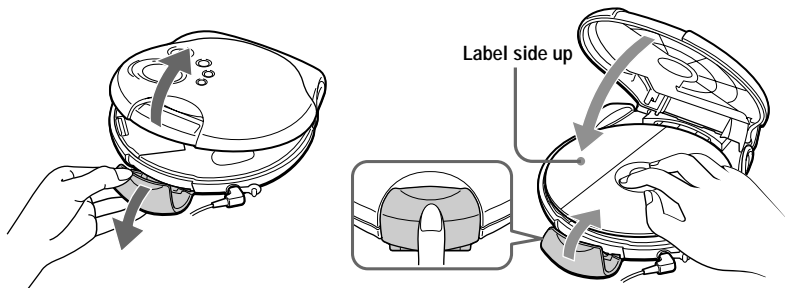

3. Play a CD.

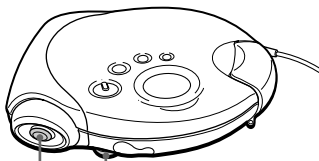

Push the 3-way control key toward **▶/▶▶|**.

Adjust the volume.

To	Do this
Play (from the point you stopped)	Push the 3- way control key toward ▶/▶▶ . Playback starts from the point you stopped.
Play (from the first track)	Push the control key toward ▶/▶▶ and hold it for 2 seconds or more.
Stop	Press ■/CHG *2
Find the beginning of the current track (AMS*1)	Push the control key toward ◀◀ once quickly*2
Find the beginning of the previous tracks (AMS)	Push the control key toward ◀◀ repeatedly*2, *3
Find the beginning of the next track (AMS)	Push the control key toward ▶/▶▶ once quickly*2, *3
Find the beginning of the succeeding tracks (AMS)	Push the control key toward ▶/▶▶ repeatedly*2, *3
Go backwards quickly	Push the control key toward ◀◀ and hold it*2
Go forward quickly	Push the control key toward ▶/▶▶ and hold it*2

*1 Automatic Music Sensor

*2 These operations can be done during play.

*3 After you have played the last track, you can return to the beginning of the first track by pushing the 3- way control key toward **▶/▶▶|**. Similarly, if you are at the first track, you can locate the last track by pushing the control key toward **◀◀**.

(Continued)

About the display

- When you push the 3- way control key toward ►/▶▶ after changing the CD or turning off and on the player, the total number of tracks in the CD and total playing time appear for about two seconds.
- During play, the track number and the elapsed playing time of the current track appear.

If the volume level does not increase

If “AVLS” appears in the display, hold down SOUND until “AVLS ” disappears from the display. For details, see “Protecting your hearing (AVLS).”

About CD-Rs/CD-RWs

This CD player can play CD-Rs/CD-RWs recorded in the CD-DA format*, but playback capability may vary depending on the quality of the disc and the condition of the recording device.

* CD-DA is the abbreviation for Compact Disc Digital Audio. It is a recording standard used for the Audio CDs.

Removing the CD

Remove the CD while pressing the pivot in the center of the tray.

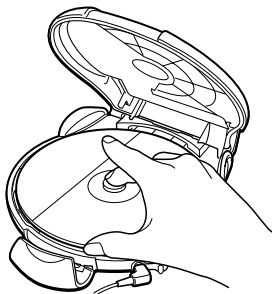

Playback options

You can enjoy various ways of playback using PLAY MODE and REPEAT/ENTER.

PLAY MODE button

Each time you press the button, you can change the playback mode.

No indication
(Normal play)



"1"
(Play a single track)



"SHUF"
(Play tracks in random order)



"PGM"
(Play tracks in your favorite order)

REPEAT/ENTER button

REPEAT

You can repeat play that is selected using PLAY MODE.

ENTER

You can select tracks for PGM play mode.

3- way control key
(▶/▶▶, ◀, ◀◀)

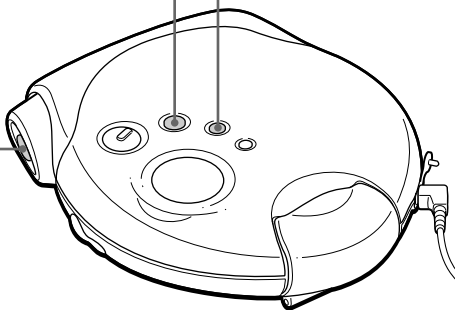

(Continued)

Playing tracks repeatedly (Repeat play)

You can play tracks repeatedly in normal, single, shuffle and PGM play modes.

During playback, press REPEAT/ENTER.



Playing a single track (Single play)

During playback, press PLAY MODE repeatedly until "1" appears.



Playing tracks in random order (Shuffle play)

During playback, press PLAY MODE repeatedly until "SHUF" appears.



Playing tracks in your favorite order (PGM play)

You can program the CD player to play up to 64 tracks in your favorite order.

- 1** During playback, press **PLAY MODE** repeatedly until “PGM” appears.



- 2** Push the 3-way control key toward **◀◀** or **▶▶** to select a track.



- 3** Press **REPEAT/ENTER** to enter the selected track.
“00” appears and the playing order increases by one.



- 4** Repeat steps 2 and 3 to select the tracks in your favorite order.

- 5** Hold down **REPEAT/ENTER** to start **PGM** play.

To check the program

During programming:

Press **REPEAT/ENTER** repeatedly before step 5.

During the PGM play:

Press **PLAY MODE** repeatedly until “PGM” flashes, then press **REPEAT/ENTER**. Each time you press **REPEAT/ENTER**, the track number appears.

Notes

- When you finish entering the 64th track in step 3, the first selected track appears in the display.
- If you select more than 64 tracks, the first selected tracks are erased.

G-PROTECTION function

The G-PROTECTION function has been developed to provide excellent protection against sound skipping while jogging. When you set the G-PROTECTION switch on your CD player to “2”, the G-PROTECTION function will be enhanced compared to “1.”

To walk with the CD player and enjoy high quality CD sound using the G-PROTECTION function, set the G-PROTECTION switch to “1.” While taking harder exercise, it is recommended that you set it to “2.”

Set G-PROTECTION (under the lid) to “1” or “2.”

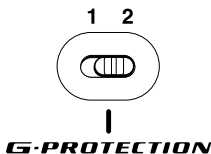

During active uses, use the supplied hand strap (see “Using the supplied hand strap” in Locating the controls).

Note

Sound may skip:

- if the CD player receives stronger continuous shock than expected,
- if a dirty or scratched CD is played or
- when using poor-quality CD-Rs/CD-RWs or if there is a problem with the original recording device or application software.

Emphasizing the bass sound (SOUND)

You can emphasize the bass-boosted sound.

Press SOUND to select “BASS ■■” or “BASS ■■■.”

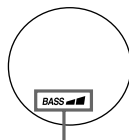
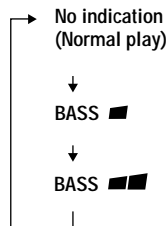

The selected sound mode is displayed.

“BASS ■■■” enhances the bass sound more than “BASS ■.”

Note

If the sound is distorted when using the SOUND function, turn down the volume.

Protecting your hearing (AVLS)

The AVLS (Automatic Volume Limiter System) function keeps down the maximum volume to protect your hearing.

Hold down SOUND until “AVLS” appears in the display.

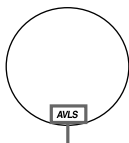

Displayed when AVLS function is activated.

To turn off the AVLS function

Hold down SOUND until “AVLS” disappears from the display.

Note

If you use the SOUND function and the AVLS function at the same time, sound may be distorted. If this happens, turn down the volume.

Locking the controls (HOLD)

You can lock the controls on your CD player to prevent accidental button presses.

Slide HOLD in the direction of the arrow.

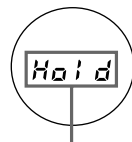
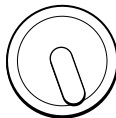

Displayed when the HOLD function is activated.

To unlock the controls

Slide HOLD in the opposite direction of the arrow.

Turning off the operation beep sound

You can turn off the beep sound that is heard from your headphones/earphones when you operate your CD player.

1 Remove the power source (AC power adaptor, rechargeable batteries or dry batteries) from the CD player.

2 Connect the power source while pressing ■/CHG.

To turn on the beep sound

Remove the power source and then connect the power source without pressing ■/CHG.

Connecting a stereo system

You can listen to CDs through a stereo system and record CDs on a cassette tape. For details, see the instruction manual that comes with the connected device.

Be sure to turn off all connected devices before making connections.

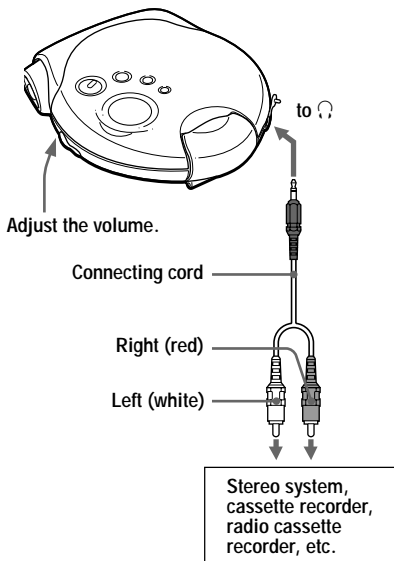

Notes

- Before you play a CD, turn down the volume of the connected device to avoid damaging the connected speakers.
- Use the AC power adaptor for recording. If you use the rechargeable batteries or dry batteries as a power source, batteries may become completely depleted during recording.
- Adjust the volume properly on the CD player and connected device so that the sound will not be distorted or noisy.

About the G-PROTECTION function when using the connecting cord

To record high quality CD sound, set the G-PROTECTION switch to "1."

► Connecting to a power source

You can use the following power sources:

- Rechargeable batteries
- AC power adaptor (see “Playing a CD”)
- LR6 (size AA) alkaline batteries

For the battery life and charging time of the rechargeable batteries, see “Specifications.”

Using the rechargeable batteries

Charge the rechargeable batteries before using them for the first time. You can use only the following rechargeable batteries for your CD player.

- NH-WM2AA (NH-WMAA × 2)

- 1** Open the battery compartment lid inside your CD player.

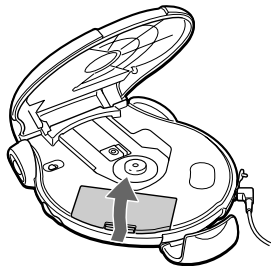

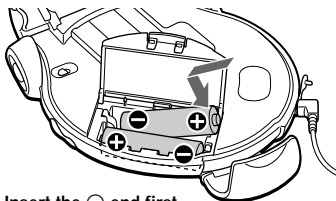

- 2** Insert two rechargeable batteries by matching the ⊕ to the diagram in the battery compartment and close the lid until it clicks into place.

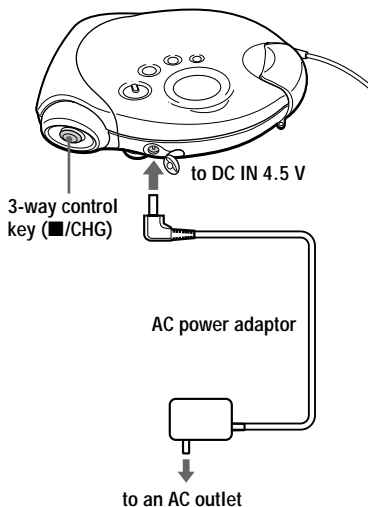

Insert the ⊖ end first
(for both batteries).

- 3** Connect the AC power adaptor to the DC IN 4.5 V jack of your CD player and an AC outlet, then press ■/CHG to start charging.



The CD player charges the batteries. The “CHG” indicator turns on in the display, and the indicator sections of  light up in succession. When the batteries are completely charged, the “CHG” and  indicators turn off.

If you press ■/CHG after the charge has already been completed, the  indicator flashes and “Full” appears in the display.

- 4** Disconnect the AC power adaptor.

To remove the rechargeable batteries

Remove the batteries as illustrated below.

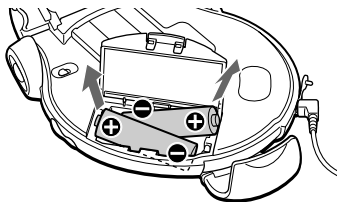

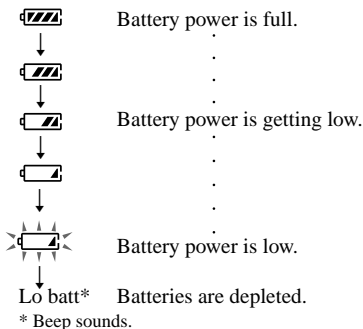

When to charge the rechargeable batteries

You can check the remaining power of the batteries in the display.



To keep the original battery capacity for a long time, charge the batteries only when they are completely depleted.

Notes

- The indicator sections of  roughly show the remaining battery power. One section does not always indicate one-fourth of the battery power.
- Depending on operating conditions, the indicator sections of  may increase or decrease.

When to replace the rechargeable batteries

If the battery life becomes shorter by about half, replace the batteries with new rechargeable batteries.

Note on the rechargeable batteries

If the battery is new or has not been used for a long time, it may not be charged completely until you charge and discharge it several times.

Note on carrying the rechargeable batteries

Use the supplied battery carrying case to prevent unexpected heat. If the rechargeable batteries and the metallic objects are contacted, heat or fire may occur due to a short circuit.

To attach the battery compartment lid

If the battery compartment lid is detached by an accidental drop, excessive force, etc., attach it as illustrated below.

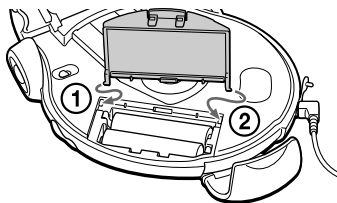

Using dry batteries

Use only the following dry battery type for your CD player:

- LR6 (size AA) alkaline batteries

Note

Be sure to remove the AC power adaptor when using the dry batteries.

1 Open the battery compartment lid.

2 Insert two LR6 (size AA) batteries by matching the \oplus to the diagram in the battery compartment.

Insert the \ominus end first (for both batteries).

To remove the batteries

Remove the batteries in the same way as rechargeable batteries.

When to replace the batteries

You can check the remaining power of the batteries in the display.

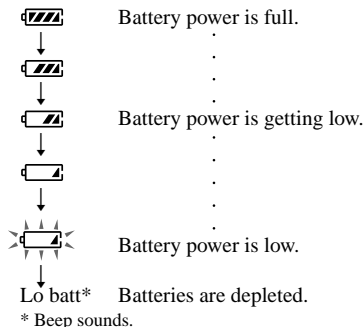

When the batteries are depleted, replace both batteries with new ones.

Notes on the power source

Disconnect all power sources when the CD player is not used.

On AC power adaptor

- Use only the AC power adaptor supplied or recommended in “Accessories (supplied/optional).” Do not use any other AC power adaptor. It may cause a malfunction.

Polarity of the plug



- When disconnecting the AC power adaptor from the AC outlet, grasp the adaptor itself. Do not pull it by the cord.
- Do not touch the AC power adaptor with wet hands.

On rechargeable batteries and dry batteries

- Do not charge the dry batteries.
- Do not throw the batteries into fire.
- Do not carry the batteries with coins or other metallic objects. It can generate heat if the positive and negative terminals of the battery are accidentally contacted by a metallic object.
- Do not mix rechargeable batteries with dry batteries.
- Do not mix new batteries with old ones.
- Do not use different types of batteries together.
- When the batteries are not to be used for a long time, remove them.
- If battery leakage occurs, wipe off any deposit in the battery compartment, and install new batteries. In case the deposit adheres to you, wash it off thoroughly.

Precautions

On safety

- Should any solid objects or liquid fall into the CD player, unplug it and have it checked by qualified personnel before operating it any further.
- Do not put any foreign objects in the DC IN 4.5 V (external power input) jack.

On the CD player

- Keep the lens on the CD player clean and do not touch it. If you do so, the lens may be damaged and the CD player will not operate properly.
- Do not put any heavy object on top of the CD player. The CD player and the CD may be damaged.
- Do not leave the CD player in a location near heat sources, or in a place subject to direct sunlight, excessive dust or sand, moisture, rain, mechanical shock, unlevelled surface, or in a car with its windows closed.
- If the CD player causes interference to the radio or television reception, turn off the CD player or move it away from the radio or television.
- Discs with non-standard shapes (e.g., heart, square, star) cannot be played on this CD player. Attempting to do so may damage the CD player. Do not use such discs.

On handling CDs

- To keep the CD clean, handle it by its edge. Do not touch the surface.
- Do not stick paper or tape onto the CD.

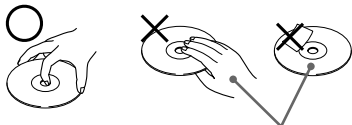

Not these ways

- Do not expose the CD to direct sunlight or heat sources such as hot air ducts. Do not leave the CD in a car parked under direct sunlight.
- Do not use the CD soiled with dust. Malfunction may occur.

On headphones/earphones

Road safety

Do not use headphones/earphones while driving, cycling, or operating any motorized vehicle. It may create a traffic hazard and is illegal in some areas. It can also be potentially dangerous to play your headsets at high volume while walking, especially at pedestrian crossings. You should exercise extreme caution or discontinue use in potentially hazardous situations.

Preventing hearing damage

Avoid using headphones/earphones at high volume. Hearing experts advise against continuous, loud and extended play. If you experience a ringing in your ears, reduce volume or discontinue use.

Consideration for others

Keep the volume at a moderate level. This will allow you to hear outside sounds and to be considerate to the people around you.

On the water resistance

- Before unfastening the buckle to open the lid, be sure to wipe off water, dust or sand on the exterior of the unit. Open and close the lid where water or sand cannot fall in the unit, and make sure that your hands are dry. If water or sand falls in the unit, trouble may occur.
- When closing the lid, check that there is no dust or sand on the rubber packing around the lid. Then close the lid firmly with the buckle.

(Continued)

Precautions

- The supplied headphones are not meant to be immersed in water or come in continuous contact with water. If they are accidentally dropped into water or get wet, dry them with a soft cloth. Never use an electric hair dryer.
- The supplied AC power adaptor is not water resistant. To prevent shock hazard, avoid using the player near water during AC operation.
- Cover the DC IN 4.5 V jack and Ω jack with the attached rubber caps when nothing is connected to these jacks. If the inside of the jacks are contaminated with water or sand, rust may develop and cause trouble.

Notes

- Since the unit is airtight, you may not be able to open the lid when there is a sudden change in air pressure inside the unit. This happens when the unit is transported on a plane or moved from a warm place to a cold place. In this case, open the rubber cap on the DC IN 4.5 V jack.
- To prevent water from leaking in, the buckle is designed to be slightly stiff. Be careful not to catch a fingernail on the buckle when unfastening the lid.

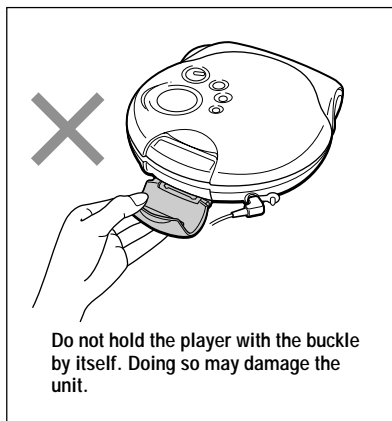

Maintenance

To clean the casing

Use a soft cloth slightly moistened in water or a mild detergent solution. Do not use alcohol, benzine or thinner.

To clean the headphones/earphones plug

Keep the plug of your headphones/earphones clean to obtain optimum sound. Wipe it with a dry, soft cloth.

To remove any dust or sand from the rubber packing

Any sand or dust on the rubber packing will prevent the lid from shutting tightly, and water may leak in. Brush off the dust once in a while.

We recommend the replacement of the rubber packing every year which is available optionally at an authorized Sony service facility.

Troubleshooting

Should any problem persist after you have checked these symptoms, consult your nearest Sony dealer.

Symptom	Cause and/or corrective actions
The volume does not increase even if the VOL control is adjusted to the maximum level.	→ If "AVLS" appears in the display, hold down SOUND until "AVLS" disappears from the display. (page 13)
No sound, or noise is heard.	→ Connect the plugs firmly. (page 6) → Plugs are dirty. Clean the plugs with a dry soft cloth periodically.
The playing time is too short when powered with the dry batteries.	→ Check that you are using alkaline batteries and not manganese batteries. (page 18) → Replace the batteries with new LR6 (size AA) alkaline batteries. (page 18)
The playing time is too short when powered with the rechargeable batteries.	→ Charge and discharge the rechargeable batteries several times. (pages 16, 17)
"Lo batt" or "00" appears in the display. The CD does not play.	→ The rechargeable batteries are used up completely. Charge the batteries. (pages 16, 17) → Replace the batteries with new LR6 (size AA) alkaline batteries. (page 18)
"HI dc In" appears in the display.	→ Use only the AC power adaptor or car battery cord in "Accessories (supplied/optional)." (back cover) → Remove all power sources, then insert the batteries or connect the AC power adaptor again. (pages 6, 16, 17, 18)
The CD does not play or "no DISC" appears in the display when a CD is placed in the CD player.	→ The buttons are locked. Slide the HOLD switch back. (page 13) → The CD is dirty or defective. (page 19) → Check that the CD is inserted with the label side up. (page 6) → Moisture condensation has occurred. Leave the CD player aside for several hours until the moisture evaporates. → Close the lid of the battery compartment firmly. (page 16) → Make sure the batteries are inserted correctly. (pages 16 - 18) → Connect the AC power adaptor to an AC outlet securely. (page 6) → The CD-R/CD-RW was not finalized. Finalize the CD-R/CD-RW with the recording device. → There is a problem with the quality of the CD-R/CD-RW, recording device, or application software.
"Hold" appears in the display when you press a button, and the CD does not play.	→ The buttons are locked. Slide the HOLD switch back. (page 13)
The CD player does not start charging.	→ During stop, press ■/CHG. (page 16)

(Continued)

Troubleshooting

Symptom	Cause and/or corrective actions
Playback starts from the point you stopped. (resume function)	→ The resume function is working. To start play from the first track, push the 3-way control key toward  and hold it for 2 seconds or more, or open the lid of the CD player. Or remove all power sources, then insert the batteries or connect the AC power adaptor again. (pages 6, 7, 16, 18)
Rustling noise of the CD is heard.	→ Close the lid of the battery compartment firmly. (page 16)
When using with a connected stereo system, the sound is distorted or noisy.	→ Adjust the volume of the CD player and the connected device. (page 15)

Specifications

System

Compact disc digital audio system

Laser diode properties

Material: GaAlAs

Wavelength: $\lambda = 780 \text{ nm}$

Emission duration: Continuous

Laser output: Less than $44.6 \mu\text{W}$

(This output is the value measured at a distance of 200 mm from the objective lens surface on the optical pick-up block with 7 mm aperture.)

D-A conversion

1-bit quartz time-axis control

Frequency response

40 - 20 000 Hz $_{-4.5}^0$ dB (measured by JEITA CP-307)

Output (at 4.5 V input level)

Headphones (stereo minijack)

Approx. 5 mW + Approx. 5 mW at 16 Ω
(Approx. 0.5 mW + Approx. 0.5 mW
at 16 Ω)*

*For the customers in Europe

Power requirements

For the area code of the model you purchased, check the upper left side of the bar code on the package.

- Sony NH-WM2AA rechargeable batteries: 2.4 V DC
- Two LR6 (size AA) batteries: 3 V DC
- AC power adaptor (DC IN 4.5 V jack):
U/U2/CA2/E92/MX2/TW2/BR3 model:
120 V, 60 Hz
CED/CET/CEW/CEX/CE7/EE/EE1/E13/G5/
G6/G7/G8/BR1 model: 220 - 230 V, 50/60 Hz
CEK/3CE7 model: 230 - 240 V, 50 Hz
AU2 model: 240 V, 50 Hz
JE.W/E33/EA3/KR4 model: 100 - 240 V,
50/60 Hz
HK2 model: 220 V, 50/60 Hz
AR1/CNA model: 220 V, 50 Hz

Battery life* (approx. hours)

(When you use the CD player on a flat and stable surface.)

Playing time varies depending on how the CD player is used.

When using	G-PROTECTION function	
	1	2
NH-WM2AA (charged for about 5 hours**)	30	32
Two Sony alkaline batteries LR6(SG) (produced in Japan)	47	50

* Measured value by the standard of JEITA (Japan Electronics and Information Technology Industries Association).

** Charging time varies depending on how the rechargeable battery is used.

Operating temperature

5°C - 35°C (41°F - 95°F)

Dimensions (w/h/d) (including projecting parts and controls)

Approx. 133.9 × 38.1 × 147.5 mm
(5 $\frac{3}{8}$ × 1 $\frac{1}{2}$ × 5 $\frac{7}{8}$ in.)

Mass (excluding accessories)

Approx. 305 g (10.8 oz.)

Design and specifications are subject to change without notice.

Accessories (supplied/optional)

Supplied accessories

For the area code of the location in which you purchased the CD player, check the upper left side of the bar code on the package.

- AC power adaptor (1)
- Headphones/earphones (1)
- Hand strap (1)

Optional accessories

AC power adaptor	AC-E45HG
Active speaker system	SRS-Z500 SRS-T1
Car battery cord	DCC-E345
Car battery cord with car connecting pack	DCC-E34CP
Car connecting pack	CPA-9C
Connecting cord	RK-G129 RK-G136
Rechargeable battery	NH-WM2AA
Earphones (except for the customers in France)	MDR-E848LP MDR-EX70LP MDR-A44L MDR-A110LP
Earphones (for the customers in France)	MDR-E808LP

When using optional headphones, use only headphones with stereo miniplugs. You cannot use headphones with micro plugs.

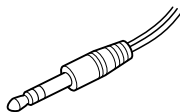

Stereo miniplug

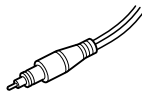

Micro plug

Your dealer may not handle some of the above listed accessories. Please ask the dealer for detailed information about the accessories in your country.

<http://www.sony.net/>

Free Manuals Download Website

<http://myh66.com>

<http://usermanuals.us>

<http://www.somanuals.com>

<http://www.4manuals.cc>

<http://www.manual-lib.com>

<http://www.404manual.com>

<http://www.luxmanual.com>

<http://aubethermostatmanual.com>

Golf course search by state

<http://golfingnear.com>

Email search by domain

<http://emailbydomain.com>

Auto manuals search

<http://auto.somanuals.com>

TV manuals search

<http://tv.somanuals.com>