

DVD Recorder

Operating Instructions

RDR-HX715



WARNING

To reduce the risk of fire or electric shock, do not expose this apparatus to rain or moisture.

To avoid electrical shock, do not open the cabinet. Refer servicing to qualified personnel only.

The AC power cord must be changed only at a qualified service shop.

CAUTION

The use of optical instruments with this product will increase eye hazard. As the laser beam used in this DVD recorder is harmful to eyes, do not attempt to disassemble the cabinet.

Refer servicing to qualified personnel only.

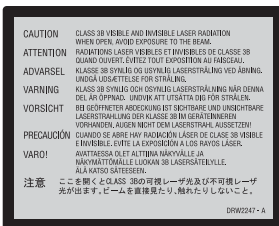

This label is located on the laser protective housing inside the enclosure.



This symbol is intended to alert the user to the presence of uninsulated "dangerous voltage" within the product's enclosure that may be of sufficient magnitude to constitute a risk of electric shock to persons.



This symbol is intended to alert the user to the presence of important operating and maintenance (servicing) instructions in the literature accompanying the appliance.

For customers in the U.S.A

Owner's Record

The model and serial numbers are located at the rear of the unit.

Record the serial number in the space provided below. Refer to them whenever you call upon your Sony dealer regarding this product.

Model No. RDR-HX715

Serial No. _____

CAUTION

You are cautioned that any changes or modifications not expressly approved in this manual could void your authority to operate this equipment.

Note

This equipment has been tested and found to comply with the limits for a Class B digital device, pursuant to Part 15 of the FCC Rules. These limits are designed to provide reasonable protection against harmful interference in a residential installation. This equipment generates, uses, and can radiate radio frequency energy and, if not installed and used in accordance with the instructions, may cause harmful interference to radio communications. However, there is no guarantee that interference will not occur in a particular installation. If this equipment does cause harmful interference to radio or television reception, which can be determined by turning the equipment off and on, the user is encouraged to try to correct the interference by one or more of the following measures:

- Reorient or relocate the receiving antenna.
- Increase the separation between the equipment and receiver.
- Connect the equipment into an outlet on a circuit different from that to which the receiver is connected.
- Consult the dealer or an experienced radio/TV technician for help.

In the United States, TV GUIDE and other related marks are registered marks of Gemstar-TV Guide International, Inc. and/or one of its affiliates. In Canada, TV GUIDE is a registered mark of Transcontinental Inc., and is used under license by Gemstar-TV Guide International, Inc. The TV Guide On Screen system is manufactured under license from Gemstar-TV Guide International, Inc. and/or one of its affiliates.

The TV Guide On Screen system is protected by one or more of the following issued United States patents 6,498,895; 6,418,556; 6,331,877; 6,239,794; 6,154,203; 5,940,073; 4,908,713; 4,751,578; 4,706,121. Gemstar-TV Guide International, Inc. and/or its related affiliates are not in any way liable for the accuracy or availability of the program schedule information or other data in the TV Guide On Screen system and cannot guarantee service availability in your area. In no event shall Gemstar-TV Guide International, Inc. and/or its related affiliates be liable for any damages in connection with the accuracy or availability of the program schedule information or other data in the TV Guide On Screen system.

Precautions

This equipment has been tested and found to comply with the limits set out in the EMC Directive using a connection cable shorter than 3 meters.

On safety

Should any solid object or liquid fall into the cabinet, unplug the recorder and have it checked by qualified personnel before operating it any further.

About the hard disk drive

The hard disk has a high storage density, which enables long recording durations and quick access to the written data. However, it can easily be damaged by shock, vibration or dust, and should be kept away from magnets. To avoid losing important data, observe the following precautions.

- Do not apply a strong shock to the recorder.
- Do not place the recorder in a location subject to mechanical vibrations or in an unstable location.
- Do not place the recorder on top of a hot surface, such as a VCR or amplifier (receiver).
- Do not use the recorder in a place subject to extreme changes in temperature (temperature gradient less than 10 °C/hour).
- Do not move the recorder with its AC power cord connected.
- Do not disconnect the AC power cord while the power is on.
- When disconnecting the AC power cord, turn off the power and make sure that the hard disk drive is not operating (the clock is displayed in the front panel display and all recording or dubbing has stopped).
- Do not move the recorder for one minute after you have unplugged the AC power cord.
- Do not attempt to replace or upgrade the hard disk by yourself, as this may result in malfunction.

If the hard disk drive should malfunction, you cannot recover lost data. The hard disk drive is only a temporary storage space.

About repairing the hard disk drive

- The contents of the hard disk drive may be checked in case of repair or inspection during a malfunction or modification. However, the contents will not be backed up or saved by Sony.
- If the hard disk needs to be formatted or replaced, it will be done at the discretion of Sony. All contents of the hard disk drive will be erased, including contents that violate copyright laws.

On power sources

- The recorder is not disconnected from the AC power source as long as it is connected to the wall outlet, even if the recorder itself has been turned off.
- If you are not going to use the recorder for a long time, be sure to disconnect the recorder from the wall outlet. To disconnect the AC power cord, grasp the plug itself; never pull the cord.
- Before disconnecting the AC power cord, check that the recorder's hard disk is not operating (recording or dubbing) on the front panel display.

On placement

- Place the recorder in a location with adequate ventilation to prevent heat build-up in the recorder.
- Do not place the recorder on a soft surface such as a rug that might block the ventilation holes.
- Do not place the recorder in a confined space such as a bookshelf or similar unit.
- Do not place the recorder in a location near heat sources, or in a place subject to direct sunlight, excessive dust, or mechanical shock.
- Do not place the recorder in an inclined position. It is designed to be operated in a horizontal position only.

- Keep the recorder and discs away from equipment with strong magnets, such as microwave ovens, or large loudspeakers.
- Do not place heavy objects on the recorder.
- To prevent fire or shock hazard, do not place objects filled with liquids, such as vases, on the apparatus.

On recording

Make trial recordings before making the actual recording.

On compensation for lost recordings

Sony is not liable and will not compensate for any lost recordings or relevant losses, including when recordings are not made due to reasons including recorder failure, or when the contents of a recording are lost or damaged as a result of recorder failure or repair undertaken to the recorder. Sony will not restore, recover, or replicate the recorded contents under any circumstances.

Copyrights

- Television programs, films, video tapes, discs, and other materials may be copyrighted. Unauthorized recording of such material may be contrary to the provisions of the copyright laws. Also, use of this recorder with cable television transmission may require authorization from the cable television transmitter and/or program owner.
- This product incorporates copyright protection technology that is protected by U.S. patents and other intellectual property rights. Use of this copyright protection technology must be authorized by Macrovision, and is intended for home and other limited viewing uses only unless otherwise authorized by Macrovision. Reverse engineering or disassembly is prohibited.

Copy guard function

Since the recorder has a copy guard function, programs received through an external tuner (not supplied) may contain copy protection signals (copy guard function) and as such may not be recordable, depending on the type of signal.

IMPORTANT NOTICE

Caution: This recorder is capable of holding a still video image or on-screen display image on your television screen indefinitely. If you leave the still video image or on-screen display image displayed on your TV for an extended period of time you risk permanent damage to your television screen. Plasma display panels and projection televisions are especially susceptible to this.

If you have any questions or problems concerning your recorder, please consult your nearest Sony dealer.

Important Safety Instructions

- 1) Read these instructions.
- 2) Keep these instructions.
- 3) Heed all warnings.
- 4) Follow all instructions.
- 5) Do not use this apparatus near water.
- 6) Clean only with dry cloth.
- 7) Do not block any ventilation openings. Install in accordance with the manufacturer's instructions.
- 8) Do not install near any heat sources such as radiators, heat registers, stoves, or other apparatus (including amplifiers) that produce heat.
- 9) Do not defeat the safety purpose of the polarized or grounding-type plug. A polarized plug has two blades with one wider than the other. A grounding type plug has two blades and a third grounding prong. The wide blade or the third prong are provided for your safety. If the provided plug does not fit into your outlet, consult an electrician for replacement of the obsolete outlet.

- 10) Protect the power cord from being walked on or pinched particularly at plugs, convenience receptacles, and the point where they exit from the apparatus.
- 11) Only use attachments/accessories specified by the manufacturer.
- 12) Use only with the cart, stand, tripod, bracket, or table specified by the manufacturer, or sold with the apparatus. When a cart is used, use caution when moving the cart/apparatus combination to avoid injury from tip-over.



- 13) Unplug this apparatus during lightning storms or when unused for long periods of time.
- 14) Refer all servicing to qualified service personnel. Servicing is required when the apparatus has been damaged in any way, such as power-supply cord or plug is damaged, liquid has been spilled or objects have fallen into the apparatus, the apparatus has been exposed to rain or moisture, does not operate normally, or has been dropped.

About this manual

- In this manual, the internal hard disk drive is written as "HDD," and "disc" is used as a general reference for the HDD, DVDs, or CDs unless otherwise specified by the text or illustrations.
- Instructions in this manual describe the controls on the remote. You can also use the controls on the recorder if they have the same or similar names as those on the remote.
- The on-screen display illustrations used in this manual may not match the graphics displayed on your TV screen.
- The explanations regarding DVDs in this manual refer to DVDs created on this recorder. The explanations do not apply to DVDs that are created on other recorders and played back on this recorder.

Table of Contents

WARNING	2
Precautions	3
Ways to Use Your DVD Recorder	9
Quick Guide to Disc Types	10
Recordable and playable discs	10
Playable discs	12

Hookups and Settings	14
Hooking Up the Recorder	14
Step 1: Unpacking	14
Step 2: Connecting the Antenna Cable and Set Top Box Controller	14
Using the cable box/satellite receiver control function.	14
A: Cable box or satellite receiver with a video/audio output	15
B: Cable box with an antenna output only	16
C: Cable without cable box, or antenna only (no cable TV)	17
Step 3: Connecting the Video Cords/HDMI Cords	18
Using the PROGRESSIVE button	19
Step 4: Connecting the Audio Cords	20
Step 5: Connecting the Power Cord	21
Step 6: Preparing the Remote	22
Controlling TVs with the remote	22
Controlling the volume of your AV amplifier (receiver) with the remote.	24
If you have a Sony DVD player or more than one Sony DVD recorder.	24
Step 7: Easy Setup	25
Checking the cable box/satellite receiver control setting.	26
Connecting a VCR or Similar Device	28
Connecting to the LINE IN 1 or 3 jacks	28
Connecting to the LINE 2 IN jacks on the front panel	29
Connecting to a Satellite or Digital Tuner	30

Seven Basic Operations — Getting to Know Your DVD Recorder

1. Inserting and Formatting a DVD Disc (Disc Info)	31
Inserting a Disc	31
Formatting a DVD disc (Disc Info)	31
2. Recording a Program	33
Checking the disc status while recording	34
3. Playing the Recorded Program (Title List)	34
4. Displaying the Playing Time and Play Information	36
Checking the playing/remaining time.	37
5. Changing the Name of a Recorded Program	38
6. Labeling and Protecting a Disc	39
Labeling a disc.	39
Protecting a disc	40
7. Playing the Disc on Other DVD Equipment (Finalize)	40
Unfinalizing a disc	41

TV GUIDE	42
Introduction to the TV Guide On Screen System	42
Troubleshooting guide	42
Watching TV with the TV Guide On Screen System	43
Setting the "Remind" Timer	45
Searching for a Program with the TV Guide On Screen System	46
Customizing the TV Guide On Screen System	47
<hr/>	
Timer Recording	49
Before Recording	49
Recording mode	49
Recording a stereo/SAP program	50
Unrecordable pictures	50
Timer Recording (TV GUIDE/Manual)	50
Recording with the TV Guide On Screen system (TV GUIDE)	50
Setting the timer manually	52
Using the Quick Timer function	53
Adjusting the recording picture quality and size	53
Creating chapters in a title	54
Changing/Canceling Timer Recording or Reminder Settings	55
Recording From Connected Equipment	56
Recording from connected equipment with a timer (Synchro Rec)	56
Recording from connected equipment without a timer	57
<hr/>	
Playback	59
Playing	59
Playing titles with the TV Guide On Screen system	59
Playback options	61
Adjusting the picture quality	63
Adjusting the sound quality	64
Pausing a TV Broadcast (TV Pause)	65
Playing from the beginning of the program you are recording (Chasing Playback)	65
Playing a previous recording while making another (Simultaneous Rec and Play)	66
Searching for a Title/Chapter/Track, etc.	67
Searching by Thumbnail (Visual Search)	67
Searching by title number or time code	67
Playing MP3 Audio Tracks or JPEG Image Files	68
Selecting an MP3 album or track	68
Selecting a JPEG album or image	69
About MP3 audio tracks and JPEG image files	70
MP3 audio tracks or JPEG image files that the recorder can play	70
About playback order of albums, tracks, and files	71

Erasing and Editing	72
Before Editing	72
Edit options for the HDD and DVD-RWs (VR mode)	72
Edit options for DVD+RWs/DVD-RWs (Video mode)/DVD+Rs/DVD-Rs	73
Erasing and Editing a Title	73
Erasing a chapter (Delete Chapter)	74
Erasing a section of a title (A-B Erase)	74
Erasing multiple titles (Erase Titles)	75
Dividing a title (Divide Title)	75
Erasing all titles on the disc	76
Erasing titles to open up disc space (Disc Map)	76
Creating chapters manually	76
Creating and Editing a Playlist	77
Moving a Playlist title (Change Order)	78
Combining multiple Playlist titles (Combine Titles)	78
Dividing a Playlist title (Divide Title)	78
Dubbing (HDD ↔ DVD)	79
Before Dubbing	79
About "Dub Mode"	79
Dubbing	81
Dubbing a single title (Title Dub)	81
Dubbing multiple titles (Dub Selected Titles)	82
DV/Digital8 Dubbing	84
Before DV/Digital8 Dubbing	84
Preparing for DV/Digital8 dubbing	84
Recording an Entire DV/Digital8 Format Tape (One Touch Dubbing)	85
Program Edit	86
Settings and Adjustments	88
Antenna Reception and Language Settings (Settings)	88
Tuner Preset	88
Area Setup	89
Clock	89
Set Top Box Control	90
Language	90
Video Settings (Video)	91
Audio Settings (Audio)	93
Recording and Parental Control Settings (Features)	96
Disc and Remote Control Settings/Factory Settings (Options)	98
Easy Setup (Resetting the Recorder)	99

Additional Information	100
Troubleshooting	100
Self-diagnosis Function (When letters/numbers appear in the display)	106
Notes About This Recorder	106
Specifications	107
About i.LINK	108
Guide to Parts and Controls	110
Glossary	114
Language Code List	116
Area Code	116
Cable Box/Satellite Receiver Brand Code	117
Index	122

Ways to Use Your DVD Recorder

Recording/Playback

Compatible media and reference pages

Quick access to recorded titles
– Title List



HDD **+RW** **-RWVR** **-RW_{Video}** **+R** **-R**

“3. Playing the Recorded Program (Title List)” on page 34

Easily search for programs with the TV Guide On Screen system
– TV Guide



HDD **+RW** **-RWVR** **-RW_{Video}** **+R** **-R**

The TV Guide On Screen system displays a free interactive program guide. Search for your favorite program by listing them alphabetically, by category or by keyword (page 46). You can then set the timer to record that program just by selecting it (page 50).

Play the beginning of a title while it is being recorded
– Chasing Playback



HDD **-RWVR**

“Playing from the beginning of the program you are recording (Chasing Playback)” on page 65

Watching one title while recording another
– Simultaneous Rec and Play



HDD **+RW** **-RWVR** **-RW_{Video}** **+R** **-R**
VCD **CD** **DATA DVD** **DATA CD**

“Playing a previous recording while making another (Simultaneous Rec and Play)” on page 66

Dubbing/Editing

Compatible media and reference pages

Creating your own program
– Playlist



HDD **-RWVR**

“Creating and Editing a Playlist” on page 77

Copying a recorded title to and from the HDD
– Dubbing (HDD ↔ DVD)



HDD **+RW** **-RWVR** **-RW_{Video}** **+R** **-R**

“Dubbing (HDD ↔ DVD)” on page 79

Automatic dubbing of DV tapes
– DV/Digital8 Dubbing







HDD **+RW** **-RWVR** **-RW_{Video}** **+R** **-R**

“DV/Digital8 Dubbing” on page 84

A list of recordable and playable discs is on page 10.

Quick Guide to Disc Types

Recordable and playable discs

Type	Disc Logo	Icon used in this manual	Formatting (new discs)	Compatibility with other DVD players (finalizing)	
Hard disk drive (internal)			(Formatting unnecessary)	Dub HDD contents to a DVD to play on other DVD players	
DVD+RW	 DVD+ReWritable  DVD+ReWritable		Automatically formatted in +VR mode	Playable on DVD+RW compatible players (automatically finalized)	
DVD-RW	VR mode	 DVD-RW *2		Format in VR mode (page 31)	Playable only on VR mode compatible players (finalization unnecessary)
	Video mode	 DVD-RW 		Format in Video mode (page 31)	Playable on most DVD players (finalization necessary) (page 40)
DVD+R	 DVD+R		Automatically formatted	Playable on most DVD players (finalization necessary) (page 40)	
DVD+R DL	 DVD+R DL				
DVD-R	 DVD-R R4.7		Automatically formatted	Playable on most DVD players (finalization necessary) (page 40)	

Usable disc versions (as of March 2005)

- 8x-speed or slower DVD+RWs
- 6x-speed or slower DVD-RWs (Ver.1.1, Ver.1.2 with CPRM^{*1})
- 16x-speed or slower DVD+Rs
- 16x-speed or slower DVD-Rs (Ver.2.0, Ver.2.1)
- 2.4x-speed DVD+R DL (Double Layer) discs

“DVD+RW,” “DVD-RW,” “DVD+R,” “DVD+R DL,” and “DVD-R” are trademarks.

*1 CPRM (Content Protection for Recordable Media) is a coding technology that protects copyrights for images.

*2 This logo applies to 4x and 6x speed DVD-RW discs.

	Recording Features				Editing Features			
	Rewrite (page 49)	Auto Chapter (page 96)	Manual Chapter (page 76)	Record 16:9 sizes (page 53)	Change title name (page 73)	Delete title (page 75)	A-B Erase (page 74)	Playlist (page 77)
	Yes	Yes	Yes	Yes	Yes	Yes	Yes	Yes
	Yes	Yes	No	No	Yes	Yes	Yes	No
	Yes	Yes	Yes	Yes	Yes	Yes	Yes	Yes
	Yes	Yes	No	Yes* ³	Yes	Yes	No	No
	No	Yes	No	No	Yes	Yes* ⁴	No	No
	No	Yes	No	Yes* ³	Yes	Yes* ⁴	No	No









Discs that cannot be recorded on

- 8 cm discs
- DVD-Rs in VR mode (Video Recording format)

*³ Only if the recording mode is LSP, SP, HSP, or HQ, and “DVD Rec. Picture Size” is set to “16:9.”

*⁴ Erasing titles does not free up disc space.

Playable discs

Type	Disc Logo	Icon used in this manual	Characteristics
DVD VIDEO			Discs such as movies that can be purchased or rented
VIDEO CD			VIDEO CDs or CD-Rs/CD-RWs in VIDEO CD/Super VIDEO CD format
CD			Music CDs or CD-Rs/CD-RWs in music CD format that can be purchased
DATA DVD	—		DVD+RWs/DVD+Rs/DVD-RWs/DVD-Rs/DVD-ROMs containing JPEG image files
DATA CD	—		CD-ROMs/CD-Rs/CD-RWs containing MP3 audio tracks or JPEG image files
8 cm DVD+RW/ DVD-RW/DVD-R	—	—	8 cm DVD+RW, DVD-RW, and DVD-R recorded with a DVD video camera. (Still images recorded with a DVD video camera cannot be played.)

“DVD VIDEO” and “CD” are trademarks.

Discs that cannot be played

- PHOTO CDs
- CD-ROMs/CD-Rs/CD-RWs that are not recorded in music CD or Video CD format, or do not contain MP3 or JPEG files
- Data part of CD-Extras
- DVD-ROMs that do not contain JPEG files or are not in DVD Video format
- DVD Audio discs
- DVD-RAMs
- HD layer on Super Audio CDs
- DVD VIDEOS with a different region code (page 13)
- DVD-Rs recorded in VR mode (Video Recording format)
- A disc recorded in a color system other than NTSC, such as PAL

Maximum recordable number of titles

Disc	Number of titles*
HDD	300
DVD-RW/DVD-R	99
DVD+RW/DVD+R	49
DVD+R DL	49

* The maximum length for each title is eight hours.

Note on playback operations of DVD VIDEOS/VIDEO CDs

Some playback operations of DVD VIDEOS/VIDEO CDs may be intentionally set by software producers. Since this recorder plays DVD VIDEOS/VIDEO CDs according to the disc contents the software producers designed, some playback features may not be available. Also, see the instructions supplied with the DVD VIDEOS/VIDEO CDs.

Region code (DVD VIDEO only)

Your recorder has a region code printed on the rear of the unit and will only play DVD VIDEOS (playback only) labeled with identical region codes. This system is used to protect copyrights. DVD VIDEOS labeled  will also play on this recorder.

If you try to play any other DVD VIDEO, the message "Playback prohibited by region code." will appear on the TV screen. Depending on the DVD VIDEO, no region code indication may be labeled even though playing the DVD VIDEO is prohibited by area restrictions.

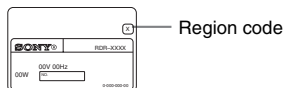

Music discs encoded with copyright protection technologies

This product is designed to play back discs that conform to the Compact Disc (CD) standard. Recently, various music discs encoded with copyright protection technologies are being marketed by some record companies. Please be aware that among those discs, there are some that do not conform to the CD standard and may not be playable by this product.

Note on DualDiscs

A DualDisc is a two sided disc product which mates DVD recorded material on one side with digital audio material on the other side. However, since the audio material side does not conform to the Compact Disc (CD) standard, playback on this product is not guaranteed.

Notes

- Some DVD+RWs/DVD+Rs, DVD-RWs/DVD-Rs, or CD-RWs/CD-Rs cannot be played on this recorder due to the recording quality or physical condition of the disc, or the characteristics of the recording device and authoring software. The disc will not play if it has not been correctly finalized. For more information, see the operating instructions for the recording device.
- You cannot mix VR mode and Video mode on the same DVD-RW. To change the disc's format, reformat the disc (page 31). Note that the disc's contents will be erased after reformatting.
- You cannot shorten the time required for recording even with high-speed discs.
- It is recommended that you use discs with "For Video" printed on their packaging.
- You cannot add new recordings to DVD+Rs, DVD-Rs, or DVD-RWs (Video mode) that contain recordings made on other DVD equipment.
- In some cases, you may not be able to add new recordings to DVD+RWs that contain recordings made on other DVD equipment. If you do add a new recording, note that this recorder will rewrite the DVD menu.
- You cannot edit recordings on DVD+RWs, DVD-RWs (Video mode), DVD+Rs, or DVD-Rs that are made on other DVD equipment.
- If the disc contains PC data unrecognizable by this recorder, the data may be erased.
- You may not be able to record on some recordable discs, depending on the disc.

Hooking Up the Recorder

Follow steps 1 to 7 to hook up and adjust the settings of the recorder.

🔌 Notes

- Plug cords securely to prevent unwanted noise.
- Refer to the instructions supplied with the components to be connected.
- You cannot connect this recorder to a TV that does not have a video input jack.
- Be sure to disconnect the power cord of each component before connecting.

Step 1: Unpacking

Check that you have the following items:

- Audio/video cord (phono plug × 3 ↔ phono plug × 3) (1)
- Power cord (1)
- Antenna cable (1)
- Remote commander (remote) (1)
- Set top box controller (1)
- Size AA (R6) batteries (2)

Step 2: Connecting the Antenna Cable and Set Top Box Controller

Select one of the following antenna hookups. Do not connect the power cord until you reach “Step 5: Connecting the Power Cord” on page 21.

If you have	Hookup
Cable box or satellite receiver with a video/audio output	A (page 15)
Cable box with an antenna output only	B (page 16)
Cable without cable box, or antenna only (no cable TV)	C (page 17)

Using the cable box/satellite receiver control function

The cable box/satellite receiver control function can be used with hookup A or B. It allows the recorder to control a cable box or satellite receiver via the supplied set top box controller. The recorder controls channels on the cable box or satellite receiver for timer recording. You can also use the recorder’s remote control to change channels on the cable box/satellite receiver whenever the cable box/satellite receiver and recorder are turned on.

To use the cable box/satellite receiver control function, you need to connect the set top box controller and set the code number and output channel (page 25). After setting up the cable box/satellite receiver control, check that the recorder can correctly control the cable box or satellite receiver (page 26).

NOTE TO CATV SYSTEM INSTALLER (IN USA)

This reminder is provided to call the CATV system installer’s attention to Article 820- 40 of the NEC that provides guidelines for proper grounding and, in particular, specifies that the cable ground shall be connected to the grounding system of the building, as close to the point of cable entry as practical.

🔌 Notes

- If your antenna is a flat cable (300-ohm twin lead cable), use an external antenna connector (not supplied) to connect the antenna to the recorder.
- If you have separate cables for VHF and UHF antennas, use a UHF/VHF band mixer (not supplied) to connect the antenna to the recorder.
- If you have made hookup A or B and want to use the TV Guide On Screen system, the cable box must be turned on, the set top box controller must be connected, and “Set Top Box Control” in “Settings” setup must be set to “On” (page 90) to download the TV Guide On Screen data.

A: Cable box or satellite receiver with a video/audio output

With this hookup, you can record any channel on the cable box or satellite receiver. Be sure that the satellite receiver or cable box is turned on.

To watch cable or satellite programs, you need to match the channel on the recorder (L1 or L3) to the input jack connected to the cable box or satellite receiver (LINE IN 1 or 3). Note that the TV Guide On Screen system does not display listings for satellite programming.

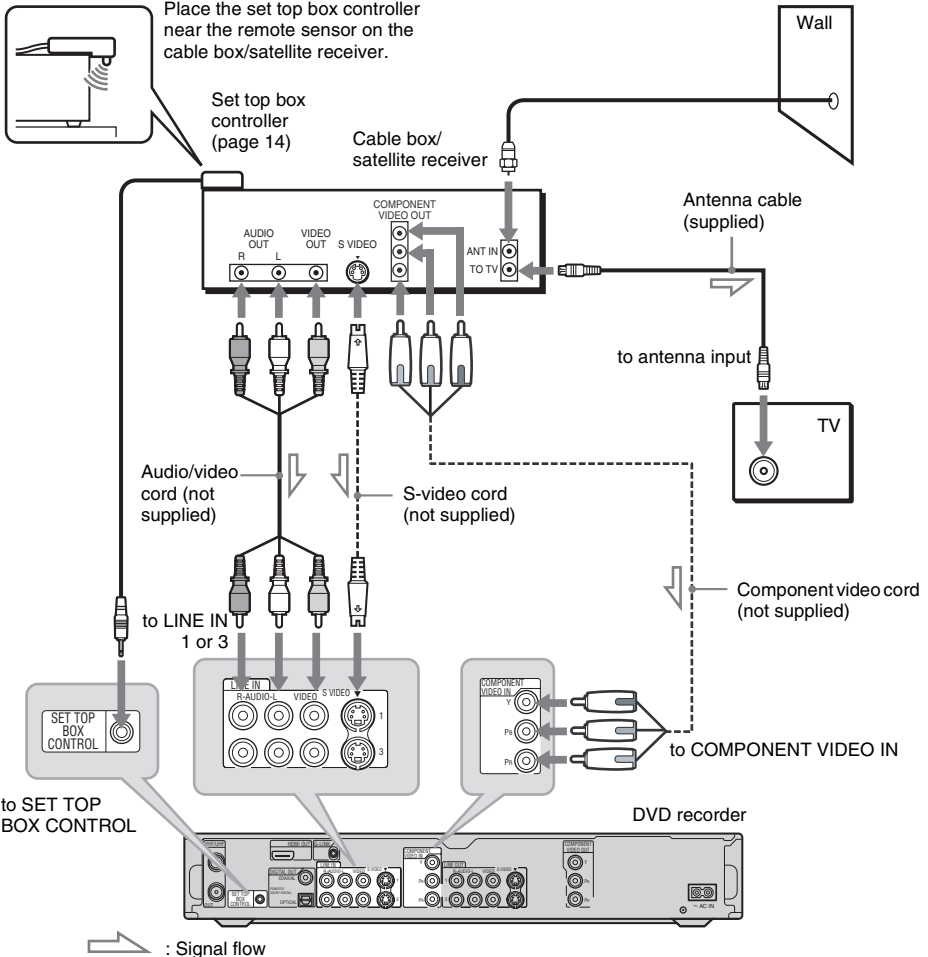

Note

Do not connect a hi-definition tuner using the component video cords. This recorder only accepts standard definition interlace signals.

Hints

- If your cable box or satellite receiver has an S-video jack or component output jacks, you can use an S-video cord (not supplied) or component video cord (not supplied) instead of the audio/video cord. When you connect using a component video cord, connect the audio cords to the LINE IN jacks.
- If you connect an S-video cord to the LINE IN 1 jack or component video cord to the COMPONENT VIDEO IN jacks, set "Line 1 Input" in "Video" setup to "S Video" or "Component" (page 93). If you connect an S-video cord to the LINE IN 3 jack, set "Line 3 Input" in "Video" setup to "S Video" (page 93).

B: Cable box with an antenna output only

With this hookup, you can record any channel on the satellite receiver or cable box. Be sure that the satellite receiver or cable box is turned on.

To watch cable programs, you need to match the channel on the recorder (2ch, 3ch, or 4ch) to the antenna output channel on the cable box (2ch, 3ch, or 4ch).

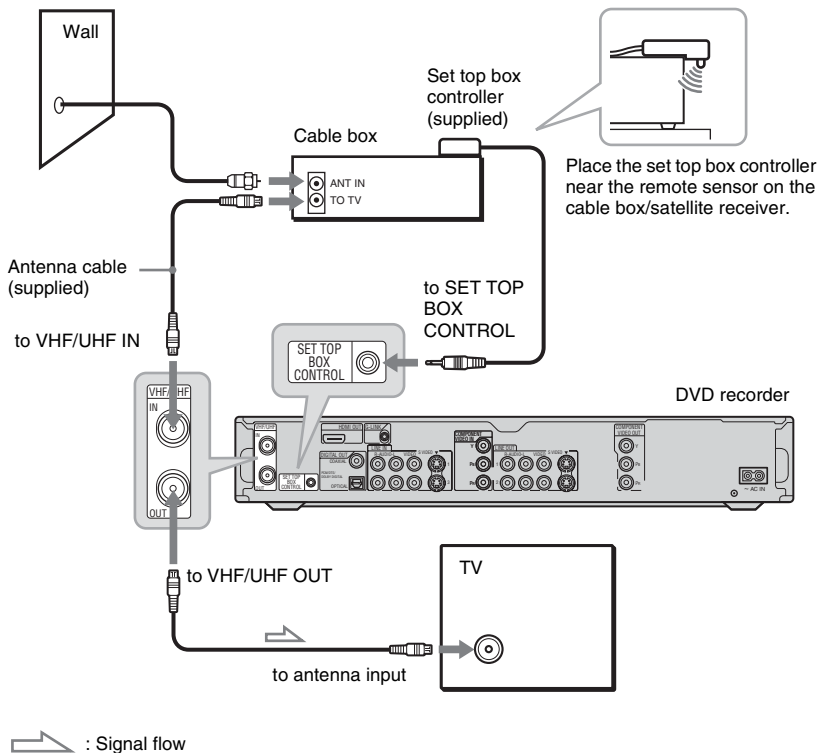

C: Cable without cable box, or antenna only (no cable TV)

Use this hookup if you watch cable channels without a cable box. Also use this hookup if you are using a VHF/UHF antenna or separate VHF and UHF antennas. With this hookup, you can record any channel by selecting the channel on the recorder.

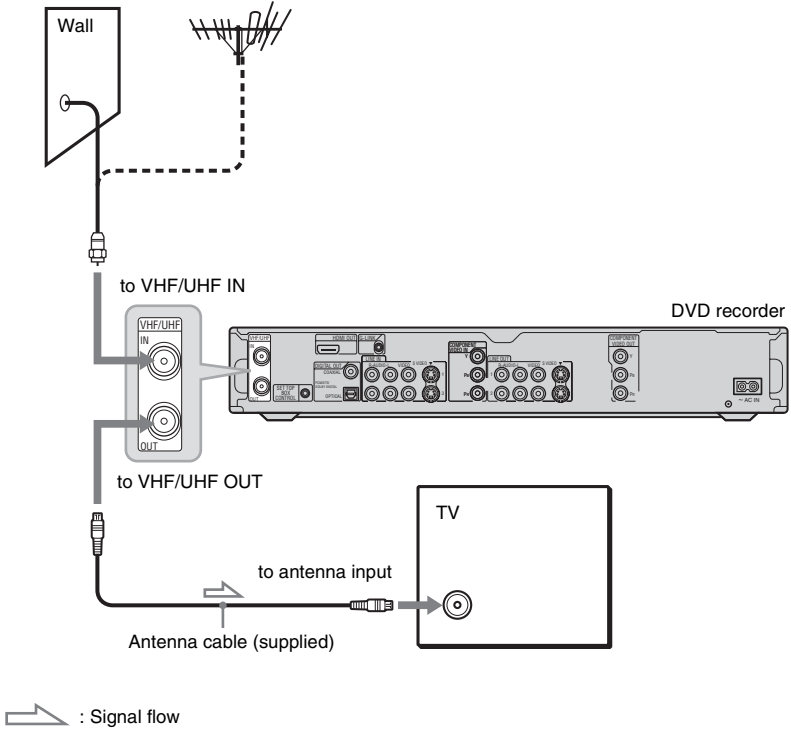

Step 3: Connecting the Video Cords/HDMI Cords

Select one of the following patterns **A** through **D**, according to the input jack on your TV monitor, projector, or AV amplifier (receiver). This will enable you to view pictures.

A Connecting to a video input jack

You will enjoy standard quality images.

B Connecting to an S VIDEO input jack

You will enjoy high quality images.

C Connecting to component video input jacks (Y, P_B, P_R)

You will enjoy accurate color reproduction and high quality images.

If your TV accepts progressive 480p format signals, you must use this connection and then press PROGRESSIVE on the remote to send progressive video signals. For details, see “Using the PROGRESSIVE button” on page 19.

D Connecting to an HDMI input jack

Use a certified HDMI cord (not supplied) to enjoy high quality digital picture and sound through the HDMI OUT jack.

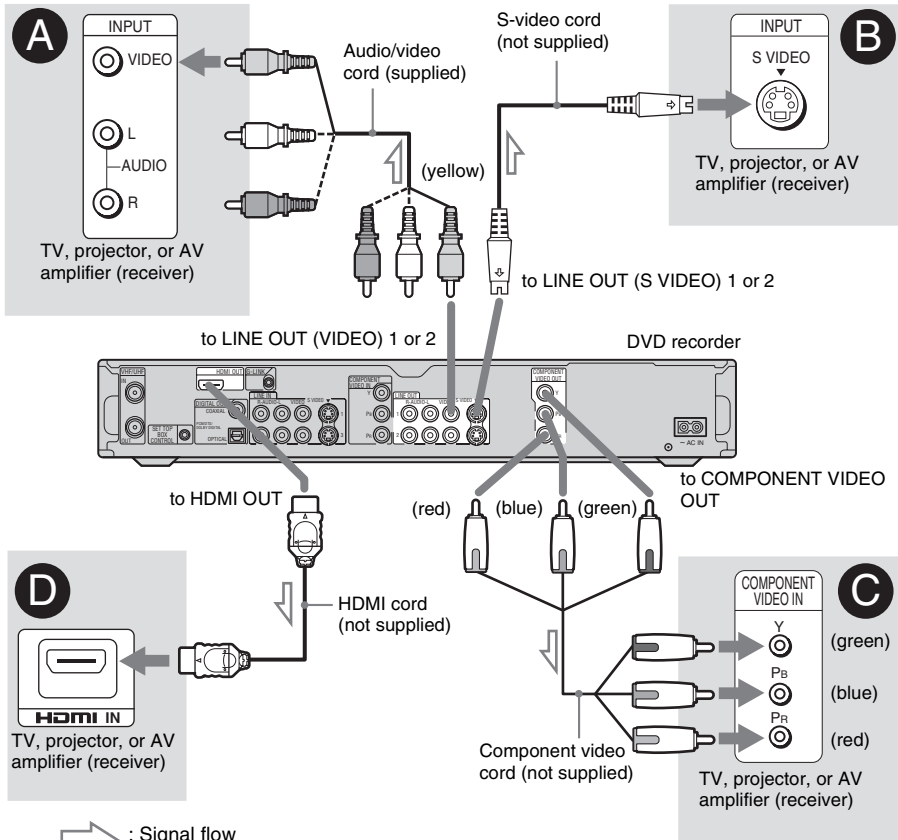

When playing “wide screen” images

Some recorded images may not fit your TV screen. To change the picture size, see page 91.

If you are connecting to a VCR

Connect your VCR to the LINE IN jack on the recorder (page 28).

Notes

- Do not connect more than one type of video cord between the recorder and your TV at the same time.
- You cannot use the PROGRESSIVE button with the connections **A** and **B**.
- You cannot connect the HDMI OUT jack (connection **D**) to DVI jacks that are not HDCP compliant (e.g., DVI jacks on PC displays).

* This DVD recorder is based on version 1.1 of High-Definition Multimedia Interface Specifications.

This DVD recorder incorporates High-Definition Multimedia Interface (HDMI™) technology.

HDMI, the HDMI logo and High-Definition Multimedia Interface are trademarks or registered trademarks of HDMI Licensing LLC.

Using the PROGRESSIVE button

By using the PROGRESSIVE button, you can select the signal format in which the recorder outputs video signals: interlace or progressive.

- 1 Connect the recorder using the COMPONENT VIDEO OUT jacks (pattern  on page 18).
- 2 Press the PROGRESSIVE button repeatedly. “PROGRESSIVE” appears in the front panel display when the recorder outputs progressive signals.

◆ Progressive

Select this when:

- your TV accepts progressive signals, and,
- the TV is connected to the COMPONENT VIDEO OUT jacks.

Note that the pictures will not be clear or no picture will appear if you select progressive signal output when either of the above conditions is not met.

◆ Interlace

Set to this position when:

- your TV does not accept progressive signals, or,
- your TV is connected to jacks other than the COMPONENT VIDEO OUT jacks (LINE OUT (VIDEO or S VIDEO)).

Hint

When you select progressive signal output, you can fine-tune the signal according to the type of software you are watching (page 92).

Step 4: Connecting the Audio Cords

Select one of the following patterns **A** or **B**, according to the input jack on your TV monitor, projector, or AV amplifier (receiver). This will enable you to listen to sound.

A Connecting to audio L/R (left/right) input jacks

This connection will use your TV's or stereo amplifier's (receiver's) two speakers for sound. You can enjoy the following surround effects (page 61).

- TV: Dynamic, Wide, Night
- Stereo amplifier (receiver): Standard, Night

B Connecting to a digital audio input jack

If your AV amplifier (receiver) has a Dolby[®]*1 Digital or DTS[®]*2 decoder and a digital input jack, use this connection. You can enjoy Dolby Digital (5.1ch) and DTS (5.1ch) surround effects.

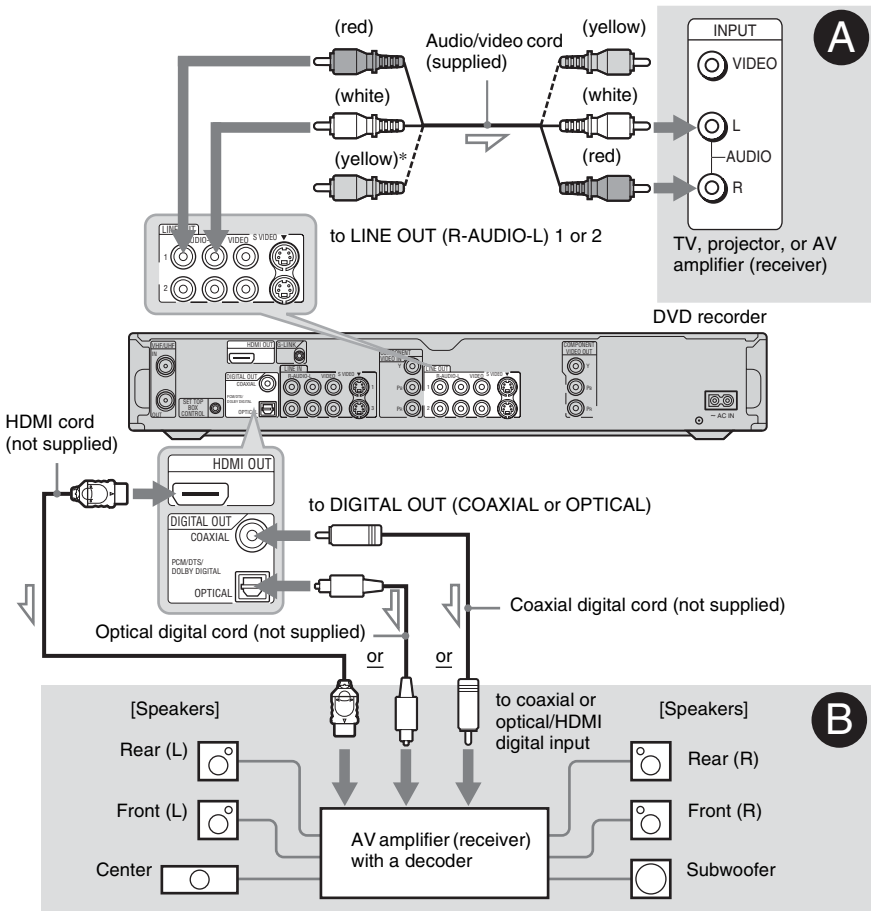

* The yellow plug is used for video signals (page 18).

Hint

For correct speaker location, see the operating instructions supplied with the connected components.

Notes

- Do not connect your TV's audio output jacks to the LINE IN (R-AUDIO-L) jacks at the same time. This will cause unwanted noise to come from your TV's speakers.
- In the connection **A**, do not connect the LINE IN (R-AUDIO-L) and LINE OUT (R-AUDIO-L) jacks to your TV's audio output jacks at the same time. This will cause unwanted noise to come from your TV's speakers.
- In the connection **B**, after you have completed the connection, make the appropriate settings under "Audio Connection" in "Easy Setup" (page 25). Otherwise, no sound or a loud noise will come from your speakers.
- With the connection **B**, the surround sound effects of this recorder cannot be used.
- When you connect the recorder to an AV amplifier (receiver) using an HDMI cord, you will need to do one of the following:
 - Connect the AV amplifier (receiver) to the TV with the HDMI cord.
 - Connect the recorder to the TV with a video cord other than HDMI cord (component video cord, S VIDEO cord, or audio/video cord).

*1 Manufactured under license from Dolby Laboratories. "Dolby" and the double-D symbol are trademarks of Dolby Laboratories.

*2 "DTS" and "DTS Digital Out" are trademarks of Digital Theater Systems, Inc.

Step 5: Connecting the Power Cord

Connect the supplied power cord to the AC IN terminal of the recorder. Then plug the recorder and TV power cords into an AC outlet. After you connect the power cord, **you must wait for a short while before operating the recorder.** You can operate the recorder once the front panel display lights up and the recorder enters standby mode.

If you connect additional equipment to this recorder (page 28), be sure to connect the power cord only after all connections are complete.

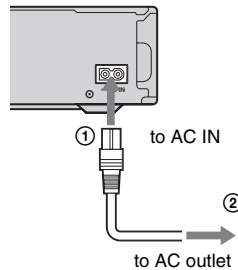

Step 6: Preparing the Remote

You can control the recorder using the supplied remote. Insert two size AA (R6) batteries by matching the ⊕ and ⊖ ends on the batteries to the markings inside the battery compartment. When using the remote, point it at the remote sensor  on the recorder.

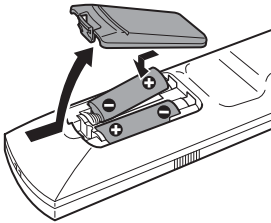

Notes

- If the supplied remote interferes your other Sony DVD recorder or player, change the command mode number for this recorder (page 24).
- Use the batteries correctly to avoid possible leakage and corrosion. Do not touch the liquid with bare hands should leakage occur. Observe the following:
 - Do not use a new battery with an old battery, or batteries of different manufacturers.
 - Do not attempt to recharge the batteries.
 - If you do not intend to use the remote for an extended period of time, remove the batteries.
 - If battery leakage occurs, wipe out any liquid inside the battery compartment, and insert new batteries.
- Do not expose the remote sensor (marked  on the front panel) to strong light, such as direct sunlight or lighting apparatus. The recorder may not respond to the remote.

Controlling TVs with the remote

You can adjust the remote's signal to control your TV.

If you connected the recorder to an AV amplifier (receiver), you can use the supplied remote to control the AV amplifier's (receiver's) volume.

Notes

- Depending on the connected unit, you may not be able to control your TV or AV amplifier (receiver) with some or all of the buttons below.
- If you enter a new code number, the code number previously entered will be erased.
- When you replace the batteries of the remote, the code number may be reset to the default setting. Set the appropriate code number again.

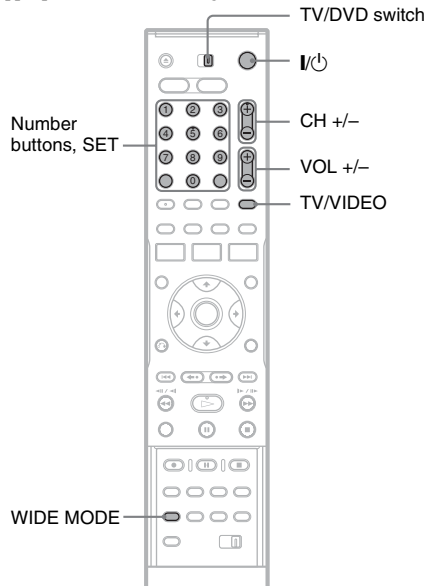

- 1** Slide the TV/DVD switch to TV.
- 2** Hold down I/Power.
- 3** Enter your TV's manufacturer code (see "Code numbers of controllable TVs" below) using the number buttons.

4 Release I/⏻.

When the TV/DVD switch is set to TV, the remote performs the following:

Buttons	Operations
I/⏻	Turns your TV on or off
VOL +/-	Adjusts the volume of your TV
CH +/-	Selects the channel on your TV
WIDE MODE	Switches to or from the wide mode of a Sony wide-screen TV
TV/VIDEO	Switches your TV's input source
Number buttons and SET	Selects the channel on your TV

Code numbers of controllable TVs

If more than one code number is listed, try entering them one at a time until you find the one that works with your TV.

Manufacturer	Code number
Sony	01 (default)
Akai	04
AOC	04
Centurion	12
Coronado	03
Curtis-Mathes	12, 14
Daewoo	04, 22
Daytron	03, 12
Fisher	11
General Electric	04, 06, 10
Gold Star/LG	03, 04, 17
Hitachi	02, 03, 04
J.C.Penney	04, 10, 12
JVC	09
KMC	03
Magnavox	03, 04, 08, 12, 21
Marantz	04, 13
MGA/Mitsubishi	04, 12, 13, 17
NEC	04, 12
Panasonic	06, 19

Manufacturer	Code number
Philco	02, 03, 04, 08
Philips	08, 21
Pioneer	06, 16
Portland	03
Proscan	10
Quasar	06, 18
Radio Shack	05, 10, 14
RCA	04, 10
Sampo	12
Samsung	03, 04, 12, 20
Sanyo	11, 14
Scott	12
Sears	07, 10, 11
Sharp	03, 05, 18
Sylvania	08, 12
Teknika	03, 08, 14
Toshiba	07, 18
Wards	03, 04, 12
Yorx	12
Zenith	14, 15

Controlling the volume of your AV amplifier (receiver) with the remote

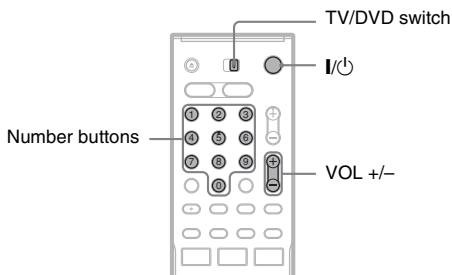

- 1** Slide the TV/DVD switch to DVD.
- 2** Hold down I/⏻, and enter the manufacturer code (see the table below) for your AV amplifier (receiver) using the number buttons.
- 3** Release I/⏻.
The VOL +/- buttons control the AV amplifier's volume.
If you want to control the TV's volume, slide the TV/DVD switch to TV.

Hint

If you want to control the TV's volume even when the TV/DVD switch is set to DVD, repeat the steps above and enter the code number 90 (default).

Code numbers of controllable AV amplifiers (receivers)

If more than one code number is listed, try entering them one at a time until you find the one that works with your AV amplifier (receiver).

Manufacturer	Code number
Sony	78, 79, 80, 91
Denon	84, 85, 86
Kenwood	92, 93
Onkyo	81, 82, 83
Pioneer	99
Sansui	87
Technics	97, 98
Yamaha	94, 95, 96

If you have a Sony DVD player or more than one Sony DVD recorder

If the supplied remote interferes with your other Sony DVD recorder or player, set the command mode number for this recorder and the supplied remote to one that differs from the other Sony DVD recorder or player.

The default command mode setting for this recorder and the supplied remote is DVD3.

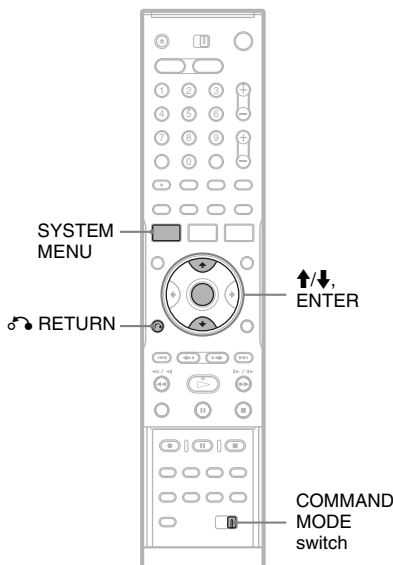

- 1** Press SYSTEM MENU.
The System Menu appears.
- 2** Select "SETUP," and press ENTER.

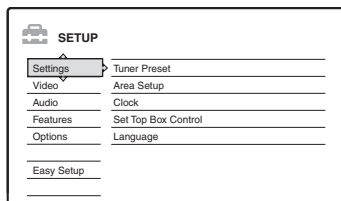

3 Select "Options," and press ENTER.

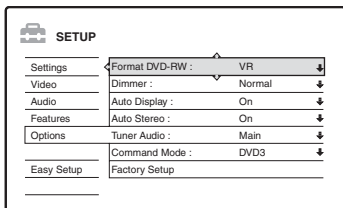

4 Select "Command Mode," and press ENTER.

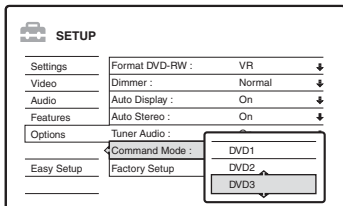

5 Select the Command mode (DVD1, DVD2, or DVD3), and press ENTER.

6 Slide the COMMAND MODE switch on the remote so it matches the mode you selected above.

To return to the previous step

Press RETURN.

Check that the command mode switch on the remote is set to the default setting of DVD3 before you try to change the command mode for the recorder. If the command mode for the remote is changed to DVD1 or DVD2, you may be unable to operate this recorder.

Step 7: Easy Setup

Make the basic adjustments by following the on-screen instructions in "Easy Setup."

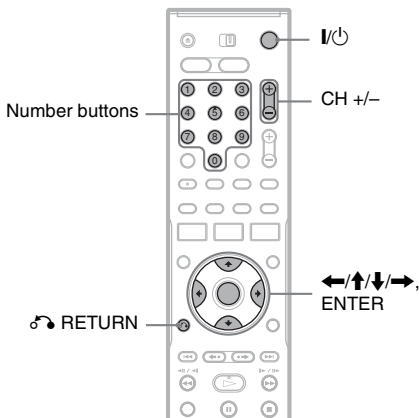

1 Turn on the recorder and switch the input selector on your TV so that the signal from the recorder appears on your TV screen.

The message about the initial settings appears.

- If this message does not appear, select "Easy Setup" from "SETUP" in the System Menu to run "Easy Setup" function ("Settings and Adjustments" on page 88).

2 Press ENTER.

Follow the on-screen instructions to make the following settings.

◆ Area Setup

"Area Setup" will enable you to use the TV Guide On Screen system (page 42).

Enter your area of residence and zip code even if you do not want to use the TV Guide On Screen system.

◆ Language

Select the language for the on-screen displays.

◆ Clock

Set the clock manually using and press ENTER.

If the clock data has already been received, go to "Set Top Box Control."

◆ Set Top Box Control

If you want to use the cable box/satellite receiver control (page 15), select “Yes,” and set the brand code and the cable box output channel (page 90).

If you do not have a cable box/satellite receiver, select “No.”

◆ Tuner Preset

“Tuner Preset” appears only when you set “Set Top Box Control” to “No.”

Select whether or not you have a cable connection.

The Tuner Preset function automatically searches for all of the receivable channels and presets them.

To set the channels manually, see page 88.

◆ TV Type

If you have a wide-screen TV, select “16:9.”

If you have a standard TV, select either “4:3 Letter Box” (shrink to fit) or “4:3 Pan Scan” (stretch to fit). This will determine how “wide-screen” images are displayed on your TV.

◆ Audio Connection

If you connected an AV amplifier (receiver) using either a digital optical or coaxial/HDMI cord, select “Yes: DIGITAL OUT” and set the digital output signal (page 94).

3 Press ENTER when “Finish” appears.

“Easy Setup” is finished.

To receive TV Guide On Screen data your recorder must be turned off when not in use. If your recorder is connected to a cable box, be sure to leave the cable box turned on. After initial setup, it may take up to 24 hours to begin to receive TV program listings. It may take up to one week to receive all eight days of TV program listings.

Checking the cable box/satellite receiver control setting

- 1 Point the DVD recorder’s remote at the recorder (not at the cable box/satellite receiver).
- 2 Press CH +/- and check that the channel changes on the cable box/satellite receiver window.
- 3 Press the number buttons and check that the channel changes on the cable box/satellite receiver window.

Tune your cable box to channel 02. Then using your DVD recorder’s remote, enter 09 to tune your cable box to channel 09. Did the cable box change to channel 09? If the cable box did not tune to channel 09, follow the instructions below for getting your recorder to control your cable box.

If you cannot get the recorder to control your cable box/satellite receiver

Check the settings at “Set Top Box Control” in “Settings” setup (page 90). If more than one code number is listed for your cable box/satellite receiver, try entering them one at a time until you find the one that works with your cable box/satellite receiver.

Check the connection and position of the set top box controller (page 15).

If your cable box or satellite receiver still does not operate with this recorder, contact your cable or satellite company to see if they can provide you with a compatible cable box or satellite receiver.

To return to the previous step

Press  RETURN.

Hint

If you want to run “Easy Setup” again, select “Easy Setup” from “SETUP” in the System Menu (page 99).

Note

If you use an S-video cord to connect your cable box or satellite receiver, set “Line1 Input” or “Line3 Input” in “Video” setup to “S Video” (page 93).

To fix the set top box controller to your cable box/satellite receiver

Once you have confirmed that the set top box controller controls your cable box or satellite receiver, fix it in place.

- 1 Remove the backing on the double-sided tape.

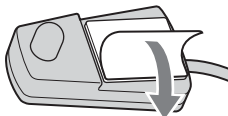

- 2 Attach it so that the set top box controller is directly above the remote control sensor on your cable box/satellite receiver.

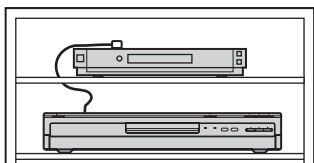

Connecting a VCR or Similar Device

After disconnecting the recorder's power cord from an AC outlet, connect a VCR or similar recording device to the LINE IN jacks of this recorder.

Use the DV IN jack on the front panel if the equipment has a DV output jack (i.LINK jack) (page 84). See also the instruction manual supplied with the connected equipment.

To record on this recorder, see "Recording from connected equipment without a timer" on page 57.

Connecting to the LINE IN 1 or 3 jacks

Connect a VCR or similar recording device to the LINE IN 1 or 3 of this recorder. If the equipment has an S-video jack, you can use an S-video cord instead of an audio/video cord.

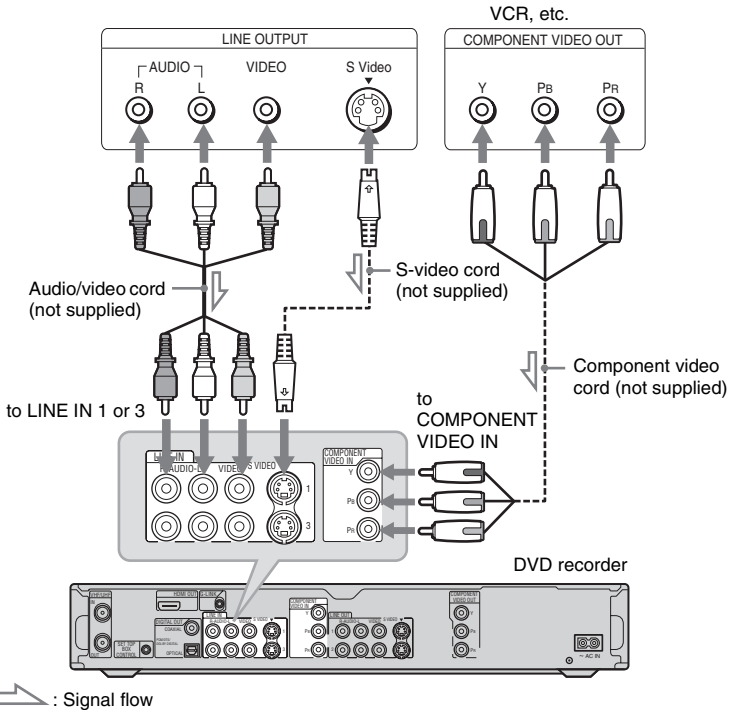

Notes

- Pictures containing copy protection signals that prohibit any copying cannot be recorded.
- If you pass the recorder signals via the VCR, you may not receive a clear image on your TV screen.



Be sure to connect your VCR to the DVD recorder and your TV in the order shown below. To watch video tapes, watch the tapes through a second line input on your TV.

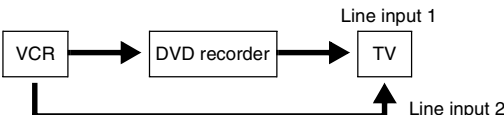

- If you disconnect the recorder's power cord, you will not be able to view the signals from the connected VCR.

Connecting to the LINE 2 IN jacks on the front panel

Connect a VCR or similar recording device to the LINE 2 IN jacks of this recorder. If the equipment has an S-video jack, you can use an S-video cord instead of an audio/video cord.

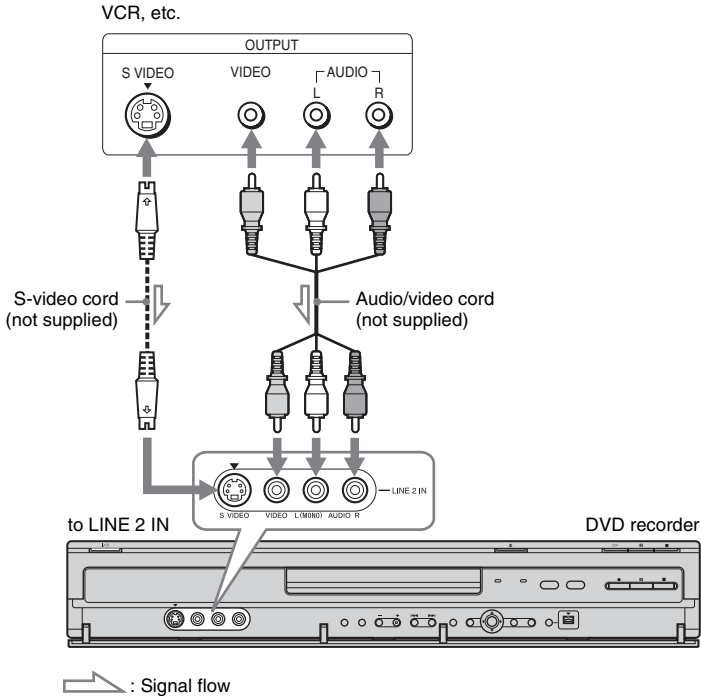

Hint

When the connected equipment outputs only monaural sound, connect to just the L (MONO) and VIDEO input jacks on the front of the recorder. Do not connect the R input jack.

Notes

- Do not connect the yellow LINE IN (VIDEO) jack when using an S-video cord.
- Do not connect the output jack of this recorder to another equipment's input jack with the other equipment's output jack connected to the input jack of this recorder. Noise (feedback) may result.
- Do not connect more than one type of video cord between the recorder and your TV at the same time.

Connecting to a Satellite or Digital Tuner

Connect a satellite or digital tuner to this recorder using the LINE IN 1 jacks. Disconnect the recorder's power cord from an AC outlet when connecting the tuner. To use the Synchro-Rec function, see below.

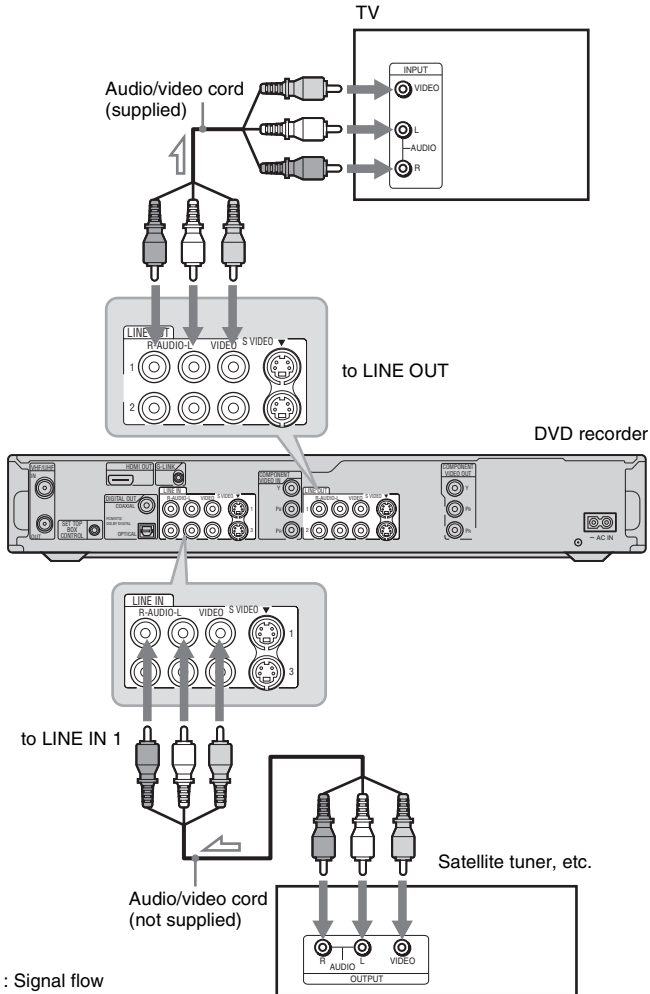

If you want to use the Synchro Rec function

This connection is necessary to use the Synchro-Recording function. See "Recording from connected equipment with a timer (Synchro Rec)" on page 56.

⚡ Notes

- Synchro-Recording does not work with some tuners. For details, see the tuner's operating instructions.
- If you disconnect the recorder's power cord, you will not be able to view the signals from the connected tuner.

1. Inserting and Formatting a DVD Disc (Disc Info)

Inserting a Disc

+RW -RWVR -RWVideo +R -R DVD
VCD CD DATA DVD DATA CD

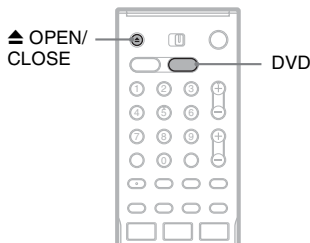

- 1 Press **DVD**.
- 2 Press **▲ OPEN/CLOSE**, and place a disc on the disc tray.

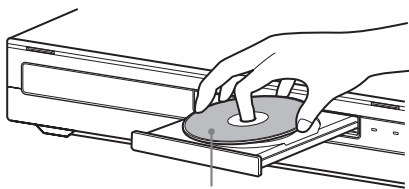

With the recording/playing side facing down

- 3 Press **▲ OPEN/CLOSE** to close the disc tray.

Wait until “LOAD” disappears from the front panel display.
Unused DVDs are formatted automatically.

Formatting a DVD disc (Disc Info)

+RW -RWVR -RWVideo

New discs are automatically formatted when inserted. If necessary, you can manually re-format a DVD+RW or DVD-RW disc to make a blank disc. For DVD-RWs, you can select a recording format (VR mode or Video mode) according to your needs (page 10).

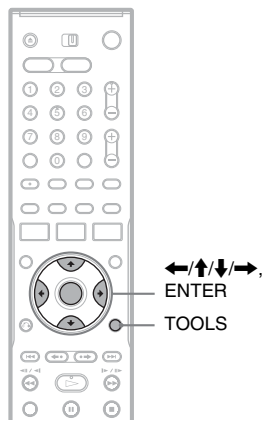

- 1 **Insert a disc.**
See “Inserting a Disc” on page 31.
- 2 **Press TOOLS.**
The TOOLS menu appears.

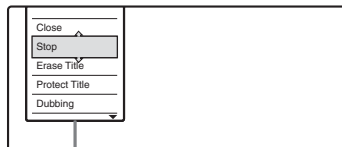

Options for the disc or picture

The TOOLS menu displays options applicable to the entire disc (e.g. disc protection), recorder (e.g. audio settings during recording), or multiple items on a list menu (e.g. erasing multiple titles). The displayed options differ depending on the situation and disc type.

3 Move the cursor down the TOOLS menu until “Disc Info” is selected, and press ENTER.

Example: When a DVD-RW (VR mode) is inserted.

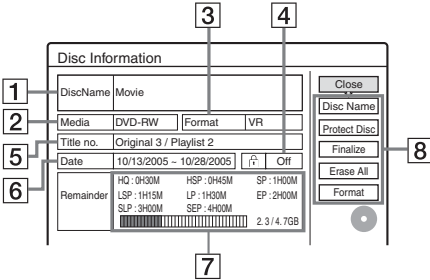

1 “Disc Name” (DVD only)

2 “Media”: Disc type

3 “Format”: Recording format type (DVD-RW only)

4 “On”/“Off”: Indicates whether protection is set (DVD-RW in VR mode only)

5 “Title no.”: Total number of titles

6 “Date”: Dates of when the oldest and the most recent titles were recorded (DVD only)

7 “Continuous Rem. Time”/“Remainder” (approximate)

- The remaining recording time in each of the recording modes
- Disc space bar
- Remaining disc space/total disc space

8 Disc setting buttons

- “Disc Name” (page 39)
- “Protect Disc” (page 40)
- “Finalize”/“Unfinalize” (page 40)
- “Erase All” (page 76)
- “Format”

Available settings differ depending on the disc type.

4 Select “Format,” and press ENTER.

5 Select “OK,” and press ENTER.

For DVD-RWs, select “VR” or “Video,” and press ENTER.

All contents on the disc are erased.

💡 Hints

- By reformatting, you can change the recording format on DVD-RWs, or record again on DVD-RWs that have been finalized.
- For DVD+RWs and DVD-RWs (Video mode), you can check free space and title location on the disc using the Disc Map display (page 76).

📌 Note

On this model, 1 GB (read “gigabyte”) is equivalent to 1 billion bytes. The larger the number, the larger the disc space.

2. Recording a Program

HDD +RW -RW/VR -RW/Video +R -R

This section introduces the basic operation to record the current TV program to the hard disk (HDD) or to a disc (DVD). For an explanation of how to make timer recordings, see page 49.

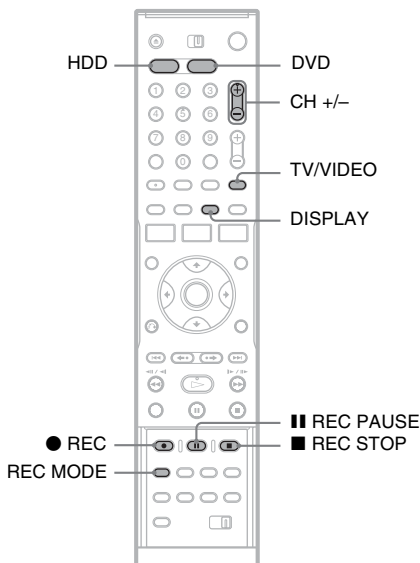

1 Press HDD or DVD.

When you record to a DVD, insert a recordable DVD (see “Inserting a Disc” on page 31).

2 Press CH +/- to select the channel or input source you want to record.

3 Press REC MODE repeatedly to select the recording mode.

Each time you press the button, the display on the TV screen changes as follows:

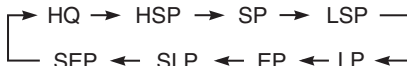

For more details about the recording mode, see page 49.

4 Press ● REC.

Recording starts.

Recording stops automatically after 8 hours of continuous recording or when the HDD or DVD is full.

To stop recording

Press ■ REC STOP located beneath the remote control cover.

Note that it may take a few seconds for recorder to stop recording.

To pause recording

Press ▬▬ REC PAUSE located beneath the remote control cover.

To restart recording, press the button again.

To watch another TV program while recording

Set your TV to the TV input using the TV/VIDEO button (page 22).

💡 Hint

If you do not want to watch TV while recording, you can turn off the TV. When using a decoder, make sure to leave it on.

⚡ Notes

- After pressing ● REC, it may take a short while to start recording.
- You cannot change the recording mode while recording or during recording pause.
- If there is a power failure, the program you are recording may be erased.

Checking the disc status while recording

You can check the recording information such as recording time or disc type.

Press DISPLAY twice during recording.

The recording information appears.

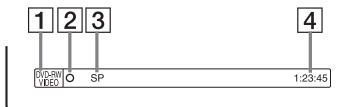

- 1 Disc type/format
- 2 Recording status
- 3 Recording mode
- 4 Recording time

Press DISPLAY to turn off the display.

3. Playing the Recorded Program (Title List)

HDD +RW -RWVR -RWVideo +R -R

To play a recorded title, select the title from the Title List.

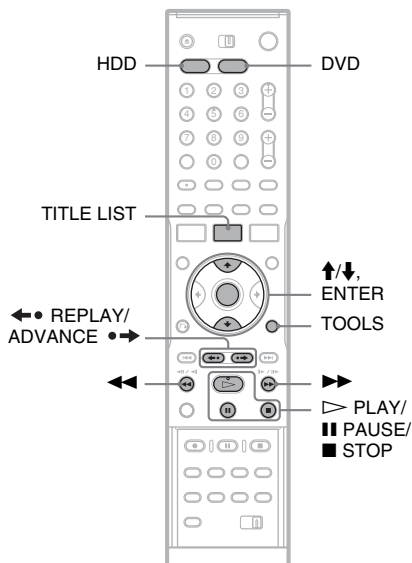

1 Press HDD or DVD.

If you select DVD, insert a DVD (see “Inserting a Disc” on page 31).

Playback starts automatically depending on the disc.

2 Press TITLE LIST.

To show the extended Title List, press TOOLS to select “Display List,” and press ENTER.

Title List with Thumbnail Images (Example: DVD-RW in VR mode)

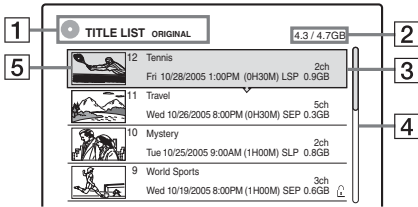

Extended Title List

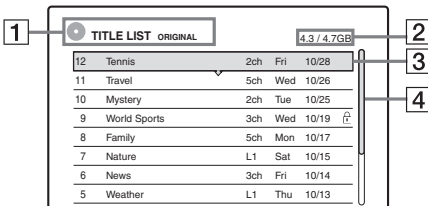

1 Disc type:

Displays a media type, HDD or DVD. Also displays the title type (Original or Playlist) for DVD-RWs (VR mode).

2 Disc space (remainder/total)

3 Title information:

Displays the title number, title name, and recording date. Title size is shown in the Thumbnail title list.

● (red): Indicates that the title is currently being recorded.

⦿: Indicates that the title is currently being dubbed.

🔒: Indicates the protected title.

“NEW” (or N): Indicates that the title is newly recorded (not played back) (HDD only).

COPY: Indicates titles containing “Copy-Once” copy protection signals (HDD only) (page 80).

4 Scroll bar:

Appears when all of the titles do not fit on the list. To view the hidden titles, press **↑/↓**.

5 Title’s thumbnail picture

The still images for each title are displayed.

3 Select a title, and press ENTER.

The sub-menu appears.

The sub-menu displays options applicable only to selected item. The displayed options differ depending on the mode, situation, and disc type.

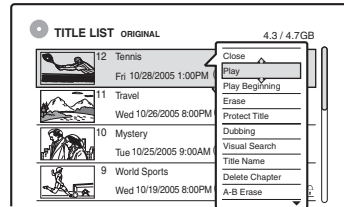

4 Select “Play,” and press ENTER.

Playback starts from the selected title.

To stop playback

Press **■ STOP**.

To scroll the list display by page (Page mode)

Press **◀◀ REPLAY/ADVANCE ▶▶** while the list display is turned on. Each time you press **◀◀ REPLAY/ADVANCE ▶▶**, the entire Title List changes to the previous/next page of titles.

About the Title List for HDD/DVD-RWs (VR mode)

You can switch the Title List to show Original or Playlist.

While the Title List menu is turned on, press **TOOLS** to select either “Original” or “Playlist,” and press **ENTER**.

For details, see “Edit options for the HDD and DVD-RWs (VR mode)” on page 72.

To change the title order (Sort)

While the Title List menu is turned on, press **TOOLS** to select “Sort Titles.” Press **↑/↓** to select the item, and press **ENTER**.

Order	Sorted
By Date	in order of when the titles were recorded. The title that is recorded most recently is listed at the top.
By Title	in alphabetical order.
By Number	in order of recorded title number.

Order	Sorted
Unseen Title (HDD only)	in order of when the titles were recorded. The title that is recorded most recently and not played back is listed at the top. Playlist titles are not displayed.

To change a title thumbnail picture (Thumbnail) (HDD/DVD-RW in VR mode only)

You can select a favourite scene for the thumbnail picture shown in the Title List menu.

- 1 Press TITLE LIST in stop mode.
- 2 Select a title whose thumbnail picture you want to change, and press ENTER. The sub-menu appears.
- 3 Select "Set Thumbnail," and press ENTER. The selected title starts to play in the background.
- 4 While watching the playback picture, press ▷ PLAY, || PAUSE, or ◀▶/▶▶ to select the scene you want to set for a thumbnail picture, and press ENTER. The display asks for confirmation.
- 5 Select "OK," and press ENTER. The scene is set for the title's thumbnail picture.

To turn off the Title List

Press TITLE LIST.

💡 Hints

- After recording, the first scene of the recording (the title) is automatically set as the thumbnail picture.
- You can select "TITLE LIST" from the System Menu.

📌 Notes

- The title names may not appear for DVDs created on other DVD recorders.
- The letters that cannot be displayed are replaced with "*."
- It may take a few seconds for the thumbnail pictures to be displayed.
- After editing, the title thumbnail picture may change to the first scene of the recording (title).
- After dubbing, the title thumbnail picture set on the source recording is canceled.

4. Displaying the Playing Time and Play Information



You can check the playing time and remaining time of the current title, chapter, or track. Also, you can check the disc name recorded on the DVD/CD.

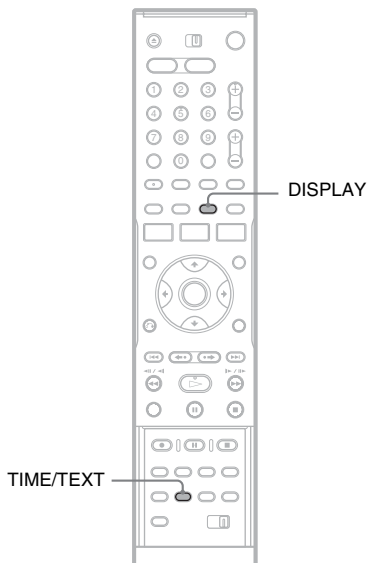

Press DISPLAY repeatedly.

Each time you press the button, the display changes as follows:

Display 1 → Display 2 → Display off

The displays differ depending on the disc type or playing status.

◆ Display 1

Example: When playing a DVD VIDEO

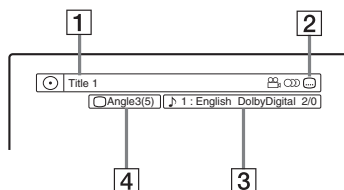

1 Title number/name
(Shows either track number, track name, scene number, or file name for CDs, VIDEO CDs, DATA DVDs, or DATA CDs.)

2 Available functions for DVD VIDEOS (angle/ audio/ subtitle, etc.), or playback data for DATA DVDs and DATA CDs

3 The current selected function or audio setting (appears only temporarily)
Example: Dolby Digital 5.1 ch

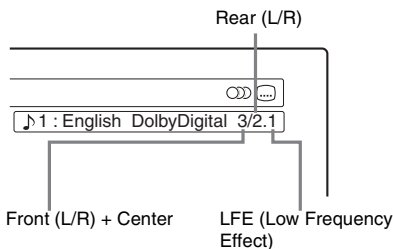

4 The current selected angle

◆ **Display 2**

Example: When playing a DVD-RW (VR mode)

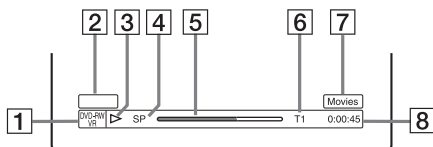

- 1** Disc type^{*1}/format (page 10)
- 2** Title type (only appears for Playlists) (page 72)
- 3** Play mode
- 4** Recording mode (page 49)
- 5** Playing status bar^{*2}
- 6** Title number (chapter number^{*3}) (page 67)
(Shows either track number, scene number, album number^{*3}, or file number for CDs, VIDEO CDs, DATA DVDs, or DATA CDs.)
- 7** Album name appears for CDs with CD text, DATA DVDs or DATA CDs when you press TIME/TEXT repeatedly.

8 Playing time (remaining time^{*3})

- ^{*1} Displays Super VIDEO CDs as “SVCD,” DATA CDs as “CD” and DATA DVDs as “DVD.”
- ^{*2} Does not appear with VIDEO CDs, DATA DVDs, and DATA CDs.
- ^{*3} Displayed when you press TIME/TEXT repeatedly.

💡 **Hints**

- If “DTS” is set to “Off” in “Audio” setup, the DTS track selection option will not appear on the screen even if the disc contains DTS tracks (page 95).
- When “Auto Display” is set to “On” (default) in “Options” setup (page 98), playback information automatically appears when the recorder is turned on, etc.

⚡ **Note**

The letters or symbols that cannot be displayed are replaced with “*.”

Checking the playing/remaining time

You can view the playing or time information displayed on the TV screen and the front panel display.

Press TIME/TEXT repeatedly.

The displays differ depending on the disc type or playing status.

◆ **Front panel display**

Example: When playing a DVD

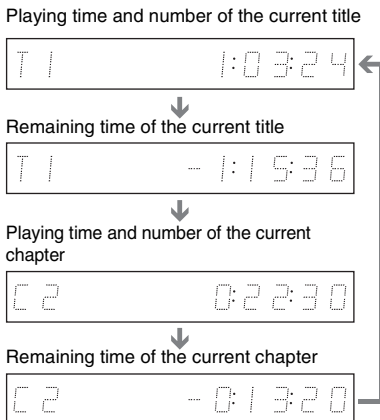

Example: When dubbing a DVD

Remaining time of dubbing in progress



Example: When playing a VIDEO CD

Playing time and number of the current scene or track



Example: When playing a CD

Track playing time and the current track/index number



Remaining time of the current track



Playing time of the disc



Remaining time of the disc



CD text (when available)

Example: When playing an MP3 audio track

Playing time and number of the current track



Current album number

Example: When viewing a JPEG image

Current file number and total number of files in the current album



Current album number and total number of albums

Notes

- The recorder can only display the first level of a CD's text, such as the disc name.
- The letters or symbols that cannot be displayed are replaced with “*.”
- Playing time of MP3 audio tracks may not be displayed correctly.

5. Changing the Name of a Recorded Program

You can label a DVD, title, or program by entering characters. You can enter up to 64 characters for a title or disc name, but the actual number of characters displayed in the menus such as the Title List will vary. The steps below explain how to change the name of the recorded program.

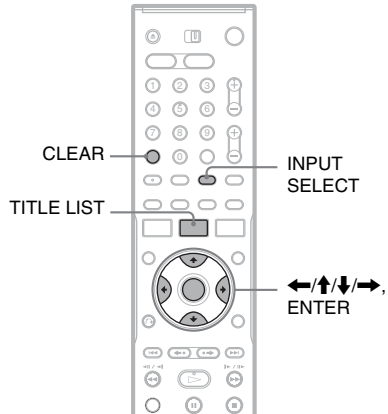

- 1 Press TITLE LIST.**
- 2 Select a title, and press ENTER.**
The sub-menu appears.
- 3 Select “Title Name,” and press ENTER.**
The display for entering characters appears.
- 4 Press ←/↑/↓/→ to move the cursor to the right of the screen and select “A” (upper-case), “a” (lower-case), or “Symbol,” and press ENTER.**
The characters of the selected type are displayed.

5 Press ←/↑/↓/→ to select the character you want to enter, and press ENTER.

The selected character appears at the top of the display.

Example: Input Title Name

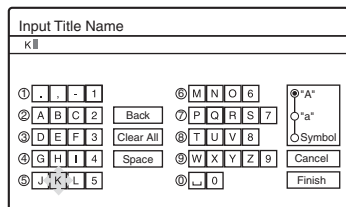

The type of characters will change according to the language you select in “Easy Setup.” Some languages allow you to enter an accent mark.

To enter a letter with an accent mark, select an accent followed by the letter.

Example: Select “`” and then “a” to enter “à.” To insert a space, select “Space.”

6 Repeat steps 4 and 5 to enter the remaining characters.

Input row

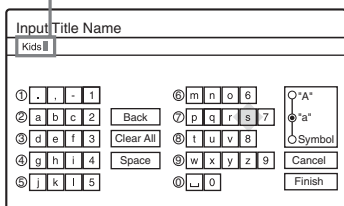

To erase a character, move the cursor to the right of the character at the input row. Select “Back” and press ENTER.

To insert a character, move the cursor to the right of the point where you want to insert the character. Select the character and press ENTER.

To erase all of the characters, select “Clear All” and press ENTER.

7 Select “Finish,” and press ENTER.

To cancel the setting, select “Cancel.”

🔧 Hints

- You can erase all displayed characters by pressing and holding CLEAR for 2 seconds or more.
- You can switch between “A” (upper-case), “a” (lower-case), or “Symbol” even if you press INPUT SELECT.

6. Labeling and Protecting a Disc

You can execute options effective for the entire disc using the Disc Information display.

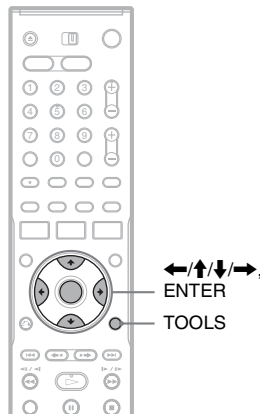

Labeling a disc

+RW -RWVR -RWVideo +R -R

1 Insert a disc.

See “Inserting a Disc” on page 31.

2 Press TOOLS to select “Disc Info,” and press ENTER.

Example: When the inserted disc is a DVD-RW (VR mode).

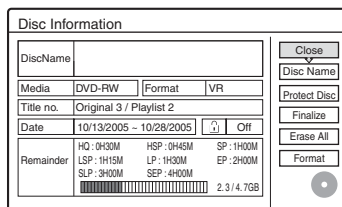

3 Select “Disc Name,” and press ENTER.

Enter the disc name in the “Input Disc Name” display (page 38).

📌 Note

You can enter up to 64 characters for a DVD’s disc name. The disc name may not appear when the disc is played on other DVD equipment.

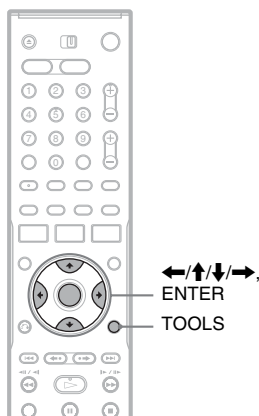

- 1 Insert a disc.**
See “Inserting a Disc” on page 31.
- 2 Press TOOLS to select “Disc Info,” and press ENTER.**
The “Disc Information” display appears.
- 3 Select “Finalize,” and press ENTER.**
The display shows the approximate time required for finalizing and asks for confirmation.

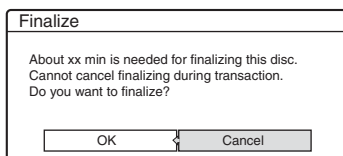

- 4 Select “OK,” and press ENTER.**
The recorder starts finalizing the disc.

Hint

You can check whether the disc has been finalized or not. If you cannot select “Finalize” in step 3 above, the disc has already been finalized.

Notes

- Depending on the condition of the disc, recording, or the DVD equipment, discs may not play even if the discs are finalized.
- The recorder may not be able to finalize the disc if it was recorded on another recorder.

Unfinalizing a disc

-RWVR **+RW_{Video}**

For DVD-RWs (Video mode)

DVD-RW (Video mode) that have been finalized to prohibit additional recording or editing can be unfinalized to allow further recording or editing.

For DVD-RWs (VR mode)

If you cannot record or edit on a DVD-RW (VR mode) that has been finalized with other DVD equipment, “This disc was finalized. Unfinalize it.” may appear.

Note

The recorder is not able to unfinalize DVD-RWs (Video mode) that have been finalized on another recorder.

- 1 Insert a disc.**
See “Inserting a Disc” on page 31.
- 2 Press TOOLS to select “Disc Info,” and press ENTER.**
The “Disc Information” display appears.
- 3 Select “Unfinalize,” and press ENTER.**
The recorder starts unfinalizing the disc. Unfinalizing may take several minutes.

Introduction to the TV Guide On Screen System

The TV Guide On Screen system is a free interactive program guide. It displays up to eight days of program listings, including program titles, promotions, and broadcast information. TV Guide On Screen data for the television program listings is carried by local broadcast stations and is received through your antenna, cable box, or direct cable connection from the wall.

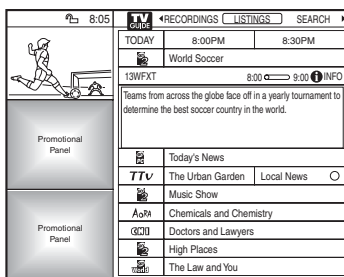

These are just a few of the ways to use the TV Guide On Screen system.

- Search for a program by listing them in alphabetical order or according to category (such as Movies or Sports), or by using the Keyword Search function (page 46).
- Once you have found the program you are looking for, use the TV Guide On Screen system to set the timer for recording (page 50).
- If you find a program that you want to watch in the future, set the Remind function so that the recorder automatically lets you know when the broadcast begins.

For more information, see “Watching TV with the TV Guide On Screen System” (page 43).

Troubleshooting guide

If you are having trouble displaying the television program list, please check the following.

- This recorder downloads the TV Guide On Screen data several times a day when the recorder is turned off. Turn off the recorder when you are not using it (for example, at night). After initial setup (page 25), it may take up to 24 hours for your recorder to start receiving program listings. It may take up to one week to receive all eight days of TV program listings.
- When the recorder is connected to a cable box, the cable box must be turned on, the set top box controller must be connected, and “Set Top Box Control” in the “Settings” setup must be set to “On” (page 90) to download the TV Guide On Screen data.
- Your area of residence and zip code must be set correctly (page 89).
- The time must be set correctly. If the time is not set, set it manually (page 89).
- The television program list is blank when TV Guide On Screen data is being downloaded or a satellite or terrestrial digital tuner is in use. You may be asked to select a channel lineup the first time you press TV GUIDE. Select one of the available channel lineups. If the channel number in the program listing does not match the broadcast station, see “To match the channel number with the broadcast station” (page 47).

Notes

- The TV Guide On Screen system is always displayed in English.
- The TV Guide On Screen system is not compatible with satellite and terrestrial digital broadcasts.
- Your cable box’s channel may suddenly change even if the recorder is turned off. This is because the set top box control has changed the channel to receive the TV Guide On Screen data.
- When you change the following settings, the TV Guide On Screen system is initialized and all timer settings are canceled.
 - “Antenna/Cable” of “Tuner Preset” in the “Settings” setup
 - “Zip Code” of “Area Setup” in the “Settings” setup
 - “Set Top Box Control” of “Set Top Box Control” in the “Settings” setup

Watching TV with the TV Guide On Screen System

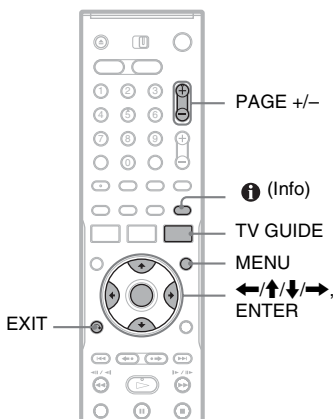

1 Press TV GUIDE.

TV Guide On Screen appears.
Example: LISTINGS

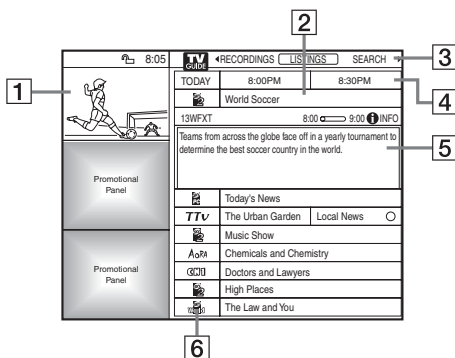

1 Video Window: This shows the program you were watching when you pressed TV GUIDE. See “To lock the Video Window” (page 47) to prevent the picture from changing when you move the cursor.

2 Title: Shows the program title and category; green (sports), purple (movies), blue (children’s), teal (others). The following icons are displayed. “O” indicates that the program is set to be recorded. “” indicates that the Remind function is set for the program.

3 Service Bar: Press \uparrow/\downarrow to move the cursor to the Service Bar. Then, select one of the following features using \leftarrow/\rightarrow , and press ENTER.

“LISTINGS”: Shows the programs for the current time slot and next 7 days.

“SEARCH”: Allows you to search for titles alphabetically, by category, or by keyword (page 46). The displayed category depends upon the program data received by this recorder. Movies, Sports, Children and News are examples of possible categories.

“SETUP”: Allows you to change the channel lineup, channel display and default options.

“SCHEDULE”: Displays the list of record or remind timer settings (page 55).

“RECORDINGS”: Displays the list of recorded titles (page 59).

4 Time Slot: Indicates the currently selected time slot. Use \leftarrow/\rightarrow to select a different time slot.

5 Info Box: Shows information about the selected program.

The following icons are displayed. “” indicates that the program is in stereo. “New” indicates that the program is not a re-run.

“C” indicates that the program is closed captioned.

Press the (Info) button repeatedly to show extended information about the program, if available.

6 Channel Logo: Shows the broadcast station logo.

2 Select a program using ↑/↓, and press MENU.

The Panel Menu appears.

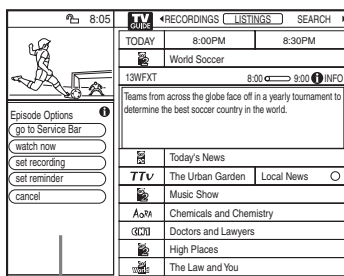

Panel Menu

The Panel Menu contains all functions that are available for the current selection. The available selections will change according to the selected item. You can tune to a channel, set a recording or edit the recording list from the Panel Menu when “LISTINGS” is selected.

3 Select “watch now” from the Panel Menu using ↑/↓, and press ENTER.

The TV Guide On Screen system disappears and the channel changes to the selected program.

To set a program for timer recording

See “Recording with the TV Guide On Screen system (TV GUIDE)” (page 50).

To close the TV Guide On Screen system

Press TV GUIDE or EXIT.

Hints

- Press the PAGE +/- buttons to change the program list by page.
- Each time you turn on the power, the TV Guide On Screen system automatically appears on your TV screen. To turn off this function, select “SETUP” in the Service Bar, and select “Change default options” – “General defaults,” and then press ENTER. When the Panel Menu appears, select “auto guide” and set it to “off.”

Notes

- The Video Window is locked during recording and the lock indicator appears in the Video Window. You cannot unlock the Video Window during recording.
- If you are watching programs through a set top box, the Video Window may not change as fast as you move the cursor. In this case, lock the Video Window (page 47).
- When you turn on the recorder, the same channel that you were watching last will automatically appear, even if you should change the channel on your set top box while the recorder’s power is off.
- The screen saver will not appear with the TV Guide On Screen system. The TV Guide On Screen system will close if no buttons are pressed for more than five minutes.

Setting the “Remind” Timer

If you want the recorder to remind you in the future when a selected program begins broadcasting, set the Remind timer.

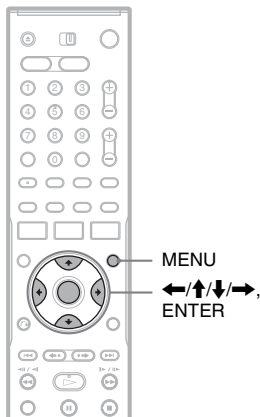

- 1** Search for a program alphabetically, by category or by keyword.
- 2** If you performed a category search go to step 3. If you performed an alphabetical or keyword search, select the program title using **↑/↓**, and press **ENTER**.
A list of episodes appears.
- 3** Select an episode using **↑/↓**, and press **ENTER**.
The Panel Menu appears.
- 4** Select “set reminder” using **↑/↓**, and press **ENTER**.

- 5** Select one of the following options using **↑/↓**, and adjust the settings using **←/→**.

- “schedule reminder”: Press **ENTER** to set the Remind timer with the displayed settings.
- “frequency”: Sets the timer to turn on the recorder “once,” “regularly” or “weekly.” Select “off” to turn off the timer.
- “auto tune”: Changes the channel automatically when the Remind timer is activated.
- “when”: Sets the time at which the recorder will remind you that a program is scheduled to start.

To change or cancel a reminder setting

See “Changing/Canceling Timer Recording or Reminder Settings” on page 55.

To set the timer for recording

- 1** Select the program you want to record, and press **MENU**.
- 2** Select “set recording” from the Panel Menu, and press **ENTER**.
- 3** Select “schedule recording” to set the timer with the displayed settings.
For more informations, see page 50.

Searching for a Program with the TV Guide On Screen System

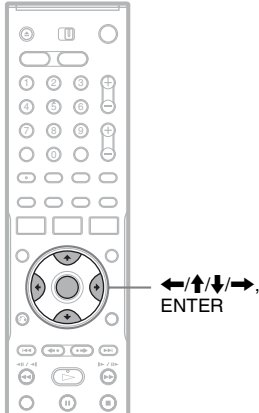

1 Select “SEARCH” in the Service Bar, and press ENTER.

2 Select a search option using \leftarrow/\rightarrow , and press ENTER.

To sort alphabetically, select “ALPHABETICAL.”

If you select “KEYWORD” prior to entering any keywords you will be prompted to enter a new keyword search. See “To enter a new keyword” below.

3 Select the letter (if you are sorting alphabetically), sub-category, or keyword using $\leftarrow/\uparrow/\downarrow/\rightarrow$, and press ENTER.

If no keywords are displayed, enter the keyword. See “To enter a new keyword” below.

4 Select a program using \uparrow/\downarrow , and press ENTER.

To enter a new keyword

- 1 Select “SEARCH” in the Service Bar, and press ENTER.
- 2 Select “KEYWORD” using \leftarrow/\rightarrow , and press ENTER.
The Panel Menu appears.
- 3 Select “new search” from the Panel Menu, and press ENTER.
- 4 Select “enter keyword” from the Panel Menu, and press ENTER.
- 5 Select a letter on the keyboard using $\leftarrow/\uparrow/\downarrow/\rightarrow$, and press ENTER.
- 6 Repeat step 5 to enter the keyword.
- 7 Select “DONE,” and press ENTER.
The recorder searches for all programs (including previous recordings) that contain the keyword in the program’s title.

Customizing the TV Guide On Screen System

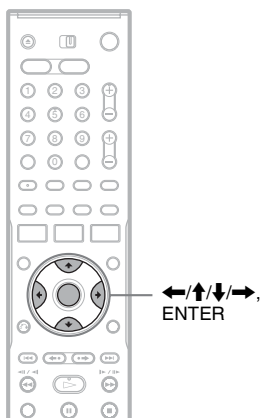

To lock the Video Window

You can lock the Video Window so that it does not change channels when you move the cursor across other titles.

From LISTINGS, select the logo of the channel that you want to lock, and press MENU. Select “video” from the Panel Menu, and lock or unlock the Video Window using ←/→.

To customize the channel lineup

- 1 Select “SETUP” in the Service Bar, and press ENTER.
- 2 Select “Change channel display” using ↑/↓, and press ENTER.
- 3 Select a channel using ↑/↓, and press ENTER.

The Panel Menu appears.

◆ To change the channel number

Select “tune channel” and enter the new channel number using the number buttons, then press ENTER.

The cursor moves to “done.”

Press ENTER again to exit the Panel Menu.

◆ To change the order of the channels

Select “position” and enter the number of the new location for the channel, then press ENTER.

The cursor moves to “done.”

Press ENTER again to exit the Panel Menu.

◆ To hide or show channels

Select “channel” and select “on,” “off” or “auto-hide” using ←/→, then press ENTER.

“off”: will hide the channel.

“auto-hide”: will show the channel only when program information is available.

The cursor moves to “done.”

Press ENTER again to exit the Panel Menu.

To match the channel number with the broadcast station

If the channel number in the program listing does not match the broadcast station, there may be more than one channel lineup for your area. To change the channel lineup, select “Change channel lineup” from “SETUP” and press ENTER. Then select a different channel lineup, if available.

To change the default settings

- 1 Select “SETUP” in the Service Bar.
- 2 Select “Change default options” using ↑/↓, and press ENTER.
- 3 Select “General defaults,” “Record defaults” or “Remind defaults,” and press ENTER. The Panel Menu for the selected option appears.

◆ General defaults

- “**i** box size”: changes the size of the info box.
- “box cycle”: changes the order in which the info box size is displayed each time the **i** (info) button is pressed. For example, “small only” will display only a small info box each time the **i** (info) button is pressed.
- “auto guide”: automatically displays the TV Guide On Screen system each time the power is turned on.

◆ Record defaults

- “start”: changes the start time of the recording to before or after the broadcast time of the program set to start.
- “end”: changes the end time of the recording to before or after the broadcast time of the program is scheduled to end.
- “recorder”: sets the default recording destination to either HDD or DVD.
- “quality”: adjusts the recording mode (page 49).

◆ Remind defaults

- “auto tune”: sets the recorder to change channels automatically when the Remind timer is activated.
- “when”: sets the recorder to display a notification message at a designated time before or after the selected program is scheduled to start.

4 Select one of the available options from the Panel Menu.

5 Adjust the default setting using **←/→**, and press ENTER.

The cursor moves to “done.”

Press ENTER again to exit the Panel Menu.

Before Recording

Before you start recording...

- This recorder can record on various discs. Select the disc type according to your needs (page 10).
- Check that the disc has enough available space for the recording (page 31). For HDD, DVD+RWs, and DVD-RWs, you can free up disc space by erasing titles (page 76).
- Adjust the recording picture quality and picture size if necessary (page 53).

Hint

Timer recordings will be made regardless whether or not the recorder is turned on. You can turn off the recorder without affecting the recording even after recording starts.

Note

To play a recorded disc on other DVD equipment, finalize the disc (page 40).

Recording mode

Like the SP or LP recording mode of VCRs, this recorder has eight different recording modes. Select a recording mode according to the time and picture quality you need. For example, if picture quality is your top priority, select the High Quality mode (HQ). If recording time is your priority, Super Extended Play mode (SEP) can be a possible choice. Note that recording times in the following table are approximate and the actual times may differ. Note also that the maximum continuous recording time for a single title is eight hours. Contents beyond this time will not be recorded.

Press REC MODE repeatedly to switch the recording modes.

Recording mode	Recording time (hours)	
	HDD	DVD*
HQ (High quality)	33	1
HSP ↑	51	1 hr. 30 min.
SP (Standard mode)	67	2
LSP ↓	85	2 hr. 30 min.
LP ↓	103	3
EP ↓	137	4
SLP ↓	204	6
SEP (Long duration)	269	8

* The recording time for DVD+R DL (Double Layer) discs is as follows:

- HQ: 1 hour 48 minutes
- HSP: 2 hours 42 minutes
- SP: 3 hours 37 minutes
- LSP: 4 hours 31 minutes
- LP: 5 hours 25 minutes
- EP: 7 hours 14 minutes
- SLP: 10 hours 51 minutes
- SEP: 14 hours 28 minutes

“HQ+” recording mode

“HQ+” records pictures in higher quality than HQ on the HDD. Set “HQ Setting” in “Features” setup to “HQ+” (page 97). Maximum recording time is 21 hours. “HQ” appears in the display.

Note

Situations below may cause slight inaccuracies with the recording time.

- Recording a program with poor reception, or a program or video source of low picture quality
- Recording on a disc that has already been edited
- Recording only a still picture or just sound

Recording a stereo/SAP program

The recorder can receive and record stereo/SAP programs.

Stereo programs

If there is noise in the stereo program, set “Auto Stereo” in “Options” setup to “Off” (page 98). The sound will be recorded in monaural but with less noise.

SAP (Second Audio Program)

When a SAP (Second Audio Program) is received, the “SAP” indicator lights up on the front panel display. To record only SAP sound, set “Tuner Audio” in “Options” setup to “SAP” (page 98).

Unrecordable pictures

Pictures with copy protection cannot be recorded on this recorder.

When the recorder receives a copy guard signal, the recorder continues to record but only a blank, grey colored screen will be recorded.

Copy control signals	Recordable discs
Copy-Free	HDD +RW -RWVR -RWVideo +R -R
Copy-Once	HDD -RWVR (CPRM*)
Copy-Never	None (a blank screen is recorded)

* The recorded disc can be played only on CPRM compatible equipment (page 10).

Timer Recording (TV GUIDE/Manual)

HDD +RW -RWVR -RWVideo +R -R

There are two methods to set the timer – setting the timer using the TV Guide On Screen system and setting the timer manually.

Notes

- When the recorder is connected to a cable box and you want to record using the TV Guide On Screen system, do the following: Turn on the cable box, connect the set top box controller, and set “Set Top Box Control” in the “Settings” setup to “On.”
- Do not operate your cable box or satellite receiver just before or during a timer recording. This may prevent the accurate recording of a program.

Recording with the TV Guide On Screen system (TV GUIDE)

You can use the TV Guide On Screen system to set the timer to record a program up to eight days in advance.

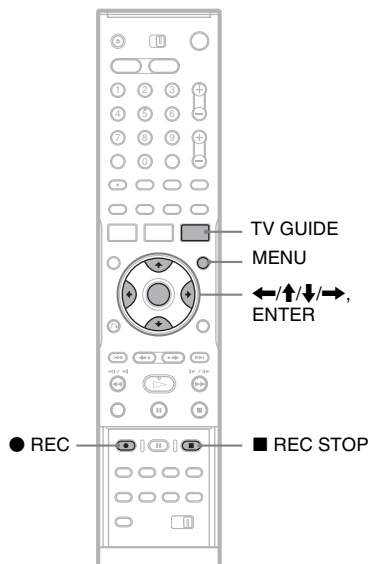

1 Press TV GUIDE.

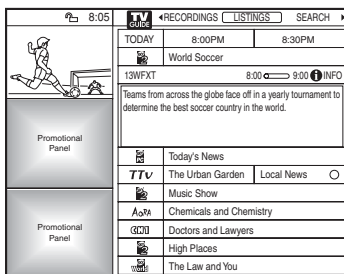

2 Select a program using ←/↑/↓/→.

To search for a program alphabetically, by category or by keyword, select “SEARCH” in the Service Bar. See “Searching for a Program with the TV Guide On Screen System” on page 46 for more information about searching for a program.

3 Press MENU.

The “Episode Options” menu appears.

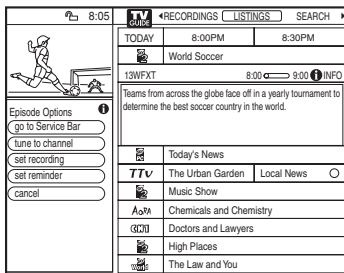

4 Select “set recording” using ↑/↓, and press ENTER.

The “Record Options” menu appears with the default settings.

- “schedule recording”: press ENTER to set the recording timer with the displayed options.
- “frequency”: sets the timer to record “once,” “regularly” or “weekly.” Select “off” to turn off the timer.
- “start”: sets the timer to begin recording before or after the program is scheduled to start.
- “end”: sets the timer to stop recording before or after the program is scheduled to end.
- “recorder”: sets the recording destination to either HDD or DVD.
- “quality”: sets the recording mode (page 49).

5 Select an option using ↑/↓, and make an adjustment using ←/→.

6 Select “schedule recording,” and press ENTER.

The **O** mark appears next to the program title, the **TIMER REC** indicator lights up in the front panel display and the recorder is ready to start recording. When recording from a cable box, be sure to turn it on.

Unlike a VCR, there is no need to turn off the recorder before the timer recording starts. If there is a recording conflict, follow the instructions on your TV screen to resolve the conflict.

To change or cancel timer recording

See “Changing/Canceling Timer Recording or Reminder Settings” on page 55.

To stop recording during timer recording

Open the remote’s cover and press **REC STOP**. Note that it may take a few seconds for the recorder to stop recording, and that the recording cannot be stopped within the first minute of recording.

To adjust the recording quality

See step 3 of “Adjusting the recording picture quality and size” on page 53.

Rec Mode Adjust

If there is not enough available disc space for the recording, the recorder automatically adjusts the recording mode to enable the entire program to be recorded. Set “Rec Mode Adjust” in “Features” setup to “On” (page 97).

Auto Title Erase (HDD only)



If there is not enough space for a timer recording, the recorder automatically erases old titles recorded on the HDD.

Set “Auto Title Erase” in “Features” setup to “On” (page 97). The oldest, played title is erased. The protected titles are not erased.

If the timer settings overlap

If one or more timer settings overlap,  appears next to the program and the recording is suspended. The timer recording resumes its original status when the overlap condition no longer exists. To change the timer settings, see “Changing/Canceling Timer Recording or Reminder Settings” on page 55.

Hint

You can also set a program to record by pressing  REC under the remote’s cover while the program is selected. Press  REC repeatedly to scroll between “record once,” “record regularly,” “record weekly” and “record off.”

Notes

- Check to see that there is enough available space for the recording (HDD/DVD+RW/DVD-RW only) (page 75).
- The Rec Mode Adjust function only works with a timer recording. It does not function with Quick Timer (page 53).
- You cannot adjust the recording quality (HDD or DVD) once the recording starts.
- If you change the recording destination of a program that is currently being recorded, the recording stops and the recording destination is changed.

Setting the timer manually

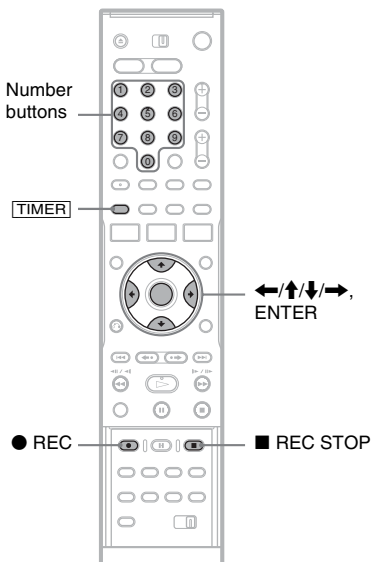

1 Press .

The cursor moves to the Panel Menu.

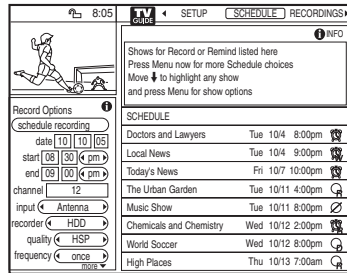

2 Select an option using .

“schedule recording”: Press ENTER to set the recording timer with the displayed options.

“date”: Press the number buttons to enter the date.

“start”: Press the number buttons to enter the start time. To change am/pm, select “am” or “pm” using .

“end”: Press the number buttons to enter the end time. To change am/pm, select “am” or “pm” using .

“channel”: Press the number buttons to enter the channel number.

“input”: Select the connected input source such as “Line1” or “Line2.”

“recorder”: Sets the recording destination to either HDD or DVD.

“quality”: Sets the recording mode (page 49).

“frequency”: Sets the timer to record “once,” “daily” or “weekly.” Select “off” to turn off the timer.

3 Select “schedule recording,” and press ENTER.

The TIMER REC indicator lights up in the front panel display and the recorder is ready to start recording. When recording from a cable box, be sure to turn it on.

Unlike a VCR, there is no need to turn off the recorder before the timer recording starts.

To confirm, change, or cancel timer recording

See “Changing/Canceling Timer Recording or Reminder Settings” on page 55.

To stop recording during timer recording

Open the remote’s cover and press  REC STOP. Note that it may take a few seconds for the recorder to stop recording.

Rec Mode Adjust

If there is not enough available disc space for the recording, the recorder automatically adjusts the recording mode to enable the entire program to be recorded. Set “Rec Mode Adjust” in “Features” setup to “On” (page 97).

Auto Title Erase (HDD only)

If there is not enough space for a timer recording, the recorder automatically erases old titles recorded on the HDD.

Set “Auto Title Erase” in “Features” setup to “On” (page 97). The oldest, played title is erased. The protected titles are not erased.

If the timer settings overlap

If one or more timer settings overlap,  appears next to the program and the recording is suspended. The timer recording resumes its original status when the overlap condition no longer exists. To change the timer settings, see “Changing/Canceling Timer Recording or Reminder Settings” on page 55.

Using the Quick Timer function

You can set the recorder to record in 30 minute increments.

Press ● REC repeatedly to set the duration.

Each press advances the time in 30 minute increments. The maximum duration is six hours.

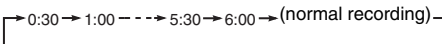

The time counter decreases minute by minute to 0:00, then the recorder stops recording (power does not turn off). Even if you turn off the recorder during recording, the recorder continues to record until the time counter runs out.

To cancel the Quick Timer

Press ● REC repeatedly until the counter appears in the front panel display. The recorder returns to normal recording mode.

Adjusting the recording picture quality and size

You can adjust the recording picture quality and picture size.

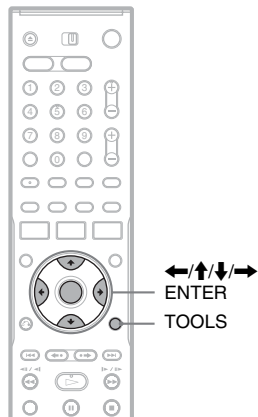

- 1 Before recording starts, press TOOLS to select “Rec Settings,” and press ENTER.

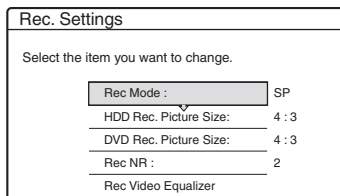

- 2 Select the item you want to adjust, and press ENTER.

The adjustment display appears.

Example: Rec NR

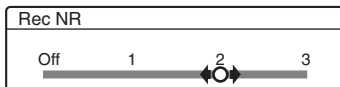

“Rec Mode”: Selects the recording mode for the desired recording time and picture quality. For more information, see “Recording mode” on page 49.

“HDD Rec. Picture Size”/“DVD Rec. Picture Size”: Sets the picture size of the program to be recorded.

- 4:3 (default): Sets the picture size to 4:3.
- 16:9: Sets the picture size to 16:9 (wide mode).
- Auto (HDD only): Automatically selects the actual picture size.

“DVD Rec. Picture Size” works with DVD-Rs and DVD-RWs (Video mode) when the recording mode is set to HQ, HSP, SP or LSP. For all other recording modes, the screen size is fixed at “4:3.”

For DVD-RWs (VR mode), the actual picture size is recorded regardless of the setting. For example, if a 16:9 size picture is received, the disc records the picture as 16:9 even if “DVD Rec. Picture Size” is set to “4:3.”

For DVD+RWs/DVD+Rs, the screen size is fixed at “4:3.”

“Rec NR” (noise reduction): Reduces noise contained in the video signal.

“Rec Video Equalizer”: Adjusts the picture in greater detail.

Press \uparrow/\downarrow to select the item you want to adjust, then press ENTER.

- Contrast: Changes the contrast.
- Brightness: Changes the overall brightness.
- Color: Makes the colors deeper or lighter.
- Hue: Changes the color balance.

3 Adjust the setting using $\leftarrow/\uparrow/\downarrow/\rightarrow$, and press ENTER.

The default setting is underlined.

“Rec NR”: (weak) Off 1 ~ 2 ~ 3 (strong)

“Rec Video Equalizer”:

- Contrast: (weak) -3 ~ 0 ~ 3 (strong)
- Brightness: (dark) -3 ~ 0 ~ 3 (bright)
- Color: (light) -3 ~ 0 ~ 3 (deep)
- Hue: (red) -3 ~ 0 ~ 3 (green)

Repeat steps 2 and 3 to adjust any other items.

Creating chapters in a title

The recorder can automatically divide a recording (a title) into chapters by inserting chapter marks during recording. To disable this function, set “Auto Chapter” in “Features” setup to “Off” (page 96).

When recording on the HDD or a DVD-RW (VR mode)

The recorder detects changes in the picture and sound and automatically inserts chapter marks. You can also insert and erase chapter marks manually (page 76).

When recording on other recordable discs

Chapter marks are inserted at approximately 6 minute intervals during recording.

Note

When dubbing (page 79), the chapter marks in the dubbing source are not retained in the dubbed title.

Notes

- If one program contains two picture sizes, the selected size is recorded. However, if the 16:9 signal cannot be recorded as 16:9, it is recorded as 4:3.
- Remnants of images may appear on your screen when using “Rec NR.”
- “Rec Video Equalizer” does not affect the input of the DV IN jack and COMPONENT VIDEO IN jacks.

Changing/Canceling Timer Recording or Reminder Settings

HDD +RW -RWvr -RWVideo +R -R

You can change or cancel timer and reminder settings using the SCHEDULE list.

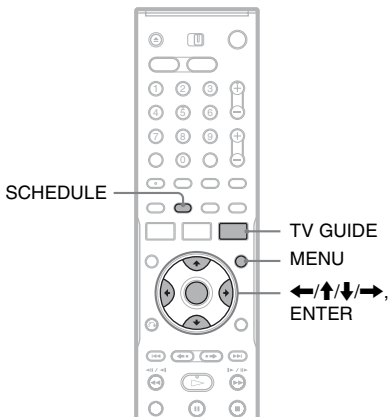

1 With the TV Guide On Screen system turned off, press SCHEDULE.

The SCHEDULE list appears.

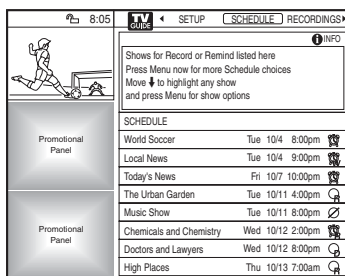

2 Select the Record or Remind timer setting you want to change using ↑/↓.

3 Press MENU.

The cursor moves to the Panel Menu.

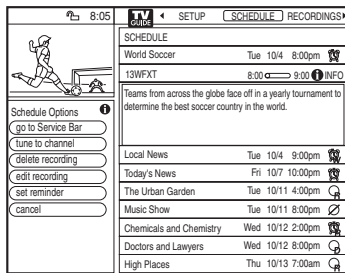

4 Select an option using ↑/↓, and press ENTER.

- “watch now” (or “tune to channel”): changes to the channel of the selected program.
- “delete recording” (or “delete reminder”): cancels the recording or the reminder setting.
- “edit recording” (or “edit reminder”): displays the Panel Menu to change the recording (page 50) or reminder settings (page 45).
- “set reminder” (or “set recording”): sets the selected program to either remind or record in addition to its current setting. For example, if a program is set to record, selecting “set reminder” will set the program to “remind” and still record.

To close the SCHEDULE list

Press TV GUIDE.

To change the SCHEDULE list

- 1 Press SCHEDULE.
The SCHEDULE list appears.
- 2 Press ↑/↓ to move the cursor to the Service Bar.
- 3 Select “SCHEDULE” in the Service Bar, and press MENU.
 - “sort by”: sorts the Record or Remind settings by “date,” “title” or “event” (“record” or “remind”).
 - “new manual recording”: sets the recording timer (page 52).
 - “new manual reminder”: sets the remind timer. See step 5 of “Setting the “Remind” Timer” on page 45.

- 4 Select “sort by.”
- 5 Select an option, and press ENTER.
The cursor moves to “done.”
Press ENTER again to exit the Panel Menu.

If two or more timer settings overlap

The timer recording set last has priority over the other settings and is recorded. All other overlapped settings are suspended, even if the setting only partially overlaps the setting with priority.  appears next to programs that are suspended.

Example: You set the timer in order of A, and then B.

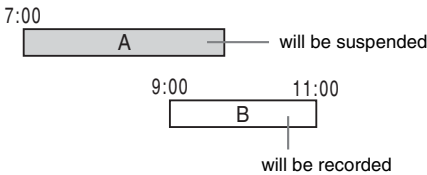

Note that if you modify setting A (for instance, if you extend the recording time), then setting A becomes the last timer recording you set and will have priority over setting B.

If the end and start time of two timer settings are the same

The end of program A or the beginning of program B will be cut.

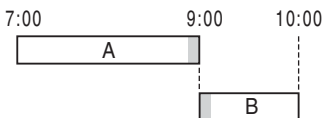

Recording From Connected Equipment

HDD **+RW** **-RWVR** **-RWVideo** **+R** **-R**

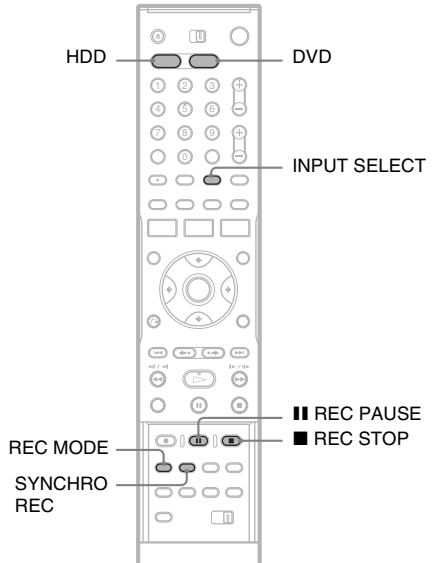

Recording from connected equipment with a timer (Synchro Rec)

You can set the recorder to automatically record programs from connected equipment that has a timer function (such as a satellite tuner). Connect the equipment to the LINE IN 1 jacks of the recorder (page 30).

When the connected equipment turns on, the recorder starts recording a program from the LINE IN 1 jacks. If you have connected a set top box, be sure to set “Set Top Box Control” to “Off” (page 90).

1 Before recording, select HDD or DVD.

If you select DVD, insert a recordable DVD (see “Inserting a Disc” on page 31).

2 Set “Synchro Rec” in “Features” setup to “Record to HDD” or “Record to DVD” (page 97).

- 3 Press INPUT SELECT repeatedly to select “L1.”**
- 4 Press REC MODE repeatedly to select the recording mode.**
For details about the recording mode, see page 49.
- 5 Set the timer on the connected equipment to the time of the program you want to record, and turn it off.**
- 6 Press SYNCHRO REC.**

The SYNCHRO REC indicator lights up on the front panel. The recorder is ready to start Synchro-Recording.
The recorder automatically starts recording when it receives an input signal from the connected equipment. The recorder stops recording when the connected equipment turns off.

To stop recording

Press **■** REC STOP or SYNCHRO REC.

To cancel Synchro Rec

Press SYNCHRO REC.

The SYNCHRO REC indicator on the recorder turns off.

⚡ Notes

- The recorder starts recording only after detecting the video signal from the connected equipment. The beginning of the program may not be recorded regardless of whether or not the recorder’s power is on or off.
- During Synchro-Recording, other operations such as normal recording cannot be done.
- To use the connected equipment while the recorder is standing by for Synchro-Recording, cancel Synchro-Recording by pressing SYNCHRO REC. Be sure to turn off the connected equipment and press SYNCHRO REC to reset Synchro-Recording before the timer recording starts.
- The Synchro Rec function does not work with some tuners. For details, see the tuner’s operating instructions.
- To use the Synchro Rec function, you must first set the recorder’s clock correctly.

If the timer settings of a Synchro-Recording and another timer recording overlap

Regardless of whether or not the program is a Synchro Rec program, the program that starts first has priority and the second program starts recording only after the first program has finished.

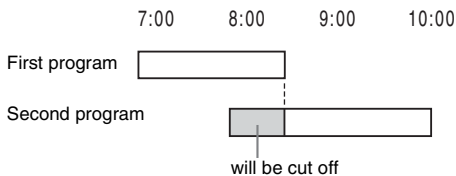

Recording from connected equipment without a timer

You can record from a connected VCR or similar device. To connect a VCR or similar device, see “Connecting a VCR or Similar Device” on page 28. Use the DV IN jack on the front panel if the equipment has a DV output jack (i.LINK jack).

- 1 Press HDD or DVD.**
If you select DVD, insert a recordable DVD (see “Inserting a Disc” on page 31).
- 2 Press INPUT SELECT to select an input source according to the connection you made.**
The front panel display changes as follows:
Channel number → L1 → L2 → L3 → DV
- 3 Press REC MODE repeatedly to select the recording mode.**
For details about the recording mode, see page 49.
- 4 Press **||** REC PAUSE to set this recorder to record pause.**
- 5 Insert the source tape into the connected equipment and set to playback pause.**
- 6 At the same time, press **||** REC PAUSE on this recorder and the pause or play button on the connected equipment.**
Recording starts.
To stop recording, press **■** REC STOP on this recorder.

If you connect a digital video camera with a DV IN jack

See “DV/Digital8 Dubbing” on page 84 for an explanation of how to record from the DV IN jack.

Hint

You can adjust the settings for the recording picture before recording. See “Adjusting the recording picture quality and size” on page 53.

Notes

- When recording a video game image, the screen may not be clear.
- Any program that contains a Copy-Never copy guard signal cannot be recorded. The recorder continues to record, but a blank screen will be recorded.

Playing

HDD +RW -RWvR -RWvideo +R -R
 DVD VCD CD DATA DVD DATA CD

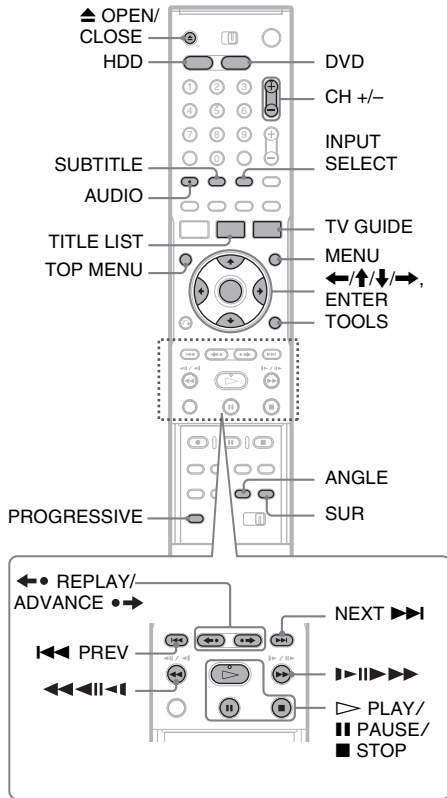

1 Press HDD or DVD.

- If you select DVD, insert a disc (see “Inserting a Disc” on page 31).
- If you insert a DVD VIDEO, VIDEO CD, or CD, press \triangleright PLAY. Playback starts.

2 Press TITLE LIST.

For details about the Title List, see “3. Playing the Recorded Program (Title List)” on page 34.

Example: DVD-RW (VR mode)

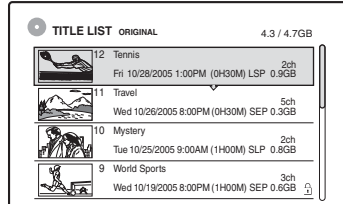

3 Select the title, and press ENTER.

The sub-menu appears.

4 Select “Play,” and press ENTER.

Playback starts from the selected title.

To stop playback

Press \blacksquare STOP.

Playing titles with the TV Guide On Screen system

To select the “list” or “group” view

1 Press TV GUIDE.

TV Guide On Screen appears.

2 Press \uparrow/\downarrow to move the cursor to the Service Bar.

3 Select “RECORDINGS” in the Service Bar using \leftarrow/\rightarrow , and press MENU.

The cursor moves to the Panel Menu.

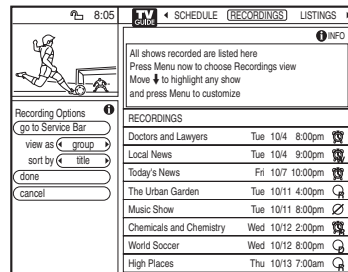

4 Select an option using \uparrow/\downarrow .

- “view as”: select “list” to view all recorded programs as a single list, or “group” to list episodes under a single program title.
- “sort by”: sorts the recorded programs by “date” or by “title” name.

- 5 Press **←/→** to make a selection, and press ENTER.
The cursor moves to “done.”
- 6 Press ENTER again to exit the Panel Menu.

To play a title

◆ List View

Select a program using **↑/↓**, and press ENTER.
Playback starts.

To make adjustments, press MENU while the program is selected and select one of the following.

- “play from beginning”
- “delete episode”

◆ Group View

- 1 Select a program using **↑/↓**, and press ENTER.
The episodes appear.
- 2 Select an episode using **↑/↓**, and press ENTER.
Playback starts.
To delete all episodes, press MENU while the program is selected and select “delete all episodes.”



🔄 Notes

- The program titles in the Title List and the TV Guide On Screen may not match.
- Information not written on the disc may also appear in the RECORDINGS screen.
- If you press TV GUIDE while making play list settings, the play list currently being set is canceled.
- JPEG image files and MP3 audio tracks do not appear in the TV Guide On Screen.

Playback options

To check the position of the buttons below, see the illustration on page 59.

Buttons	Operations
<p>AUDIO</p> <p>HDD -RWVR DVD</p> <p>VCD CD</p>	<p>Selects one of the audio tracks recorded on the disc when pressed repeatedly.</p> <p>DVD : Selects the language.</p> <p>HDD -RWVR : Selects the main or sub sound.</p> <p>VCD CD : Selects stereo or monaural audio tracks.</p>
<p>SUBTITLE</p> <p>DVD</p>	<p>Selects a subtitle language when pressed repeatedly.</p>
<p>ANGLE</p> <p>DVD</p>	<p>Selects an angle when pressed repeatedly.</p> <p>If various angles (multi-angles) for a scene are recorded on the disc, “∞” appears in the front panel display.</p>
<p>SUR (surround)</p> <p>+RW -RWVR -RW_{Video}</p> <p>+R -R DVD</p>	<p>Selects one of the TVS effects when pressed repeatedly.</p> <p>TVS* (TV Virtual Surround) lets you enjoy virtual surround sound effects created from the front left and right speakers. The selected setting is displayed in the front panel display for a few seconds.</p> <p>“TVS OFF”: No surround effect</p> <p>“TVS DYNAMIC”: Creates one set of virtual rear speakers.</p> <p>“TVS WIDE”: Creates five sets of virtual rear speakers.</p> <p>“TVS NIGHT”: Creates five sets of virtual rear speakers. Effective at low volume.</p> <p>“TVS STANDARD”: Creates three sets of virtual rear speakers. Effective when you use two separate front speakers.</p> <p>* TVS was developed by Sony to produce home surround sound with just a stereo TV.</p>
<p>PROGRESSIVE</p> <p>HDD +RW -RWVR</p> <p>-RW_{Video} +R -R</p> <p>DVD VCD</p>	<p>Switches the type of video output signal to interlace or progressive format (page 19).</p>
<p>◀• REPLAY/ADVANCE</p> <p>•▶ (instant replay/instant advance)</p> <p>HDD +RW -RWVR</p> <p>-RW_{Video} +R -R</p> <p>DVD</p>	<p>Replays the scene/briefly fast forwards the scene.</p>
<p>◀◀ PREV/NEXT ▶▶</p>	<p>Goes to the beginning of the previous/next title/chapter/scene/track.</p> <p>For the HDD, you cannot go to the beginning of the previous/next title.</p>

Buttons	Operations
 (fast reverse/fast forward)	Fast reverses/fast forwards the disc when pressed during playback. Search speed changes as follows: <div style="text-align: center; margin: 10px 0;"> fast reverse fast forward <<<1 ← → 1▶▶*1 <<<2 ← ← → → 2▶▶ <<<3*2 ← ← ← → → → 3▶▶*2 </div> When you press and hold the button, fast forward/fast reverse continues at the selected speed until you release the button. <p>*1 When you press ▶▶ once during playback of a title recorded in the HDD, you can play quickly with sound (“x1.5” appears).</p> <p>*2 <<<3 and 3▶▶ are only available for the HDD and DVDs.</p>
 (slow, freeze frame) <div style="margin-top: 5px;"> HDD +RW -RWvR -RWvideo +R -R DVD VCD * </div> * Playback direction only	Plays in slow motion when pressed for more than one second in pause mode. Plays one frame at a time when pressed briefly in pause mode.
 PAUSE	Pauses playback.

To resume normal playback, press ▷ PLAY.

🔊 Notes

- To enjoy the TVS function, set “Digital Out” to “On” and “Dolby Digital” to “D-PCM” in “Audio” setup.
- The volume may be reduced when surround effects are set.
- When the playback signal does not contain a signal for the rear speakers, the surround effects will be difficult to hear.
In addition, the surround effects may also be difficult to hear depending on the title being played and the environment where the recorder is being used.
- When you select one of the surround modes, turn off the surround settings of the connected TV or amplifier (receiver).
- Make sure that your listening position is between and at an equal distance from your speakers, and that the speakers are located in similar surroundings.
- Angles and subtitles cannot be changed with titles recorded on this recorder.
- 96 kHz PCM audio and DTS audio do not have surround effects.
- The surround effects do not work while performing playback quickly with sound.

To playback quickly with sound (Scan Audio)

When you press ▶▶ during playback of a title recorded in the HDD, you can play quickly with dialogue or sound (“x1.5” appears). No sound is output when you press ▶▶ two or more times to change search speed.

To resume playback from the point where you stopped (Resume Play)

When you press ▷ PLAY again after you stop playback, the recorder resumes playback from the point where you pressed ■ STOP.

To start from the beginning, press TOOLS to select “Play Beginning,” and press ENTER. Playback starts from the beginning of the title/track/scene.

The point where you stopped playing is cleared when:

- you open the disc tray (except for HDD).
- you play another title (except for HDD).
- you switch the Title List menu to Original or Playlist (HDD/DVD-RW in VR mode only).
- you edit the title after stopping playback.
- you change the settings on the recorder.
- you turn off the recorder (VIDEO CD/CD/DATA DVD/DATA CD only).
- you make a recording (except for HDD/DVD-RWs in VR mode).
- you switch between JPEG and MP3.

🔊 Note

You cannot resume playback during TV Pause.

To use the DVD's Menu

When you play a DVD VIDEO, or a finalized DVD+RW, DVD-RW (Video mode), DVD+R, or DVD-R, you can display the disc's menu by pressing TOP MENU or MENU.

To play VIDEO CDs with PBC functions

PBC (Playback Control) allows you to play VIDEO CDs interactively using the menu on your TV screen.

When you start playing a VIDEO CD with PBC functions, the menu appears.

Select an item using the number buttons and press ENTER. Then, follow the instructions in the menu (press ▷ PLAY when "Press SELECT" appears).

The PBC function of Super VIDEO CDs does not work with this recorder. Super VIDEO CDs are played in continuous play mode only.

To play restricted DVDs (Parental Control)

If you play a restricted DVD, the message "Do you want temporarily change parental control to *?" appears on your TV screen.

- 1 Select "OK" and press ENTER.
The display for entering your password appears.
- 2 Enter your four-digit password using the number buttons.
- 3 Press ENTER to select "OK."
The recorder starts playback.

To register or change the password, see "Parental Control (DVD VIDEO only)" on page 96.

To lock the disc tray (Child Lock)

You can lock the disc tray to prevent children from ejecting the disc.

When the recorder is turned on, hold down ■ STOP until "LOCKED" appears in the front panel display. The ▲ OPEN/CLOSE button does not work while the Child Lock is set.

To unlock the disc tray, hold down ■ STOP until "UNLOCKED" appears in the front panel display when the recorder is turned on.

🔧 Hints

- You can also use the ▷ PLAY button in step 3 (page 59) to start playback.
- Even if you select "Factory Setup" in "Options" setup (page 99), the Child Lock remains set.

Notes on playing DTS sound tracks on a CD

- When playing DTS-encoded CDs, excessive noise will be heard from the analog stereo jacks. To avoid possible damage to the audio system, the consumer should take proper precautions when the analog stereo jacks of the recorder are connected to an amplification system. To enjoy DTS Digital Surround™ playback, an external 5.1-channel decoder system must be connected to the digital jack of the recorder.
- Set the sound to "Stereo" using the AUDIO button when you play DTS sound tracks on a CD (page 61).

Notes on playing DVDs with a DTS sound track

DTS audio signals are output only through the DIGITAL OUT (COAXIAL or OPTICAL) jack.

When you play a DVD with DTS sound tracks, set "DTS" to "On" in "Audio" setup (page 95).

Adjusting the picture quality



- 1 Press TOOLS during playback to select "Video Settings," and press ENTER.

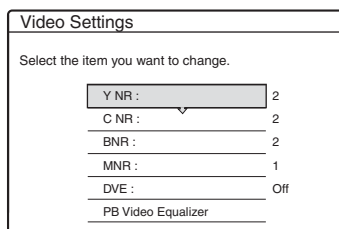

- 2 Select an item, and press ENTER.

The adjustment display appears.

"Y NR" (luminance noise reduction):

Reduces noise contained in the luminance element of the video signal.

"C NR" (chroma noise reduction): Reduces noise contained in the color element of the video signal.

"BNR" (block noise reduction): Reduces "block noise" or mosaic like patterns in the picture.

"MNR" (mosquito noise reduction): Reduces the faint noise appearing around the outlines of the images. The noise reduction effects are automatically adjusted within each setting range according to the video bit rate and other factors.

"DVE" (digital video enhancer): Sharpens the outlines of the images.

“PB Video Equalizer” (Playback video equalizer): Adjusts the picture in greater detail.

Select an item and press ENTER.

- Contrast: changes the contrast.
- Brightness: changes the overall brightness.
- Color: makes the colors deeper or lighter.
- Hue: changes the color balance.

3 Press ←/→ to adjust the setting, and press ENTER.

The default settings are underlined.

“Y NR”: (weak) Off 1 2 3 (strong)

“C NR”: (weak) Off 1 2 3 (strong)

“BNR”: (weak) Off 1 2 3 (strong)

“MNR”: (weak) Off 1 2 3 (strong)

“DVE”*: (weak) Off 1 2 3 (strong)

“PB Video Equalizer”:

- Contrast: (weak) -3 ~ 0 ~ 3 (strong)
- Brightness: (dark) -3 ~ 0 ~ 3 (bright)
- Color: (light) -3 ~ 0 ~ 3 (deep)
- Hue: (red) -3 ~ 0 ~ 3 (green)

Repeat steps 2 and 3 to adjust any other items.

* “1” softens the outlines of the images. “2” enhances the outlines and “3” enhances them more than “2.”

🔊 Notes

- If the outlines of the images on your screen become blurred, set “BNR” and/or “MNR” to “Off.”
- Depending on the disc or the scene being played, the above BNR, MNR, Y NR, or C NR effects may be hard to discern. And, these functions may not work with some screen sizes.
- When using the DVE function, noise found in the title may become more apparent. In this case, it is recommended that you use the BNR function with the DVE function. If the condition still does not improve, set the DVE level to “1” or “Off.”

Adjusting the sound quality

HDD +RW -RWVR -RW/video +R -R
DVD VCD CD DATA CD

1 Press TOOLS during playback to select “Audio Settings,” and press ENTER.

2 Select an item, and press ENTER.

“Surround” (TVS): Selects one of the surround modes. For more information, see “Playback options” on page 61.

“Audio Filter”: Selects the digital filter to reduce noise above 22.05 kHz (Fs* is 44.1 kHz), 24 kHz (Fs is 48 kHz), or 48 kHz (Fs is above 96 kHz).

- Sharp (default): Provides a wide frequency range and spatial feeling.

- Slow: Provides smooth and warm sound.

“AV SYNC”: When the video is delayed, this function delays the audio for synchronization with the video (0 to 120 milliseconds). Larger numbers indicate a longer audio delay for synchronization with the video. When dubbing to a VCR or other video recording equipment, be sure to return this setting to 0 ms (default).

* Sampling frequency of audio source. This function only adjusts the output signals from the LINE OUT (R-AUDIO-L).

3 Press ←/↑/↓/→ to select the option, and press ENTER.

🔊 Note

There may be little effect by changing the Audio Filter depending on the disc or playback environment.

Pausing a TV Broadcast (TV Pause)

You can pause a current TV broadcast, and then continue watching the program at a later time. This is useful when you receive an unexpected phone call or visitor while watching TV.

1 While viewing a TV broadcast with this recorder, press **|| PAUSE**.

The picture pauses. You can pause the picture for up to three hours.

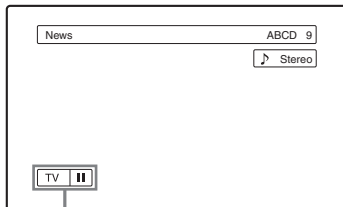

TV pause

2 Press **|| PAUSE** or **> PLAY** again to resume watching the program.

⚡ Notes

- Paused titles are not saved to the HDD.
- This function is canceled when:
 - **■ STOP** is pressed.
 - **CH +/-** is pressed.
 - **DVD** is pressed.
 - **▲ OPEN/CLOSE** is pressed.
 - **TITLE LIST** is pressed.
 - **INPUT SELECT** is pressed.
 - the recorder is turned off.
 - a timer recording or Synchro-Recording is started.
 - DV/Digital8 dubbing or regular dubbing is started.
- It may take a few seconds to resume playback of the paused program.
- Even if you fast forward the recorded program, there will always be a time difference of about one minute or more between the recorded program and the current TV broadcast.

Playing from the beginning of the program you are recording (Chasing Playback)

HDD **-RWVR**

“Chasing Playback” allows you to view the recorded part of a program while the recording is being made. You do not need to wait until the recording finishes.

Press **TOOLS** while recording to select “Chasing Playback,” and press **ENTER**.

Playback starts from the beginning of the program you are recording.

When you fast forward to the point that you are recording, Chasing Playback returns to normal playback.

⚡ Notes

- For DVD-RWs (VR mode), this function does not work when recording:
 - on a 1x-speed DVD-RW.
 - in the HQ or HSP recording mode.
- The DVD’s picture on your TV screen freezes for a few seconds when you fast forward/fast reverse or instant replay/advance the recording.
- Chasing Playback is possible from one minute or more after recording starts.
- Even if you fast forward the recorded program, there will always be a time difference of about one minute or more between the recorded program and the current TV broadcast.

Playing a previous recording while making another (Simultaneous Rec and Play)



“Simultaneous Rec and Play” allows you to view a previously recorded program while recording programs. Playback continues even if a timer recording starts. Use this function as follows:

- While recording to the HDD:
Play another title on the HDD.
Play a previously recorded program on a DVD by pressing DVD.
- While recording to a DVD:
Play a previously recorded program on the HDD by pressing HDD.
- While recording to a DVD-RW (VR mode)^{*1}:
Play another title on the same DVD-RW (VR mode) disc.^{*2}

^{*1} Simultaneous Rec and Play function does not work when you record:

- on a 1x-speed DVD-RW.
- in the HQ or HSP recording mode.

^{*2} Picture noise may appear depending upon the condition of the recording, or when playing a title recorded in the HQ or HSP recording mode. The picture freezes for a few seconds when you use fast forward/fast reverse or instant replay/advance.

You can also play a DVD VIDEO, VIDEO CD, Super VIDEO CD, CD, DATA DVD, or DATA CD while recording on the HDD.

Example: Play another title on the HDD while recording to the HDD.

- 1 While recording, press TITLE LIST to display the HDD Title List.
- 2 Select the title you want to play, and press ENTER.
- 3 Select “Play” from the sub-menu, and press ENTER.
Playback starts from the selected title.

Example: Play a DVD while recording to the HDD.

- 1 While recording, press DVD and insert the DVD into the recorder.
- 2 Press TITLE LIST to display the DVD Title List.
- 3 Select the title you want to play, and press ENTER.
- 4 Select “Play” from the sub-menu, and press ENTER.
Playback starts from the selected title.

Searching for a Title/ Chapter/Track, etc.

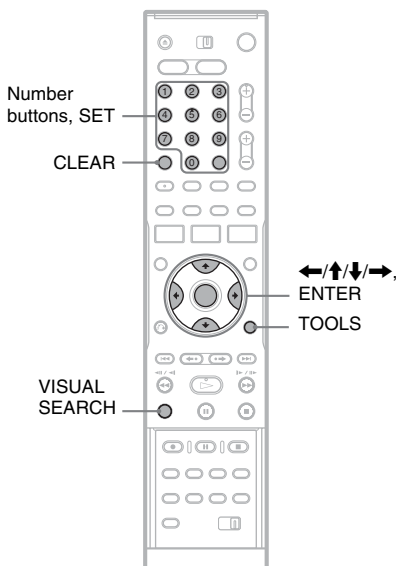

Searching by Thumbnail (Visual Search)

HDD +RW -RWvR -RWVideo +R -R

Each chapter is displayed as a thumbnail. You can search for the desired scene visually.

1 Press VISUAL SEARCH during playback.

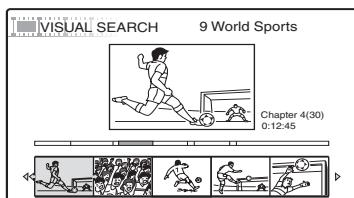

2 Select a scene using ←/→, and press ENTER.

Playback of the selected scene is started.

Searching by title number or time code

HDD +RW -RWvR -RWVideo +R -R
DVD VCD CD DATA DVD DATA CD

You can search a disc by title, chapter, scene or track. As titles and tracks are assigned individual numbers, select the title or track by entering its number. You can also search for a scene using the time code.

1 Press TOOLS during playback to select a search method, and press ENTER.

- “Title Search” (for DVDs)
- “Chapter Search” (for HDD/DVDs)
- “Track Search” (for CDs/DATA CDs)
- “Search” (for VIDEO CDs)
- “Album Search” (for DATA DVDs/DATA CDs)
- “Time Search” (for HDD/DVDs): Searches for a starting point by entering the time code.
- “File Search” (for DATA DVDs/DATA CDs)

The display for entering the number appears. Example: Title Search



The number in parentheses indicates the total number of titles, tracks, etc.

2 Press the number buttons to select the number of the title, chapter, track, time code, etc., you want.

For example: Time Search
To find a scene at 2 hours, 10 minutes, and 20 seconds, enter “21020.”

If you make a mistake, press CLEAR to cancel the number, then select another number.

3 Press SET.

The recorder starts playback from the selected number.

Note

“Title Search” is not applicable to the HDD.

Playing MP3 Audio Tracks or JPEG Image Files

DATA DVD DATA CD

You can play MP3 audio tracks and JPEG image files on DATA CDs (CD-ROMs/CD-Rs/CD-RWs) or JPEG image files on DATA DVDs (DVD-ROMs/DVD+RWs/DVD+Rs/DVD-RWs/DVD-Rs).

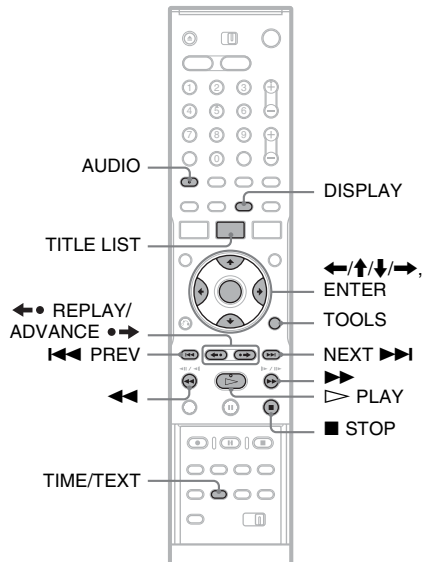

1 Insert a disc.

See "Inserting a Disc" on page 31.

2 Press **▷ PLAY**.

For MP3 discs, playback starts from the first MP3 audio track on the disc.

For JPEG files, a slideshow of the pictures on the disc begins.

If the DATA CD contains both MP3 audio tracks and JPEG image files, playback starts from the JPEG image files the first time

▷ PLAY is pressed.

Selecting an MP3 album or track

1 Press **TITLE LIST**.

The album list appears.

To change the page, press **◀• REPLAY/ADVANCE •▶**.

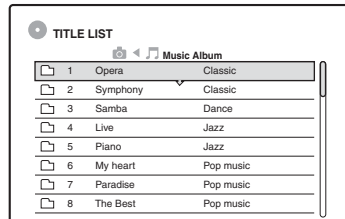

2 Select an album, and press **ENTER**.

The sub-menu appears.

3 Select "View Album," and press **ENTER**.

The track list appears.

To change the page, press **◀• REPLAY/ADVANCE •▶**.

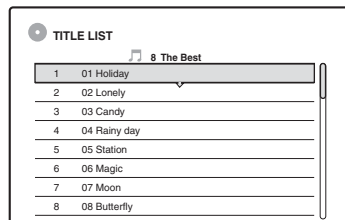

4 Select a track, and press **ENTER**.

"Play": Plays the track.

"Play Beginning": Plays the beginning of the track.

"Track Data": Shows data about the track such as artist and album name.

To stop playback

Press **■ STOP**.

To fast review or forward a track

Press **◀◀/▶▶** during playback.

To go to the previous or next MP3 audio track

Press **◀◀ PREV** or **NEXT ▶▶** during playback. If you repeatedly press **◀◀ PREV** or **NEXT ▶▶**, you will go to the previous or next album.

To go to the previous or next album

Press ◀• REPLAY/ADVANCE •▶ during playback.

💡 Hint

Press the AUDIO button to switch between stereo or monaural audio tracks.

Selecting a JPEG album or image

1 Press TITLE LIST.

The album list appears.

To change the page, press ◀• REPLAY/ADVANCE •▶.

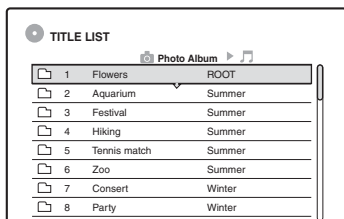

2 Select an album, and press ENTER.

The sub-menu appears.

3 Select "View Album," and press ENTER.

The image list appears.

To change the page, press ◀• REPLAY/ADVANCE •▶.

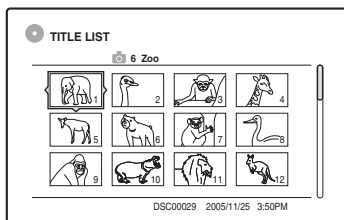

4 Select an image, and press ENTER.

“View Image”: Shows the image on the entire screen.

“Slideshow”: Shows the images in the album as a slideshow.

“Image Data”: Shows data about when the picture was taken.

To stop viewing the JPEG image

Press ■ STOP.

To view the previous or next picture

Press ◀◀ PREV/NEXT ▶▶ while the picture is displayed.

To rotate a picture

Press TOOLS while the image is displayed to select “Rotate Right” or “Rotate Left,” and press ENTER.

To change the slideshow speed

Press TOOLS while the album list or image list is displayed to select “Slideshow Speed,” and press ENTER. Then select the speed from “Fast” (quick), “Normal,” and “Slow.”

To go to the previous or next album

Press ◀• REPLAY/ADVANCE •▶ while the JPEG image is displayed.

💡 Hints

- If you are playing a DATA CD that has both MP3 and JPEG files, you can switch between photo and music albums by using the ◀/▶ buttons when the album list is displayed.
- You can rotate a JPEG image by using the ◀/▶ buttons when the image is displayed.
- Press DISPLAY repeatedly to show information about the JPEG album or image on your TV screen. Then press TIME/TEXT to toggle between the current selected image number and album number.

⚡ Notes

- If the DVD disc, such as a disc from a DVD video camera, contains both video and JPEG images, only the video can be played back.
- Some JPEG files, especially files of three million pixels or more, may lengthen the slideshow interval.
- Rotated JPEG images will not be saved when you press ■ STOP or switch to another folder.
- Images larger than 720 × 480 will be reduced to 720 × 480 when displayed.
- Images larger than 4 mega bytes cannot be displayed.
- Progressive JPEG images cannot be displayed.
- When you attempt to play a broken file or a file that does not satisfy the play conditions, 📄 appears but the recorder cannot play the file.

About MP3 audio tracks and JPEG image files

MP3 is audio compression technology that satisfies certain ISO/MPEG regulations. JPEG is image compression technology.

You can play MP3 (MPEG1 Audio Layer 3) format audio tracks and JPEG image files on DATA CDs (CD-ROMs/CD-Rs/CD-RWs) or JPEG image files on DATA DVDs (DVD-ROMs/DVD+RWs/DVD+Rs/DVD-RWs/DVD-Rs).

DATA CDs must be recorded according to ISO9660 Level 1, Level 2 or Joliet format for the recorder to recognize the MP3 tracks.

DATA DVDs must be recorded in Universal Disc Format (UDF). You can also play discs recorded in MultiSession.

See the instructions supplied with the CD-R/CD-RW/DVD-R/DVD-RW drives and the recording software (not supplied) for details on the recording format.

Note on MultiSession/Border discs

If MP3 audio tracks or JPEG image files are recorded in the first session/border, the recorder will also play MP3 audio tracks or JPEG image files in other sessions/borders. If audio tracks and images in Music CD format or Video CD format are recorded in the first session/border, only the first session/border will be played back.

Note

The recorder may not be able to play some DATA CDs/ DATA DVDs created in the Packet Write format.

MP3 audio tracks or JPEG image files that the recorder can play

The recorder can play the following tracks and files:

- MP3 audio tracks with the extension “.MP3,” “.mp3,” or “.Mp3.”
- JPEG image files with the extension “.JPEG,” “.jpg,” “.JPG,” “.Jpg,” “.jpeg,” or “.Jpeg.”
- JPEG image files that conform to the DCF* image file format.

* “Design rule for Camera File system”: Image standards for digital cameras regulated by JEITA (Japan Electronics and Information Technology Industries Association).

Notes

- The recorder will play any data with the extension “.MP3,” “.mp3,” “.Mp3,” “.JPEG,” “.jpg,” “.JPG,” “.Jpg,” “.jpeg,” or “.Jpeg” even if they are not in MP3 or JPEG format. Playing these data may generate a loud noise which could damage your speaker system.
- The recorder does not conform to audio tracks in mp3PRO format.
- Some files cannot be played.
- The letters that cannot be displayed are replaced with “*.”

About playback order of albums, tracks, and files

Albums play in the following order:

Structure of disc contents

Tree 1 Tree 2 Tree 3 Tree 4 Tree 5

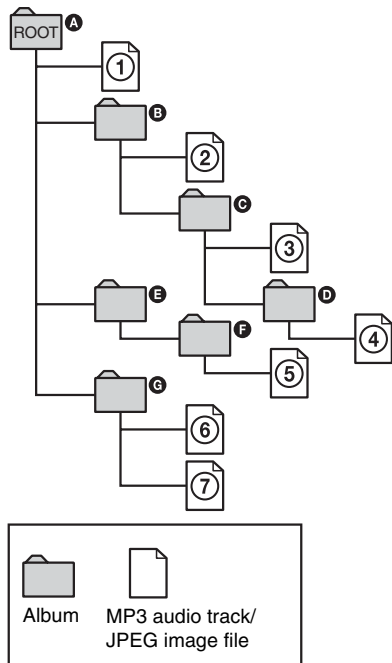

When you insert a DATA CD/DATA DVD and press \triangleright PLAY, the numbered tracks (or files) are played sequentially, from ① through ⑦. For JPEG image files, press ADVANCE $\bullet\rightarrow$ to go to the next album. (For instance, when you want to go from ① to ②.) Any sub-albums/tracks (or files) contained within a currently selected album take priority over the next album in the same tree. (Example: **C** contains **D** so ④ is played before ⑤.) When you press TITLE LIST and the list of album names appears (page 34), the album names are arranged in the following order: **A** \rightarrow **B** \rightarrow **C** \rightarrow **D** \rightarrow **F** \rightarrow **G**. Albums that do not contain tracks (or files) (such as album **E**) do not appear in the list.

💡 Hints

- If you add numbers (01, 02, 03, etc.) to the front of the track/file names when you store the tracks (or files) in a disc, the tracks and files will be played in that order.
- Since a disc with many trees takes longer to start playback, it is recommended that you create albums with no more than two trees.

⚡ Notes

- Depending on the software you use to create the DATA DVD/DATA CD, the playback order may differ from the above illustration.
- No more than a total of 199 individual folders can be played. (Folders that do not contain JPEG/MP3 files are counted as well.)
- No more than a total of 999 folders and files can be played. (Files other than JPEG/MP3 files, and folders that do not contain JPEG/MP3 files are counted as well.)
- No more than 200 folders and files can be recognized in a single folder. (Folders that do not contain JPEG/MP3 files are counted as well.)
- Proceeding to the next or another album may take some time.
- This recorder supports MP3 audio bit rates up to 160 kbps.

Before Editing

This recorder offers various edit options for various disc types. Before you edit, check the disc type in the front panel display, and select the option available for your disc (page 10).

Notes

- You may lose the edited contents if you remove the disc or a timer recording starts while editing.
- DVD discs created by DVD video cameras cannot be edited on this recorder.

Edit options for the HDD and DVD-RWs (VR mode)

HDD **-RWVR**

You can enjoy advanced edit functions. First you have two options for the HDD and DVD-RWs (VR mode): editing either the original recording (called the “original”), or the playback information created from the original (called a “Playlist”). Since each is different in nature and offers different merits, read the following and select the one that better suits your needs.

To edit original titles

Edits made to the original titles are final. If you plan to retain an unaltered original recording, create and edit a Playlist (see below). The edit functions available for original titles are:

- Labeling a title (page 73).
- Setting protection against erasure (page 73).
- Erasing a title (page 73).
- Erasing multiple titles (page 75).
- Erasing a section of a title (A-B Erase) (page 74).
- Erasing all titles on the disc (page 76).
- Erasing a chapter (page 74).
- Dividing one title into two titles (HDD only) (page 75).

To create and edit Playlist titles

A Playlist is a group of Playlist titles created from the original title for editing purposes. When you create a Playlist, only the control information necessary for playback, such as the playback order, is stored on the disc. Since the original titles are left unaltered, Playlist titles can be re-edited.

Example: You have recorded the final few matches of a soccer tournament on a DVD-RW (VR mode). You want to create a digest with the goal scenes and other highlights, but you also want to keep the original recording.

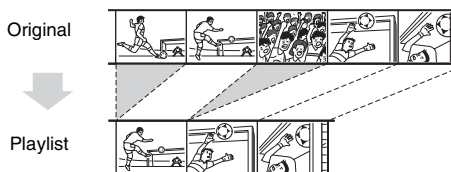

In this case, you can compile highlight scenes as a Playlist title. You can even rearrange the scene order within the Playlist title (“Creating and Editing a Playlist” on page 77).

The advanced edit functions available for Playlist titles are:

- Setting protection against erasure (HDD only) (page 73).
- Labeling a title (page 73).
- Erasing a title (page 73).
- Erasing multiple titles (page 75).
- Erasing a section of a title (A-B Erase) (page 74).
- Rearranging the title order (DVD-RWs (VR mode) only) (page 78).
- Dividing a title into multiple titles (page 75).
- Combining multiple titles into one title (page 78).
- Erasing a chapter (page 74).

Hint

You can display the disc’s Playlist titles in the Title List (Playlist), or the original titles in the Title List (Original). To switch the two Title Lists, press TOOLS while a Title List is displayed, and select “Original” or “Playlist.”

Notes

- The Playlist title calls up data from the original titles for playback. When an original title is used for a Playlist title, the original title cannot be erased.
- If a message appears and indicates that the disc's control information is full, erase or edit unnecessary titles.
- Playlist titles containing titles recorded with the "Copy-Once" copy protection signal cannot be dubbed or moved (page 80).

Edit options for DVD+RWs/DVD-RWs (Video mode)/DVD+Rs/DVD-Rs

+RW -RW_{Video} +R -R

You can perform simple edits. Since Video mode titles are actual recordings on the disc, you cannot undo any edits you make. The edit functions available for Video mode titles are:

- Setting protection against erasure (page 73).
- Labeling a title (page 73).
- Erasing a title (page 73).
- Erasing multiple titles (page 75).
- Erasing a section of a title (A-B Erase) (DVD+RWs only) (page 74).
- Erasing all titles on the disc (page 76).
- Erasing titles to open up disc space (Disc Map) (DVD+RWs and DVD-RWs (Video mode) only) (page 76).

Notes

- When editing a DVD+R or DVD-R, finish all editing before finalizing the disc. You cannot edit a finalized disc.
- The available disc space does not increase even when you erase titles for DVD+Rs and DVD-Rs.
- If a message appears and indicates that the disc's control information is full, erase or edit unnecessary titles.

Erasing and Editing a Title

HDD +RW -RW_{VR} -RW_{Video} +R -R

This section explains the basic edit functions. Note that editing is irreversible. To edit the HDD or DVD-RWs (VR mode) without changing the original recordings, create a Playlist title (page 77).

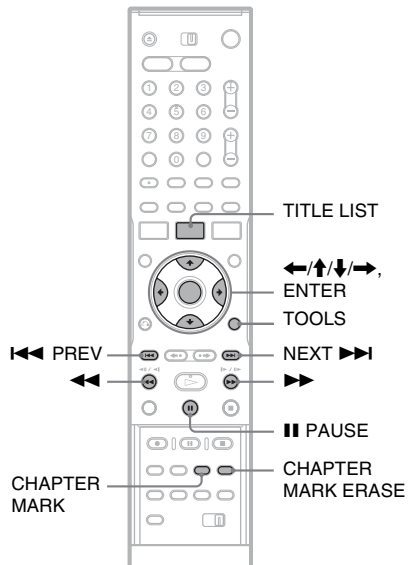

1 Press TITLE LIST.

For HDD titles or DVD-RWs in VR mode, press TOOLS and select "Original" or "Playlist" from the TOOLS menu to switch the Title Lists, if necessary.

2 Select a title, and press ENTER.

The sub-menu appears.

3 Select an option, and press ENTER.

You can make the following edits to the title. "Erase": Erases the selected title. Select "OK" when asked for confirmation.

"Protect Title": Protects the title. Select "On" when the Protection display appears. "P" appears next to the protected title. To cancel the protection, select "Off."

"Title Name": Allows you to enter or re-enter a title name (page 38).

"Set Thumbnail": Changes the title's thumbnail picture that appears in the Title List (page 36).

“A-B Erase”: Erases a section of the title (page 74).

“Delete Chapter”: Erases chapter units of the title while viewing thumbnails (see below).

“Divide Title”: Divides a title into two titles (page 75).

Hints

- You can erase multiple titles at one time (page 75), or erase all of the titles on the disc at once (page 76).
- You can automatically erase titles that have already played (page 97).
- You can label or re-label DVDs (page 39).

Note

DVD-RW (VR mode) playlist titles cannot be protected.

Erasing a chapter (Delete Chapter)

HDD -RWvR

Thumbnails are displayed for each chapter. You can easily select and erase a section in a title. Note that erasing a chapter cannot be undone.

1 After step 2 of “Erasing and Editing a Title,” select “Delete Chapter,” and press ENTER.

2 Select a thumbnail of the chapter using / , and press ENTER.

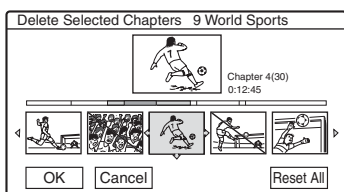

- To cancel the selection, press ENTER again.
- To erase multiple chapters, repeat step 2.
- To reset all selections, select “Reset All.”

3 Select “OK,” and press ENTER.

The display asks for confirmation.

4 Select “Yes,” and press ENTER.



Erasing a section of a title (A-B Erase)

HDD +RW -RWvR

You can select a section (scene) in a title and erase it. Note that erasing scenes in a title cannot be undone.

1 After step 2 of “Erasing and Editing a Title,” select “A-B Erase” and press ENTER.

The display for setting point A appears.

- To return to the beginning of the title, press  PAUSE and then press  PREV.

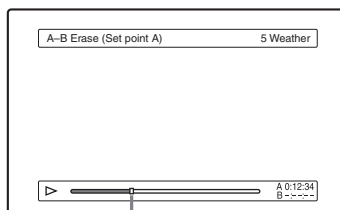

Playback point

2 Select point A by pressing / , and press ENTER.

The display for setting point B appears.

3 Select point B by pressing / , and press ENTER.

The display asks for confirmation.

- To reset either point A or B, select “Change A” or “Change B,” and go to step 2 or 3.
- To preview the title without scenes to be erased, select “Preview” (except for DVD+RWs).

4 Select “OK,” and press ENTER.

The scene is erased, and the display asks whether to erase another scene.

- To continue, select “Yes,” and repeat from step 2.
- To finish, select “No.”

Hint

A chapter mark is inserted after the scene was erased. The chapter mark divides the title into separate chapters on either side of the mark.

Notes

- Images or sound may be momentarily interrupted at the point where you erase a section of a title.
- Sections shorter than five seconds may not be erased.
- For DVD+RWs, the erased section may be slightly different from the points you selected.

Erasing multiple titles (Erase Titles)

HDD +RW -RWVR -RWVideo +R -R

You can select and erase more than one title at one time using the TOOLS menu.

- 1 Press TITLE LIST.
- 2 Press TOOLS to select “Erase Titles,” and press ENTER.

The display for selecting titles to be erased appears.

- 3 Select a title, and press ENTER.

A check mark appears in the check box next to the selected title.

- To clear the check mark, press ENTER again.
- To clear all of check marks, select “Reset All.”

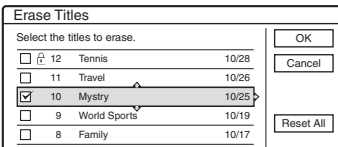

- 4 Repeat step 3 to select all of the titles you want to erase.

- 5 When you finish selecting titles, select “OK,” and press ENTER.

The list of the titles to be erased appears for confirmation.

- To change the selection, select “Change,” and repeat from step 3.

- 6 Select “OK” and press ENTER.

The titles are erased.

Dividing a title (Divide Title)

HDD -RWVR *

If you want to dub a long title to a disc but do not want to reduce the picture quality, divide the title into two shorter titles. Note that dividing a title cannot be undone.

* Only playlist titles can be divided for DVD-RW (VR mode).

- 1 Press TITLE LIST.

Press TOOLS and select “Original” or “Playlist” from the TOOLS menu to switch the Title Lists, if necessary.

- 2 Select a title, and press ENTER.

The sub-menu appears.

- 3 Select “Divide Title,” and press ENTER.

The display for setting the dividing point appears. The title starts to play in the background.

- To return to the beginning of the title, press **II PAUSE** and then press **◀◀ PREV**.

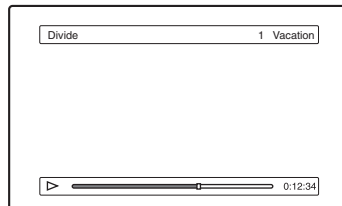

- 4 Select the dividing point by pressing **◀◀/▶▶**, and press ENTER.

The display asks for confirmation.

- To change the dividing point, select “Change.”

- 5 Select “OK,” and press ENTER.

The display for entering the title name appears.

- To use the same title name as before, select “No.”

- 6 Select “Yes,” and press ENTER to enter a new name.

Follow the explanations on page 38. After you enter a new name, the title is divided in two.

Erasing all titles on the disc

HDD +RW -RWVR -RWVideo +R -R

1 Press **TOOLS** to select “Disc Info,” and press **ENTER**.

The “Disc Information” display appears.

2 Select “Erase All,” and press **ENTER**.

3 Select “OK,” and press **ENTER**.

All titles on the disc are erased (except the protected titles).

Erasing titles to open up disc space (Disc Map)

+RW -RWVideo

When recording on a DVD+RW or DVD-RW (Video mode), the recorder searches for the largest open space and records there. Before you start, check the disc status by using Disc Map, and erase titles to create a space large enough for the recording.

1 Insert a disc and press **TITLE LIST**.

2 Press **TOOLS** to select “Disc Map,” and press **ENTER**.

The “Disc Map” display appears.

- To check the open space, select the space by pressing **←/→**.

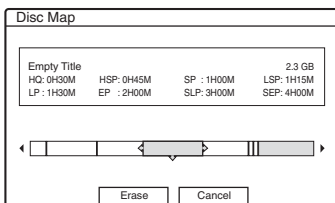

- When **◀** or **▶** appears on either side of the screen, you can scroll sideways by pressing **←/→**.

3 Select a title by pressing **←/→**, and press **ENTER**.

The display for selecting titles to be erased appears.

- To cancel the selection, press **ENTER** again.
- To erase more titles, repeat step 3.

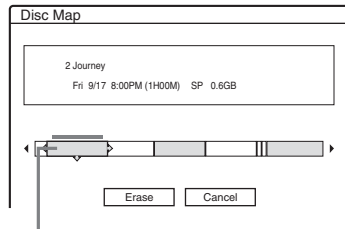

Selected title

4 Select “Erase,” and press **ENTER**.

The display asks for confirmation.

5 Select “OK,” and press **ENTER**.

The selected titles are erased, freeing up disc space.

- To change the selection, select “Change.”

Creating chapters manually

HDD -RWVR

You can manually insert a chapter mark at any point you like during playback or recording.

Press CHAPTER MARK at the point where you want to divide the title into chapters.

Each time you press the button, “Marking ...” appears on the screen and the scenes to the left and right of the mark become separate chapters.

To erase chapter marks

You can combine two chapters by erasing the chapter mark during playback.

Press **◀◀ PREV/NEXT ▶▶▶** to search for a chapter number, and while displaying the chapter containing the chapter mark you want to erase, press **CHAPTER MARK ERASE**.

The current chapter combines with the previous chapter.

Notes

- When dubbing, any chapter marks you enter will be erased.
- To insert a chapter mark manually during recording, set “Auto Chapter” in “Features” setup to “Off.”

Creating and Editing a Playlist

HDD **-RWVR**

Playlist edit allows you to edit or re-edit without changing the actual recordings. You can create up to 97 Playlist titles.

⚡ Note

Once you create a Playlist title from original titles, you will be unable to erase or edit the original titles.

- 1 Press **TITLE LIST**.
- 2 Press **TOOLS** to select **“Create Playlist,”** and press **ENTER**.

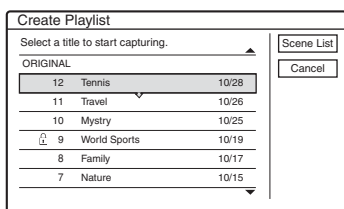

- 3 Select the title you want to include in the Playlist title, and press **ENTER**.

The sub-menu appears.

“Capture”: Adds a section of the title to the Playlist title as one scene.

“Capture All”: Adds the entire title to the Playlist title as one scene. After capturing the title, go to step 8.

- 4 Select **“Capture,”** and press **ENTER**.

The display for setting the start point (IN) appears. The title starts to play in the background.

- To return to the beginning of the title, press **|| PAUSE** and then press **◀◀ PREV**.

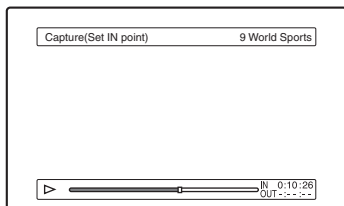

- 5 Select the **IN** point by pressing **◀◀/▶▶**, and press **ENTER**.

The display for setting the end point (OUT) appears, and the title continues to play in the background.

- 6 Select the **OUT** point by pressing **◀◀/▶▶**, and press **ENTER**.

The display asks for confirmation.

To reset the IN or OUT point, select “Change IN” or “Change OUT” and repeat step 5 or 6. To view the selected scene, select “Preview.”

- 7 Select **“OK,”** and press **ENTER**.

The Scene List menu appears with all of the selected scenes.

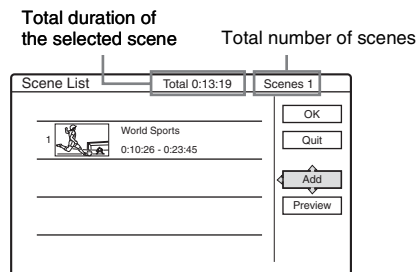

- To add more scenes, select “Add” and go to step 3.
- To preview all of the captured scenes in the listed order, select “Preview.”

- 8 Select the scene you want to re-edit, and press **ENTER**.

The sub-menu appears.

“Move”: Changes the scene order.

“Erase”: Erases the scene. The selection is canceled.

“Preview”: Displays thumbnail pictures of the scenes.

“Change IN”: Allows you to change the IN point, and repeat from step 5.

“Change OUT”: Allows you to change the OUT point, and repeat from step 6.

- 9 When you finish editing the Scene List, select **“OK,”** and press **ENTER**.

The display for entering the title name appears. To enter a new name, select “Enter” (page 38).

- 10 Select **“OK”** to use the default name, and press **ENTER**.

To play the Playlist title

Press **TOOLS** while the Title List menu is turned on. Then, select “Playlist” and press **ENTER**.

When the Title List (Playlist) menu appears, select a title and press **▷** **PLAY**.

Hint

When a Playlist title is created, the **IN** and **OUT** points will become chapter marks, and each scene will become a chapter.

Note

The picture may pause when the edited scene is played.

Moving a Playlist title (Change Order)

-RWVR

You can change the Playlist title order within the Title List (Playlist).

1 Press **TITLE LIST** to turn on the Title List (Playlist) menu.

If the Title List (Original) menu appears, press **TOOLS** and select “Playlist.”

2 Select the title you want to move, and press **ENTER**.

The sub-menu appears.

3 Select “Change Order,” and press **ENTER**.

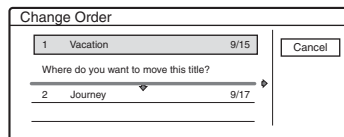

4 Select a new location for the title by pressing **↑/↓**, and press **ENTER**.

The title moves to the new location.

Combining multiple Playlist titles (Combine Titles)

HDD -RWVR

1 Press **TITLE LIST** to turn on the Title List (Playlist) menu.

If the Title List (Original) menu appears, press **TOOLS** and select “Playlist.”

2 Press **TOOLS** to select “Combine Titles,” and press **ENTER**.

The display for selecting titles appears.

3 Select a title, and press **ENTER**.

A number indicating the order in which you selected the title appears.

To cancel the selection, press **ENTER** again.

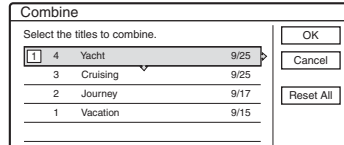

4 Repeat step 3 to select all of the titles you want to combine.

To cancel all of the selections, select “Reset All.”

5 Select “OK,” and press **ENTER**.

The list of titles to be combined appears.

To change the selection, select “Change” and go to step 3.

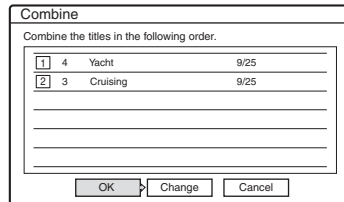

6 Select “OK,” and press **ENTER**.

The display for selecting a title name from among the selected titles appears.

To enter a new name, select “Enter Text,” and follow the explanations on page 38.

To change the selection, select “Change” and go to step 3.

7 Select a name, and press **ENTER**.

The titles are combined.

Note

When the number of chapters in the title to be combined exceeds the limit, the chapters at the end are combined into a single chapter.

Dividing a Playlist title (Divide Title)

HDD -RWVR

You can divide a Playlist title. For operations, see page 75.

Before Dubbing

HDD +RW -RW/VR -RW_{Video} +R -R

In this section, “dubbing” refers to “copying a recorded title on the internal hard disk drive (HDD) to another disc, or vice versa.” You can select to dub one title at a time (Title Dubbing – see “Dubbing a single title (Title Dub)” on page 81), or multiple titles all at once (Multiple Title Dubbing – see “Dubbing multiple titles (Dub Selected Titles)” on page 82).

Before you start, read the following precautions, which are common to both dubbing methods.

If you want to record from a digital video camera connected to the DV IN jack, see “DV/Digital8 Dubbing” on page 84. To record from equipment connected to the LINE IN jacks, see “Recording from connected equipment without a timer” on page 57.

Before you start...

- Select the disc type according to your needs (page 10). This recorder can record on various discs.
- Timer recordings and Synchro-Recording do not start during dubbing. Before you start, check the Timer List menu to see if there is any timer recording due to start during dubbing.
- When “Auto Chapter” of “Features” setup is set to “On,” chapter marks are automatically inserted at approximately 6 minute intervals while dubbing from the HDD to a DVD, or when the recorder detects picture and sound changes while dubbing from a DVD to the HDD. The chapter marks in the dubbing source are not retained in the dubbed title.

- For a title whose picture size (16:9 or 4:3) is mixed:
 - When dubbed from the HDD to DVD-RW (Video mode) or DVD-R, the picture size is determined by the setting in “DVD Rec. Picture Size” (page 53).
 - When dubbed from HDD to DVD+RW or DVD+R, the picture size is always 4:3.
 - When dubbed from HDD to DVD-RW (VR mode), the originally recorded picture size is retained.

Hints

- When you dub a Playlist title, it is recorded as an Original title.
- When dubbed from a DVD to the HDD, the picture size and the sound types originally recorded are retained.

Notes

- To play a dubbed disc on other DVD equipment, finalize the disc (page 40).
- The recorder may not function as described depending on the disc status. Follow the instructions that appear on the screen.
- You cannot dub from DVD VIDEOS to the HDD.
- Thumbnails that you have set for the originally recorded title (page 36) will not be retained in the dubbed title.

About “Dub Mode”

With this recorder, the recording mode for dubbing is displayed as “Dub Mode.” Two dubbing method are available: High-speed Dubbing and Rec Mode Conversion Dubbing. Read the following and select according to the required time, disc space, and picture quality.

Dubbing at high-speed (High-speed Dubbing)

HDD → +RW / -RW/VR / -RW_{Video} / +R / -R

Allows you to dub what you have stored in the HDD to a high-speed DVD (8x-speed DVD+RWs/6x-speed DVD-RWs/16x-speed DVD+Rs/16x-speed DVD-Rs, or slower versions of each disc type), without changing the recording mode.

Set “Dub Mode” to “Fast” in “Title Dub” or “Dub Selected Titles” display (page 81). You cannot select “Fast” when titles that cannot be dubbed at high speed are selected (such as the titles displayed in “Notes” below). The minimum required time is as follows (approximate).

Required times for High-speed Dubbing from HDD to DVD (for 60-minute program)^{*1}

Speed ^{*2}	6x	6x ^{*3}	8x ^{*4}	8x ^{*4}	2.4x
Rec. mode	High-speed DVD-RW	High-speed DVD+RW	High-speed DVD-R	High-speed DVD+R	DVD+R (Double Layer)
HQ	10 min.	10 min.	8 min.	8 min.	25 min.
HSP	6 min. 40 sec.	6 min. 40 sec.	5 min.	5 min.	16 min. 40 sec.
SP	5 min.	5 min.	3 min. 45 sec.	3 min. 45 sec.	12 min. 30 sec.
LSP	4 min.	4 min.	3 min.	3 min.	10 min.
LP	3 min. 20 sec.	3 min. 20 sec.	2 min. 30 sec.	2 min. 30 sec.	8 min. 20 sec.
EP	2 min. 30 sec.	2 min. 30 sec.	2 min.	2 min.	6 min. 15 sec.
SLP	1 min. 40 sec.	60 min. ^{*5}	1 min. 15 sec.	60 min. ^{*5}	60 min. ^{*5}
SEP	1 min. 15 sec.	60 min. ^{*5}	56 sec.	60 min. ^{*5}	60 min. ^{*5}

^{*1} The values in the above table are for reference only. Actual times for dubbing also require time for creating disc's control information and other data.

^{*2} This is the maximum recording speed of this recorder. The value may vary depending on the disc condition. Also, this recorder may be unable to record at the maximum speed for discs that support recording speeds exceeding the maximum value.

^{*3} The maximum drive speed of this recorder is 6x when using 6x-speed or faster DVD+RWs.

^{*4} The maximum drive speed of this recorder is 8x when using 8x-speed or faster DVD+Rs/DVD-Rs.

^{*5} High-speed dubbing is not available when dubbing titles recorded in SLP and SEP mode to DVD+RWs and DVD+Rs.

Notes

- High-speed Dubbing is not available for the following titles:
 - Titles recorded in HQ+.
 - Titles recorded in mixed picture size (4:3 and 16:9 etc.), (except DVD-RWs (VR mode)).
- When dubbed to a DVD-RW (Video mode)/DVD+RW/DVD+R/DVD-R, remnants of edited titles may remain on the disc. If you edit a title, use the Rec Mode Conversion Dubbing method. This will smooth out the pauses between the scenes.
- When playing a dubbed DVD+R DL disc, the video and audio may be momentarily interrupted at the point where the layers switch.

Rec Mode Conversion Dubbing



Allows you to dub from the HDD to a DVD or vice versa, in a dubbing mode that differs from the original recordings. For example, when you dub an HQ title (data size is large) in SP mode, you can reduce the data size, saving more titles using less space.

Select a mode different from the original recording in “Dub Mode” in the steps of “Dubbing a single title (Title Dub)” on page 81 or “Dubbing multiple titles (Dub Selected Titles)” on page 82.

When a title recorded to HDD in HQ or HQ+ mode is converted to another mode, the recorder automatically assigns an appropriate bit rate, thus retaining the original picture quality as much as possible.

Note

The picture quality will not improve even if a title is converted to a recording mode of better picture quality.

Dubbing restriction

You cannot dub movies and other DVD Videos to the HDD. Also, when dubbing from a DVD to the HDD, a gray, blank screen will be recorded for scenes that contain a copy protection signal.

Copy protection signals



* CPRM-compatible DVD-RWs (VR mode) only
CPRM (Content Protection for Recordable Media) is a coding technology that protects copyrights for images.

Move

HDD → -RW/VR

Titles containing “Copy-Once” copy protection signals can be moved only from HDD to DVD-RW (VR mode)* (after the title is moved, the original title in the HDD is erased). The “Move” function is performed using the same procedure as dubbing (page 81). Titles containing “Copy-Once” copy protection signals are indicated with COPY.

Notes

- The following titles in the HDD cannot be moved.
 - Protected titles
 - Playlist titles
 - Original titles referenced from the playlist
- If the move operation is stopped before completion, the title in the HDD is not erased.

* CPRM-compatible DVD-RWs (VR mode) only.

Dubbing

HDD +RW -RW/VR -RW_Video +R -R

Dubbing a single title (Title Dub)

- 1 Insert the DVD that you are going to dub to or from.**
- 2 Press HDD or DVD to select the source.**
- 3 Press TITLE LIST to turn on the Title List menu.**
- 4 Select a title, and press ENTER.**
The sub-menu appears.
- 5 Select “Dubbing,” and press ENTER.**
The display for selecting the dubbing mode appears.
If a title with COPY (page 81) is selected in the title list, a confirmation screen is displayed.
To “Move,” select “Yes.”

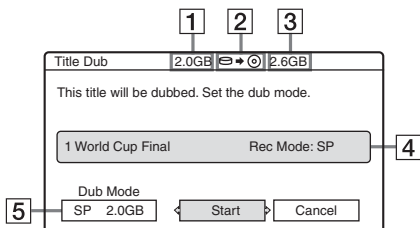

- 1** Size of the title (approximate)
 - 2** Direction of dubbing
 - 3** Available space on the disc to be dubbed (approximate)
 - 4** Information about the title to be dubbed
 - 5** Dubbing mode and the space that remains after dubbing (approximate)
- 6 Select “Dub Mode.”**

Dubbing (HDD ↔ DVD)

7 Select a dubbing mode by pressing ↑/↓.



* Appears when High-speed Dubbing is available for the title (page 79).

8 Select “Start,” and press ENTER.

The dubbing indication appears in the front panel display (page 38).

To automatically adjust the dubbing mode (Auto Dub Mode)

If there is not enough available space on the target disc, the recorder automatically selects a dubbing mode with lower picture quality according to the available space. If there is insufficient disc space in the selected dubbing mode, the following display appears after step 8.

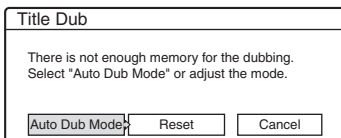

Select “Auto Dub Mode” and press ENTER to start dubbing. To manually select another dubbing mode, select “Reset,” and go to step 7.

To stop dubbing

Press TOOLS to select “Stop Dubbing,” and press ENTER. When asked for confirmation, select “Yes,” and press ENTER.

💡 Hints

- If disc space is still insufficient for the selected dubbing mode, erase unnecessary parts of the title, or free up disc space by erasing titles on the disc (page 76).
- You can turn off the recorder during dubbing. The recorder completes dubbing even after being turned off.

Dubbing multiple titles (Dub Selected Titles)

A maximum of 30 selected titles can be dubbed at once. You can select the dubbing mode for each title.

- 1 Insert the DVD that you are going to dub to or from.
- 2 Press HDD or DVD to select the source.
- 3 Press TITLE LIST to turn on the Title List menu.
- 4 Press TOOLS to select “Dub Selected Titles,” and press ENTER.

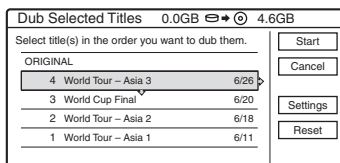

- 5 Select titles in the order you want to dub, and press ENTER.

The titles are numbered in the selected order. To cancel the selection, press ENTER again. If a title with COPY (page 81) is selected in the title list, a confirmation screen is displayed. To “Move,” select “Yes.”

- 6 Repeat step 5 to select all of the titles you want to dub.

To make adjustments for each of the titles, select “Settings” (see “To adjust the settings for each title” below). To cancel all of the selections, select “Reset,” and go to step 5.

- 7 Select “Start,” and press ENTER.

The dubbing indication appears in the front panel display (page 38).

To adjust the settings for each title

You can make detailed settings for each of the selected titles during Multiple Title Dubbing.

- 1 In step 6 of “Dubbing multiple titles (Dub Selected Titles)” on page 82, select “Settings” and press ENTER.

The following display for making the adjustments appears.

To re-select titles, select “Change,” and go to step 5 of “Dubbing multiple titles (Dub Selected Titles)” above. To have the recorder adjust the dubbing mode so all of the selected titles fit in, select “Auto mode.”

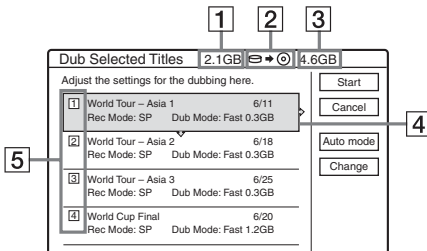

- 1 Total size of the selected titles
 - 2 Direction of dubbing
 - 3 Available space on the disc to be dubbed (approximate)
 - 4 Information about the title to be dubbed (title name, original recording mode, dubbing mode, and data size after dubbing)
 - 5 Order of dubbing
- 2 Select the title which you want to adjust, and press ENTER.
The sub-menu appears.
“Dub Mode”: Selects the dubbing mode for each title (page 79).
“Change Order”: Moves the title to change the dubbing order. Press \uparrow/\downarrow to select a new location, and press ENTER.
“Cancel”: Cancels the title selection. The title is excluded from dubbing.
 - 3 Select an option, and press ENTER.
 - 4 When you finish making adjustments, select “Start,” and press ENTER.

To automatically adjust the dubbing mode (Auto Dub Mode)

If there is not enough available space on the target disc, the recorder automatically selects a dubbing mode with lower picture quality according to the available space. The same dubbing mode is set for all of the titles. If disc space is insufficient for the selected dubbing mode, the following display appears after step 7 of “Dubbing multiple titles (Dub Selected Titles)” on page 82.

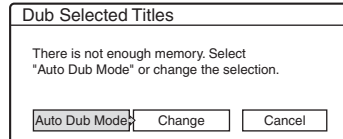

Select “Auto Dub Mode” and press ENTER. If you have selected only one title, select “OK.”

To stop dubbing

Press TOOLS to select “Stop Dubbing,” and press ENTER. When asked for confirmation, select “Yes,” and press ENTER.

💡 Hints

- You can turn off the recorder during dubbing. The recorder completes dubbing even after being turned off.
- You can start Multiple Title Dubbing by selecting “DUBBING” from the System Menu.

Before DV/Digital8 Dubbing

This section explains dubbing with a digital video camera via the DV IN jack on the front panel. If you want to dub by way of the LINE IN jacks, see “Recording from connected equipment without a timer” on page 57.

To record from the DV IN jack

The DV IN jack on this recorder conforms to the i.LINK standard. You can connect any other equipment that has an i.LINK (DV) jack, and record digital signals.

Follow the instructions in “Preparing for DV/Digital8 dubbing,” and then move on to the section on dubbing. For more information about i.LINK, see “About i.LINK” on page 108.

Hint

If you plan to do additional editing on a disc after the initial dub, use the DV IN jack and record on a DVD-RW (VR mode) or HDD.

Preparing for DV/Digital8 dubbing

You can connect a digital video camera to the DV IN jack on the recorder to record or edit from a DV/Digital8 format tape. Operation is straightforward because the recorder will fast forward and rewind the tape for you – you do not need to operate your digital video camera. Do the following to start using the “DV Edit” functions of this recorder.

See the instruction manual supplied with the digital video camera as well before connecting.

Notes

- The DV IN jack is for input only. It will not output signals.
- You cannot use the DV IN jack when:
 - your digital video camera does not work with this recorder. Connect the camera to the LINE IN jack and follow the instructions of “Recording from connected equipment without a timer” on page 57.
 - the input signal is not in DVC-SD format. Do not connect a MICRO MV format digital video camera even if it has an i.LINK jack.
 - the images on the tape contain copy protection signals, which limit recording.
- If you want to play the disc on other DVD equipment, finalize the disc (page 40).

Hookups

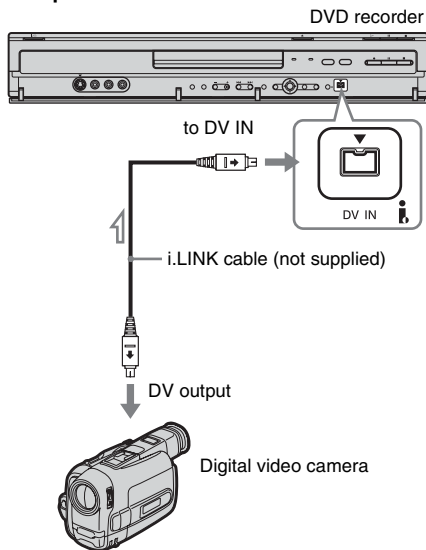

1 Press HDD or DVD to select the recording destination.

If you select DVD, insert a disc (see “Inserting a Disc” on page 31).

2 Insert the source DV/Digital8 format tape into your digital video camera.

For the recorder to record or edit, your digital video camera must be set to video playback mode.

3 Press INPUT SELECT on the remote repeatedly to select “DV.”

The front panel display changes as follows:

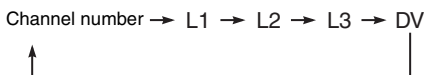

4 Press REC MODE on the remote repeatedly to select the recording mode.

The recording mode changes as follows:

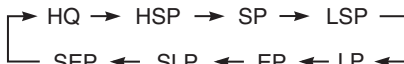

For details about the recording mode, see page 49.

5 Press **TOOLS** on the remote to select “DV/D8 Audio Input,” and press **ENTER**. Then, select the setting for the audio input.

“Stereo1” (default): Records original sound only. Normally select this when dubbing a DV format tape.

“Mix”: Records both stereo 1 and 2.

“Stereo2”: Records additional audio only.

Select “Mix” or “Stereo2” only if you have added a second audio channel when recording with your digital video camera.

You are ready to start dubbing. Select one of the dubbing methods on the following pages.

Hints

- You can turn off the recorder during dubbing. The recorder completes dubbing even after being turned off.
- You can adjust the settings for the recording picture before recording. See “Adjusting the recording picture quality and size” on page 53.

Notes

- You cannot connect more than one piece of digital video equipment to the recorder.
- You cannot control the recorder using another device or another recorder of the same model.
- You cannot record date, time, or the contents of the cassette memory onto the disc.
- If you record from a DV/Digital8 format tape that is recorded in multiple sound tracks, such as a tape with multiple sampling frequencies (48 kHz, 44.1 kHz, or 32 kHz), no sound or an unnatural sound will be output when playing back the sampling frequency switch point on the disc.
- In order to use this recorder’s “Auto Chapter” setting (pages 85, 86), be sure to correctly set the clock on your digital video camera before shooting.
- The recorded picture may be momentarily affected if the picture size of the source image changes, or if there is nothing recorded on the tape.

Recording an Entire DV/Digital8 Format Tape (One Touch Dubbing)

HDD **+RW** **-RWVR** **-RWvideo** **+R** **-R**

You can record the entire contents of a DV/Digital8 format tape onto a disc with a single press of the **ONE-TOUCH DUB** button on the recorder. The recorder controls the digital video camera for the whole process, and completes the recording.

How chapters are created

The contents dubbed to the HDD or DVD become a single title. When “Auto Chapter” of “Features” setup is set to “On” (page 96), this title is divided into chapters. When dubbing to the HDD or a DVD-RW (VR mode), each shooting session on the tape becomes a chapter on the disc. For other discs, the recorder divides the title into chapters at approximately 6 minute intervals.

Follow steps 1 to 5 of “Preparing for DV/Digital8 dubbing” on page 84, and press **ONE-TOUCH DUB** on the recorder.

The recorder rewinds the tape and then starts recording the tape contents.

When the recording is finished, the recorder rewinds the tape in the digital video camera.

To stop during recording

Open the remote’s cover and press **■ REC STOP**. Note that it may take a few seconds for the recorder to stop recording.

Hints

- If you set “Finalize Disc” of “One Touch Dubbing” to “Auto” in “Features” setup (page 97), the recorded disc (except DVD-RW (VR mode)) will automatically be finalized after recording is finished.
- You can play back a previously recorded title on the HDD while One Touch Dubbing is in progress.

Notes

- When a blank space between the recordings on the tape continues for more than five minutes, One Touch Dubbing ends automatically.
- The recorder records a blank for five minutes before it stops dubbing. To stop the blank recording, press **■ REC STOP**.

Program Edit

HDD +RW -RWVR -RW_{Video} +R -R

You can select scenes from a DV/Digital8 format tape, and then automatically record selected scenes to the HDD or a DVD.

To use this function, you will do the following:

Connect your digital video camera and prepare for recording



Select and edit the scenes you want to dub

Using the recorder's remote control, fast forward or rewind the tape to select the scenes. At this point, the selected scenes are not copied to the disc. The recorder only remembers the IN and OUT points of the scenes that you selected for dubbing. You can also reset, erase, or change the order of the scenes.



Dub the selected scenes

After you have selected the scenes, the recorder will fast forward and rewind the tape automatically and record the scenes to the HDD or a DVD.

◆ How chapters are created

The contents dubbed to the HDD or DVD become a single title. When "Auto Chapter" of "Features" setup is set to "On" (page 96), this title is divided into chapters. When dubbing to the HDD or a DVD-RW (VR mode), each shooting session on the tape becomes a chapter on the disc. For other discs, the recorder divides the title into chapters at approximately 6 minute intervals.

1 Follow steps 1 to 5 of "Preparing for DV/Digital8 dubbing" on page 84, and press SYSTEM MENU.

2 Select "DV/D8 EDIT," and press ENTER.

The display asks if you want to start selecting scenes.

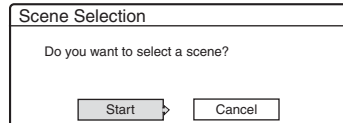

- If you have previously saved a program, the display asks if you want to edit an existing program or to create a new program. To resume editing the existing program, select "Saved Data," and go to step 6.

3 Select "Start," and press ENTER.

The display for setting the IN point (start of the scene) appears.

The scene starts to play in the background.

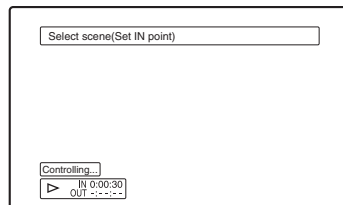

4 Select the IN point by pressing ◀◀/▶▶, and press ENTER.

The display for setting the OUT point (end of the scene) appears. The scene starts to play in the background from the IN point.

5 Select the OUT point by pressing ◀◀/▶▶, and press ENTER.

The display asks if you want to add the selected scene to the Scene List menu.

To preview the scene, select "Preview."

To reset either the IN or OUT point, select "Change IN" or "Change OUT," and repeat the steps above.

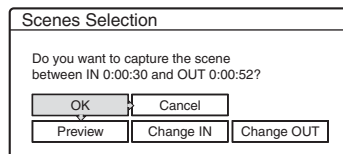

6 Select “OK,” and press ENTER.

A new Scene List menu appears with the selected scene.

To add a scene, select “Add.”

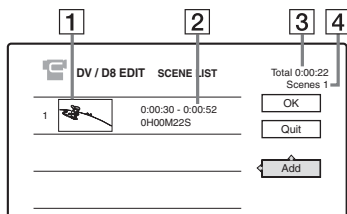

- 1 Thumbnail picture
- 2 Time information
- 3 Total duration of the program
- 4 Total number of scenes

7 When you finish adding scenes, select the scene you want to edit, and press ENTER.

The sub-menu appears.

“Move”: Changes the scene order. Follow the explanations on the screen to change the order by pressing \uparrow/\downarrow and ENTER.

“Erase”: Erases the scene. When asked for confirmation, select “OK.”

“Preview”: Plays the selected scene.

“Change IN”: Changes the start of the scene. Repeat from step 4.

“Change OUT”: Changes the end of the scene. Repeat from step 5.

8 When you finish editing the Scene List, select “OK,” and press ENTER.

The display for entering the title name appears. To enter a new name, select “Enter,” and follow the explanations on page 38.

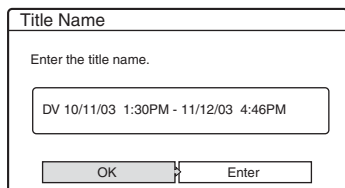

9 Select “OK,” and press ENTER.

The default title name is fixed, and the display asks if you want to start recording.

To change the disc media, select “Media” and press \uparrow/\downarrow . To change the dubbing mode, select “Dub Mode” and press \uparrow/\downarrow .

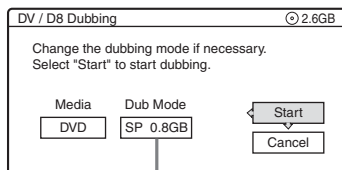

Data capacity required for the dubbing

10 Select “Start,” and press ENTER.

The recorder starts recording the tape contents as programmed.

- If the recording does not fit due to the dubbing mode you selected, the display asks if you want to continue.

To change the dubbing mode, select “Reset” and repeat from step 9.

To have the recorder adjust the dubbing mode, select “Auto Dub Mode.”

- If there is not enough disc space even after changing the dubbing mode, the display asks if you want to record halfway. To continue, select “OK.”

To stop during recording

Open the remote’s cover and press \blacksquare REC STOP. Note that it may take a few seconds for the recorder to stop recording.

Notes

- Contents recorded to the HDD or a DVD may not be recorded as programmed if the tape’s time code is not sequential or there are blanks between the recordings on the tape. In this case, see “Recording from connected equipment without a timer” on page 57.
- The start and end points of a program may be different from what you have set if the source DV/Digital8 format tape is in any of the following conditions:
 - Recording mode was changed during the recording.
 - There is a blank space in the recorded portion of the tape.
- If you set the beginning of the tape as the IN point and the end point as the OUT point, the IN and OUT points may move slightly during dubbing.
- You cannot set a scene to be shorter than one second.

Antenna Reception and Language Settings (Settings)

The “Settings” setup helps you to make tuner, clock, and language settings for the recorder.

1 Press **SYSTEM MENU** while the recorder is in stop mode.

2 Select “**SETUP**,” and press **ENTER**.

3 Select “**Settings**,” and press **ENTER**.

The options of “Settings” appear. The default settings are underlined.

To turn off the display, press **SYSTEM MENU** repeatedly.

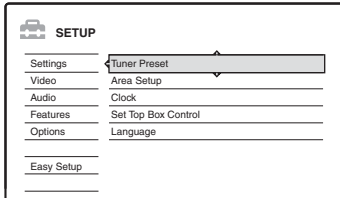

Tuner Preset

Notes

- You cannot preset channels for the connected cable box or satellite receiver.
- You cannot select “Tuner Preset” when you set “Set Top Box Control” to “On”.

Auto Preset

Automatically presets the receivable channels. The recorder can receive VHF channels 2 to 13, UHF channels 14 to 69, and unscrambled CATV channels 1 to 125. First, we recommend that you preset the receivable channels in your area using automatic presetting methods.

1 Select “**Tuner Preset**” in “**Settings**,” and press **ENTER**.

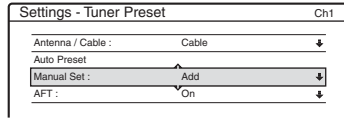

2 Select “**Antenna/Cable**,” and press **ENTER**.

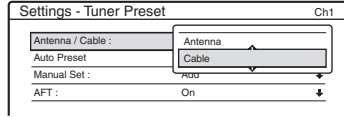

<u>Cable</u>	Presets cable TV channels.
Antenna	Presets VHF and UHF channels.

3 Select an option, and press **ENTER**.

4 Select “**Auto Preset**,” and press **ENTER**. All receivable channels are preset in numerical sequence.

Manual Set

Presets or disables channels manually.

If some channels could not be set using the “Auto Preset” or “Easy Setup” function, you can set them manually.

1 Select “**Tuner Preset**” in “**Settings**,” and press **ENTER**.

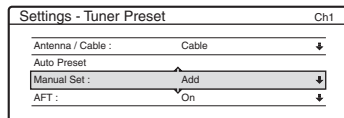

2 Select “**Antenna/Cable**,” and press **ENTER**.

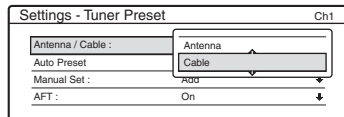

<u>Cable</u>	Presets cable TV channels.
Antenna	Presets VHF and UHF channels.

- Select the channel you want to preset using the number buttons and the SET button. To disable a channel, select the channel using CH +/-.

Channel to be preset/disabled

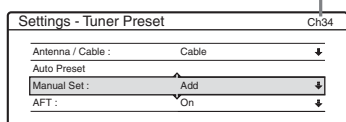

- Select "Manual Set," and press ENTER.

<u>Add</u>	Presets the channels.
<u>Erase</u>	Disables the channels.

- Select "Add" to preset the channel, and press ENTER.

- Select "AFT" and press ENTER.

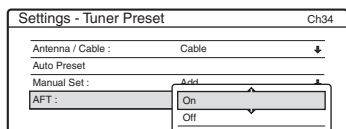

<u>On</u>	Turns on the Auto Fine Tuning function. Normally, select this.
<u>Off</u>	Allows you to adjust the picture manually.

- Select "On" to turn on AFT, and press ENTER.

To preset or disable another channel, repeat from step 2.

- If the Auto Fine Tuning function does not work effectively, select "Off" in step 6 and press ENTER. When the fine tuning bar appears, press ←/→ to obtain a clearer picture, and press ENTER.

- To preset or disable another channel, repeat steps 3 to 7.

Area Setup

Sets up your area and zip code number. You need to set this correctly to use the TV Guide On Screen system.

- Select "Area Setup" in "Settings," and press ENTER.

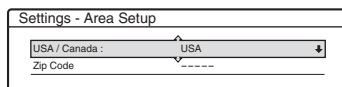

- Select "USA/Canada," and press ENTER.

- Select your country, and press ENTER.

- Select "Zip Code," and press ENTER.

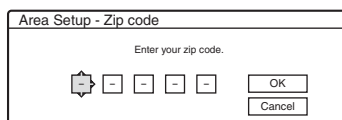

- Enter your zip code number using ←/↑/↓/→, and press ENTER.

- Select "OK," and press ENTER.

Clock

Set the clock manually.

- Select "Clock" in "Settings," and press ENTER.

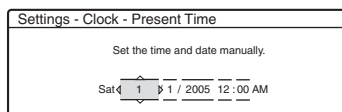

- Press ↑/↓ to set the month, and press →. Set the day, year, hour, and minutes in sequence. Press ←/→ to select the item to be set, then press ↑/↓ to set the numbers. The day of the week is set automatically.

- Press ENTER to start the clock.

Hint

To change the numbers in step 2, press ← to return to the item to be changed, and select the numbers by pressing ↑/↓.

Set Top Box Control

You can control your cable box/satellite receiver using the supplied set top box controller. See “Step 7: Easy Setup” on page 25 for details.

Set Top Box Control

On	Turns on the cable box/satellite receiver control function. See “Using the cable box/satellite receiver control function” (page 14).
<u>Off</u>	Turns off the cable box/satellite receiver control function. Select this if you do not want to use the supplied set top box controller.

When “Set Top Box Control” is set to “On,” you can make the following settings. Note that when you change “Set Top Box Control” to “On” or “Off,” all of the timer recording settings will be canceled.

◆ Brand Code

See “Cable Box/Satellite Receiver Brand Code” (page 117) for the brand code for your cable box or satellite receiver, and enter the code using the number buttons and ENTER.

◆ Connection

Selects the connection you used for your cable box or satellite receiver. When the cable box or satellite receiver is connected to the recorder’s LINE IN jacks, select the connection from “Line1,” “Line2,” or “Line3.” When the cable box or satellite receiver is connected to the recorder’s VHF/UHF IN jack, select the output channel, “Ch2,” “Ch3,” or “Ch4.”

◆ Ch. digit lock

Allows you to select whether to fix the digits for your cable box or satellite receiver.

<u>Off</u>	Select this when your cable box or satellite receiver only accepts a three or more digit channel number. Normally select this.
Lock to two digits	Select this only when your cable box or satellite receiver only accepts a two digit channel number.

◆ Mode for SET button

Select “Mode 1” or “Mode 2” if your cable box or satellite receiver requires pressing ENTER or SET, etc., after entering the channel number. If “Mode 1” does not work, try “Mode 2.” If your cable box or satellite receiver does not respond to either setting, contact the manufacturer of the cable box or satellite receiver.

<u>Off</u>	No code is sent when SET is pressed. Normally select this.
Mode 1	Sends the channel number you entered.
Mode 2	Sends the channel number you entered.

Language

OSD (On-Screen Display)

Switches the display language on the screen.

DVD Menu (DVD VIDEO only)

Switches the language for the DVD menu.

Audio (DVD VIDEO only)

Switches the language of the sound track.

When you select “Original,” the language given priority in the disc is selected.

Subtitle (DVD VIDEO only)

Switches the language of the subtitles recorded on the disc.

When you select “Audio Follow,” the subtitle language changes according to the language you selected for the sound track.

💡 Hint

If you select “Others” in “DVD Menu,” “Subtitle,” or “Audio,” select and enter a language code from “Language Code List” on page 116 using the number buttons.

🔔 Note

If you select a language in “DVD Menu,” “Subtitle,” or “Audio” that is not recorded on the DVD VIDEO, one of the recorded languages will be automatically selected.

Video Settings (Video)

Video settings will adjust items related to the image, such as size and color.

Choose the settings according to the type of TV, tuner, or decoder connected to the DVD recorder.

- 1** Press **SYSTEM MENU** while the recorder is in stop mode.
- 2** Select **“SETUP,”** and press **ENTER.**
- 3** Select **“Video,”** and press **ENTER.**

The “Video” setup appears with the following options. The default settings are underlined.

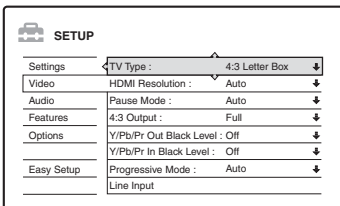

TV Type

Sets the picture size when playing back a title recorded from 16:9 size video (page 53) or a 16:9 size commercial DVD video.

Select the playback picture size according to the type of connected TV (wide-screen/wide mode TV or conventional 4:3 screen TV).

16:9	Select this when connecting to a wide-screen TV or TV with a wide mode function.
<u>4:3 Letter Box</u>	Select this when connecting to a 4:3 screen TV. Displays a wide picture with bands on the upper and lower portions of the screen.
4:3 Pan Scan	Select this when connecting to a 4:3 screen TV. Automatically displays a wide picture on the entire screen and cuts off the portions that do not fit.

16:9



4:3 Letter Box



4:3 Pan Scan



Note

Depending on the disc, “4:3 Letter Box” may be selected automatically instead of “4:3 Pan Scan” or vice versa.

HDMI Resolution

Selects the type of video signals output from the HDMI OUT jack. When you select “Auto” (default), the recorder outputs video signals of the highest resolution acceptable for your TV. If the picture is not clear, natural or to your satisfaction, try another option that suits the disc and your TV/projector, etc. For details, refer also to the instruction manual supplied with the TV/projector, etc.

<u>Auto</u>	Normally, select this.
1920×1080i	Sends 1920×1080i video signals.
1280×720p	Sends 1280×720p video signals.
720×480p	Sends 720×480p video signals.

Note

Even when a setting other than “Auto” is selected and the connected TV cannot accept the resolution, the recorder automatically adjusts the video signals that are suitable for the TV.

Pause Mode (HDD/DVDs only)

Selects the picture quality in pause mode.

<u>Auto</u>	The picture, including subjects that move dynamically, is output with no jitter. Normally select this position.
Frame	The picture, including subjects that do not move dynamically, is output in high resolution.

4:3 Output

This setting is effective only when you set “TV Type” in “Video” to “16:9.”

Adjust this to watch 4:3 aspect ratio progressive signals. If you can change the aspect ratio on your progressive format (480p) compatible TV, change the setting on your TV, not the recorder. Note that this setting is effective only for HDMI connection or progressive signals output from the COMPONENT VIDEO OUT jacks.

<u>Full</u>	Select this when you can change the aspect ratio on your TV.
Normal	Select this when you cannot change the aspect ratio on your TV. Shows a 16:9 aspect ratio signal with black bands on left and right sides of the image.

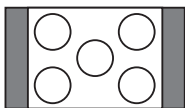

16:9 aspect ratio TV

Y/Pb/Pr Out Black Level

Selects the black level (setup level) for the video signals output from the COMPONENT VIDEO OUT jacks (page 18).

This setting is not effective when the PROGRESSIVE indicator lights up on the front panel and the recorder outputs progressive signals.

<u>On</u>	Raises the standard black level. Select this when the picture appears too dark.
<u>Off</u>	Sets the black level of the output signal to the standard level. Normally, select this.

Y/Pb/Pr In Black Level

Selects the black level (setup level) for the NTSC video signals input from the COMPONENT VIDEO IN jacks (page 15). This setting is available when “Line1 Input” is set to “Component” (page 93).

<u>On</u>	Raises the standard black level. Select this when the picture appears too bright.
<u>Off</u>	Sets the black level of the input signals to the standard level. Normally, select this.

Progressive Mode

DVD software can be divided into two types: film based software and video based software. Video based software is derived from TV, such as dramas and sit-coms, and displays images at 30 frames/60 fields per second. Film based software is derived from film and displays images at 24 frames per second. Some DVD software contains both Video and Film.

In order for these images to appear natural on your screen when output in PROGRESSIVE mode, the progressive video signal needs to be converted to match the type of DVD software that you are watching.

You can fine-tune the progressive 480p video signals that are output when you press PROGRESSIVE (“PROGRESSIVE” lights up).

Note that you must connect to a progressive format TV using the COMPONENT VIDEO OUT jacks (page 18).

<u>Auto</u>	Automatically detects the software type (Film-based or Video-based) and selects the appropriate conversion mode. Normally select this position.
Video	Fixes the conversion mode to the mode for Video-based software.

Line Input

Sets the method of inputting video signals from the LINE IN jacks on the rear panel of the recorder. Select an option for each of the items below according to the combination of jacks and methods that you are going to use.

◆ Line1 Input

Selects a method of inputting video signals for the LINE IN 1 jack on the rear panel of the recorder.

<u>V</u> ideo	Inputs video signals.
S Video	Inputs S video signals.
Component	Inputs component signals.

◆ Line3 Input

Selects the method of inputting video signals for the LINE IN 3 jack on the rear panel of the recorder. The pictures will not be clear if this setting does not match the type of video input signal.

<u>V</u> ideo	Inputs video signals.
S Video	Inputs S video signals.

Audio Settings (Audio)

The “Audio” setup allows you to adjust the sound according to the playback and connection conditions.

1 Press SYSTEM MENU while the recorder is in stop mode.

2 Select “SETUP,” and press ENTER.

3 Select “Audio,” and press ENTER.

The “Audio” setup appears with the following options. The default settings are underlined.

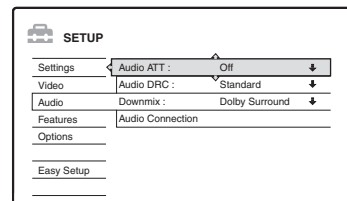

Audio ATT (attenuation)

If the playback sound is distorted, set this item to “On.” The recorder reduces the audio output level. This function affects the output of the following jacks:

– LINE OUT (R-AUDIO-L) 1/2 jacks

<u>O</u> n	Select this when the playback sound from the speakers is distorted.
<u>O</u> ff	Normally select this position.

Audio DRC (Dynamic Range Control) (DVDs only)

Makes the sound clear when the volume is turned down when playing a DVD that conforms to "Audio DRC." This affects the output from the following jacks:

- LINE OUT (R-AUDIO-L) 1/2 jacks
- DIGITAL OUT (OPTICAL or COAXIAL)/HDMI OUT jack only when "Dolby Digital" is set to "D-PCM" (page 94).

<u>Standard</u>	Normally select this position.
TV Mode	Makes low sounds clear even if you turn the volume down.
Wide Range	Gives you the feeling of being at a live performance.

Downmix (DVDs only)

Switches the method for mixing down to two channels when you play a DVD which has rear sound elements (channels) or is recorded in Dolby Digital format. For details on the rear signal components, see "4. Displaying the Playing Time and Play Information" on page 36. This function affects the output of the following jacks:

- LINE OUT (R-AUDIO-L) 1/2 jacks
- DIGITAL OUT (OPTICAL or COAXIAL)/HDMI OUT jack when "Dolby Digital" is set to "D-PCM" (page 94).

<u>Dolby Surround</u>	Normally select this position. Multi-channel audio signals are output to two channels for enjoying surround sounds.
Normal	Multi-channel audio signals are downmixed to two channels for use with your stereo.

Audio Connection

The following setup items switch the method of outputting audio signals when you connect a component such as an amplifier (receiver) with a digital input jack.

For connection details, see "Step 4: Connecting the Audio Cords" on page 20. Select "Dolby Digital," "DTS," "48kHz/96kHz PCM," and "Audio(HDMI)" after setting "Digital Out" to "On."

If you connect a component that does not accept the selected audio signal, a loud noise (or no sound) will come out from the speakers, and may affect your ears or cause speaker damage.

- 1 Select "Audio Connection" in "Audio," and press ENTER.

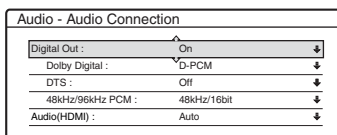

- 2 Select "Digital Out," and press ENTER.

<u>On</u>	Normally select this position.
Off	The influence of the digital circuit upon the analog circuit is minimal.

- 3 Select "On," and press ENTER.

- 4 Set the digital output signal.

- Dolby Digital (HDD/DVDs only)
Selects the type of Dolby Digital signal.

<u>D-PCM</u>	Select this when the recorder is connected to an audio component lacking a built-in Dolby Digital decoder. The surround effects of output signals are determined by the "Downmix" setting item in "Audio" setup.
Dolby Digital	Select this when the recorder is connected to an audio component with a built-in Dolby Digital decoder.

Note

If the HDMI OUT jack is connected to equipment not compatible with DOLBY DIGITAL signals, the "D-PCM" signals will be automatically output even when you select "Dolby Digital."

- **DTS (DVD VIDEO only)**

Selects whether or not to output DTS signals.

On	Select this when the recorder is connected to an audio component with a built-in DTS decoder.
Off	Select this when the recorder is connected to an audio component without a built-in DTS decoder.

 **Note**

When HDMI output is performed to equipment not compatible with DTS signals, the signals will not be output regardless of the “DTS” setting.

- **48kHz/96kHz PCM (DVD VIDEO only)**

Selects the sampling frequency of the audio signal.

<u>48kHz/16bit</u>	The DVD video audio signal is converted to 48kHz/16bit and output.
96kHz/24bit	All signals containing 96kHz/24bit are output without conversion. However, the signals are output at 48kHz/16bit if copyright-protected signals are contained.

 **Notes**

- “48kHz/96kHz PCM” setting has no effect when audio signals are output from the LINE OUT 2 (R-AUDIO-L) jacks. If the sampling frequency is 96kHz, signals are simply converted to 96kHz analog signals and output.
- If the HDMI OUT jack is connected to equipment not compatible with 96 kHz signals, 48kHz PCM will be automatically output even when you select “96kHz/24bit.”

- **Audio(HDMI)**

Selects the type of audio signal output from the HDMI OUT jack.

<u>Auto</u>	Normally, select this. Outputs the optimum audio signal that can be received by the TV based on the “Digital Out” setting (page 94).
PCM	Converts Dolby Digital or 96 kHz PCM signals to 48 kHz/16 bit PCM.

 **Notes**

- A loud noise (or no sound) will be output if you connect the recorder to a TV that is not compatible with DOLBY DIGITAL/DTS signals and “Auto” is selected. In this case, select “PCM.”
- Set “Digital Out” to “On” when outputting compressed audio signals to an HDMI compatible TV.

Recording and Parental Control Settings (Features)

The “Features” setup allows you to adjust recording and parental control settings.

1 Press **SYSTEM MENU** while the recorder is in stop mode.

2 Select **“SETUP,”** and press **ENTER.**

3 Select **“Features,”** and press **ENTER.**

The “Features” setup appears with the following options. The default settings are underlined.

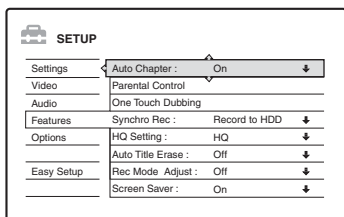

Auto Chapter

Selects whether to automatically divide a recording (a title) into chapters during recording or dubbing.

<u>On</u>	For the HDD or a DVD-RW (VR mode), the recorder detects changes in the picture and sound and automatically inserts chapter marks. For other recordable discs, the recorder inserts chapter marks at approximately 6 minute intervals.
Off	No chapter mark is inserted.

Notes

- The actual chapter mark interval may vary depending on the amount of information contained in the video to be recorded.
- Chapter marks are automatically inserted where the recordings start on the tape when “Auto Chapter” is set to “On” during DV dubbing to the HDD or a DVD-RW (VR mode).

Parental Control (DVD VIDEO only)

Playback of some DVD VIDEOS can be limited according to a predetermined level, such as the age of the users. Scenes may be blocked or replaced with different scenes.

1 Select **“Parental Control”** in **“Features,”** and press **ENTER.**

- If you have not entered a password, the display for registering a new password appears.

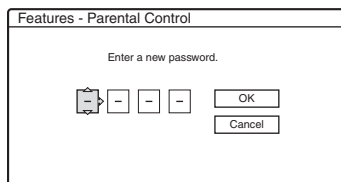

- When you have already registered a password, the display for entering the password appears.

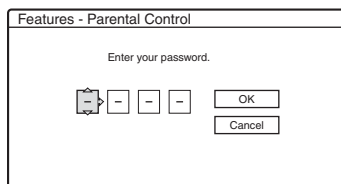

2 Enter your four-digit password using the number buttons, then select **“OK”** and press **ENTER.**

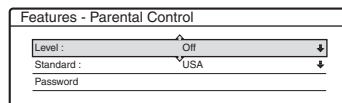

3 Select **“Standard,”** and press **→** or **ENTER.** The selection items for **“Standard”** are displayed.

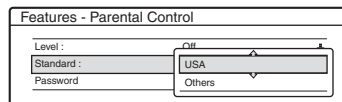

4 Select a geographic area as the playback limitation level, and press **ENTER.** The area is selected.

- When you select **“Others,”** press the number buttons to select and enter an area code in the table (page 116). Then select **“OK”** and press **ENTER.**

- 5 Select “Level,” and press ENTER.
The selection items for “Level” are displayed.

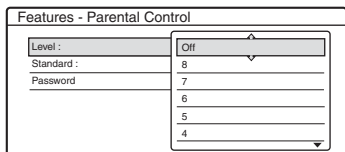

The lower the value, the stricter the limitation. Discs rated higher than the selected level will be restricted.

- 6 Select the level, and press ENTER.
The Parental Control setting is complete.

To cancel the Parental Control setting for the disc, set “Level” to “Off” in step 6.

To change the password, select “Password” in step 3, and press ENTER. When the display for registering a password appears, enter a new four-digit password using the number buttons, then select “OK” and press ENTER.

Notes

- If you forget your password, you will have to reset it by selecting “Parental Control” of “Factory Setup” in “Options” setup (page 99).
- When you play discs which do not have the Parental Control function, playback cannot be limited on this recorder.
- Depending on the disc, you may be asked to change the Parental Control level while playing the disc. In this case, enter your password, then change the level.

One Touch Dubbing

Displays the following option for the One Touch Dub function.

◆ Finalize Disc (for all recordable discs except DVD-RW in VR mode)

Selects whether or not to finalize the disc automatically following One Touch Dubbing (page 85).

Auto	Automatically finalizes the disc following One Touch Dubbing.
<u>Manual</u>	Allows you to finalize the disc manually.

Synchro Rec

Selects the recording destination used for Synchro-Recording (page 56).

<u>Record to HDD</u>	Records to the HDD.
Record to DVD	Records to DVDs.

HQ Setting (HDD only)

Selects the HQ mode used for recording on the HDD (page 49).

HQ+	Records in higher quality (approximate 15 Mbps).
<u>HQ</u>	Records in the standard HQ mode.

Auto Title Erase (HDD only)

On	Automatically erases old titles recorded on the HDD (page 51).
<u>Off</u>	Turns off the function.

Rec Mode Adjust

On	Automatically adjusts the recording mode to enable the entire program to be recorded (page 51).
<u>Off</u>	Turns off the function.

Screen Saver

The screen saver image appears when you do not use the recorder for more than 10 minutes while an on-screen display, such as the System Menu, is displayed on your TV screen. The screen saver image helps prevent your display device from becoming damaged (ghosting).

<u>On</u>	Turns on the screen saver function.
Off	Turns off the function.

Disc and Remote Control Settings/Factory Settings (Options)

The “Options” setup allows you to set up other operational settings.

- 1** Press **SYSTEM MENU** while the recorder is in stop mode.
- 2** Select “**SETUP**,” and press **ENTER**.
- 3** Select “**Options**,” and press **ENTER**.
The “Options” setup appears with the following options. The default settings are underlined.

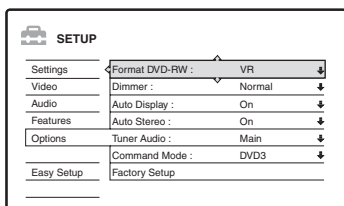

Format DVD-RW (DVD-RW only)

The recorder automatically starts formatting in VR mode or Video mode, whichever is selected below, when a new, unformatted DVD-RW is inserted.

<u>VR</u>	Automatically formats the disc in VR mode.
Video	Automatically formats the disc in Video mode.

Dimmer

Adjusts the lighting of the front panel display.

<u>Normal</u>	Bright lighting.
Power Save	Low lighting. Turns off the lighting when the power is off.

Auto Display

<u>On</u>	Automatically displays information on the screen when the recorder is turned on, etc.
Off	Displays information only when DISPLAY is pressed.

Auto Stereo

This function is effective only when “Tuner Audio” is set to “Main.”

<u>On</u>	Receives stereo programs. Normally select this.
Off	Select this to reduce noise. The sound changes to monaural.

Tuner Audio

Selects the sound to be recorded.

<u>Main</u>	Records only the main sound.
SAP	Records only the SAP (Second Audio Program) sound.

Note

If no SAP sound is received, the main sound is recorded regardless of the setting.

Command Mode

Changes the Command Mode of the recorder if other DVD equipment is assigned the same Command Mode. Be sure to match the Command Mode switch on the remote to the setting made here. For details, see “If you have a Sony DVD player or more than one Sony DVD recorder” on page 24.

DVD1	Select this if the default Command Mode conflicts with other DVD equipment.
DVD2	Select this if the default Command Mode conflicts with other DVD equipment.
<u>DVD3</u>	The default Command Mode of the recorder.

Factory Setup

Allows you to select the setup settings by group, and return them to their default settings. Note that all of your previous settings will be lost.

- 1 Select "Factory Setup" in "Options," and press **→** or ENTER.
The display for selecting a group of settings appears.
- 2 Select the group of settings you want to return to default from "Settings," "Video," "Audio," "Features," "Options," "Parental Control," and "All," and press **→** or ENTER.
- 3 Select "Start," and press ENTER.
The selected settings return to their default settings.
- 4 Press ENTER when "Finish" appears.

Easy Setup (Resetting the Recorder)

Select this to run the "Easy Setup" program.

- 1 Press **SYSTEM MENU** while the recorder is in stop mode.
- 2 Select **"SETUP,"** and press **ENTER.**
- 3 Select **"Easy Setup,"** and press **ENTER.**

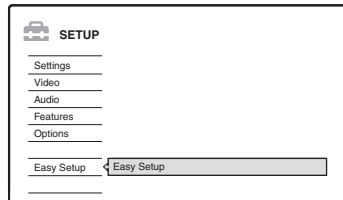

- 4 Press **ENTER.**
- 5 Select **"Start."**
- 6 Follow the instructions for "Easy Setup" (page 25) from step 2.

Additional Information

Troubleshooting

If you experience any of the following difficulties while using the recorder, use this troubleshooting guide to help remedy the problem before requesting repairs. Should any problem persist, consult your nearest Sony dealer.

Power

The power does not turn on.

- ➔ Check that the AC power cord is connected securely.

Picture

There is no picture.

- ➔ Re-connect all connecting cords securely.
- ➔ The connecting cords are damaged.
- ➔ Check the connection to your TV (page 14).
- ➔ Switch the input selector on your TV (such as to “VCR”) so that the signal from the recorder appears on the TV screen.
- ➔ When playing a double-layer DVD, the video and audio may be momentarily interrupted at the point where the layers switch.

Picture noise appears.

- ➔ If the picture output signal from your recorder passes through your VCR to get to your TV, or if you are connected to a combination TV/VIDEO player, the copy-protection signal applied to some DVD programs could affect picture quality. If you still experience this problem even when you connect your recorder directly to your TV, try connecting your recorder to your TV’s S VIDEO input.
- ➔ You have set the recorder to progressive format (the PROGRESSIVE indicator lights up) even though your TV cannot accept the progressive signal. In this case, press PROGRESSIVE until the PROGRESSIVE indicator turns off.

- ➔ Even if your TV is compatible with progressive format (480p) signals, the image may be affected when you set the recorder to progressive format. In this case, disconnect the HDMI cord from the recorder, and then press PROGRESSIVE so that the PROGRESSIVE indicator turns off and the recorder is set to normal (interlace) format.
- ➔ Noise may appear in the pictures recorded on the HDD, which is due to the characteristics of HDD, and is not a malfunction.
- ➔ When playing a double-layer DVD, the video and audio may be momentarily interrupted at the point where the layers switch.

There is no picture or the picture noise appears when connected to the HDMI OUT jack.

- ➔ Try the following: ①Turn the recorder off and on again. ②Turn the connected equipment off and on again. ③Disconnect and then connect the HDMI cord again.
- ➔ If the HDMI OUT jack is used for video output, changing the “HDMI Resolution” setting in the “Video” setup may solve the problem (page 91). Connect the TV and the recorder using a video jack other than the HDMI OUT, and switch the TV’s input to the connected video input so that you can see the on-screen displays. Change the “HDMI Resolution” setting in the “Video” setup, and switch the TV’s input back to HDMI. If the picture still does not appear, repeat the steps and try other options.
- ➔ The recorder is connected to an input device that is not HDCP compliant (page 18).

TV program reception does not fill the screen.

- ➔ Set the channel manually in “Tuner Preset” in “Settings” setup (page 88).
- ➔ Select the correct source using the INPUT SELECT button, or select a channel of any TV program using the CH +/- buttons.

TV program pictures are distorted.

- ➔ Reorient the TV antenna.
- ➔ Adjust the picture (see the TV’s instruction manual).
- ➔ Place the recorder and TV farther apart.
- ➔ Place the TV and any bunched antenna cables farther apart.
- ➔ The RF cable is connected to the VHF/UHF OUT jack on the recorder. Connect the cable to the VHF/UHF IN jack.

The channel on the cable box/satellite receiver has been changed.

- ➔ The set top box controller is connected and “Set Top Box Control” is set to “On.” Check the “Set Top Box Control” settings in “Settings” setup (page 90).

TV channels cannot be changed.

- ➔ The channel is disabled (page 88).
- ➔ A timer recording started, which changed the channels.

The picture from equipment connected to the recorder’s input jack does not appear on the screen.

- ➔ If the equipment is connected to the LINE IN 1 jacks, select “L1” in the front panel display by pressing CH +/- or INPUT SELECT.
If the equipment is connected to the LINE 2 IN jacks, select “L2” in the front panel display by pressing CH +/- or INPUT SELECT.
If the equipment is connected to the LINE IN 3 jacks, select “L3” in the front panel display by pressing CH +/- or INPUT SELECT.
If the equipment is connected to the DV IN jack, (this is usually for a digital video camera connection), select “DV” in the front panel display by pressing CH +/- or INPUT SELECT.
- ➔ When the equipment is connected to the COMPONENT VIDEO IN jacks using a component video cord, set “Line1 Input” in “Video” setup to “Component” (page 93).
- ➔ When an S video cable is connected to the recorder’s LINE IN 1 or 3 jack, set “Line1 Input” or “Line3 Input” in “Video” setup to “S Video” (page 93).

The playback picture or TV program from the equipment connected through the recorder is distorted.

- ➔ If the playback picture output from a DVD player, VCR, or tuner goes through your recorder before reaching your TV, the copy-protection signal applied to some programs could affect picture quality. Disconnect the playback equipment in question and connect it directly to your TV.

The picture does not fill the screen.

- ➔ Set “TV Type” in “Video” setup in accordance with the screen size of your TV (page 91).

The picture does not fill the screen, even though the picture size is set in “TV Type” in “Video” setup.

- ➔ The picture size of the title is fixed.

TV Guide On Screen

TV Guide On Screen does not appear.

- ➔ ①Even if you complete “Easy Setup,” TV program listings do not appear until the recorder receives the TV Guide On Screen data. ②Turn off the recorder, but do not unplug it. ③Wait for 24 hours. It may take several days for the recorder to receive the TV Guide On Screen data for all channels. If the recorder does not receive the TV Guide On Screen data after 24 hours, select “Factory Setup” in “Options” setup and reset all of the recorder’s settings (page 99). Then run “Easy Setup” from “SETUP” in the System Menu (page 99).
- ➔ The area and/or zip code is incorrect. Correctly set your area of residence and zip code in “Area Setup” of “Settings” setup (page 89).
- ➔ When the recorder is connected to a cable box, the cable box must be turned on and “Set Top Box Control” in “Settings” setup must be set to “On” (page 90) to download the TV Guide On Screen data.
- ➔ The cable box brand code is incorrect (page 117).
- ➔ The TV Guide On Screen data may not be available in some areas.
- ➔ The “Time Lock” function on your cable box is activated. Set this function to off.

The channel number in the program listing does not match the broadcast station.

- ➔ There may be more than one channel lineup for your area. To change the channel lineup, select “Change channel lineup” from “SETUP” in the Service Bar of TV Guide On Screen (page 47).

Program listings for some channels are missing.

- ➔ It may take several days for the recorder to receive all of the TV Guide On Screen data.
- ➔ Some channels, such as satellite channels, are not displayed by the TV Guide On Screen system.
- ➔ All of the TV Guide On Screen data could not be received because the reception is poor.

The program listing is not up to date.

- ➔ The recorder was in use during the time that the TV Guide On Screen data was scheduled to be downloaded.
- ➔ All of the TV Guide On Screen data could not be received because the reception is poor.

Sound

There is no sound.

- ➔ Re-connect all connections securely.
- ➔ The connecting cord is damaged.
- ➔ The input source setting on the amplifier or the connection to the amplifier is incorrect.
- ➔ The recorder is in reverse play, fast-forward, slow motion, or pause mode.
- ➔ If the audio signal does not come through the DIGITAL OUT (OPTICAL or COAXIAL)/HDMI OUT jacks, check the “Audio Connection” settings in “Audio” setup (page 94).

No sound is output from the HDMI OUT jack.

- ➔ Try the following: ① Turn the recorder off and on again. ② Turn the connected equipment off and on again. ③ Disconnect and then connect the HDMI cord again.
- ➔ The HDMI OUT jack is connected to a DVI device (DVI jacks do not accept audio signals).
- ➔ The equipment connected to the HDMI OUT jack does not conform to the audio signal format, in this case set “Audio(HDMI)” of “Audio Connection” in “Audio” setup to “PCM” (page 95).

Sound distortion occurs.

- ➔ Set “Audio ATT” in “Audio” setup to “On” (page 93).

Sound is noisy.

- ➔ When playing a CD with DTS sound tracks, noise will come from the LINE OUT 1/2 R-AUDIO-L jacks (page 63).

The sound volume is low.

- ➔ The sound volume is low on some DVDs. The sound volume may improve if you set “Audio DRC” in “Audio” setup to “TV Mode” (page 94).
- ➔ Set “Audio ATT” in “Audio” setup to “Off” (page 93).
- ➔ One of the TVS effects is selected (page 61).

An alternate audio track cannot be recorded or played.

- ➔ Second Audio Program (SAP) is not available for all programs. The program you are recording does not have a second audio program.
- ➔ You have set “Tuner Audio” in “Options” settings to “Main” (page 98). Select “SAP” to record alternate audio programs.
- ➔ If you have connected an AV amplifier to the DIGITAL OUT (OPTICAL or COAXIAL) jack and want to change the audio track for a DVD-RW (VR mode) during playback, set “Dolby Digital” of “Audio Connection” in “Audio” setup to “D-PCM” (page 94).

Playback

The recorder does not play any type of disc (except HDD).

- ➔ The disc is upside down. Insert the disc with the labeled side facing up.
- ➔ The disc is not correctly inserted.
- ➔ Moisture has condensed inside the recorder. Remove the disc and leave the recorder turned on for about half an hour until the moisture evaporates.
- ➔ If the disc was recorded on another recorder, the recorder cannot play the disc if it was not finalized (page 40).

The recorder does not start playback from the beginning.

- ➔ Resume play was activated (page 62).
- ➔ You have inserted a DVD whose Title menu or DVD menu automatically appears on the TV screen when it is first inserted. Use the menu to start playback.

The recorder starts playing automatically.

- ➔ The DVD VIDEO features an auto playback function.

Playback stops automatically.

- ➔ If the DVD has an auto pause signal, the recorder stops playback at the auto pause signal.

Some functions such as Stop, Search, or Slow-motion Play cannot be performed.

- ➔ Depending on the DVD, you may not be able to do some of the operations above. See the instruction manual supplied with the disc.

The language for the sound track cannot be changed.

- ➔ Multilingual tracks are not recorded on the DVD being played.
- ➔ The DVD VIDEO prohibits the changing of the language for the sound track.
- ➔ Try changing the language using the DVD VIDEO's menu.

The subtitle language cannot be changed or turned off.

- ➔ Multilingual subtitles are not recorded on the DVD VIDEO.
- ➔ The DVD VIDEO prohibits changing of the subtitles.
- ➔ Try changing the subtitle using the DVD VIDEO's menu.
- ➔ The subtitles cannot be changed for the titles recorded on this recorder.

The angles cannot be changed.

- ➔ Multi-angles are not recorded on the DVD VIDEO being played.
- ➔ You are trying to change the angles when “” does not appear on the TV screen (page 61).
- ➔ The DVD VIDEO prohibits changing angles.
- ➔ Try changing the angle using the DVD VIDEO's menu.
- ➔ The angles cannot be changed for the titles recorded on this recorder.

The MP3 audio tracks do not play.

- ➔ The MP3 audio tracks are not recorded in a format that the recorder can play (page 70).

The JPEG image files do not play.

- ➔ The JPEG image files are not recorded in a format that the recorder can play (page 70).
- ➔ Progressive JPEG images cannot be played.

TV Pause does not work.

- ➔ You are recording to the HDD or the HDD is full.

Recording/Timer recording/ Editing

The channel cannot be changed from the channel you are recording.

- ➔ Set the TV's input source to “TV.”

Recording does not start immediately after you press ● REC.

- ➔ Operate the recorder only after “LOAD,” “FORMAT,” or “INFOWRITE” disappears from the front panel display.

Nothing was recorded even though you set the timer setting correctly.

- ➔ There was a power failure during recording.
- ➔ The recorder's internal clock stopped due to a power failure that lasted for more than 1 hour. Reset the clock (page 89).
- ➔ The channel was hidden after the timer recording was set. (See “Customizing the TV Guide On Screen System” on page 47.)
- ➔ Disconnect the AC power cord from an AC outlet, and connect it again.
- ➔ The program contains copy protection signals that restrict copying.
- ➔ The timer setting overlapped another setting that was set later.
- ➔ There is no DVD inside the recorder.
- ➔ There is not enough disc space for the recording.
- ➔ The set top box was turned off.
- ➔ The set top box controller was incorrectly connected (page 15).
- ➔ The settings in “Set Top Box Control” in “Settings” setup have been changed (page 90).
- ➔ A separate recording was in the process of being made without the use of the timer (page 56).
- ➔ The recorder was in the process of dubbing (HDD↔DVD).
- ➔ The recorder was in the process of DV/Digital8 Dubbing.

Recording does not stop immediately after you press ■ REC STOP.

- ➔ It will take a few seconds for the recorder to input disc data before recording can stop.

Recording does not stop after you press

■ STOP.

- ➔ Open the remote's cover and press ■ REC STOP.

Timer recording is not complete or did not start from the beginning.

- ➔ There was a power failure during recording. Should the power failure continue for more than 1 hour, reset the clock (page 89).
- ➔ Disc space was not enough.

Contents previously recorded were erased.

- ➔ Data that has been recorded on a DVD with a PC will be erased from the disc when the disc is inserted.
- ➔ "Auto Title Erase" in the "Features" setup is set to "On" (page 97).

Recording from the equipment with a timer

Nothing was recorded even though you set the Synchro-Recording setting correctly.

- ➔ You forgot to turn off the connected equipment. Turn off the connected equipment and set the recorder to Synchro-Recording standby mode (page 56).
- ➔ The recorder was not set to the Synchro-Recording standby mode. Press SYNCHRO REC to have the recorder stand by for recording. Make sure the SYNCHRO REC indicator lights up on the front panel (page 56).
- ➔ The recorder is connected to the TV output jack of the connected equipment.

Synchro-Recording does not complete.

- ➔ The timer setting for the connected equipment overlapped the recorder's timer setting (page 57).
- ➔ There was a power failure during the recording.

The recorder automatically starts recording when the satellite receiver is turned on.

- ➔ The Synchro Rec function was activated. Turn off the satellite receiver and cancel the Synchro Rec function (page 56).

Display

The clock has stopped.

- ➔ Set the clock again (page 89).
- ➔ The clock stopped due to a power failure that lasted for more than one hour. Reset the clock (page 89).

The clock is wrong.

- ➔ Set the clock again (page 89). If you cannot set the clock, wait until the clock data is received and the clock is automatically adjusted.

The TIMER REC indicator is flashing.

- ➔ The disc does not have enough space.
- ➔ Insert a recordable disc inside the recorder.

The recording mode indication is incorrect.

- ➔ When the recording or dubbing is less than three minutes, the recording mode indication may be displayed incorrectly. The actual recording itself is correctly made in the selected recording mode.
- ➔ After playing titles recorded in SLP and SEP mode, the recording mode indication may change depending on the recorded program.

The clock does not appear in the front panel display.

- ➔ "Dimmer" in "Options" setup is set to "Power Save" (page 98).

Remote control

The remote does not function.

- ➔ Batteries are weak.
- ➔ The remote is too far from the recorder.
- ➔ The remote's manufacturer code returned to the default setting when you replaced the batteries. Reset the code (page 22).
- ➔ Turn on the recorder.
- ➔ The remote is not pointed at the remote sensor on the recorder.
- ➔ Different command modes are set for the recorder and remote. Set the same command mode (page 24). The default command mode setting for this recorder and the supplied remote is DVD3.
- ➔ Set the TV/DVD switch to DVD (page 24).

Other Sony equipment responds to the remote.

- ➔ The same command mode is set for both the equipment and recorder. Set a different command mode for the recorder (page 24).

Others

The recorder does not operate properly.

- ➔ Restart the recorder. Press down **I/⏻** on the recorder for more than ten seconds until “WELCOME” appears in the front panel display.
- ➔ When static electricity, etc., causes the recorder to operate abnormally, turn off the recorder and wait until the clock appears in the front panel display. Then, unplug the recorder and after leaving it off for a while, plug it in again.

Five numbers or letters are displayed in the front panel display.

- ➔ The self-diagnosis function was activated (see the table on page 106).

The disc tray does not open after you press **⏻ OPEN/CLOSE**.

- ➔ It may take a few seconds for the disc tray to open after you have recorded or edited a DVD. This is because the recorder is adding disc data to the disc.

The disc tray does not open and “TRAY LOCKED” appears in the front panel display.

- ➔ Contact your Sony dealer or local authorized Sony service facility.

“RECOVERY” appears in the front panel display.

- ➔ The recorder’s recovery function was activated when the recorder was turned on because the power was turned off or failed during recording. Leave the recorder on until “RECOVERY” disappears from the front panel display.

“HDD ERROR” appears in the front panel display.

- ➔ The hard disk error occurred. Press down **I/⏻** on the recorder for ten seconds until “WELCOME” appears in the front panel display. If this does not resolve the problem, format the recorder’s HDD by pressing down the HDD button on the recorder for more than ten seconds until “FORMAT” appears in the front panel display. Note that all the contents recorded on the HDD will be erased. If this does not fix the problem, contact your nearest Sony dealer.

“FAN ERROR” appears in the front panel display.

- ➔ Check that the vent on the rear of the recorder is not blocked. Then, immediately disconnect the AC power cord. Leave the recorder off for a while, then re-connect the power cord, and press **I/⏻** on the recorder.

The disc tray does not open and you cannot remove the disc after you press **⏻ OPEN/CLOSE**.

- ➔ Turn off the recorder. Once the clock appears in the front panel display, disconnect the power cord. Connect it again while pressing down **⏻** on the recorder, and release the button when the disc tray opens. Then, keep **I/⏻** on the recorder pressed for about ten seconds until “WELCOME” appears in the front panel display.

“LOCKED” appears in the front panel display.

- ➔ The disc tray is locked. Cancel the Child Lock (page 63).

Self-diagnosis Function (When letters/numbers appear in the display)

When the self-diagnosis function is activated to prevent the recorder from malfunctioning, a five-character service number (e.g., C 13 00) with a combination of a letter and four numbers appears in the front panel display. In this case, check the following table.

First three characters of the service number	Cause and/or corrective action
C 13	There is a problem in the HDD. ➔ Contact your nearest Sony dealer or local authorized service facility. The DVD is dirty. ➔ Clean the disc with a soft cloth.
C 31	The DVD/CD is not inserted correctly. ➔ Re-insert the disc correctly.
E XX (xx is a number)	To prevent a malfunction, the recorder has performed the self-diagnosis function. ➔ Contact your nearest Sony dealer or local authorized Sony service facility and give the five-character service number. Example: E 61 10

Notes About This Recorder

On operation

- If the recorder is brought directly from a cold to a warm location, or is placed in a very damp room, moisture may condense on the lenses inside the recorder. Should this occur, the recorder may not operate properly. In this case, remove the disc and leave the recorder turned on for about half an hour until the moisture evaporates.
- When you move the recorder, take out any discs. If you don't, the disc may be damaged.

On adjusting volume

Do not turn up the volume while listening to a section with very low level inputs or no audio signals. If you do, the speakers may be damaged when a peak level section is played.

On cleaning

Clean the cabinet, panel, and controls with a soft cloth slightly moistened with a mild detergent solution. Do not use any type of abrasive pad, scouring powder or solvent such as alcohol or benzene.

About repairing the hard disk drive

- It may be necessary to access data stored on the hard disk for testing purposes; there is no intention to copy or store the data, titles or any other information.
- If replacement or initialization (format) is required, the hard disk will be formatted at our discretion. In this case, please note that all of the contents recorded there will be erased (including any data found to violate copyright law).

On cleaning discs

Do not use a commercially available cleaning disc. It may cause a malfunction.

Notes about the discs

- To keep the disc clean, handle the disc by its edge. Do not touch the surface. Dust, fingerprints, or scratches on the disc may cause it to malfunction.



- Do not expose the disc to direct sunlight or heat sources such as hot air ducts, or leave it in a car parked in direct sunlight as the temperature may rise considerably inside the car.
- After playing, store the disc in its case.
- Clean the disc with a cleaning cloth. Wipe the disc from the center out.



- Do not use solvents such as benzine, thinner, commercially available disc/lens cleaners, or anti static spray intended for vinyl LPs.
- Do not use the following discs.
 - A disc that has a non-standard shape (e.g., card, heart).
 - A disc with a label or sticker on it.
 - A disc that has cellophane tape or sticker adhesive on it.

Specifications

System

Laser: Semiconductor laser

Channel coverage:

NTSC

VHF: 2 to 13/UHF: 14 to 69/CATV: A-8 to A-1, A to W, W+1 to W+84

Video reception: Frequency synthesizer system

Audio reception: Split carrier system

Antenna: 75-ohm antenna terminal for VHF/UHF

Timer: Clock: Quartz locked/Timer indication: 12-hour cycle (digital)/Power back-up duration: 1 hour

Video recording format: MPEG Video

Audio recording format/applicable bit rate: Dolby Digital 2 ch/256 kbps

Inputs and outputs

LINE OUT 1/2

(AUDIO): Phono jack/2 Vrms/10 kilohms

(VIDEO): Phono jack/1.0 Vp-p

(S VIDEO): 4-pin mini DIN/Y: 1.0 Vp-p, C: 0.286 Vp-p

LINE IN 1/2/3

(AUDIO): Phono jack/2 Vrms/more than 22 kilohms

(VIDEO): Phono jack/1.0 Vp-p

(S VIDEO): 4-pin mini DIN/Y: 1.0 Vp-p, C: 0.286 Vp-p

DV IN: 4-pin/i.LINK S100

DIGITAL OUT (OPTICAL): Optical output jack/–18 dBm (wave length: 660 nm)

DIGITAL OUT (COAXIAL): Phono jack/0.5 Vp-p/75 ohms

COMPONENT VIDEO OUT (Y, P_B, P_R):

Phono jack/Y: 1.0 Vp-p/P_B, P_R:
interlace*=0.648 Vp-p, progressive or
interlace**=0.7 Vp-p

COMPONENT VIDEO IN (Y, P_B, P_R):

Phono jack/Y: 1.0 Vp-p/P_B, P_R:
interlace*=0.648 Vp-p, progressive or
interlace**=0.7 Vp-p

* “Y/Pb/Pr Out Black Level” is “On”

** “Y/Pb/Pr Out Black Level” is “Off”

SET TOP BOX CONTROL:

Mini jack

HDMI OUT:

Type A (19-pin)

General

Power requirements: 120 V AC, 60 Hz

Power consumption: 57 W

Dimensions (approx.): 430 × 75 × 328 mm
(17 × 3 × 13 in.) (width/height/depth) incl.
projecting parts

Hard disk drive capacity: 160 GB

Mass (approx.): 5.3 kg (11.68 lb)

Operating temperature:

5°C to 35°C (41°F to 95°F)

Operating humidity: 25% to 80%

Supplied accessories:

Audio/video cord (1)

Power cord (1)

Antenna cable (1)

Set top box controller (1)

Remote commander (remote) (1)

Size AA (R6) batteries (2)

Specifications and design are subject to change
without notice.

About i.LINK

The DV IN jack on this recorder is an i.LINK-compliant DV IN jack. This section describes the i.LINK standard and its features.

What is i.LINK?

i.LINK is a digital serial interface for handling digital video, digital audio and other data in two directions between equipment having the i.LINK jack, and for controlling other equipment.

i.LINK-compatible equipment can be connected by a single i.LINK cable. Possible applications are operations and data transactions with various digital AV equipment. When two or more i.LINK-compatible equipment are connected to this recorder in a daisy chain, operations and data transactions are possible with not only the equipment that this recorder is connected to but also with other devices via the directly connected equipment.

Note, however, that the method of operation sometimes varies according to the characteristics and specifications of the equipment to be connected, and that operations and data transactions are sometimes not possible on some connected equipment.

Note

Normally, only one piece of equipment can be connected to this recorder by the i.LINK cable (DV connecting cable). When connecting this recorder to i.LINK-compatible equipment having two or more i.LINK jacks (DV jacks), see the instruction manual of the equipment to be connected.

About the name “i.LINK”

i.LINK is a more familiar term for IEEE 1394 data transport bus proposed by SONY, and is a trademark approved by many corporations. IEEE 1394 is an international standard standardized by the Institute of Electrical and Electronics Engineers.

i.LINK baud rate

i.LINK's maximum baud rate varies according to the equipment. Three maximum baud rates are defined:

S100 (approx. 100 Mbps*)

S200 (approx. 200 Mbps)

S400 (approx. 400 Mbps)

The baud rate is listed under "Specifications" in the instruction manual of each equipment. It is also indicated near the i.LINK jack on some equipment.

The maximum baud rate of equipment on which it is not indicated such as this unit is "S100."

When units are connected to equipment having a different maximum baud rate, the baud rate sometimes differs from the indicated baud rate.

* What is Mbps?

Mbps stands for megabits per second, or the amount of data that can be sent or received in one second. For example, a baud rate of 100 Mbps means that 100 megabits of data can be sent in one second.

i.LINK functions on this recorder

For details on how to dub when this recorder is connected to other video equipment having DV jacks, see page 84.

The DV jack on this recorder can only input DVC-SD signals. It cannot output signals. The DV jack will not accept MICRO MV signals from equipment such as a MICRO MV digital video camera with an i.LINK jack.

For further precautions, see the notes on page 84.

For details on precautions when connecting this recorder, also see the instruction manuals for the equipment to be connected.

Required i.LINK cable

Use the Sony i.LINK 4-pin-to-4-pin cable (during DV dubbing).

i.LINK and  are trademarks.

Guide to Parts and Controls

For more information, see the pages in parentheses.

Remote

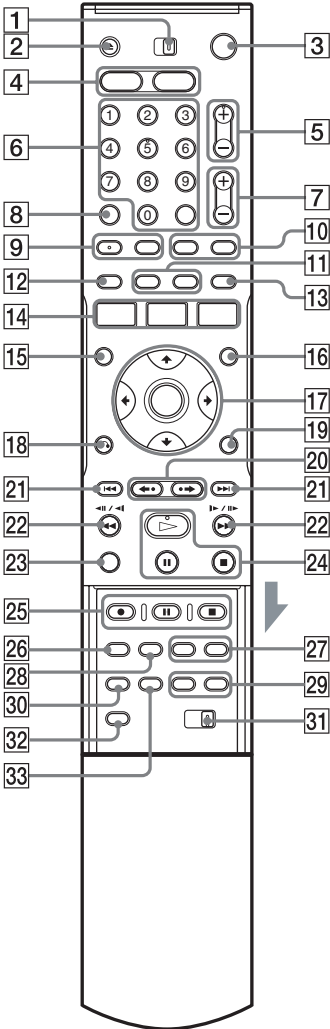

- 1** TV/DVD switch (22)
- 2** ▲ OPEN/CLOSE button (31)
- 3** I/⏻ (on/standby) button (25)
- 4** HDD button (33)
DVD button (31)
- 5** CH (channel) +/- buttons (33)
PAGE +/- buttons (44)
The + button has a tactile dot*.
- 6** Number buttons (52, 67)
SET button (67)
The number 5 button has a tactile dot*.
- 7** VOL (volume) +/- buttons (22)
- 8** CLEAR button (67)
- 9** AUDIO button (61)
SUBTITLE button (61)
The AUDIO button has a tactile dot*.
- 10** INPUT SELECT button (56, 84)
TV/VIDEO button (22)
- 11** SCHEDULE button (55)
DISPLAY button (36)
- 12** [TIMER] button (52)
- 13** ⓘ (info) button (43, 47)
- 14** SYSTEM MENU button (86, 88)
TITLE LIST button (34, 59, 68, 73)
TV GUIDE button (42)
- 15** TOP MENU button (63)
- 16** MENU button (44, 63)
- 17** ←/↑/↓/→/ENTER button (25)
- 18** ↻ RETURN button (25)
EXIT button (44)
- 19** TOOLS button (31)
- 20** ◀◀ REPLAY (instant replay)/ADVANCE (instant advance) ▶▶ buttons (34, 68)
- 21** ◀◀ PREV (previous)/NEXT ▶▶ buttons (61)

- 22** ◀◀◀◀||◀|/▶||▶▶▶▶ (search) buttons (61)
- 23** VISUAL SEARCH button (67)
- 24** ▷ PLAY button (59)
■ PAUSE button (61)
■ STOP button (59)
The ▷ PLAY button has a tactile dot*.
- 25** ● REC button (33)
■ REC PAUSE button (33)
■ REC STOP button (33)
- 26** REC MODE button (33)
- 27** CHAPTER MARK/CHAPTER MARK ERASE buttons (76)
- 28** SYNCHRO REC button (56)
- 29** ANGLE button (61)
SUR (surround) button (61)
- 30** WIDE MODE button (22)
- 31** COMMAND MODE switch (DVD 1,2,3) (24)
- 32** PROGRESSIVE button (19)
- 33** TIME/TEXT button (37)

* Use the tactile dot as a reference when operating the recorder.

Front panel

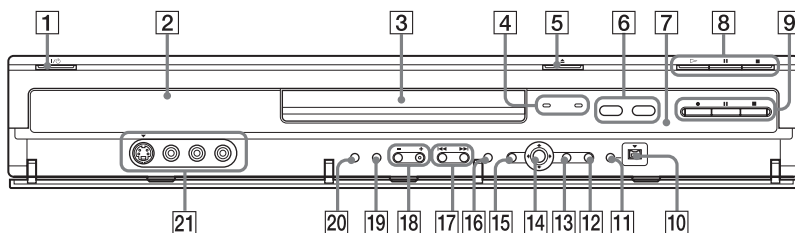

- | | |
|--|---|
| <p>1 I/⏻ (on/standby) button (25)</p> <p>2 Front panel display (37, 113)</p> <p>3 Disc tray (31)</p> <p>4 TIMER REC indicator (50)
SYNCHRO REC indicator (56)</p> <p>5 ≡ (open/close) button (31)</p> <p>6 HDD button/indicator (33)
DVD button/indicator (31)</p> <p>7 📺 (remote sensor) (22)</p> <p>8 ▷ (play) button (59)
⏸ (pause) button (61)
■ (stop) button (59)</p> <p>9 ● REC button (33)
⏸ REC PAUSE button (33)
■ REC STOP button (33)</p> | <p>10 📺 DV IN jack (84)</p> <p>11 ONE-TOUCH DUB button (85)</p> <p>12 SYSTEM MENU button (86, 88)</p> <p>13 TOOLS button (31)</p> <p>14 ⬅/⬆/⬇/➡/ENTER button (25)</p> <p>15 ↶ RETURN button (25)</p> <p>16 TV GUIDE button (42)</p> <p>17 ⏮/⏭ (previous/next) buttons (61)</p> <p>18 CHANNEL +/- buttons (33)
The + button has a tactile dot*.</p> <p>19 INPUT SELECT button (56, 84)</p> <p>20 REC MODE button (33)</p> <p>21 LINE 2 IN (S VIDEO/VIDEO/L(MONO)
AUDIO R) jacks (29)</p> |
|--|---|

* Use the tactile dot as a reference when operating the recorder.

Front panel display

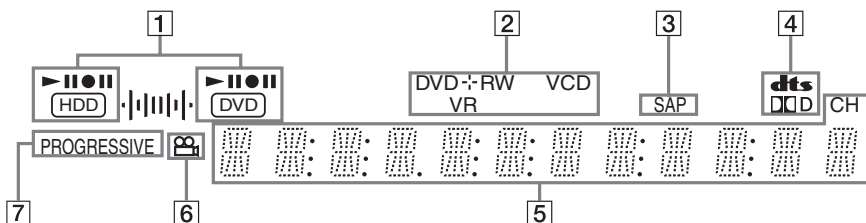

- 1** HDD/DVD indicators
Displays the selected media and the playing/recording/dubbing status.
- 2** Disc type*/recording format
- 3** SAP (Second Audio Program) indicator (50)
- 4** Audio signal indicators (36)
- 5** Displays the following (37):
 - Playing time/remaining time
 - Current title/chapter/track/index number
 - Recording time/recording mode
 - Clock
 - Channel
- 6**  (angle) indicator (61)
- 7** PROGRESSIVE indicator (19)

* Displays DATA CDs as “CD.”

Hint

You can turn off the front panel display when the recorder is turned off by setting “Dimmer” to “Power Save” in “Options” setup (page 98).

Rear panel

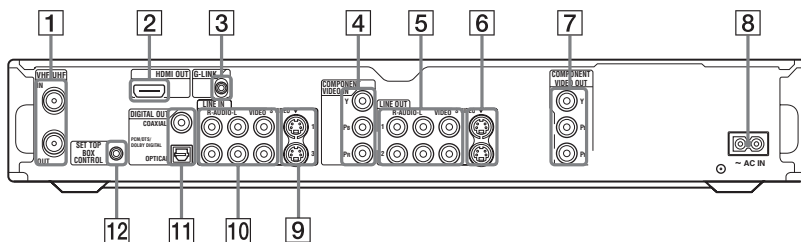

- 1** VHF/UHF IN/OUT jacks (16, 17)
- 2** HDMI OUT (high-definition multimedia interface out) jack (18)
- 3** G-LINK jack (for service use only)
- 4** COMPONENT VIDEO IN (Y, Pb, Pr) jacks (15)
- 5** LINE OUT 1/2 (R-AUDIO-L/VIDEO) jacks (18, 20)
- 6** LINE OUT 1/2 (S VIDEO) jack (18)
- 7** COMPONENT VIDEO OUT (Y, Pb, Pr) jacks (18)
- 8** AC IN terminal (21)
- 9** LINE IN 1/3 (S VIDEO) jack (28)
- 10** LINE IN 1/3 (R-AUDIO-L/VIDEO) jacks (28)
- 11** DIGITAL OUT (COAXIAL/OPTICAL) jacks (20)
- 12** SET TOP BOX CONTROL jack (15, 16)

Glossary

Chapter (page 67)

Sections of a picture or a music feature that are smaller than titles. A title is composed of several chapters. Depending on the disc, no chapters may be recorded.

Copy protection signals (page 50)

Copy restriction set by copyright owners, etc. These signals are included in some software or TV programs and restrict recording on this recorder.

Dolby Digital (page 94)

Digital audio compression technology developed by Dolby Laboratories. This technology conforms to multi-channel surround sound. The rear channel is stereo and there is a discrete subwoofer channel in this format. Dolby Digital provides the same discrete channels of high quality digital audio found in "Dolby Digital" theater surround sound systems.

Good channel separation is realized because all of the channel data is recorded discretely, and little deterioration occurs because all channel data processing is digital.

DTS (page 95)

Digital audio compression technology by Digital Theater Systems, Inc. This technology conforms to multi-channel surround sound. The rear channel is stereo and there is a discrete subwoofer channel in this format. DTS provides the same discrete channels of high quality digital audio.

Good channel separation is realized because all of the channel data is recorded discretely, and little deterioration occurs because all channel data processing is digital.

DVD+R (page 10)

A DVD+R (read "plus R") is a recordable disc that is the same size as a DVD VIDEO. Contents can be recorded only once to a DVD+R, and will have the same format as a DVD VIDEO.

DVD+RW (page 10)

A DVD+RW (read "plus RW") is a recordable and rewritable disc. DVD+RWs use a recording format that is comparable to the DVD VIDEO format.

DVD-R (page 10)

A DVD-R is a recordable disc that is the same size as a DVD VIDEO. Contents can be recorded only once to a DVD-R, and will have the same format as a DVD VIDEO.

DVD-RW (page 10)

A DVD-RW is a recordable and rewritable disc that is the same size as a DVD VIDEO. The DVD-RW has two different modes: VR mode and Video mode. DVDs created in Video mode have the same format as a DVD VIDEO, while discs created in VR (Video Recording) mode allow the contents to be programmed or edited.

DVD VIDEO (page 12)

A disc that contains up to eight hours of moving pictures on a disc the same diameter as a CD. The data capacity of a single-layer and single-sided DVD is 4.7 GB (Giga Byte), which is 7 times that of a CD. The data capacity of a double-layer and single-sided DVD is 8.5 GB, a single-layer and double-sided DVD is 9.4 GB, and double-layer and double-sided DVD is 17 GB. The picture data uses the MPEG 2 format, which is a worldwide standard of digital compression technology. The picture data is compressed to about 1/40 (average) of its original size. The DVD also uses a variable rate coding technology that changes the data to be allocated according to the status of the picture. Audio information is recorded in a multi-channel format, such as Dolby Digital, allowing you to enjoy a more real audio presence.

Furthermore, various advanced functions such as the multi-angle, multilingual, and Parental Control functions are provided on the DVD.

Hard disk drive (page 3)

A hard disk drive is a whole mechanical system that consists of discs and drive. Discs are flat, circular, rigid plates coated with a thin magnetic media. Magnetic heads record data on the rapidly spinning discs, and this enables the speedy and efficient reading and writing of data.

HDMI (High-Definition Multimedia Interface) (page 20)

HDMI is an interface that supports both video and audio on a single digital connection. The HDMI connection carries standard to high definition video signals and multi-channel audio signals to AV components such as HDMI equipped TVs, in digital form without degradation.

The HDMI specification supports HDCP (High-bandwidth Digital Contents Protection), a copy protection technology that incorporates coding technology for digital video signals.

Interlace format (page 19)

Interlace format shows every other line of an image as a single “field” and is the standard method for displaying images on television. The even number field shows the even numbered lines of an image, and the odd numbered field shows the odd numbered lines of an image.

Original (page 72)

Titles actually recorded on a HDD/DVD-RW (VR mode). Erasing original titles frees up disc space.

Playlist (page 72)

Playback information created from the actual recordings on a HDD/DVD-RW (VR mode). A Playlist leaves the original titles as they are, and contains only the information needed to control playback. A Playlist title takes up very little disc space.

Progressive format (page 19)

Compared to the Interlace format that alternately shows every other line of an image (field) to create one frame, the Progressive format shows the entire image at once as a single frame. This means that while the Interlace format can show 30 frames/60 fields in one second, the Progressive format can show 60 frames in one second. The overall picture quality increases and still images, text, and horizontal lines appear sharper.

Title (page 67)

The longest section of a picture or music feature on a DVD, movie, etc., in video software, or the entire album in audio software.

Track (page 67)

Sections of a music feature on a CD/VIDEO CD (the length of a song).

Language Code List

For details, see page 90.

The language spellings conform to the ISO 639: 1988 (E/F) standard.

Code Language	Code Language	Code Language	Code Language
1027 Afar	1183 Irish	1347 Maori	1507 Samoan
1028 Abkhazian	1186 Scots Gaelic	1349 Macedonian	1508 Shona
1032 Afrikaans	1194 Galician	1350 Malayalam	1509 Somali
1039 Amharic	1196 Guarani	1352 Mongolian	1511 Albanian
1044 Arabic	1203 Gujarati	1353 Moldavian	1512 Serbian
1045 Assamese	1209 Hausa	1356 Marathi	1513 Siswati
1051 Aymara	1217 Hindi	1357 Malay	1514 Sesotho
1052 Azerbaijani	1226 Croatian	1358 Maltese	1515 Sundanese
1053 Bashkir	1229 Hungarian	1363 Burmese	1516 Swedish
1057 Byelorussian	1233 Armenian	1365 Nauru	1517 Swahili
1059 Bulgarian	1235 Interlingua	1369 Nepali	1521 Tamil
1060 Bihari	1239 Interlingue	1376 Dutch	1525 Telugu
1061 Bislama	1245 Inupiak	1379 Norwegian	1527 Tajik
1066 Bengali;	1248 Indonesian	1393 Occitan	1528 Thai
Bangla	1253 Icelandic	1403 (Afan)Oromo	1529 Tigrinya
1067 Tibetan	1254 Italian	1408 Oriya	1531 Turkmen
1070 Breton	1257 Hebrew	1417 Punjabi	1532 Tagalog
1079 Catalan	1261 Japanese	1428 Polish	1534 Setswana
1093 Corsican	1269 Yiddish	1435 Pashto;	1535 Tonga
1097 Czech	1283 Javanese	Pushto	1538 Turkish
1103 Welsh	1287 Georgian	1436 Portuguese	1539 Tsonga
1105 Danish	1297 Kazakh	1463 Quechua	1540 Tatar
1109 German	1298 Greenlandic	1481 Rhaeto-	1543 Twi
1130 Bhutani	1299 Cambodian	Romance	1557 Ukrainian
1142 Greek	1300 Kannada	1482 Kirundi	1564 Urdu
1144 English	1301 Korean	1483 Romanian	1572 Uzbek
1145 Esperanto	1305 Kashmiri	1489 Russian	1581 Vietnamese
1149 Spanish	1307 Kurdish	1491 Kinyarwanda	1587 Volapük
1150 Estonian	1311 Kirghiz	1495 Sanskrit	1613 Wolof
1151 Basque	1313 Latin	1498 Sindhi	1632 Xhosa
1157 Persian	1326 Lingala	1501 Sangho	1665 Yoruba
1165 Finnish	1327 Laothian	1502 Serbo-	1684 Chinese
1166 Fiji	1332 Lithuanian	Croatian	1697 Zulu
1171 Faroese	1334 Latvian;	1503 Singhalese	
1174 French	Lettish	1505 Slovak	
1181 Frisian	1345 Malagasy	1506 Slovenian	1703 Not specified

Area Code

For details, see page 96.

Code Area	Code Area	Code Area	Code Area
2044 Argentina	2165 Finland	2362 Mexico	2149 Spain
2047 Australia	2174 France	2376 Netherlands	2499 Sweden
2046 Austria	2109 Germany	2390 New Zealand	2086 Switzerland
2057 Belgium	2248 India	2379 Norway	2528 Thailand
2070 Brazil	2238 Indonesia	2427 Pakistan	2184 United
2079 Canada	2254 Italy	2424 Philippines	Kingdom
2090 Chile	2276 Japan	2436 Portugal	
2092 China	2304 Korea	2489 Russia	
2115 Denmark	2363 Malaysia	2501 Singapore	

Cable Box/Satellite Receiver Brand Code

If more than one code number is listed, try entering them one at a time until you find the one that works with your cable box/satellite receiver. Note that TV Guide On Screen data cannot be received through a satellite receiver.

Cable box brand	Code number
3M	0033
ABC	0003, 0011, 0017, 0008, 0014, 0001, 0013, 0206, 0047, 0237, 0033
Accuphase	0003, 0013, 0047, 0001, 0011, 0017, 0014, 0206
Acorn	1102, 0237
Action	0237
Active	0237, 1102
Aim	0015
Allegro	0315, 0153
Amark	0008, 0277, 0144, 0056
American	0060
Americast	0899
Antronix	0207, 0022
Anvision	0211, 0111
Apache	0770
Arbatron	0014, 0011, 0003, 0476
Archer	0153, 0022, 0207, 0039, 0797, 0237, 0260
ASE	1080
Auna	1269
BBT	0267
BCC	0276
Belcor	0056, 0022
Bell & Howell	0014
Bell Atlantic	0641
Bell South	0899
Bestlink	0303
Betavue	0022
British Telecom	0003

Cable box brand	Code number
BVS	0641
Cable Healthcare	0769, 0058
Cable Star	0056
Cabletenna	0022, 0039
Cableview	0022
Century	0153, 0618, 0008, 0315
Citation	0017
Citizen	0153, 0315, 0078, 0242
Clearmaster	0883
ClearMax	0883, 1247
Colour Voice	0031, 0025
Comband	0233, 0232
Comtec	0274
Comtronics	0060, 0040
Comtronics Eagle	0040, 0060
Contec	0019
Coolmax	0883
Curtis Mathes	0015, 0242
Dae Ryung Eagle	0008
Daeryung	0008, 0877, 0477, 0277, 1877
Diamond	0035
Digeo	1476
Digi	0637
Director	0476
Dumont	0637
Eagle Comtronics	0060, 0028
Eastern	0002, 0274, 0418
Electricord	0078
Emerson	0797, 0303, 0015, 0014
Everquest	0040, 0015
Focus	0400
Fosgate	0276
Funai	0248, 0019
FutureVision	0649
Garrard	0153
Gateway	0764

Cable box brand	Code number
GC Electronics	0207, 0056, 0330, 0016, 0040, 0077, 0030
GE	0232, 0233, 0144, 0021
Gemini	0015, 0070, 0057, 0242, 0014, 0797, 0013, 0400
General Instrument	0476, 0011, 0014, 0098, 0810, 0024, 0003, 0015, 0276
GHZ	0078
Gibraltar	0003
Global	1327
GMI	0069, 0057, 0015, 0797
GoldStar	0144, 0040
Goodmind	0770, 0797
Gradiente	1136
Hamlin	0020, 0009, 0034, 0259, 0015, 0273, 0206
Healthway Interactive	0058, 1020, 1015, 0769
Hitachi	0011, 0154, 0009, 0008, 0003, 0033, 0014, 0255
Houston Tracker	0011
Hwalin	0303
IBM	0670
IIEC	1018
Interbuy	0274
Jasco	0315, 0153, 0015
Jebsee	0014, 0400
Jerrold	0003, 0014, 0276, 0011, 0012, 0020, 0024, 0015, 0047, 0098, 0476, 0031, 0029, 0111, 0032, 0054, 0810, 0028
Kuang Yu	0024
Leon	0069, 0015
LG	0040, 0144
Linsay	0440
Macom	0033
Maestro	0812
Magnavox	0797, 0027, 0032, 0334, 0069
Millennium	0618, 0153

Cable box brand	Code number
Memorex	0000
Mitsubishi	0003
Motorola	0476, 0276, 1476, 0810, 1376, 1254, 0400, 1106
Movie Time	0156, 0078, 0063, 0203
MS	0069, 0015, 1018, 0303
MultiVision	0012
Myrio	1117
NET	0274
Next Level	0764, 1316, 1315, 1314
Nexus	0770
Northcoast	0671, 0314
Nova Vision	0277, 0008
Novabeam	0277
Novaplex	0618, 0277, 0017, 0008
NSC	0156, 0070, 0203, 0063, 0400, 0012, 0618, 0022, 0637, 0010, 0044
Oak	0019, 0303, 0248, 0017
Omega	0015
Omniview	0371
Optimus	0021
Pace	0008, 0237, 0277, 0477, 0877, 1877
Pacific Bell	0843
Panasonic	0107, 0021, 0144, 0008, 0124, 0307, 0000, 0040
Panther	0637
Paragon	0000, 0525, 0008
Penney	0637, 0000
Philips	0025, 0031, 0290, 0027, 0030, 0153, 0060, 0242, 0028, 0334, 0211, 0029, 0259, 0307, 0652, 0013, 0069, 0649, 0255, 0305, 0032, 0111, 0317
Pioneer	0144, 0023, 0533, 1877, 0877, 0260
Popular Mechanics	0400
Prelude	0770
Prism	0012, 0013, 0059

Cable box brand	Code number
Protelcon	0786
Pulsar	0000, 0040
Quasar	0000
Quest	0144, 0020
R Line	0040
RadioShack	0883, 0015, 0315, 0303, 0797
Rampage	0255
Ranger	1247
RCA	0021, 0060, 0797, 0047, 1256, 0843
Realistic	0207, 0153
Recoton	0153, 0400
Regal	0259, 0020, 0273, 0279, 0276
Regency	0002, 0020, 0682
Rembrandt	0070, 0153, 0040, 0022, 0011
RK	0304, 0479
Runco	0000
Samsung	0040, 0144, 0023, 0003, 0070, 0000
Sasktel	1737
Scientific Atlanta	0008, 0277, 0017, 0006, 0237, 0025, 0477, 0207, 0877, 0003, 0012, 0000, 0021, 1877
Seam	0510
Sears	0510
Sejin	1265
Sigma	0019
Signal	0040, 0015, 0011, 0035
Signature	0011
SkyCable	0112
Skygiant	1091
SL Marx	0040
Sony	1006, 1506, 1606
Spectradyne	0769, 0058
Spectravision	0058
Sprucer	0021, 0307, 0010, 0144

Cable box brand	Code number
Standard Components	0203, 0096, 0155
Starcom	0003, 0015, 0047, 0014, 0098, 0305
Stargate	0015, 0040, 0770, 0865, 0797, 0305, 0014
Starquest	0015
StarSight	0542, 0422
Stealth	0274
Stellar One	0807
Storm	1018, 0637
Suena Madritel	1230
Supercable	0276
Supermax	0883
Sylvania	0001
Tandy	0258
Tatung	0097
Teac	1018
Technics	0029
Teknika	0146
Teleavia	0040
TeleCaption	0221
Teleview	0063, 0040
Texscan	0001, 0096, 0010
TFC	0310
Thomson	1256
Timeless	0418, 0274, 0040
Tocom	0012, 0013, 0029, 0019, 0059, 0017
Torx	0003
Toshiba	0000
Trans PX	0303, 0276, 0153, 0315
Trinity	1248
Tristar	0883
TS	0255, 0024, 1018, 0003, 0303
Tusa	0015
TV COMM	0035, 0019
TV Guide	1476
TV86	0063, 0040

Cable box brand	Code number
Uniden	0022
Unika	0207, 0153, 0022
United Cable	0003, 0014, 0011, 0276
Universal	0191, 0078, 0207, 0056, 0022, 0039, 0153, 0077, 0322, 0315
US Electronics	0276, 0008, 0003, 0017
V2	0883
Videoway	0250, 0000
VideoWorks	0124
Vidtech	0244
Viewmaster	0883, 0770
Viewstar	0258, 0289, 0060, 0063, 0211, 0027, 0111, 0030, 0121
Vision	0883
Visionetics	1264
Vortex View	0883
WaveMaster	0565
Wiso	0078
Zenith	0000, 0525, 0054, 0017, 0039, 0153, 0060, 0315, 0191, 0899
Zentek	0400

Satellite receiver brand	Code number
AlphaStar	0772
Atlantic Telephone	1333
Bell ExpressVu	0775
Century	0856
Chaparral	0216
Crossdigital	1109
DirecTV	0749, 0566, 0392, 1749, 0099, 1109, 1076, 1442, 1856, 0247, 1142, 1639, 0724, 0639, 0819
Dish Network System	0775, 1005, 1170
Dishpro	0775, 1005
Echostar	0775, 1170, 1005
Expressvu	0775
Galaxis	0863
GE	0566
General Instrument	0361, 0869, 0627
GOI	0775
Gradiente	0856
Hitachi	0819, 0749
Houston Tracker	0775
HTS	0775
Hughes Network Systems	0749, 1749, 1442, 1142
Humax	1176, 1359, 1048, 0863, 0283
Innova	0099
Jerrold	0361, 0036, 0627
JVC	0775, 1170
Magnavox	0722, 0724
McIntosh	0869
Memorex	0724
Mitsubishi	0749
Motorola	0869
NEC	1270
Netsat	0099
Next Level	0869
Optimus	0724
Panasonic	0247, 0701

Satellite receiver brand	Code number
Paysat	0724
Philips	1076, 0099, 1142, 0724, 0722, 0749, 1442, 1749, 0856, 0775
Primestar	0361, 0627, 0869
Proscan	0392, 0566
QNS	1367
RadioShack	0869
RCA	0566, 0392, 0143, 0855
Samsung	1109, 1276
Sky	0856, 0099, 1856
Sony	0639, 1639
Star Choice	0869
Star Trak	0869, 0772
Thomson	0566, 0392
Tivo	1142, 1442
Toshiba	0790, 0749, 1749, 1285
UEC	1333, 1358
Uniden	0724, 0722
Video Cipher II Plus	0361
Zenith	0856, 1856

Index

Words in quotations appear in the on-screen displays.

Numerics

- 16:9 26, 91
- 4:3 Letter Box 26, 91
- 4:3 Pan Scan 26, 91
- “48kHz/96kHz PCM” 95

A

- “A-B Erase” 74
- Adjusting
 - playback picture 63
 - playback sound 64
 - recording picture 53
- ADVANCE 35, 68
- “AFT” 89
- Album 37, 71
- Album number 37
- “Album Search” 67
- ANGLE 61
- Antenna 14
- Area code 116
- “Area Setup” 25, 89
- AUDIO 61
- “Audio” 90
- “Audio ATT” 93
- “Audio Connection” 26
- Audio cord 20
- “Audio DRC” 94
- “Audio Filter” 64
- “Audio” settings 93
- “Auto Chapter” 96
- “Auto Display” 98
- “Auto Stereo” 98
- “Auto Title Erase” 97
- “AV SYNC” 64

B

- Batteries 22
- “BNR” 63
- “Brand Code” 90
- “Brightness” 54, 64

C

- “C NR” 63
- Cable box 15, 16
- Cable box brand 117
- Cable box/satellite receiver brand code 117
- “Capture” 77
- “Capture All” 77
- CD 12
- “Ch. digit lock” 90
- “Change IN” 77, 87
- “Change Order” 78
- “Change OUT” 77, 87
- Chapter 37, 54, 76, 114
- CHAPTER MARK 76
- CHAPTER MARK ERASE 76
- Chapter number 37
- “Chapter Search” 67
- Chasing Playback 65
- Child Lock 63
- Cleaning discs 106
- CLEAR 67
- “Clock” 89
- “Color” 54, 64
- “Combine Titles” 78
- “Command Mode” 25, 98
- COMPONENT VIDEO IN 15, 28
- COMPONENT VIDEO OUT 18
- Connecting
 - the antenna cable 14
 - the audio cords 20
 - the video cords 18
- “Connection” 90
- “Contrast” 54, 64
- Controlling TVs with the remote 22
- Copy protection 50, 114
- Copy-Free 50
- Copy-Never 50
- Copy-Once 50
- CPRM 10
- Creating chapters 76

D

- DATA CD 12
- “Delete Chapter” 74
- “Digital Out” 94
- Digital video camera 84
- “Dimmer” 98
- “Disc Info” 31, 39, 40, 76
- “Disc Map” 76
- “Disc Name” 39
- Disc Settings 31, 39, 40, 76, 98
- Disc space 32
- Disc types 10
- Display
 - front panel display 37, 113
- “Divide Title” 75
- Dolby Digital 20, 94, 114
- “Downmix” 94
- DTS 63, 95, 114
- “Dub Mode” 79, 87
- Dubbing
 - “Dub Mode” 79
 - High-speed Dubbing 79
 - Rec Mode Conversion
 - Dubbing 80
 - “Settings” 83
- “DV/D8 Audio Input” 85
- “DV/D8 EDIT” 86
- DV IN 84
- DV/Digital8 Dubbing 84
 - One Touch Dubbing 85, 97
 - Program Edit 86
- “DVD Menu” 90
- “DVD Rec. Picture Size” 54
- DVD VIDEO 12, 114
- DVD+R 10, 114
- DVD+RW 10, 114
- DVD’s Menu 63
- DVD-R 10, 114
- DVD-RW 10, 114
- “DVE” 63

E

Easy Setup 25, 99
Editing 72
 DV Edit 84
Enter characters 38
“Erase” 73, 77, 87
“Erase All” 76
“Erase Titles” 75

F

“Factory Setup” 99
Fast forward 62
Fast reverse 62
“Features” 96
“File Search” 67
“Finalize” 41
“Finalize Disc” 97
Finalizing 40
“Format” 31
“Format DVD-RW” 98
Formatting 31
Freeze Frame 62
Front panel 112
Front panel display 37, 113

G

GB 32

H

Handling discs 107
Hard disk drive 3, 10, 115
“HDD Rec. Picture Size” 54
HDMI
 “Audio(HDMI)” 95
 “HDMI Resolution” 91
HDMI OUT 18
“HQ Setting” 97
“Hue” 54, 64

I

i.LINK 108
INPUT SELECT 57, 84
Interlace format 115

J

JPEG image files 68

L

Labeling 39
“Language” 90
Language code 116
LINE 2 IN 29
LINE IN 1/3 28
“Line1 Input” 93
“Line3 Input” 93
“LISTINGS” 43

M

MENU 63
Menu
 DVD’s Menu 63
 Top menu 63
“Mix” 85
“MNR” 63
“Mode for SET button” 90
“Move” 77, 87
MP3 audio tracks 68

N

NEXT 61
Number buttons 52, 67

O

One Touch Dubbing 85, 97
On-screen display
 Setup Display 88
 Sub-menu 35
 TOOLS menu 31
“Options” 98
Original 35, 72, 115
“OSD” language 25, 90

P

Page mode 35
Parental Control 63, 96
Parental control settings 96
Parts and controls 110
“Pause Mode” 91
“PB Video Equalizer” 64
PBC 63
“Play Beginning” 62
Play mode 37

Playable discs 12

Playback 59
 freeze frame 62
 JPEG image files 68
 MP3 audio tracks 68
 resume play 62
 scan audio 62
 slow-motion play 62
Playback picture quality 63
Playing status bar 37
Playlist 35, 72, 77, 115
Power cord 21
PREV 61
“Preview” 74, 77, 87
Program Edit 86
PROGRESSIVE 19, 61
Progressive format 115
“Progressive Mode” 92
“Protect Disc” 40
“Protect Title” 73

Q

Quick guide to disc types 10
Quick Timer 53

R

Rear panel 113
REC 33
“Rec Mode Adjust” 51, 97
“Rec Mode” 53
“Rec NR” 54
REC PAUSE 33
“Rec Settings” 53
REC STOP 33, 51, 57, 85
“Rec Video Equalizer” 54
Recordable discs 10
Recording 49, 56, 96
 picture adjustment 53
 recording format 10
 Synchro Rec 56
 while watching another
 program 33
Recording mode 34, 37, 49
Recording picture quality 53
Recording picture size 53
Recording time 34, 49
“RECORDINGS” 43
RECOVERY 105
Region code 13

Remaining time 37
Remote 22, 110
REPLAY 35, 68
Resetting 99
Resume Play 62

S

S VIDEO 18
SAP (Second Audio Program)
50
Satellite receiver 15
Scan Audio 62
Scene List 77
“SCHEDULE” 43
SCHEDULE 55
“Screen Saver” 97
“SEARCH” 43
“Search” 67
Searching
 scan audio 62
 search mode 67
 visual search 67
Self-diagnosis function 106
SET 67
“Set Thumbnail” 73
“Set Top Box Control” 90
SET TOP BOX CONTROL
jack 15, 16
Set top box controller 14, 27
“Settings” 88
“SETUP” 43
Setup Display 88
Simultaneous Rec and Play 66
Sort 35
Sound quality 64
Stereo 50

Stereo programs 50
“Stereo1” 85
“Stereo2” 85
STOP 59
Sub-menu 35
SUBTITLE 61
“Subtitle” 90
Super VIDEO CD 12
SUR (surround) 61
SYNCHRO REC 57
System menu 88

T

Thumbnail picture 36
“Time Search” 67
TIME/TEXT 37
TIMER 52
Timer recording
 check/change/cancel 55
 manual setting 52
 Rec Mode Adjust 53
 Synchro Rec 56
 TV GUIDE 50
Title 37, 115
TITLE LIST 59
Title List 34, 59
 Sort 35
 Thumbnail 36
“Title Name” 73
Title number 37
“Title Search” 67
TOOLS 31
TOP MENU 63
Track 115
Track number 37
“Track Search” 67

Troubleshooting 100
“Tuner Audio” 98
“Tuner Preset” 26, 88
TV GUIDE 42
TV Guide On Screen system
42, 50
TV Pause 65
“TV Type” 26, 91
TV/DVD switch 22
TV/VIDEO 33
TVS (TV Virtual Surround)
61

U

“Unfinalize” 41
Unfinalizing 41
Usable discs 10, 12

V

VIDEO CD 12
Video cord 18
Video input 18
Video mode 10
“Video” settings 91
Visual Search 67
VR mode 10, 72

W

WIDE MODE 23

Y

“Y NR” 63
“Y/Pb/Pr In Black Level” 92
“Y/Pb/Pr Out Black Level” 92



Printed on 100% recycled paper using
VOC (Volatile Organic Compound)-free
vegetable oil based ink.



* 1 - 2 6 3 5 8 9 2 1 1 5 *

2-635-892-11(1)

Free Manuals Download Website

<http://myh66.com>

<http://usermanuals.us>

<http://www.somanuals.com>

<http://www.4manuals.cc>

<http://www.manual-lib.com>

<http://www.404manual.com>

<http://www.luxmanual.com>

<http://aubethermostatmanual.com>

Golf course search by state

<http://golfingnear.com>

Email search by domain

<http://emailbydomain.com>

Auto manuals search

<http://auto.somanuals.com>

TV manuals search

<http://tv.somanuals.com>