

IC Recorder
ICD-PX440



Use this Help Guide when you have any questions on how to use your IC recorder.

[Go to Page Top](#)

 How to Use

[Preparation](#)

[Recording](#)

[Playback](#)

[Editing](#)

[Menu](#)

[Computer](#)

[Software](#)

1

[Specifications](#)

[Announcements](#)

[Go to Page Top](#)

 [Troubleshooting](#)

[IC recorder operations](#)

[Software operations \(Sound Organizer\)](#)

[Messages](#)

[System limitations](#)

[Go to Page Top](#)

 [List of Topics](#)

[How to Use](#)

[Troubleshooting](#)

[Go to Page Top](#)

[Notes on use](#)

4-534-070-11(1)

Copyright 2014 Sony Corporation

Table of Contents

How to Use.....	i
Preparation.....	1
Parts description.....	24
Parts and controls.....	73
Display window.....	25
Display when stopped.....	75
Display when recording.....	78
Display during playback.....	79
Display when the HOLD function is set.....	81
Display in the HOLD status.....	82
Display of the current file information.....	83
Display during FOLDER selection.....	84
Display of the file list.....	86
Display during MENU operation.....	87
Power.....	27
Inserting batteries.....	88
Disconnecting the IC recorder from your computer.....	89
Using a USB AC Adaptor.....	91
Disconnecting the IC recorder from the USB AC adaptor.....	92
Turning the power on.....	93
Turning the power off.....	94
Memory card.....	28
Inserting a memory card.....	95
Selecting the memory.....	97
Clock setting.....	29
Setting the clock.....	99
Setting the clock using the menu.....	101
Language setting.....	30
Setting the display language.....	103
Selecting items on the display.....	31
Selecting a folder and a file.....	104
Selecting a tab.....	106
HOLD.....	32
Preventing unintentional operations (HOLD).....	108
Releasing the HOLD function.....	110
AVLS (Automatic Volume Limiter System).....	33

About the AVLS function (European models only).....	111
Turning the AVLS function on or off.....	112
Recording.....	2
Recording.....	34
Recording sound from the built-in microphones.....	114
About the recording level guide.....	117
Monitoring sound while recording.....	118
Various operations while recording.....	119
Various operations/settings.....	35
Selecting a recording scene for each situation.....	121
Registering recording settings in “My Scene”	123
Tips for better recording.....	125
Default settings for the “Scene Select” menu	127
Adding a new segment to a previously recorded file.....	129
Adding an overwrite recording during playback.....	131
Starting to record automatically in response to sound – the VOR function.....	133
Recording via other devices.....	36
Recording with an external microphone.....	135
Recording from external equipment.....	137
Using external devices.....	37
Recording the playback sound of the IC recorder on external equipment.....	139
Playback.....	3
Playing.....	38
Playing back the recorded sound.....	140
Various operations while playing.....	142
Various operations/settings.....	39
Reducing noise in the playback sound and making the human voice clearer – the noise cut function	144
Adjusting the playback speed – the DPC (Digital Pitch Control) function.....	146
Playing back all files in a folder continuously - the continuous play.....	147
Playing back a file repeatedly.....	148
Playing back a specified section repeatedly (A-B repeat).....	149
Listening with better sound quality.....	150
Searching forward/backward during playback (Cue/Review).....	151
Searching the desired point quickly (Easy Search).....	152
Using a calendar.....	40

Selecting a recording date from the calendar and playing back.....	153
Setting an alarm.....	41
Playing back a file at a desired time with an alarm.....	155
Editing.....	4
Erasing files.....	42
Erasing a file.....	157
Erasing all files in a folder.....	159
Organizing files.....	43
Moving a file to a different folder.....	161
Copying a file to the other memory.....	163
Track marks.....	44
Adding a track mark.....	165
Erasing a track mark.....	167
Erasing all the track marks in the selected file at one time.....	169
Dividing files.....	45
Dividing a file at the current position.....	171
Dividing a file at all the track mark positions.....	173
Protecting files.....	46
Protecting a file.....	175
Menu.....	5
Using menus.....	47
Using the menu.....	176
Menu list.....	178
Menu items.....	48
Selecting the recording mode (REC Mode).....	181
Selecting the microphone sensitivity (Mic Sensitivity).....	182
Reducing noise when recording (Recording Filter).....	184
Selecting the input mode (Select Input).....	186
Selecting the display mode (Display).....	187
Turning the operation indicator on or off (LED).....	188
Selecting the memory using the menu (Select Memory).....	189
Selecting the clock display (Time Display).....	190
Turning the beep sound on or off (Beep).....	191
Setting the time period for the IC recorder to turn off (Auto Power Off).....	192
Resetting all menu items to the default setting (Reset All Settings).....	193
Formatting the memory (Format).....	194
Checking the system information (System Information).....	196
Computer.....	6
Using the IC recorder with a computer.....	50

Connecting the IC recorder to your computer.....	197
Structure of folders and files.....	199
Copying files from the IC recorder to your computer.....	203
Copying a music file from your computer to the IC recorder (drag and drop).....	205
Playing back music files copied from your computer using the IC recorder.....	206
Using the IC Recorder as USB memory.....	207
Software.....	7
Sound Organizer.....	51
What you can do using Sound Organizer (for Windows only).....	208
System requirements for using Sound Organizer.....	210
Installing Sound Organizer (for Windows only).....	212
The Sound Organizer window (for Windows only).....	215
Specifications.....	8
Specifications.....	52
About compatible memory cards.....	217
System requirements.....	218
Design and specifications.....	220
Battery life.....	223
Announcements.....	9
Notes on use.....	53
Precautions.....	225
Safety regulations.....	54
Safety regulations.....	227
Copyrights/Trademarks.....	55
Trademarks.....	229
Notice for users.....	230
Support website.....	56
Customer support websites.....	231
Troubleshooting.....	ii
IC recorder operations.....	10
If you have problems.....	57
Troubleshooting.....	232
Noise.....	58
The recorded file is noisy and is hard to understand.....	233
The recorded file is noisy and you want to record with less noise in your recording.....	234
A rustling noise is recorded.....	235

A buzzing or humming noise is recorded.....	236
Noise is recorded when you record a file using an external microphone (not supplied).....	237
Noise is heard when you listen to the file using headphones.....	238
Noise is heard in the playback even though the noise cut function is active.....	239
Power.....	59
The IC recorder cannot be turned on. The IC recorder does not operate, even if you press any button.....	240
The IC recorder cannot be turned off.....	241
The IC recorder is powered off automatically.....	242
The battery life is short.....	243
General operations.....	60
The IC recorder does not operate correctly.....	244
The operation indicator does not light.....	245
Recording.....	61
You cannot record a file.....	246
Recording is interrupted.....	247
When recording from other equipment, the input level is too strong or not strong enough.....	248
You cannot add a recording or an overwrite recording.....	249
Playback.....	62
The playback volume is low.....	250
No sound comes from the speaker.....	251
Sound comes from the speaker even when headphones are plugged in.....	252
Playback speed is too fast or too slow.....	253
Playback sound is not good when a music file is played back.....	254
Editing.....	63
You cannot divide a file.....	255
You cannot move a file.....	256
You cannot copy a file to another memory.....	257
Clock.....	64
"--:--" is displayed.	258
The recording date of a file appears as "--y--m--d" or "--:--."	259
The clock setting is reset.....	260
Display.....	65
There are fewer menu items displayed in the menu mode.....	261
The remaining time displayed in the display window is shorter than	

The remaining time displayed in the display window is shorter than that displayed on the computer.....	262
Files.....	66
The “Memory Full” animation is displayed and you cannot start recording.....	263
The “File Full” animation is displayed and you cannot operate the IC recorder.....	264
The memory card is not recognized.....	265
Computer.....	67
Even after you change a menu setting, the change is not applied to the menu.....	266
A character in a folder or file name is displayed in unreadable characters.....	267
It takes a long time to copy a file.....	268
The IC recorder is not recognized by your computer. A folder/file cannot be transferred from your computer.....	269
The file transferred from your computer is not displayed or cannot be played back.....	270
The computer cannot start.....	271
Software operations (Sound Organizer).....	11
Installation.....	68
The Sound Organizer software cannot be installed.....	272
Connections.....	69
The IC recorder cannot be properly connected.....	273
Operations.....	70
Playback sound from the computer is low. / No sound is emitted from the computer.....	274
Stored files cannot be played back or edited.....	275
The counter or slider moves incorrectly, or noise is heard.....	276
Operation is slow when there are many files.....	277
Display does not work during saving, adding, or deleting of files.....	278
The software ‘hangs’ when the Sound Organizer software starts up	279
Messages.....	12
Messages list.....	280
System limitations.....	13
System limitations.....	284
List of Topics.....	ii
How to Use.....	14
Troubleshooting.....	19



IC Recorder

ICD-PX440

[Back](#) | [Back to Top](#)

Preparation

[Parts description](#)

[Display window](#)

[Power](#)

[Memory card](#)

[Clock setting](#)

[Language setting](#)

[Selecting items on the display](#)

[HOLD](#)

[AVLS \(Automatic Volume Limiter System\)](#)

[Go to Page Top](#)

[Notes on use](#)



IC Recorder

ICD-PX440

[Back](#) | [Back to Top](#)

Recording

[Recording](#)

[Various operations/settings](#)

[Recording via other devices](#)

[Using external devices](#)

[Go to Page Top](#)

[Notes on use](#)

4-534-070-11(1)

Copyright 2014 Sony Corporation



IC Recorder

ICD-PX440

[Back](#) | [Back to Top](#)

Playback

[Playing](#)

[Various operations/settings](#)

[Using a calendar](#)

[Setting an alarm](#)

[Go to Page Top](#)

[Notes on use](#)

4-534-070-11(1)

Copyright 2014 Sony Corporation

IC Recorder

ICD-PX440

[Back](#) | [Back to Top](#)

Editing

[Erasing files](#)

[Organizing files](#)

[Track marks](#)

[Dividing files](#)

[Protecting files](#)

[Go to Page Top](#)

[Notes on use](#)

4-534-070-11(1)

Copyright 2014 Sony Corporation



IC Recorder

ICD-PX440

[Back](#) | [Back to Top](#)

Menu

[Using menus](#)

[Menu items](#)

[Go to Page Top](#)

[Notes on use](#)

4-534-070-11(1)

Copyright 2014 Sony Corporation



IC Recorder

ICD-PX440

[Back](#) | [Back to Top](#)

Computer

[Using the IC recorder with a computer](#)

[Go to Page Top](#)

[Notes on use](#)

4-534-070-11(1)

Copyright 2014 Sony Corporation



IC Recorder

ICD-PX440

[Back](#) | [Back to Top](#)

Software

[Sound Organizer](#)

[Go to Page Top](#)

[Notes on use](#)

4-534-070-11(1)

Copyright 2014 Sony Corporation



IC Recorder

ICD-PX440

[Back](#) | [Back to Top](#)

Specifications

[Specifications](#)

[Go to Page Top](#)

[Notes on use](#)

4-534-070-11(1)

Copyright 2014 Sony Corporation



IC Recorder

ICD-PX440

[Back](#) | [Back to Top](#)

Announcements

[Notes on use](#)

[Safety regulations](#)

[Copyrights/Trademarks](#)

[Support website](#)

[Go to Page Top](#)

[Notes on use](#)

4-534-070-11(1)

Copyright 2014 Sony Corporation



IC Recorder

ICD-PX440

[Back](#) | [Back to Top](#)

IC recorder operations

[If you have problems](#)

[Noise](#)

[Power](#)

[General operations](#)

[Recording](#)

[Playback](#)

[Editing](#)

[Clock](#)

[Display](#)

[Files](#)

[Computer](#)



IC Recorder

ICD-PX440

[Back](#) | [Back to Top](#)

Software operations (Sound Organizer)

[Installation](#)

[Connections](#)

[Operations](#)

[Go to Page Top](#)

[Notes on use](#)

4-534-070-11(1)

Copyright 2014 Sony Corporation



IC Recorder

ICD-PX440

[Back](#) | [Back to Top](#)

Messages

[Messages list](#)

[Go to Page Top](#)

[Notes on use](#)

4-534-070-11(1)

Copyright 2014 Sony Corporation



IC Recorder

ICD-PX440

[Back](#) | [Back to Top](#)

System limitations

[System limitations](#)

[Go to Page Top](#)

[Notes on use](#)

4-534-070-11(1)

Copyright 2014 Sony Corporation

IC Recorder

ICD-PX440

[Back](#) | [Back to Top](#)

How to Use

Preparation

Parts description

- [Parts and controls](#)

Display window

- [Display when stopped](#)
- [Display when recording](#)
- [Display during playback](#)
- [Display when the HOLD function is set](#)
- [Display in the HOLD status](#)
- [Display of the current file information](#)
- [Display during FOLDER selection](#)
- [Display of the file list](#)
- [Display during MENU operation](#)

Power

- [Inserting batteries](#)
- [Disconnecting the IC recorder from your computer](#)
- [Using a USB AC Adaptor](#)
- [Disconnecting the IC recorder from the USB AC adaptor](#)
- [Turning the power on](#)
- [Turning the power off](#)

Memory card

- [Inserting a memory card](#)

- [Selecting the memory](#)

Clock setting

- [Setting the clock](#)
- [Setting the clock using the menu](#)

Language setting

- [Setting the display language](#)

Selecting items on the display

- [Selecting a folder and a file](#)
- [Selecting a tab](#)

HOLD

- [Preventing unintentional operations \(HOLD\)](#)
- [Releasing the HOLD function](#)

AVLS (Automatic Volume Limiter System)

- [About the AVLS function \(European models only\)](#)
- [Turning the AVLS function on or off](#)

Recording

Recording

- [Recording sound from the built-in microphones](#)
- [About the recording level guide](#)
- [Monitoring sound while recording](#)
- [Various operations while recording](#)

Various operations/settings

- [Selecting a recording scene for each situation](#)
- [Registering recording settings in “My Scene”](#)
- [Tips for better recording](#)
- [Default settings for the “Scene Select” menu](#)
- [Adding a new segment to a previously recorded file](#)
- [Adding an overwrite recording during playback](#)
- [Starting to record automatically in response to sound – the VOR function](#)

Recording via other devices

- [Recording with an external microphone](#)
- [Recording from external equipment](#)

Using external devices

- [Recording the playback sound of the IC recorder on external equipment](#)

Playback

Playing

- [Playing back the recorded sound](#)
- [Various operations while playing](#)

Various operations/settings

- [Reducing noise in the playback sound and making the human voice clearer – the noise cut function](#)
- [Adjusting the playback speed – the DPC \(Digital Pitch Control\) function](#)
- [Playing back all files in a folder continuously - the continuous play](#)
- [Playing back a file repeatedly](#)
- [Playing back a specified section repeatedly \(A-B repeat\)](#)
- [Listening with better sound quality](#)
- [Searching forward/backward during playback \(Cue/Review\)](#)
- [Searching the desired point quickly \(Easy Search\)](#)

Using a calendar

- [Selecting a recording date from the calendar and playing back](#)

Setting an alarm

- [Playing back a file at a desired time with an alarm](#)

Editing

Erasing files

- [Erasing a file](#)
- [Erasing all files in a folder](#)

Organizing files

- [Moving a file to a different folder](#)
- [Copying a file to the other memory](#)

Track marks

- [Adding a track mark](#)
- [Erasing a track mark](#)
- [Erasing all the track marks in the selected file at one time](#)

Dividing files

- [Dividing a file at the current position](#)
- [Dividing a file at all the track mark positions](#)

Protecting files

- [Protecting a file](#)

Menu

Using menus

- [Using the menu](#)
- [Menu list](#)

Menu items

- [Selecting the recording mode \(REC Mode\)](#)
- [Selecting the microphone sensitivity \(Mic Sensitivity\)](#)
- [Reducing noise when recording \(Recording Filter\)](#)
- [Selecting the input mode \(Select Input\)](#)
- [Selecting the display mode \(Display\)](#)
- [Turning the operation indicator on or off \(LED\)](#)
- [Selecting the memory using the menu \(Select Memory\)](#)
- [Selecting the clock display \(Time Display\)](#)
- [Turning the beep sound on or off \(Beep\)](#)
- [Setting the time period for the IC recorder to turn off \(Auto Power Off\)](#)
- [Resetting all menu items to the default setting \(Reset All Settings\)](#)
- [Formatting the memory \(Format\)](#)
- [Checking the system information \(System Information\)](#)

Computer

Using the IC recorder with a computer

- [Connecting the IC recorder to your computer](#)
- [Structure of folders and files](#)
- [Copying files from the IC recorder to your computer](#)
- [Copying a music file from your computer to the IC recorder \(drag and drop\)](#)
- [Playing back music files copied from your computer using the IC recorder](#)
- [Using the IC Recorder as USB memory](#)

Software

Sound Organizer

- [What you can do using Sound Organizer \(for Windows only\)](#)

[System requirements for using Sound Organizer](#)

- [Installing Sound Organizer \(for Windows only\)](#)
- [The Sound Organizer window \(for Windows only\)](#)

Specifications

Specifications

- [About compatible memory cards](#)
- [System requirements](#)
- [Design and specifications](#)
- [Battery life](#)

Announcements

Notes on use

- [Precautions](#)

Safety regulations

- [Safety regulations](#)

Copyrights/Trademarks

- [Trademarks](#)
- [Notice for users](#)

Support website

- [Customer support websites](#)

[Go to Page Top](#)

[Notes on use](#)

4-534-070-11(1)

Copyright 2014 Sony Corporation

IC Recorder

ICD-PX440

[Back](#) | [Back to Top](#)

Troubleshooting

IC recorder operations

If you have problems

- [Troubleshooting](#)

Noise

- [The recorded file is noisy and is hard to understand.](#)
- [The recorded file is noisy and you want to record with less noise in your recording.](#)
- [A rustling noise is recorded.](#)
- [A buzzing or humming noise is recorded.](#)
- [Noise is recorded when you record a file using an external microphone \(not supplied\).](#)
- [Noise is heard when you listen to the file using headphones.](#)
- [Noise is heard in the playback even though the noise cut function is active.](#)

Power

- [The IC recorder cannot be turned on. The IC recorder does not operate, even if you press any button.](#)
- [The IC recorder cannot be turned off.](#)
- [The IC recorder is powered off automatically.](#)
- [The battery life is short.](#)

General operations

- [The IC recorder does not operate correctly.](#)
- [The operation indicator does not light.](#)

Recording

- [You cannot record a file.](#)
- [Recording is interrupted.](#)

- When recording from other equipment, the input level is too strong or not strong enough.
- You cannot add a recording or an overwrite recording.

Playback

- The playback volume is low.
- No sound comes from the speaker.
- Sound comes from the speaker even when headphones are plugged in.
- Playback speed is too fast or too slow.
- Playback sound is not good when a music file is played back.

Editing

- You cannot divide a file.
- You cannot move a file.
- You cannot copy a file to another memory.

Clock

- "--:--" is displayed.
- The recording date of a file appears as "--y--m--d" or "--:--."
- The clock setting is reset.

Display

- There are fewer menu items displayed in the menu mode.
- The remaining time displayed in the display window is shorter than that displayed on the computer.

Files

- The "Memory Full" animation is displayed and you cannot start recording.
- The "File Full" animation is displayed and you cannot operate the IC recorder.
- The memory card is not recognized.

Computer

- Even after you change a menu setting, the change is not applied to the menu.
- A character in a folder or file name is displayed in unreadable characters.
- It takes a long time to copy a file.
- The IC recorder is not recognized by your computer. A folder/file cannot be transferred from your computer.
- The file transferred from your computer is not displayed or cannot be played back.
- The computer cannot start.

Software operations (Sound Organizer)

Installation

- The Sound Organizer software cannot be installed.

Connections

- [The IC recorder cannot be properly connected.](#)

Operations

- [Playback sound from the computer is low. / No sound is emitted from the computer.](#)
- [Stored files cannot be played back or edited.](#)
- [The counter or slider moves incorrectly, or noise is heard.](#)
- [Operation is slow when there are many files.](#)
- [Display does not work during saving, adding, or deleting of files.](#)
- [The software 'hangs' when the Sound Organizer software starts up.](#)

Messages

Messages list

- [Messages list](#)

System limitations

System limitations

- [System limitations](#)

[Go to Page Top](#)

Notes on use

4-534-070-11(1)

Copyright 2014 Sony Corporation

IC Recorder

ICD-PX440

[Back](#) | [Back to Top](#)

[Print](#)

Notes on use

June 2013

Before use

To make full use of this content, please read the following notes thoroughly. Please note that they are subject to change without prior notice.

Recommended system environment

The following system environments are recommended for displaying this content. You may not be able to view the content on other system environments.

■ For viewing on a computer

Recommended browser

- With Microsoft Windows
 - Microsoft Internet Explorer 8 or later
 - Mozilla Firefox: latest version
 - Google Chrome™ : latest version
- With Apple Mac OS
 - Apple Safari Ver. 5 or later
 - Mozilla Firefox: latest version
 - Google Chrome : latest version

■ For viewing on a smartphone or tablet

Basic operation has been confirmed on the standard browser for the noted devices running the following operating systems.

- Android™ 2.3 or later: Xperia series, Walkman running Android
- iOS 4 or later: iPhone, iPod touch, iPad

■ JavaScript

JavaScript is used with this content for viewing convenience. If JavaScript is disabled in your web browser settings, the content may not operate properly or it may not be displayed correctly.

■ Style Sheets

Cascading Style Sheets are used in designing this content. Page layout may not be as intended if you view the content with style sheets disabled or on a web browser that is not compatible with style sheets. However, operation

will not be affected.

■ Cookies

This content uses cookies. To use services incorporating cookies, you need to set your browser to allow cookies.

Handling of personal information obtained from websites

Sony may use cookies, web beacons or similar technologies to make statistical analysis of customers' usage of this content while preserving anonymity.

[Go to Page Top](#)

Notes on use

4-534-070-11(1)

Copyright 2014 Sony Corporation



IC Recorder

ICD-PX440

[Back](#) | [Back to Top](#)

Parts description

[Parts and controls](#)

Explains the name of parts, such as buttons and switches, on the IC recorder.

[Go to Page Top](#)

[Notes on use](#)

4-534-070-11(1)

Copyright 2014 Sony Corporation

IC Recorder

ICD-PX440

[Back](#) | [Back to Top](#)

Display window

[Display when stopped](#)

Explains the items and icons that appear on the display window while the IC recorder is stopped.

[Display when recording](#)

Explains the items and icons that appear on the display window while the IC recorder is recording.

[Display during playback](#)

Explains the items and icons that appear on the display window while the IC recorder is playing back.

[Display when the HOLD function is set](#)

Shows the message that appears on the display window when the HOLD function is set to “ON.”

[Display in the HOLD status](#)

Shows the message that appears in the display window when you operate the IC recorder while the HOLD function is set to “ON.”

[Display of the current file information](#)

Explains the display which shows the current file information, such as the date and time recorded, file length, etc.

[Display during FOLDER selection](#)

Explains the items and icons that appear on the display window of the folder list.

[Display of the file list](#)

Explains the file list which appears after you select a particular folder.

Display during MENU operation

Explains the display that appears when you operate menu items.

[Go to Page Top](#)

Notes on use

4-534-070-11(1)

Copyright 2014 Sony Corporation



IC Recorder

ICD-PX440

[Back](#) | [Back to Top](#)

Power

[Inserting batteries](#)

Explains how to insert batteries.

[Disconnecting the IC recorder from your computer](#)

Explains how to disconnect the IC recorder from your computer.

[Using a USB AC Adaptor](#)

Explains how to use a USB AC Adaptor.

[Disconnecting the IC recorder from the USB AC adaptor](#)

Explains how to disconnect the IC recorder from the USB AC adaptor.

[Turning the power on](#)

Explains how to turn the power of the IC recorder on with the HOLD · POWER ON/OFF switch.

[Turning the power off](#)

Explains how to turn the power of the IC recorder off with the HOLD · POWER ON/OFF switch.

[Go to Page Top](#)

[Notes on use](#)

IC Recorder

ICD-PX440

[Back](#) | [Back to Top](#)

Memory card

[Inserting a memory card](#)

Explains how to insert or remove a memory card.

[Selecting the memory](#)

Explains how to select the memory to be used, either the built-in memory or the memory card.

[Go to Page Top](#)

[Notes on use](#)

4-534-070-11(1)

Copyright 2014 Sony Corporation



IC Recorder

ICD-PX440

[Back](#) | [Back to Top](#)

Clock setting

[Setting the clock](#)

Explains how to set the clock when the clock setting window appears.

[Setting the clock using the menu](#)

Explains how to set the clock from the menu.

[Go to Page Top](#)

[Notes on use](#)

4-534-070-11(1)

Copyright 2014 Sony Corporation



IC Recorder

ICD-PX440

[Back](#) | [Back to Top](#)

Language setting

[Setting the display language](#)

Explains how to select the language to be used for messages, menus, folder names, etc.

[Go to Page Top](#)

[Notes on use](#)

4-534-070-11(1)

Copyright 2014 Sony Corporation



IC Recorder

ICD-PX440

[Back](#) | [Back to Top](#)

Selecting items on the display

[Selecting a folder and a file](#)

Explains how to select a file or a folder in the display window.

[Selecting a tab](#)

Explains how to select the tab and switch the display according to the tab selected.

[Go to Page Top](#)

[Notes on use](#)

4-534-070-11(1)

Copyright 2014 Sony Corporation



IC Recorder

ICD-PX440

[Back](#) | [Back to Top](#)

HOLD

[Preventing unintentional operations \(HOLD\)](#)

Explains how to disable all button operations to prevent unintentional operations.

[Releasing the HOLD function](#)

Explains how to release the HOLD function to enable button operations.

[Go to Page Top](#)

[Notes on use](#)

4-534-070-11(1)

Copyright 2014 Sony Corporation



IC Recorder

ICD-PX440

[Back](#) | [Back to Top](#)

AVLS (Automatic Volume Limiter System)

[About the AVLS function \(European models only\)](#)

Explains how to maintain a moderate volume level when using headphones.

[Turning the AVLS function on or off](#)

Explains how to turn the AVLS function on or off.

[Go to Page Top](#)

[Notes on use](#)

4-534-070-11(1)

Copyright 2014 Sony Corporation



IC Recorder

ICD-PX440

[Back](#) | [Back to Top](#)

Recording

[Recording sound from the built-in microphones](#)

Explains the basic recording procedures using the built-in microphone.

[About the recording level guide](#)

Explains the recording level guide. It appears during recording and shows the input level.

[Monitoring sound while recording](#)

Explains how to monitor the sound while recording with headphones.

[Various operations while recording](#)

Introduces various operations you can perform while recording.

[Go to Page Top](#)

[Notes on use](#)

4-534-070-11(1)

Copyright 2014 Sony Corporation

IC Recorder

ICD-PX440

[Back](#) | [Back to Top](#)

Various operations/settings

[Selecting a recording scene for each situation](#)

Explains how to select the recording settings that match to various recording scenes, such as during meeting or interview (Scene Select).

[Registering recording settings in “My Scene”](#)

Explains how to register recording settings you want to use in “My Scene 1” or “My Scene 2” in the “Scene Select” menu.

[Tips for better recording](#)

Introduces hints for recording in various situations.

[Default settings for the “Scene Select” menu](#)

Introduces the recording settings (such as “REC Mode,” “Mic Sensitivity,” etc.) that are set as default for each “Scene Select” menu item.

[Adding a new segment to a previously recorded file](#)

Explains how to add a new segment to the file that is currently playing.

[Adding an overwrite recording during playback](#)

Explains how to add an overwrite recording after a selected point in a recorded file.

[Starting to record automatically in response to sound – the VOR function](#)

This function starts and pauses recording automatically according to the volume of the sound (input level) that the IC recorder detects.

IC Recorder

ICD-PX440

[Back](#) | [Back to Top](#)

Recording via other devices

[Recording with an external microphone](#)

Explains how to record with an external microphone that is connected to the IC recorder and selects the input mode with the “Select Input” menu.

[Recording from external equipment](#)

Explains how to record from externally connected equipment.

[Go to Page Top](#)

[Notes on use](#)

4-534-070-11(1)

Copyright 2014 Sony Corporation



IC Recorder

ICD-PX440

[Back](#) | [Back to Top](#)

Using external devices

[Recording the playback sound of the IC recorder on external equipment](#)

Explains how to record the playback sound of the IC recorder on external equipment.

[Go to Page Top](#)

[Notes on use](#)

4-534-070-11(1)

Copyright 2014 Sony Corporation



IC Recorder

ICD-PX440

[Back](#) | [Back to Top](#)

Playing

[Playing back the recorded sound](#)

Explains how to play back the recorded sound with the speaker of the IC recorder.

[Various operations while playing](#)

Introduces various operations you can perform while playing.

[Go to Page Top](#)

[Notes on use](#)

4-534-070-11(1)

Copyright 2014 Sony Corporation



IC Recorder

ICD-PX440

[Back](#) | [Back to Top](#)

Various operations/settings

[Reducing noise in the playback sound and making the human voice clearer – the noise cut function](#)

Explains how to reduce ambient noise, which makes the human voice clearer when playing back a file.

[Adjusting the playback speed – the DPC \(Digital Pitch Control\) function](#)

Explains how to adjust the playback speed in a range from 0.50 times to 2.00 times.

[Playing back all files in a folder continuously - the continuous play](#)

Explains how to play back all files in a folder continuously.

[Playing back a file repeatedly](#)

Explains how to play back a file repeatedly.

[Playing back a specified section repeatedly \(A-B repeat\)](#)

Explains how to play back a range between point A and point B, that you have set.

[Listening with better sound quality](#)

Explains how you can listen to a file with the high quality sound by connecting headphones or speakers to the IC recorder.

[Searching forward/backward during playback \(Cue/Review\)](#)

Explains how to find a desired point in the file by cueing/reviewing during playback.

[Searching the desired point quickly \(Easy Search\)](#)

Explains how to quickly locate the point at which you wish to start playback.

IC Recorder

ICD-PX440

[Back](#) | [Back to Top](#)

Using a calendar

[Selecting a recording date from the calendar and playing back](#)

Explains how to play back a file recorded using the IC recorder by searching for it from the calendar.

[Go to Page Top](#)

[Notes on use](#)

4-534-070-11(1)

Copyright 2014 Sony Corporation



IC Recorder

ICD-PX440

[Back](#) | [Back to Top](#)

Setting an alarm

[Playing back a file at a desired time with an alarm](#)

Explains how to start playing back a file with alarm sound at a desired time you set.

[Go to Page Top](#)

[Notes on use](#)

4-534-070-11(1)

Copyright 2014 Sony Corporation

IC Recorder

ICD-PX440

[Back](#) | [Back to Top](#)

Erasing files

[Erasing a file](#)

Explains how to erase a file stored on the IC recorder.

[Erasing all files in a folder](#)

Explains how to erase all files in a selected folder at once.

[Go to Page Top](#)

[Notes on use](#)

4-534-070-11(1)

Copyright 2014 Sony Corporation

IC Recorder

ICD-PX440

[Back](#) | [Back to Top](#)

Organizing files

[Moving a file to a different folder](#)

Explains how to move a selected file to a selected folder.

[Copying a file to the other memory](#)

Explains how to copy a file back and forth between the built-in memory and a memory card.

[Go to Page Top](#)

[Notes on use](#)

4-534-070-11(1)

Copyright 2014 Sony Corporation

IC Recorder

ICD-PX440

[Back](#) | [Back to Top](#)

Track marks

[Adding a track mark](#)

Explains how to add track marks to make it easier for you to find a point in a file.

[Erasing a track mark](#)

Explains how to erase a track mark that is located at just before the current position.

[Erasing all the track marks in the selected file at one time](#)

Explains how to erase all track marks in the selected file at once.

[Go to Page Top](#)

[Notes on use](#)

4-534-070-11(1)

Copyright 2014 Sony Corporation

IC Recorder

ICD-PX440

[Back](#) | [Back to Top](#)

Dividing files

[Dividing a file at the current position](#)

Explains how to divide a file into two parts at the desired position.

[Dividing a file at all the track mark positions](#)

Explains how to divide a file at all track mark positions.

[Go to Page Top](#)

[Notes on use](#)

4-534-070-11(1)

Copyright 2014 Sony Corporation



IC Recorder

ICD-PX440

[Back](#) | [Back to Top](#)

Protecting files

[Protecting a file](#)

Explains how to protect a file so that you cannot erase or edit it.

[Go to Page Top](#)

[Notes on use](#)

4-534-070-11(1)

Copyright 2014 Sony Corporation



IC Recorder

ICD-PX440

[Back](#) | [Back to Top](#)

Using menus

[Using the menu](#)

Explains how to set menus.

[Menu list](#)

Introduces the menus in each tab and in which operation mode the IC recorder can make changes to the menu. It also includes a link to each menu topic.

[Go to Page Top](#)

[Notes on use](#)

4-534-070-11(1)

Copyright 2014 Sony Corporation



IC Recorder

ICD-PX440

[Back](#) | [Back to Top](#)

Menu items

[Selecting the recording mode \(REC Mode\)](#)

Explains how to set the recording mode for the file to be recorded.

[Selecting the microphone sensitivity \(Mic Sensitivity\)](#)

Explains how to set the microphone sensitivity for the built-in microphone.

[Reducing noise when recording \(Recording Filter\)](#)

Explains how to reduce ambient noise or the roaring noise from wind, which allows you to record a file more clearly.

[Selecting the input mode \(Select Input\)](#)

Explains how to set the input type ("MIC IN" or "Audio IN") of the externally connected equipment.

[Selecting the display mode \(Display\)](#)

Explains how to set which information is to be displayed (elapsed time, remaining time, etc.) in the display window.

[Turning the operation indicator on or off \(LED\)](#)

Explains how to turn the operation indicator on or off while you are operating the IC recorder.

[Selecting the memory using the menu \(Select Memory\)](#)

Explains how to select the memory media (built-in memory or memory card) to be used.

[Selecting the clock display \(Time Display\)](#)

Explains how to select from 12 hour-clock or 24 hour-clock.

[Turning the beep sound on or off \(Beep\)](#)

Explains how to turn the operation beep on or off.

[Setting the time period for the IC recorder to turn off \(Auto Power Off\)](#)

Explains how to set the Auto Power Off function which turns the IC recorder off automatically when no operation has made and the duration of time set for this function has elapsed.

[Resetting all menu items to the default setting \(Reset All Settings\)](#)

This function changes menu settings back to the default settings. (Some of the menu items such as the clock setting, will not be changed.)

[Formatting the memory \(Format\)](#)

Explains how to format the built-in memory or a memory card which erases all files and changes the folder structure back to the initial status.

[Checking the system information \(System Information\)](#)

Explains how to check the model name of your IC recorder, software version and user name.

[Go to Page Top](#)

[Notes on use](#)

4-534-070-11(1)

Copyright 2014 Sony Corporation

IC Recorder

ICD-PX440

[Back](#) | [Back to Top](#)

Using the IC recorder with a computer

[Connecting the IC recorder to your computer](#)

Explains how to exchange files between the IC recorder and the computer connected.

[Structure of folders and files](#)

Explains the structure of folders and files that can be viewed on the computer.

[Copying files from the IC recorder to your computer](#)

Explains how to copy files and folders from the memory on the IC recorder to your computer.

[Copying a music file from your computer to the IC recorder \(drag and drop\)](#)

Explains how to copy music files that are stored on your computer to the IC recorder.

[Playing back music files copied from your computer using the IC recorder](#)

Explains how to listen to the files that have been transferred from your computer to the IC recorder.

[Using the IC Recorder as USB memory](#)

Explains how to store files (image files, text files, etc.) on the computer to the IC recorder and use it as an USB storage device.

[Go to Page Top](#)[Notes on use](#)



IC Recorder

ICD-PX440

[Back](#) | [Back to Top](#)

Sound Organizer

[What you can do using Sound Organizer \(for Windows only\)](#)

Introduces the functions or operations you can perform using the Sound Organizer software.

[System requirements for using Sound Organizer](#)

Shows a list of the system environments that are required to use the Sound Organizer software.

[Installing Sound Organizer \(for Windows only\)](#)

Explains the procedures required to install the Sound Organizer software.

[The Sound Organizer window \(for Windows only\)](#)

Explains the operations you can perform on the basic Sound Organizer window.

[Go to Page Top](#)

[Notes on use](#)

4-534-070-11(1)

Copyright 2014 Sony Corporation



IC Recorder

ICD-PX440

[Back](#) | [Back to Top](#)

Specifications

[About compatible memory cards](#)

Explains the types of memory cards you can use with your IC recorder.

[System requirements](#)

Shows a list of the system environments that are required to use the IC recorder (such as the version of your OS, etc.).

[Design and specifications](#)

Shows the specifications of the IC recorder (such as dimensions and weight, the size of the built-in memory, etc.).

[Battery life](#)

Shows the battery life for alkaline batteries or rechargeable batteries, in each file format.

[Go to Page Top](#)

[Notes on use](#)

4-534-070-11(1)

Copyright 2014 Sony Corporation

IC Recorder

ICD-PX440

[Back](#) | [Back to Top](#)

Notes on use

[Precautions](#)

Explains notes on operations, such as the places you use the IC recorder, and information on handling or maintenance.

[Go to Page Top](#)

[Notes on use](#)

4-534-070-11(1)

Copyright 2014 Sony Corporation



IC Recorder

ICD-PX440

[Back](#) | [Back to Top](#)

Safety regulations

[Safety regulations](#)

Describes important information (warnings or notes) for your safety.

[Go to Page Top](#)

[Notes on use](#)

4-534-070-11(1)

Copyright 2014 Sony Corporation



IC Recorder

ICD-PX440

[Back](#) | [Back to Top](#)

Copyrights/Trademarks

[Trademarks](#)

List of trademarks/registered trademarks

[Notice for users](#)

Important notice on copyrights

[Go to Page Top](#)

[Notes on use](#)

4-534-070-11(1)

Copyright 2014 Sony Corporation



IC Recorder

ICD-PX440

[Back](#) | [Back to Top](#)

Support website

[Customer support websites](#)

Introduces URLs of the customer support websites.

[Go to Page Top](#)

[Notes on use](#)

4-534-070-11(1)

Copyright 2014 Sony Corporation



IC Recorder

ICD-PX440

[Back](#) | [Back to Top](#)

If you have problems

[Troubleshooting](#)

[Go to Page Top](#)

[Notes on use](#)

4-534-070-11(1)

Copyright 2014 Sony Corporation



IC Recorder

ICD-PX440

[Back](#) | [Back to Top](#)

Noise

[The recorded file is noisy and is hard to understand.](#)

[The recorded file is noisy and you want to record with less noise in your recording.](#)

[A rustling noise is recorded.](#)

[A buzzing or humming noise is recorded.](#)

[Noise is recorded when you record a file using an external microphone \(not supplied\).](#)

[Noise is heard when you listen to the file using headphones.](#)

[Noise is heard in the playback even though the noise cut function is active.](#)

[Go to Page Top](#)

Notes on use

4-534-070-11(1)

Copyright 2014 Sony Corporation



IC Recorder

ICD-PX440

[Back](#) | [Back to Top](#)

Power

The IC recorder cannot be turned on. The IC recorder does not operate, even if you press any button.

The IC recorder cannot be turned off.

The IC recorder is powered off automatically.

The battery life is short.

[Go to Page Top](#)

Notes on use

4-534-070-11(1)

Copyright 2014 Sony Corporation



IC Recorder

ICD-PX440

[Back](#) | [Back to Top](#)

General operations

[The IC recorder does not operate correctly.](#)

[The operation indicator does not light.](#)

[Go to Page Top](#)

[Notes on use](#)

4-534-070-11(1)

Copyright 2014 Sony Corporation

IC Recorder

ICD-PX440

[Back](#) | [Back to Top](#)

Recording

[You cannot record a file.](#)

[Recording is interrupted.](#)

[When recording from other equipment, the input level is too strong or not strong enough.](#)

[You cannot add a recording or an overwrite recording.](#)

[Go to Page Top](#)

[Notes on use](#)

4-534-070-11(1)

Copyright 2014 Sony Corporation



IC Recorder

ICD-PX440

[Back](#) | [Back to Top](#)

Playback

[The playback volume is low.](#)

[No sound comes from the speaker.](#)

[Sound comes from the speaker even when headphones are plugged in.](#)

[Playback speed is too fast or too slow.](#)

[Playback sound is not good when a music file is played back.](#)

[Go to Page Top](#)

[Notes on use](#)

4-534-070-11(1)

Copyright 2014 Sony Corporation



IC Recorder

ICD-PX440

[Back](#) | [Back to Top](#)

Editing

You cannot divide a file.

You cannot move a file.

You cannot copy a file to another memory.

[Go to Page Top](#)

Notes on use

4-534-070-11(1)

Copyright 2014 Sony Corporation



IC Recorder

ICD-PX440

[Back](#) | [Back to Top](#)

Clock

“--:--” is displayed.

The recording date of a file appears as “--y--m--d” or “--:--.”

The clock setting is reset.

[Go to Page Top](#)

[Notes on use](#)

4-534-070-11(1)

Copyright 2014 Sony Corporation



IC Recorder

ICD-PX440

[Back](#) | [Back to Top](#)

Display

There are fewer menu items displayed in the menu mode.

The remaining time displayed in the display window is shorter than that displayed on the computer.

[Go to Page Top](#)

Notes on use

4-534-070-11(1)

Copyright 2014 Sony Corporation

IC Recorder

ICD-PX440

[Back](#) | [Back to Top](#)

Files

The “Memory Full” animation is displayed and you cannot start recording.

The “File Full” animation is displayed and you cannot operate the IC recorder.

The memory card is not recognized.

[Go to Page Top](#)

Notes on use

4-534-070-11(1)

Copyright 2014 Sony Corporation



IC Recorder

ICD-PX440

[Back](#) | [Back to Top](#)

Computer

[Even after you change a menu setting, the change is not applied to the menu.](#)

[A character in a folder or file name is displayed in unreadable characters.](#)

[It takes a long time to copy a file.](#)

[The IC recorder is not recognized by your computer. A folder/file cannot be transferred from your computer.](#)

[The file transferred from your computer is not displayed or cannot be played back.](#)

[The computer cannot start.](#)

[Go to Page Top](#)

Notes on use

4-534-070-11(1)

Copyright 2014 Sony Corporation



IC Recorder

ICD-PX440

[Back](#) | [Back to Top](#)

Installation

The Sound Organizer software cannot be installed.

[Go to Page Top](#)

Notes on use

4-534-070-11(1)

Copyright 2014 Sony Corporation



IC Recorder

ICD-PX440

[Back](#) | [Back to Top](#)

Connections

The IC recorder cannot be properly connected.

[Go to Page Top](#)

Notes on use

4-534-070-11(1)

Copyright 2014 Sony Corporation



IC Recorder

ICD-PX440

[Back](#) | [Back to Top](#)

Operations

[Playback sound from the computer is low. / No sound is emitted from the computer.](#)

[Stored files cannot be played back or edited.](#)

[The counter or slider moves incorrectly, or noise is heard.](#)

[Operation is slow when there are many files.](#)

[Display does not work during saving, adding, or deleting of files.](#)

[The software 'hangs' when the Sound Organizer software starts up.](#)

[Go to Page Top](#)[Notes on use](#)

4-534-070-11(1)

Copyright 2014 Sony Corporation



IC Recorder

ICD-PX440

[Back](#) | [Back to Top](#)

Messages list

[Messages list](#)

[Go to Page Top](#)

[Notes on use](#)

4-534-070-11(1)

Copyright 2014 Sony Corporation



IC Recorder

ICD-PX440

[Back](#) | [Back to Top](#)

System limitations

[System limitations](#)

[Go to Page Top](#)

[Notes on use](#)

4-534-070-11(1)

Copyright 2014 Sony Corporation

IC Recorder

ICD-PX440



[Back](#) | [Back to Top](#)

[Print](#)

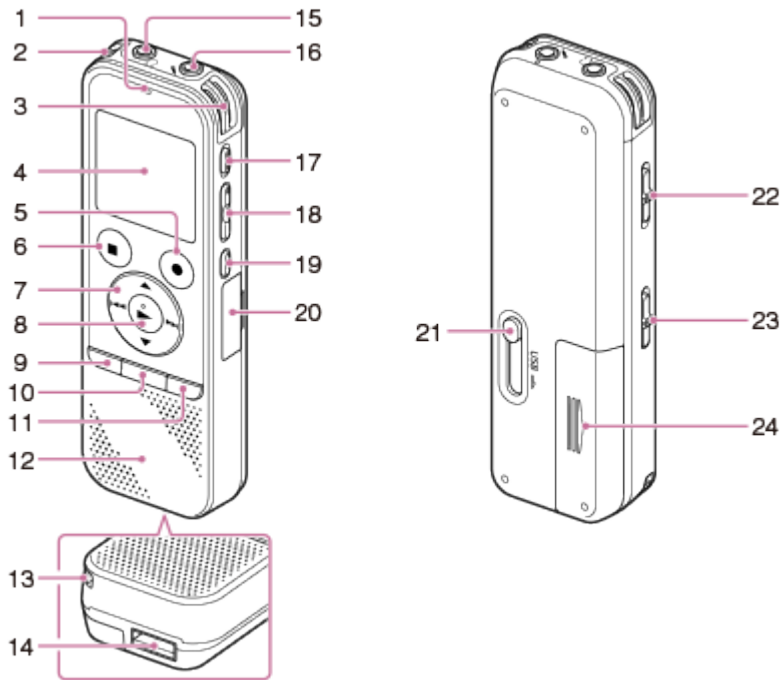
Parts and controls



1. Operation indicator
2. Built-in microphones (stereo) (L)
3. Built-in microphones (stereo) (R)
4. Display window
5. ● REC/PAUSE (record/pause) button
6. ■ STOP button
7. Control button (▲ , ▼ , ◀◀ (review/fast backward), ▶▶ (cue/fast forward))
8. ► (play/enter) button (*1)
9. MENU button
10. T-MARK (track mark) button
11. FOLDER button
12. Speaker

13. Strap hole (A strap is not supplied.)
14. USB connector compartment
15.  (headphones) jack
16.  (microphone) (PLUG IN POWER) jack (*1)
17. ERASE button
18. VOL $-/+$ (volume $-/+$) button (*1)
19.  A-B (repeat A-B) button
20. M2™/microSD memory card slot (The card slot is inside the cover.)(*2)
21. USB slide lever
22. HOLD · POWER ON/OFF switch
23. DPC (SPEED CTRL) switch
24. Battery compartment

*1 These buttons and the jack have a tactile dot. Use it as a reference point for operations, or to identify each terminal.

*2 In this Help Guide, M2™ and microSD cards are generally referred to as a “memory card.” The M2™/microSD memory card slot is referred to as the “memory card slot.”

[Go to Page Top](#)

Notes on use

4-534-070-11(1)

Copyright 2014 Sony Corporation

IC Recorder

ICD-PX440

[Back](#) | [Back to Top](#)

[Print](#)

Display when stopped

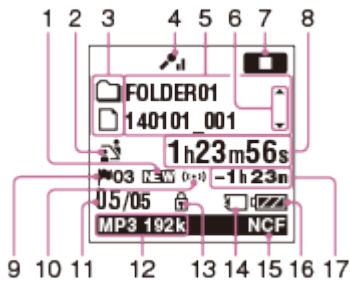

Note

- The window shown above displays indications, numbers or items for explanatory purposes. The actual window may differ from those displayed here.

1. Newly arriving podcast indicator

Appears when a new podcast file is transferred from the Sound Organizer software.

2. Scene Select indicator

Displays the currently selected scene used for recording. Appears when a scene is set.

: Meeting

: Lecture

: Voice Notes

: Interview

: Music

: My Scene 1

: My Scene 2

3. File information type indicator

: A folder where you can record a file













: A folder for playback only

: A folder for podcast files

: Title name

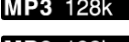
: Artist name

: File name

4. Microphone sensitivity indicator
Displays the level of the microphone sensitivity that has been set in the menu.
: High
: Medium
: Low
: High(Music)
: Low(Music)
5. File information
Displays the information for each file according to the file information type (folder name, title name, artist name, file name).
6. Operating guide for switching file information
You can switch the file information display in sequence by pressing ▲ or ▼ .
7. Operation mode indicator
Displays the following, depending on the current operation of the IC recorder.
: stop
8. Counter information
You can select the display mode in the menu.
 Elapsed Time: The elapsed time of a file
 Remain Time: The remaining time of a file
 REC Date: Date recorded
 REC Time: Time recorded
9. Track mark indicator
Displays the track mark number just before the current position. Appears when a track mark is set for a file.
10. Alarm indicator
Appears when the alarm is set in a file.
11. File number information
The selected file number is displayed in the numerator and the total number of files in the folder is displayed in the denominator.
12. Recording mode indicator
The recording mode selected in the menu is displayed.
: MP3 8kbps(MONO)
: MP3 48kbps(MONO)
: MP3 128kbps
: MP3 192kbps
13. Protect indicator
Appears when the protection is set for a file.
14. Memory card indicator
Appears when “Memory Card” is selected as “Select Memory.” When “Built-In Memory” is selected, no indication is displayed.
15. Recording filter indicator
Displays the recording filter setting.
: Appears when the recording filter is set to “NCF(Noise Cut).”
: Appears when the recording filter is set to “LCF(Low Cut).”
16. Battery indicator
17. Remaining recording time
Displays the remaining recording time in hours, minutes, and seconds. If there is more than 10 hours time

remaining, the time is displayed in hours.

If there is more than 10 minutes and less than 10 hours time remaining, the time is displayed in hours and minutes.

If there is less than 10 minutes time remaining, the time is displayed in minutes and seconds.

[Go to Page Top](#)

Notes on use

4-534-070-11(1)

Copyright 2014 Sony Corporation

IC Recorder

ICD-PX440

[Back](#) | [Back to Top](#)

[Print](#)

Display when recording

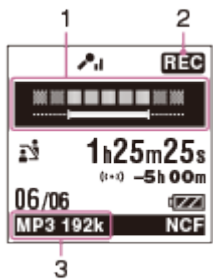

Note

- The window shown above displays indications, numbers or items for explanatory purposes. The actual window may differ from those displayed here.

1. Recording level guide display

Displays the recording level and the optimum level for recording.

2. Operation mode indicator

Displays the following, depending on the current operation of the IC recorder.

REC: recording

●||: recording pause (flashing)

VOR REC: recording with the VOR function

VOR ●||: recording pause with the VOR function (flashing)

If you press **● REC/PAUSE** to pause recording when “VOR” is set to “ON” in the menu, only “**●||**” flashes.

3. Recording mode indicator

Displays the recording mode of the currently recorded file.

MP3 8k: MP3 8kbps(MONO)

MP3 48k: MP3 48kbps(MONO)

MP3 128k: MP3 128kbps

MP3 192k: MP3 192kbps

[Go to Page Top](#)

IC Recorder

ICD-PX440

[Back](#) | [Back to Top](#)

[Print](#)

Display during playback

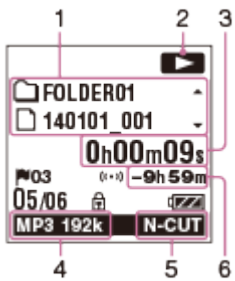

Note



- The window shown above displays indications, numbers or items for explanatory purposes. The actual window may differ from those displayed here.

1. File information

You can check and switch the file information display during playback by pressing **▲** or **▼**. The file information display cannot be switched when the DPC (SPEED CTRL) switch is set to “ON.”

A file recorded using the IC recorder is displayed as follows.



: Folder name: FOLDER01 - FOLDER05 (If the folder has been transferred from the computer to the IC recorder, “” or “” appears on the display.)

: File name: Date_file number (e.g. 140101_001)



: Artist name (e.g. My Recording)

: Title: Date_file number (e.g. 140101_001)

2. Operation mode indicator

Displays the following, depending on the current operation of the IC recorder.

: playback

 : review/fast backward, cue/fast forward

 : going backward/forward continuously

3. Counter information

You can select the display mode in the menu.

Elapsed Time: The elapsed time of a file



Remain Time: The remaining time of a file

REC Date: Date recorded

REC Time: Time recorded

4. Recording mode indicator

When the IC recorder is playing a file, the recording mode of the file is displayed.

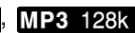
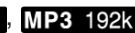
   : MP3 file recorded with the IC recorder

When the files are transferred from your computer, only the file format is displayed.

: MP3 file transferred

: Appears when the IC recorder cannot recognize the recording mode.

5. Noise Cut indicator

Appears when the “Noise Cut” in the menu is set to “Auto,” “Maximum,” or “Medium.”

: Noise Cut

6. Remaining recording time

Displays the remaining recording time in hours, minutes, and seconds.

If there is more than 10 hours time remaining, the time is displayed in hours.

If there is more than 10 minutes and less than 10 hours time remaining, the time is displayed in hours and minutes.

If there is less than 10 minutes time remaining, the time is displayed in minutes and seconds.

[Go to Page Top](#)

Notes on use

4-534-070-11(1)

Copyright 2014 Sony Corporation



IC Recorder

ICD-PX440

[Back](#) | [Back to Top](#)[Print](#)

Display when the HOLD function is set

**Note**

- The window shown above displays indications, numbers or items for explanatory purposes. The actual window may differ from those displayed here.

1. Message displayed when the HOLD function is set to “ON.”

“HOLD” and the current time appear for approximately 3 seconds when you slide the HOLD • POWER ON/OFF switch in the direction of “HOLD.”

[Go to Page Top](#)[Notes on use](#)

4-534-070-11(1)

Copyright 2014 Sony Corporation

IC Recorder

ICD-PX440

[Back](#) | [Back to Top](#)[Print](#)

Display in the HOLD status

**Note**

- The window shown above displays indications, numbers or items for explanatory purposes. The actual window may differ from those displayed here.

1. Message displayed while HOLD function is on.

Appears when you attempt to operate the IC recorder while the HOLD function is set to prevent unintentional operations. All button operations are disabled.

[Go to Page Top](#)

Related Topic

- [Preventing unintentional operations \(HOLD\)](#)
- [Releasing the HOLD function](#)

[Go to Page Top](#)

IC Recorder

ICD-PX440

[Back](#) | [Back to Top](#)

[Print](#)

Display of the current file information



Note

- The window shown above displays indications, numbers or items for explanatory purposes. The actual window may differ from those displayed here.

1. Current file information

When a file that has been recorded using the IC recorder is selected and the IC recorder is stopped, you can check the file information by pressing **■ STOP**. The file information appears for about 1 minute. You can scroll the display by pressing **▲** or **▼**.

The following information will be displayed.

- Rec Date/Time: Displays the date and time recorded (y (year), m (month), d (day), and time).
- File Length: Displays the length of the file (h (hour), m (minute), and s (second)).
- Model Name: Displays the name of the device on which the current file was recorded. The model name that appears for "Model:" in the "System Information" will be displayed in this area.
- Scene Select: Displays the "Scene Select" setting in effect when the file was recorded.
- REC Mode: Displays the recording mode of the file.
- Mic Sensitivity: Displays the microphone sensitivity setting in effect when the file was recorded.
- Recording Filter: Displays the recording filter setting in effect when the file was recorded.
- VOR: Displays the VOR (Voice Operated Recording) setting in effect when the file was recorded.
- Input: Displays the input method ("Built-in Mic," "External Mic," or "AUDIO IN" used when the file was recorded).

Hint

- If you do not attempt to operate the IC recorder for 1 minute, the file information disappears and the display returns to the stop mode display. If you go back to the stop mode display immediately, press **■ STOP**.

IC Recorder

ICD-PX440

[Back](#) | [Back to Top](#)

[Print](#)

Display during FOLDER selection

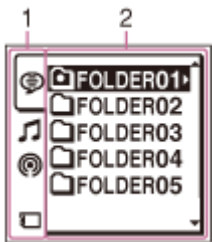

Note

- The window shown above displays indications, numbers or items for explanatory purposes. The actual window may differ from those displayed here.

1. Tabs

Displays the types (recordable or playback-only) of areas and memory available:

 (Voice): Recordable area used to manage files recorded with the IC recorder.

 (Music): Playback-only area used to manage music files transferred from your computer. (If no file or folder has been transferred, the tab will not be displayed.)

 (Podcast): Playback-only area used to manage podcast files transferred from your computer. (If no file or folder has been transferred, the tab will not be displayed.)

 (Built-in memory): Appears when you insert a memory card and set the memory to the built-in memory.

 (Memory card): Appears when you insert a memory card and set the memory to the memory card.

2. Folders

Displays the folders contained in the selected tab.

Structure of folders displayed in the display window of the IC recorder

The display of the structure of the folders seen in the display window of the IC recorder is different from that seen on the display of a computer.

The folder indicators in the display window of the IC recorder are as follows:

 Folder for files recorded using the IC recorder

 Folder transferred from a computer (They are displayed when music files have been transferred from a computer.)

: Folder for podcast files transferred from a computer (These folders are displayed when podcast files have been



transferred from a computer.)

Note

- If folders have no files that can be played back using the IC recorder, those folders will not be displayed in the display window of the IC recorder.

Folders displayed on the tab of the IC recorder



Folders for files recorded using the IC recorder (folders under the VOICE folder) will be displayed.

Note

- Even if a file is transferred directly under the VOICE folder, it will not be displayed on the  tab of the IC recorder.

Folders displayed on the tab of the IC recorder



The following folders will be displayed among the folders forwarded from a computer.

- Folders under the MUSIC folder which contains a file (When some folders have multiple levels, all folders will be displayed in parallel.)
- Folders transferred to places other than under the MUSIC folder or the PODCASTS folder
- A folder called “No Folder” (If you transfer files separately, those files will be displayed under this folder.)

Folders displayed on the tab of the IC recorder



Folders for podcast files transferred from a computer will be displayed.

When you transfer podcast files from your computer to the IC recorder, use the Sound Organizer software.

[Go to Page Top](#)

IC Recorder

ICD-PX440

[Back](#) | [Back to Top](#)

[Print](#)

Display of the file list

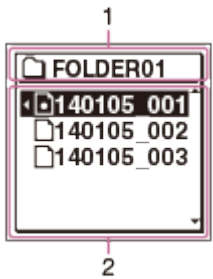

Note

- The window shown above displays indications, numbers or items for explanatory purposes. The actual window may differ from those displayed here.

1. Folder

The icon and the name of the particular folder that you select.

2. File list

The list of files stored in the folder.

[Go to Page Top](#)

[Notes on use](#)

4-534-070-11(1)

Copyright 2014 Sony Corporation

IC Recorder

ICD-PX440

[Back](#) | [Back to Top](#)

[Print](#)

Display during MENU operation

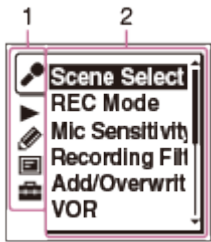





Note

- The window shown above displays indications, numbers or items for explanatory purposes. The actual window may differ from those displayed here.

1. Menu tabs

Displays the menu tabs.

- : Recording
- : Playback
- : Edit
- : Display
- : IC recorder settings

2. Menu items

Displays the menu items of the selected menu tab.

[Go to Page Top](#)

Related Topic

- [Menu list](#)

IC Recorder

ICD-PX440

[Back](#) | [Back to Top](#)[Print](#)

Inserting batteries

1. Insert batteries.

Slide and lift the battery compartment lid, insert LR03 (size AAA) alkaline batteries with correct polarity, and close the lid.

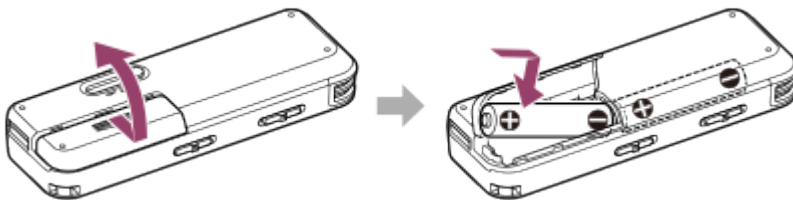
**Note**

- The IC recorder itself cannot charge the nickel metal hydride rechargeable batteries. Use the specified charger to charge nickel metal hydride rechargeable batteries.
- When replacing the batteries, be sure to replace both batteries with new ones.

Hint

- You can use two NH-AAA-B2KN/NH-AAA-B2EN rechargeable batteries (not supplied).

[Go to Page Top](#)

Notes on use

4-534-070-11(1)

Copyright 2014 Sony Corporation

IC Recorder

ICD-PX440

[Back](#) | [Back to Top](#)

[Print](#)

Disconnecting the IC recorder from your computer

Follow the procedures below; otherwise, when the IC recorder contains data files, the files may be damaged or become unplayable.

1. Make sure that the operation indicator does not light.
2. Perform the following operation on your computer.
 - On the Windows taskbar at the bottom right of the desktop, left-click the following icon.



Then, left-click “Eject IC RECORDER” (Windows 7, Windows 8, Windows 8.1), or “Safely remove USB Mass Storage Device” (Windows Vista). The icon and menu displayed can be different on different operating systems. The icon may not be always displayed on the taskbar depending on your computer settings.

- On a Mac screen, click the removal icon of the “IC RECORDER” that appears on the sidebar of the Finder.
3. Disconnect the IC recorder from the USB port of the computer, and slide the USB slide lever in the direction of the arrow to retract the USB connector.

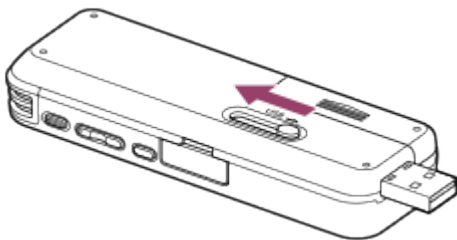

Hint

- For details on disconnecting the IC recorder from your computer, refer to the operating instructions supplied with your computer.

[Go to Page Top](#)

Related Topic

- [Connecting the IC recorder to your computer](#)

[Go to Page Top](#)

Notes on use

4-534-070-11(1)

Copyright 2014 Sony Corporation

IC Recorder

ICD-PX440

[Back](#) | [Back to Top](#)

[Print](#)

Using a USB AC Adaptor

You can use the IC recorder while it is connected to an AC outlet using a USB AC adaptor (not supplied). This is useful when you want to record for a long time.

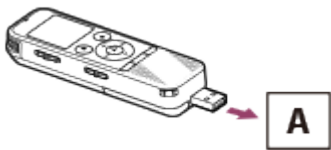

A: USB AC adaptor (not supplied)

1. Connect a USB AC adaptor (not supplied) to an AC outlet.
2. Slide the USB slide lever on the back of the IC recorder and connect the USB connector to the USB AC adaptor.

[Go to Page Top](#)

Related Topic

- [Disconnecting the IC recorder from the USB AC adaptor](#)

[Go to Page Top](#)

[Notes on use](#)



IC Recorder

ICD-PX440

[Back](#) | [Back to Top](#)[Print](#)

Disconnecting the IC recorder from the USB AC adaptor

Follow the procedures below; otherwise, when the IC recorder contains data files, the files may be damaged or become unplayable.

1. If you are recording or playing back a file, press **■ STOP** to stop the IC recorder.
2. Make sure that the operation indicator of the IC recorder does not light.
3. Disconnect the IC recorder from the USB AC adaptor, and then disconnect the USB AC adaptor from the AC outlet.

[Go to Page Top](#)

Related Topic

- [Using a USB AC Adaptor](#)

[Go to Page Top](#)

Notes on use

4-534-070-11(1)

Copyright 2014 Sony Corporation

IC Recorder

ICD-PX440

[Back](#) | [Back to Top](#)

[Print](#)

Turning the power on

1. Slide and hold the HOLD · POWER ON/OFF switch in the direction of “POWER ON/OFF” until the window display appears.

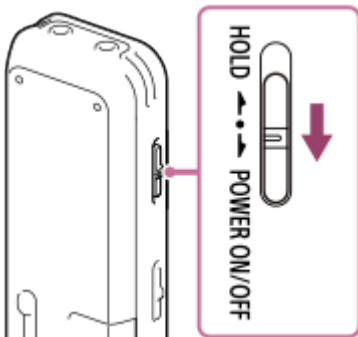

The “Accessing...” animation is displayed, and the IC recorder is turned on.

Hint

- When the IC recorder is in the stop mode, and you leave the IC recorder without attempting an operation for a certain length of time, the auto power off function will take effect. (The length of time before auto power off is set to “10min” when you purchase the IC recorder.)

[Go to Page Top](#)

Related Topic

- [Turning the power off](#)
- [Setting the time period for the IC recorder to turn off \(Auto Power Off\)](#)

IC Recorder

ICD-PX440

[Back](#) | [Back to Top](#)

[Print](#)

Turning the power off

1. Slide and hold the HOLD · POWER ON/OFF switch in the direction of “POWER ON/OFF” until the “Power Off” animation is displayed.

The IC recorder is turned off.

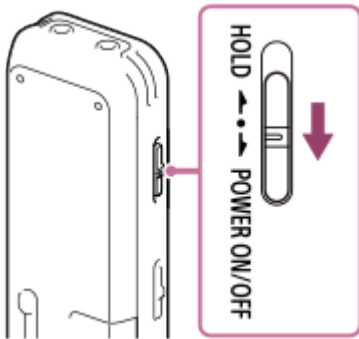

Hint

- When the IC recorder is in the stop mode, and you leave the IC recorder without attempting an operation for a certain length of time, the auto power off function will take effect. (The length of time before auto power off is set to “10min” when you purchase the IC recorder.)

[Go to Page Top](#)

Related Topic

- [Setting the time period for the IC recorder to turn off \(Auto Power Off\)](#)
- [Turning the power on](#)

IC Recorder

ICD-PX440

[Back](#) | [Back to Top](#)

[Print](#)

Inserting a memory card

In addition to the built-in memory, you can record files on a memory card.

Note

- In this Help Guide, M2™ and microSD cards are generally referred to as a “memory card.” The M2™/microSD memory card slot is referred to as the “memory card slot.”

1. In the stop mode, open the cover of the memory card slot.



2. Insert an M2™ or microSD card securely to the end of the slot until it clicks into place, as described below.
 - ①: Insert an M2™ with the label side facing toward you.
 - ②: Insert a microSD card with the terminal side facing toward you.

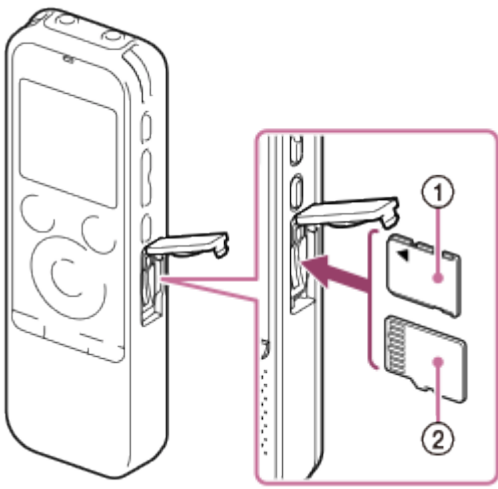

3. Close the cover of the memory card slot.
“Change to Memory Card?” appears on the display.
4. Press ▲ or ▼ to select “Yes” or “No,” and then press ►.

Note

- If a memory card is not recognized, remove it and then insert it into the IC recorder again.
- Do not insert any liquid, metal, flammable or any object other than a memory card into the memory card slot. Doing so may cause fire, electric shock, or malfunctions.
- Before recording, we recommend that you copy all the data stored on the memory card to your computer and format the memory card on the IC recorder so it contains no data.
- If you insert a memory card while the IC recorder is turned off, you can select the memory to be used with “Select Memory” in the menu when you turn the IC recorder on the next time.

Hint

- To remove the memory card, push the memory card into the slot. When it pops out, remove it from the memory card slot.
- If you apply excessive force to the cover of the memory card slot, the cover may be detached. In this case, you can reattach the cover to its previous location on the IC recorder.

[Go to Page Top](#)

Related Topic

- [Formatting the memory \(Format\)](#)
- [Structure of folders and files](#)
- [About compatible memory cards](#)
- [Selecting the memory using the menu \(Select Memory\)](#)

IC Recorder











ICD-PX440

[Back](#) | [Back to Top](#)



[Print](#)

Selecting the memory

You can switch the memory between the built-in memory and a memory card using the folder selection window.



1. Press FOLDER.
The folder selection window is displayed.
2. Press , and then press  or  to select the  or  tab.
 (Built-in memory) or  (Memory card) tab will appear when you insert a memory card into the IC recorder.
3. Press .
4. Press  or  to select "Built-In Memory" or "Memory Card," and then press .



The tab icon is changed to those of the selected memory,  or .

5. Press  STOP to return to the stop mode display.

Hint

- You can switch the memory using the menu. Select MENU - the  tab - "Select Memory" to switch the memory.
- If the memory card has not been formatted, switch the memory using the "Select Memory" menu, and then select MENU - the  tab - "Format" to format the memory card.

[Go to Page Top](#)

- [Inserting a memory card](#)
- [Selecting the memory using the menu \(Select Memory\)](#)
- [Formatting the memory \(Format\)](#)

[Go to Page Top](#)

Notes on use

4-534-070-11(1)

Copyright 2014 Sony Corporation

IC Recorder

ICD-PX440

[Back](#) | [Back to Top](#)

[Print](#)

Setting the clock

You need to set the clock to use the alarm function or record the date and time.

When you insert batteries for the first time, or when you re-insert batteries or replace batteries with new ones, the “Set Date&Time” animation appears, and then the year section begins to flash in the clock setting display window.

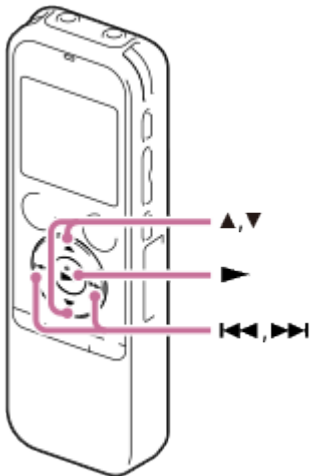

1. Set year, month, day, hour and minute.

Press ▲ or ▼ to set the year (the last two digits of the year), and then press ►. Repeat this procedure to set month, day, hour, and minute in sequence.

You can move the cursor to the year, month, day, hour and minute by pressing ◀◀ or ▶▶.

When you set the minute and press ►, the clock reflects the setting.

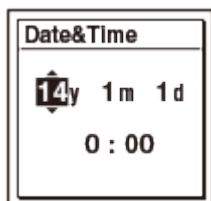

When you finish setting the clock, the display window returns to the stop mode display.

Note

- When you re-insert batteries, or when you replace batteries with new ones, the clock setting display appears, and the approximate time when you last operated the IC recorder before replacing the batteries is displayed. Set the clock to the current time again.
- If you do not press ► within 1 minute of entering the clock setting data, the clock setting mode is canceled and the window will return to the display of the stop mode.
- The time is displayed either in 12-Hour with “AM” or “PM,” or in 24-Hour, depending on the “Time Display” setting in the menu. The default setting differs depending on the country or region you purchased the IC recorder.

Hint

- If you set the HOLD function to on while the IC recorder is stopped, the current time will be displayed.
- You can set the clock using the menu as well.

[Go to Page Top](#)

Related Topic

- [Setting the clock using the menu](#)

[Go to Page Top](#)[Notes on use](#)

4-534-070-11(1)

Copyright 2014 Sony Corporation

IC Recorder

ICD-PX440

[Back](#) | [Back to Top](#)

[Print](#)

Setting the clock using the menu

While the IC recorder is stopped, you can set the clock using the menu.

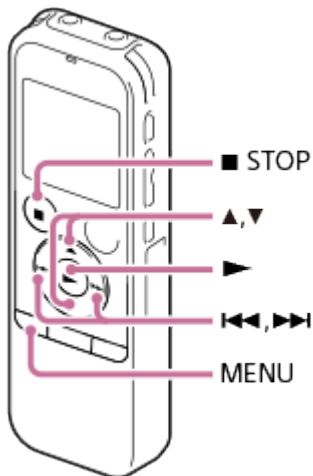

1. Select MENU - the  tab - "Date&Time," and then press ▶.

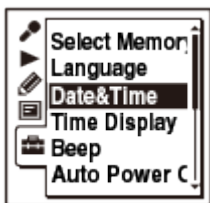

2. Press ▲ or ▼ to select "Auto(Synchronizing)" or "Manual," and then press ▶.



When you select "Auto(Synchronizing)," the clock is automatically adjusted using the clock in the computer

connected to the IC recorder and on which the Sound Organizer software is started.
When you select “Manual,” proceed to the next steps.

3. Press ▲ or ▼ to select the date display and then press ►.



4. Set year, month, day, hour and minute.

Press ▲ or ▼ to set the year (the last two digits of the year), and then press ►. Repeat this procedure to set month, day, hour, and minute in sequence.

You can move the cursor to the year, month, day, hour and minute by pressing ◀◀ and ▶▶. When you set the minute and press ►, the clock reflects the setting.

5. Press ■ STOP to exit the menu mode.

Note

- If you do not press ► within 1 minute of entering the clock setting data, the clock setting mode is canceled and the window will return to the display of the stop mode.
- The time is displayed either in 12-Hour with “AM” or “PM,” or in 24-Hour, depending on the “Time Display” setting in the menu. The default setting differs depending on the country or region you purchased the IC recorder.

Hint

- If you set the HOLD function to on while the IC recorder is stopped, the current time will be displayed.

[Go to Page Top](#)

Notes on use

4-534-070-11(1)

Copyright 2014 Sony Corporation

IC Recorder



ICD-PX440

[Back](#) | [Back to Top](#)

[Print](#)

Setting the display language

You can select the language to be used for messages, menus, folder names, file names, etc.

1. Select MENU - the  tab - "Language," and then press .

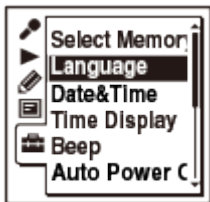

2. Press  or  to select the language that you want to use, and then press .

You can select the language from Deutsch (German), English, Español (Spanish), Français (French), Italiano (Italian), Русский (Russian), 한국어 (Korean), 简体中文 (Chinese), 繁體中文 (Chinese), ไทย (Thai).

3. Press  STOP to return to the stop mode display.

Note

- Number of language options you can select and the default setting differ depending on the country or region you purchased your IC recorder.

[Go to Page Top](#)

Notes on use

4-534-070-11(1)

Copyright 2014 Sony Corporation

IC Recorder

ICD-PX440

[Back](#) | [Back to Top](#)

[Print](#)

Selecting a folder and a file

You can select a folder and a file for recording, playing or editing.

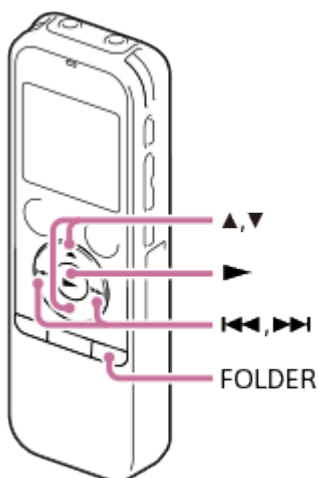

1. In the stop mode, press FOLDER.
The folder selection window is displayed.
2. Select a folder.
Press ▲ or ▼ to select the desired folder, and then press ▶.
To display the files contained in the selected folder, press ▲ or ▼ to select the folder, and then press ▶▶.

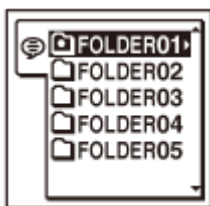

When you purchase the IC recorder, there are 5 folders already available (FOLDER01-05).

3. Select a file.
When the file selection window is displayed, press ▲ or ▼ to select the desired file, and then press ▶.

When the stop mode window is displayed, you can switch files by pressing ◀◀ and ▶▶.

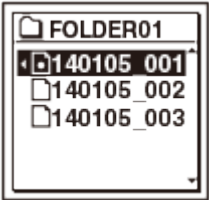

[Go to Page Top](#)

[Notes on use](#)

4-534-070-11(1)

Copyright 2014 Sony Corporation

IC Recorder

ICD-PX440

[Back](#) | [Back to Top](#)

[Print](#)

Selecting a tab

The recordable area and the playback-only area of folders stored on the IC recorder are managed separately, and are displayed with tabs.

When you select a folder, you can move between areas by switching the tabs.

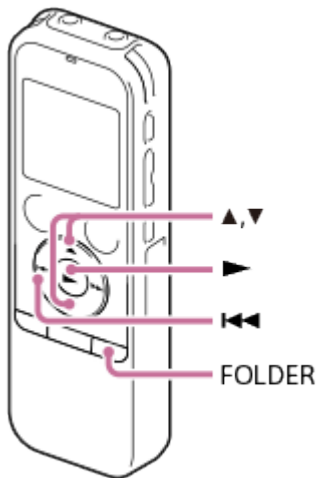

1. In the stop mode, press FOLDER.

The folder selection window is displayed.

2. Press and then press or to select the , , , or tab.

Only the tab is displayed when you purchase the IC recorder. The tab and the tab will be displayed when you transfer files from your computer.

The tab is displayed when a memory card is inserted. When the memory card is selected as the memory to be used, the tab will be displayed.



3. Press ►.

The folders contained in the selected tab are displayed.

4. Select a folder and a file.

[Go to Page Top](#)

Related Topic

- [Selecting a folder and a file](#)
- [Playing back music files copied from your computer using the IC recorder](#)

[Go to Page Top](#)

[Notes on use](#)

4-534-070-11(1)

Copyright 2014 Sony Corporation

IC Recorder

ICD-PX440

[Back](#) | [Back to Top](#)

[Print](#)

Preventing unintentional operations (HOLD)

You can disable all the buttons (HOLD) in order to prevent unintentional operations when you carry the IC recorder, etc.

1. Slide the HOLD · POWER ON/OFF switch in the direction of “HOLD” to disable the buttons while the power is on.

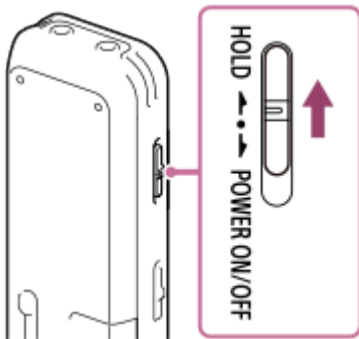

“HOLD” and current time appear for approximately 3 seconds, indicating that all the button operations are disabled.



Note

- When the HOLD function is activated during recording, all button operations are disabled. To stop recording, cancel the HOLD function first.

Hint

- Even if the HOLD function is activated, you can stop the alarm playback by pressing any button. (You cannot stop normal playback.)
- The clock display (12 hour-clock or 24 hour-clock) can be changed using “Time Display” in the menu. (e.g., 12:00)

Related Topic

- [Releasing the HOLD function](#)

[Notes on use](#)

4-534-070-11(1)

Copyright 2014 Sony Corporation

IC Recorder

ICD-PX440

[Back](#) | [Back to Top](#)

[Print](#)

Releasing the HOLD function

If you operate buttons on the IC recorder when the HOLD function is set, “HOLD. Slide HOLD Switch to Activate.” appears on the display.



Release the HOLD function when you operate the IC recorder.

1. Slide the HOLD · POWER ON/OFF switch towards the center.

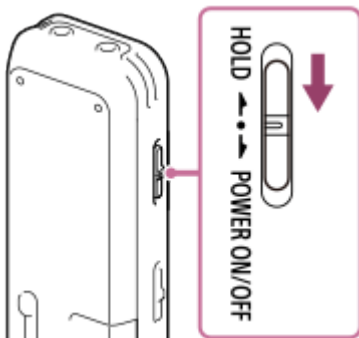

[Go to Page Top](#)

Related Topic

- [Preventing unintentional operations \(HOLD\)](#)

IC Recorder

ICD-PX440

[Back](#) | [Back to Top](#)

[Print](#)

About the AVLS function (European models only)

The AVLS (Automatic Volume Limiter System) function allows you to listen to the sound at a moderate volume level when using headphones.

The AVLS function limits the maximum volume to prevent auditory issues or distraction and also to maintain a moderate volume level.

When “AVLS” is set to “ON”

When you try to adjust the volume to a level that exceeds the AVLS-specified level, the “AVLS” indicator lights. You cannot adjust the volume to a level that exceeds the limit.

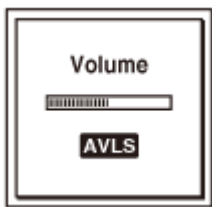

Note

- “AVLS” is set to “ON” when you purchase the IC recorder. If you want to turn off the function and play back files at the original volume, use the menu to set “AVLS” to “OFF.”

[Go to Page Top](#)

[Notes on use](#)

4-534-070-11(1)

Copyright 2014 Sony Corporation

IC Recorder





ICD-PX440

[Back](#) | [Back to Top](#)

[Print](#)





Turning the AVLS function on or off

When the AVLS function is set to “ON,” the “AVLS” indicator lights and you cannot adjust the volume to a level that exceeds the AVLS-specified level. This function is set to “ON” at the time of purchase, but you can also turn the function off.

1. In the stop or playback mode, select MENU – the  tab – “AVLS,” and then press .
2. Press  or  to select “OFF” (when you turn off the AVLS function) or “ON” (when you turn on the AVLS function), and then press .

When you select “OFF,” the “AVLS OFF?” message is displayed with a beeping sound. When you select “ON,” proceed to step 4.



3. Press  or  to select “Yes,” and then press .
- If you want to cancel the setting you have selected, select “No” in this step.
4. Press  STOP to exit the menu mode.

Note

- If you play back files at volume that exceeds the AVLS-specified level for specified period of time, the following animation will be displayed and “AVLS” in the menu is automatically set to “ON.”



- When you turn off the AVLS function, please be careful not to listen to an excessive volume of the sound.

- When you listen to the sound using headphones for the specific period of time, the AVLS function is automatically turned on even if you set “AVLS” is set to “OFF” in the menu.

[Go to Page Top](#)

Notes on use

4-534-070-11(1)

Copyright 2014 Sony Corporation

IC Recorder

ICD-PX440

[Back](#) | [Back to Top](#)

[Print](#)

Recording sound from the built-in microphones

The following steps are the basic recording procedures using the specified microphone sensitivity and recording mode.

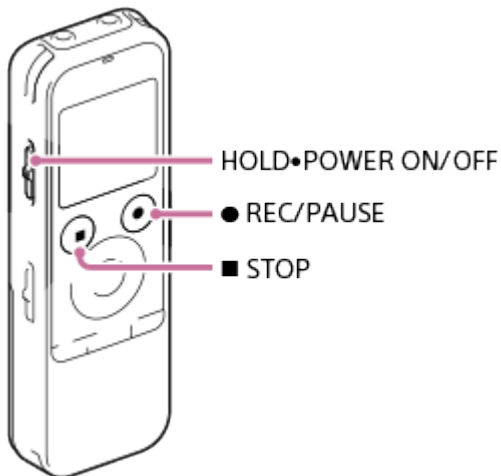

Note

- Noise may be recorded if an object, such as your finger, etc., accidentally rubs or scratches the IC recorder during recording.

Hint

- Before you start recording, we recommend you make a trial recording first, or monitor the recording.
1. Slide the HOLD · POWER ON/OFF switch in the direction of “POWER ON/OFF” to turn on the IC recorder, or towards the center to release the IC recorder from the HOLD status.
The stop mode window appears.



2. Select the desired folder.
3. Place the IC recorder so that the built-in microphones (①) face the direction of the source to be recorded.

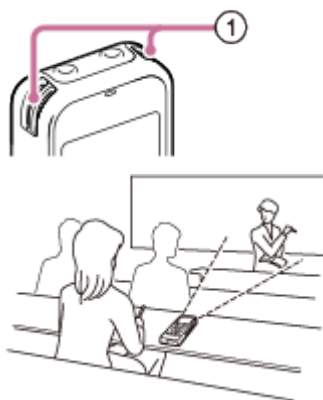

4. Press ● REC/PAUSE in the stop mode.
The operation indicator (②) lights in red.

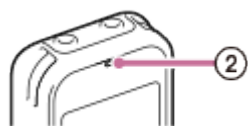

You do not need to press and hold ● REC/PAUSE while recording.
The new file will be automatically recorded as the last file in the current folder.
During recording, the recording level guide (③) is displayed.

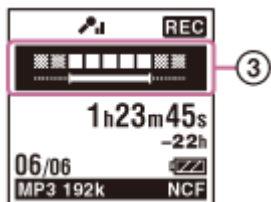

5. Press ■ STOP to stop recording.
The “Accessing...” animation appears and the IC recorder stops at the beginning of the current recording file.

Note

- The IC recorder is recording data and storing it on the memory media when the “Accessing...” animation appears on the display. While the IC recorder is accessing data, do not remove the batteries or connect or disconnect the USB AC adaptor (not supplied). Doing so may damage the data.

[Go to Page Top](#)

Related Topic

- [Monitoring sound while recording](#)
- [Turning the power on](#)

- [Releasing the HOLD function](#)
- [Selecting a folder and a file](#)
- [About the recording level guide](#)
- [Various operations while recording](#)

[Go to Page Top](#)

Notes on use

4-534-070-11(1)

Copyright 2014 Sony Corporation

About the recording level guide

During recording, the recording level guide (①) is displayed.

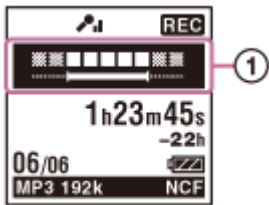

The upper meter shows the current input level. The white bar in the lower meter shows the optimum input level for recording.



Please adjust the orientation of the built-in microphones, the distance from the sound source, the microphone sensitivity, or the “Scene Select” setting so that the upper input level fits within the lower optimum range, as illustrated above.

Hint

- If the white portion of the input level meter is short, we recommend that you place the IC recorder nearer to the sound source or set the microphone sensitivity higher.

[Go to Page Top](#)

Related Topic

- [Recording sound from the built-in microphones](#)

[Go to Page Top](#)

IC Recorder

ICD-PX440

[Back](#) | [Back to Top](#)

[Print](#)

Monitoring sound while recording

If you connect headphones to the  (headphones) jack, you can monitor the recording.



1. Connect headphones to the  (headphones) jack.
2. Press VOL -/+ to adjust the monitoring volume.
Monitoring volume does not affect to the recording level.

[Go to Page Top](#)

Related Topic

- [Recording sound from the built-in microphones](#)

[Go to Page Top](#)

[Notes on use](#)

IC Recorder

ICD-PX440

[Back](#) | [Back to Top](#)

[Print](#)

Various operations while recording

You can perform the following operations while recording.

To pause recording

Press ● REC/PAUSE.

During recording pause, the operation indicator flashes in red and “” begins to flash in the display window. An hour after you pause recording, recording pause is automatically released and the IC recorder enters the stop mode.

To release pause and resume recording

Press ● REC/PAUSE again.

Recording resumes from that point. (To stop recording after pausing recording, press ■ STOP.)

To review the current recording instantly

Press ►.

Recording stops and playback starts from the beginning of the file just recorded.

To review during recording

Press and hold ◀◀ during recording or recording pause.

Recording stops and you can search backwards while listening to fast playback sound. After you release ◀◀, playback starts from that point.

Hint

- You can make new folders or erase unwanted folders using the Sound Organizer software.

[Go to Page Top](#)

Related Topic

- [Recording sound from the built-in microphones](#)

- [The Sound Organizer window \(for Windows only\)](#)

[Go to Page Top](#)

[Notes on use](#)

4-534-070-11(1)

Copyright 2014 Sony Corporation

IC Recorder

ICD-PX440

[Back](#) | [Back to Top](#)

[Print](#)



Selecting a recording scene for each situation

According to various recording scene, you can change the items for recording, such as “REC Mode,” “Mic Sensitivity,” etc., to the recommended settings in bulk (Scene Select).

You can store your favorite recording settings for “My Scene 1” and “My Scene 2.” Set “Scene Select” to “OFF” first, change the recording settings (“REC Mode,” “Mic Sensitivity,” “Recording Filter” and “VOR”) to your desired settings, and then perform the following operations.

1. In the stop mode, select MENU - the  tab - “Scene Select,” and then press .



2. Press  or  to select a scene you want, and then press .



3. Press  STOP to exit the menu mode.

Descriptions of menu items

You can select one of the menu items available.

OFF:

To turn off the “Scene Select” function.

(Initial setting)

Meeting:

To record in a variety of situations, such as recording in a spacious conference room.

Lecture:

To record seminars or lectures.

 **Voice Notes:**

To record dictation with a microphone in front of your mouth.

 **Interview:**

To record human voice at a distance of 1 to 2 meters (40 in. to 80 in.).

 **Music:**

To record chorus lessons or musical instruments, such as an acoustic guitar, a piano, or a violin, at a distance of 2 to 3 meters (80 in. to 120 in.).

 **My Scene 1:**

Use to keep your favorite recording settings, such as “REC Mode” and “Mic Sensitivity.”

 **My Scene 2:**

Use to keep your favorite recording settings, such as “REC Mode” and “Mic Sensitivity.”

[Go to Page Top](#)

Related Topic

- [Default settings for the “Scene Select” menu](#)
- [Registering recording settings in “My Scene”](#)

[Go to Page Top](#)

[Notes on use](#)

4-534-070-11(1)

Copyright 2014 Sony Corporation

IC Recorder

ICD-PX440

[Back](#) | [Back to Top](#)

[Print](#)

Registering recording settings in “My Scene”

You can register recording settings you want to use in “My Scene 1” or “My Scene 2” in the “Scene Select” menu.

1. Set the “Scene Select” menu to “OFF.”



2. Set the following recording menu items to the setting you want to use.
The following recording menu items can be set.
 - REC Mode
 - Mic Sensitivity
 - Recording Filter
 - VOR
3. After you set the recording menu items, select “Scene Select” in the menu, press ▲ or ▼ to select “Copy Current Settings” that appears under “My Scene 1” or “My Scene 2,” and then press ►.
“Copy Current Recording Setting?” appears on the display.
4. Press ▲ or ▼ to select “Execute,” and then press ►.

[Go to Page Top](#)

Related Topic

- [Selecting a recording scene for each situation](#)

- [Default settings for the “Scene Select” menu](#)
- [Selecting the recording mode \(REC Mode\)](#)
- [Selecting the microphone sensitivity \(Mic Sensitivity\)](#)
- [Reducing noise when recording \(Recording Filter\)](#)
- [Starting to record automatically in response to sound – the VOR function](#)

[Go to Page Top](#)

[Notes on use](#)

4-534-070-11(1)

Copyright 2014 Sony Corporation

IC Recorder

ICD-PX440

[Back](#) | [Back to Top](#)

[Print](#)

Tips for better recording

Recording at a meeting

By placing the IC recorder on a handkerchief, etc. substituting for a stand, you can record with clear, low-noise sound, without vibration noise from the desk.

When you use the “Scene Select” function, select “Meeting.”



Recording a voice note

By placing the IC recorder close to one side of your mouth, you can prevent breathing on the built-in microphones, and record with clear sound.

When you use the “Scene Select” function, select “Voice Notes.”

Note

- When you record while holding the IC recorder on your hand, be careful not to record any rustling noises which may be recorded when you touch the IC recorder.



Recording an interview

Place the IC recorder so that the built-in microphones face the interviewee.

When you use the “Scene Select” function, select “Interview.”



Recording a music performance

You can obtain dynamic stereo recording.

When you record a music performance, place the IC recorder close to the musical instruments. If you record a piano performance, for example, make sure not to place the IC recorder on the piano, otherwise the vibration from the piano may be recorded as well.

You can also create your own CDs using the Sound Organizer software.

When you use the “Scene Select” function, select “Music.”

If the sound distortion occur when you place the IC recorder close to a musical instruments, set the “Mic Sensitivity” in the menu to “ Low(Music).” In this way, you can record the sound more clearly.



[Go to Page Top](#)

[Notes on use](#)

4-534-070-11(1)

Copyright 2014 Sony Corporation

IC Recorder

ICD-PX440

[Back](#) | [Back to Top](#)

[Print](#)

Default settings for the “Scene Select” menu

The setting items for the “Scene Select” menu are set as follows by default.

Meeting

REC Mode: MP3 192kbps

Mic Sensitivity:  Medium

VOR: OFF

Recording Filter: NCF(Noise Cut)

Lecture

REC Mode: MP3 192kbps

Mic Sensitivity:  Medium

VOR: OFF

Recording Filter: NCF(Noise Cut)

Voice Notes

REC Mode: MP3 128kbps

Mic Sensitivity:  Low

VOR: OFF

Recording Filter: LCF(Low Cut)

Interview

REC Mode: MP3 128kbps

Mic Sensitivity:  Medium

VOR: OFF

Recording Filter: NCF(Noise Cut)

Music

REC Mode: MP3 192kbps

Mic Sensitivity:  Low (Music)

VOR: OFF

Recording Filter: OFF

My Scene 1

REC Mode: MP3 192kbps
Mic Sensitivity:  Medium
VOR: OFF
Recording Filter: OFF

My Scene 2

REC Mode: MP3 192kbps
Mic Sensitivity:  Medium
VOR: OFF
Recording Filter: OFF

[Go to Page Top](#)

Related Topic

- [Selecting a recording scene for each situation](#)

[Go to Page Top](#)

Notes on use

4-534-070-11(1)

Copyright 2014 Sony Corporation

IC Recorder

ICD-PX440

[Back](#) | [Back to Top](#)

[Print](#)

Adding a new segment to a previously recorded file

When “Add/Overwrite” in the menu is set to “Add,” you can add a new segment to the file being played back. The added segment will be placed after the current file, and will be counted as a part of the file.

Select the file to which you want to add a segment first.

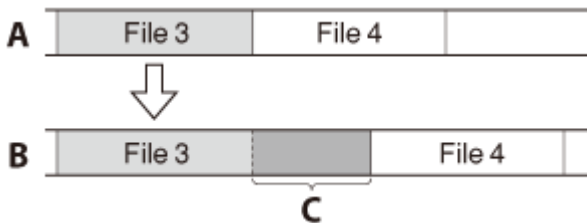

A: During playback of file 3

B: After adding a new segment

C: Added segment

1. In the stop mode, select MENU - the  tab - “Add/Overwrite,” and then press .



2. Press  or  to select “Add,” and then press .



“Add/Overwrite” is set to “OFF” when you purchase the IC recorder.

3. Press  STOP to exit the menu mode.

4. When the file to be added is played back press ● REC/PAUSE.
“Add REC?” will be displayed.
5. While “Add REC?” is displayed, press ● REC/PAUSE.
The recording lamp will turn red.
Then recording starts.
6. To stop recording, press ■ STOP.

Note

- You cannot add a segment when the file has reached the maximum size limit (500 MB).
- You cannot add a segment to an MP3 file that was not recorded using the IC recorder. Moreover, when you edit files using the Sound Organizer software, adding a segment to the files may not be possible.
- The recording mode of an additional recording is the same as the added file.
- If 10 minutes have passed after step 4, you must start the procedure again from step 4.
- You cannot add a new segment to a protected file.

[Go to Page Top](#)

Related Topic

- [Selecting a folder and a file](#)

[Go to Page Top](#)

[Notes on use](#)

4-534-070-11(1)

Copyright 2014 Sony Corporation

Adding an overwrite recording during playback

When “Add/Overwrite” in the menu is set to “Overwrite,” you can add an overwrite recording after a selected point in a recorded file. The part of the file after the selected point is erased. Select the file to which you want to add an overwrite recording first.

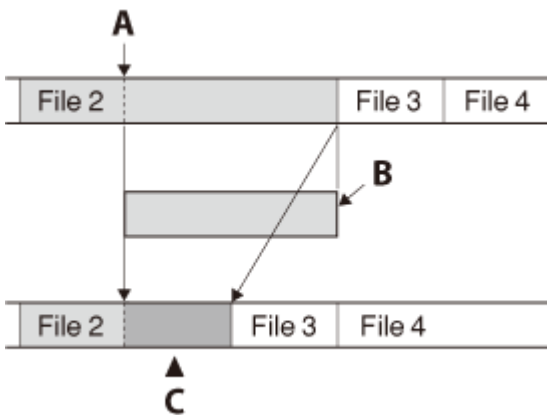

A: The starting point of an overwrite recording

B: The erased part of File 2

C: Added overwrite recording in File 2

1. In the stop mode, select MENU - the  tab - “Add/Overwrite,” and then press .



2. Press  or  to select “Overwrite,” and then press .



“Add/Overwrite” is set to “OFF” when you purchase the IC recorder.

3. Press **■** STOP to exit the menu mode.
4. When the file to be added is played back, press **●** REC/PAUSE at the position where you want to overwrite the file.
“Overwrite REC?” will be displayed.
5. While “Overwrite REC?” is displayed, press **●** REC/PAUSE.
The recording lamp will turn red.
Then recording starts.
6. To stop recording, press **■** STOP.

Note

- You cannot add an overwrite recording to an MP3 file when the file has reached the maximum size limit (500 MB). However, you can add an overwrite recording to a file, even if the file has reached the maximum size limit, when the beginning of the point to the overwritten has not reached the maximum size limit.
- You cannot add an overwrite recording to an MP3 file which was not recorded using the IC recorder. Moreover, when you edit files using the Sound Organizer software, adding an overwrite recording to the files may not be possible.
- The recording mode of an additional overwrite recording is the same as the added file.
- If 10 minutes have passed after step 4, you must start the procedure again from step 4.
- You cannot overwrite a protected file.

[Go to Page Top](#)

Related Topic

- [Selecting a folder and a file](#)

[Go to Page Top](#)

[Notes on use](#)

IC Recorder



ICD-PX440

[Back](#) | [Back to Top](#)





[Print](#)

Starting to record automatically in response to sound – the VOR function

You can set the VOR (Voice Operated Recording) function to “ON,” to make the IC recorder start recording when the IC recorder detects sound, and pause when no sound is heard, eliminating recording during soundless periods.

1. Select MENU - the  tab - “VOR,” and then press .



2. Press  or  to select “ON,” and then press .
- “VOR” is set to “OFF” when you purchase the IC recorder.
3. Press  STOP to exit the menu mode.
4. Press  REC/PAUSE.
- “**VOR REC**” appears in the display window.

The recording pauses when no sound is detected and “**VOR  II**” flashes. When the IC recorder detects sound again, the recording starts again.

Note

- The VOR function is affected by the sound around you. Set “Mic Sensitivity” in the menu according to the recording conditions. If recording is not satisfactory after you have changed the “Mic Sensitivity” setting, or for an important recording, set “VOR” to “OFF” in the menu.
- If you set “VOR” when “Scene Select” is set to other than “OFF,” the “Scene Select” setting selected will be canceled.

Hint

- To cancel the VOR function, set “VOR” to “OFF” in step 2.

Related Topic

- [Using the menu](#)

[Notes on use](#)

4-534-070-11(1)

Copyright 2014 Sony Corporation

IC Recorder

ICD-PX440

[Back](#) | [Back to Top](#)

[Print](#)



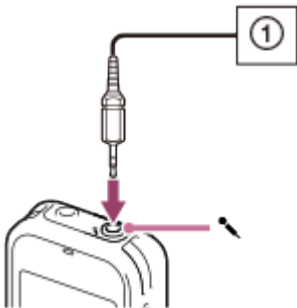

Recording with an external microphone

You can record sound using an externally connected microphone.

1. Connect an external microphone (①) to the  (microphone) jack when the IC recorder is in the stop mode.



“Select Input” appears in the display window. If “Select Input” is not displayed, set it in the menu.

2. Press  or  to select “MIC IN,” and then press .
3. Press  STOP to exit the menu mode.
4. Press  REC/PAUSE to start recording.

The built-in microphones are automatically cut off.

If the input level is not strong enough, adjust the “Mic Sensitivity” setting on the IC recorder.

When a plug in power type microphone is connected, power is automatically supplied to the microphone from the IC recorder.

Hint

- You can use a headphone-type electret condenser microphone to record sound from a telephone or a cell phone. For details on how to make the connection, refer to the operating instructions supplied with the microphone.

[Go to Page Top](#)

Related Topic

- [Selecting the input mode \(Select Input\)](#)

[Go to Page Top](#)

Notes on use

4-534-070-11(1)

Copyright 2014 Sony Corporation

IC Recorder

ICD-PX440

[Back](#) | [Back to Top](#)

[Print](#)

Recording from external equipment

You can make music files without using the computer by recording sound/music from other equipment such as a radio cassette recorder, a tape recorder, etc. connected to the IC recorder.

Hint

- If the input level is not strong enough, connect the headphones jack (minijack, stereo) of other equipment to the  (microphone) jack of the IC recorder and adjust the volume level on the piece of equipment connected to the IC recorder while checking the recording level guide.

1. Connect a piece of external equipment (①) to the  (microphone) jack of the IC recorder when the IC recorder is in the stop mode.

Connect the audio output connector of other equipment to the  (microphone) jack of the IC recorder using an audio connecting cable (not supplied).

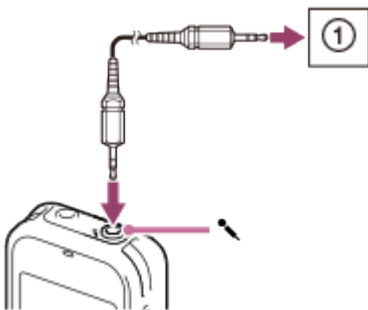

“Select Input” appears in the display window.

If “Select Input” is not displayed, set it in the menu.

2. Press  or  to select “Audio IN,” and then press .

3. Press  STOP to exit the menu mode.

4. Press  REC/PAUSE to start recording.

The built-in microphones are automatically cut off and the sound from the connected piece of equipment is recorded. **REC** lights up in the display.

5. Start playback on the piece of equipment connected to the IC recorder.

Hint

- To stop recording, press ■ STOP.

[Go to Page Top](#)

Related Topic

- [Recording the playback sound of the IC recorder on external equipment](#)
- [Selecting the input mode \(Select Input\)](#)

[Go to Page Top](#)

[Notes on use](#)

4-534-070-11(1)

Copyright 2014 Sony Corporation

IC Recorder



ICD-PX440

[Back](#) | [Back to Top](#)

[Print](#)

Recording the playback sound of the IC recorder on external equipment

You can record the playback sound of the IC recorder with an externally connected equipment. Before you start recording, we recommend you make a trial recording first.

1. Connect an audio connecting cable (not supplied) to the  (headphones) jack of the IC recorder and to the external input terminal of other equipment.
2. Press  on the IC recorder to start playback and at the same time set the connected equipment to the recording mode.
A file from the IC recorder will be recorded on the equipment connected.
3. Press  STOP on the IC recorder and the connected equipment at the same time to stop recording.

[Go to Page Top](#)

Notes on use

4-534-070-11(1)

Copyright 2014 Sony Corporation

IC Recorder

ICD-PX440

[Back](#) | [Back to Top](#)

[Print](#)

Playing back the recorded sound

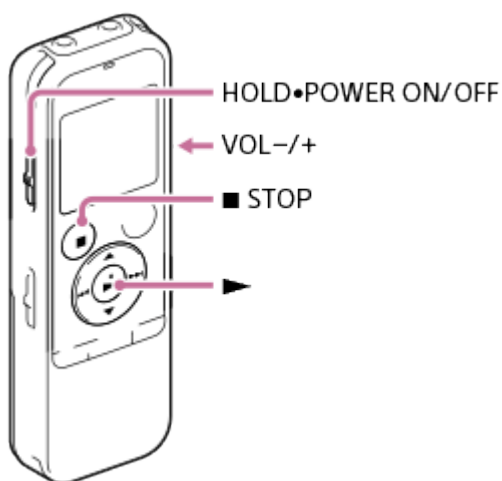

1. Slide the HOLD • POWER ON/OFF switch in the direction of “POWER ON/OFF” to turn on the IC recorder, or towards the center to release the IC recorder from the HOLD status.
The stop mode window appears.
2. Select the desired file to be played back.
If you do not select a file, the file just recorded or played back most recently will be played back.
3. Press ▶.
Playback starts, and the operation indicator will light in green.
4. Press VOL -/+ to adjust the volume.

Note

- For the customers in Europe only:
When “AVLS” is set to “ON” in the menu and the “AVLS” indicator is displayed, you cannot adjust the volume to a level that exceeds the AVLS-specified level. If you want to turn off the function and play back files at the original volume, use the menu to set “AVLS” to “OFF.”

Hint

- Press ■ STOP to stop playback.

[Go to Page Top](#)**Related Topic**

- [Turning the power on](#)
- [Releasing the HOLD function](#)
- [Selecting a folder and a file](#)
- [Various operations while playing](#)

[Go to Page Top](#)**Notes on use**

4-534-070-11(1)

Copyright 2014 Sony Corporation

IC Recorder

ICD-PX440

[Back](#) | [Back to Top](#)

[Print](#)

Various operations while playing

You can perform the following operations while the IC recorder is playing.

To stop at the current position (Playback Pause function)

Press . To resume playback from that point, press  again.

To go back to the beginning of the current file

Press  once.

When a track mark is set, you can move the playback position backward to the track mark before the current point. (The IC recorder acts as described here when the “Easy Search” function is set to “OFF.”)

To go back to previous files

Press  repeatedly.

(During the stop mode, keep the button pressed to go back the files continuously. In the continuous searching mode, the IC recorder does not locate track marks.)

To skip to the next file

Press  once.

When a track mark is set, you can move the playback position forward to the track mark after the current point. (The IC recorder acts as described here when the “Easy Search” function is set to “OFF.”)

To skip to the succeeding files

Press  repeatedly.

(During the stop mode, keep the button pressed to skip the files continuously. In the continuous searching mode, the IC recorder does not locate track marks.)

[Go to Page Top](#)

Related Topic

- [Playing back the recorded sound](#)

- [Adding a track mark](#)
- [Searching the desired point quickly \(Easy Search\)](#)

[Go to Page Top](#)

[Notes on use](#)

4-534-070-11(1)

Copyright 2014 Sony Corporation

IC Recorder

ICD-PX440

[Back](#) | [Back to Top](#)





[Print](#)

Reducing noise in the playback sound and making the human voice clearer – the noise cut function

The noise cut function reduces ambient noise other than the human voice, which makes the human voice clearer when you listen to the playback sound.

1. In the stop or playback mode, select MENU - the  tab - “Noise Cut,” and then press .



2. Press  or  to select “Auto,” “Maximum,” or “Medium,” and then press .
3. Press  STOP to exit the menu mode.

Descriptions of menu items

You can select one of the menu items available.

Auto:

The noise cut level will be adjusted automatically according to the surrounding sound level.

Maximum:

The noise cut level will be higher.

Medium:

The noise cut level will be lowered. Select this item when you cannot hear the sound clearly by setting the noise cut function to “Maximum.”

OFF:

The noise cut function will be turned off.

(Initial setting)

Note

- When playing back a music file in good sound quality, make sure to set the noise cut function to “OFF.”
- When playing back files using the built-in speaker, the noise cut function does not work.

- When the noise cut function is set to “Auto,” the IC recorder adjusts the noise cut level automatically, however, when you play a file recorded with the “Scene Select” menu set to “Meeting,” “Lecture,” “Voice Notes,” or “Interview,” the noise cut function will switch to “Medium” automatically.

[Go to Page Top](#)

Notes on use

4-534-070-11(1)

Copyright 2014 Sony Corporation

IC Recorder

ICD-PX440

[Back](#) | [Back to Top](#)

[Print](#)

Adjusting the playback speed – the DPC (Digital Pitch Control) function

You can adjust the playback speed in a range from 0.50 times to 2.00 times. The file is played back in natural tones by means of a digital processing function.

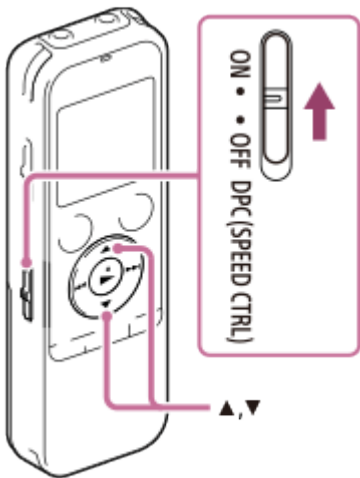

1. Slide the DPC (SPEED CTRL) switch to “ON.”
2. During playback, press ▲ or ▼ to adjust the playback speed.
The speed decreases by 0.05 times (from $\times 0.50$ to $\times 1.00$).
The speed increases by 0.10 times (from $\times 1.00$ to $\times 2.00$).
When you press and hold each button, you can change the speed continuously.
The playback speed is set to “ $\times 0.70$ ” when you purchase the IC recorder.

Hint

- To resume normal playback speed, slide the DPC (SPEED CTRL) switch to “OFF.”

[Go to Page Top](#)



IC Recorder

ICD-PX440





[Back](#) | [Back to Top](#)

[Print](#)

Playing back all files in a folder continuously - the continuous play

1. In the stop or playback mode, select MENU - the  tab - "Continuous Play," and then press .



2. Press  or  to select "ON" or "OFF," and then press .
3. Press  STOP to exit the menu mode.

Descriptions of menu items

You can select one of the menu items available.

ON:

Files in one folder are played back continuously.

(Initial setting)

OFF:

A file is played back.

[Go to Page Top](#)

Related Topic

- [Playing back a file repeatedly](#)
- [Playing back a specified section repeatedly \(A-B repeat\)](#)



IC Recorder

ICD-PX440

[Back](#) | [Back to Top](#)[Print](#)

Playing back a file repeatedly

1. During playback, press and hold until " 1" appears.
The selected file will be played back repeatedly.

Hint

- To cancel repeat playback and change back to the normal playback, press again.

[Go to Page Top](#)

Related Topic

- [Playing back all files in a folder continuously - the continuous play](#)
- [Playing back a specified section repeatedly \(A-B repeat\)](#)

[Go to Page Top](#)

Notes on use

4-534-070-11(1)

Copyright 2014 Sony Corporation

IC Recorder



ICD-PX440

[Back](#) | [Back to Top](#)



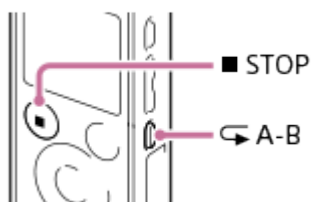

[Print](#)

Playing back a specified section repeatedly (A-B repeat)



1. During playback, press  A-B to specify the starting point A.
“A-B B?” is displayed.
2. Press  A-B again to specify the finishing point B.
“ A-B” is displayed and the specified section is played back repeatedly.

Hint

- To cancel A-B repeat playback and change back to the normal playback, press  A-B again.
- To stop A-B repeat playback, press  STOP. The IC recorder is stopped but the A-B repeat setting remains. Press  STOP again to release the A-B repeat setting.
- To change the segment specified for A-B repeat playback, press  A-B again during the A-B repeat playback. The play mode changes to the normal playback. Perform the steps 1 and 2 again to re-set the range of the A-B repeat playback.

[Go to Page Top](#)

Related Topic

- [Playing back all files in a folder continuously - the continuous play](#)
- [Playing back a file repeatedly](#)

IC Recorder

ICD-PX440

[Back](#) | [Back to Top](#)[Print](#)

Listening with better sound quality

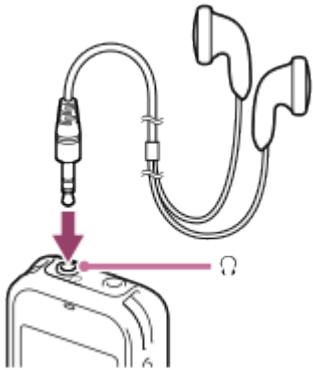

- Listening to the sound with headphones:
Connect headphones to the Ω (headphones) jack. The built-in speaker will be automatically disconnected.
- Listening to the sound from an external speaker:
Connect an active or passive speaker (not supplied) to the Ω (headphones) jack. The built-in speaker will be automatically disconnected.

[Go to Page Top](#)

Notes on use

4-534-070-11(1)

Copyright 2014 Sony Corporation

IC Recorder

ICD-PX440

[Back](#) | [Back to Top](#)

[Print](#)

Searching forward/backward during playback (Cue/Review)

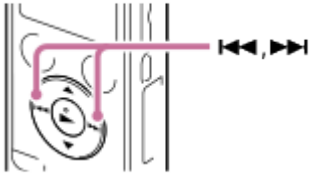

- To search forward (Cue):
Press and hold **▶▶** during playback and release it at the point you wish to resume playback.
- To search backward (Review):
Press and hold **◀◀** during playback and release it at the point you wish to resume playback.

The IC recorder searches at slow speed with playback sound. This is useful to check one word forward or back. Then, if you press and hold the button, the IC recorder starts to search at higher speed.

When files are played back or searched to the end of the last file

- When you play back or fast play back to the end of the last file, "FILE END" lights up for approximately 5 seconds.
- When "FILE END" and the operation indicator go off, the IC recorder will stop at the beginning of the last file.
- If you press and hold **◀◀** while "FILE END" is lit, the playback point is moved back rapidly in the file, and normal playback will start at the point you release the button.

[Go to Page Top](#)

[Notes on use](#)

4-534-070-11(1)

Copyright 2014 Sony Corporation

IC Recorder



ICD-PX440

[Back](#) | [Back to Top](#)





[Print](#)

Searching the desired point quickly (Easy Search)

The Easy Search function allows you to quickly locate the point at which you wish to start playback.

1. In the stop or playback mode, select MENU - the  tab - "Easy Search," and then press .





2. Press  or  to select "ON," and then press .
3. Press  STOP to exit the menu mode.



Descriptions of menu items

You can select one of the menu items available.

ON:

You can go back approx. 3 seconds by pressing  once, or advance approx. 10 seconds by pressing  once. This function is useful when attempting to locate desired point in a long recording.

OFF:

The easy search function does not work. By pressing  or , you can move the playback position forward or backward.

(Initial setting)

[Go to Page Top](#)

[Notes on use](#)

IC Recorder



ICD-PX440

[Back](#) | [Back to Top](#)

[Print](#)

Selecting a recording date from the calendar and playing back

You can play back a file recorded using the IC recorder by searching for it from the calendar.

1. In the stop mode, select MENU - the  tab - "Calendar," and then press .





The calendar appears after the "Accessing..." animation, and the current date will be selected.

2. Press  or  to select a date, and then press .

The underline is displayed at the date where a recorded file exists.



You can move to the previous week or the following week of the date by pressing  or . When you press and hold each button, you can move continuously through the dates or the weeks.

3. Press  or  to select a file, and then press .

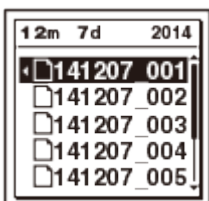

A confirmation message appears, and the file you selected will be played back.

4. Press  or  to select "Enter," and then press .

The file will be played back.

You can return to the previous window by selecting “Back.”

5. Press ■ STOP to stop playback.

Note

- You need to set the clock in advance to select a recording date from the calendar and play back a file.
- If you specify a date where a recorded file does not exist, “No File” will be displayed. Select a date where a recorded file exists.
- You can search for and play back only the files in the recordable folder that contains files recorded with the IC recorder. For details, see “[Structure of folders and files.](#)”

Hint

- To cancel the selection of a recording date from the calendar and the accompanying playback, press ■ STOP before step 4.

[Go to Page Top](#)

Related Topic

- [Setting the clock](#)
- [Setting the clock using the menu](#)
- [Structure of folders and files](#)

[Go to Page Top](#)

Notes on use

4-534-070-11(1)

Copyright 2014 Sony Corporation

IC Recorder



ICD-PX440

[Back](#) | [Back to Top](#)





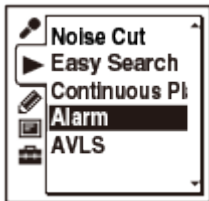

[Print](#)

Playing back a file at a desired time with an alarm









You can sound an alarm and start playback of a selected file at a desired time. You can have a file played back on a specified date, once every week, or at the same time every day. You can set an alarm for a file.

1. Select the file you want to play back with an alarm.
2. Enter the alarm setting mode.
 - i. In the stop mode, select MENU - the  tab - "Alarm," and then press .



- ii. Press  or  to select "ON," and then press .
3. Set the alarm date and time.
 - i. Press  or  to select "Date," a day of the week, or "Daily," and then press .
 - ii. Do one of the following operations.

When you select "Date," set the year, month, day, hour, and minute in sequence, as described in "[Setting the clock.](#)"

When you select a day of the week or "Daily," press  or  to set the hour, and then press . Press  or  to set the minute, and then press .
4. Press  or  to select a favorite alarm pattern, and then press .



"Executing..." is displayed.

5. Press **■** STOP to exit the menu mode.

The setting process is finished and “(●)” (alarm indicator) appears in the display window.

When the set date and time comes, the IC recorder is automatically turned on and “ALARM” is displayed in the display window. Then the alarm and the selected file will be played back using the selected alarm pattern. When the playback ends, the IC recorder will stop automatically. (When the alarm pattern is set to “Beep&Play” or “Play,” the IC recorder will stop at the beginning of the selected file.)

Descriptions of the alarm pattern

You can select one of the menu items available.

Beep&Play:

The selected file is played back after the alarm sounds.

Beep:

Only the alarm sounds.

Play:

Only the selected file is played back.

Note

- An alarm will not sound during recording. The alarm will start playing after you stop the recording.
- You cannot select a podcast file or a file stored on a memory card for the alarm sound.

Hint

- To change the alarm setting, select the file you want to change its alarm setting, and then follow steps 2 through 5.
- To cancel the alarm setting, follow steps 1 and 2. In step 2, select “OFF” (instead of “ON”) and press **▶**. The alarm will be canceled and the alarm indicator will disappear from the display window.
- To stop the alarm playback, press any button other than VOL **-/+** while the alarm sound is heard. If the HOLD function is activated, you can stop the alarm playback by pressing any button.

[Go to Page Top](#)

Related Topic

- [Setting the clock](#)

[Go to Page Top](#)

Notes on use

4-534-070-11(1)

Copyright 2014 Sony Corporation

IC Recorder

ICD-PX440

[Back](#) | [Back to Top](#)

[Print](#)

Erasing a file

You can select a file and erase it.

Note

- Once a file has been erased, you cannot retrieve it.

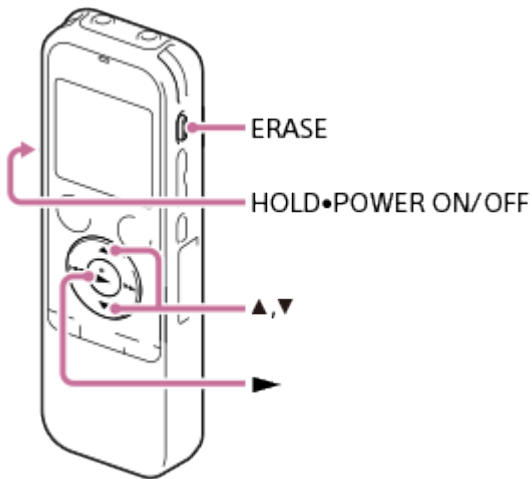

1. Slide the HOLD • POWER ON/OFF switch in the direction of “POWER ON/OFF” to turn on the IC recorder, or towards the center to release the IC recorder from the HOLD status.
The stop mode window appears.
2. Select the file you want to erase when the IC recorder is in the stop or playback mode.
3. Press ERASE.
“Erase?” appears and the specified file is played back for confirmation.
4. Press ▲ or ▼ to select “Execute.”



5. Press ►.

The “Erasing...” animation appears in the display window and the selected file will be erased.

When a file is erased, the remaining files will advance so that there will be no space between files.

Note

- You cannot erase a protected file. To erase the file, release the protection first, and then erase the file.

Hint

- To cancel erasing, select “Cancel” in step 4, and then press ►.
- To erase a part of a file, divide the file into two files first, and then proceed with steps 3 through 5.

[Go to Page Top](#)

Related Topic

- [Turning the power on](#)
- [Releasing the HOLD function](#)
- [Selecting a folder and a file](#)
- [Dividing a file at the current position](#)
- [Protecting a file](#)

[Go to Page Top](#)

Notes on use

4-534-070-11(1)

Copyright 2014 Sony Corporation

IC Recorder

ICD-PX440



[Back](#) | [Back to Top](#)

[Print](#)

Erasing all files in a folder





You can erase all files in the selected folder.

Press FOLDER to return to the folder window before erasing the files and select a folder from which all files are to be erased, and then go to the menu window.

1. In the stop mode, select the folder containing the files you want to erase.
2. Select MENU - the  tab - "Erase All," and then press .



"Erase All Files in the Folder?" appears on the display.

3. Press  or  to select "Execute," and then press .
- The "Erasing..." animation appears in the display window and all files in the selected folder will be erased.
4. Press  STOP to exit the menu mode.

Note

- You cannot erase a protected file. To erase the file, release the protection first, and then erase the file.

Hint

- To cancel erasing, select "Cancel" in step 3, and then press .

[Go to Page Top](#)

- [Protecting a file](#)
- [Selecting a folder and a file](#)
- [Erasing a file](#)

[Go to Page Top](#)

Notes on use

4-534-070-11(1)

Copyright 2014 Sony Corporation

IC Recorder



ICD-PX440

[Back](#) | [Back to Top](#)









[Print](#)

Moving a file to a different folder

Moves the selected file to the selected folder.

1. Select the file you want to move.
2. In the stop mode, select MENU - the  tab - “Move File,” and then press .



3. Press , press  or  to select the  tab or the  tab, and then press .
4. Press  or  to select the folder that you want to move the file into, and then press .



“Moving File...” animation appears and the file is moved to the last position in the destination folder. When you move a file to another folder, the original file in the previous folder will be erased.

5. Press  STOP to exit the menu mode.

Note

- You cannot move a protected file. To move the file, release the protection first, and then move the file.
- You cannot move podcast files.

Hint

- To cancel moving the file, press  STOP before step 4.

Related Topic

- [Protecting a file](#)
- [Selecting a folder and a file](#)

Notes on use

4-534-070-11(1)

Copyright 2014 Sony Corporation

IC Recorder

ICD-PX440

[Back](#) | [Back to Top](#)



[Print](#)

Copying a file to the other memory

You can copy the selected file from the built-in memory to the desired folder on a memory card, or from a memory card to the desired folder on the built-in memory. This function is useful in saving a backup. Before starting the operation, insert a memory card to be used for copying into the memory card slot.







1. Select the file you want to copy.



When you want to copy a file from a memory card to the built-in memory, set the source memory media to “Memory Card.”

2. Select MENU - the  tab - “File Copy,” and then press .



The “Copy to Memory Card Select Folder” or the “Copy to Built-In Memory Select Folder” animation appears and the folder selection window is displayed.

3. Press , press  or  to select the  tab or the  tab, and then press .

4. Press  or  to select the folder that you want to copy the file into, and then press .

The “Copying...” animation appears and the file is copied as the last file in the destination folder. A file will be copied with the identical file name.

5. Press  STOP to exit the menu mode.

Note

- You cannot copy podcast files.

Hint

- To cancel the copy operation, press  STOP before step 4.

- To cancel the copy operation during copying, press ■ STOP while the “Copying...” animation is displayed in step 4.

[Go to Page Top](#)

Related Topic

- [Selecting the memory](#)
- [Inserting a memory card](#)

[Go to Page Top](#)

Notes on use

4-534-070-11(1)

Copyright 2014 Sony Corporation

IC Recorder

ICD-PX440

[Back](#) | [Back to Top](#)

[Print](#)

Adding a track mark

You can add a track mark at a point at which you would like to divide a file later or locate during playback. You can add a maximum of 98 track marks to each file.

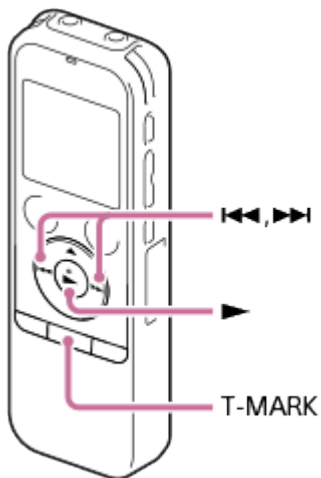

1. During recording, playing back, or recording pausing, press T-MARK at the position you want to add a track mark. The  (track mark) indicator flashes three times, and a track mark is added.



Note

- You cannot add track marks to a protected file. To add track marks to the file, release the protection first, and then add the track marks.
- You cannot add track marks to music files or podcast files.

Hint

- To locate a track mark and start playback at the track mark, press ◀◀ or ▶▶ in the stop mode. When the 🚩 (Track mark) indicator flashes once, press ▶.

[Go to Page Top](#)

Related Topic

- [Protecting a file](#)

[Go to Page Top](#)

Notes on use

4-534-070-11(1)

Copyright 2014 Sony Corporation

IC Recorder

ICD-PX440

[Back](#) | [Back to Top](#)

[Print](#)

Erasing a track mark

You can erase the track mark that is located at just before the current position.

1. Stop at a position after the track mark you would like to erase.
2. Select MENU - the tab - “Erase Track Mark,” and then press .



“Erase Track Mark?” appears on the display.

3. Press or to select “Execute,” and then press .
- The “Erasing...” animation appears in the display window and the selected track mark will be erased.

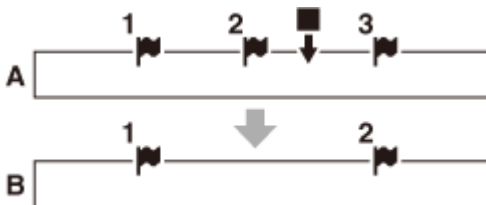

- A. Before erasing a track mark: is the stop position.
- B. After erasing a track mark: The track mark just before the stop position will be erased.

4. Press STOP to exit the menu mode.

Note

- You cannot erase track marks from a protected file. To erase track marks from the file, release the protection first, and then erase the track marks.

Hint

To cancel erasing, select “Cancel” in step 3, and then press ►.

[Go to Page Top](#)

Related Topic

- [Protecting a file](#)

[Go to Page Top](#)

Notes on use

4-534-070-11(1)

Copyright 2014 Sony Corporation

IC Recorder



ICD-PX440

[Back](#) | [Back to Top](#)

[Print](#)





Erasing all the track marks in the selected file at one time

You can erase all the track marks of the selected file.

1. Select a file from which you want to erase the track marks.
2. Select MENU - the  tab - “Erase All Track Marks,” and then press .



“Erase All Track Marks?” appears on the display.

3. Press  or  to select “Execute,” and then press .
- The “Erasing...” animation appears in the display window and all the track marks will be erased at one time.
4. Press  STOP to exit the menu mode.

Note

- You cannot erase track marks from a protected file. To erase track marks from the file, release the protection first, and then erase the track marks.

Hint

- To cancel erasing, select “Cancel” in step 3, and then press .

[Go to Page Top](#)

Related Topic

- [Protecting a file](#)

[Go to Page Top](#)

Notes on use

4-534-070-11(1)

Copyright 2014 Sony Corporation

IC Recorder
ICD-PX440

[Back](#) | [Back to Top](#)

[Print](#)

Dividing a file at the current position

You can divide a file in the stop mode, so that the file is divided into two parts and new file numbers are added to the divided file names. By dividing a file, you can easily find the point from which you want to play back when you make a long recording such as at a meeting. You can divide a file until the total number of files in the folder reaches the maximum number allowed.

1. Stop the file at the position where you want to divide a file.
2. Select MENU - the tab - “Divide Current Position,” and then press .



“Divide?” appears on the display.

3. Press or to select “Execute,” and then press .

The “Dividing...” animation appears, and the divided files will be suffixed with a sequential number (“_1” for the original file, and “_2” for the new file).

A	File 1	File 2	File 3
B	File 1	File 2_1	File 2_2
			File 3

A. Before dividing a file: is the position you want to divide.

B. After dividing a file: A suffix made up of a sequential number (“_1,” “_2”) is added to the file names of the divided files.

4. Press STOP to exit the menu mode.

Note

- You cannot divide a protected file. To divide the file, release the protection first.
- You cannot divide music files or podcast files.

Hint

- To cancel dividing, select “Cancel” in step 3, and then press ►.

[Go to Page Top](#)

Related Topic

- [Protecting a file](#)

[Go to Page Top](#)

[Notes on use](#)

4-534-070-11(1)

Copyright 2014 Sony Corporation

Dividing a file at all the track mark positions

You can divide a file at all the track mark positions.

1. Select the file you want to divide.
2. In the stop mode, select MENU - the tab - “Divide All Track Marks,” and then press .



“Divide All Track Marks?” appears on the display.

3. Press or to select “Execute,” and then press .
- The “Dividing...” animation appears, and the file is divided at all the track mark positions. All the existing track marks in the files will be erased.
- A suffix made up of a sequential number (from “_01” to “_99”) is added to each of the divided files.

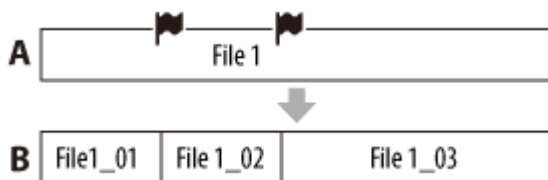

- A. Before dividing a file: are track marks
- B. After dividing a file: A file is divided at all the track marks, and a suffix made up of a sequential number (“_01,” “_02,” “_03”) is added to the file names of the divided files.

4. Press STOP to exit the menu mode.

Note

- You cannot divide a protected file. To divide the file, release the protection first.

You cannot divide music files or podcast files.

Hint

- To cancel dividing, select “Cancel” in step 3, and then press ►.
- To cancel dividing while a file is being divided, press ■ STOP while the “Dividing...” animation is displayed.

[Go to Page Top](#)

Related Topic

- [Protecting a file](#)

[Go to Page Top](#)

[Notes on use](#)

4-534-070-11(1)

Copyright 2014 Sony Corporation

IC Recorder





ICD-PX440

[Back](#) | [Back to Top](#)

[Print](#)





Protecting a file

To prevent a file from being accidentally erased or edited, you can protect an important file. A protected file is marked with the  (protect) indicator and is regarded as a read-only file you cannot erase or edit.

1. Display the file which you want to protect from the  tab or the  tab.
2. In the stop mode, select MENU - the  tab - “Protect,” and then press .



“Set Protection?” appears on the display.

3. Press  or  to select “Execute,” and then press .
- The file is protected. A protected file is marked with the  (protect) indicator.
4. Press  STOP to exit the menu mode.

Note

- You cannot protect podcast files.

Hint

- To release protection, select the protected file, and then proceed with steps 2 through 4. In this case, “Erase Protection?” will be displayed in step 2.
- To cancel setting the protection, select “Cancel” in step 3, and then press .

[Go to Page Top](#)

IC Recorder

ICD-PX440

[Back](#) | [Back to Top](#)



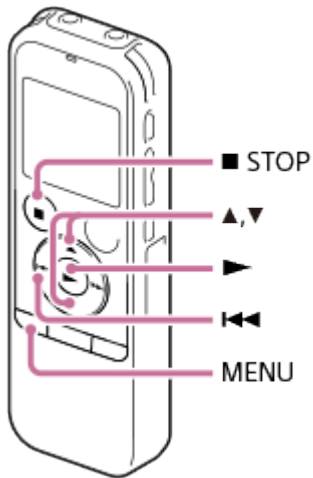

[Print](#)

Using the menu



1. Press MENU to enter the menu mode.
The menu mode window will be displayed.



2. Press ◀◀, press ▲ or ▼ to select the , , , , or  tab, and then press ▶.
3. Press ▲ or ▼ to select the menu item for which you want to make setting, and then press ▶.
4. Press ▲ or ▼ to select the setting that you want to set, and then press ▶.
5. Press ■ STOP to exit the menu mode.

Note

- If you do not press any button for 1 minute, the menu mode is automatically canceled and the window will return to the normal display.

Hint

- To return to the previous window, press **⏪** during menu mode.
- To exit the menu mode, press **■** STOP or MENU.

[Go to Page Top](#)

[Notes on use](#)

4-534-070-11(1)

Copyright 2014 Sony Corporation

IC Recorder

ICD-PX440

[Back](#) | [Back to Top](#)

[Print](#)

Menu list

The list below shows the menu items in each tab and in which operation mode the IC recorder can make changes to the menus.

Menu items in the (Recording) tab

- Scene Select: Stop mode
[Selecting a recording scene for each situation](#)
- REC Mode: Stop mode
[Selecting the recording mode \(REC Mode\)](#)
- Mic Sensitivity: Stop mode, Recording mode
[Selecting the microphone sensitivity \(Mic Sensitivity\)](#)
- Recording Filter: Stop mode, Recording mode
[Reducing noise when recording \(Recording Filter\)](#)
- Add/Overwrite: Stop mode
[Adding a new segment to a previously recorded file](#)
[Adding an overwrite recording during playback](#)
- VOR: Stop mode, Recording mode
[Starting to record automatically in response to sound – the VOR function](#)
- Select Input: Stop mode
[Selecting the input mode \(Select Input\)](#)

Menu items in the (Playback) tab

- Noise Cut: Stop mode, Playback mode
[Reducing noise in the playback sound and making the human voice clearer – the noise cut function](#)
- Easy Search: Stop mode, Playback mode
[Searching the desired point quickly \(Easy Search\)](#)
- Continuous Play: Stop mode, Playback mode
[Playing back all files in a folder continuously - the continuous play](#)
- Alarm: Stop mode
[Playing back a file at a desired time with an alarm](#)

- AVLS (*): Stop mode, Playback mode
[Turning the AVLS function on or off](#)

Menu items in the (Edit) tab

- Protect: Stop mode
[Protecting a file](#)
- Divide Current Position: Stop mode
[Dividing a file at the current position](#)
- Move File: Stop mode
[Moving a file to a different folder](#)
- File Copy: Stop mode
[Copying a file to the other memory](#)
- Erase Track Mark: Stop mode
[Erasing a track mark](#)
- Erase All Track Marks: Stop mode
[Erasing all the track marks in the selected file at one time](#)
- Divide All Track Marks: Stop mode
[Dividing a file at all the track mark positions](#)
- Erase All: Stop mode
[Erasing all files in a folder](#)

Menu items in the (Display) tab

- Calendar: Stop mode
[Selecting a recording date from the calendar and playing back](#)
- Display: Stop mode, Playback mode, Recording mode
[Selecting the display mode \(Display\)](#)
- LED: Stop mode
[Turning the operation indicator on or off \(LED\)](#)

Menu items in the (IC recorder setting) tab

- Select Memory: Stop mode
[Selecting the memory using the menu \(Select Memory\)](#)
- Language: Stop mode
[Setting the display language](#)
- Date&Time: Stop mode
[Setting the clock using the menu](#)
- Time Display: Stop mode
[Selecting the clock display \(Time Display\)](#)
- Beep: Stop mode
[Turning the beep sound on or off \(Beep\)](#)
- Auto Power Off: Stop mode
[Setting the time period for the IC recorder to turn off \(Auto Power Off\)](#)
- Reset All Settings: Stop mode
[Resetting all menu items to the default setting \(Reset All Settings\)](#)

- Format: Stop mode
[Formatting the memory \(Format\)](#)
- System Information: Stop mode
[Checking the system information \(System Information\)](#)

* For the European models only

[Go to Page Top](#)

Notes on use

4-534-070-11(1)

Copyright 2014 Sony Corporation

IC Recorder

ICD-PX440

[Back](#) | [Back to Top](#)





[Print](#)

Selecting the recording mode (REC Mode)

You can set the recording mode for the files to be recorded. Set this menu item before you start recording.

1. In the stop mode, select MENU - the  tab - "REC Mode," and then press .



2. Press  or  to select the desired recording mode, and then press .
3. Press  STOP to exit the menu mode.

Descriptions of menu items

You can select one of the menu items available.

MP3 192kbps:

MP3 (compressed) in stereo standard-quality recording mode
(Initial setting)

MP3 128kbps:

MP3 (compressed) in long play stereo recording mode

MP3 48kbps(MONO):

MP3 (compressed) in monaural standard recording mode

MP3 8kbps(MONO):

MP3 (compressed) in long play monaural recording mode

Note

- If you set "REC mode" when "Scene Select" is set to other than "OFF," the "Scene Select" setting will be canceled.

[Go to Page Top](#)

IC Recorder

ICD-PX440

[Back](#) | [Back to Top](#)





[Print](#)

Selecting the microphone sensitivity (Mic Sensitivity)

You can set the microphone sensitivity for the built-in microphone. Set this menu item before you start recording.

1. In the stop or recording mode, select MENU - the  tab - "Mic Sensitivity," and then press .



2. Press  or  to select the desired level of the microphone sensitivity, and then press .
3. Press  STOP to exit the menu mode.

Descriptions of menu items

You can select one of the menu items available.

High:

To record a sound far away from the IC recorder or a low sound, such as recording in a spacious room.

Medium:

To record the sound of a normal conversation or meeting, such as recording in a meeting space or during interview.

(Initial setting)

Low:

To record dictation with a microphone in front of your mouth, a sound near the IC recorder, or a loud sound.

High(Music):

To record music played in a large room, such as a musical hall.

Low(Music):

To record music played nearby, such as piano lessons.

Note

- If you set "Mic Sensitivity" when "Scene Select" is set to other than "OFF," the "Scene Select" setting will be canceled.

- The microphone sensitivity is disabled when “Select Input” in the menu is set to “Audio IN.”

[Go to Page Top](#)



Notes on use

4-534-070-11(1)

Copyright 2014 Sony Corporation

Reducing noise when recording (Recording Filter)

You can record with less noise in the recorded sound by using the “Recording Filter” function.

1. In the stop or recording mode, select MENU - the  tab - “Recording Filter,” and then press .



2. Press  or  to select “NCF(Noise Cut)” or “LCF(Low Cut),” and then press .



3. Press  STOP to exit the menu mode.

Descriptions of menu items

You can select one of the menu items available.

NCF(Noise Cut):

In addition to low frequency sounds, the IC recorder cuts the noise of high frequency sounds outside the normal audio range.

LCF(Low Cut):

The IC recorder cuts low frequency noise such as projector machine sound or roaring noise from the wind, etc.

OFF:

Cancels the recording filter function.

(Initial setting)

Note

- When the “Select Input” menu is set to “Audio IN” and you connect other equipment to the  (microphone) jack, the recording filter function does not work.
- If you set “Recording Filter” when “Scene Select” is set to other than “OFF,” the “Scene Select” setting will be canceled.

Hint

- Select “OFF” in step 2 to cancel the recording filter function (“OFF” is the initial setting).

[Go to Page Top](#)

Related Topic

- [Selecting the input mode \(Select Input\)](#)

[Go to Page Top](#)

[Notes on use](#)

4-534-070-11(1)

Copyright 2014 Sony Corporation

IC Recorder

ICD-PX440

[Back](#) | [Back to Top](#)





[Print](#)

Selecting the input mode (Select Input)

You can select the external input to be recorded that is connected to the  (microphone) jack.

1. In the stop mode, select MENU - the  tab - “Select Input,” and then press .



2. Press  or  to select “MIC IN” or “Audio IN,” and then press .
3. Press  STOP to exit the menu mode.

Descriptions of menu items

You can select one of the menu items available.

MIC IN:

Select when you record files using an external microphone.

(Initial setting)

Audio IN:

Select when you record using other equipment.

[Go to Page Top](#)

[Notes on use](#)

4-534-070-11(1)

Copyright 2014 Sony Corporation

IC Recorder



ICD-PX440

[Back](#) | [Back to Top](#)





[Print](#)

Selecting the display mode (Display)

You can set which information to be displayed in the display window.

1. Select MENU - the  tab - "Display," and then press .



2. Press  or  to select the desired display mode, and then press .
3. Press  STOP to exit the menu mode.

Descriptions of menu items

You can select one of the menu items available.

Elapsed Time:

Elapsed playback time of one file
(Initial setting)

Remain Time:

During stop or playback, the remaining time of one file
During recording, the available recording time

REC Date:

Date recorded

REC Time:

Time recorded

[Go to Page Top](#)

IC Recorder

ICD-PX440

[Back](#) | [Back to Top](#)





[Print](#)

Turning the operation indicator on or off (LED)

This setting turns the operation indicator on or off during operation.

1. In the stop mode, select MENU - the  tab - "LED," and then press .



2. Press  or  to select "ON" or "OFF," and then press .
3. Press  STOP to exit the menu mode.

Descriptions of menu items

You can select one of the menu items available.

ON:

During recording or playback, the operation indicator lights or flashes.

(Initial setting)

OFF:

The operation indicator does not light or flash, even during operation.

Note

- When the IC recorder is connected to a computer, the operation indicator lights or flashes even if "LED" is set to "OFF."

[Go to Page Top](#)

IC Recorder

ICD-PX440

[Back](#) | [Back to Top](#)





[Print](#)

Selecting the memory using the menu (Select Memory)

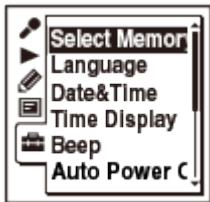
You can select the memory media on which you want to store a file, or which contains the file you want to play, edit, or copy.

1. In the stop mode, select MENU - the  tab - “Select Memory,” and then press .



2. Press  or  to select “Built-In Memory” or “Memory Card,” and then press .
3. Press  STOP to exit the menu mode.

Descriptions of menu items

You can select one of the menu items available.

Built-In Memory:

The built-in memory of the IC recorder is selected.

(Initial setting)

Memory Card:

The memory card inserted in the memory card slot is selected.

Note

- When no memory card is currently inserted in the IC recorder, the built-in memory is automatically selected.

[Go to Page Top](#)

[Notes on use](#)

IC Recorder

ICD-PX440

[Back](#) | [Back to Top](#)





[Print](#)

Selecting the clock display (Time Display)

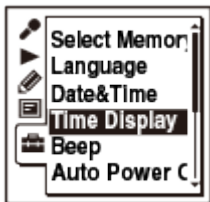
You can select from 12 hour-clock or 24 hour-clock.

1. In the stop mode, select MENU - the  tab - "Time Display," and then press .



2. Press  or  to select the desired menu item, and then press .
3. Press  STOP to exit the menu mode.

Descriptions of menu items

You can select one of the menu items available.

12-Hour:

12:00AM = midnight, 12:00PM = noon

24-Hour:

0:00 = midnight, 12:00 = noon

Note

- The default setting differs depending on the area you purchased your IC recorder.

[Go to Page Top](#)

[Notes on use](#)

IC Recorder

ICD-PX440

[Back](#) | [Back to Top](#)





[Print](#)

Turning the beep sound on or off (Beep)

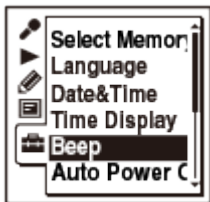
You can turn the operation beep on or off.

1. In the stop mode, select MENU - the  tab - "Beep," and then press .



2. Press  or  to select "ON" or "OFF," and then press .
3. Press  STOP to exit the menu mode.

Descriptions of menu items

You can select one of the menu items available.

ON:

A beep will sound to indicate that an operation has been accepted or an error has occurred.

(Initial setting)

OFF:

No beep sound will be heard.

Note

- The alarm sounds even if you set "Beep" to "OFF" in the menu.

[Go to Page Top](#)

[Notes on use](#)

IC Recorder

ICD-PX440

[Back](#) | [Back to Top](#)





[Print](#)

Setting the time period for the IC recorder to turn off (Auto Power Off)

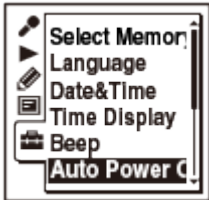
You can set the IC recorder to turn off automatically after a designated length of time. The auto power off function then takes effect when the IC recorder is not used for a specified length of time while in the stop mode.

1. In the stop mode, select MENU - the  tab - “Auto Power Off,” and then press .



2. Press  or  to select the desired menu item, and then press .
3. Press  STOP to exit the menu mode.

Descriptions of menu items

You can select one of the menu items available.

5min:

The IC recorder will be turned off after approx. 5 minutes.

10min:

The IC recorder will be turned off after approx. 10 minutes.
(Initial setting)

30min:

The IC recorder will be turned off after approx. 30 minutes.

60min:

The IC recorder will be turned off after approx. 60 minutes.

OFF:

The IC recorder will not be turned off automatically.

[Go to Page Top](#)

IC Recorder

ICD-PX440

[Back](#) | [Back to Top](#)

[Print](#)

Resetting all menu items to the default setting (Reset All Settings)



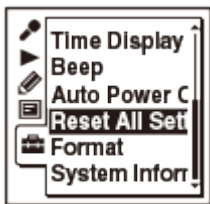

You can re-set all menu items to the default setting.
However, the following menu items cannot be initialized.

- Alarm
- Protect
- Select Memory
- Date&Time

1. In the stop mode, select MENU - the  tab - “Reset All Settings,” and then press .



“Default Value?” appears on the display.

2. Press  or  to select “Execute,” and then press .
3. Press  STOP to exit the menu mode.

Hint

- To cancel the operation, select “Cancel” in step 2.

[Go to Page Top](#)

[Notes on use](#)

IC Recorder

ICD-PX440

[Back](#) | [Back to Top](#)





[Print](#)

Formatting the memory (Format)

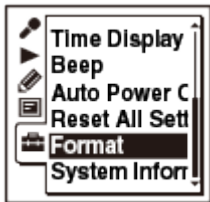
You can format the memory media currently selected (the built-in memory or the memory card), erasing all the data in the memory and resetting the folder structure to its default status.

1. In the stop mode, select MENU - the  tab - “Format,” and then press .



2. Press  or  to select “Execute,” and then press .
- The “Formatting...” animation appears and the memory media will be formatted.
3. Press  STOP to exit the menu mode.

Note

- Use the IC recorder formatting function to format the memory media.
Do not use your computer to format the media.
- Switch the memory media to the one to be formatted before you start the format operation.
- If you format the built-in memory, all data stored there will be erased. (Protected files, the Help Guide and the Sound Organizer software will also be erased.) Note that once the files are erased, you cannot retrieve them.

Hint

- To cancel formatting the memory media, select “Cancel” in step 2.

[Go to Page Top](#)

- [Selecting the memory using the menu \(Select Memory\)](#)

[Go to Page Top](#)

Notes on use

4-534-070-11(1)

Copyright 2014 Sony Corporation

IC Recorder

ICD-PX440

[Back](#) | [Back to Top](#)

[Print](#)

Checking the system information (System Information)

You can check the system information such as the IC recorder model name and the version number of the software. User name can be registered on your IC recorder using the Sound Organizer software.

1. In the stop mode, select MENU - the  tab - “System Information,” and then press .

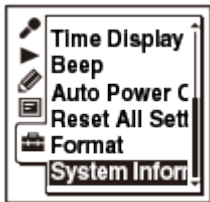

2. Press  STOP to exit the menu mode.

Hint

- You can set the IC recorder so that it will display the user name in a part of the file name by using the Sound Organizer software.

[Go to Page Top](#)

[Notes on use](#)

4-534-070-11(1)

Copyright 2014 Sony Corporation

IC Recorder

ICD-PX440

[Back](#) | [Back to Top](#)

[Print](#)

Connecting the IC recorder to your computer

To exchange files between the IC recorder and your computer, connect the IC recorder to your computer.

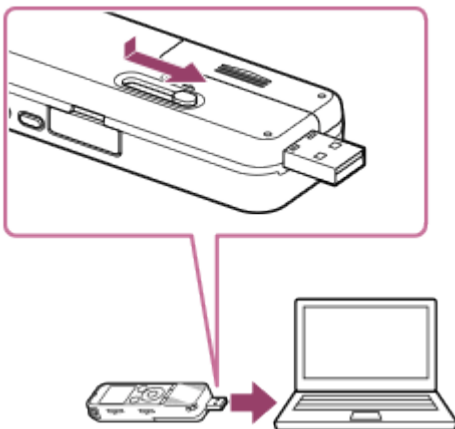

1. Slide the USB slide lever on the back of the IC recorder, and insert the USB connector into the USB port of a running computer.
2. Make sure the IC recorder has been recognized properly.
 - On the Windows screen; open “My Computer” or “Computer,” and make sure that “IC RECORDER” or “MEMORY CARD” has been recognized.
 - On the Mac screen; make sure that an “IC RECORDER” or “MEMORY CARD” drive is displayed on the Finder.

The IC recorder is recognized by the computer as soon as the connection is made. While the IC recorder is connected to the computer, “Connecting” is displayed in the display window of the IC recorder.

If the IC recorder cannot be connected to a computer directly, a dedicated USB connection support cable PC-U004 is available as a repair part for a fee.

For more details, consult your nearest Sony dealer.

You can also use a self-powered USB hub, provided it has a USB logo.

Related Topic

- [Disconnecting the IC recorder from your computer](#)

Notes on use

4-534-070-11(1)

Copyright 2014 Sony Corporation



IC Recorder

ICD-PX440

[Back](#) | [Back to Top](#)[Print](#)

Structure of folders and files

The folders and files are displayed on the computer screen as shown. On a Windows screen using Explorer, and on a Mac screen using Finder, folders and files can be displayed by opening “IC RECORDER” or “MEMORY CARD.”

Built-in memory

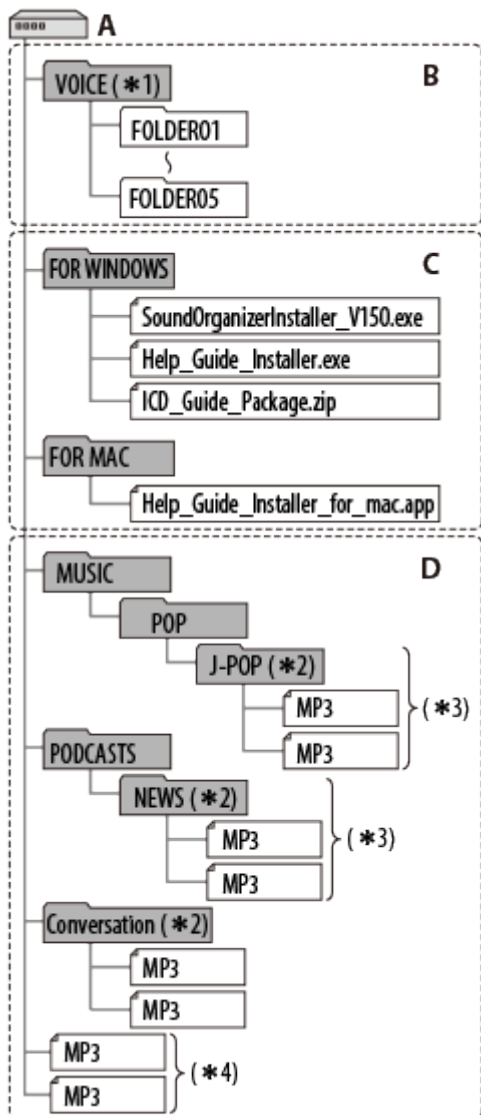

A: IC RECORDER

B: Folder for files recorded using the IC recorder

C: Folder containing installers for the Sound Organizer software, Help Guide, etc.

D: Folder transferred from your computer

*1 Even if a file is transferred directly under the VOICE folder, it will not be displayed on the  tab of the IC recorder. When you transfer a file from your computer to the IC recorder, put the file in the folders under the VOICE folder.

*2 The name of a folder in which music files are stored will be displayed on the IC recorder as it is, so it is convenient if you put an easy-to-remember name on the folder in advance. Folders shown in the illustration are examples of folder names.

*3 The IC recorder can recognize up to 8 levels of folders transferred to the IC recorder.

*4 If you transfer music files separately, they are classified as being in “No Folder.”

Hint

- The title or artist name, etc., registered in the music files, can be displayed on the IC recorder. It is useful if you input the ID3 tag information using the software you use to make the music files on your computer.
- If no title, or artist name has been registered “No Data” will be displayed in the display window of the IC recorder.

Memory Stick Micro™ (M2™)

When connecting the IC recorder with your computer after the destination memory media has been set to “Memory Card,” the structure of folders is different from that when the destination memory media is set to “Built-In Memory.”

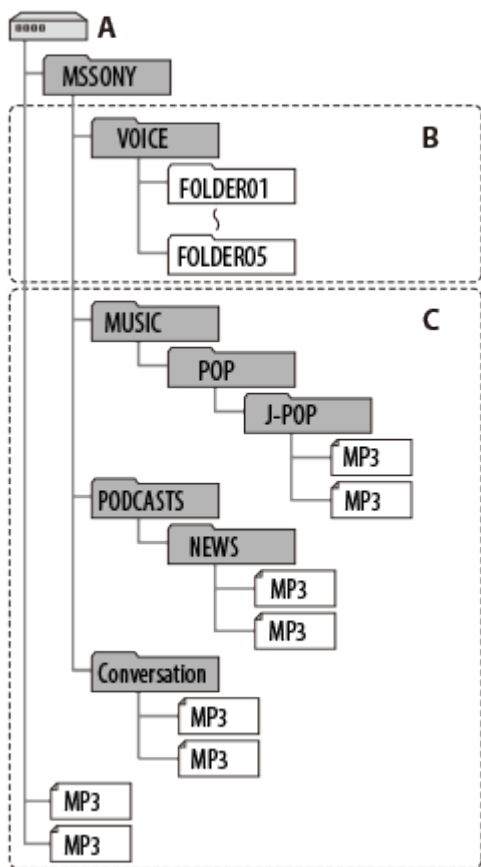

A: MEMORY CARD

B: Folder for files recorded using the IC recorder

C: Folder transferred from your computer

microSD card

When connecting the IC recorder with your computer after the destination memory media has been set to “Memory Card,” the structure of folders is different from that when the destination memory media is set to “Built-In Memory.”

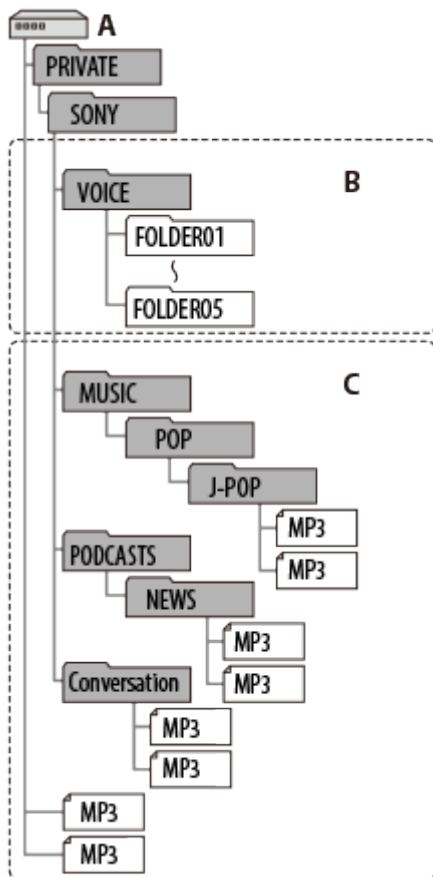

A: MEMORY CARD

B: Folder for files recorded using the IC recorder

C: Folder transferred from your computer

[Go to Page Top](#)

Related Topic

- [Selecting the memory using the menu \(Select Memory\)](#)

[Go to Page Top](#)

Notes on use

4-534-070-11(1)

Copyright 2014 Sony Corporation

IC Recorder

ICD-PX440

[Back](#) | [Back to Top](#)

[Print](#)

Copying files from the IC recorder to your computer

You can copy the files and folders from the IC recorder to your computer to store them.



1. Connect the IC recorder to your computer.
2. Copy files or folders you want to transfer to your computer.
Drag and drop the files or folders you want to copy from “IC RECORDER” or “MEMORY CARD” to the local disk on your computer.
3. Disconnect the IC recorder from your computer.

Hint

- To copy a file or folder (drag and drop), click and hold the file or folder (①), drag (②), and then drop (③).

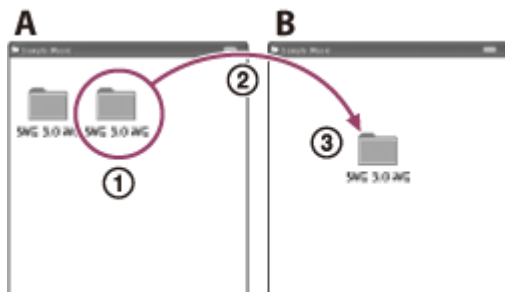

A: IC RECORDER or MEMORY CARD

B: Your computer

Related Topic

- [Connecting the IC recorder to your computer](#)
- [Disconnecting the IC recorder from your computer](#)

[Go to Page Top](#)

Notes on use

4-534-070-11(1)

Copyright 2014 Sony Corporation

IC Recorder

ICD-PX440

[Back](#) | [Back to Top](#)

[Print](#)

Copying a music file from your computer to the IC recorder (drag and drop)

You can copy music or the other audio files (MP3(.mp3) (*)) from your computer to the IC recorder by dragging and dropping them, and you can play them back using the IC recorder.



* For the file formats that can be played back using the IC recorder, see [“Design and specifications.”](#)

1. Connect the IC recorder to your computer.
2. Copy the folder in which the music files are stored to the IC recorder.
On a Windows screen using Explorer, or on a Mac screen using Finder, drag and drop the folder containing the music files onto “IC RECORDER” or “MEMORY CARD.”
The IC recorder can recognize up to 400 folders. You can copy up to 199 files to one folder. Moreover, the IC recorder can recognize up to a total of 4,095 folders and files for one memory media.
3. Disconnect the IC recorder from your computer.

[Go to Page Top](#)

Related Topic

- [Connecting the IC recorder to your computer](#)
- [Disconnecting the IC recorder from your computer](#)

IC Recorder

ICD-PX440





















[Back](#) | [Back to Top](#)

[Print](#)

Playing back music files copied from your computer using the IC recorder

You can copy music or the other audio files (MP3(.mp3) (*)) from your computer to the IC recorder, and you can play them back using the IC recorder.

* For the file formats that can be played back using the IC recorder, see "[Design and specifications.](#)"

1. Press FOLDER.
2. Press , press  or  to select the  tab, and then press .
3. Press  or  to select the folder () in which music files are stored, and then press .
To display the files contained in a folder, press  or  to select a folder, and then press .
4. Select the music file you want to play.
When the file selection window is displayed, press  or  to select the desired file, and then press .
When the stop mode window is displayed, you can switch files by pressing  and .
5. Press  to start playback.
Pressing  or  allows you to check the information of a music file that is currently being played back.
6. Press  STOP to stop playback.

[Go to Page Top](#)

Related Topic

- [Display during playback](#)

[Go to Page Top](#)



IC Recorder

ICD-PX440

[Back](#) | [Back to Top](#)[Print](#)

Using the IC Recorder as USB memory

When the IC recorder is connected to your computer, image data or text data on the computer, as well as files recorded using the IC recorder can be temporarily stored on the IC recorder.

Your computer must meet the specified system requirements to use the IC recorder as USB memory.

For details on the system requirements, check "[System requirements](#)."

[Go to Page Top](#)

[Notes on use](#)

4-534-070-11(1)

Copyright 2014 Sony Corporation

IC Recorder

ICD-PX440

[Back](#) | [Back to Top](#)

[Print](#)

What you can do using Sound Organizer (for Windows only)

You can install Sound Organizer using the set up file (SoundOrganizerInstaller_V150.exe) stored on the built-in memory of the IC recorder.

Sound Organizer allows you to exchange files with an IC recorder or memory card. The songs imported from music CDs and other media, MP3 and other audio files imported from a computer, and podcasts can also be played and transferred to an IC recorder. Various operations can be performed for imported files, including playback, editing and conversion to MP3 and other formats. You can also burn CDs of the music you like, and send audio files by mail. For details on the operation of the Sound Organizer, refer to the Sound Organizer help.

Importing files recorded with an IC recorder

You can import recording files that were recorded with an IC recorder into Sound Organizer. The imported files are saved to the computer.

Importing songs from a music CD

You can import the songs of a music CD into Sound Organizer. The imported songs are saved to the computer.

Importing songs on the computer

You can import music and other files saved to the computer into Sound Organizer.

Subscribing to and updating podcasts

You can subscribe to podcasts in Sound Organizer. Subscribing to and updating podcasts enables you to download (subscription) and enjoy the latest data from the Internet.

Playing files

You can play the files imported into Sound Organizer.

Changing the file information

You can change the title name, artist name, and other file information displayed in the file list.

Dividing files

You can divide one file into multiple files.

Combining files

You can combine multiple files into one file.

Registering the user name

You can register a user name (information for recognizing your IC recorder) for your IC recorder. If you record a file with a user name set, the user name will be added to the file. If you do not set a user name, the user information for the recorded file will be "My Recording."

Deleting files from an IC recorder

You can delete a file saved to an IC recorder.

Use this operation to delete files in the IC recorder when you want to increase the amount of free space in the IC recorder or there are unnecessary files.

Transferring files to an IC recorder

You can transfer a file from Sound Organizer to an IC recorder or memory card.

You can enjoy transferred music, podcasts, and other content on your IC recorder.

Burning a music CD

You can select your favorite songs from the songs imported into Sound Organizer and then burn your own original music CD.

Other convenient uses

- You can start the mail software and send a recording file attached to mail.
- You can use the voice recognition software Dragon NaturallySpeaking (not supplied) which is compatible with Sound Organizer to perform voice recognition for a file and convert the voice to text.

[Go to Page Top](#)

[Notes on use](#)

4-534-070-11(1)

Copyright 2014 Sony Corporation

IC Recorder

ICD-PX440

[Back](#) | [Back to Top](#)

[Print](#)

System requirements for using Sound Organizer

The following shows the system requirements for using Sound Organizer.

Operating systems

- Windows 8.1
- Windows 8.1 Pro
- Windows 8
- Windows 8 Pro
- Windows 7 Ultimate Service Pack 1 or higher
- Windows 7 Professional Service Pack 1 or higher
- Windows 7 Home Premium Service Pack 1 or higher
- Windows 7 Home Basic Service Pack 1 or higher
- Windows 7 Starter Service Pack 1 or higher
- Windows Vista Ultimate Service Pack 2 or higher
- Windows Vista Business Service Pack 2 or higher
- Windows Vista Home Premium Service Pack 2 or higher
- Windows Vista Home Basic Service Pack 2 or higher

Pre-installed

Note

- One of the above operating systems should be by default pre-installed. Upgraded operating systems or multi-boot environment are not supported.

IBM PC/AT or compatible

- CPU
 - Windows Vista: Pentium III processor of 800 MHz or faster
 - Windows 7: Pentium III processor of 1 GHz or faster
 - Windows 8: Pentium III processor of 1 GHz or faster
 - Windows 8.1: Pentium III processor of 1 GHz or faster
- Memory

Windows Vista: At least 512 MB (In the case of Windows Vista Ultimate/Business/Home Premium, at least 1 GB is recommended.)

Windows 7: At least 1 GB (32 bit version)/At least 2 GB (64 bit version)

Windows 8: At least 1 GB (32 bit version)/At least 2 GB (64 bit version)

Windows 8.1: At least 1 GB (32 bit version)/At least 2 GB (64 bit version)

- Free hard disk space

At least 400 MB is required.

Depending on the version of Windows, more than 400 MB may be used.

Also, free space for handling music data is required.

- Display settings

Screen resolution: 800 × 600 pixels or higher (1,024 × 768 pixels is recommended.)

Screen color: High Color (16 bit) or higher

- Sound card

A SoundBlaster compatible card is recommended.

- USB port

A compatible USB port is required to use devices and media.

Operation via a USB hub is not guaranteed except for models for which operation has been specifically guaranteed.

- Disk drive

To create a music CD, you need a CD-R/RW drive.

[Go to Page Top](#)

Notes on use

4-534-070-11(1)

Copyright 2014 Sony Corporation



IC Recorder

ICD-PX440

[Back](#) | [Back to Top](#)[Print](#)

Installing Sound Organizer (for Windows only)

Install Sound Organizer on your computer.

Note

- When installing Sound Organizer, log in to an account with administrator privileges.
Also, if you are using Windows 7/Windows 8/Windows 8.1 and the [User Account Control] screen appears, confirm the contents of the screen and then click [Yes] ([Continue] in the case of Windows Vista).
 - The Windows Media Format Runtime module is added by the installer of Sound Organizer. This module is not removed when Sound Organizer is uninstalled. However, it may not be installed if it has been preinstalled.
 - The data in the content storage folders is not deleted when Sound Organizer is uninstalled.
 - In an installation environment in which multiple operating systems are installed on one computer, do not install Sound Organizer in each of the operating systems. Doing so may result in data inconsistencies.
1. Connect the IC recorder to the computer.
 2. Go to the [Start] menu, click [Computer] (or [My Computer]), and then double-click [IC RECORDER] - [FOR WINDOWS].

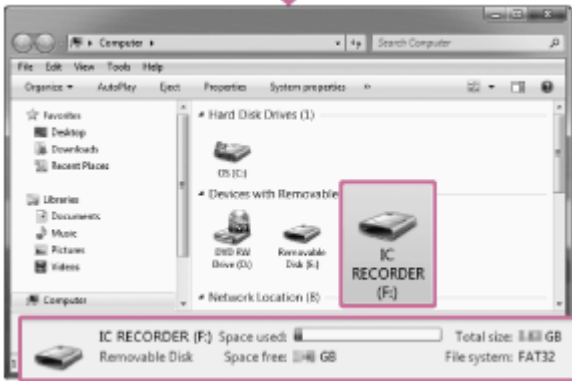
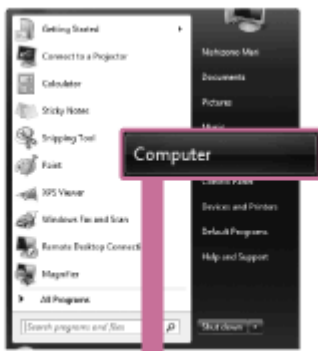

The display that appears on the computer screen differs depending on the version of the operating system you are using. Windows 7 is used as an example in this Help Guide.

3. Double-click [SoundOrganizerInstaller_V150] (or [SoundOrganizerInstaller_V150.exe]).



Depending on the version of the operating system you are using, the preparations for setup (extract) may start automatically without any notice appearing on the screen.

In such a case, follow the instructions that appear on the screen.

4. Make sure that you accept the terms of the license agreement, select [I accept the terms in the license agreement], and then click [Next].

5. When the [Setup Type] window appears, select [Standard] or [Custom], and then click [Next].
Follow the instructions on the screen and set the installation settings when you select [Custom].
6. When the [Ready to Install the Program] window appears, click [Install].
The installation starts.
7. When [Sound Organizer has been installed successfully.] window appears, check [Launch Sound Organizer Now], and then click [Finish].

Note

- You may need to restart your computer after installing Sound Organizer.

[Go to Page Top](#)

Related Topic

- [Connecting the IC recorder to your computer](#)

[Go to Page Top](#)

Notes on use

4-534-070-11(1)

Copyright 2014 Sony Corporation

IC Recorder
ICD-PX440

[Back](#) | [Back to Top](#)

[Print](#)

The Sound Organizer window (for Windows only)





1. Help
Displays the help of Sound Organizer. For details on each operation, refer to these help files.
2. The file list of Sound Organizer (My Library)
Displays a list of files included in My Library of Sound Organizer in accordance with the operation.
 - 📁 Recording Files: Displays a list of recording files.
Recording files that were recorded with an IC recorder appear in this library when they are imported.
 - 🎵 Music: Displays a list of music files.
Songs imported from a music CD appear in this library.
 - 📻 Podcast: Displays a list of podcasts.
3. The file list of the IC recorder
Displays the files saved to the connected IC recorder or memory card.
4. Edit Mode button
Displays the edit area so that you can edit a file.
5. Quick Operation Guide button
Displays the Quick Operation Guide to receive guidance on the basic features of Sound Organizer.
6. Sidebar (Import/Transfer)
 - 📷 IC Recorder: Displays the transfer screen. A list of files on a connected device appears.

 Import CD: Displays the screen for importing music CDs.

 Burn CD/DVD: Displays the screen for burning discs.

7. Transfer buttons

: Transfers the files of Sound Organizer to an IC recorder or memory card.

: Imports the files of an IC recorder or memory card to My Library of Sound Organizer.

[Go to Page Top](#)

Notes on use

4-534-070-11(1)

Copyright 2014 Sony Corporation



IC Recorder

ICD-PX440

[Back](#) | [Back to Top](#)[Print](#)

About compatible memory cards

You can use the following memory cards with the IC recorder.

- microSD cards of up to 2 GB: supported
- microSDHC cards from 4 GB to 32 GB: supported
- microSDXC cards of 64 GB or more: not supported
- M2™ cards of up to 16 GB: supported

Due to the file system specifications of the IC recorder, you can record a file smaller than 500 MB using a memory card.

Note

- In this Help Guide, M2™ and microSD cards are generally referred to as a “memory card.” The M2™/microSD memory card slot is referred to as the “memory card slot.”
- Operations of all types of compatible memory cards are not guaranteed.

[Go to Page Top](#)

Notes on use

4-534-070-11(1)

Copyright 2014 Sony Corporation

IC Recorder

ICD-PX440

[Back](#) | [Back to Top](#)

[Print](#)

System requirements

When you use the IC recorder connected to a computer or as a USB mass storage device, your computer must meet the operating system requirements and port environment described below.

To use your computer with the Sound Organizer software, see “[System requirements for using Sound Organizer.](#)”

Operating systems

- Windows 8.1
- Windows 8.1 Pro
- Windows 8
- Windows 8 Pro
- Windows 7 Ultimate Service Pack 1 or higher
- Windows 7 Professional Service Pack 1 or higher
- Windows 7 Home Premium Service Pack 1 or higher
- Windows 7 Home Basic Service Pack 1 or higher
- Windows 7 Starter Service Pack 1 or higher
- Windows Vista Ultimate Service Pack 2 or higher
- Windows Vista Business Service Pack 2 or higher
- Windows Vista Home Premium Service Pack 2 or higher
- Windows Vista Home Basic Service Pack 2 or higher
- Mac OS X (v10.5-v10.9)

Pre-installed

Note

- One of the above operating systems should be by default pre-installed. Upgraded operating systems or multi-boot environment are not supported.
- For the latest version information and compatibility with your operating system, please access the support home page for the IC recorder (see “[Customer support websites](#)”).

Hardware environment

- Sound board: Sound boards compatible with any of the supported operating systems

- Port: USB port
- Disk drive: To create a music CD, you need a CD-R/RW drive.

Note

The following systems are not supported:

- Operating systems other than the ones indicated in this topic
- Personally constructed computers or operating systems
- Upgraded operating systems
- Multi-boot environment
- Multi-monitor environment

[Go to Page Top](#)

Notes on use

4-534-070-11(1)

Copyright 2014 Sony Corporation

IC Recorder

ICD-PX440

[Back](#) | [Back to Top](#)

[Print](#)

Design and specifications

Capacity (User available capacity: when the built-in memory is formatted with the IC recorder)

4 GB (approx. 3.60 GB = 3,865,470,566 Byte)

A small amount of the built-in memory is used for file management and therefore not available for user storage.

Maximum number of folders (for a drive)

400 folders

Maximum number of files (for a folder)

199 files

Maximum number of files (for a drive)

4,074 files (When 21 folders are contained in a drive.)

Frequency range

MP3 192kbps: 75 Hz - 20,000 Hz

MP3 128kbps: 75 Hz - 17,000 Hz

MP3 48kbps(MONO): 75 Hz - 14,000 Hz

MP3 8kbps(MONO): 75 Hz - 3,500 Hz

Compatible file formats

MP3 (*1)

Bit rate: 32 kbps - 320 kbps (Supports variable bit rate (VBR))

Sampling frequencies: 16/22.05/24/32/44.1/48 kHz

File extension: .mp3

Speaker

Approx. 28 mm (1 1/8 in.) dia.

Input/Output

Microphone jack (minijack, stereo)

input for plug in power, minimum input level 0.6 mV

Headphone jack (minijack, stereo)

output for 8 Ω - 300 Ω impedance headphones

USB connector (Type-A)

High-Speed USB compatible

Card slot

Memory Stick Micro™ (M2™)/microSD memory card slot

Playback speed control (DPC)

2.00 times - 0.50 times

Power output

300 mW

Power requirements

Two LR03 (size AAA) alkaline batteries (supplied): 3.0 V DC

Two NH-AAA rechargeable batteries (not supplied): 2.4 V DC

Operating temperature

5 °C - 35 °C (41 °F to 95 °F)

Dimensions (w/h/d) (not incl. projecting parts and controls) (JEITA) (*2)

Approx. 37.2 mm × 113.2 mm × 19.3 mm (1 1/2 in. × 4 1/2 in. × 25/32 in.)

Mass (JEITA) (*2)

Approx. 75 g (2 5/8 oz) including two LR03 (size AAA) alkaline batteries

Supplied accessories

See “Quick Start Guide” supplied with your IC recorder.

Design and specifications are subject to change without notice.

*1 The playback of MP3 files recorded using the IC recorder is also supported. Not all encoders are supported.

*2 Measured value by the standard of JEITA (Japan Electronics and Information Technology Industries Association)

Maximum recording time (*1)(*2)

The maximum recording time of all the folders is as follows.

MP3 192kbps (🎧/📁/📁/📁/📁) (*3)**Built-in memory**

44 h. 40 m.

Memory card

2 GB: 22 h. 20 m.

4 GB: 44 h. 40 m.

8 GB: 89 h. 25 m.

16 GB: 178 h.

32 GB: 357 h.

MP3 128kbps (🎧/📁) (*3)**Built-in memory**

67 h. 5 m.

Memory card

2 GB: 33 h. 30 m.

4 GB: 67 h. 5 m.

8 GB: 134 h.

16 GB: 268 h.

32 GB: 536 h.

MP3 48kbps(MONO)

Built-in memory

178 h.

Memory card

2 GB: 89 h. 25 m.

4 GB: 178 h.

8 GB: 357 h.

16 GB: 715 h.

32 GB: 1,431 h.

MP3 8kbps(MONO)

Built-in memory

1,073 h.

Memory card

2 GB: 536 h.

4 GB: 1,073 h.

8 GB: 2,147 h.

16 GB: 4,294 h.

32 GB: 8,589 h.

(h.: hours/m.: minutes)

*1 When you are going to record continuously for a long time, you may have to replace the batteries with new ones in the middle of recording. For details on the battery life, see "[Battery life](#)."

*2 The maximum recording time in this topic for your reference only, and may differ depending on the card specifications.

*3 Default settings for the recording scenes

The maximum playback time of a music file/number of files (*1)

48 kbps

Playback time: 178 h.

Number of files: 2,670 files

128 kbps

Playback time: 67 h. 5 m.

Number of files: 1,006 files

256 kbps

Playback time: 33 h. 30 m.

Number of files: 502 files

(h.: hours/m.: minutes)

*1 In the case where MP3 files of 4 minutes each are transferred to the IC recorder.

[Go to Page Top](#)

IC Recorder

ICD-PX440

[Back](#) | [Back to Top](#)

[Print](#)

Battery life

When using Sony LR03 (SG) (size AAA) alkaline batteries (*1)

MP3 192kbps

Recording: Approx. 57 h.

Playback through speaker (*2): Approx. 18 h.

Playback using headphones: Approx. 48 h.

MP3 128kbps

Recording: Approx. 57 h.

Playback through speaker (*2): Approx. 18 h.

Playback using headphones: Approx. 48 h.

MP3 48kbps(MONO)

Recording: Approx. 72 h.

Playback through speaker (*2): Approx. 18 h.

Playback using headphones: Approx. 48 h.

MP3 8kbps(MONO)

Recording: Approx. 96 h.

Playback through speaker (*2): Approx. 18 h.

Playback using headphones: Approx. 48 h.

(h.: hours/m.: minutes)

*1 Measured value by the standard of JEITA (Japan Electronics and Information Technology Industries Association). The battery life may shorten depending on how you operate the IC recorder.

*2 When playing back music through the internal speaker with the volume level set to 27

When using Sony NH-AAA rechargeable batteries (*1)

MP3 192kbps

Recording: Approx. 42 h.

Playback through speaker (*2): Approx. 12 h.

Playback using headphones: Approx. 34 h.

MP3 128kbps

Recording: Approx. 42 h.

Playback through speaker (*2): Approx. 12 h.

Playback using headphones: Approx. 34 h.

MP3 48kbps(MONO)

Recording: Approx. 50 h.

Playback through speaker (*2): Approx. 12 h.

Playback using headphones: Approx. 34 h.

MP3 8kbps(MONO)

Recording: Approx. 65 h.

Playback through speaker (*2): Approx. 12 h.

Playback using headphones: Approx. 34 h.

(h.: hours/m.: minutes)

*1 Measured value by the standard of JEITA (Japan Electronics and Information Technology Industries Association). The battery life may shorten depending on how you operate the IC recorder.

*2 When playing back music through the internal speaker with the volume level set to 27

[Go to Page Top](#)

[Notes on use](#)

4-534-070-11(1)

Copyright 2014 Sony Corporation

IC Recorder

ICD-PX440

[Back](#) | [Back to Top](#)

[Print](#)

Precautions

On power

Operate the unit only on 3.0 V or 2.4 V DC. Use two LR03 (size AAA) alkaline batteries or two NH-AAA rechargeable batteries.

On safety

Do not operate the unit while driving, cycling or operating any motorized vehicle.

On handling

- Do not leave the unit in a location near heat sources, or in a place subject to direct sunlight, excessive dust or mechanical shock.
- Should any solid object or liquid fall into the unit, remove the batteries and have the unit checked by qualified personnel before operating it any further.
- Be careful not to allow water to splash on the unit. The unit is not waterproof. In particular, be careful in the following situations.
 - When you have the unit in your pocket and go to the bathroom, etc.
When you bend down, the unit may drop into the water and may get wet.
 - When you use the unit in an environment where the unit is exposed to rain, snow, or humidity.
 - In circumstances where you get sweaty. If you touch the unit with wet hands or if you put the unit in the pocket of sweaty clothes, the unit may get wet.
- You may feel pain in your ears if you use headphones when the ambient air is very dry. This is not because of a malfunction of the headphones, but because of static electricity accumulated in your body. You can reduce static electricity by wearing non-synthetic clothes that prevent the emergence of static electricity.

On noise

- Noise may be heard when the unit is placed near an AC power source, a fluorescent lamp or a mobile phone during recording or playback.
- Noise may be recorded when an object, such as your finger, etc., rubs or scratches the unit during recording.

On maintenance

To clean the exterior, use a soft cloth slightly moistened in water. Then use a soft dry cloth to wipe the exterior. Do not use alcohol, benzine or thinner.

Backup recommendations

To avoid potential risk of data loss caused by accidental operation or malfunction of the IC recorder, we recommend that you save a backup copy of your recorded files to a computer, etc.

On using a memory card

- When formatting (initializing) a memory card, make sure to use the IC recorder to format it. Operations of the memory cards formatted with Windows or other devices are not guaranteed.
- If you format a memory card containing recorded data, the recorded data will be deleted. Be careful not to delete important data.
- Do not leave a memory card within the reach of small children. They might accidentally swallow it.
- Do not insert or remove a memory card during recording/playback/formatting. Doing so may cause a malfunction of the IC recorder.
- Do not remove a memory card while the “Accessing...” or “Formatting...” animation appears in the display window, or the operation indicator is flashing in orange.
- We do not guarantee the operations of all types of compatible memory cards with the IC recorder.
- For compatible M2™, please refer to the Sony website.
- MagicGate™ is the collective name of content protection technologies developed by Sony. The IC recorder does not support data recording/playback that requires MagicGate™ functions.
- The IC recorder does not support parallel data transfer.
- You cannot use a ROM (read-only-memory) type or write-protected memory card.
- Data may be corrupted in the following cases:
 - When a memory card is removed or the IC recorder is turned off during a read or write operation.
 - When a memory card is used in locations subject to static electricity or electrical noise.
- We assume no responsibility for any loss or damage of recorded data.
- We recommend that you save a backup copy of the important data.
- Do not touch the terminal of a memory card with your hand or a metal object.
- Do not strike, bend or drop a memory card.
- Do not disassemble or modify a memory card.
- Do not expose a memory card to water.
- Do not use a memory card under the following conditions:
 - Locations beyond the required operating conditions, including locations, such as the hot interior of a car parked in the sun and/or in the summer, the outdoors exposed to direct sunlight, or a place near a heater.
 - Humid locations or locations with corrosive substances present.
- When using a memory card, make sure to check the correct insertion direction into the memory card slot.

If you have any questions or problems concerning your unit, please consult your nearest Sony dealer.

[Go to Page Top](#)

IC Recorder

ICD-PX440

[Back](#) | [Back to Top](#)

[Print](#)

Safety regulations

WARNING

Do not expose the batteries (battery pack or batteries installed) to excessive heat such as sunshine, fire or the like for a long time.

CAUTION

Risk of explosion if battery is replaced by an incorrect type. Dispose of used batteries according to the instructions.

- The recorded music is limited to private use only. Use of the music beyond this limit requires permission of the copyright holders.
- Sony is not responsible for incomplete recording/downloading or damaged data due to problems of the IC recorder or computer.
- Depending on the types of the text and characters, the text shown on the IC recorder may not be displayed properly on device. This is due to:
 - The capacity of the connected IC recorder.
 - The IC recorder is not functioning normally.
 - Content information is written in the language or the character that is not supported by the IC recorder.

Disposal of waste batteries and electrical and electronic equipment (applicable in the European Union and other European countries with separate collection systems)



This symbol on the product, the battery or on the packaging indicates that the product and the battery shall not be treated as household waste. On certain batteries this symbol might be used in combination with a chemical symbol. The chemical symbols for mercury (Hg) or lead (Pb) are added if the battery contains more than 0.0005% mercury or 0.004% lead. By ensuring these products and batteries are disposed of correctly, you will help prevent potentially

negative consequences for the environment and human health which could otherwise be caused by inappropriate waste handling. The recycling of the materials will help to conserve natural resources.

In case of products that for safety, performance or data integrity reasons require a permanent connection with an incorporated battery, this battery should be replaced by qualified service staff only. To ensure that the battery and the electrical and electronic equipment will be treated properly, hand over these products at end-of-life to the applicable collection point for the recycling of electrical and electronic equipment. For all other batteries, please view the section on how to remove the battery from the product safely. Hand the battery over to the applicable collection point for the recycling of waste batteries. For more detailed information about recycling of this product or battery, please contact your local Civic Office, your household waste disposal service or the shop where you purchased the product or battery.

Notice for the customers: the following information is only applicable to equipment sold in the countries applying EU directives

This product has been manufactured by or on behalf of Sony Corporation, 1-7-1 Konan Minato-ku Tokyo, 108-0075 Japan. Inquiries related to product compliance based on European Union legislation shall be addressed to the authorized representative, Sony Deutschland GmbH, Hedelfinger Strasse 61, 70327 Stuttgart, Germany. For any service or guarantee matters, please refer to the addresses provided in the separate service or guarantee documents.

To prevent possible hearing damage, do not listen at high volume levels for long periods.



[Go to Page Top](#)

[Notes on use](#)

4-534-070-11(1)

Copyright 2014 Sony Corporation

IC Recorder

ICD-PX440

[Back](#) | [Back to Top](#)

[Print](#)

Trademarks

- Microsoft, Windows, Windows Vista and Windows Media are registered trademarks or trademarks of Microsoft Corporation in the United States and/or other countries.
- Mac OS is a trademark of Apple Inc., registered in the USA and other countries.
- Pentium is a registered trademark of Intel Corporation.
- MPEG Layer-3 audio coding technology and patents licensed from Fraunhofer IIS and Thomson.
- microSD and microSDHC logos are trademarks of SD-3C, LLC.



- Memory Stick Micro™, M2™ and  are trademarks or registered trademarks of Sony Corporation.



- MagicGate™ is a trademark of Sony Corporation.
- Nuance, the Nuance logo, Dragon, Dragon NaturallySpeaking, and RealSpeak are trademarks and/or registered trademarks of Nuance Communications Inc., and/or its affiliates in the United States and/or other countries.

All other trademarks and registered trademarks are trademarks or registered trademarks of their respective holders. Furthermore, “™” and “®” are not mentioned in each case in this Help Guide.

The Sound Organizer uses software modules as shown below:

Windows Media Format Runtime

[Go to Page Top](#)

IC Recorder

ICD-PX440

[Back](#) | [Back to Top](#)

[Print](#)

Notice for users

All rights reserved. This Help Guide or the software described herein, in whole or in part, may not be reproduced, translated or reduced to any machine readable form without prior written approval from Sony Corporation. IN NO EVENT SHALL SONY CORPORATION BE LIABLE FOR ANY INCIDENTAL, CONSEQUENTIAL OR SPECIAL DAMAGES, WHETHER BASED ON TORT, CONTRACT, OR OTHERWISE, ARISING OUT OF OR IN CONNECTION WITH THIS HELP GUIDE, THE SOFTWARE OR OTHER INFORMATION CONTAINED HEREIN OR THE USE THEREOF.

Sony Corporation reserves the right to make any modification to this Help Guide or the information contained herein at any time without notice.

- The software described herein may also be governed by the terms of a separate user license agreement.
- This software is for Windows and cannot be used for Mac.
- Display windows in this Help Guide may differ from what are actually displayed on your IC recorder depending on the area you purchased the IC recorder and the settings you have made.

What you record is for personal enjoyment and use only. Copyright laws prohibit other forms of use without the permission of the copyright holders.

The use of Memory Stick™ media for recording copyright-protected graphics or other data is limited to the restrictions specified under applicable copyright laws.

Any use beyond those restriction is prohibited.

This product supports Memory Stick Micro™ (M2™) media. M2™ is an abbreviated form of Memory Stick Micro™. Hereinafter, M2™ is used in this Help Guide.

[Go to Page Top](#)

[Notes on use](#)



IC Recorder

ICD-PX440

[Back](#) | [Back to Top](#)

[Print](#)

Customer support websites

Please access the following support home page to get the support information about your IC recorder:

For customers in Europe:

<http://support.sony-europe.com/DNA>

For customers in Latin America:

<http://www.sony-latin.com/index.crp>

For customers in the U.S.A.:

<http://www.sony.com/recordersupport>

For customers in Canada:

<http://fr.sony.ca/ElectronicsSupport>

For customers in other countries/regions:

<http://www.sony-asia.com/support>

Note that recorded files may be deleted during service or repair work.

[Go to Page Top](#)

Notes on use

4-534-070-11(1)

Copyright 2014 Sony Corporation

IC Recorder

ICD-PX440

[Back](#) | [Back to Top](#)

[Print](#)

Troubleshooting

Before taking the IC recorder for repair, check it as follows.

- Check the items listed in “Troubleshooting.”
- Re-insert the batteries.
Some problems may be solved when you re-insert the batteries.
- Check the Sound Organizer help.
For details on the operation of Sound Organizer, refer to the Sound Organizer help.

Should any problem persist after you have made these checks, consult your nearest Sony dealer.

Please access the following support home page to get the support information about your IC recorder:

For customers in Europe:

<http://support.sony-europe.com/DNA>

For customers in Latin America:

<http://www.sony-latin.com/index.crp>

For customers in the U.S.A.:

<http://www.sony.com/recordersupport>

For customers in Canada:

<http://fr.sony.ca/ElectronicsSupport>

For customers in other countries/regions:

<http://www.sony-asia.com/support>

Note that recorded files may be deleted during service or repair work.

[Go to Page Top](#)

[Notes on use](#)

4-534-070-11(1)

Copyright 2014 Sony Corporation

IC Recorder

ICD-PX440

[Back](#) | [Back to Top](#)

[Print](#)

The recorded file is noisy and is hard to understand.

- Noise from the recording environment other than the human voice is recorded.
If you set “Noise Cut” in the menu to “Auto,” “Maximum,” or “Medium,” the IC recorder reduces the extraneous noise, such as mechanical noise from projectors or air-conditioners.
This function reduces noise in the entire bandwidth, therefore the IC recorder is able to play back the human voice clearly.

[Go to Page Top](#)

[Notes on use](#)

4-534-070-11(1)

Copyright 2014 Sony Corporation



IC Recorder

ICD-PX440

[Back](#) | [Back to Top](#)

[Print](#)

The recorded file is noisy and you want to record with less noise in your recording.

- If you set “Recording Filter” in the menu to “NCF(Noise Cut)” or “LCF(Low Cut)” before recording, you can record a file with less noise from the recording environment.
Furthermore, you can use the “Scene Select” function, which allows you to change various recording settings (“REC Mode,” “Mic Sensitivity,” etc.) to the recommended settings in one batch process to suit the situation in which you are recording.

[Go to Page Top](#)

[Notes on use](#)

4-534-070-11(1)

Copyright 2014 Sony Corporation



IC Recorder

ICD-PX440

[Back](#) | [Back to Top](#)[Print](#)

A rustling noise is recorded.

- A rustling noise may be recorded if the IC recorder is rubbed by your hand or clothing while you are recording. If possible, please do not touch the IC recorder until you finish recording.

[Go to Page Top](#)

Notes on use

4-534-070-11(1)

Copyright 2014 Sony Corporation



IC Recorder

ICD-PX440

[Back](#) | [Back to Top](#)[Print](#)

A buzzing or humming noise is recorded.

- A buzzing or humming noise may be recorded if the IC recorder is placed near an AC power source, a fluorescent lamp, or a mobile phone during recording or playback.
Keep the IC recorder away from such equipment when recording.

[Go to Page Top](#)

[Notes on use](#)

4-534-070-11(1)

Copyright 2014 Sony Corporation



IC Recorder

ICD-PX440

[Back](#) | [Back to Top](#)[Print](#)

Noise is recorded when you record a file using an external microphone (not supplied).

- The plug of the connected external microphone is dirty.
Clean the plug.

[Go to Page Top](#)

[Notes on use](#)

4-534-070-11(1)

Copyright 2014 Sony Corporation



IC Recorder

ICD-PX440

[Back](#) | [Back to Top](#)[Print](#)

Noise is heard when you listen to the file using headphones.

- The plug of the connected headphones is dirty.
Clean the plug.

[Go to Page Top](#)

[Notes on use](#)

4-534-070-11(1)

Copyright 2014 Sony Corporation



IC Recorder

ICD-PX440

[Back](#) | [Back to Top](#)[Print](#)

Noise is heard in the playback even though the noise cut function is active.

- When playing back files using the built-in speaker, the noise cut function does not work.
- When the noise cut function is set to “Auto,” the IC recorder adjusts the noise cut level automatically, however, when you play a file recorded with the “Scene Select” menu set to “Meeting,” “Lecture,” “Voice Notes,” or “Interview,” the noise cut function will switch to “Medium” automatically.

[Go to Page Top](#)

[Notes on use](#)

4-534-070-11(1)

Copyright 2014 Sony Corporation

IC Recorder

ICD-PX440

[Back](#) | [Back to Top](#)

[Print](#)

The IC recorder cannot be turned on. The IC recorder does not operate, even if you press any button.

- The batteries are weak.
- The batteries have been inserted with incorrect polarity.
- The power of the IC recorder is off.
Slide and hold the HOLD · POWER ON/OFF switch in the direction of “POWER ON/OFF” until the window display appears. The power is turned on.
- The HOLD function is activated.
Slide the HOLD · POWER ON/OFF switch in the center direction.

[Go to Page Top](#)

Related Topic

- [Turning the power on](#)
- [Turning the power off](#)
- [Parts and controls](#)
- [Releasing the HOLD function](#)

[Go to Page Top](#)

[Notes on use](#)



IC Recorder

ICD-PX440

[Back](#) | [Back to Top](#)

[Print](#)

The IC recorder cannot be turned off.

-
- Slide and hold the HOLD · POWER ON/OFF switch in the direction of “POWER ON/OFF” until “Power Off” animation is displayed when the IC recorder is in the stop mode. The power is turned off.

[Go to Page Top](#)

Related Topic

- [Turning the power off](#)
- [Parts and controls](#)

[Go to Page Top](#)

[Notes on use](#)

4-534-070-11(1)

Copyright 2014 Sony Corporation

IC Recorder

ICD-PX440

[Back](#) | [Back to Top](#)

[Print](#)

The IC recorder is powered off automatically.

- When the IC recorder is in the stop mode and you leave the IC recorder without attempting an operation for a certain length of time, the auto power off function will take effect. (The length of time before auto power off is set to “10min” when you purchase the IC recorder.) You can select the length of time before auto power off takes effect in the menu.

[Go to Page Top](#)

Related Topic

- [Setting the time period for the IC recorder to turn off \(Auto Power Off\)](#)

[Go to Page Top](#)

[Notes on use](#)

4-534-070-11(1)

Copyright 2014 Sony Corporation

IC Recorder

ICD-PX440

[Back](#) | [Back to Top](#)

[Print](#)

The battery life is short.

- The battery life listed in this Help Guide is based on playback with the volume level set to 27. The battery life may shorten depending on the operation of the IC recorder.
- Even if you do not use the IC recorder, the batteries are consumed slightly. If you do not intend to use the IC recorder for an extended period of time, it is recommended that you turn the power off or remove the batteries. Moreover, if you set “Auto Power Off” to a short span in the menu, you can prevent the batteries from being consumed due to forgetting to turn the IC recorder off.
- You are using the batteries in an environment with a temperature of under 5 °C (41 °F). Battery life becomes shorter as a result of the battery characteristics. This is not a malfunction.
- You are using manganese batteries for this IC recorder. You cannot use the IC recorder with manganese batteries.

[Go to Page Top](#)

Related Topic

- [Turning the power off](#)
- [Setting the time period for the IC recorder to turn off \(Auto Power Off\)](#)
- [Battery life](#)

[Go to Page Top](#)

[Notes on use](#)

IC Recorder

ICD-PX440

[Back](#) | [Back to Top](#)

[Print](#)

The IC recorder does not operate correctly.

- Take out the batteries and insert it again.
- You may have formatted the memory of the IC recorder using the computer.
Use the IC recorder formatting function to format the memory.

[Go to Page Top](#)

Related Topic

- [Formatting the memory \(Format\)](#)

[Go to Page Top](#)

[Notes on use](#)

4-534-070-11(1)

Copyright 2014 Sony Corporation

IC Recorder

ICD-PX440

[Back](#) | [Back to Top](#)

[Print](#)

The operation indicator does not light.

- “LED” is set to “OFF.”
Display the menu and set “LED” to “ON.”

[Go to Page Top](#)

Related Topic

- [Turning the operation indicator on or off \(LED\)](#)

[Go to Page Top](#)

[Notes on use](#)

4-534-070-11(1)

Copyright 2014 Sony Corporation





IC Recorder

ICD-PX440

[Back](#) | [Back to Top](#)[Print](#)

You cannot record a file.

- The remaining memory capacity is insufficient.
- You cannot record a file when you select a folder in the playback-only area (the  tab and the  tab).

[Go to Page Top](#)

Notes on use

4-534-070-11(1)

Copyright 2014 Sony Corporation

IC Recorder

ICD-PX440

[Back](#) | [Back to Top](#)

[Print](#)

Recording is interrupted.

- The VOR function is activated. When you are not using the VOR function, set “VOR” to “OFF” in the menu.

[Go to Page Top](#)

Related Topic

- [Starting to record automatically in response to sound – the VOR function](#)

[Go to Page Top](#)

[Notes on use](#)

4-534-070-11(1)

Copyright 2014 Sony Corporation



IC Recorder

ICD-PX440

[Back](#) | [Back to Top](#)[Print](#)

When recording from other equipment, the input level is too strong or not strong enough.

- Connect the headphones jack of other equipment to the  (microphone) jack of the IC recorder and adjust the volume level on the piece of equipment connected to the IC recorder.
- If you use an audio connecting cable with resistance, the input level is low during recording. Use an audio connecting cable without resistance.

[Go to Page Top](#)

[Notes on use](#)

4-534-070-11(1)

Copyright 2014 Sony Corporation



IC Recorder

ICD-PX440

[Back](#) | [Back to Top](#)

[Print](#)

You cannot add a recording or an overwrite recording.

- “Add/Overwrite” is set to “OFF” in the menu. Set “Add/Overwrite” to “Add” or “Overwrite.”
- The remaining memory capacity is insufficient. The overwritten part will be deleted after the overwriting part finishes recording. Therefore, you can only overwrite within the remaining recording time.
- You cannot add a segment or overwrite a part of a file which was not recorded using the IC recorder.
- You cannot add a segment or overwrite a part of a file in a folder in the playback-only area ( tab and the  tab).
- You cannot add a segment to or overwrite a protected file.

[Go to Page Top](#)

Related Topic

- [Adding a new segment to a previously recorded file](#)
- [Adding an overwrite recording during playback](#)

[Go to Page Top](#)

[Notes on use](#)

4-534-070-11(1)

Copyright 2014 Sony Corporation



IC Recorder

ICD-PX440

[Back](#) | [Back to Top](#)[Print](#)

The playback volume is low.

- The built-in speaker is mainly for monitoring, and the playback volume is low. Use headphones.

[Go to Page Top](#)

Notes on use

4-534-070-11(1)

Copyright 2014 Sony Corporation

IC Recorder

ICD-PX440

[Back](#) | [Back to Top](#)

[Print](#)

No sound comes from the speaker.

- Headphones are plugged in.

[Go to Page Top](#)

Related Topic

- [Listening with better sound quality](#)

[Go to Page Top](#)

[Notes on use](#)

4-534-070-11(1)

Copyright 2014 Sony Corporation



IC Recorder

ICD-PX440

[Back](#) | [Back to Top](#)[Print](#)

Sound comes from the speaker even when headphones are plugged in.

- If you plug in headphones not securely during playback, the sound may come from the speaker. Unplug the headphones, and then insert them securely.

[Go to Page Top](#)[Notes on use](#)

4-534-070-11(1)

Copyright 2014 Sony Corporation



IC Recorder

ICD-PX440

[Back](#) | [Back to Top](#)[Print](#)

Playback speed is too fast or too slow.

- The DPC (SPEED CTRL) switch has been set to “ON,” and you have changed the playback speed using ▲ or ▼ . Slide the DPC (SPEED CTRL) switch to “OFF,” or change the playback speed to normal using ▲ or ▼ .

[Go to Page Top](#)

Related Topic

- [Adjusting the playback speed – the DPC \(Digital Pitch Control\) function](#)

[Go to Page Top](#)

[Notes on use](#)

4-534-070-11(1)

Copyright 2014 Sony Corporation



IC Recorder

ICD-PX440

[Back](#) | [Back to Top](#)[Print](#)

Playback sound is not good when a music file is played back.

- When you play back a music file with “Noise Cut” in the menu is set to “Auto,” “Maximum,” or “Medium,” playback sound may be deteriorated.
Set “Noise Cut” to “OFF.”

[Go to Page Top](#)

Related Topic

- [Reducing noise in the playback sound and making the human voice clearer – the noise cut function](#)

[Go to Page Top](#)

[Notes on use](#)

4-534-070-11(1)

Copyright 2014 Sony Corporation



IC Recorder

ICD-PX440

[Back](#) | [Back to Top](#)[Print](#)

You cannot divide a file.

- You need a certain amount of free space in the memory to divide a file.
- 199 files have been recorded in the selected folder (📁).
Erase some of the files or erase all the files after you store them on the other memory media or on your computer.
- Because of the system limitations, you may not be able to divide a file at the very beginning or at the very end of the file.
- You cannot divide files other than those recorded using the IC recorder (e.g., a file transferred from a computer).

[Go to Page Top](#)

Related Topic

- [Erasing a file](#)

[Go to Page Top](#)

Notes on use

4-534-070-11(1)

Copyright 2014 Sony Corporation



IC Recorder

ICD-PX440

[Back](#) | [Back to Top](#)

[Print](#)

You cannot move a file.

- You cannot move a  (Podcast) file.
- You cannot move a protected file.
- You cannot move a file to a memory card.

[Go to Page Top](#)

[Notes on use](#)

4-534-070-11(1)

Copyright 2014 Sony Corporation



IC Recorder

ICD-PX440

[Back](#) | [Back to Top](#)

[Print](#)

You cannot copy a file to another memory.

- You cannot copy a  (Podcast) file to another memory.

[Go to Page Top](#)

[Notes on use](#)

4-534-070-11(1)

Copyright 2014 Sony Corporation



IC Recorder

ICD-PX440

[Back](#) | [Back to Top](#)

[Print](#)

“--:--” is displayed.

-
- You have not set the clock.

[Go to Page Top](#)

Related Topic

- [Setting the clock](#)
- [Setting the clock using the menu](#)

[Go to Page Top](#)

[Notes on use](#)

4-534-070-11(1)

Copyright 2014 Sony Corporation



IC Recorder

ICD-PX440

[Back](#) | [Back to Top](#)[Print](#)

The recording date of a file appears as "--y--m--d" or "--:--."

- The date of recording will not be displayed if you recorded the file when the clock was not set.

[Go to Page Top](#)

[Notes on use](#)

4-534-070-11(1)

Copyright 2014 Sony Corporation



IC Recorder

ICD-PX440

[Back](#) | [Back to Top](#)[Print](#)

The clock setting is reset.

-
- When you re-insert batteries, or when replace batteries with new ones, the clock setting display appears, and the approximate time when you last operated the IC recorder before replacing the batteries is displayed. Set the clock to the current time again.

[Go to Page Top](#)

Related Topic

- [Setting the clock](#)

[Go to Page Top](#)

[Notes on use](#)

4-534-070-11(1)

Copyright 2014 Sony Corporation

IC Recorder

ICD-PX440

[Back](#) | [Back to Top](#)

[Print](#)

There are fewer menu items displayed in the menu mode.

- During playback or recording modes, there are menu items that are not displayed.

[Go to Page Top](#)

Related Topic

- [Menu list](#)

[Go to Page Top](#)

[Notes on use](#)

4-534-070-11(1)

Copyright 2014 Sony Corporation



IC Recorder

ICD-PX440

[Back](#) | [Back to Top](#)

[Print](#)

The remaining time displayed in the display window is shorter than that displayed on the computer.

- The IC recorder requires a certain amount of memory for system operation. That amount is subtracted from the remaining time, which is the reason for the difference.

[Go to Page Top](#)

[Notes on use](#)

4-534-070-11(1)

Copyright 2014 Sony Corporation

IC Recorder

ICD-PX440

[Back](#) | [Back to Top](#)

[Print](#)

The “Memory Full” animation is displayed and you cannot start recording.

- The memory is full.
Erase some of the files or erase all the files after you store them on the other memory media or on your computer.

[Go to Page Top](#)

Related Topic

- [Erasing a file](#)

[Go to Page Top](#)

[Notes on use](#)

4-534-070-11(1)

Copyright 2014 Sony Corporation



IC Recorder

ICD-PX440

[Back](#) | [Back to Top](#)[Print](#)

The “File Full” animation is displayed and you cannot operate the IC recorder.

- 199 files have been recorded in the selected folder (📁) or 4,074 files (when there are 21 folders) in total have been recorded. Therefore you cannot record another file, or move a file.

Erase some of the files or erase all the files after you store them on the other memory media or on your computer.

[Go to Page Top](#)

Related Topic

- [Erasing a file](#)

[Go to Page Top](#)

[Notes on use](#)

4-534-070-11(1)

Copyright 2014 Sony Corporation



IC Recorder

ICD-PX440

[Back](#) | [Back to Top](#)[Print](#)

The memory card is not recognized.

- Remove a memory card and check the side of the memory card. Then insert it with correct side and direction.
- Switch the memory media of the IC recorder to “Memory Card.”

[Go to Page Top](#)

Related Topic

- [Inserting a memory card](#)
- [Selecting the memory](#)

[Go to Page Top](#)

[Notes on use](#)

4-534-070-11(1)

Copyright 2014 Sony Corporation



IC Recorder

ICD-PX440

[Back](#) | [Back to Top](#)[Print](#)

Even after you change a menu setting, the change is not applied to the menu.

- If the batteries are removed just after the menu setting is changed, or the menu setting is changed using “IC Recorder Setting” of the Sound Organizer software with the exhausted batteries inserted, the menu setting may not function.

[Go to Page Top](#)

[Notes on use](#)

4-534-070-11(1)

Copyright 2014 Sony Corporation



IC Recorder

ICD-PX440

[Back](#) | [Back to Top](#)[Print](#)

A character in a folder or file name is displayed in unreadable characters.

- The IC recorder cannot support or display some special characters and symbols that are entered on a computer using Windows Explorer or the Mac Finder.

[Go to Page Top](#)

[Notes on use](#)

4-534-070-11(1)

Copyright 2014 Sony Corporation



IC Recorder

ICD-PX440

[Back](#) | [Back to Top](#)

[Print](#)

It takes a long time to copy a file.

-
- If the file size of a file is large, it takes a considerable time to finish copying. Wait until the copying is finished.

[Go to Page Top](#)

[Notes on use](#)

4-534-070-11(1)

Copyright 2014 Sony Corporation

IC Recorder

ICD-PX440

[Back](#) | [Back to Top](#)

[Print](#)

The IC recorder is not recognized by your computer. A folder/file cannot be transferred from your computer.

- Disconnect the IC recorder from your computer and reconnect it.
- Do not use a USB hub or USB extension cable. Connect the IC recorder directly to your computer.
- Operation is not guaranteed if you use any system requirements other than those described in this Help Guide.
- Depending on the USB port position, the IC recorder may not be recognized. If this happens, try another port.

[Go to Page Top](#)

Related Topic

- [System requirements for using Sound Organizer](#)
- [System requirements](#)

[Go to Page Top](#)

[Notes on use](#)

4-534-070-11(1)

Copyright 2014 Sony Corporation



IC Recorder

ICD-PX440

[Back](#) | [Back to Top](#)[Print](#)

The file transferred from your computer is not displayed or cannot be played back.

- The IC recorder can recognize up to 8 levels of folders transferred to the IC recorder.
- The file format may differ from those that can be played back using the IC recorder (MP3(.mp3)). Check the compatible file formats.

[Go to Page Top](#)

Related Topic

- [Design and specifications](#)

[Go to Page Top](#)

[Notes on use](#)

4-534-070-11(1)

Copyright 2014 Sony Corporation

IC Recorder

ICD-PX440

[Back](#) | [Back to Top](#)

[Print](#)

The computer cannot start.

- If you start the computer with the IC recorder connected to the computer, the computer may freeze or may not start properly.
Disconnect the IC recorder from the computer and reboot the computer again.

[Go to Page Top](#)

[Notes on use](#)

4-534-070-11(1)

Copyright 2014 Sony Corporation



IC Recorder

ICD-PX440

[Back](#) | [Back to Top](#)[Print](#)

The Sound Organizer software cannot be installed.

- The free disk or memory space on the computer is too small.
Check the hard disk and memory space.
- You are trying to install the software into the computer with the operating system that the Sound Organizer software does not support.
Install the software into the computer with the supported operating system.
- In Windows Vista, Windows 7, Windows 8, or Windows 8.1, you have logged on using a guest account.
Make sure to log on using a user name with computer administrator privileges.

[Go to Page Top](#)

Related Topic

- [System requirements for using Sound Organizer](#)

[Go to Page Top](#)

[Notes on use](#)

4-534-070-11(1)

Copyright 2014 Sony Corporation

IC Recorder

ICD-PX440

[Back](#) | [Back to Top](#)

[Print](#)

The IC recorder cannot be properly connected.

- Check that the installation of the software has been successful. Also check the connection as follows:
 - _ When using an external USB hub, connect the IC recorder directly to the computer.
 - _ Disconnect and then connect the IC recorder.
 - _ Connect the IC recorder to another USB port.
- Your computer may be in the system standby/hibernate mode.
Do not let your computer enter into the system standby/hibernate mode while being connected to the IC recorder.
- Save a backup copy of all of the data stored on the built-in memory or the memory card, and then format the built-in memory or the memory card using the formatting function in the menu.

[Go to Page Top](#)

Related Topic

- [Selecting the memory using the menu \(Select Memory\)](#)

[Go to Page Top](#)

[Notes on use](#)

4-534-070-11(1)

Copyright 2014 Sony Corporation



IC Recorder

ICD-PX440

[Back](#) | [Back to Top](#)

[Print](#)

Playback sound from the computer is low. / No sound is emitted from the computer.

- No sound board is installed.
- No speaker is built-in or connected to the computer.
- The volume of the sound is turned down.
- Turn up the volume on the computer. (Refer to the instruction manual of the computer.)
- The volume of WAV files can be changed and saved using the “Increase Volume” feature of the Microsoft Sound Recorder.

[Go to Page Top](#)

[Notes on use](#)

4-534-070-11(1)

Copyright 2014 Sony Corporation



IC Recorder

ICD-PX440

[Back](#) | [Back to Top](#)[Print](#)

Stored files cannot be played back or edited.

- You cannot play back files whose file format the Sound Organizer software does not support. Depending on the file format, you cannot use part of editorial features of the software. Refer to the help files of the Sound Organizer software.

[Go to Page Top](#)[Notes on use](#)

4-534-070-11(1)

Copyright 2014 Sony Corporation



IC Recorder

ICD-PX440

[Back](#) | [Back to Top](#)[Print](#)

The counter or slider moves incorrectly, or noise is heard.

- This happens when you play back files that you divided.
Store a file on your computer first (*), and then add it to the IC recorder.

* Select the saving file format that suits the IC recorder you use.

[Go to Page Top](#)

[Notes on use](#)

4-534-070-11(1)

Copyright 2014 Sony Corporation



IC Recorder

ICD-PX440

[Back](#) | [Back to Top](#)[Print](#)

Operation is slow when there are many files.

- When the total number of files increases, the operation becomes slower, regardless of the length of the recording time.

[Go to Page Top](#)

[Notes on use](#)

4-534-070-11(1)

Copyright 2014 Sony Corporation



IC Recorder

ICD-PX440

[Back](#) | [Back to Top](#)[Print](#)

Display does not work during saving, adding, or deleting of files.

- It takes a longer time to copy or delete long files.
Wait until the copying or deleting is finished. After completing operations, the display works normally.

[Go to Page Top](#)

[Notes on use](#)

4-534-070-11(1)

Copyright 2014 Sony Corporation



IC Recorder

ICD-PX440

[Back](#) | [Back to Top](#)[Print](#)

The software 'hangs' when the Sound Organizer software starts up.

- Do not disconnect the IC recorder while the computer is communicating with the IC recorder. Otherwise the computer operations become unstable or the data inside the IC recorder may be damaged.
- There may be conflict between the software and other driver or application.

[Go to Page Top](#)

[Notes on use](#)

4-534-070-11(1)

Copyright 2014 Sony Corporation

IC Recorder

ICD-PX440

[Back](#) | [Back to Top](#)

[Print](#)

Messages list

Follow the instructions below if a message appears on the display.

HOLD. Slide HOLD Switch to Activate.

All the button operations are disabled because the IC recorder is in the HOLD status to prevent unintentional operations. Slide the HOLD · POWER ON/OFF switch towards the center to release the IC recorder from the HOLD status.

(See "[Releasing the HOLD function](#)")

Low Battery Level

You cannot format the memory or erase all the files in a folder because of insufficient battery power. Replace the old LR03 (size AAA) alkaline batteries with new ones.

(See "[Inserting batteries](#)")

Low Battery

The batteries are exhausted. Replace the old LR03 (size AAA) alkaline batteries with new ones.

(See "[Inserting batteries](#)")

Low Battery to Update

The software update cannot be done because of the insufficient battery power.

Replace the old LR03 (size AAA) alkaline batteries with new ones.

(See "[Inserting batteries](#)")

Memory Card Error

An error occurred while a memory card was being inserted into the memory card slot. Remove and try inserting it again. If this message persists, use a new memory card.

Memory Card Not Supported

A memory card that the IC recorder does not support is inserted.

(See "[About compatible memory cards.](#)")

Memory Card Locked

The memory card is write-protected. A write-protected memory card cannot be used with the IC recorder.

Read Only Memory Card

A read-only memory card is inserted. A read-only memory card cannot be used with the IC recorder.

Memory Card Access Denied

Since a memory card containing an access control function is inserted, you cannot use it.

Memory Full

The remaining memory capacity of the IC recorder is insufficient. Erase some files before recording.

(See [“Erasing a file”](#))

File Full

When there are already the maximum number of files in the selected folder or the total number of files stored on the IC recorder has exceeded the maximum, you cannot record a new file. Erase some files before recording.

(See [“Erasing a file”](#))

Track Marks are Full

You can set up to 98 track marks for a file. Cancel unwanted track marks.

(See [“Erasing a track mark”](#))

File Damaged

You cannot play back or edit files, because the data of the selected file is damaged.

Built-In Memory Needs to be Formatted / Memory Card Needs to be Formatted

The IC recorder cannot be turned on using the computer because there is no copy of the control file required for operation. Format the built-in memory or the memory card using the formatting function in the menu of the IC recorder. Do not use your computer to format the built-in memory or the memory card.

(See [“Formatting the memory \(Format\)”](#))

Process Error

- The IC recorder failed in memory access. Remove and then re-insert the batteries.
- Save a backup copy of your data and format the built-in memory or the memory card using the menu.
(See [“Formatting the memory \(Format\)”](#))

Stop and Reinsert Memory Card

A memory card was inserted during recording or playback. Remove the memory card and insert it while the IC recorder is in the stop mode.

Set Date&Time

Set the clock; otherwise, you cannot set the alarm.

No File

The selected folder does not have any files. You cannot move a file or set the alarm, etc., because of this.

No Track Marks

There are no track marks when you attempt to erase a track mark or track marks, or divide a file at all the track mark positions.

No Memory Card

There is no memory card inserted into the memory card slot when you attempt to set the “Select Memory” or “File Copy” menus.

File Protected

The selected file is protected or is a “Read only” file. You cannot erase it. Cancel the protection on the IC recorder or cancel “Read only” on your computer to edit the file using the IC recorder.

(See [“Protecting a file”](#))

Already Set

You set the alarm to play back a file at a date and time previously set on another file. Change the alarm setting.

Past Date/Time

You set the alarm when the time has already passed. Check it and set the appropriate date and time.

(See [“Playing back a file at a desired time with an alarm”](#))

Unknown Data



- This data is not in a file format that is supported by the IC recorder. The IC recorder supports MP3 (.mp3) files.
(See [“Design and specifications”](#))
- You cannot play back copyright protected files.

Set Add/Overwrite

“Add/Overwrite” in the menu is set to “OFF.” You cannot add a recording or an overwrite recording.

(See [“Adding a new segment to a previously recorded file”](#) and [“Adding an overwrite recording during playback”](#))



Invalid Operation

- You cannot divide or set a track mark in files in the folder in the playback-only area (the  tab and the  tab).
- When a memory card has a bad block on it, the card cannot be written to. Prepare a new memory card to replace the current one.
- The file name has reached the maximum number of characters; you cannot divide the file. Shorten the file name.
- The “Divide All Track Marks” function cannot be used because there is a track mark within 0.5 seconds from the dividing position.
- The “Divide All Track Marks” function cannot be used because there is a track mark within 0.5 seconds from the beginning of a file or the end of a file.
- The file length is less than 1 second; you cannot divide such a short file.
- The “Divide Current Position” function cannot be used at a position within 0.5 seconds from the beginning of a file or the end of a file.

New File

The file being recorded has reached the maximum size limit (500 MB). The file will be divided automatically and recording will continue as a new file.

Change Folder

If there are no files in the  or  folder, no folders are displayed in the display window. A folder containing a file will be displayed.

Cannot Divide - Exceeds Max 199 Files in Folder

When there are already 199 files in the selected folder or the total number of files stored on the IC recorder exceeds the maximum, you cannot divide a file. Erase some files before dividing a file.

(See [“Erasing a file”](#))

Same File Name Exists

A file of the same file name already exists in the folder, so a file cannot be created or renamed.

Erased Track Marks too near Divide Point

When there is a track mark set within 0.5 seconds from the dividing position, the track mark is automatically erased.

No operation with Memory Card

You cannot set an alarm in a file stored on a memory card. Switch the memory media of the IC recorder to “Built-In

Memory.”

(See “[Selecting the memory](#)”)

AVLS (For the European models only)

The volume of the playback sound exceeds the AVLS-specified level. Adjust the volume to a moderate level.

Scene Select Deactivated

When “Scene Select” in the menu is set to a value other than “OFF,” if you set “REC Mode,” “Mic Sensitivity,” “Recording Filter” and “VOR,” the setting of “Scene Select” is changed to “OFF” automatically.

(See “[Selecting a recording scene for each situation](#)”)

System Error

A system error other than the above has occurred. Remove the batteries and re-insert them.

[Go to Page Top](#)

[Notes on use](#)

4-534-070-11(1)

Copyright 2014 Sony Corporation

IC Recorder

ICD-PX440

[Back](#) | [Back to Top](#)

[Print](#)

System limitations

There are some system limitations of the IC recorder. Troubles as mentioned below are not malfunctions of the IC recorder.

You cannot display or play back music files in order.

If you have transferred music files using your computer, those files may not be transferred in order of transfer because of system limitations. If you transfer music files from your computer to the IC recorder one by one, you can display and play back the music files in transferred order.

A file is divided automatically.

The file being recorded has reached the maximum size limit (500 MB). Therefore it is automatically divided.

You cannot enter lowercase characters.

Depending on the combination of the characters used for the folder name that was made on your computer, those characters may change to all capitals.

Unreadable characters or “□” are displayed in a folder name, title, artist name, or file name.

A character which cannot be displayed on the IC recorder has been used. The IC recorder cannot support or display some special characters and symbols that are entered on a computer using Windows Explorer or the Mac Finder.

When you set A-B repeat playback, the set positions move a little.

Depending on the files, the set positions may move.

The remaining recording time becomes shorter when you divide a file.

You need a certain amount of free space for a file management area to divide a file, therefore the remaining recording time will be shortened.

[Go to Page Top](#)

[Notes on use](#)

Free Manuals Download Website

<http://myh66.com>

<http://usermanuals.us>

<http://www.somanuals.com>

<http://www.4manuals.cc>

<http://www.manual-lib.com>

<http://www.404manual.com>

<http://www.luxmanual.com>

<http://aubethermostatmanual.com>

Golf course search by state

<http://golfingnear.com>

Email search by domain

<http://emailbydomain.com>

Auto manuals search

<http://auto.somanuals.com>

TV manuals search

<http://tv.somanuals.com>