

MiniDisc Recorder

Operating Instructions



MDS-E58

WARNING

Notice for the Customers in the United Kingdom

IMPORTANT

The wires in this mains lead are coloured in accordance with the following code:

Blue : Neutral
Brown : Live

As the colours of the wires in the mains lead of this apparatus may not correspond with the coloured markings identifying the terminals in your plug, proceed as follows:

The wire which is coloured blue must be connected to the terminal which is marked with the letter N or coloured black.

The wire which is coloured brown must be connected to the terminal which is marked with the letter L or coloured red. Do not connect either wire to the earth terminal in the plug which is marked by the letter E or by the safety earth symbol \perp or coloured green or green-and-yellow.

To prevent fire or shock hazard, do not expose the unit to rain or moisture.

To avoid electrical shock, do not open the cabinet. Refer servicing to qualified personnel only.

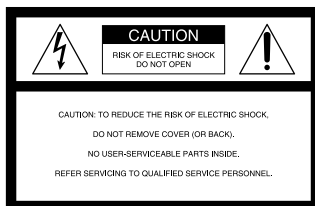

This symbol is intended to alert the user to the presence of uninsulated "dangerous voltage" within the product's enclosure that may be of sufficient magnitude to constitute a risk of electric shock to persons.



This symbol is intended to alert the user to the presence of important operating and maintenance (servicing) instructions in the literature accompanying the appliance.

* The location of the marking is at the rear of the enclosure.

INFORMATION

This equipment has been tested and found to comply with the limits for a Class B digital device, pursuant to Part 15 of the FCC Rules. These limits are designed to provide reasonable protection against harmful interference in a residential installation. This equipment generates, uses, and can radiate radio frequency energy and, if not installed and used in accordance with the instructions, may cause harmful interference to radio communications.

However, there is no guarantee that interference will not occur in a particular installation. If this equipment does cause harmful interference to radio or television reception, which can be determined by turning the equipment off and on, the user is encouraged to try to correct the interference by one or more of the following measures:

- Reorient or relocate the receiving antenna.
- Increase the separation between the equipment and receiver.
- Connect the equipment into an outlet on a circuit different from that to which the receiver is connected.
- Consult the dealer or an experienced radio / TV technician for help.

Precautions

On safety (Refer to the supplied "WARNING".)

Should any solid object or liquid fall into the cabinet, unplug the recorder and have it checked by qualified personnel before operating it any further.

On power sources

- Before operating the recorder, check that the operating voltage of the recorder is identical with your local power supply. The operating voltage is indicated on the nameplate at the rear of the recorder.
- If you are not going to use the recorder for a long time, be sure to disconnect the recorder from the wall outlet. To disconnect the AC power cord, grasp the plug itself; never pull the cord.
- AC power cord must be changed only at the qualified service shop.

On operation

If the recorder is brought directly from a cold to a warm location, or is placed in a very damp room, moisture may condense on the lenses inside the recorder. Should this occur, the recorder may not operate properly. In this case, remove the MD and leave the recorder turned on for about an hour until the moisture evaporates.

On the MiniDisc cartridge

- Do not open the shutter to expose the MD.
- Do not place the cartridge where it will be subject to extremes of sunlight, temperature, moisture or dust.

On cleaning

Clean the cabinet, panel and controls with a soft cloth slightly moistened with a mild detergent solution. Do not use any type of abrasive pad, scouring powder or solvent such as alcohol or benzene.

If you have any questions or problems concerning your recorder, please consult your nearest Sony dealer.

Welcome!

Thank you for purchasing the Sony MiniDisc Recorder. Before operating the recorder, please read this manual thoroughly and retain it for future reference.

About This Manual

Conventions

- Controls in the instructions are those on the recorder; these may, however, be substituted by controls on the remote that are similarly named or, when different, appear in the instructions within brackets.
- The following icons are used in this manual:



Indicates a procedure that requires use of the remote.



Indicates tips for making the task easier and hints.

TABLE OF CONTENTS

Getting Started

Unpacking	4
Connection	4

Basic Operations

Recording on an MD	6
Playing an MD	8

Recording on MDs

Notes on Recording	9
Useful Tips for Recording	9
Recording Over Existing Tracks	11
Adjusting the Recording Level	11
Marking Track Numbers While Recording (Track Marking)	12
Starting Recording With 6 Seconds of Prestored Audio Data (Time Machine Recording)	12
Synchro-Recording With Audio Equipment of Your Choice	13
Synchro-Recording With a Sony CD Player	14

Playing MDs

Using the Display	15
Locating a Specific Track	16
Locating a Particular Point in a Track	17
Playing Tracks Repeatedly	17
Playing Tracks in Random Order (Shuffle Play)	18
Creating Your Own Program (Program Play)	19
Useful Tips When Recording From MDs to Tape	20

Editing Recorded MDs

Notes on Editing	20
Erasing Recordings (Erase Function)	20
Dividing Recorded Tracks (Divide Function)	22
Combining Recorded Tracks (Combine Function)	23
Moving Recorded Tracks (Move Function)	24
Labeling Recordings (Title Function)	24
Undoing the Last Edit (Undo Function)	27

Additional Information

Function of Control Terminal	27
Dimensions	28
Display Messages	29
System Limitations	29
Troubleshooting	30
Specifications	31
Index of Parts and Controls	32
Guide to the Serial Copy Management System	33

Unpacking

Check that you received the following items:

- Remote commander (remote) RM-D7M (1)
- R6 (size AA) batteries (2)

Inserting batteries into the remote

You can control the recorder using the supplied remote.

Insert two R6 (size AA) batteries by matching the + and - on the batteries. When using the remote, point it at the remote sensor  on the recorder.

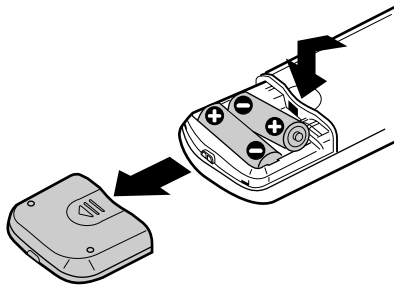

When to replace batteries

With normal use, the batteries should last for about six months. When the remote no longer operates the recorder, replace all the batteries with new ones.

Notes

- Do not leave the remote near an extremely hot or humid place.
- Do not drop any foreign object into the remote casing, particularly when replacing the batteries.
- Do not expose the remote sensor to direct sunlight or lighting apparatuses. Doing so may cause a malfunction.
- If you don't use the remote for an extended period of time, remove the batteries to avoid possible damage from battery leakage and corrosion.

Connection

Overview

This section describes how to hook up the MD recorder to other components such as a mixer, CD player or DAT recorder. Be sure to turn off the power of each component before connection.

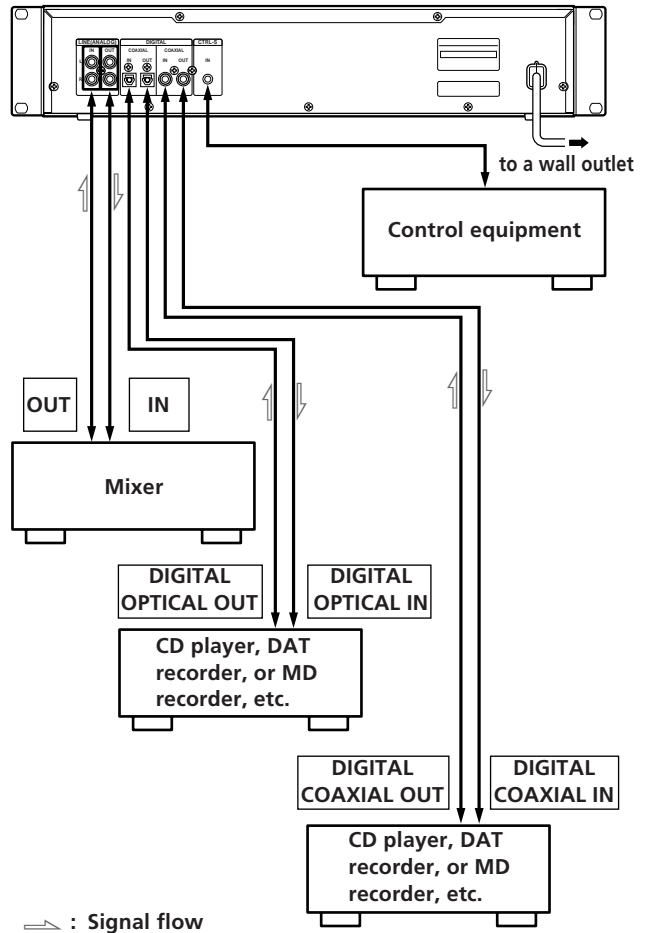

What cords will I need?

- Audio connecting cords (pin type)

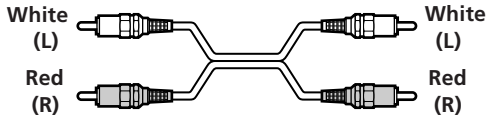

- Optical cable

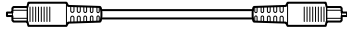

- Coaxial digital connecting cable

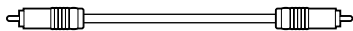

- Control-S cord (mini jack type)

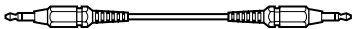

Connection

Connecting the recorder to a mixer

Connect the mixer to the LINE (ANALOG) IN/OUT jacks using the audio connecting cords. Be sure to match the color-coded cords to the appropriate jacks on the components: red (right) to red and white (left) to white. Be sure to make connections firmly to prevent hum and noise.

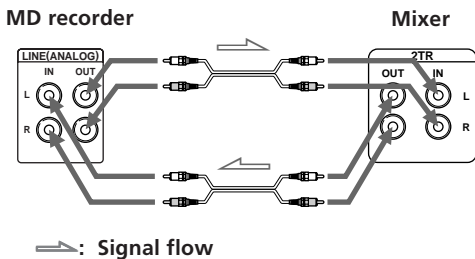

Connecting the recorder to a digital component such as a CD player, DAT recorder, another MD recorder, or mixer

Connect the component through the DIGITAL IN/OUT connectors with two optical cables or coaxial digital connecting cables.

- Using the optical cables

Take the caps off the connectors before plugging in the cables.

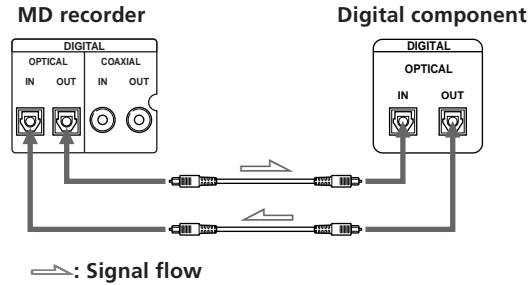

- Using the coaxial digital connecting cables

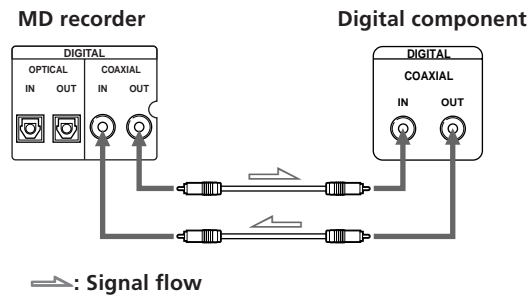

Automatic conversion of digital sampling rates during recording

A built-in sampling rate converter automatically converts the sampling frequency of various digital sources to the 44.1 kHz sampling rate of your MD recorder.

This allows you to record sources such as 32 and 48 kHz DAT or satellite broadcasts, as well as compact discs and other MDs.

Connecting the AC power cord

Connect the AC power cord to a wall outlet.

Recording on an MD

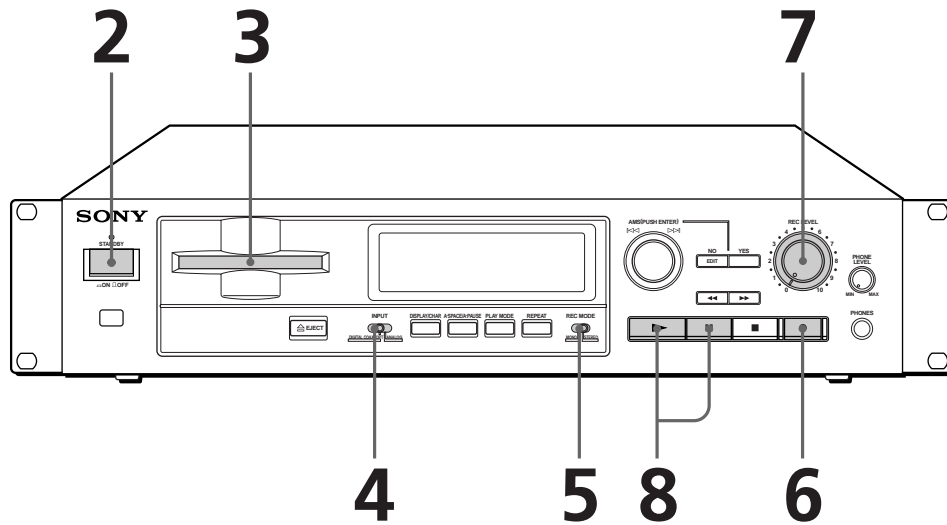

1 Turn on the mixer and program source.

2 Press ①.

3 Insert a recordable MD.

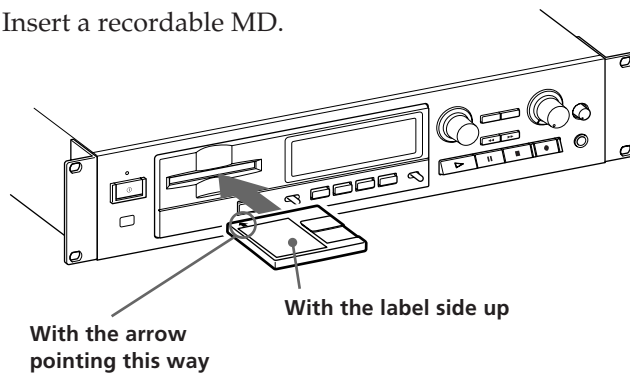

If the MD has a recorded material on it, the recorder will automatically start recording from the end of the last recorded track.

4 Set INPUT to the corresponding input connector.

To record through	Set INPUT to
DIGITAL IN	COAXIAL
	OPTICAL
LINE (ANALOG) IN	ANALOG

5 Set REC MODE to the mode you want to record in.

To record in	Set REC MODE to
Stereo sound	STEREO
Monaural sound*	MONO

* In the monaural recording, you can record about two times longer than in the stereo recording.

Monitor audio during recording

Even if you set REC MODE to MONO, the monitor signal does not become monaural.

6 Press ●.
The recorder stands by for record.

7 When recording the analog input signal, adjust the recording level with REC LEVEL.
The fourth dot is satisfactory for most purposes. For details, refer to "Adjusting the Recording Level" on page 11.

8 Press ▷ or ■.
Recording starts.

9 Start playing the program source.

When "TOC" flashes in the display

The recorder is currently updating the Table Of Contents (TOC). Do not turn off the power, move the recorder, or pull out the AC power cord, while "TOC" is flashing. Changes to an MD made through recording are saved only when you update the TOC by ejecting the MD.

Do not turn off the power or disconnect the recorder from the power source immediately after recording.

If you do, recorded material may not be saved to the MD. To save the material, after recording, press ⏏ EJECT to take out the MD. "TOC" will flash in the display at this time. After "TOC" stops flashing and is unlit, you can turn off the power or pull out the AC power cord.

To	Press
Stop recording	■
Pause recording*	■. Press the button again or press ▷ to resume recording.
Take out the MD	⏏ EJECT after stopping recording

* Whenever you pause recording, the track number increases by one. For example, if you paused recording while recording on track 4, the track number increases by one and recording continues on the new track when restarted.

To protect an MD against accidental erasure

To make it impossible to record on an MD, slide the tab in the direction of arrow, opening the slot. To allow recording, close the slot.

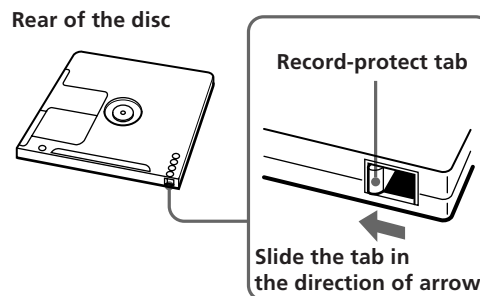

Note

If you switch REC MODE during recording or recording pause, recording stops.

Playing an MD

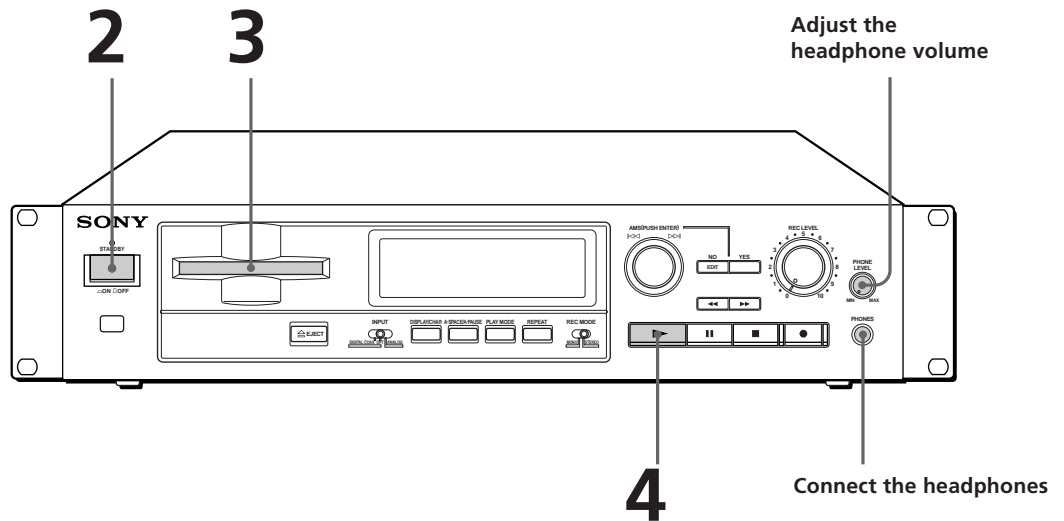

1 Turn on the mixer and adjust the fader or level control of the corresponding channel.

2 Press **AMS**.

3 Insert an MD.

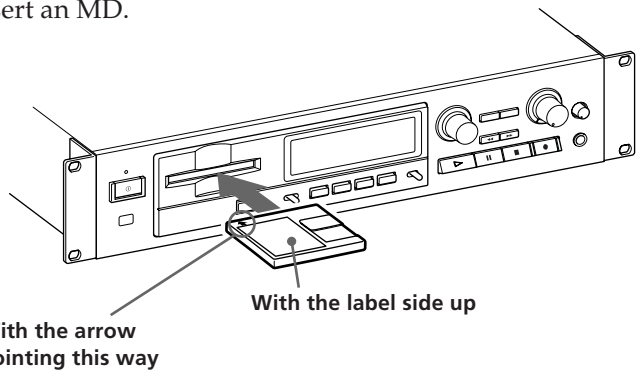

4 Press **▶**.
The recorder starts playing.

💡 You can locate and play back a track while the recorder is stopped

- 1 Turn AMS (or press **◀◀** or **▶▶** on the remote) until the number of the desired track appears.
- 2 Press AMS or **▶**.

💡 **To use headphones**
Connect them to PHONES jack. Use PHONE LEVEL to adjust the volume.

To	Do the following:
Stop playing	Press ■ .
Pause playing	Press ⏸ . Press the button again or press ▶ to resume playing.
Go to the next track	Turn AMS clockwise (or press ▶▶ on the remote).
Go to the preceding track	Turn AMS counterclockwise (or press ◀◀ on the remote).
Take out the MD	Press ⏏ EJECT.

Notes on Recording

If "Protected" appears in the display

The MD is record-protected. Close the slot to record on the disc (see "To protect an MD against accidental erasure" on page 7).

If "Din Unlock" flashes in the display

- The digital program source which you set with INPUT in Step 4 on page 6, is not connected.
To continue, connect the program source properly.
- The program source is not on.
Turn on the program source.

Depending on the source being recorded, track numbers are marked in the following ways:

- When recording from a CD or MD with INPUT set to DIGITAL and the source connected through DIGITAL IN: The recorder automatically marks track numbers in the same sequence as the original. If, however, a track is repeated two or more times (e.g. by single-track repeat play) or two or more tracks with the same track number (e.g. from different MDs or CDs) are played, the track or tracks are recorded as a single, continuous track with a single track number.
If the source is an MD, track numbers may not be marked for tracks of less than 4 seconds.
- When recording from a source connected through LINE (ANALOG) IN with INPUT set to ANALOG, and "LEVEL- SYNC" does not light up (see "Marking Track Numbers While Recording" on page 12) or when recording from DAT or satellite broadcasts connected through DIGITAL IN with INPUT set to DIGITAL: The source will be recorded as a single track. You can divide the track afterwards using the Divide Function (see "Dividing Recorded Tracks" on page 22) or mark track numbers during recording by using the Track Marking Function on page 12.
If "LEVEL-SYNC" appears in the display, the recorder automatically marks track numbers when recording analog source or digital recording of DAT or satellite broadcasts (see "Marking track numbers automatically" on page 12).
- When recording from DAT or satellite broadcasts with INPUT set to DIGITAL, the recorder automatically marks a track number whenever the sampling frequency of the input signal changes.

When "TOC" flashes in the display

The recorder is currently updating the Table Of Contents (TOC). Do not turn off the power, move the recorder, or pull out the AC power cord. Changes to an MD made through recording are saved when you update the TOC by ejecting the MD.

When the PLAY MODE is PROGRAM or SHUFFLE

The PLAY MODE is switched to CONTINUE automatically.

If "Cannot Copy" appears in the display

The recorder uses the SCMS (Serial Copy Management System).

MDs recorded through digital input connector cannot be copied onto other MDs or DAT tapes through the digital output connector (see page 33).

When recording digital signals that have been emphasized (in the higher frequencies)

The signal is automatically de-emphasized (with attenuation proportional to the degree of emphasis) and the level of the de-emphasized signal is indicated on the peak level meters.

When the recorder is recording or in recording pause, digital signals input through DIGITAL IN are output to DIGITAL OUT with the same sampling rate.

To change the digital input signal to another sampling rate for output (without recording it to an MD), use Input Monitor Function (see page 10).

Useful Tips for Recording

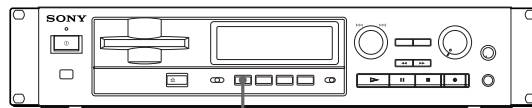

DISPLAY/CHAR

Checking the remaining recordable time on the MD

- When you press DISPLAY/CHAR repeatedly while recording, the display changes as follows: elapsed recording time, remaining recordable time on the MD, track name.
- When you press DISPLAY/CHAR repeatedly while the recorder is stopped, the display changes as follows: total recorded time, remaining recordable time on the MD, disc name (see page 15).

(Continued)

Monitoring the input signal (Input Monitor)

Before starting recording, you can monitor the selected input signal through the recorder's output connectors.

- 1 Press EJECT to remove the MD.
- 2 Set INPUT according to the input signal you want to monitor.

When INPUT is set to ANALOG

The analog signal input through LINE (ANALOG) IN is output to DIGITAL OUT after A/D conversion, and then to the LINE (ANALOG) OUT connectors and PHONES jack after D/A conversion.

When INPUT is set to DIGITAL

The digital signal input through DIGITAL IN is output to DIGITAL OUT, and then to the LINE (ANALOG) OUT connectors and PHONES jack after D/A conversion.

Note

Even if you set REC MODE to MONO, the monitor signal does not become monaural.

- 3 Press .
If INPUT is set to ANALOG, "AD-DA" appears in the display.
If INPUT is set to DIGITAL, "-DA" appears in the display.

If "Auto Cut" appears in the display (Auto Cut)

There has been no sound input for 30 seconds while INPUT is set to DIGITAL and the source is connected through DIGITAL IN. The 30 seconds of silence are replaced by a blank of about 3 seconds and the recorder changes to recording pause.



You can turn off the Auto Cut Function

For details, see "If "Smart Space" appears in the display" below.

If "Smart Space" appears in the display (Smart Space)

When there has been an extended silence of up to 30 seconds in length, and the signal is input again, the silence is replaced by a blank of about 3 seconds and the recorder continues recording.

Note

However, if you begin recording during such an extended silent portion, the smart space function will not be activated.

To turn off the Smart Space Function and Auto Cut Function

- 1 While the recorder is stopped, press EDIT/NO twice to display "Setup Menu".
- 2 Turn AMS until "S. Space" menu appears in the display, then press AMS.
- 3 Turn AMS until "S. Space Off" appears in the display, then press AMS.
- 4 Press EDIT/NO.

To turn on the Smart Space Function and Auto Cut Function again

- 1 Carry out Steps 1 and 2 in "To turn off the Smart Space Function and Auto Cut Function" above.
- 2 Turn AMS until "S. Space On" appears in the display, then press AMS.
- 3 Press EDIT/NO.

Notes



- When you turn off the Smart Space Function, the Auto Cut Function is also turned off automatically.
- The Smart Space Function and Auto Cut Function are factory set to on.
- The Smart Space Function does not affect the order of the track numbers being recorded, even if the blank space occurs in the middle of a track.
- If you turn off the recorder or disconnect the AC power cord, the recorder will recall the last setting (on or off) of the Smart Space and Auto Cut Functions the next time you turn on the recorder.

Playing back tracks just recorded

Follow this procedure to play back tracks that have just been recorded.

Press  immediately after stopping recording. Playback starts from the first track of the material just recorded.

To play from the first track of the MD after recording

- 1 Press  again after stopping recording.
- 2 Press .
Playback starts from the first track of the MD.

Recording Over Existing Tracks

Follow the procedure below to record over existing material just as you would on an analog cassette tape.

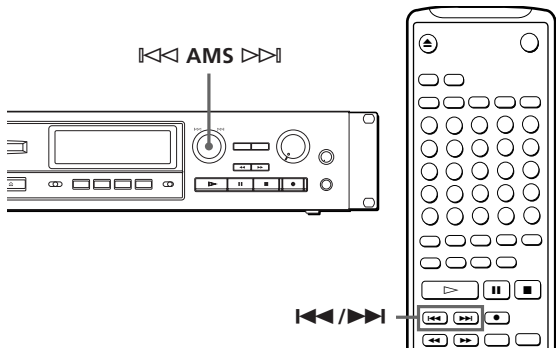

- 1 Carry out Steps 1 to 5 in "Recording on an MD" on page 6.
- 2 Turn AMS (or press ◀◀ or ▶▶) until the number of the track to be recorded over appears.
- 3 To record from the start of the track, continue from Step 6 in "Recording on an MD" on page 7.

⚡ While "TRACK" flashes in the display

The recorder is recording over an existing track, and stops flashing when it reaches the end of the recorded portion.

⚡ To record from the middle of the track

- 1 After Step 2 above, press ▷ to start playback.
- 2 Press || where you want to start recording.
- 3 Continue from Step 6 in "Recording on an MD" on page 7.

Note

You cannot record from the middle of an existing track when "PROGRAM" or "SHUFFLE" is displayed/lit.

Adjusting the Recording Level

When recording with INPUT set to ANALOG and the signal input through LINE (ANALOG) IN jacks, use REC LEVEL to adjust the recording level before starting recording.

You cannot adjust the recording level during digital recording.

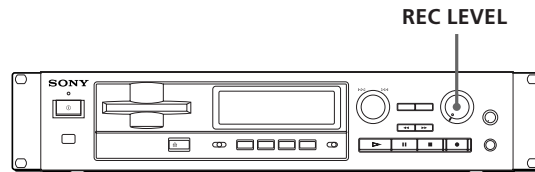

- 1 Carry out Steps 1 to 6 in "Recording on an MD" on pages 6 and 7.
- 2 Play the portion of the program source with the strongest signal level.
- 3 While monitoring the sound, turn REC LEVEL to adjust the recording level so that the peak level meters reach their highest point without turning on the OVER indication. Occasional lighting of "OVER" is acceptable.

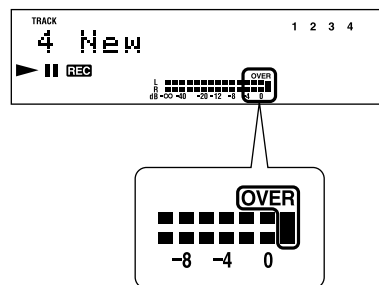

- 4 Stop playing the program source.
- 5 To start recording, follow the procedure starting from Step 8 in "Recording on an MD" on page 7.

Marking Track Numbers While Recording (Track Marking)

You can mark track numbers either manually or automatically. By marking track numbers at specific points, you can quickly locate the points later using the AMS Function or Editing Functions.

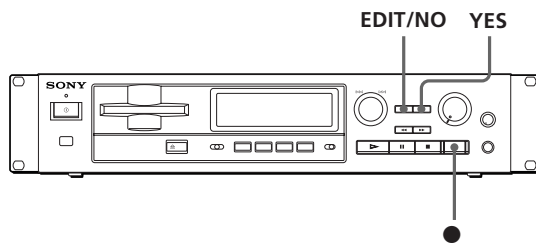

Marking track numbers manually (Manual Track Marking)

You can mark track numbers at any time while recording on an MD.

Press ● at the place you want to add a track mark while recording.

Marking track numbers automatically (Automatic Track Marking)

The recorder adds track marks differently in the following cases:

- When recording from CDs or MDs with INPUT set to DIGITAL and the source connected through DIGITAL IN:
The recorder marks track numbers automatically. When you record from a CD or MD, the track numbers are marked as they are found on the original.
- **In the case other than the above**
While "LEVEL-SYNC" appears in the display, the recorder marks a new track number whenever the signal level drops and rises to a certain point (Automatic Track Marking). If "LEVEL-SYNC" does not light up, set the LevelSync to ON as follows:

To display "LEVEL-SYNC"

- 1 While the recorder is stopped, press EDIT/NO twice to display "Setup Menu".
- 2 Turn AMS until "LevelSync?" appears in the display, then press AMS.
- 3 Turn AMS until "LevelSync ON" appears in the display, then press AMS.
- 4 Press EDIT/NO.

To cancel Automatic Track Marking

- 1 Carry out Steps 1 and 2 in "To display "LEVEL-SYNC"" above.
- 2 Turn AMS until "LevelSync OFF" appears in the display, then press AMS.
- 3 Press EDIT/NO.

💡 When you want to mark track numbers after you've finished recording

Use the Divide Function (see "Dividing Recorded Tracks" on page 22.)

Note

If you turn off the recorder or disconnect the AC power cord, the recorder will recall the last setting (LevelSync ON or OFF) of the Automatic Track Marking Function the next time you turn on the recorder.

Starting Recording With 6 Seconds of Prestored Audio Data (Time Machine Recording)

When recording from an FM or satellite broadcast, the first few seconds of material are often lost due to the time it takes you to ascertain the contents and press the record button. To prevent the loss of this material, the Time Machine Recording Function constantly stores 6 seconds of the most recent audio data in the buffer memory so that when you begin recording the program source, the recording actually begins with the 6 seconds of audio data stored in the buffer memory in advance, as shown in the illustration below:

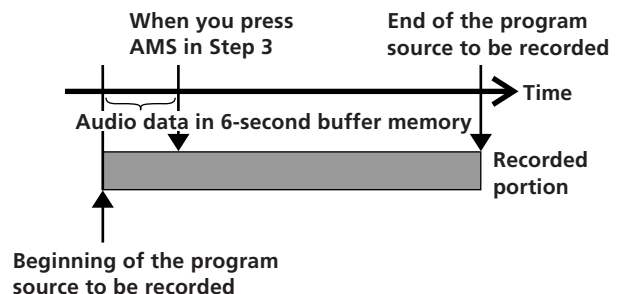

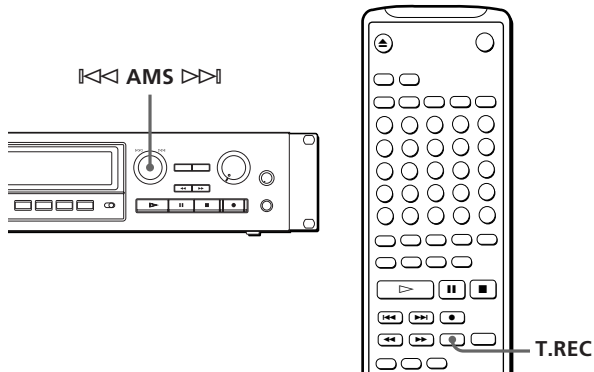

- 1** Carry out Steps 1 to 6 in “Recording on an MD” on pages 6 and 7.
The recorder changes to recording pause.
- 2** Start playing the program source you want to record.
The most recent 6 seconds of audio data is stored in the buffer memory.
- 3** Press AMS (or T.REC) to start Time Machine Recording.
Recording of the program source starts with the 6 seconds of audio data stored in the buffer memory.

To stop Time Machine Recording

Press ■.

Note

The recorder starts storing audio data when the recorder is in recording pause and you start playing the program source. With less than 6 seconds of playing of the program source and audio data stored in the buffer memory, Time Machine Recording starts with less than 6 seconds of audio data.

Synchro-Recording With Audio Equipment of Your Choice

By using the MUSIC SYNC button on the remote, you can automatically start a Synchronized recording with the signal input from the program source through the input jacks.

The method of marking track numbers differs, depending on the program source being recorded and how the recorder is connected to the program source. (See “Notes on Recording” on page 9.)

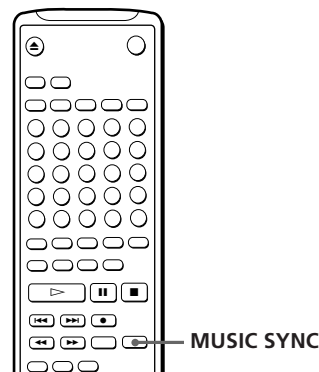

- 1** Carry out Steps 1 to 5 in “Recording on an MD” on page 6.
- 2** Press MUSIC SYNC.
The recorder changes to recording pause.
- 3** Start playing the program source you want to record.
The recorder starts recording automatically.

To stop Music Synchro-Recording

Press ■.

Note

During Music Synchro-Recording, the Smart Space Function and the Auto Cut Function turn on automatically regardless of their settings (ON or OFF) and type of input (digital or analog).

Synchro-Recording With a Sony CD Player

By connecting your recorder to a Sony CD player, you can easily dub CDs onto MDs using the CD synchro buttons on the remote. If your recorder is connected to a Sony CD player by a digital input cable, track numbers are automatically marked as on the original, regardless of whether "LevelSync ON" or "LevelSyncOFF" is selected. If your recorder is connected to a Sony CD player by audio connecting cords through LINE (ANALOG) IN, track numbers are automatically marked when you select "LevelSync ON" (see "Marking Track Numbers While Recording" on page 12).

As the same remote controls both the CD player and the recorder, you may have trouble operating both units if they are far from each other. If you do, place the CD player close to this recorder.

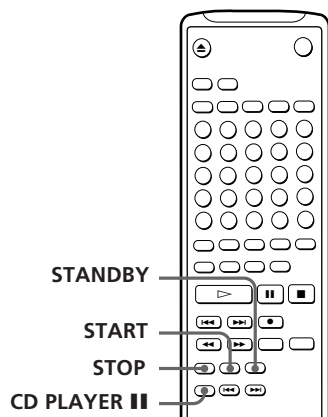

- 1** Turn on the CD player and the mixer.
- 2** Carry out Steps 2 to 5 in "Recording on an MD" on page 6 to prepare the recorder for recording.
- 3** Insert a CD into the CD player.
- 4** Select the playback mode (Shuffle Play, Program Play, etc.) on the CD player.
- 5** Press STANDBY.
The CD player pauses for playing and the recorder pauses for recording.

- 6** Press START.
The recorder starts recording and the CD player starts playback.
The track number and elapsed recording time of the track appear in the display.

If the CD player does not start playing

Some CD player models may not respond when you press START on the remote of the recorder. Press **II** on the remote of the CD player instead.

- 7** Press STOP to stop synchro-recording.

To pause recording

Press STANDBY or CD PLAYER **II**.

To restart recording, press START or CD PLAYER **II**. A new track number is marked each time you pause recording.

You can use the remote of the CD player during synchro-recording

When you press **■**, the CD player stops and the recorder pauses for recording.
When you press **II**, the CD player pauses and the recorder pauses for recording.
To restart synchro-recording, press **▷**.

You can change CDs during synchro-recording

Carry out the following steps instead of Step 7 above.

- 1** Press **■** on the remote of the CD player.
The recorder pauses for recording.
- 2** Change the CD.
- 3** Press **▷** on the remote of the CD player.
Synchro-recording restarts.

You can also do synchro-recording with a Sony video CD player

Using the procedure for synchro-recording with a Sony CD player, you can do synchro-recording with a Sony video CD player also.
To select the video CD player, press button number 2 while pressing down the POWER button before starting the procedure.
To select the CD player again, press button number 1 while pressing down the POWER button.
The recorder is factory set to CD player for synchro-recording.

You can check the remaining recordable time on the MD

Press DISPLAY/CHAR (or DISPLAY) (see page 15).

Using the Display

You can use the display to check disc and track information such as the total track number, total playing time of the tracks, remaining recordable time of the disc and disc name.

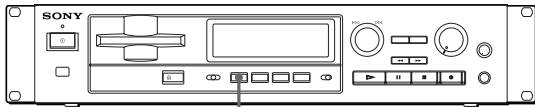

DISPLAY/CHAR

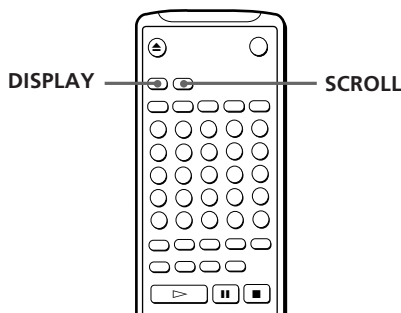

DISPLAY

SCROLL

Checking the total track number, total disc playing time, remaining recordable time of the disc and the title of the disc

Each time you press DISPLAY/CHAR (or DISPLAY) while the recorder is stopped, you can change the display as follows:

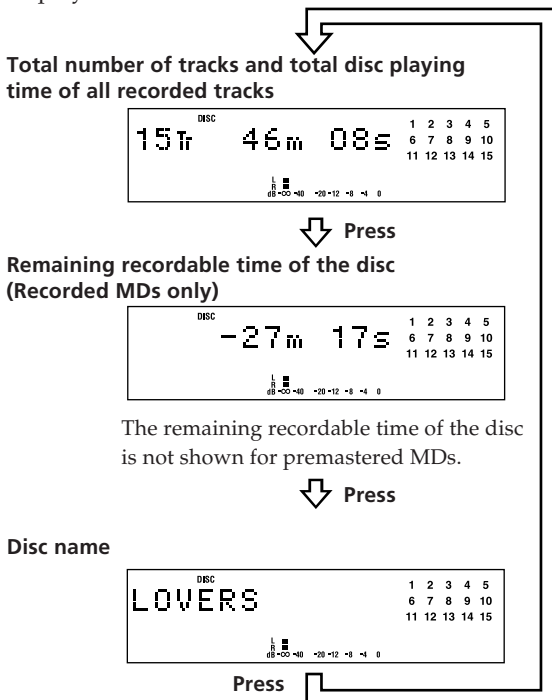

When you insert an MD, the disc name, total number of tracks, and total disc playing time appear in the display as follows:

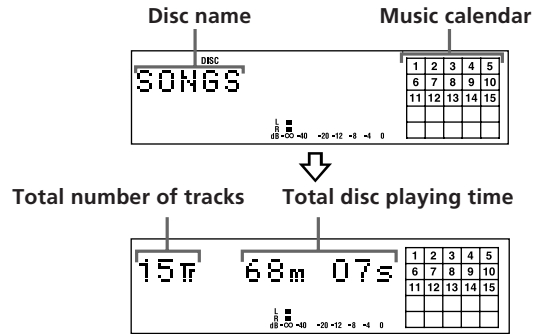

The disc name appears, followed by the total number of tracks (Tr) and total disc playing time. A music calendar showing all the track numbers appears within a grid if the MD is a mastered disc, or without a grid if the MD is a recordable disc. If the total track number exceeds 25, z appears to the right of number 25 in the music calendar. To label a recordable disc and its tracks, see "Labeling Recordings" on page 24.

Note

When you insert a new MD or turn off the recorder and turn it on again, the last item displayed will reappear. However, if you disconnect the AC power cord, the display will show the total number of tracks and total disc playing time of all recorded tracks the next time you turn on the recorder, no matter what the last display was.

Checking remaining time and the title of a track

Each time you press DISPLAY/CHAR (or DISPLAY) while playing an MD, you can change the display as shown below. The track numbers in the music calendar disappear after they are played.

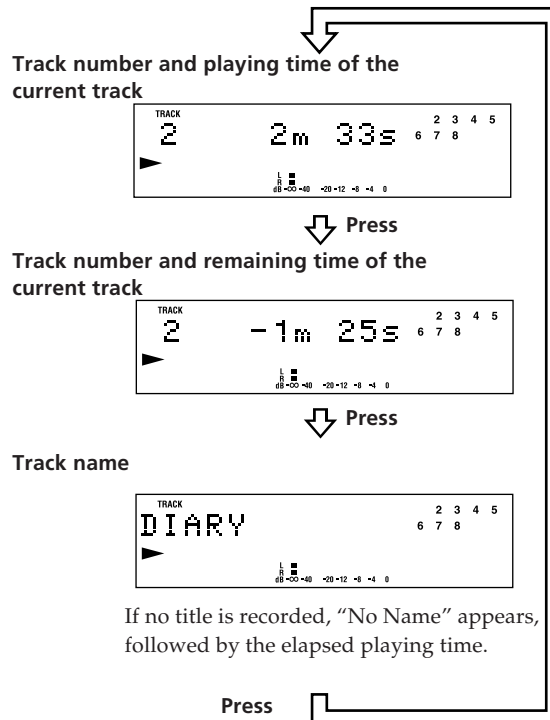

If no title is recorded, "No Name" appears, followed by the elapsed playing time.

(Continued)

💡 You can check the track name at any time while playing an MD

Press SCROLL on the remote.

Since the display shows up to 12 characters at a time, press SCROLL again to see the rest of the track title if the title has 13 characters or more.

Press SCROLL again to pause scrolling, and again to continue scrolling.

💡 When you directly locate a track with a number over 25

You must press >25 first, before entering the corresponding digits.

Press >25 once if it is a 2-digit track number, and twice if it is a 3-digit track number.

To enter "0," press button 10.

Examples: • To play track number 30
Press >25 once, then 3 and 10.

• To play track number 100
Press >25 twice, then 1, 10 and 10.

Locating a Specific Track

You can quickly locate any track while playing a disc by using AMS (Automatic Music Sensor), **⏮** and **⏭**, number buttons or M.SCAN on the remote.

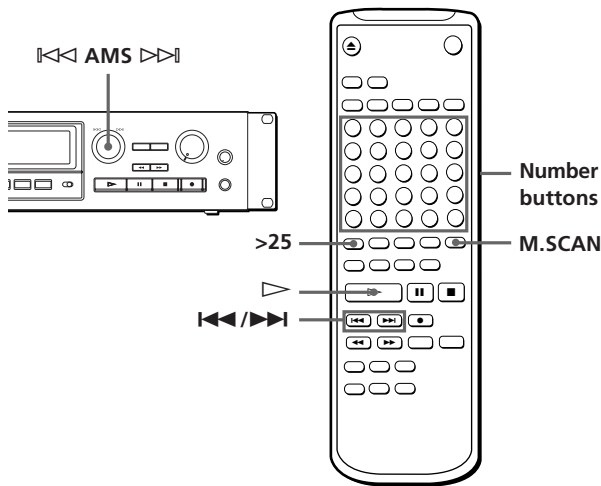

💡 You can change the playing time during music scan

- 1 While the recorder is stopped, press EDIT/NO to display "Setup Menu."
- 2 Turn AMS until "M. Scan" menu appears in the display, then press AMS.
- 3 Turn AMS to select the length of the M.SCAN play within the range of 6 to 20 seconds, using steps of about one second, then press AMS.
- 4 Press EDIT/NO.

💡 To pause playing at the beginning of a track

Turn AMS (or press **⏮** or **⏭**) after pausing playback.

💡 To go quickly to the beginning of the last track

Turn AMS counterclockwise (or press **⏮**) while the display shows the total number of tracks and total disc playing time, remaining recordable time of the disc, or disc name (see page 15).

To locate	Do the following:
The next or succeeding tracks	During playback, turn AMS clockwise (or press ⏭ repeatedly) until you find the desired track.
The current or preceding tracks	During playback, turn AMS counterclockwise (or press ⏮ repeatedly) until you find the desired track.
A specific track directly	Press number buttons to enter the track number.
A specific track by using AMS	<ol style="list-style-type: none"> 1 Turn AMS until the desired track number appears while the recorder is stopped. (The track number is flashing.) 2 Press AMS or ▷.
By scanning each track (music scan)	<ol style="list-style-type: none"> 1 Press M.SCAN before you start playing. 2 When you find the desired track, press ▷ to start playing.

Locating a Particular Point in a Track

You can also use ◀◀ and ▶▶ to locate a particular point in a track during playback or playback pause.

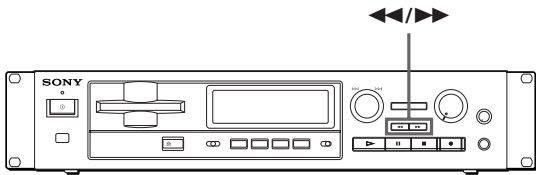

To locate a point	Press
While monitoring the sound	▶▶ (forward) or ◀◀ (backward) and keep pressing until you find the desired point.
Quickly by observing the display during playback pause (high speed search)	▶▶ or ◀◀ and hold until you find the desired point. There is no sound output during this operation.

💡 When "OVER" appears during high speed search
 If the disc reaches the end while you are pressing ▶▶ during playback pause, "OVER" appears in the display. Press ◀◀ (or press ◀◀) or turn AMS (or press ◀◀) counterclockwise to go back.

Notes

- If the disc reaches the end while you are pressing ▶▶ during sound monitoring, the recorder stops.
- Tracks that are only a few seconds long may be too short to scan using the search function. For such tracks, it is better to play the MD at normal speed.

Playing Tracks Repeatedly

You can play tracks repeatedly in any play mode.

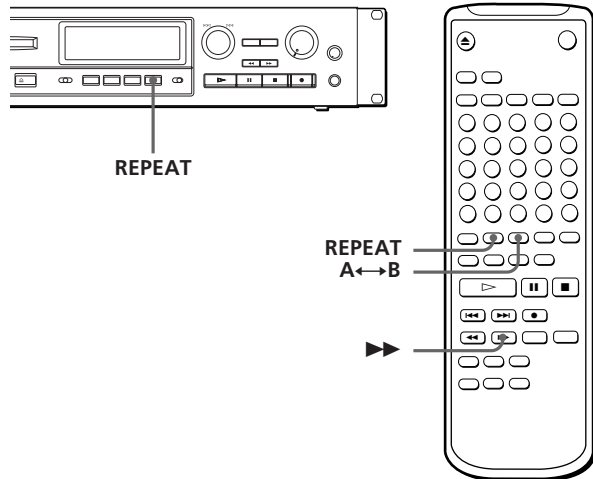

Press REPEAT.
 "REPEAT" appears in the display.
 The recorder repeats the tracks as follows:

When the MD is played in	The recorder repeats
Normal play (page 8)	All the tracks
Shuffle Play (page 18)	All the tracks in random order
Program Play (page 19)	The same program

To cancel repeat play

Press REPEAT several times until "REPEAT" disappears.
 The recorder returns to the original playing mode.

Repeating the current track

While the track you want to repeat is playing in normal play, press REPEAT several times until "REPEAT 1" appears in the display.

(Continued)

Repeating a specific portion (A-B Repeat)



You can play a specific portion of a track repeatedly. This might be useful when you want to memorize lyrics.

Note that you can only repeat a portion within the boundaries of a single track.

- 1 While playing a disc, press A↔B at the starting point (point A) of the portion to be played repeatedly.
"REPEAT A-B" flashes in the display.
- 2 Continue playing the track or press ►► until you reach the ending point (point B), then press A↔B again.
"REPEAT A-B" lights continuously. The recorder starts to play the specified portion repeatedly.

To cancel A-B Repeat

Press REPEAT or ■.

Setting new starting and ending points

You can repeat the portion immediately after the currently specified portion by changing the starting and ending points.

- 1 Press A↔B while "REPEAT A-B" appears.
The current ending point B becomes the new starting point A and "REPEAT A-B" flashes in the display.
- 2 Continue playing the track or press ►► until you reach the new ending point (point B), then press A↔B again.
"REPEAT A-B" lights continuously and the recorder starts playing the newly specified portion repeatedly.

Note

If you turn off the recorder or disconnect the AC power cord, the recorder will recall the last setting of the Repeat Function the next time you turn on the recorder.

The A-B Repeat settings, however, are lost.

Playing Tracks in Random Order (Shuffle Play)

You can have the recorder "shuffle" tracks and play them in random order.

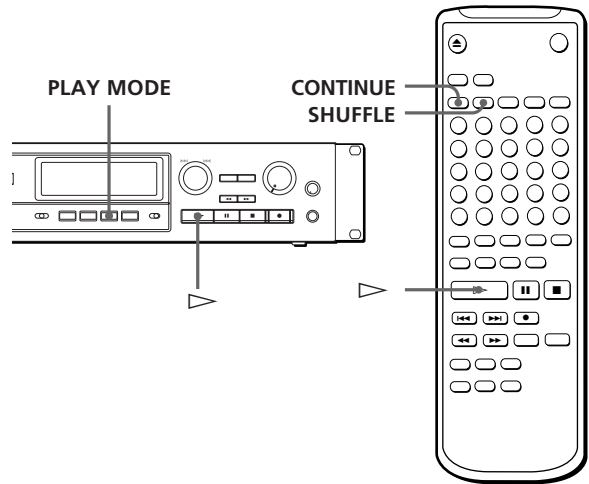

- 1 Press PLAY MODE repeatedly (or SHUFFLE once) until "SHUFFLE" appears in the display when the recorder is stopped.
- 2 Press ▷ to start Shuffle Play.

To cancel Shuffle Play

When the recorder is stopped, press PLAY MODE repeatedly (or CONTINUE once) until "SHUFFLE" disappears.



You can specify tracks during Shuffle Play

- To play the next track, turn AMS clockwise (or press ►►).
- To play from the beginning of the current track again, turn AMS counterclockwise (or press ◀◀). You cannot use AMS (or ◀◀) to go to tracks that have already been played.

Creating Your Own Program (Program Play)

You can specify the playback order of the tracks on an MD and create your own programs containing up to 25 tracks.

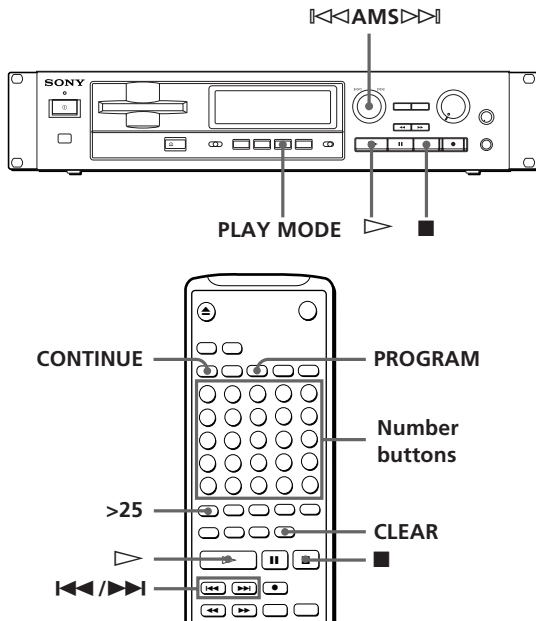

- 1 Press PLAY MODE repeatedly (or PROGRAM once) until "PROGRAM" appears in the display when the recorder is stopped.
- 2 Carry out either a) or b):
 - a) **When using the remote**
Press the number buttons to enter the tracks you want to program in the order you want. To program a track with a number over 25, use the >25 button (see page 16).
If you've made a mistake
Press CLEAR, then press the correct number button.
 - b) **When using the controls on the recorder**
 - 1 Turn AMS until the track number you want appears in the display.
 - 2 Press AMS.
- 3 Repeat Step 2 to enter other tracks. Each time you enter a track, the total program time is calculated and appears in the display.
- 4 Press ▷ to start Program Play.

To cancel Program Play

When the recorder is stopped, press PLAY MODE repeatedly (or CONTINUE once) until "PROGRAM" disappears.

You can program the same track repeatedly
While the track number appears in the display, press AMS as many times as you want to repeat.

The program remains even after Program Play ends
When you press ▷, you can play the same program again.

Notes

- The program created by the Program Play Function is lost when you press EJECT to take out the MD.
- The program created by the Program Play Function is lost when you turn off the recorder or disconnect the AC power cord.
- The display shows "- m - s" instead of the total playing time when the total playing time of the program exceeds 160 minutes.

Checking the track order

You can check the order of tracks in your program during playback or playback pause.

Turn AMS (or press ◀◀ or ▶▶) during playback or playback pause. The track numbers appear in the order they were programmed.

Changing the track order

You can change the order of the tracks in your program before you start playing.

To	Do the following:
Erase the last track in the program	Press CLEAR. Each time you press this button, the last track will be cleared.
Add tracks to the end of the program	Carry out Steps 2 and 3 in "Creating Your Own Program."
Change the whole program completely	<ol style="list-style-type: none"> 1 Press PLAY MODE (or press CONTINUE) so that "PROGRAM" disappears while the recorder is stopped. 2 Carry out Steps 1 to 3 in "Creating Your Own Program."

Useful Tips When Recording From MDs to Tape

The Auto Space and Auto Pause Functions described in this section make recording from MDs to tape more easy.

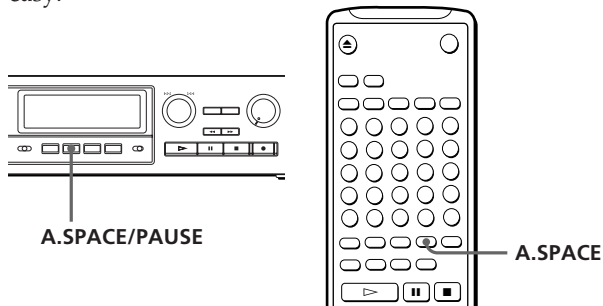

Inserting blank spaces while recording to tape (Auto Space)

The Auto Space Function inserts a 3-second blank space between each track while recording from MDs to tapes, allowing you to use the AMS function during playback later.

Press A.SPACE/PAUSE (or A.SPACE) repeatedly until "A.SPACE" appears in the display.

To cancel Auto Space

Press A.SPACE/PAUSE (or A.SPACE) repeatedly until "A.SPACE" disappears.

Note

If the Auto Space Function is on while recording a selection containing multiple track numbers, (for example, a medley or symphony), blank spaces will be inserted within the selection whenever the track number changes.

Pausing after each track (Auto Pause)

When the Auto Pause Function is on, the recorder pauses after playing each track. Auto Pause is convenient when recording single tracks or multiple, non-consecutive tracks.

Press A.SPACE/PAUSE (or A.SPACE) repeatedly until "A.PAUSE" appears in the display.

To restart playback

Press  or .

To cancel Auto Pause

Press A.SPACE/PAUSE (or A. SPACE) repeatedly until "A.PAUSE" disappears.

Note

If you turn off the recorder or disconnect the AC power cord, the recorder will recall the last setting of the Auto Space and Auto Pause Functions the next time you turn on the recorder.

Notes on Editing

You can edit the recorded tracks after recording, using the following functions:

- Erase Function allows you to erase recorded tracks simply by specifying the corresponding track number.
- Divide Function allows you to divide tracks at specified points so that you can quickly locate those points afterwards, using the AMS function.
- Combine Function allows you to combine two consecutive tracks into one.
- Move Function allows you to change the order of tracks by moving a specific track to a desired track position.
- Title Function allows you to create titles for your recorded MDs and tracks.

If "Protected" appears in the display

The recorder could not edit because the record-protect slot on the MD is open. Edit after closing the slot (see page 7.)

When "TOC" flashes in the display

Do not move the recorder or pull out the AC power cord. After editing, "TOC" lights continuously until you eject the MD. "TOC" flashes while the recorder is updating the TOC. When the recorder finishes updating the TOC, "TOC" goes off.

Erasing Recordings (Erase Function)

Follow the procedures below to erase:

- A single track
- All tracks
- Part of a track

Note, however, that once erased, MD data cannot be recovered.

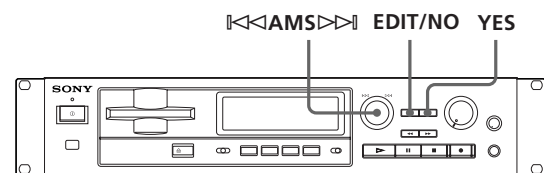

Erasing a single track

You can erase a track simply by specifying the respective track number. When you erase a track, the total number of tracks on the MD decreases by one and all tracks following the erased one are renumbered. Since erasing merely updates the TOC, there is no need to record over material.

 To avoid confusion when erasing multiple tracks, you should proceed in the order of high to low track numbers to prevent the renumbering of tracks that have not been erased yet.

Example: Erasing B

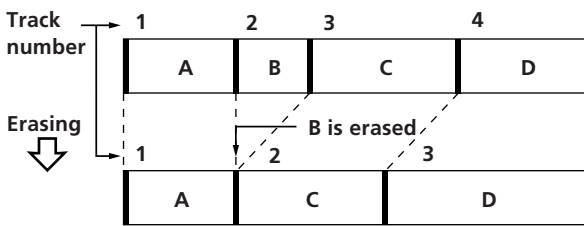

- 1 While the recorder is stopped or during playback pause, press EDIT/NO to display "Edit Menu."
- 2 Turn AMS until "Erase?" appears in the display, then press AMS.
- 3 Turn AMS until the track number you want to erase appears in the display.
- 4 Press AMS or YES. When the track selected in Step 3 has been erased, "Complete" appears for a few seconds and the total number of tracks in the music calendar decreases by one.
- 5 Repeat Steps 1 to 4 to erase more tracks.

To cancel the Erase Function

Press EDIT/NO or ■.

Note

If "Erase???" appears in the display, the track was recorded or edited on another MD recorder and is record-protected. If this indication appears, press YES to erase the track.

Erasing all tracks on an MD

You can delete the disc name, all recorded tracks, and titles of the recordable MD at once.

- 1 While the recorder is stopped or during playback pause, press EDIT/NO to display "Edit Menu."
- 2 Turn AMS until "All Erase?" appears in the display.
- 3 Press AMS or YES. "All Erase???" appears and all tracks in the music calendar start flashing.
- 4 Press AMS or YES again. When the disc name, all recorded tracks, and titles on the MD have been erased, "Complete" appears for a few seconds and the music calendar disappears.

To cancel the Erase Function

Press EDIT/NO or ■ and "All Erase?" or "All Erase???" disappears.

You can undo the Erase Function

See "Undoing the Last Edit" on page 27.

Erasing a part of a track

By using the Divide (see page 22), Erase (see page 20) and Combine (see page 23) Functions, you can erase specific portions of a track.

Example: Erasing a part of track A

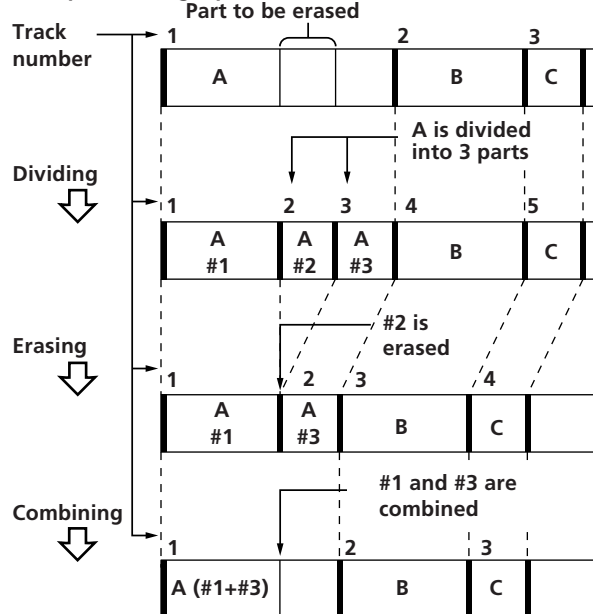

Dividing Recorded Tracks (Divide Function)

With the Divide Function you can assign a track number at places that you want to randomly access afterwards. Use this function to add tracks to MDs recorded from an analog source (and therefore contain no track numbers), or to divide an existing track into multiple portions. When you divide a track, the total number of tracks on the MD increases by one and all tracks following the divided track are renumbered.

Example: Dividing track 2 to create a new track for C

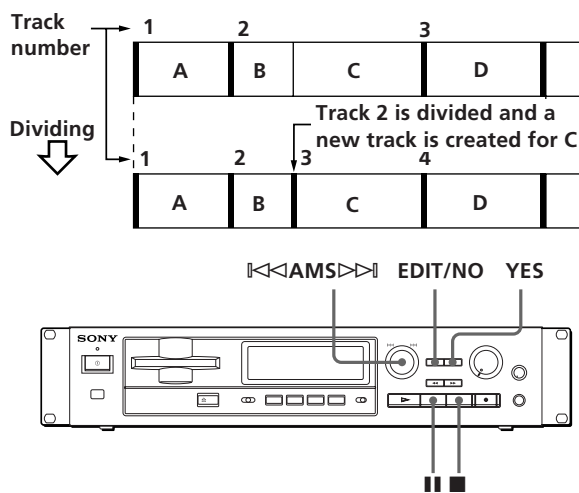

- 1** While playing the MD, press **||** at the point where you want to create a new track.
The recorder pauses playing.
- 2** Press EDIT/NO to display "Edit Menu."
- 3** Turn AMS until "Divide?" appears in the display, then press AMS.
"Rehearsal" alternates with "Position ok?" in the display, the track to be divided starts flashing in the music calendar, and the starting portion of the new track begins playing repeatedly. (If the starting position is correct, proceed with Step 5.)

- 4** While monitoring the sound, turn AMS to find the starting position of the new track.
The starting portion of the new track is played back repeatedly.
"Rehearsal" alternates with "Position ok?" in the display.
The starting position can be moved within a maximum range of -128 to +127 steps of about 0.06 seconds within a track.
- 5** Press YES or AMS when the position is correct.
When the track has been divided, "Complete" appears for a few seconds and the newly created track begins playing. The new track will have no track title even if the original track was labeled.

To cancel the Divide Function

Press **■** or EDIT/NO.

💡 You can undo a track division

Combine the tracks again (see "Combining Recorded Tracks" on page 23) then redivide the tracks if necessary.

💡 You can divide a track while recording

Use the Track Marking Function (see page 12).

Combining Recorded Tracks (Combine Function)

Use the Combine Function while the recorder is stopped, playing or in pause to combine consecutive tracks on a recorded MD. This function is useful for combining several songs into a single medley, or several independently recorded portions into a single track. When you combine two tracks, the total number of tracks decreases by one and all tracks following the combined tracks are renumbered.

Example: Combining B and C

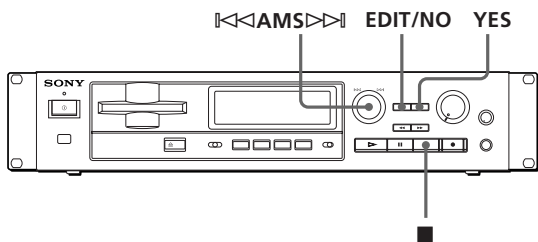
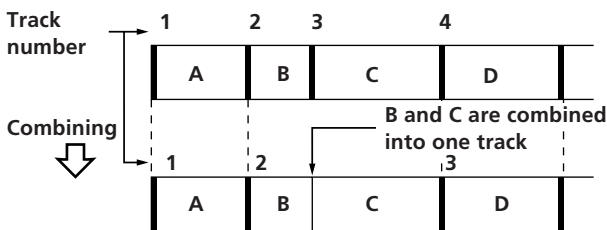

- 1 While the recorder is stopped or during playback pause, press EDIT/NO to display "Edit Menu."
- 2 Turn AMS until "Combine?" appears in the display, then press AMS.
- 3 Turn AMS until the number of the former track of the two to be combined appears in the display, then press AMS.
"Rehearsal" alternates with "Track ok?" in the display. The place where the two tracks will join (i.e., the end of the former track and the beginning of the latter track) repeatedly plays back and the respective track number flashes in the music calendar.
- 4 If the track is the wrong one, press EDIT/NO or ■, then start again from Step 1.
- 5 If the place is correct, press AMS or YES.
When the tracks have been combined, "Complete" appears for a few seconds and the total number of tracks in the music calendar decreases by one.
If both of the combined tracks have track titles, the title of the latter track is erased.

To cancel the Combine Function

Press EDIT/NO or ■.

💡 You can undo a track combination

Divide the tracks again (see "Dividing Recorded Tracks" on page 22), then repeat the combine function with the correct tracks if necessary.

Note

If "Impossible" appears in the display, the tracks cannot be combined. This sometimes happens when you've edited the same track many times, and is due to a technical limitation of the MD system, not a mechanical error.

Moving Recorded Tracks (Move Function)

Use the Move Function to change the order of any track. After you move a track, the track numbers between the new and old track positions are automatically renumbered.

Example: Moving track C to track position 2

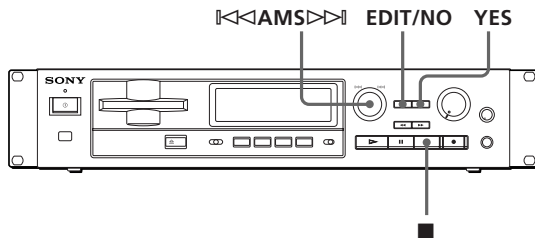
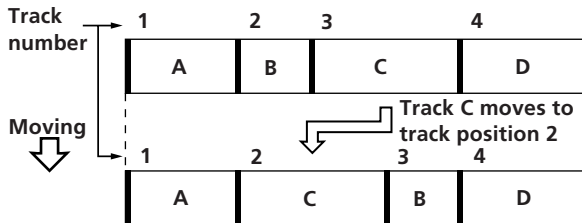

- 1 While the recorder is stopped or during playback pause, press EDIT/NO to display "Edit Menu."
- 2 Turn AMS until "Move?" appears in the display, then press AMS.
- 3 Turn AMS until the track number you want to move appears in the display, then press AMS.

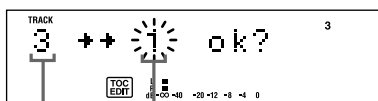

Track number to be moved New track position

- 4 Turn AMS until the new track position appears.
- 5 Press AMS or YES. After you have moved the track, "Complete" appears for a few seconds.

To cancel the Move Function

Press EDIT/NO or ■.

Labeling Recordings (Title Function)

You can create titles for your recorded MDs and tracks. Titles — which may consist of uppercase and lowercase letters, numbers and symbols for a maximum of about 1,700 characters per disc — appear in the display during MD operation.

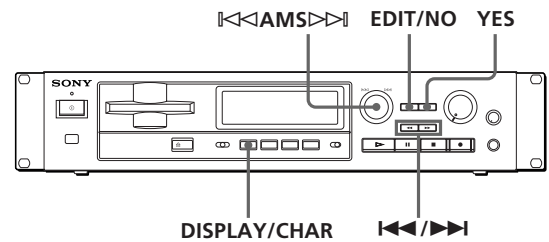

Use the following procedure to label a track or an MD. You can label a track during play, pause, record, or stop mode. If the track is playing or recording, be sure to finish labeling before the track ends. If the track ends before you've completed the labeling procedure, only the characters already entered are recorded automatically.

- 1 Press EDIT/NO to display "Edit Menu."
- 2 Turn AMS until "Name in?" appears in the display, then press AMS.
- 3 Turn AMS to select "Disc" or track number, then press AMS. When you label an MD, select "Disc" and when you label a track, select the track number. Note that during recording, the recorder changes to character typing mode and a cursor starts flashing.

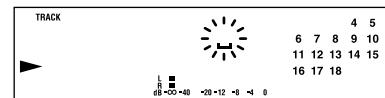

4 Press DISPLAY/CHAR to select the character type as follows:

To select	Press DISPLAY/CHAR repeatedly until
Uppercase letters	"A" appears in the display
Lowercase letters	"a" appears in the display
Numbers	"0" appears in the display

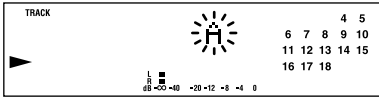

5 Turn AMS to select the character.

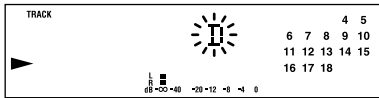

The selected character flashes.

Letters, numbers, and symbols appear in sequential order as you turn AMS.

You can use the following symbols in titles:

! " # \$ % & ' () * + , - . / : ; < = > ? @ _ ` ^

You can press DISPLAY/CHAR to change the character type at any time during this step (see Step 4.)

6 Press AMS to enter the selected character. The cursor shifts rightward and waits for the input of the next character.

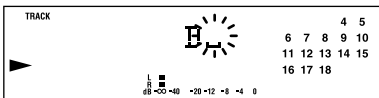

7 Repeat Steps 4 to 6 until you have entered the entire title.

If you entered the wrong character

Press ◀ or ▶ until the character to be corrected starts flashing, and repeat Steps 4 to 6 to enter the correct character.

To erase a character

Press ◀ or ▶ until the character to be erased starts flashing, then press EDIT/NO.

To enter a space

Press AMS or ▶ while the cursor is flashing.

8 Press YES.

This completes the labeling procedure and the title appears on the left side of the display.

To cancel labeling

Press ■.

Note

You cannot label a track or an MD while you are recording over an existing track.

(Continued)

Labeling tracks and MDs with the remote

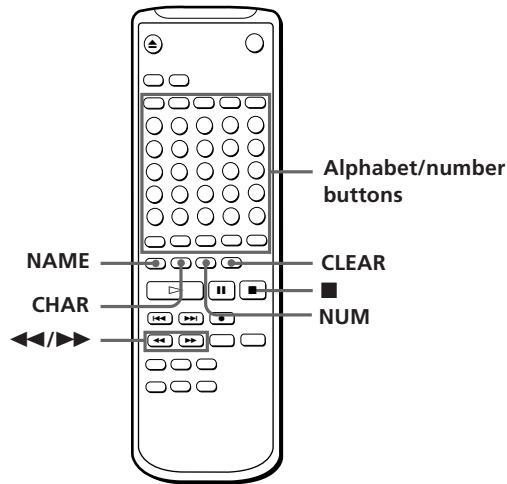

- 1 Press NAME repeatedly until a flashing cursor appears in the display, then do the following:

To label	Make sure that the recorder is
A track	Playing, pausing, recording the track to be labeled, or stopped after locating the track to be labeled
An MD	Stopped with no track number appearing in the display

- 2 Select the character type as follows:

To select	Press
Uppercase letters	CHAR repeatedly until "Selected ABC" appears in the display
Lowercase letters	CHAR repeatedly until "Selected abc" appears in the display
Numbers	NUM repeatedly until "Selected 123" appears in the display

- 3 Enter one character at a time.
After you enter a character, the cursor shifts rightward and waits for the input of the next character.

- 4 Repeat Steps 2 and 3 until you have entered the entire title.

If you entered the wrong character

Press ◀ or ▶ until the character to be corrected starts flashing.
Press CLEAR to erase the incorrect character, then enter the correct one.

- 5 Press NAME again.
The entered title appears on the left side of the display window after the label has been recorded.

To cancel labeling

Press ■.

Changing an existing title

- 1 Press NAME, then do the following:

To change	Make sure that the recorder is
A track title	Playing, pausing the track whose title is to be changed, or stopped after locating the track whose title is to be changed
A disc name	Stopped with no track number appearing in the display

- 2 Keep pressing CLEAR (or EDIT/NO on the recorder) until the current title is erased.
- 3 Enter the new title.
Carry out Steps 4 to 7 of "Labeling Recordings" on page 24, or Steps 2 to 4 of "Labeling tracks and MDs with the remote" on page 26.
- 4 Press NAME.

Undoing the Last Edit (Undo Function)

You can use the Undo Function to cancel the last edit and restore the contents of the MD to the condition that existed before editing was done. Note, however, that you cannot undo an edit if you do any of the following after the edit:

- Press the ● button on the front panel.
- Press the ● button, the MUSIC SYNC button, or the CD-SYNC STANDBY button on the remote.
- Turn off the power or eject the MD.
- Disconnect the AC power cord.

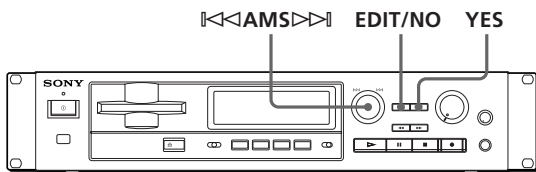

- 1 While the recorder is stopped or during playback pause, press EDIT/NO to display "Edit Menu."
- 2 Turn AMS until "Undo?" appears in the display, then press AMS.
"Undo?" does not appear if no editing has been done.
One of the following messages appears in the display, depending on the type of editing to be undone:

Editing done:	Message:
Erasing a single track	"Erase Undo ?"
Erasing all tracks on an MD	
Dividing a track	"Divide Undo ?"
Combining tracks	"Combine Undo ?"
Moving a track	"Move Undo ?"
Labeling a track or an MD	"Name Undo ?"
Changing an existing title	

- 3 Press YES again.
"Complete" appears for a few seconds and the contents of the MD are restored to the condition that existed before the edit.

To cancel the Undo Function

Press EDIT/NO or ■.

Function of Control Terminal

Control terminal (CTRL-S)

Mini jack type

When a system controller with CTRL-S terminal is connected to the control terminal of this recorder, it can operate as a remote .

Control functions

The system controller which is connected to the control terminal operates the same as the supplied remote RM-D7M.

Note

When the system controller is connected to the control jack, the remote can not be used because its infrared rays are stopped.

Dimensions

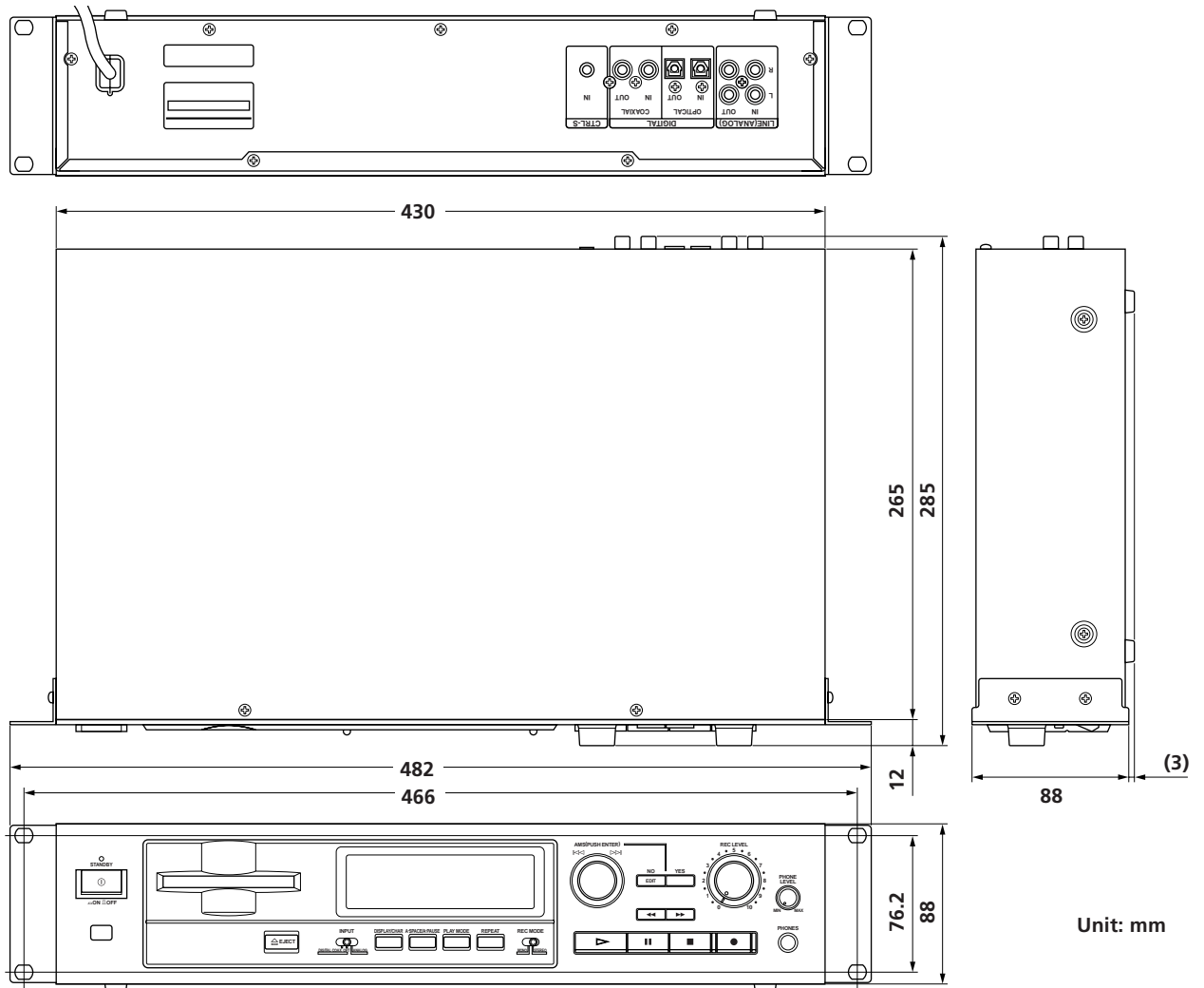

Unit: mm

Mounting the recorder

This recorder can be attached to a standard 19 inch rack (type EIA). After detaching the four feet on the bottom of the recorder, mount the recorder on the rack.

Display Messages

The following table explains the various messages that appear in the display.

Message	Meaning
Blank Disc	A new (blank) or erased MD has been inserted.
Cannot Copy	An attempt was made to make a second copy from a digitally dubbed MD (see page 33.)
Cannot EDIT	An attempt was made to edit the MD during Program, Shuffle, or Normal Play.
Din Unlock	The connected digital sound source is turned off or the recorder is not connected properly to the sound source.
Disc Error	Defected MD is inserted.
Disc Full	The MD is full (see "System Limitations" on this page.)
Impossible	You cannot record or edit the MD due to the system limitations.
Name Full	The titling capacity of the MD has reached its limit (about 1,700 characters.)
No Disc	There is no MD in the recorder.
No Track	The inserted MD has a disc title but no tracks.
Protected	The inserted MD is record-protected.
Retry	The first recording attempt failed due to a disturbance or scratch on the MD, and a second attempt is being made.
Retry Error	Due to vibrations to the recorder or scratches on the MD, several recording attempts were made but with no success.
STANDBY (flashing)	The contents previously recorded are not saved correctly on the MD, or the program created by Program Play is not stored in the recorder's memory.

System Limitations

The recording system in your MiniDisc recorder is radically different from those used in cassette and DAT recorders and is characterized by the limitations described below. Note, however, that these limitations are due to the inherent nature of the MD recording system itself and not to mechanical causes.

"Disc Full" lights up even before the MD has reached the maximum recording time (60 or 74 minutes)

When 255 tracks have been recorded on the MD, "Disc Full" lights up regardless of the total recorded time. More than 255 tracks cannot be recorded on the MD. To continue recording, erase unnecessary tracks or use another recordable MD.

"Disc Full" lights up before the maximum number of tracks is reached

Fluctuations in emphasis within tracks are sometimes interpreted as track intervals, incrementing the track count and causing "Disc Full" to light up.

The remaining recording time does not increase even after erasing numerous short tracks

Tracks under 12 seconds in length are not counted and so erasing them may not lead to an increase in the recording time.

Some tracks cannot be combined with others

Track combination may become impossible when tracks are edited.

The total recorded time and the remaining time on the MD may not total the maximum recording time (60 or 74 minutes)

Recording is done in minimum units of 2 seconds each, no matter how short the material. The contents recorded may thus be shorter than the maximum recording capacity. Disc space may also be further reduced by scratches.

Tracks created through editing may exhibit sound dropout during search operations.

Track numbers are not recorded correctly

Incorrect assignment or recording of track numbers may result (1) when CD tracks are divided into several smaller tracks during digital recording, or (2) while recording certain CDs with the "LEVEL-SYNC" indication on (i.e., the automatic track marking function on.)

“TOC Reading” appears for a long time

If the inserted recordable MD is brand new, “TOC Reading” appears in the display longer than for MDs that have been used.

Limitations when recording over an existing track

- The correct remaining recording time may not be displayed.
- You may find it impossible to record over a track if that track has been recorded over several times already. If this happens, erase the track using the Erase Function (see page 20.)
- The remaining recording time may be shortened out of proportion to the total recorded time.
- Recording over a track to eliminate noise is not recommended since this may shorten the duration of the track.
- You may find it impossible to label a track while recording over it.

The correct recorded/playing time may not be displayed during playback of monaural-format MDs.

Troubleshooting

If you experience any of the following difficulties while using the recorder, use this troubleshooting guide to help you remedy the problem. Should any problem persist, consult your nearest Sony dealer.

The recorder does not operate or operates poorly.

- ➔ The MD may be damaged (“Disc Error” appears.) Take the MD out and insert it again. If “Disc Error” remains, replace the MD.

The recorder does not play back.

- ➔ Moisture has formed inside the recorder. Take the MD out and leave the recorder in a warm place for several hours until the moisture evaporates.
- ➔ The recorder is not on. Press $\text{\textcircled{1}}$ to turn the recorder on.
- ➔ The MD is inserted in the wrong direction. Slide the MD into the disc compartment with the label side up and the arrow pointing towards the opening until the recorder grips it.
- ➔ The MD may not be recorded (the music calendar does not appear). Replace the disc with one that has been recorded.

The recorder does not record.

- ➔ The MD is record-protected (“Protected” appears.) Close the record-protect slot (see page 7.)
- ➔ The recorder is not connected properly to the sound source. Make connections properly to the sound source.
- ➔ The recording level is not adjusted properly (in case of input through LINE (ANALOG) IN.) Turn REC LEVEL to adjust the recording level properly (see page 11.)
- ➔ A premastered MD is inserted. Replace it with a recordable MD.
- ➔ There is not enough time left on the MD. Replace it with another recordable MD with fewer recorded tracks, or erase unnecessary tracks.
- ➔ There has been a power failure or the AC power cord has been disconnected during recording. Data recorded to that point may be lost. Repeat the recording procedure.

The recorder does not work during synchro-recording.

- ➔ The currently selected CD player type (CD player or video CD player) does not match the CD player being used. Reset the CD player type (see page 14.)

The sound has a lot of static.

- ➔ Strong magnetism from a television or a similar device is interfering with operations. Move the recorder away from the source of strong magnetism.

Note

If the recorder does not operate properly even after you’ve attempted the prescribed remedies, turn off the power, then reinsert the plug into the power outlet.

Specifications

System	MiniDisc digital audio system
Disc	MiniDisc
Laser	Semiconductor laser ($\lambda = 780 \text{ nm}$) Emission duration: continuous
Laser output	Less than $44.6 \mu\text{W}^*$ * This output is the value measured at a distance of 200 mm from the objective lens surface on the Optical Pick-up Block with 7 mm aperture.
Laser diode properties	Material: GaAlAs
Revolutions (CLV)	400 rpm to 900 rpm
Error correction	Advanced Cross Interleave Reed Solomon Code (ACIRC)
Sampling frequency	44.1 kHz
Coding	Adaptive Transform Acoustic Coding (ATRAC)
Modulation system	EFM (Eight-to-Fourteen Modulation)
Number of channels	2 stereo channels
Frequency response	5 to 20,000 Hz $\pm 0.5 \text{ dB}$
Signal-to-noise ratio	Over 92 dB during playback
Wow and flutter	Below measurable limit

Inputs

	Jack type	Input impedance	Reference input	Maximum input
LINE (ANALOG) IN	Phono jacks	47 kilohms	-4 dBu	+12 dBu
DIGITAL OPTICAL IN	Square optical connector jack	Optical wave length: 660 nm	—	—
DIGITAL COAXIAL IN	Phono jacks	75 ohms	0.5Vp-p $\pm 20\%$	—

Outputs

	Jack type	Reference output	Load impedance
PHONES	Stereo phone jack	0-10 mW The level varies.	32 ohms
LINE (ANALOG) OUT	Phono jacks	Maximum +8 dBu	Over 10 kilohms
DIGITAL OPTICAL OUT	Square optical connector jack	Optical power -18 dBm	Wave length: 660 nm
DIGITAL COAXIAL OUT	Phono jacks	0.5Vp-p (at 75 ohms)	75 ohms

0 dBu=0.775 Vrms

General

Power requirements	Refer to warning letter.
Power consumption	20 W
Dimensions (approx.) (w/h/d) incl. projecting parts	482 × 91 × 285 mm (19 × 3 ⁵ / ₈ × 11 ¹ / ₄ in.)
Mass (approx.)	4 kg (8 lbs 14 oz)

Supplied accessories See page 4.

Optional accessories

Wired / wireless remote unit: RM-D5ME
Optical cable: POC-15A, etc.
Coaxial digital connecting cable: VMC-10, etc.
Recordable MDs: MDW-60 (60 min), MDW-74 (74 min)

U.S. and foreign patents licensed from Dolby Laboratories Licensing Corporation.

Design and specifications are subject to change without notice.

Index of Parts and Controls

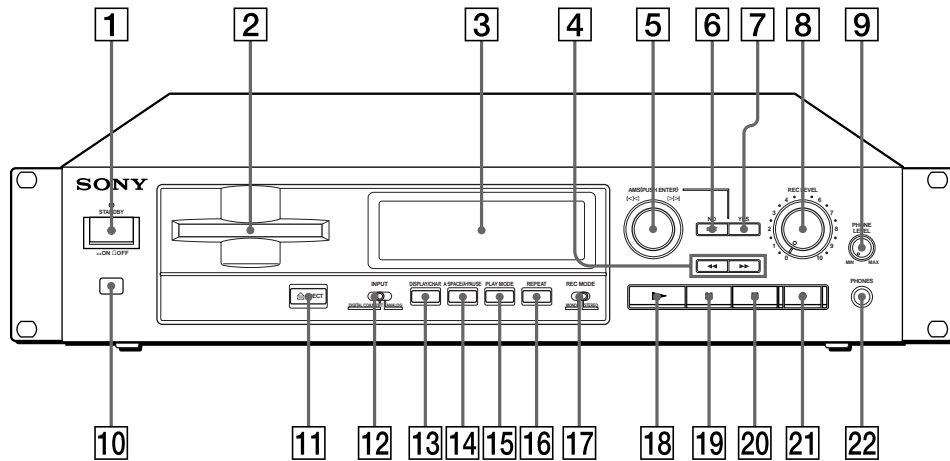

- | | |
|---------------------------------------|---------------------------|
| 1 ① (power) switch | 13 DISPLAY/CHAR button |
| 2 Disc compartment | 14 A.SPACE/A.PAUSE button |
| 3 Display | 15 PLAY MODE button |
| 4 ◀◀/▶▶ (fast forward/rewind) buttons | 16 REPEAT button |
| 5 AMS control | 17 REC MODE selector |
| 6 EDIT/NO button | 18 ▷ (play) button |
| 7 YES button | 19 (pause) button |
| 8 REC LEVEL control | 20 ■ (stop) button |
| 9 PHONE LEVEL control | 21 ● (record) button |
| 10 Remote sensor | 22 PHONES jack |
| 11 ≡ EJECT button | |
| 12 INPUT selector | |

Guide to the Serial Copy Management System

This MD recorder uses the Serial Copy Management System, which allows only first-generation digital copies to be made of premastered software via the recorder's digital input jack. An outline of this system appears below:

- 1 You can record from digital program sources (CDs, DATs or premastered MDs) onto a DAT tape or recordable MD via digital input jack on the DAT or MD recorder. You cannot, however, record from this recorded DAT tape or MD onto another DAT tape or recordable MD via the digital input jack on the DAT or MD recorder.

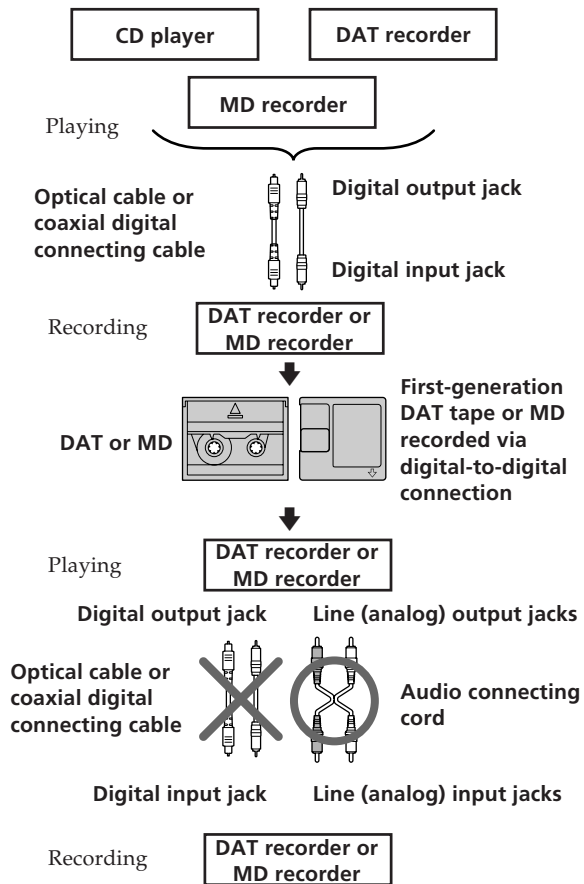

- 2 You can record the digital input signal of a digital satellite broadcast onto a DAT tape or recordable MD via the digital input jack on the DAT or MD recorder which is capable of handling a sampling frequency of 32 kHz or 48 kHz. You can then record the contents of this recorded DAT tape or recordable MD (first-generation) onto another DAT tape or recordable MD via digital input jack on the DAT or MD recorder to create a second-generation digital copy. Subsequent recording from the second-generation copy onto another recordable DAT tape or MD is possible only through the analog input jack on the DAT or MD recorder. Note, however, that on some BS tuners, second-generation digital copying may not be possible.

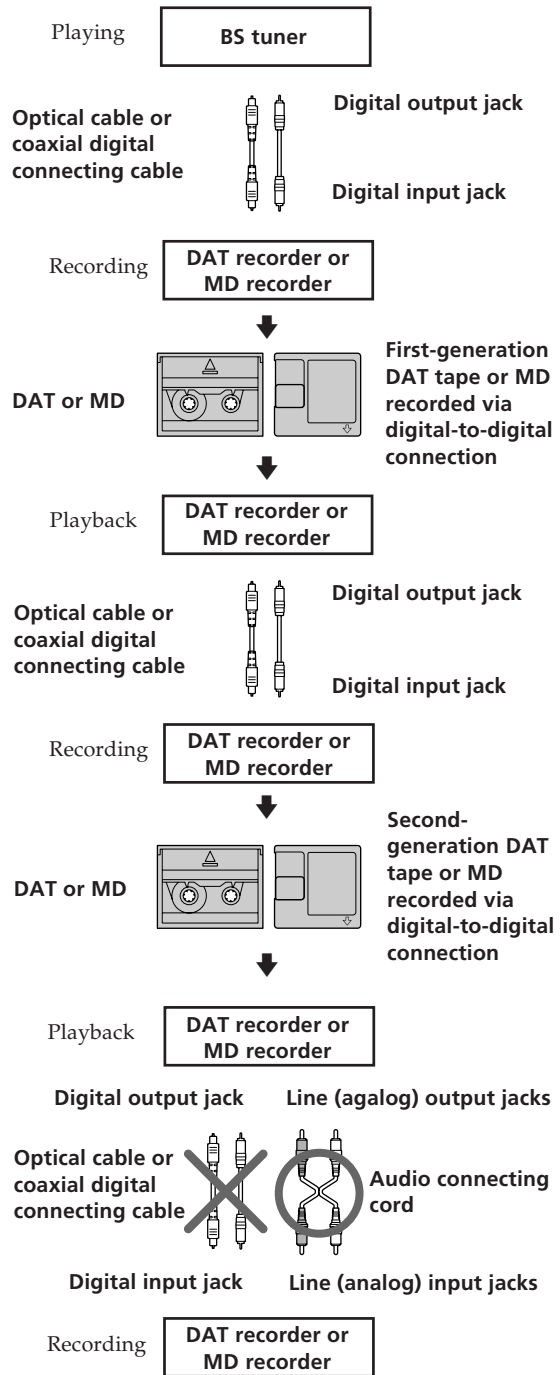

(Continued)

Additional Information

- 3 You can record a DAT tape or MD recorded via the DAT or MD recorder's analog input jack onto another DAT tape or MD via the DAT or MD recorder's digital output jack. You cannot, however, make a second-generation DAT tape or MD copy via the DAT or MD recorder's digital output jack.

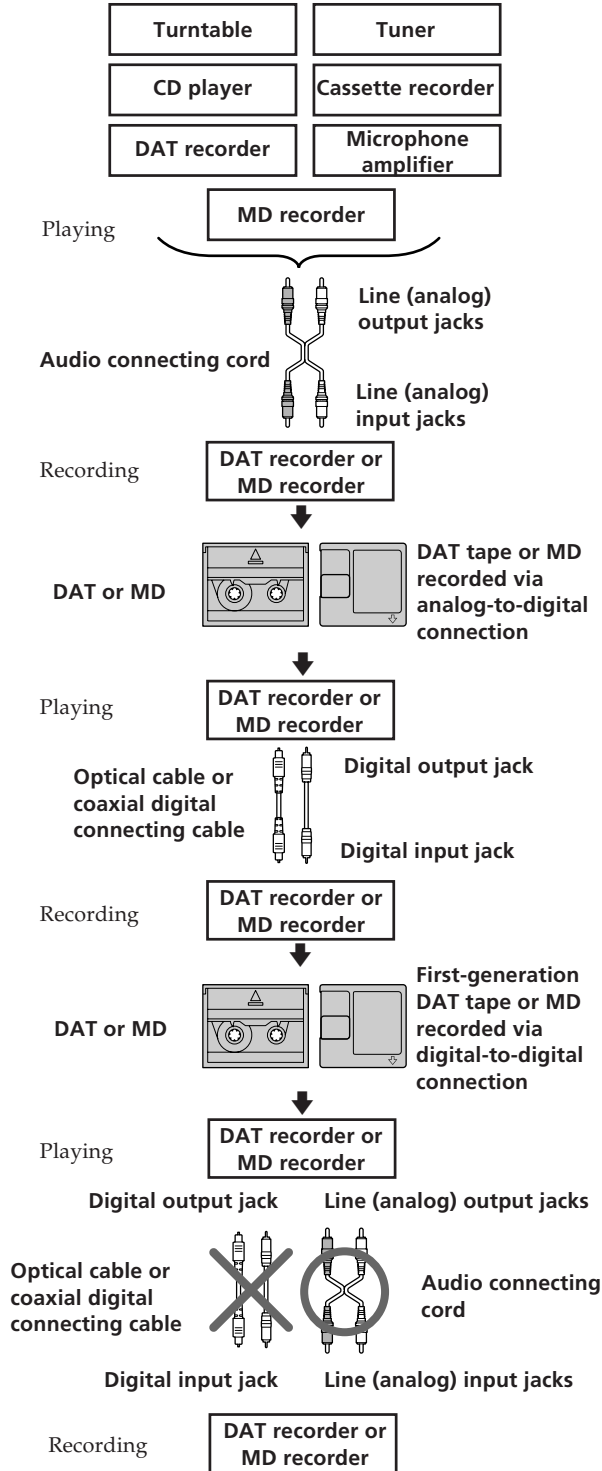

Free Manuals Download Website

<http://myh66.com>

<http://usermanuals.us>

<http://www.somanuals.com>

<http://www.4manuals.cc>

<http://www.manual-lib.com>

<http://www.404manual.com>

<http://www.luxmanual.com>

<http://aubethermostatmanual.com>

Golf course search by state

<http://golfingnear.com>

Email search by domain

<http://emailbydomain.com>

Auto manuals search

<http://auto.somanuals.com>

TV manuals search

<http://tv.somanuals.com>