



















**SONY®**

***VAIO® Computer  
Quick Start***

**PCG-GRT300Z Series**

## Short Cut Menu

-  +F1 Displays the VAIO Help and Support Center window.
-  +Tab Switches the selected button on the taskbar.
-  +D Displays the desktop.
-  +E Displays the My Computer window.
-  +F Displays the Search Results window, where you can find a file or folder. This is the equivalent of selecting Search from the Start menu.
-  +Ctrl+F Displays the Search Results - Computers window, where you can locate other computers. This is the equivalent of selecting Search, and then Computer from the Start menu.
-  +M Minimizes all displayed windows.
- Shift+  +M Returns all minimized windows to their previous size.
-  +R Displays the Run window. This is the equivalent of selecting Run from the Start menu.
- Fn+  +Insert Displays the System Properties window. This is the equivalent of selecting Control Panel, and then System from the Start menu.
- Fn+F3 Toggles the built-in speakers off and on.
- Fn+F4 Together with the  or  keys, it increases volume.  
Together with the  or  keys, it decreases volume.
- Fn+F5 Together with the  or  keys, it increases brightness.  
Together with the  or  keys, it decreases brightness.
- Fn+F7 Toggles the display between the computer screen (LCD), a connected external display, and both the LCD and an external display.
- Fn+F12 Puts the system into Hibernate mode, a power management state. To return the system to normal operating mode, press the power button.
- Fn+Esc Puts the system into Standby mode, a power management state. To return the system to the active state, press any key or the power button.

# Contents

<b>Notice to Users .....</b>	<b>5</b>
<b>Setting Up .....</b>	<b>13</b>
Unpacking Your Computer .....	14
<b>Getting Started .....</b>	<b>23</b>
Turning On Your Computer .....	23
Using the Touch Pad .....	28
<b>VAIO Recovery Wizard Utility.....</b>	<b>35</b>
<b>Troubleshooting .....</b>	<b>37</b>
Support Options.....	41



# Notice to Users

© 2004 Sony Electronics Inc. All rights reserved. This manual and the software described herein, in whole or in part, may not be reproduced, translated, or reduced to any machine-readable form without prior written approval.

SONY ELECTRONICS INC. PROVIDES NO WARRANTY WITH REGARD TO THIS MANUAL, THE SOFTWARE, OR OTHER INFORMATION CONTAINED HEREIN AND HEREBY EXPRESSLY DISCLAIMS ANY IMPLIED WARRANTIES OF MERCHANTABILITY OR FITNESS FOR ANY PARTICULAR PURPOSE WITH REGARD TO THIS MANUAL, THE SOFTWARE, OR SUCH OTHER INFORMATION. IN NO EVENT SHALL SONY ELECTRONICS INC. BE LIABLE FOR ANY INCIDENTAL, CONSEQUENTIAL, OR SPECIAL DAMAGES, WHETHER BASED ON TORT, CONTRACT, OR OTHERWISE, ARISING OUT OF OR IN CONNECTION WITH THIS MANUAL, THE SOFTWARE, OR OTHER INFORMATION CONTAINED HEREIN OR THE USE THEREOF.

Sony Electronics Inc. reserves the right to make any modification to this manual or the information contained herein at any time without notice. The software described herein is governed by the terms of a separate user license agreement.

This product contains software owned by Sony and licensed by third parties. Use of such software is subject to the terms and conditions of license agreements enclosed with this product. Some of the software may not be transported or used outside the United States. Software specifications are subject to change without notice and may not necessarily be identical to current retail versions.

Updates and additions to software may require an additional charge. Subscriptions to online service providers may require a fee and credit card information. Financial services may require prior arrangements with participating financial institutions.



As an ENERGY STAR® Partner, Sony Corporation has determined that this product meets the ENERGY STAR® guidelines for energy efficiency.

The International ENERGY STAR® Office Equipment Program is an international program that promotes energy saving through the use of computers and other office equipment. The program backs the development and dissemination of products with functions that effectively reduce energy consumption. It is an open system in which business proprietors can participate voluntarily. The targeted products are office equipment such as computers, displays, printers, facsimiles and copiers. Their standards and logos are uniform among participating nations. ENERGY STAR is a U.S. registered mark.



The Wireless LAN functionality, which is incorporated into selected models only, has passed Wi-Fi certification and complies with the interoperability specifications established by WFA (Wi-Fi Alliance).

Sony, DVgate Plus, Handycam, i.LINK, Mavica, MagicGate™ Memory Stick, Memory Stick, VAIO, and the VAIO logo are trademarks of Sony Corporation. Microsoft, Windows Media, Windows, Windows NT, and the Windows logo are registered trademarks of Microsoft Corporation. Intel, SpeedStep, and Pentium are trademarks or registered trademarks of Intel Corporation. PS/2 is a registered trademark of IBM. Acrobat Reader, Photoshop,

Photoshop Elements, and Premiere are trademarks of Adobe Systems Incorporated. PowerPanel is a trademark of Phoenix Technologies Ltd.



This product incorporates copyright protection technology that is protected by U.S. patents and other intellectual property rights. Use of this copyright protection technology must be authorized by Macrovision, and is intended for home and other limited viewing uses only unless otherwise authorized by Macrovision. Reverse engineering or disassembly is prohibited.

i.LINK is a trademark of Sony used only to designate that a product contains an IEEE 1394 connection. The i.LINK connection may vary, depending on the software applications, operating system, and compatible i.LINK devices. All products with an i.LINK connection may not communicate with each other. Please refer to the documentation that came with your compatible i.LINK device for information on operating conditions and proper connection. Before connecting compatible i.LINK PC peripherals to your system, confirm their operating system compatibility and required operating conditions. All other trademarks are trademarks of their respective owners.

### **End User / Product Activation Requirements**

Certain software product(s) included with this computer may include features such as copy protection and content management technology. Use of the software product(s) requires agreement to applicable end user agreements and full compliance with applicable product activation procedures. Product activation procedures and privacy policies will be detailed during initial launch of the software product(s), or upon certain reinstallations of the software product(s) or reconfiguration of the computer, and may be completed by Internet or telephone (toll charges may apply).

### **Owner's Record**

The model number and serial number are located on the bottom of your Sony VAIO® computer. Record the model and serial numbers in the space provided here, and keep in a secure location. Refer to the model and serial numbers when you call your Sony Service Center.

Model Number: \_\_\_\_\_  
Serial Number: \_\_\_\_\_

### **Safety Information**

#### **WARNING**

- To prevent fire or shock hazard, do not expose your computer to rain or moisture.
- To avoid electrical shock, do not open the cabinet. Refer servicing to qualified personnel only.
- Never install modem or telephone wiring during a lightning storm.
- Never install telephone jacks in wet locations unless the jack is specifically designed for wet locations.
- Never touch uninsulated telephone wire or terminals unless the telephone line has been disconnected at the network interface.
- Use caution when installing or modifying telephone lines.
- Avoid using the modem during an electrical storm.
- Do not use the modem or a telephone to report a gas leak in the vicinity of the leak.
- A socket outlet should be as close as possible to the unit and easily accessible.
- i.LINK, PC Card, and USB connectors are not supplied with Limited Power Sources.
- To prevent possible damage to your computer during transportation, first attach any supplied connector covers and slot protectors in their appropriate locations, and secure the battery pack in the battery bay.
- Do not use or store your computer in a location subject to: Heat sources, such as radiators or air ducts; direct sunlight; excessive dust; moisture

or rain; mechanical vibration or shock; strong magnets or speakers that are not magnetically shielded; ambient temperature higher than 95°F (35°C) or less than 40°F (5°C); and high humidity.

- For safety and/or optimum performance, Sony recommends using genuine Sony rechargeable battery packs.



**To change the backup battery, please contact your nearest Sony Service Center.**

**Caution: The use of optical instruments with this product will increase eye hazard. As the laser beam used in this product is harmful to the eyes, do not attempt to disassemble the cabinet. Refer servicing to qualified personnel only.**

**(For optical drive) Danger: Visible and invisible laser radiation when open. Avoid direct exposure to beam.**

**Caution: To reduce the risk of fire, use only No. 26 AWG or larger telecommunication line cord.**

## AVERTISSEMENT

- Pour prévenir tout risque d'incendie ou d'électrocution, garder cet appareil à l'abri de la pluie et de l'humidité.
- Pour prévenir tout risque d'électrocution, ne pas ouvrir le châssis de cet appareil et ne confier son entretien qu'à une personne qualifiée.
- Ne jamais effectuer l'installation de fil modem ou téléphone durant un orage électrique.
- Ne jamais effectuer l'installation d'une prise téléphonique dans un endroit mouillé à moins que la prise soit conçue à cet effet.
- Ne jamais toucher un fil téléphonique à découvert ou un terminal à moins que la ligne téléphonique n'ait été débranché de l'interface réseau.
- Soyez très prudent lorsque vous installez ou modifiez les lignes téléphoniques.
- Évitez d'utiliser le modem durant un orage électrique.

- N'utilisez pas le modem ni le téléphone pour prévenir d'une fuite de gaz quand vous êtes près de la fuite.
- L'appareil doit être le plus près possible d'une prise murale pour en faciliter l'accès.
- Des connecteurs i.LINK, PC Card, et USB ne sont pas fournis avec des Sources d'Énergie Limitées.
- Afin de prévenir des indemnités à votre ordinateur pendant la transportation, attachez d'abord tous les volets de connecteurs et protecteurs d'emplacements comme il faut, et insérez la batterie dans le logement de la batterie.
- Évitez d'utiliser ou de ranger votre ordinateur dans un endroit soumis à : des sources de chaleur telles que des radiateurs ou des bouches d'aération; la lumière directe du soleil; une poussière excessive; l'humidité ou la pluie; des vibrations ou des chocs mécaniques; des aimants puissants ou des haut-parleurs dépourvus de blindage antimagnétique; une température ambiante supérieure à 35 °C (95°F) ou inférieure à 5 °C (40°F); et une forte humidité.
- Pour des raisons de sécurité et/ou de performance, Sony recommande l'utilisation de batteries rechargeables authentiques Sony.



**Pour changer la pile de recharge, veuillez contacter votre centre de service Sony le plus près.**

**Avertissement: L'utilisation d'instruments optiques avec ce produit augmente les risques pour les yeux. Puisque le faisceau laser utilisé dans ce produit est dommageable pour les yeux, ne tentez pas de désassembler le boîtier. Adressez-vous à un agent de service qualifié.**

**(Pour le lecteur optique) Danger: Radiation laser visible et invisible si ouvert. Évitez l'exposition directe au faisceau.**

**Attention : Afin de réduire les risques d'incendie, n'utilisez qu'un cordon de communication NO. 26 AWG ou plus gros.**

If you have questions about this product, you can write to the Sony Customer Information Service Center at 12451 Gateway Blvd., Ft. Myers, FL 33913 or find Sony Customer Service on the Web at: <http://www.sony.com/pcsupport>.

## Regulatory Information

### Declaration of Conformity

Trade Name:	Sony
Model No.:	PCG-8P1L, PCG-8P2L
Responsible Party:	Sony Electronics Inc.
Address:	680 Kinderkamack Road Oradell, NJ 07649
Telephone: (For FCC-related matters only.)	201-930-6972
This device complies with Part 15 of the FCC rules. Operation is subject to the following two conditions:  (1) This device may not cause harmful interference, and  (2) this device must accept any interference received, including interference that may cause undesired operation.	

TV Tuner Model No.: ENX-23
This device complies with Part 15 of the FCC rules. Operation is subject to the following two conditions: (1) This device may not cause harmful interference, and (2) this device must accept any interference received, including interference that may cause undesired operation.

This equipment has been tested and found to comply with the limits for a Class B digital device, pursuant to Part 15 of the FCC Rules. These limits are designed to provide reasonable protection against harmful interference in a residential installation. This equipment generates, uses, and can radiate radio

frequency energy and, if not installed and used in accordance with the instructions, may cause harmful interference to radio communications. However, there is no guarantee that interference will not occur in a particular installation. If this equipment does cause harmful interference to radio or television reception, which can be

determined by turning the equipment off and on, the user is encouraged to try to correct the interference by one or more of the following measures:

- Reorient or relocate the receiving antenna.
- Increase the separation between the equipment and the receiver.
- Connect the equipment to an outlet on a circuit different from that to which the receiver is connected.
- Consult the dealer or an experienced radio/TV technician for help.

You are cautioned that any changes or modifications to the computer not expressly approved in this manual could void your authority to operate this equipment.

Only peripherals (computer input/output devices, terminals, printers, etc.) that comply with FCC Class B limits may be attached to this computer product. Operation with non-compliant peripherals is likely to result in interference to radio and television reception.

All cables used to connect peripherals must be shielded and grounded. Operation with cables connected to peripherals that are not shielded and grounded may result in interference to radio and television reception.

### FCC Part 68

This equipment complies with Part 68 of the FCC rules and the requirements adopted by the ACTA. On the bottom of this equipment is a label that contains, among other information, a product identifier in the format US:AAAEQ##TXXXX. If requested, this information must be provided to the telephone company.

This modem uses the USOC RJ11C telephone jack.

A telephone plug and jack used to connect this equipment to the premises wiring and telephone network must comply with the applicable FCC Part 68 rules and requirements adopted by the ACTA.

The REN is used to determine the number of devices which may be connected to the telephone line. Excessive RENs on a telephone line may result in the



devices not ringing in response to an incoming call. In most, but not all areas, the sum of RENs should not exceed five (5.0). To be certain of the number of devices that may be connected to a line, as determined by the total RENs, contact the telephone company. For products approved after July 23, 2001, the REN for this product is part of the product identifier that has the format US: AAAEQ##TXXXX. The digits represented by ## are the REN without a decimal point (e.g., 03 is a REN of 0.3). For earlier products, the REN is separately shown on the label.

If this equipment causes harm to the telephone network, the telephone company will notify you in advance that temporary discontinuance of service may be required. But if advance notice is not practical, the telephone company will notify the customer as soon as possible. Also, you will be advised of your right to file a complaint with the FCC if you believe it is necessary.

The telephone company may make changes in its facilities, equipment, operations, or procedures that could affect the operation of the equipment. If this happens, the telephone company will provide advance notice in order for you to make the necessary modifications in order to maintain uninterrupted service.

If trouble is experienced with this equipment, for repair or warranty information, please contact 1-888-4-SONY-PC (1-888-476-6972), or write to the Sony Customer Information Service Center, One Sony Drive, Park Ridge, NJ 07656. If the equipment is causing harm to the telephone network, the telephone company may request that you disconnect the equipment until the problem is resolved.

Repair of this equipment should be made only by a Sony Service Center or Sony authorized agent. For a Sony Service Center near you, call 1-888-4-SONY-PC (1-888-476-6972).

Connection to party line service is subject to state tariffs. Contact the state public utility commission, public service commission, or corporation commission for information.

If your home has specially wired alarm equipment connected to the telephone line, ensure the installation of this equipment does not disable your alarm equipment. If you have questions about what will disable alarm equipment, consult your telephone company or a qualified installer.

Use a surge arrester to protect against electrical surges.

## **FCC Radio Frequency Exposure (United States)**

(Applies to wireless LAN models only) This equipment complies with FCC radiation exposure limits set forth for an uncontrolled environment. This equipment should be installed and operated with minimum distance of 8 inches (20 cm) between the radiator and body (excluding extremities: hands, wrists, and feet).

This device and its antenna(s) must not be co-located or operating with any other antenna or transmitter. Users are not permitted to modify this transmitter device. Any unauthorized change made to this device could void your authority to operate this device.

## **IC RSS-210 (Canada)**

(Applies to wireless LAN models only) Operation is subject to the following two conditions: (1) this device may not cause interference, and (2) this device must accept any interference, including interference that may cause undesired operation of the device.

To prevent radio interference to the licensed service, this device is intended to be operated indoors and away from windows to provide maximum shielding. Equipment (or its transmit antenna) that is installed outdoors is subject to licensing.

The term "IC:" before the certification / registration number only signifies that the Industry Canada technical specifications were met.

(S'applique aux modèles sans fil de LAN seulement) L'utilisation de ce dispositif est autorisée seulement aux conditions suivantes: (1) il ne doit pas produire de brouillage et (2) l'utilisateur du dispositif doit être prêt à accepter tout brouillage radioélectrique reçu, même si ce brouillage est susceptible de compromettre le fonctionnement du dispositif.

Pour empêcher que cet appareil cause du brouillage au service faisant l'objet d'une licence, il doit être utilisé à l'intérieur et devrait être placé loin des fenêtres afin de fournir un écran de blindage maximal. Si le matériel (ou son antenne d'émission) est installé à l'extérieur, il doit faire l'objet d'une licence.

L'expression "IC:" avant le numéro d'homologation / enregistrement signifie seulement que les spécifications techniques d'Industrie Canada ont été respectées.

## Telephone Consumer Protection Act of 1991 (United States)

The Telephone Consumer Protection Act of 1991 makes it unlawful for any person to use a computer or other electronic device, including FAX machines, to send any message unless such message clearly contains in a margin at the top or bottom of each transmitted page or on the first page of the transmission, the date and time it is sent and an identification of the business or other entity, or other individual sending the message, and the telephone number of the sending machine or such business, other entity, or individual. (The telephone number provided may not be a 900 number or any other number for which charges exceed local or long-distance transmission charges.)

In order to program this information into your facsimile machine, see your fax software documentation.

## Telephone Consumer Guidelines (Canada)

Please refer to your telephone directory under 'Privacy Issues' and/or 'Terms of Service.' For more detailed information, please contact:

CRTC

Terrasses de la Chaudière, Tour centrale 1 promenade du Portage, 5 étage Hull PQ K1A 0N2.

This Class B digital apparatus complies with Canadian ICES-003.

Cet appareil numérique de la classe B est conforme à la norme NMB-003 du Canada.

## RECYCLING LITHIUM ION BATTERIES

RECYCLING LITHIUM-ION BATTERIES

Lithium-Ion batteries are recyclable.

You can help preserve our environment by returning your used rechargeable batteries to the collection and recycling location nearest you.

For more information regarding recycling of rechargeable batteries, call toll free 1-800-822-8837, or visit <http://www.rbrc.org/>.

Caution: Do not handle damaged or leaking Lithium-Ion batteries.



## RECYCLAGE DES ACCUMULATEURS AUX IONS DE LITHIUM

RECYCLAGE DES ACCUMULATEURS AUX IONS DE LITHIUM

Les accumulateurs aux ions de lithium sont recyclables.

Vous pouvez contribuer à préserver l'environnement en rapportant les piles usées dans un point de collection et recyclage le plus proche.

Pour plus d'informations sur le recyclage des accumulateurs, téléphonez le numéro gratuit 1-800-822-8837 (États-Unis et Canada uniquement), ou visitez <http://www.rbrc.org/>.

Avertissement: Ne pas utiliser des accumulateurs aux ions de lithium qui sont endommagés ou qui fuient.





**Do not handle damaged or leaking lithium ion batteries.**

**Danger of explosion if battery is incorrectly replaced. Replace only with the same or equivalent type recommended by the manufacturer. Discard used batteries according to the manufacturer's instructions.**

**The battery pack used in this device may present a fire or chemical burn hazard if mistreated. Do not disassemble, heat above 140°F (60°C) or incinerate. Dispose of used battery promptly. Keep away from children.**

**Ne pas utiliser des batteries au lithium ionisé qui sont endommagées ou qui fuient.**

**Une batterie non conforme présente un danger d'explosion. La remplacer seulement par une batterie identique ou de type équivalent recommandé par le fabricant. Évacuer les batteries usées selon les directives du fabricant.**

**La manutention incorrecte du module de batterie de cet appareil présente un risque d'incendie ou de brûlures chimiques. Ne pas démonter, incinérer ou exposer à une température de plus de 60°C. Évacuer promptement la batterie usée. Garder hors de portée des enfants.**

## **INDUSTRY CANADA NOTICE**

NOTICE: This equipment meets the applicable Industry Canada Terminal Equipment Technical Specifications.

The Ringer Equivalence Number (REN) for this terminal equipment is 0.2. The REN assigned to each terminal equipment provides an indication of the maximum number of terminals allowed to be connected to a telephone interface. The termination on an interface may consist of any combination of devices subject only to the requirement that the sum of the Ringer Equivalence Numbers of all the devices does not exceed five.

## **AVIS D'INDUSTRIE CANADA**

REMARQUE: Cet équipement est conforme aux Spécifications Techniques des Équipements Terminaux d'Industrie Canada en vigueur.

Le Nombre Équivalent de Sonneries (REN) de cet équipement terminal est 0,2. Le REN attribué à chaque équipement terminal indique le nombre maximum de terminaux que l'on peut connecter à une interface téléphonique. Il est possible de raccorder à une interface plusieurs combinaisons d'appareils, mais la somme des Nombres Équivalents de Sonneries de tous ces appareils ne doit pas dépasser cinq.



# Setting Up

*Congratulations on your purchase of the Sony VAIO® computer. Sony has combined leading-edge technology in audio, video, computing, and communications to provide state-of-the-art personal computing.*

## Unpacking Your Computer

These hardware components are included.

### Carton Contents



**Main unit**

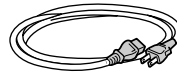

**Power cord**

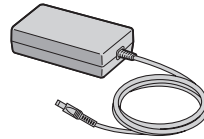

**AC adapter**

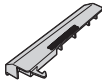

**Weight saver**

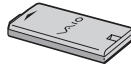

**Battery**

If the computer you purchased features GigaPocket™ software, the accessories listed on the following page are also included in the carton.

**GigaPocket accessories (for models equipped with GigaPocket features)**

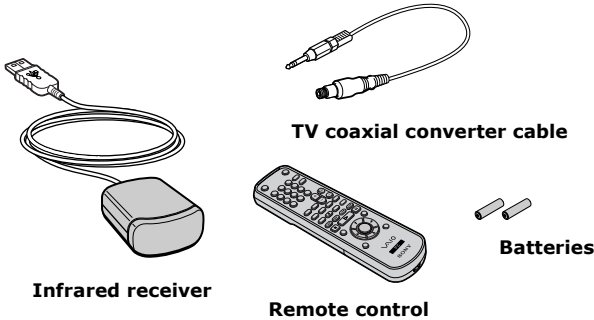

For additional information about GigaPocket™ accessories and how to use them, refer to the VAIO® Computer User Guide.

**VAIO Computer Documents**

- ❑ **VAIO® Computer User Guide** — A searchable on-screen help file that contains detailed information on how to use your new computer. See “Locating Your VAIO Computer User Guide” on page 30 for more information.
- ❑ **VAIO® Computer Quick Start (this document)** — Contains information on unpacking and setting up your computer for immediate use.
- ❑ **VAIO® Computer Specifications** — An online file that details the hardware specifications and lists the installed programs on your computer. Go to <http://www.sony.com/pcsupport> for more information.

**Software CDs**

Depending on the model you purchased, additional program CDs may be included with your computer.

**About System Recovery operations**

Computers with the Microsoft® Windows® XP operating system feature a Hard Disk Drive recovery process that eliminates the need for Recovery CDs.

## Locating Controls and Ports

Front (models with GigaPocket)

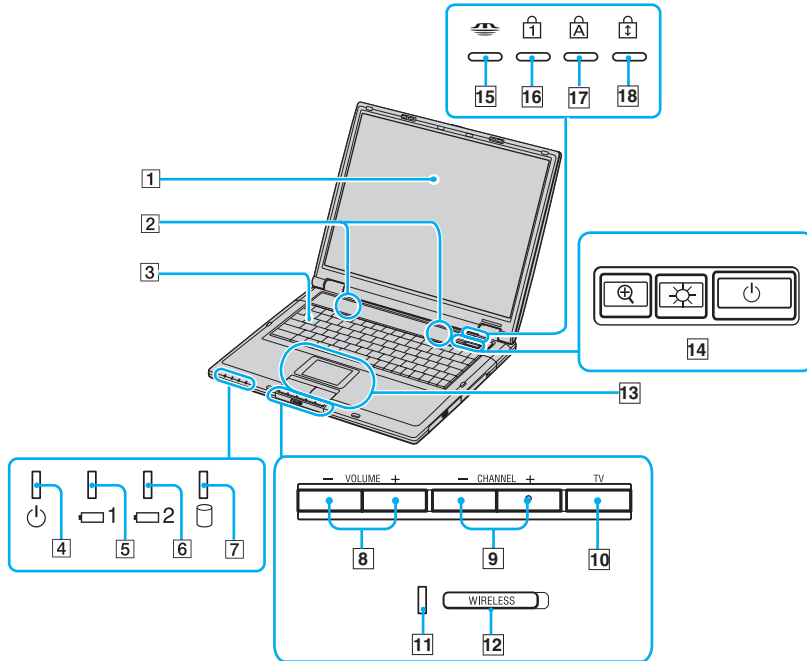

<b>1</b>	LCD screen	<b>10</b>	TV button
<b>2</b>	Speakers	<b>11</b>	Wireless LAN indicator*
<b>3</b>	Keyboard	<b>12</b>	Wireless LAN switch*
<b>4</b>	Power indicator	<b>13</b>	Touch pad, Left / right buttons
<b>5</b>	Battery indicator	<b>14</b>	Power button, Brightness button, Magnify button
<b>6</b>	Battery 2 indicator	<b>15</b>	Memory Stick® media indicator
<b>7</b>	Hard disk drive indicator	<b>16</b>	Num lock indicator
<b>8</b>	Volume Up/Down buttons	<b>17</b>	Caps lock indicator
<b>9</b>	Channel Up/Down buttons	<b>18</b>	Scroll lock indicator

\* Wireless LAN functionality available on selected models only.



**Front (models without GigaPocket)**

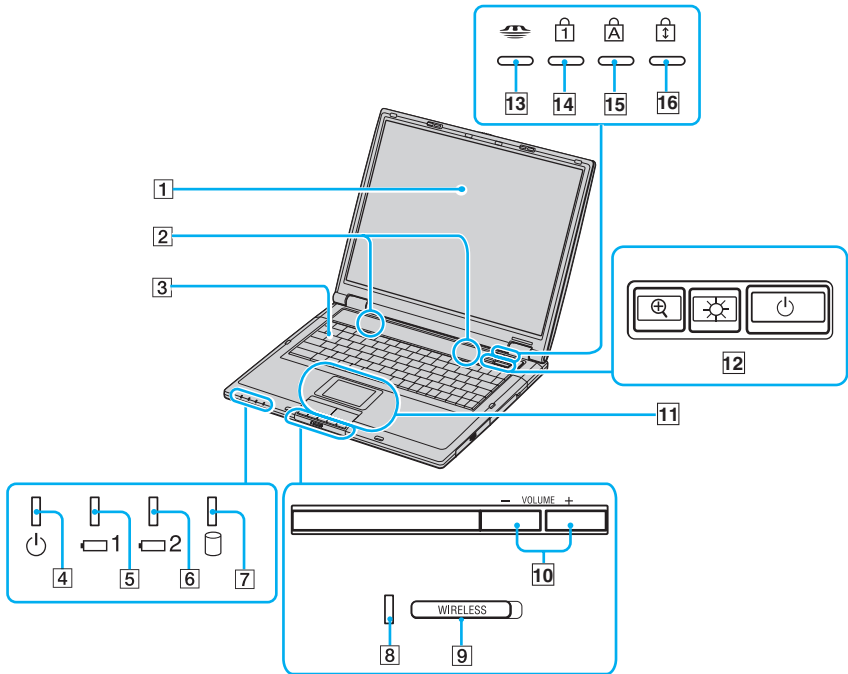

<b>1</b>	LCD screen	<b>9</b>	Wireless LAN switch*
<b>2</b>	Speakers	<b>10</b>	Volume Up/Down buttons
<b>3</b>	Keyboard	<b>11</b>	Touch pad, Left / right buttons
<b>4</b>	Power indicator	<b>12</b>	Power button, Brightness button, Magnify button
<b>5</b>	Battery indicator	<b>13</b>	Memory Stick® media indicator
<b>6</b>	Battery 2indicator	<b>14</b>	Num lock indicator
<b>7</b>	Hard disk drive indicator	<b>15</b>	Caps lock indicator
<b>8</b>	Wireless LAN indicator*	<b>16</b>	Scroll lock indicator

\* Wireless LAN functionality available on selected models only.

Back

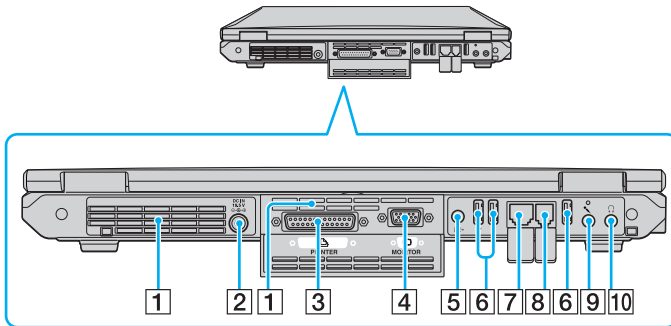

1	Air vent	6	USB 2.0 ports
2	DC IN port	7	Network (Ethernet) port
3	Printer port	8	Modem jack
4	Monitor (VGA) port	9	Microphone jack
5	Video Out port	10	Headphone jack



**Only connect 10BASE-T or 100BASE-TX cables to the Network (Ethernet) port. Do not connect any other type of network cable or any telephone line to this port. Connecting cables other than those listed above may result in an electric current overload and could cause a malfunction, excessive heat, or fire in the port. To connect the unit to a network, refer to your on-screen VAIO® Computer User Guide or contact your network administrator. See “Locating Your VAIO Computer User Guide” on page 30 for more information.**

*Left (models with GigaPocket)*

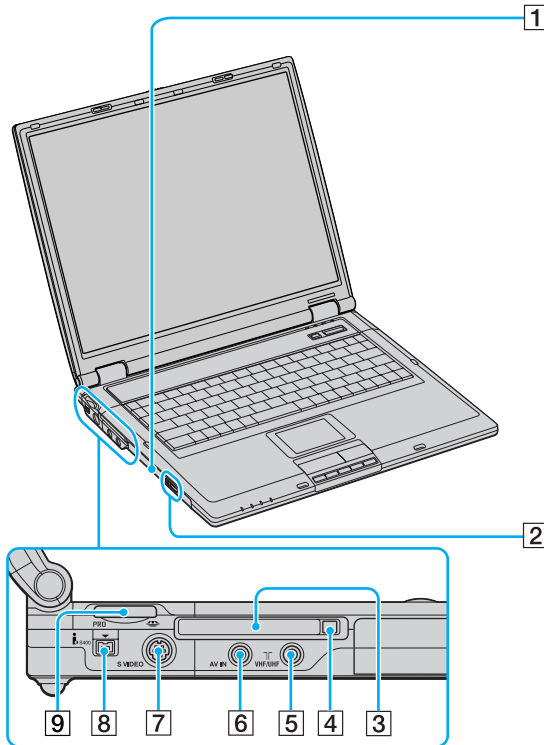

1	Optical drive	6	AV In jack
2	Optical drive eject button	7	S Video In jack
3	PC Card slot (one slot)	8	i.LINK® (IEEE 1394) S400 port
4	PC Card eject button	9	Memory Stick® media slot*
5	VHF/UHF jack		

\* Your computer supports Memory Stick PRO™ high speed and high capacity capabilities.

**⚠ Do not plug headphones or external speakers into the VHF/UHF jack. The VHF/UHF jack is designed only for use with the supplied TV coaxial converter cable. Refer to the User Guide for more information.**

**Left (models without GigaPocket)**

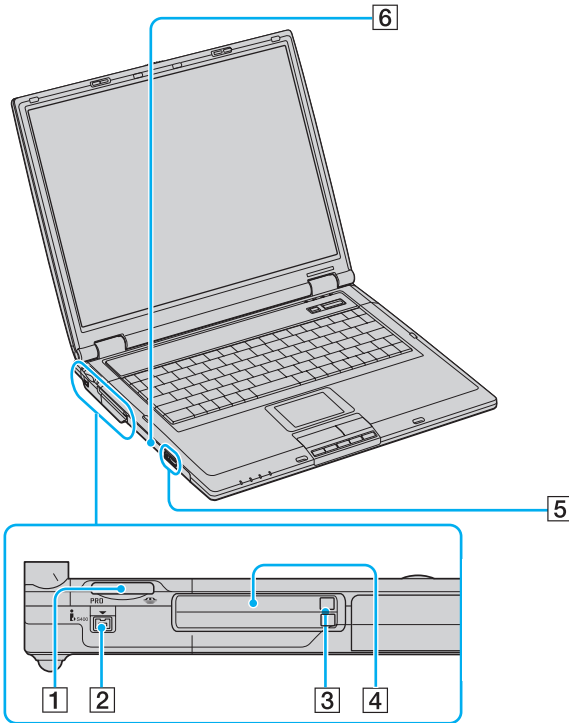

<b>1</b>	Memory Stick® media slot*	<b>4</b>	PC Card slots (Two slots)
<b>2</b>	i.LINK® (IEEE 1394) S400 port	<b>5</b>	Optical drive eject button
<b>3</b>	PC Card eject button	<b>6</b>	Optical drive

\* Your computer supports Memory Stick PRO™ high speed and high capacity capabilities.

*Right*

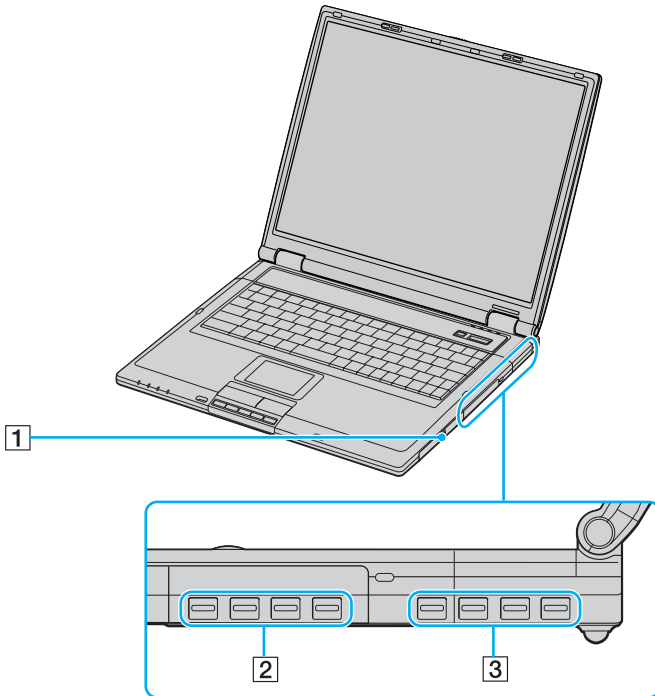

- 
- |          |                 |
|----------|-----------------|
| <b>1</b> | Battery bay     |
| <b>2</b> | Hard disk drive |
- 

- |          |          |
|----------|----------|
| <b>3</b> | Air vent |
|----------|----------|
-

**Bottom**

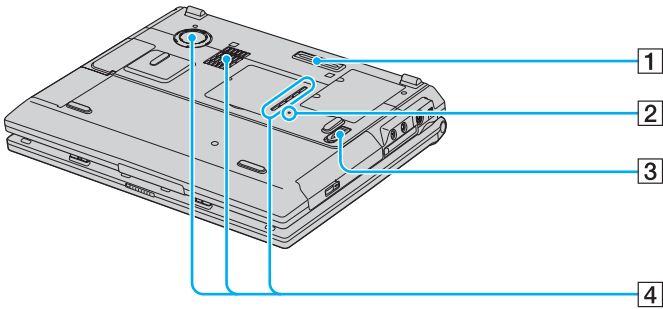

<b>1</b>	Port replicator connector	<b>3</b>	Release switch
<b>2</b>	Reset button	<b>4</b>	Air vent

# Getting Started

*This section helps you get your computer running and registered, so you can take advantage of Sony's many support options. You'll also learn how to locate your on-screen VAIO® Computer User Guide, which contains step-by-step instructions for operating your computer.*

## **Turning On Your Computer**

To use your computer immediately, use the supplied AC adapter as a power source. Your supplied battery is not charged when you unpack it, however, you can begin charging it when you use your AC adapter. See “Powering Your Computer” in your on-screen VAIO® Computer User Guide for more information about using batteries. See also “Locating Your VAIO Computer User Guide” on page 30.

### ***To insert and charge the battery***

- 1 First open the computer lid by sliding the cover release latch to the right, and lift the cover while holding the bottom of the computer firmly.

### ***Opening the Computer***

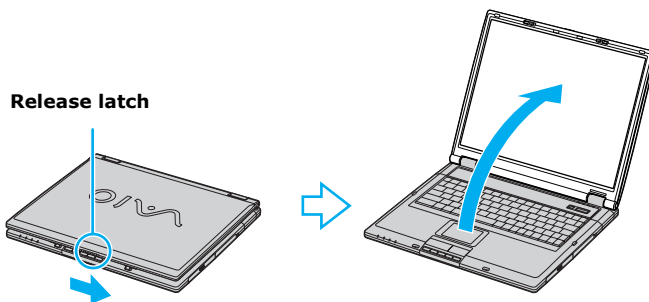

- 2 Push the battery bay cover down to open it. The battery bay cover swings out but does not detach from the computer.

### *Opening the Battery Bay*

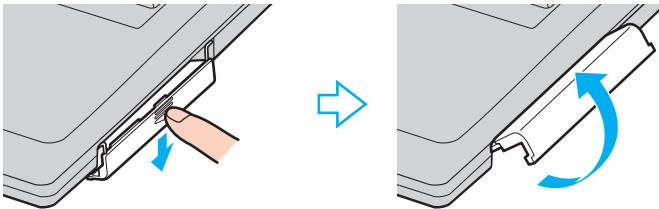

- 3 Slide the battery (with the logo facing up) into the battery bay. If the computer is on, it automatically detects the battery.

### *Inserting the Battery*

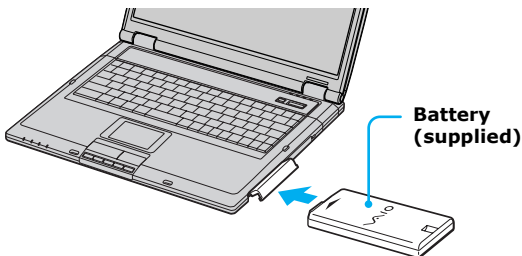

- 4 Push the battery bay cover up until it clicks into place.
- 5 Connect the AC adapter to the computer. See “To connect the AC adapter.”

Once you connect the AC adapter to the computer, the battery begins to charge whether the computer is on or off. The battery indicator  shows the battery status. The indicator blinks as the battery charges. See “Powering Your Computer” in your on-screen VAIO® Computer User Guide for more information.



**To connect the AC adapter**

- 1 Plug the AC adapter cable into the DC IN port.

**Connecting the AC Adapter to the Computer**

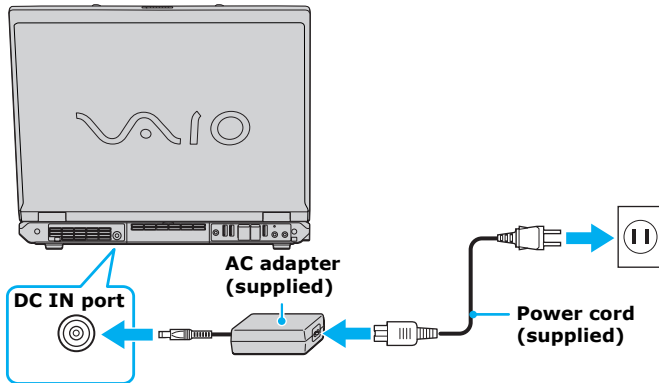

- 2 Plug the power cord into the AC adapter and an AC outlet.

 Use only the supplied AC adapter with your computer.

### **To open and turn on the computer**

- 1 Slide the release latch to the right and lift the cover while holding the bottom of the computer firmly.

#### **Opening the Computer**

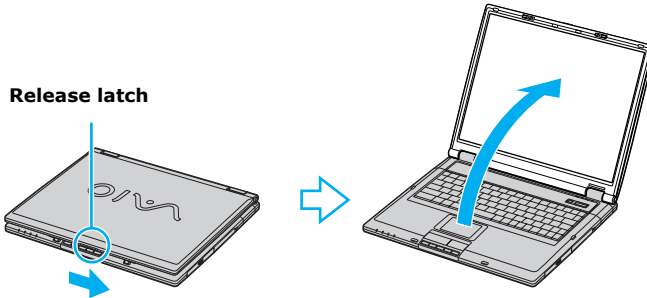

- 2 Press the power button until the green power indicator lights up.

#### **Turning on the Computer**

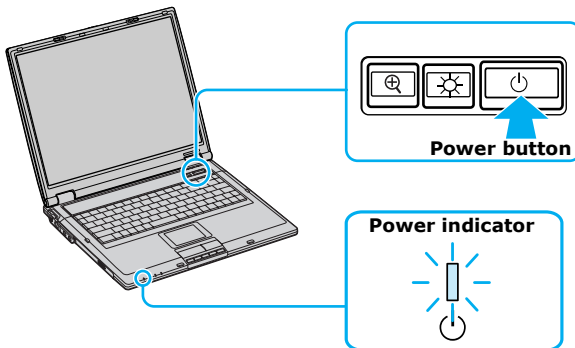

 If you hold down the power button, the computer turns off.

- 3 If necessary, adjust the brightness controls for the LCD display as follows:
- ❑ Your computer is equipped with a **Brightness** button, located next to the **Power** button. Pressing it will adjust the LCD screen brightness.
  - ❑ To increase brightness, press the **Fn+F5** keys, and then press the **Up Arrow** key **↑** or **Right Arrow** key **→**.
  - ❑ To decrease brightness, press the **Fn+F5** keys, and then press the **Down Arrow** key **↓** or **Left Arrow** key **←**.

## Using the Touch Pad

The computer contains a pointing device called a touch pad. You can point to, select, drag, and scroll objects on the screen using the built-in touch pad.

### Describing the touch pad

#### Locating the Touch Pad

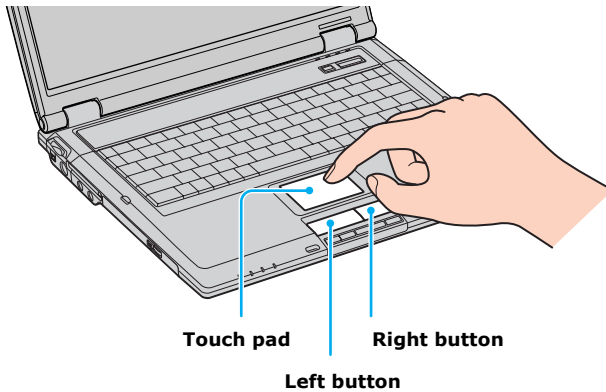

<b><i>Touch Pad Action</i></b>	<b><i>Description</i></b>
Sliding one finger	Equivalent to using a mouse to place the pointer on an item.
Tapping once	Equivalent to pressing the left button once.
Tapping twice	Equivalent to pressing the left button twice.

---

<b>Touch Pad Action</b>	<b>Description</b>
-------------------------	--------------------

---

Sliding one finger while pressing the left button	Equivalent to using the mouse to drag an item.
---	--

---

Moving your finger along the right edge of the touch pad	Equivalent to scrolling vertically. (The scroll function is available only with programs that support a touch pad scroll feature.)
--	--

---

Moving your finger along the bottom to scroll horizontally	Equivalent to scrolling horizontally. (The scroll function is available only with programs that support a touch pad scroll feature.)
--	--

---

## **Registering Your Computer**

 You are prompted to register your computer the first time you turn on the unit. Follow the on-screen instructions to complete the registration process. If you are not able to register your computer during the first session, you are provided with additional registration opportunities later.

Take advantage of Sony's commitment to quality customer support and receive these benefits by registering your computer:

- Sony Customer Support** — Talk to a support representative to troubleshoot problems you may have with your computer.
- Limited Warranty Extension** — Protect your investment. See the Warranty Card for more details.
- Product Information Notification** — By giving Sony your contact information, you will enable Sony to reach you regarding performance updates and upgrades.

## Locating Your VAIO Computer User Guide

The on-screen VAIO® Computer User Guide is a searchable help file that contains detailed information on how to use your new computer.

### To open the user guide

- 1 Click **Start** on the Windows® taskbar, and then click **Help and Support**. The **Help and Support Center** window appears, displaying information about your VAIO® computer and Microsoft® Windows® operating system.

### Locating the VAIO User Guide

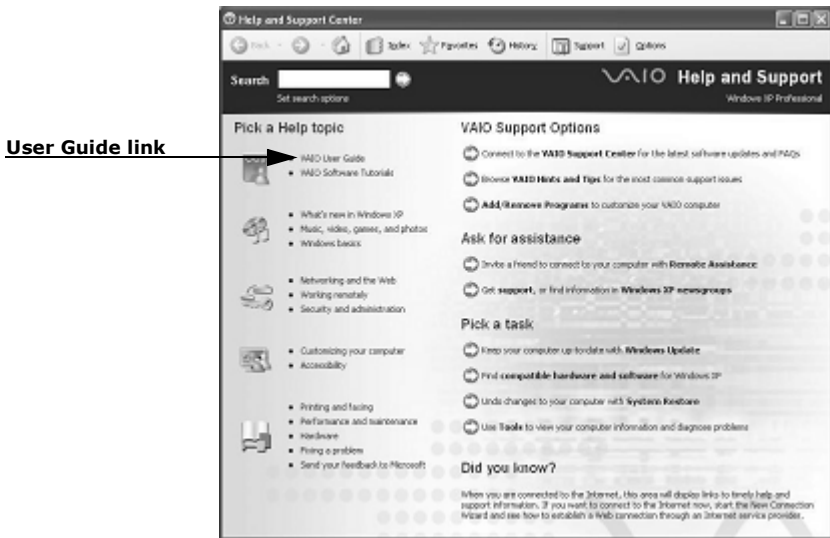

- 2 Click **VAIO User Guide** in the **Pick a Help topic** column. A second **Help and Support Center** window appears, which offers information about your computer.

**VAIO User Guide Window**

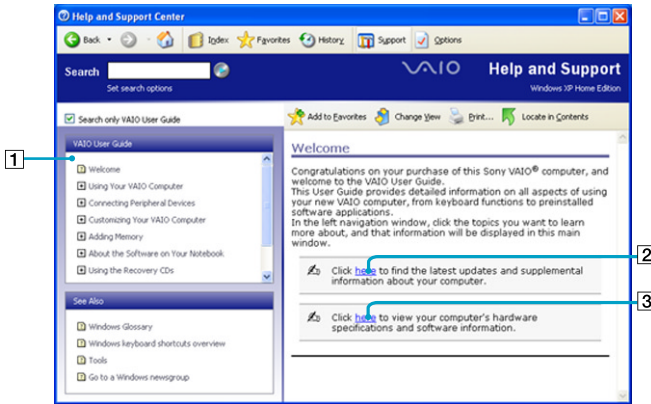

1	User guide table of contents	List of computer help topics
2	Link to Electronic Flyer	List of updates and supplemental information
3	Link to Sony Computing Support Web site	Includes support information and list of your computer's hardware specifications (Internet access required).

## Setting Up A Dial-Up Connection

This section describes the basic steps for setting up your dial-up connection. The Connection Wizard guides you through the process of choosing an Internet Service Provider (ISP) or setting up an existing account, and connecting to the Internet.

### To set up a dial-up connection

- 1 Connect a telephone cable to your computer. See “Setting up a dial-up Internet connection” in the Internet and Network Connections chapter of your on-screen VAIO® Computer User Guide.
- 2 Click **Start**, point to **All Programs, Accessories, Communications**, and then click **New Connection Wizard**. The **New Connection Wizard** appears.

### New Connection Wizard



- 3 Click **Next**.
- 4 If it is not already selected, click **Connect to the Internet**.
- 5 Click **Next**.
- 6 Follow the on-screen instructions.



## Turning Off Your Computer

Using the power button to turn off your computer may result in loss of data. Follow the steps below to properly turn off your computer and avoid losing data.

### *To turn off your computer*

- 1 Close all operations.
- 2 Click **Start** on the Windows® taskbar.
- 3 Click **Turn Off Computer** at the bottom of the **Start** menu to display the **Turn off computer** window, and select **Turn Off**.

 Respond to any prompts warning you to save documents.

- 4 Wait for your computer to turn off automatically. The computer is off when the power indicator turns off.

 During a period of inactivity, you can conserve battery life by using power saving modes. See “Conserving Battery Power” in the VAIO® Computer User Guide for more information.

 If you are unable to turn off the computer, press the power button and hold it until the power indicator turns off. This operation may result in data loss.



# VAIO Recovery Wizard Utility

*System and Application Recovery CDs/DVDs are not supplied with your VAIO® computer. Your VAIO computer is equipped with the VAIO Recovery Wizard, a fast and easy-to-use system recovery utility. This system and application recovery utility enables you to recover preinstalled software programs, the operating system, and to create a VAIO Recovery Media Kit.*

## **About the VAIO Recovery Wizard utility**

- ❑ Use the several recovery options to restore your preinstalled software programs and specific partitions on your hard disk drive.
- ❑ Follow the instructions that guide you through several recovery options choosing the default selections or customizing your computer's recovery.
- ❑ Discover the advantages of recovering your computer without using CDs or other external media.
- ❑ Create your own Recovery Media Kit, using your purchased CD or DVD media.

## **Creating a Recovery Media Kit**

You can create your Recovery Media Kit using CD or DVD media\* that can be used if your system does not start. The Recovery Media Kit enables you to reclaim the space reserved for the recovery partition (approximately 5 GB).

For more information about creating the Recovery Media Kit, see the VAIO Recovery Options online guide:

- 1 Click **Start** in the Windows® taskbar, and then click **Help and Support**.
- 2 From the **VAIO Help and Support Center**, click **VAIO Recovery Options**.

---

\* The number of CDs and/or DVDs required to create a Recovery Media Kit may vary, depending on the computer model purchased.

Visit the Sony Computing Support Web site for the latest information about using the VAIO Recovery Wizard or Recovery Media Kit.

Go to <http://www.ita.sel.sony.com/support/news/hddrecovery.html>.

### ***To purchase a VAIO Recovery Media kit***

- 1 Go to the Sony Direct Accessories and Parts Center Web site at <http://servicesales.sel.sony.com>.
- 2 Enter your computer model number (for example, PCG-XXXX), and click **List Parts and accessories**.
- 3 Follow the online instructions to order the Recovery Media Kit.



If you are not able to access the Sony Direct Accessories and Parts Center Web site, contact a customer service representative at 1-800-488-7669.

### ***Using the VAIO Recovery Wizard Help***

For more information about recovery options or instructions on using the VAIO Recovery Wizard utility program, see the VAIO Recovery Wizard Help.

Access the Help by following these steps:

- 1 Turn on your computer.
- 2 Click **Start** in the Microsoft® Windows® taskbar and click **All Programs**.
- 3 Click **VAIO Recovery Wizard**. The VAIO Recovery Wizard utility appears.
- 4 Click **Help**. The VAIO Recovery Wizard Help appears in a separate window\*.

---

\* If you do not perform a recovery operation, your system prompts you to restart your computer when closing the VAIO Recovery Wizard utility.

# Troubleshooting

## ***What do I do if my computer won't start?***

- ❑ Make sure the computer is securely plugged into a power source and turned on. Make sure the power indicator shows the power is on.
- ❑ Make sure the battery is inserted properly and charged.
- ❑ Make sure the floppy disk drive (if applicable) is empty.
- ❑ If the computer is plugged into a power strip or uninterruptible power supply (UPS), make sure the power strip or UPS is turned on and working.
- ❑ If you are using an external display, make sure it is plugged into a power source and turned on. Make sure the brightness and contrast controls are adjusted correctly. See the guide that came with your display for details.
- ❑ Disconnect the AC adapter and remove the battery. Wait one minute. Reattach the AC adapter and reinsert the battery. Turn on the power.
- ❑ Condensation may cause the computer to malfunction. If this occurs, do not use the computer for at least one hour.
- ❑ If the computer still does not turn on, follow these steps:
  - 1 Unplug the power cord and remove the battery.
  - 2 Use a thin, straight object (such as a paper clip) to press the reset button.

 See “Locating Controls and Ports” on page 15 to locate the reset button.

- 3 Reinsert the power cord and the battery.
- 4 Turn on the computer.

## ***What do I do if a BIOS error appears when my computer starts?***

If the message “Press <F1> to resume, <F2> to setup” appears at the bottom of the screen, follow these steps:

- 1 Press the **F2** key. The **BIOS Setup** menu appears.
- 2 Set the date (month/day/year). Press **Enter**.
- 3 Press the **Down Arrow** key **↓** to select **System Time**, and then set the time (hour: minute: second). Press **Enter**.
- 4 Press the **Right Arrow** key **→** to select the **Exit** tab, and then press the **Down Arrow** key **↓** to select **Get Default Values**. The message **Load default values for all SETUP items** appears.
- 5 Press **Enter**. The **Setup Confirmation** window appears.
- 6 Select **Yes**, and press **Enter**.
- 7 Select **Exit (Save Changes)**, and press **Enter**. The **Setup Confirmation** window appears again.
- 8 Select **Yes**, and press **Enter**. The computer restarts.



If this occurs on a regular basis, contact Sony Computing Support (<http://www.sony.com/pcsupport>).

### ***What do I do if the message “Operating system not found” appears when my computer starts?***

- ❑ Make sure the computer does not have a “non-bootable” floppy disk in the floppy disk drive (if applicable).
- ❑ If a non-bootable floppy disk is in the drive:
  - 1 Remove the floppy disk.
  - 2 Restart the computer and confirm that the Microsoft® Windows® operating system starts properly.
- ❑ If Windows still does not start, follow these steps to initialize the BIOS:
  - 1 If there is a disk in the floppy disk drive, then remove it.
  - 2 Turn off the computer.
  - 3 Remove any peripheral devices connected to the computer.
  - 4 Restart the computer.
  - 5 Press the **F2** key when the Sony logo appears. The **BIOS Setup** window appears.

- 6 Press the **Right Arrow** key → to select the **Exit** menu.
- 7 Press the **Down Arrow** key ↓ to select **Get Default Values**. The message **Load default values for all SETUP items** appears.
- 8 Press **Enter**. The **Setup Confirmation** window appears.
- 9 Select **Yes**, and press **Enter**.
- 10 Select **Exit (Save Changes)**, and press **Enter**. The **Setup Confirmation** window appears again.
- 11 Select **Yes**, and press **Enter**. The computer restarts.

### ***What do I do if my computer stops responding?***

It is best to turn off your computer using the Turn Off Computer or Shut Down option on the Microsoft® Windows® Start menu, located on the taskbar. Using other methods, including those listed below, may result in loss of unsaved data.

- ❑ Click **Start** on the Windows® taskbar, select **Turn Off Computer**, and then click **Turn Off**.
- ❑ If your computer does not turn off, press the **Ctrl+Alt+Delete** keys simultaneously. When the **Windows Task Manager** dialog box appears, click **Turn Off** from the **Shut Down** menu.
- ❑ If your computer still does not turn off, press and hold the power button or slide and hold the power switch until the computer turns off.
- ❑ If your computer stops responding while playing a CD or DVD, press the **Ctrl+Alt+Delete** keys simultaneously. You can turn off the computer from the **Windows Task Manager**.

 Pressing the **Ctrl+Alt+Delete** keys simultaneously or turning off the computer with the power button or switch may cause loss of data.

### ***What is HyperThreading Technology, and how do I enable or disable it?***

Depending on the model configuration you purchased, your computer may be provided with a CPU supporting HyperThreading Technology that enables parallel execution of two software processes (software threads) on a single processor.

When the HT Technology is enabled, some software such as drivers and applications may not be compatible with HT Technology. If your computer does not provide successful operations, you may disable the HT Technology. If you disable the HT Technology, however, your computer system performance may be degraded depending on usage.

To enable or disable HyperThreading technology:

- 1 Click **Start** from the Windows® taskbar, select **Turn Off Computer**.
- 2 Press the power button to turn on your computer, then immediately press the **F2** key. The BIOS setup page appears.
- 3 Select **Advanced** from the main menu bar.
- 4 Select **HyperThreading Technology** and press **Enter**. A pop-up menu appears.
- 5 Select either **Enabled** or **Disabled** and press **Enter**.
- 6 Select **Exit** from the main menu bar and press **Enter**.
- 7 Select **Exit Saving Changes** and press **Enter**.
- 8 Select **Yes**. Your computer restarts.



## ***Support Options***

If you have questions about your computer or the preinstalled programs, refer to the following sources for answers in the sequence listed below.

---

### **1 VAIO® Computer User Guide**

The on-screen VAIO® Computer User Guide provides detailed information on how to maximize your computer capabilities and solve common problems.

---

### **2 Program Guides and Help Files**

The preinstalled programs on your computer may come with individual help guides. These guides are stored on the hard disk as on-screen Help files. You can find the Help files from the Help menu under the specific program.

---

### **3 Operating System Online Support**

Your computer comes preinstalled with a Microsoft® Windows® operating system. For operating system support, you can visit Microsoft® customer support at: <http://support.microsoft.com/directory/>.

---

### **4 Sony Computing Support**

This service provides instant access to information on commonly encountered problems. Type a description of the problem and the Knowledge Database searches for the corresponding solutions online. You can visit Sony Computing Support at: <http://www.sony.com/pcsupport>.

---





***<http://www.sony.com/vaio>***

## Free Manuals Download Website

<http://myh66.com>

<http://usermanuals.us>

<http://www.somanuals.com>

<http://www.4manuals.cc>

<http://www.manual-lib.com>

<http://www.404manual.com>

<http://www.luxmanual.com>

<http://aubethermostatmanual.com>

Golf course search by state

<http://golfingnear.com>

Email search by domain

<http://emailbydomain.com>

Auto manuals search

<http://auto.somanuals.com>

TV manuals search

<http://tv.somanuals.com>