



Hardware Guide

PCV-RS series (PCV-C11M)

Read this first

Notice

© 2004 Sony Corporation. All rights reserved.

This manual and the software described herein, in whole or in part, may not be reproduced, translated, or reduced to any machine-readable form without prior written approval.

Sony Corporation provides no warranty with regard to this manual, the software, or other information contained herein and hereby expressly disclaims any implied warranties or merchantability or fitness for any particular purpose with regard to this manual, the software or such other information. In no event shall Sony Corporation be liable for any incidental, consequential, or special damages, whether based on tort, contract, or otherwise, arising out of or in connection with this manual, the software, or other information contained herein or the use thereof.

Macrovision: This product incorporates copyright protection technology that is protected by U.S patents and other intellectual property rights. Use of this copyright protection technology must be authorised by Macrovision, and is intended for home and other limited viewing uses only unless otherwise authorised by Macrovision. Reverse engineering or disassembly is prohibited.

In the manual, the TM or [®] marks are not specified.

Sony Corporation reserves the right to make any modification to this manual or the information contained herein at any time without notice. The software described herein is governed by the terms of a separate user licence agreement.

Please note that the illustrations in this manual may not necessarily apply to your model. Please see the Specifications sheet for the specific configuration of your VAIO.

ENERGY STAR

As an ENERGY STAR Partner, Sony has determined that this product meets the ENERGY STAR guidelines for energy efficiency. The International ENERGY STAR Office Equipment Program is an international program that promotes energy saving through the use of computers and their office equipment. The program backs the development and dissemination of products with functions that effectively reduce energy consumption. It is an open system in which business proprietors can participate voluntarily. The targeted products are office equipment such as computers, displays, printers, facsimiles and copiers. Their standards and logos are uniform among participating nations.

ENERGY STAR is a U.S. registered mark.



Environmental information



Halogenated flame retardants are not used in cabinets.
Corrugated cardboard is used for packaging cushions.

Owner's record

The serial number, model number and product key are located on the back of your Sony desktop. Record the numbers and refer to them if you call VAIO-Link. See also the printed **Specifications** document.

Safety information

General

- Opening the unit, for whatever reason, could lead to damages that are not covered by the guarantee.
- To avoid electrical shock, do not open the cabinet. Refer servicing to qualified personnel only.
- To prevent fire or shock hazard, do not expose your VAIO desktop to rain or moisture.
- If reporting a gas leak, do not use the modem or a telephone in the vicinity of the leak.
- Avoid using the modem during a severe electrical storm.
- The power socket outlet you are using must be installed near the equipment and must be easily accessible.
- Risk of explosion if battery is replaced by an incorrect type. Dispose of used batteries according to the instructions.
- Do not move your computer while the system is in **Standby** mode.
- The magnetic properties of some objects can have serious consequences for your hard disk drive. They can erase the data on the hard disk drive and cause the computer to malfunction. Do not place your computer near or on any objects, which emit magnetic fields, mainly:
 - TV sets
 - Speakers
 - Magnets and magnetic bracelets.

You can find detailed safety information in the **Regulations Guide**.

Audio/video

Audio and picture distortion may occur if this equipment is positioned in close proximity to any equipment emitting electromagnetic radiation.

Connectivity

- ❑ Never install modem or telephone wiring during a severe lightning storm.
- ❑ Never install telephone jacks in wet locations unless the jack is specifically designed for wet locations.
- ❑ Take care when installing or modifying telephone lines.
- ❑ To disconnect your VAIO desktop completely from the mains voltage, unplug the power cable.
- ❑ Make sure that the socket outlet is easily accessible.

Optical disc drive

The use of optical instruments can cause eye hazard. As the laser beam used in this product is harmful to the eyes, do not attempt any disassembling process. For servicing, refer to qualified personnel only.

Regulatory information

Sony hereby declares that this product is in compliance with the essential requirements and other relevant provisions of European Directive 1999/5/EC (radio equipment and telecommunications terminal equipment Directive).



Declaration of Conformity

The European Union is targeting the free movement of goods for the internal market and to prevent technical barriers to trade. This effort has resulted in several EU Directives asking that manufacturers make their products comply with essential standards. Manufacturers are required to affix the "CE" mark on the products they sell and to draw up a "Declaration of Conformity" (DoC).

Primarily, the Declarations of Conformity are intended for the market surveillance authorities as proof that products satisfy the required standards. Additionally, Sony provides these EU DoC's on the website www.compliance.sony.de as a service to our customers.

You can search for all Declarations of Conformity available for a specific product by typing in the model name in the search box. A list of matching documents will be displayed and can be downloaded. Please note that the availability of declarations depends on the scope of the EU Directives and the individual product specifications.

Before activating the built-in modem, please read the **Regulations Guide**.

You can find detailed safety information in the **Regulations Guide**.

Disposing of the internal memory backup battery

- Your Sony VAIO desktop is equipped with an internal back-up memory battery (motherboard battery) that should not have to be replaced during the lifetime of the product. If you want to replace the battery, please contact VAIO-Link: www.vaio-link.com
- Keep away from children.
- Dispose of the battery properly at its end-of-life.
- In some areas the disposal of non-hazardous batteries in household or business waste may be prohibited. Please use the public waste collection system.

Disposing of the AA batteries

The bundled remote control is powered by AA batteries.

- Do not handle damaged or leaking batteries.
- Dispose of promptly and properly at end-of-life.
- May explode or leak if recharged, disposed of in fire, mixed with other types of battery or improperly installed.
- Keep away from children.
- In some areas, the disposal of batteries in household or business waste may be prohibited. Please use the public collection system.

Welcome

Congratulations on purchasing a Sony VAIO computer. Sony has combined leading-edge technology in audio, video, computing and communications to provide you with state-of-the-art personal computing.

As well as exceptional performance, here are the main features you can enjoy:

- ❑ **Dual drives** – Enjoy the freedom of two optical disc drives.
- ❑ **Sony audio and video quality** – The advanced graphics card and high-quality external stereo speakers enable you to take advantage of today's advanced multimedia applications, games, and entertainment software.
- ❑ **Multimedia features** – Enjoy audio and video CDs and DVDs, even record them yourself.
- ❑ **VAIO Zone** – Take advantage of this new software application, allowing you to enjoy music, video, and photos locally or through a home networking environment. If your computer has TV tuner functionalities, you can also watch/record TV on your VAIO.
- ❑ **TDTV** – tdtv takes your VAIO's TV functions to a new level. Never miss your favourite TV programme again, by remote-recording it via the Internet onto your TV tuner-equipped VAIO. The tdtv Interactive Programme Guide gives you a comprehensive overview of what's on when and automatically synchronises it with your VAIO, wherever you happen to be at the time.
- ❑ **Sony Memory Stick PRO/Duo slot** – This compact digital storage medium allows you to easily transfer images, sounds, data and text between cameras, computers, and more.
- ❑ **Interconnectivity** – Your computer has Memory Stick, USB 2.0, i.LINK, CompactFlash, xD-Picture and Secure Digital/MMC functionalities.
- ❑ **Windows XP** – Your system includes the latest operating system from Microsoft.
- ❑ **Excellent customer support** – If you are experiencing any problems with your computer, please check the VAIO-Link website for a possible solution: www.vaio-link.com. Before contacting VAIO-Link, please try to solve the problem by reading this guide, your printed **Guide to Troubleshooting and Recovering your VAIO System**, the online help files in the **Windows Help and Support Center** or the manuals and help files for the peripherals or software.



Documentation pack

Your documentation pack contains printed information and user guides to read on your computer.

Guides are provided in PDF format, which you can easily browse through and print out.

The **My Info Centre** portal is a perfect starting point to using your VAIO - a comprehensive collection of everything you need to get the most from your PC.

The user guides are collected under **My Documentation**, which can be shown as follows:

- 1 Go to **Start** and click the **My Info Centre** icon .
- 2 From **My Home**, select your country and language from the drop-down boxes.
- 3 From the pictures at the top of the window click **My Documentation** .
- 4 Select the guide you want to read.

 You can manually browse to the user guides by going to **My Computer** > **VAIO (C:)** (your C drive) > **My Documentation** > **Documentation** and opening the folder for your language.

You may have a separate disc for the documentation of bundled accessories.

Printed documentation

The printed part of your documentation pack includes the following:

- ❑ A **Getting Started** brochure, where you will find a brief description of the items in your box and how to set up your computer;
- ❑ A **Specifications** sheet, containing a table of specifications, a list of bundled software and, on the reverse side, a guide to setting up your VAIO;
- ❑ A **Guide to Troubleshooting and Recovering your VAIO System**, where you will find solutions to common problems, an explanation of the purpose and use of the VAIO disc delivered with your computer, and VAIO-Link information;
- ❑ Booklets containing the following information: **Sony Guarantee** conditions, **Safety Regulations** and **Modem Regulations**.

Non-printed documentation

My Documentation contains the following VAIO user guides:

- ❑ The **Hardware Guide** (this guide) explains the features of your VAIO in detail, how to use these features confidently and safely, connect peripheral devices and more.
- ❑ The **Software Guide** describes how to register your VAIO, the software features available with VAIO systems, how to change settings, how to manage drivers, and more.
- ❑ The **VAIO Zone** guide explains the valuable features of VAIO's multimedia portal. If your computer has TV tuner functionalities, this is where you will find information about watching/recording TV on your VAIO.

My Documentation also gives you:

- ❑ Help files about reading the guides.
- ❑ Important information about your computer, in the form of notices and announcements.

In **My Info Centre** you can also find:

 **My Software**
Feeling creative? Click this icon for an overview of your software and check out our upgrade options.

 **My VAIO essentials**
Want to expand the capabilities of your VAIO? Click on this icon and have a look at your compatible accessories.

 **My Websites**
Click this icon and check out our most popular websites.

 **My ISP**
Click this icon to find out about the preferred offerings from our partners and access the world of the internet.

Further sources

- ❑ Go to **Start > Help and Support** for VAIO support information as well as tips and tricks.
- ❑ Consult the **Online Help** files of the software you are using for detailed information on features and troubleshooting.
- ❑ Go to www.club-vaio.com to find online tutorials about your favourite VAIO software.

Ergonomic considerations

Whenever possible, try and take into account the following ergonomic considerations when using your new computer, whether at home or in the office:

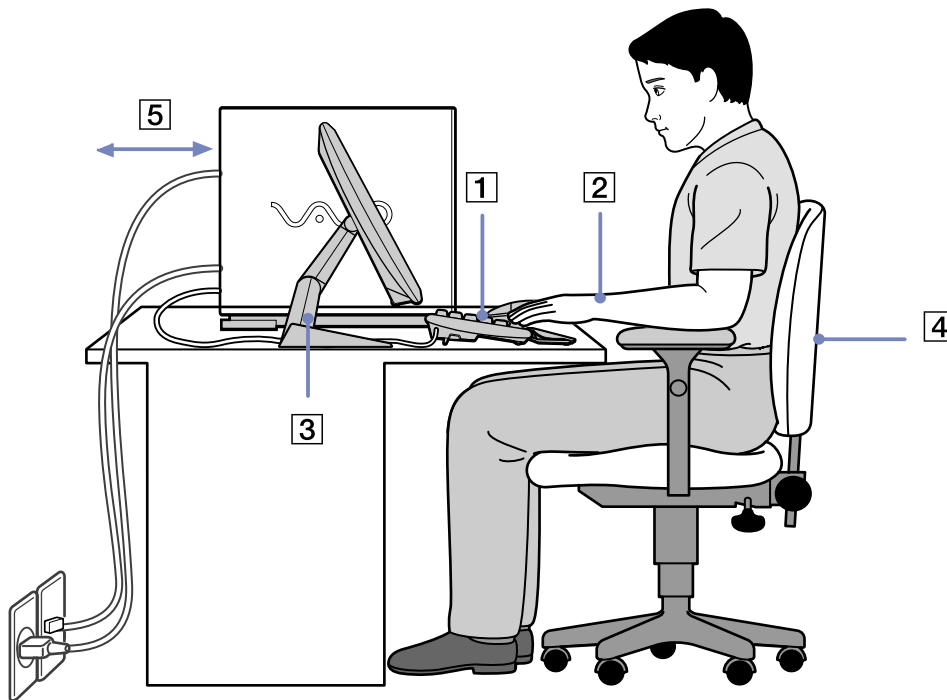

- ❑ **Position of the keyboard and mouse** – Place the keyboard directly in front of you (1). Keep your forearms horizontal, with your wrists in a neutral, comfortable position (2) while using the keyboard or mouse – not at an angle. Let your upper arms hang naturally at your sides. Use the palm rest only briefly, to relax your wrists when you are not typing. Place the mouse at the same level as the keyboard and use your whole arm to move it.
- ❑ **Position and viewing angle of the monitor** – Set the display at a comfortable viewing distance (3). Make sure the display screen is at eye level or slightly lower. Use the display's tilting feature, if available, to find the best position. You can reduce eye-strain and muscle-fatigue by adjusting the tilt of the display to the proper position. Remember to adjust the brightness setting of the display. If you are using a CRT monitor, make sure that the refresh rate is at an optimal level, that is, at least 75Hz.
- ❑ **Furniture and posture** – Sit in a chair with good back support (4). Adjust the level of the chair so your feet are flat on the floor. A footrest may make you more comfortable. Sit in a relaxed, upright posture and avoid slouching forward or leaning too far backwards.
- ❑ **Lighting** – Choose a location where windows and lights do not create glare or reflection on the display. Use indirect lighting to avoid bright spots reflecting on the display. You can also purchase accessories for your display that help reduce glare. Proper lighting adds to your comfort and work effectiveness.
- ❑ **Ventilation** – Make sure you leave at least 25 cm of space behind and on the left of the main unit (5).
- ❑ **And finally** – Remember to have breaks during sessions with your computer. Excessive use of the computer may strain muscles or tendons.

Using your VAIO computer

Once you have read and followed the information in the printed **Getting Started** guide and **Specifications** sheet, you can start using your computer safely and confidently. Read on to get the most out of using your VAIO computer.

- Shutting down your computer safely ([page 15](#))
- Using the keyboard ([page 16](#))
- Using the TV function ([page 17](#))
- Using the mouse ([page 18](#))
- Using the disc drives ([page 20](#))
- Using the floppy disk drive ([page 23](#))
- Using the modem ([page 24](#))
- Using power modes ([page 25](#))
- Using the media slots ([page 28](#))
- Expansion capabilities ([page 35](#))

Shutting down your computer safely

It is important that you shut down your computer properly so you do not lose unsaved data.

To shut down your computer, proceed as follows:

- 1 Turn off any peripherals connected to your computer.
- 2 Click the **Start** button.
- 3 Click **Turn Off Computer**.
The **Turn off computer** window appears.
- 4 Click **Turn Off**.
- 5 Respond to any prompts warning you to save documents or to consider other users and wait for your computer to turn off automatically.
The power indicator turns off.

 See the printed **Guide to Troubleshooting and Recovering your VAIO System** if you have problems shutting down your computer.

Using the keyboard

Your computer is delivered with a VAIO keyboard. The features are much the same as a standard keyboard, plus some additional functions.

For information on the standard keys and shortcuts, please go to the Windows **Help and Support Center (Start > Help and Support)**. The VAIO-Link website (www.vaio-link.com) also contains glossary information to help you use the keyboard.

Indicators

<i>Light</i>	<i>On</i>	<i>Off</i>
Num Lock	Turns on when the number keys in the numeric keypad are active.	Turns off when the alphanumeric character keys in the keypad area are active.
Caps Lock	Turns on when the letters appear in uppercase as you type. The <Shift> key lowers the case of typed letters when Caps Lock is on.	Turns off when the letters appear in lowercase as you type (unless you hold down the <Shift> key).
Scroll Lock	Turns on when the screen scrolls differently (not all applications support this function).	Turns off when the information moves across the screen normally.

Using the TV function

Your computer is equipped with a TV tuner board. In combination with Sony's **VAIO Zone** software, it allows you to:

- ❑ Watch, record and play back analogue broadcasted cable and terrestrial TV programmes, all by remote control;
 - ❑ Digitise analogue video and audio using the S-Video or composite and audio inputs;
 - ❑ Manage your video units (capsules), preview them and create multiple folders;
 - ❑ Set up a timer to record channels at a repeated time;
 - ❑ Suspend viewing TV (time-shifting);
 - ❑ Stream your recorded TV contents via Ethernet (or WLAN) to connected PCs.
-  Sony cannot guarantee the streaming of recorded content if it is beyond a certain level of high quality.

For details on using **VAIO Zone** and the remote control, please see the dedicated guide. Otherwise read the help files within the software itself.

tvTV takes your VAIO's TV functions to a new level. Never miss your favourite TV programme again, by remote-recording it via the Internet onto your TV tuner-equipped VAIO. The tvTV Interactive Programme Guide gives you a comprehensive overview of what's on when and automatically synchronises it with your VAIO, wherever you happen to be at the time. For more information, read the **Welcome to TVTV** HTML files on your computer.

Using the mouse

The VAIO wheel mouse allows you to control the cursor in a number of ways. You can point to, select, drag and scroll objects on the screen using the buttons and the wheel.

The mouse has the following functions:

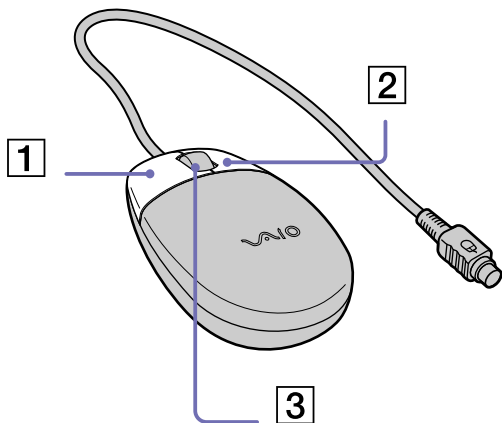

	<i>Button</i>	<i>Function</i>
1	Left button	Click or double-click the left button to select items. To drag and drop items, hold the left button down while sliding the mouse, then release the button to drop the item.
2	Right button	Press the right button once to display a context-sensitive shortcut menu (not always an active function).
3	Central wheel	Turn the central wheel to scroll up or down a page. Press the wheel once to lock the scroll action and control the movement by moving the entire mouse. (The scroll function is available only with applications that support it).

You can adjust the mouse pointer speed and other functions under **Mouse Properties**. To display **Mouse Properties**, go to the **Control Panel**, select **Printers and Other Hardware**, then select **Mouse**.

Setting up the mouse for left-handed users

To set your mouse up for left-handed users, proceed as follows:

- 1 Go to **Start**, select **Control Panel**, then click the **Printers and Other Hardware** option.
- 2 Click the mouse icon.
The **Mouse Properties** dialog box appears.
- 3 In the **Buttons** tab, select the option button next to **Switch primary and secondary buttons**.
- 4 Click **OK**.
The new mouse settings are now in place.

Using the disc drives

Your computer is equipped with two separate optical drives. Please see the printed **Specifications** sheet to see which drives your model has.

For installing software and using the **VAIO Recovery Disc** it is recommended that you use the upper drive.

- ❑ A DVD±RW drive reads data from and writes data onto DVD and CD.
- ❑ A DVD-ROM drive reads data from DVDs and CDs.
- ❑ A CD-RW drive reads data from and writes to CDs.
- ❑ A CD-ROM drive reads data from CDs.

To insert a disc, proceed as follows:

- 1 Turn on the computer.
- 2 Press the appropriate eject button to open the drive. The tray slides out.
- 3 Place a disc in the tray with the label side facing upwards. Make sure the disc is secure in the centre of the tray.
- 4 Close the tray by pushing it gently.

 See the printed **Guide to Troubleshooting and Recovering your VAIO System** and the **VAIO Troubleshooting - Burning DVDs and CDs** in the **Windows Help and Support Center** if you have problems using discs.

To remove a disc, proceed as follows:

- 1 Make sure the disc indicator light is not on.
- 2 Press the appropriate eject button to open the drive and remove the disc carefully.

 Do not press the eject button when the LED indicator is turned on. Otherwise, data may be lost.

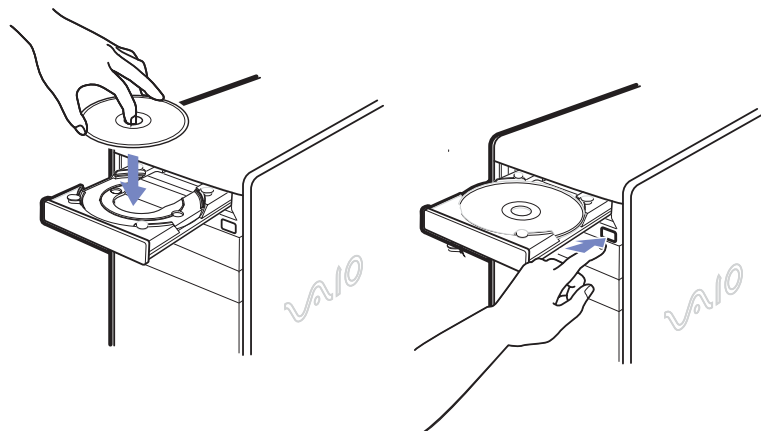

Reading and writing CDs and DVDs

To achieve optimum performance when writing data on to disc (also called 'burning'), follow these recommendations:

- Only use circular discs. Do not use discs with any other shape (star, heart, card, etc.), as this may damage the disc drive.
- Do not strike or shake the computer while writing data to a disc.
- For optimal writing speed, deactivate the screensaver before writing data to a disc.
- Memory-resident disc utilities may cause unstable operation or data loss. Deactivate these utilities before writing data to a disc.
- When using a software application to burn discs, make sure you exit and close all other applications.
- Never touch the surface of the disc. Fingerprints and dust on the surface of a disc may cause writing errors.
- Never put stickers on discs. This will affect the use of the disc irreparably.



Playing DVDs

To achieve optimum performance when playing DVDs, you should follow these recommendations:

- Close all open applications before playing a DVD movie.
- Play DVDs with the software **VAIO Zone**.
- Do not switch power saving modes while playing a DVD.
- Do not use built-in utility applications to speed up discs, because they may cause the system to become unstable.
- Make sure the screensaver is deactivated.
- Region codes indicators are labelled on the DVDs to indicate in which region and on what type of player you can play the disc. Unless a **2** (Europe belongs to region **2**) or **ALL** (this means that you can play this DVD everywhere in the world) is labelled on your DVD disc or on the packaging, you cannot play the disc on this player.
- Do not try to change the region code settings of the DVD drive. Any difficulties caused by changing the region code settings of the DVD drive are out of warranty.

Using two screens while watching a DVD film

To use two screens and change the DVD playback settings, proceed as follows:

- 1 Connect your TV / DVI display to the computer as described in **Connecting a TV set (page 39)** or **Connecting a display (page 37)**
- 2 Go to **Control Panel**.
- 3 Click **Appearance and Themes** and then **Display**.
The **Display Properties** dialog box appears.
- 4 Click the **Settings** tab and click **Advanced**.
- 5 On the **Displays** tab, click  next to the **TV** or **DVI** button.
- 6 Make sure  is selected and click **OK**.
- 7 On the **Overlay** tab, click **Clone mode options...** and make sure **Overlay Display Mode** is set to **Theater Mode**.

Using the floppy disk drive

Your VAIO desktop is equipped with a floppy disk drive.

Inserting a floppy disk

To insert a floppy disk, proceed as follows:

- 1 Hold the floppy disk with the label side facing up.
- 2 Gently push the disk into the floppy disk drive until it clicks into place.

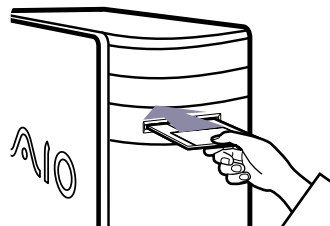

Removing a floppy disk

To remove a floppy disk, proceed as follows:

- 1 Wait until the LED indicator turns off.
 - 2 Press the eject button and pull the disk out gently.
-  Do not press the eject button when the LED indicator is turned on. Otherwise, data may be lost.

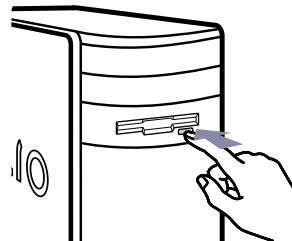

Using the modem

Your VAIO desktop is equipped with an internal modem. As described in the printed **Getting Started** guide, use the single RJ-11 jack  to connect the supplied modem cable to the phone line. Once you have connected the phone line and registered with an Internet Service Provider, you can take advantage of online services and the Internet, to register your computer and software online, and to contact VAIO-Link by e-mail.

Troubleshooting the modem

If you have problems with your modem, check the printed **Guide to Troubleshooting and Recovering your VAIO System** and the VAIO-Link website (www.vaio-link.com).

Using power modes

The colour of the power indicator light(s) on the main unit tells you which mode the computer is in.

'VAIO' light	Power indicator	Mode
Blue	No light	Computer is in Normal mode
No light	Amber	Computer is in Standby mode
No light	No light	Computer is turned off or in Hibernate mode

 Please see the printed **Specifications** sheet for the exact location of the indicators.

To set the timer for your computer to automatically enter **Standby** or **Hibernate** mode after a certain amount of time, go to **Control Panel**, click **Performance and Maintenance** and change the settings under **Power Schemes**.

Using **Standby** mode

If you plan to stop using your computer for a short period of time (not overnight), you can put it into **Standby** mode instead of turning it off completely. Putting the computer into **Standby** mode saves energy and allows a quick return to normal computer use.

To activate **Standby** mode manually, proceed as follows:

- 1 Save your work, close all applications and close your Internet connection, if applicable.
- 2 Press the **Standby** button on the keyboard .

Alternatively;

- 1 From the **Start** menu on the Windows taskbar, select **Turn Off Computer**.
- 2 Select **Stand By**.
The computer goes into **Standby** mode, indicated by the amber light of the power indicator.

To return to **Normal** mode, press the **Standby** button again or any key on the keyboard.

 You can use the **Standby** button to turn the power on.

You can leave Windows running when using **Standby**.

When the computer is in **Standby** mode, you cannot insert a disc.

The computer comes out of **Standby** mode quicker than out of **Hibernate** mode and uses more power.

Using **Hibernate** mode

If you are interrupted and need to leave your computer suddenly, you can put it into **Hibernate** mode. This power saving mode saves you the time of shutting down in the normal way.

When you put your computer into **Hibernate** mode:

- Everything in the memory is saved to the hard disk.
- The monitor and system are turned off.
- The computer is turned off.
- The power indicator light turns off.

To activate **Hibernate** mode manually, proceed as follows:

- 1 Save your work.
- 2 From the **Start** menu on the Windows taskbar, select **Turn Off Computer**.
- 3 In the **Turn Off Computer** screen, hold down the **<Shift>** key to reveal the **Hibernate** button.
- 4 Click **Hibernate**.

The computer goes into **Hibernate** mode, the computer turns off.

To return to **Normal** mode, quickly press the power button.

Operation returns to the same state as before.

 You can leave Windows running when using **Hibernate**.

If you press the power button for more than six seconds, the computer will switch off completely.

When the computer is in **Hibernate** mode, you cannot insert a disc.

Hibernate uses less power than **Standby** and requires more time.

Using the media slots

As well as the Sony Memory Stick, your VAIO computer also supports other high capacity memory card formats, such as CompactFlash, Secure Digital (SD) and xD Picture. You can exchange digital data with a number of compatible products, such as digital cameras, mobile phones or handheld devices.

Please refer the manual of the individual devices and memory cards.

 Some devices may not support the formats that this PC uses as standard. In this case, you may see a message telling you to format the card.

- ! Before you use memory cards other than Memory Sticks in devices such as a digital camera or audio device, you must format them beforehand on the device which you use to record data. Please be aware that formatting the card will delete all the data on it.

Using Memory Sticks

Your VAIO computer is designed to support the Memory Stick. The Memory Stick is a compact, portable, and versatile device especially designed for exchanging and sharing digital data with compatible products, such as digital cameras, mobile phones and CLIÉ handheld devices. Because it is removable, it can be used for external data storage.

Use the flash memory technology to download anything that can be converted into digital data, such as pictures, music, words, sounds, movies and photographs.

Please see your printed **Specifications** sheet to see which Memory Stick types are compatible with your VAIO and if there are any limitations.

- You can purchase Memory Sticks from the Sony Style website (www.sonymstyle-europe.com), or from your local Sony dealer.
- Detailed information about which CLIÉ handhelds are compatible with which Memory Sticks can be found here: www.clie-link.com.
- Detailed information about which VAIO computers are compatible with which Memory Sticks can be found here: www.vaio-link.com.

Inserting a Memory Stick

To insert a Memory Stick, proceed as follows:

- 1 Insert the memory stick into the slot with the arrow side pointing upwards.
- 2 Make sure the memory stick is secure in the slot.
The memory stick is automatically detected by your system and appears in the **My Computer** window with its own drive.

 Always hold memory sticks with the arrow pointing in the correct direction when you insert it into the slot. To avoid damaging the computer or the memory stick, do not force the stick into the slot if it does not insert smoothly.

Removing a Memory Stick

To remove a Memory Stick, proceed as follows:

- 1 Make sure the indicator light is not on.
 - 2 Push the memory stick in to release it, and then pull it out.
-  You are recommended to remove the memory stick before shutting down the computer.

If an error message appears when you remove it, insert the memory stick into the slot again and press **<Enter>**. Wait until the active application finishes, then remove the memory stick. If the message confirms the ejection of the card, click **OK**.

Please do not remove the Memory Stick when the memory card access lamp is on. Otherwise, the card may not be detected the next time it is inserted into the slot. If the stick is removed by mistake and is subsequently not detected, please shut off the power of the computer, wait ten seconds and then turn it on again.

Write-protecting Memory Sticks

Some Memory Sticks are designed with an erasure prevention switch to protect valuable data from accidental erasure or overwriting. Move the tab horizontally or vertically to set or release write-protection. When the erasure prevention switch is off, data can be saved on the Memory Stick. When the erasure prevention switch is on, data can be read from but not saved on the Memory Stick.

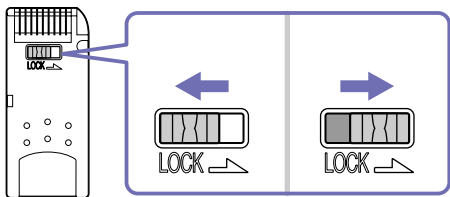

 Some kinds of Memory Stick do not have a lock switch.

Using xD Picture cards

Your VAIO has an xD-Picture card slot that allows you to transfer pictures between your digital camera, PC, PDA, printer and more. The xD-Picture Card is small and light, featuring high-speed transfer rates and high-volume capacity. Currently available in 16 MB, 32 MB, 64 MB, 128 MB and 256 MB versions, the card reaches high read/write speeds, and has an impressive range of compatibility.

Inserting an xD Picture card

To insert an xD Picture card, proceed as follows:

- 1 Insert the memory card into the slot with the arrow side pointing upwards.
- 2 Make sure the card is secure in the slot.
The card is automatically detected by your system and appears in the **My Computer** window with its own drive.

 Always hold memory cards with the arrow pointing in the correct direction when you insert it into the slot. To avoid damaging the computer or the memory card, do not force the card into the slot if it does not insert smoothly.

Removing an xD Picture card

To remove an xD Picture card, proceed as follows:

- 1 Make sure the indicator light is not on.
 - 2 Push the card in to release it, and then pull it out.
-  You are recommended to remove the memory card before shutting down the computer.

If an error message appears when you remove it, insert the memory card into the slot again and press **<Enter>**. Wait until the active application finishes, then remove the memory card. If the message confirms the ejection of the card, click **OK**.

Please do not remove the memory card when the access lamp is on. Otherwise, the card may not be detected the next time it is inserted into the slot. If the card is removed by mistake and is subsequently not detected, please shut off the power of the computer, wait ten seconds and then turn it on again.

Using CompactFlash cards

Your VAIO desktop has a CompactFlash slot that supports Type I or Type II cards. CompactFlash is a removable mass storage device. And is used to interconnect digital cameras, digital music players, desktop computers, handheld PCs, personal communicators, Palm PCs, digital voice recorders and photo printers. Its advanced features include a high transfer rate for fast copy/download and a high storage capacity.

- This slot cannot be use anything except for writing and reading memory cards or storage device cards.
- Some CompactFlash cards may require you to disable idle devices during use.
- You may not be able to use some of the card's features with this computer.
- Your system may run into serious problems if;
 - you remove the card or turn the computer off while the card is in use.
 - your working environment contains high electrical activity.
- When not is use, always put the CompactFlash card in its case to avoid high electrical effects.

Inserting a CompactFlash card

Simply insert the card gently into the card slot.

The card is automatically detected by your system and will appear with its own icon under **My Computer**.

 Do not force a CompactFlash card into the slot. It may damage the connector pins. If you have difficulty inserting a CompactFlash card, check that you are inserting the card in the correct direction. See the manual supplied with your card for more information on use.

Removing a CompactFlash card

To remove a CompactFlash card, proceed as follows:

- 1 Make sure the card is not in use and the indicator is not lit.
- 2 Push the card in to release it, and then pull it out.

 If you remove the CompactFlash card from the computer when it is still in use, unsaved data may be lost. Always back up important data.

Using Secure Digital cards

The Secure Digital (SD) card is a small, high-capacity data storage media card.

 The Secure digital card slot is exclusively for the use of SD cards and Multi Media cards. Please do not insert other memory cards.

Inserting a Secure Digital card

To insert the SD card, proceed as follows:

- 1 Insert the SD card into the SD card slot.
- 2 Push the card in until it clicks into place.
The card is automatically detected by your system and will appear with its own icon under **My Computer**.

! Do not force the SD card into the slot. If you have difficulty with it, check that you are inserting the card in the correct direction. See the manual supplied with your card for more information on use.

Removing a Secure Digital card

To remove an SD card, proceed as follows:

- 1 Make sure the card is not in use and the indicator is not lit.
- 2 Push the card in to release it, and then pull it out.

 If you remove the SD card from the computer when it is still in use, unsaved data may be lost. Always back up important data.

Troubleshooting memory cards

Check the write-protect switch on your Memory Stick. If it is set to on, you cannot write or delete data on the card.

Expansion capabilities

There are four expansion slots at the rear of your VAIO computer, as follows:

- ❑ **Top slot:** AGP slot containing the graphics card.
- ❑ **Second slot:** Empty PCI slot.
- ❑ **Third slot:** PCI slot containing the **TV tuner** ports.
- ❑ **Bottom slot:** CNR slot containing the modem card.

Empty PCI slots allow you the choice of adding to the expansion capabilities of your computer.

You are strongly advised not to add hardware yourself. Please contact your local Sony dealer for advice on changing the internal hardware components.

Connecting peripheral devices

You can add functionality to your computer by using the various ports on your unit.

To identify and locate the ports on your computer, please see the printed **Specifications** sheet.

- ❑ Connecting a display ([page 37](#))
- ❑ Connecting a Universal Serial Bus (USB) device ([page 41](#))
- ❑ Connecting a printer ([page 42](#))
- ❑ Connecting an i.LINK device ([page 43](#))
- ❑ Connecting an S/PDIF device ([page 44](#))
- ❑ Connecting a microphone ([page 44](#))
- ❑ Connecting to a network ([page 45](#))

Sony computer supplies, accessories and peripherals can be purchased from your local retailer or from the Sony website: www.sonymstyle-europe.com

For more information about connection compatibility, go to the VAIO-Link website: www.vaio-link.com

Connecting a display

You can connect multiple displays to your desktop, each using a different port on the back of your computer:

- an LCD screen using the DVI-D connector

- a TV using the TV/video out connector

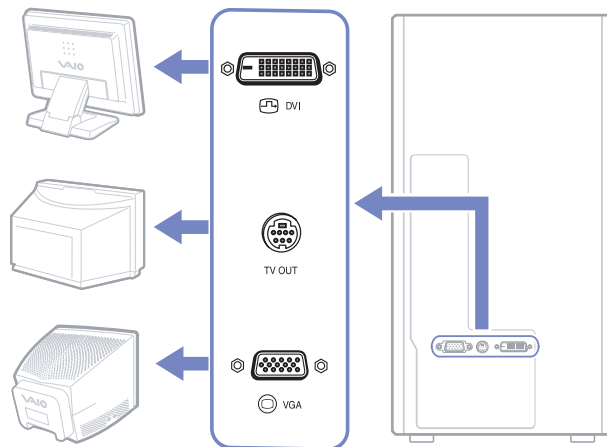

- a CRT or LCD screen using the VGA connector



Please make note of the following viewing possibilities:

- If you have a VGA and a DVI-D connected, the image is shown on both screens by default.
- If you have a VGA and a TV connected, the image is shown on both screens by default.
- If you have a DVI-D and a TV connected, the image is shown on both screens by default.
- If you have a VGA, a DVI and a TV connected, the image will be shown on both the VGA and the DVI-D by default.

To change your display from VGA to DVI-D or vice versa, proceed as follows:

- 1 Connect the display(s), as described in the printed **Getting Started** or in the instructions delivered with the display, if applicable.
- 2 Go to **Control Panel**.
- 3 Click **Appearance and Themes** then **Display**.
The **Display Properties** dialog box appears.
- 4 Click the **Settings** tab and then **Advanced**.
- 5 On the **Displays** tab, click  next to the **DVI** button.
- 6 Make sure  is selected and click **OK** when you have finished.

Connecting a TV set

You can connect a TV directly to your computer.

In order to be able to use a TV screen, you also have to enable the TV output function.

Your VAIO desktop is delivered with a TV/video out cable (or 'converter cable'), which is for use with TV sets without an S-Video port.

Connecting a TV that has no S-Video port

To connect a TV to your VAIO desktop with the supplied TV/video out cable, proceed as follows:

- 1 Plug one end of the TV/video out cable into the TV/video out port on the back of your computer.
- 2 Take your composite cable (not supplied) and connect one end to the inserted TV/video out cable.
- 3 Connect the other end to the yellow-coloured port (video-in) on your TV set.
The video output is now in place.
- 4 Connect the single end of your audio cable (not supplied) to the headphones port, either on the back of your computer or on the connected speaker.
- 5 Connect the double end of the audio cable to the red and white ports respectively on your TV set.
The audio output is now in place and your TV is ready for use with your computer.

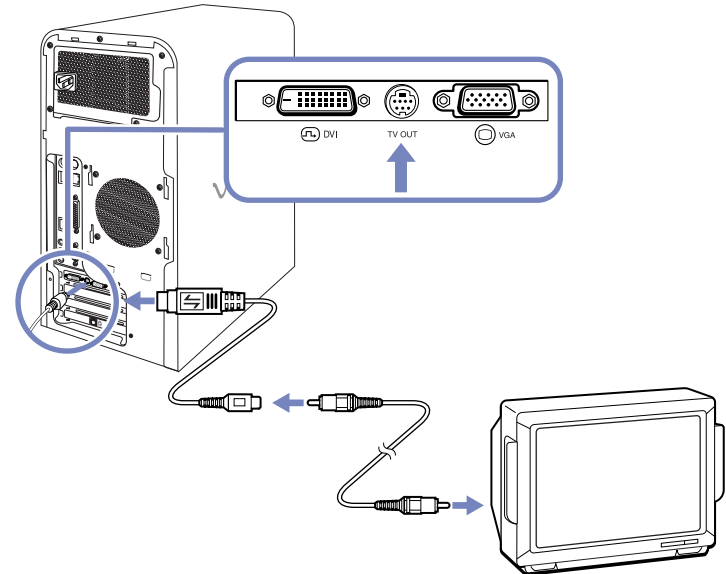



Connecting a TV that has an S-Video port

To connect a TV to your VAIO desktop with an S-Video cable (not supplied), proceed as follows:

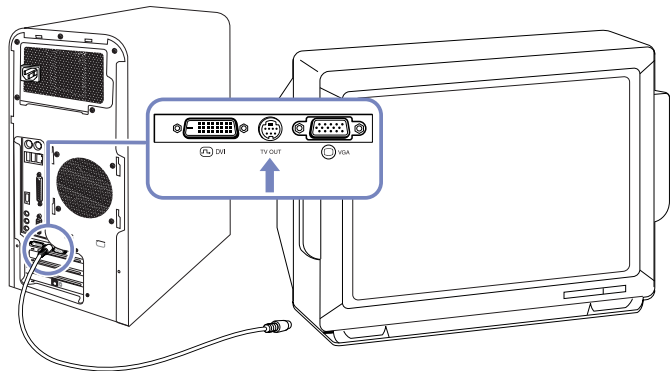
- 1 Plug one end of the S-Video cable into the TV/video out port on the back of your computer.
- 2 Plug the other end of the S-Video cable into your TV's S-Video port.



To enable TV output, proceed as follows:

- 1 Go to **Control Panel**.
- 2 Click **Appearance and Themes**.
- 3 Click **Display**.
The **Display Properties** dialog box appears.
- 4 Click the **Settings** tab and then **Advanced**.
- 5 On the **Displays** tab, click  next to the **TV** button.
- 6 Make sure  is selected and click **OK** when you have finished.

Connecting a Universal Serial Bus (USB) device

You can connect a USB device such as a scanner, a floppy disk drive or a printer, to your VAIO desktop.

To connect a USB device, simply plug in the USB cable of the device into one of the  ports on your computer.

- ❑ USB devices are hot plug and play devices. You do not need to shut down your computer prior to connecting these devices unless the manual supplied with the device states otherwise.
- ❑ For some USB devices you need to install the software before you connect the device. Not following this procedure might cause the device not to work properly. For more information, check the manual provided with the USB device.

Connecting a printer

To connect a printer, you can use either the printer port or a USB port, depending on the cable you use for your printer. Please see your printer's documentation for details on connection and installation.

Always check the printer manufacturer's website for the latest drivers for your operating system. Some printers do not function properly without updated drivers.

USB printer drivers should be automatically installed. Once you plug the printer's USB cable into one of the USB ports on your computer, the **Found New Hardware Wizard** will guide you through any setup procedure you need to follow.

If the printer is not automatically installed, you can try the following:

- 1 From the **Control Panel**, select **Printers and Other Hardware**, then **Printers and Faxes**.
- 2 Under **Printer Tasks**, click **Add a printer**.
- 3 Let the **Add Printer Wizard** guide you through the installation process.
- 4 Click **Finish**.
The printer is now installed.

 This procedure applies for most, but not for all printers.

Troubleshooting printing

If you have problems printing, check the printed **Guide to Troubleshooting and Recovering your VAIO System**; the documentation delivered with your printer; and the VAIO-Link website (www.vaio-link.com).

Connecting an i.LINK device

Your VAIO computer includes a 4-pin i.LINK port on the front of the system and a 6-pin i.LINK port on the back of the system. Use these ports (i) to connect an i.LINK device such as a digital video camera recorder, or to link up two VAIO computers so you can copy, delete or edit files.

- ❑ The i.LINK device will need its own power supply.
- ❑ You are strongly advised to use only Sony i.LINK cables, as using other brands may cause problems with the i.LINK devices.
- ❑ The i.LINK connection may vary, depending on the software applications, operating system, and compatible i.LINK devices. Not all products with an i.LINK connection may communicate with each other.
- ❑ Please refer to the documentation that came with your compatible i.LINK device and software for information on operating conditions and proper connection.

Connecting a digital video camera recorder

To connect a digital video camera recorder, proceed as follows:

- 1 Plug one end of the i.LINK cable (not supplied) into the i.LINK port (i) of the computer and the other end into the DV out port on your digital video camera recorder.
On Sony digital video cameras, ports marked DV out, DV in/out or i.LINK are i.LINK-compatible.
 - 2 Launch the **DVgate Plus** application (see the Help files within the software itself for more information).
-  If the connected i.LINK device is not recognised, disconnect the i.LINK device, then connect it again.

Troubleshooting i.LINK devices

If you have problems with your i.LINK device, check the printed **Guide to Troubleshooting and Recovering your VAIO System**, the documentation delivered with the device, and the VAIO-Link website (www.vaio-link.com).

Connecting an S/PDIF device

The S/PDIF (Sony/Philips Digital Interface) port on your computer allows you to transfer audio files to optical devices. The advantage is that it does not use the conversion to and from an analog format, which could degrade the signal quality.

Please read the documentation provided with your optical device for connection information.

Connecting a microphone

Your VAIO desktop does not contain an internal microphone. If you need to use a sound input device, for example to chat on the Internet, you need to plug in an external microphone.

To connect an external microphone, plug the microphone cable into the microphone connector identified by the symbol .

 Make sure your microphone is designed for computer use.

Connecting to a network

Your computer comes with a built-in Ethernet interface.

To connect to a network, proceed as follows:

- 1 Connect your 10BASE-T/100BASE-TX Ethernet cable (not supplied) to the Ethernet port, identified by the symbol , on the back of the computer.
If there is a sticker covering the Ethernet port, this is to remind customers in Germany not to insert an ISDN cable (see caution below).
- 2 Go to **Start**, right-click **My Computer** and select **Properties**.
- 3 Click the **Hardware** tab and select **Device Manager**.
The **Device Manager** screen appears with the list of devices.
- 4 Under **Network Adapters**, right-click the name of the adapter and click **Properties**.
- 5 Under **Device Usage**, select **Use this device (enable)**.
- 6 Click **OK** to close the **Properties** window.
The Ethernet connection is now enabled.

! Connect only 10BASE-T/100BASE-TX cables to the Ethernet port. Using other cables or a telephone cable may cause a malfunction, excessive heat or even fire in the port. If using this computer in Germany, please make sure you do not use an ISDN cable. It is physically very similar, but its higher voltage of 12V may destroy the motherboard inside the computer.

 For more information about connecting your VAIO desktop to the network, please consult the hardware troubleshooting section of the VAIO-Link website (www.vaio-link.com).

For help on connecting to a network, see your network administrator if you have one.

Upgrading your VAIO computer

Sony recommends contacting your local dealer for upgrade or maintenance of your new computer. Your local dealer has knowledge of this specialised personal computer and familiar with the safety practices and regulatory compliance required for using and modifying electronic equipment.

The upgrading procedures described in this section assume that you are familiar with the general terminology associated with personal computers and with the safety practices and regulatory compliance required for using and modifying electronic equipment.

Disconnect the computer from its power source and from telecommunication links, networks, or modems before you open the unit or follow any procedures described in this section.

Your computer may not be equipped with all of the hardware features mentioned in this section. The interior configuration of your system may vary from the illustrations, depending on the computer purchased.

To view the hardware configuration for your computer, see the printed **Specifications** sheet.

Your VAIO desktop and memory modules use high precision components and electronic connector technology. To avoid the invalidation of your guarantee by mishandling, it is recommended that:

- You contact your local Sony dealer to install any new internal hardware components.
 - You do not install memory modules yourself, if you are not familiar with upgrading memory on a computer.
 - Please contact VAIO-Link if you need assistance.
- ! Failure to disconnect your computer from its power source may result in personal injury or equipment damage.
- ! Electrostatic discharge (ESD) can damage disk drives, add-on cards, and other components. Follow the procedures here only at an ESD workstation. Otherwise, do not work on a carpeted area and do not handle materials that produce or hold static electricity, such as cellophane wrappers. Ground yourself by keeping constant contact with an unpainted metal part of the unit while carrying out any of these procedures.

Upgrading memory

In the future, you may want to upgrade the memory installed on your VAIO by replacing / adding memory modules. However, we recommend that you do not install them yourself unless you are familiar with upgrading memory on a computer.

For memory upgrades, use only those modules mentioned in the printed **Specifications** table.

Be careful when adding memory yourself. Mistakes on installation or removal of the memory module may cause a malfunction.

Electrostatic discharge can damage electronic components. Before touching a memory expansion board, remember the following:

- ❑ Handle the memory module gently.
 - ❑ The procedures described in this document assume familiarity with the general terminology associated with personal computers and with the safety practices and regulatory compliance required for using and modifying electronic equipment.
 - ❑ Disconnect the system from its power source and from any telecommunication links, networks, or modems before you open the system. Failure to do so may result in personal injury or equipment damage.
 - ❑ Do not open the memory module package until you are ready to install the module. The package protects the module from ESD.
 - ❑ Use the special bag delivered with the memory module, or wrap the module in aluminium foil to protect it from electrostatic discharge.
-  Do not place the memory module in places subject to: Heat sources such as radiators or air ducts, direct sunlight, excessive dust, mechanical vibration or shock, strong magnets or speakers that are not magnetically shielded, ambient temperature of more than +35°C or less than +5°C, or high humidity.
- !** Introducing any liquids or any foreign substances or objects into the memory slots, or other internal components of the computer, will result in damage to the computer and any repairs will be out of warranty.

Viewing the amount of memory

To view the amount of memory, proceed as follows:

- 1 Turn on the computer.
- 2 Click the **Start** button, point to **All Programs**, then **VAIO System Information**, and click **VAIO System Information** again. You can view the amount of installed memory here.

Adding / replacing a memory module

If you are not familiar with upgrading memory on a computer, we highly recommend that you contact your dealer.

To add or change a memory module, proceed as follows:

- 1 Shut down the computer, unplug it, and remove any peripheral devices.
- 2 Wait for the computer to cool down.
The inside of the main unit becomes very hot during operation. Wait for about one hour for the computer to cool down before opening the unit.
- 3 Position the main unit so the back panel is facing you.
- 4 Unscrew the three cover release screws located on the edges of the back panel, and set them aside.
The cover is released.
- 5 Slide the cover towards the back of the unit to remove it then gently place the unit on its side.

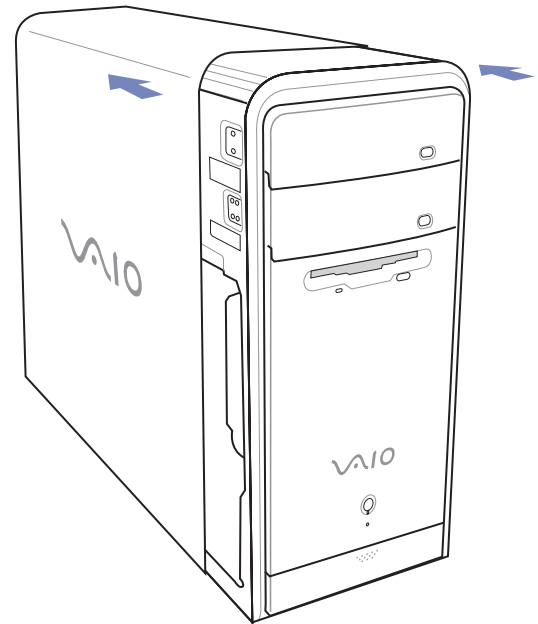

- 6 To remove an existing memory module, release the end latches and gently lift out the module, as shown (may vary from actual configuration).

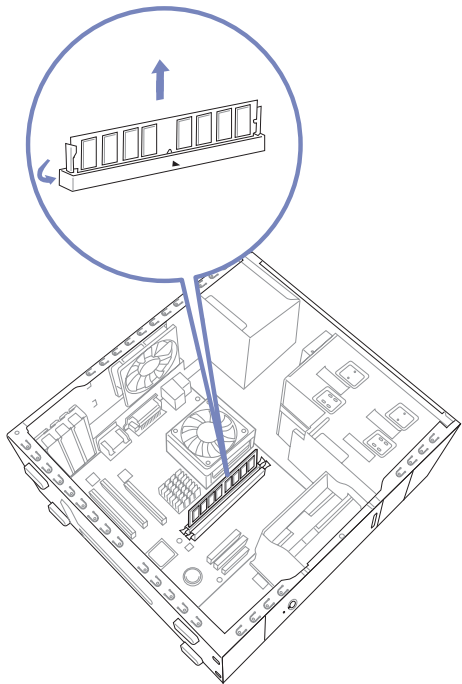

- 7 To insert a new memory module, remove it from its anti-static package, handling it only by the edges.
- 8 Locate the notch on the bottom edge of the memory module.
- 9 Align the memory module over the slot, making sure the module is facing the correct way.

- 10 Press evenly against the memory module's upper corners. The end latches snap into position automatically.
- 11 Reinstall any add-on cards or components you removed.
- 12 Replace the cover sliding the cover firmly over the unit, sliding it forward until the cover snaps into place.
- 13 Replace the three release screws.

 The illustrations here may vary from the actual configuration of your VAIO.

- ! Use only the memory modules specified on the printed **Specifications** sheet.
- ! To avoid damaging a memory module or the memory module slot, move the side latches slightly outward to relieve pressure. The module is properly inserted when the side latches click into place.

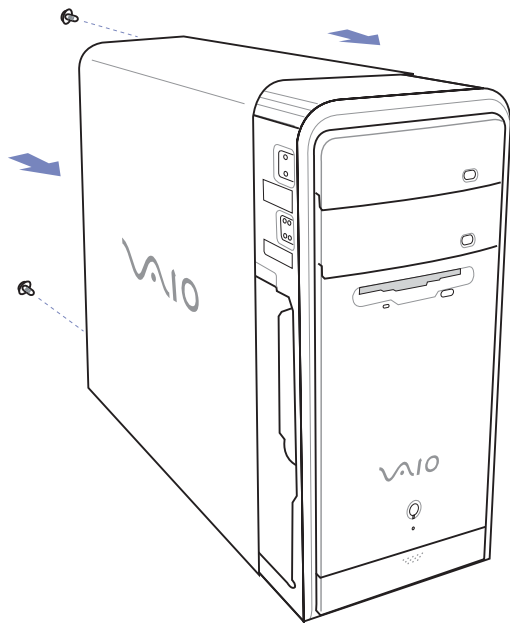

Getting help

This section describes how to get help and support if something goes wrong with your computer. Sony offers you many support options for your computer.

Sony documentation

Please see the section **Documentation pack (page 8)** for details on the printed and non-printed documentation delivered with your computer, as well as further sources of reference.

Other sources of information

- Go to the **online help files** that accompany your software for instructions on using the software.
- Go to the **online help files** in the **Windows Help and Support Center** by pressing the <F1> key.
- VAIO-Link website:** If you have any problems with your computer, you can access the VAIO-Link website for troubleshooting. Go to: www.vaio-link.com
- e-Support:** This interactive part of our website www.vaio-link.com allows you to get in contact with our dedicated support team over the internet. Using a personalised account, you can log your technical queries with ease.
- VAIO-Link help lines:** Before contacting VAIO-Link by telephone, try to solve the problem by reading the non-printed and printed documentation.
- Visit the other Sony websites:
 - www.club-vaio.com if you want to know more about VAIO and become part of the growing VAIO community.
 - www.sonystyle-europe.com for online purchases.
 - www.sony.net for other Sony products.

 You need to set up an Internet connection before you can access the online features described here.

e-Support

What is e-Support?

You have searched our user guides and website (www.vaio-link.com) but have not found an answer to your question/issue? e-Support is the ideal solution for you!

Our e-Support Web Portal is an interactive website on which you can submit any technical query you may have regarding your VAIO and receive answers from our dedicated support team.

Every submitted query will result in a unique 'case number' to ensure smooth communication between yourself and the e-Support Team.

Who can use e-Support?

All registered VAIO customers are entitled to unlimited access to the VAIO-Link e-Support Web Portal.

How can I access the e-Support portal?

When you register your VAIO computer online at Club-VAIO (www.club-vaio.com), you will automatically receive an email with the link to the e-Support Web Portal, your Customer ID and some basic explanation a few hours later.

All you need to do is activate your account by clicking on the provided link in the email.

You are now ready to create your first case!

You can access the e-Support Web Portal from any computer with an active Internet connection.

A complete help file is available on the e-Support Web Portal to help you use our e-Support Service.

Can I submit questions in my native language?

Since you are interacting with our e-Support Team through a portal, which connects you directly to our central database, e-Support will only accept and deal with queries submitted in English.

Can I submit my questions at any time?

Yes, you can submit your questions 24/7, but please keep in mind that our e-Support Team can only treat your queries from Monday till Friday between 8am and 6pm.

Is there a cost involved for using e-Support?

No, this is a complete free of charge service offered to all registered VAIO customers!

How do I know when the e-Support Team has handled my query/case?

As soon as your case has been dealt with by our e-Support Team, you will receive an email, notifying you that your case has been updated.

Precautions

This section describes safety guidelines and precautions to help you protect your computer from potential damage. Please contact VAIO-Link if you need assistance.

- ❑ On handling the hard disk ([page 55](#))
- ❑ On using the power source ([page 56](#))
- ❑ On handling your computer ([page 57](#))
- ❑ On handling LCD screens ([page 58](#))
- ❑ On handling floppy disks ([page 59](#))
- ❑ On handling discs ([page 59](#))
- ❑ On handling Memory Sticks ([page 60](#))

On handling the hard disk

The hard disk has a high storage density and reads or writes data in a short time. However, it can be easily damaged by mechanical vibration, shock or dust.

Although the hard disk has the internal safety device to prevent losing data due to mechanical vibration, shock or dust, you should be careful when handling your computer.

To avoid damaging your hard disk:

- Do not subject your computer to sudden movements.
- Keep the computer away from magnets.
- Do not place your computer in a location subject to mechanical vibration or in an unstable position.
- Do not move your computer while the power is on.
- Do not turn off the power or restart the computer while reading or writing data to disk.
- Do not use your computer in a place subject to extreme changes in temperature.

 If the hard disk is damaged, the data cannot be restored.

On using the power source

- ❑ See the printed **Specifications** sheet to check the power operation of your VAIO.
- ❑ Do not share the AC outlet with other high power-consuming equipment, such as a photocopier or shredder.
- ❑ You can purchase a power strip with a surge protector. This device prevents damage to your computer caused by sudden power surges, in an electrical storm, for example.
- ❑ Do not place heavy objects on the power cord.
- ❑ To disconnect the cord, pull it out by the plug. Never pull the cord itself.
- ❑ Unplug your computer from the wall outlet if you are planning to not use the computer for a long time.
- ❑ Make sure that the socket outlet is easily accessible.

On handling your computer

- ❑ Clean the unit with a soft cloth, which is either dry or lightly moistened with a mild detergent solution. Do not use any type of abrasive pad, scouring powder, or solvent such as alcohol or benzene, as these may damage the finish of your computer.
- ❑ Should you drop a solid object or any liquid onto the computer, shut down your computer and then unplug it. You may want to have the computer checked by qualified personnel before operating it again.
- ❑ Do not drop the computer or place heavy objects on top of the computer.
- ❑ Do not place your computer in a location subject to:
 - ❑ Heat sources, such as radiators or air ducts
 - ❑ Direct sunlight
 - ❑ Excessive dust
 - ❑ Moisture or rain
 - ❑ Mechanical vibration or shock
 - ❑ Strong magnets or speakers that are not magnetically shielded
 - ❑ An ambient temperature of more than 35°C or less than 5°C
 - ❑ High humidity.
- ❑ Do not place electronic equipment near your computer. The electromagnetic field of your computer may cause a malfunction.
- ❑ Provide adequate air circulation to prevent internal heat from building up. Do not place your computer on porous surfaces such as rugs or blankets, or near material such as curtains or draperies that may block its ventilation slots.
- ❑ The computer uses high-frequency radio signals and may cause interference to radio or TV reception. Should this occur, relocate the computer a suitable distance away from the set.
- ❑ Use only specified peripheral equipment and interface cables; otherwise, problems may occur.
- ❑ Do not use cut or damaged connection cables.

- ❑ If the computer is brought directly from a cold location to a warm one, moisture may condense inside your computer. In this case, allow at least one hour before turning on your computer. If any problems occur, unplug your computer and contact VAIO-Link.
- ❑ Make sure you disconnect the power cord before cleaning the computer.
- ❑ As you may lose important data once your computer is damaged, you should back up your data regularly. You can restore most of the original application programs from the supplied disc (read the **Guide to Troubleshooting and Recovering your VAIO System** for details).

On handling LCD screens

- ❑ Do not leave the LCD facing the sun as it can damage the LCD. Be careful when using the computer near a window.
- ❑ Do not scratch the LCD or exert pressure on it. This could cause malfunction.
- ❑ Using the computer in low temperature conditions may produce a residual image on the screen. This is not a malfunction. When the computer returns to normal temperature, the screen returns to normal.
- ❑ A residual image may appear on the screen if the same image is displayed for a lengthy period of time. The residual image disappears in a while. You can use a screensaver to prevent residual images.
- ❑ The screen becomes warm during operation. This is normal and does not indicate a malfunction.
- ❑ The LCD is manufactured using high-precision technology. You may, however, see tiny black points and/or bright points (red, blue, or green) that continuously appear on the LCD. This is a normal result of the manufacturing process and does not indicate a malfunction.
- ❑ Avoid rubbing the LCD screen, as this can damage the screen. Use a soft, dry cloth to wipe the LCD screen.

On handling floppy disks

- ❑ Do not open the shutter manually or touch the surface of the floppy disk.
- ❑ Keep floppy disks away from magnets.
- ❑ Keep floppy disks away from direct sunlight and other sources of heat.

On handling discs

- ❑ Do not touch the surface of the disc.
- ❑ Do not drop or bend the disc.
- ❑ Fingerprints and dust on the surface of a disc may cause reading errors. Always hold the disc by its edge and central hole, as shown.

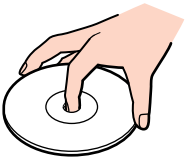

- ❑ Proper care of the disc is essential to its continuous reliability. Do not use solvents such as benzene, thinning agents, commercially available cleaners or anti-static spray, as they may cause damage to the disc.
- ❑ For normal cleaning, hold the disc by its edge and use a soft cloth to wipe the surface from the centre out.
- ❑ If the disc is badly soiled, moisten a soft cloth with water, wring it out well, and use it to wipe the surface of the disc from the centre out. Wipe off any remaining moisture with a dry soft cloth.
- ❑ Never put stickers on discs. This will affect the use of the disc irreparably.

On handling Memory Sticks

- ❑ Do not touch the Memory Stick connector with your finger or metallic objects.
- ❑ Use only the label supplied with the Memory Stick as a label.
- ❑ Do not bend, drop, or apply heavy shock to the Memory Stick.
- ❑ Do not disassemble or modify Memory Sticks.
- ❑ Do not let Memory Sticks get wet.
- ❑ Do not use or store Memory Sticks in a location subject to:
 - ❑ Extremely high temperatures, such as in a car parked in the sun
 - ❑ Direct sunlight
 - ❑ High humidity or
 - ❑ Corrosive substances.
- ❑ Use the storage case supplied with the Memory Stick.

Trademarks

Sony, Battery Checker, Click to DVD, DVgate Plus, HotKey Utility, Keyboard Utility, Memory Stick Formatter, PictureGear Studio, Prepare your VAIO, SonicStage, SonicStage Mastering Studio, Sony Notebook Setup, VAIO Edit Components, VAIO Launcher, VAIO Media, VAIO Power Management, VAIO Power Management Viewer, VAIO System Information, VAIO Zone, Memory Stick, the Memory Stick logo, VAIO and the VAIO logo are trademarks of Sony Corporation.

Microsoft, Internet Explorer, Windows Movie Maker, Windows Media Player, Windows XP Professional, Windows XP Home Edition, Microsoft Works and the Windows logo are trademarks or registered trademarks of Microsoft Corporation in the U.S. and other countries.

i.LINK is a trademark of Sony used only to designate that a product contains an IEEE1394 connection.

Adobe, Adobe Acrobat Elements, Adobe Acrobat Professional, Adobe Photoshop Album, Adobe Reader, Adobe Premiere Standard and Adobe Photoshop Elements are trademarks of Adobe Systems Incorporated.

MoodLogic is a trademark of MoodLogic, Inc.

Norton Internet Security 2004 and Norton Password Manager 2004 are trademarks or registered trademarks of Symantec Corporation.

RecordNow! is a trademark of Sonic.

WinDVD for VAIO is a trademark of InterVideo, Inc.

Sun Java VM is a trademark of Sun Microsystems, Inc.

Google Toolbar is a trademark of Google.

Yahoo! Messenger is a trademark of Yahoo!.

SafeGuard PrivateDisk is a trademark of Utimaco Software.

My Info Centre contains Macromedia Flash™ Player software by Macromedia, Inc., Copyright © 1995-2003 Macromedia, Inc. All rights reserved. Macromedia and Flash are trademarks of Macromedia, Inc.

All other names of systems, products and services are trademarks of their respective owners. In the manual, the ™ or ® marks are not specified.

Specifications are subject to change without notice. All other trademarks are trademarks of their respective owners.

Please see the printed Specifications sheet to see what software is available for your model.

Free Manuals Download Website

<http://myh66.com>

<http://usermanuals.us>

<http://www.somanuals.com>

<http://www.4manuals.cc>

<http://www.manual-lib.com>

<http://www.404manual.com>

<http://www.luxmanual.com>

<http://aubethermostatmanual.com>

Golf course search by state

<http://golfingnear.com>

Email search by domain

<http://emailbydomain.com>

Auto manuals search

<http://auto.somanuals.com>

TV manuals search

<http://tv.somanuals.com>