

WARNING

To prevent fire or shock hazard, do not expose the unit to rain or moisture.

To avoid electrical shock, do not open the cabinet. Refer servicing to qualified personnel only.

Welcome!

Thank you for purchasing the Sony Portable VIDEO CD Player. Before operating your player, please read this manual and retain it for future reference.

This player can play the following discs:

- VIDEO CD

Disc logo



Contents Audio & video signals

- Audio CD

Disc logo



Contents Audio signals only

There are 2 types of CDs in size — 12 cm and 8 cm. Their longest play time is 74 and 20 minutes respectively. The actual play time, however, varies among the CDs.

Note on VIDEO CDs

This player conforms to Version 1.1 and 2.0 of VIDEO CD standards. You can enjoy two kinds of playback according to the CD type.

Disc type	You can
VIDEO CDs without PBC functions (Version 1.1)	Enjoy video playback (moving pictures) as well as music.
VIDEO CDs with PBC functions (Version 2.0)	Play interactive software using menus displayed on the TV screen, in addition to the video playback function. Also play high-resolutive still pictures.

Table of contents

Playing a VIDEO CD	5
--------------------------	---

Playing an audio CD	8
---------------------------	---

Playing VIDEO CDs in Various Modes	10
-------------------------------------------------	-----------

Playing VIDEO CDs using the wireless remote control	10
Displaying the operating status on the TV screen	10
Playing multiplex VIDEO CDs	12
Adjusting the picture quality (Sharpness)	13
Playing VIDEO CDs in slow-motion (Slow-motion Play)	13
Playing in still picture mode (Flash Motion Play/ Multi Flash Play)	14
Playing VIDEO CDs with PBC functions (PBC Play)	15
Playing VIDEO CDs repeatedly (Repeat Play)	16
Using other functions	17
To resume playing from the point you stopped the VIDEO CD (Resume Function)	17
Connecting to other video equipment	17

Locating a Scene or Track in VIDEO CDs	18
-----------------------------------------------------	-----------

Locating a specific track by observing the TV screen (Search)	18
Locating a specific point directly	19
To locate a specific point using the video index numbers or the scene numbers (Video Index Search/ Scene Number Search) ..	19
To locate a specific point by inputting the time of the point (Time Jump Search)	20
To locate a specific point by observing nine scenes in the current track at one time (Track Digest Search)	20

Continue to the next page →

Table of contents (Continued)

Playing Audio CDs in Various Modes	21
Playing tracks repeatedly (Repeat Play)	21
Playing only the tracks you want (INTRO PGM Play)	22
Playing tracks in random order (Shuffle Play)	23
Playing tracks in the order you want (RMS Play)	23
Using other functions	24
To prevent sound from skipping (ESP)	24
To enjoy more powerful bass sound (MEGA BASS Function) ..	25
To lock the buttons (HOLD Function)	25
To resume playing from the point you stopped the audio CD (Resume Function)	26
To turn off the beep	26
Connecting to other stereo equipment	26

Power Source	27
Using alkaline batteries	27
Using the battery case	27
When to replace the dry batteries	28

Additional Information	29
Precautions	29
Troubleshooting	30
Maintenance	31
Specifications	32
Parts identification	33
Glossary	35

Playing a VIDEO CD

You can play back a VIDEO CD, using the supplied AC power adaptor. You can also use the alkaline batteries. (See "Power Source" on page 27.) To produce color pictures normally, you need to set the color system properly according to the connected TV.

1 Connect

To connect a TV equipped with audio/video input jacks

Use the supplied AV monitor cord.

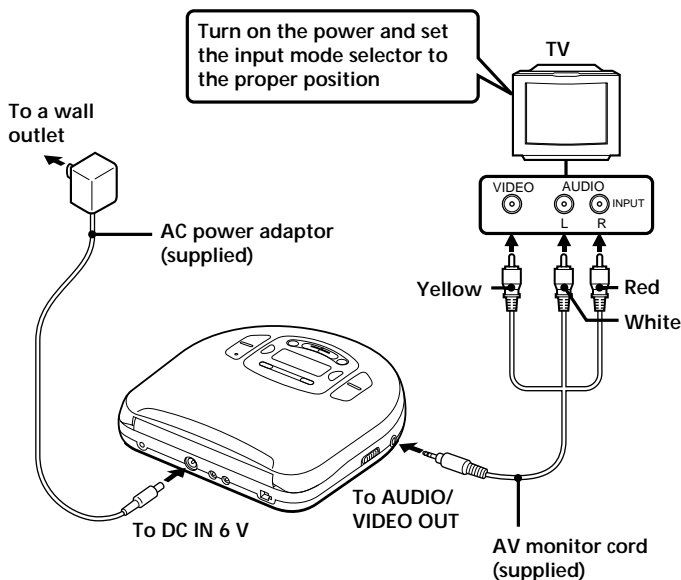

Continue to the next page →

2 Set the NTSC/PAL switch to "PAL" or "NTSC" according to the color system of your TV

Set the switch to "PAL" or "NTSC" using a pointed material.

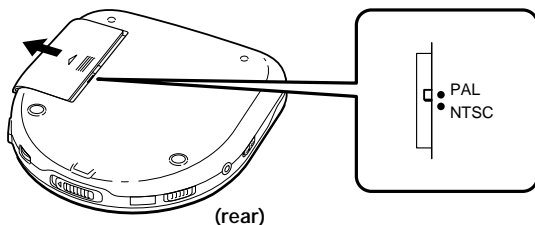

PAL system countries:

China, India, Indonesia, Singapore, Malaysia, etc.

NTSC system countries:

Japan, Korea, Taiwan, the U.S.A., etc.

3 Place a VIDEO CD

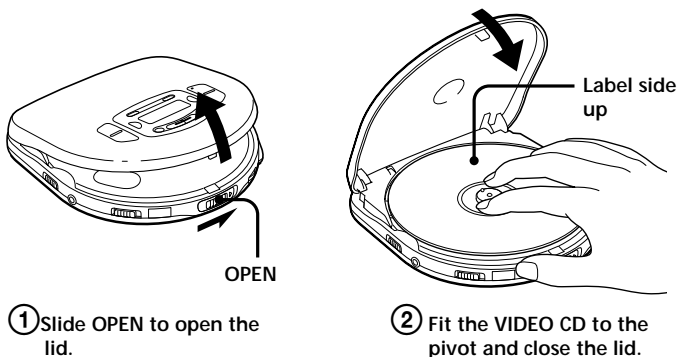

4 Play

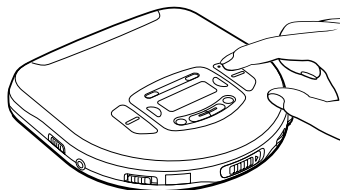

To	Do this
Pause	Press ▶ .
Resume play after pause	Press ▶ .
Locate the next or succeeding tracks	Press ▶▶ repeatedly until you find the track.
Locate the current or preceding tracks	Press ◀◀ repeatedly until you find the scene or track.
Locate a specific track directly	Press the number button of the track (wireless remote control only)
Locate a point in the track while monitoring the picture*	Press ◀◀1 or ▶▶1 and hold it down until ◀◀1 or ▶▶1 appears on the TV screen.
Locate a point in the track quickly while monitoring the picture*	While ◀◀1 or ▶▶1 appears on the TV screen, press ◀◀ or ▶▶ again and hold it down until ◀◀2 or ▶▶2 appears on the TV screen.

* To return to normal playback, press **▶||**.

To play the VIDEO CD with PBC functions, see page 15.

- 1 Press **▶||**.
The player starts playing a VIDEO CD.
- 2 Adjust the volume on the equipment connected to this player. (On this player, you can adjust the volume of the signals output from the PHONES/ REMOTE jack only.)

To stop playing, press **■**.
The player also turns off.

To remove the VIDEO CD

Remove the VIDEO CD while pressing the pivot.

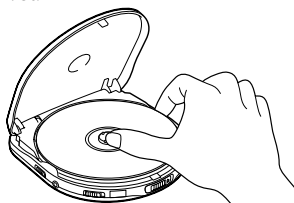

To connect to other stereo equipment

If you connect the player to the stereo equipment, you can enjoy better sound quality. For more details, see "Connecting to other stereo equipment" (page 26).

Playing an audio CD

You can also use the alkaline batteries. (See “Power Source” on page 27.)

1 Connect

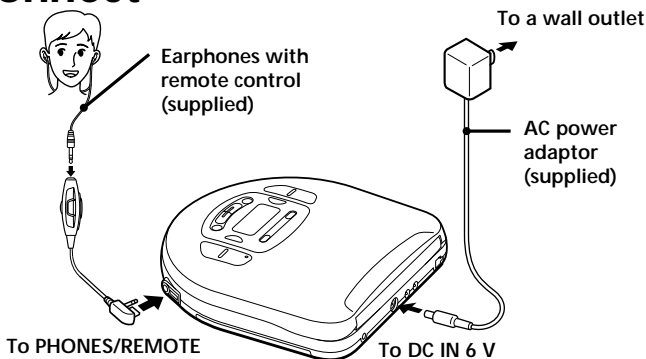

2 Place an audio CD

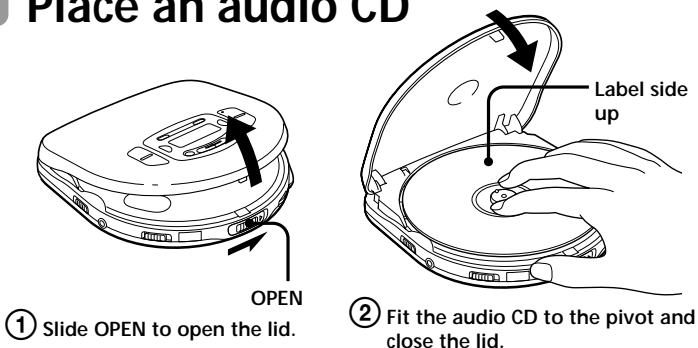

3 Play

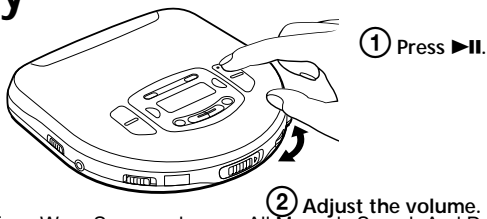

To	Press
Pause	▶
Resume play after pause	▶
Find the beginning of the current track (AMS*)	◀◀ once**
Find the beginning of previous tracks (AMS)	◀◀ repeatedly**
Find the beginning of the next track (AMS)	▶▶ once**
Locate a specific track directly	Number buttons of the track (wireless remote control only)**
Find the beginning of succeeding tracks (AMS)	▶▶ repeatedly**
Go forward quickly	Hold down ▶▶**
Go backwards quickly	Hold down ◀◀**

* AMS = Automatic Music Sensor

** These operations are possible during both play and pause.

To stop playing, press ■.

The player also turns off.

If you press REPEAT/ENTER to display "REPEAT", you can locate the tracks continuously in the following order:

- When using ▶▶: next track → next track last track → first track → second track
- When using ◀◀: previous track → previous track first track → last track

To remove the audio CD

Remove the audio CD while pressing the pivot.

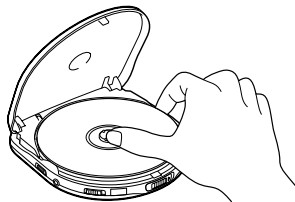

Notes on display

- When you press ▶|| (when RESUME is set to OFF), the total number of tracks in the audio CD and the total playing time appear for about 2 seconds.
- During play, the track number and the elapsed playing time of the current track appear.
- During pause, the elapsed playing time flashes in the display.
- Between tracks, the time to the beginning of the next track will appear with the "-" indication.

Using the earphones with remote control

You can use the remote control as the wired remote control.

- Connect the plug of the earphones to the remote control, not to the PHONES/REMOTE jack of the player.
- Connect the earphones to the remote control firmly. A loose connection may cause noise during playback.
- Press ▶ to play audio CD instead of ▶||.
- Turn VOL to adjust the volume.

Note

- Use only the supplied remote control. You cannot operate this player with the remote control supplied with other models.

▶ **Playing VIDEO CDs in Various Modes**

Playing VIDEO CDs using the wireless remote control

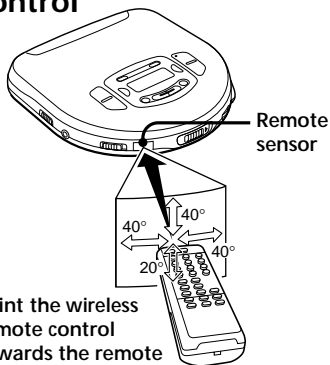

Point the wireless remote control towards the remote sensor of the player.

Note

- When using the player on alkaline batteries, you can turn on the player by pressing **▶||** on the wireless remote control within about 5 minutes after you turn it off. If 5 minutes have already passed, press **▶||** on the player to turn it on. (You cannot turn on the player using the wireless remote control.)
- Do not expose the remote sensor to direct sunlight or lighting apparatuses.
- Remove any obstacles between the remote sensor on the player and the wireless remote control.

To insert batteries into the wireless remote control

Insert two R6 (size AA) batteries by matching the **+** and **-** on the batteries.

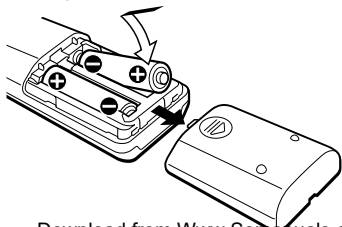

Displaying the operating status on the TV screen

You can check the operating status of the player and the information about the VIDEO CD on the TV screen.

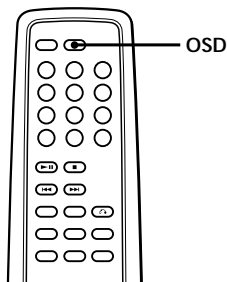

Press OSD.

Each time you press the button, the OSD (On-Screen Display) mode changes as follows:

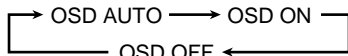

When "OSD AUTO" is selected, the operating status appears for a few seconds on the TV screen when you press a button or when the operating status is changed. When "OSD ON" is selected, the operating status, time display, etc. are always displayed.

■ **While playing a VIDEO CD without PBC functions/while playing back with PBC OFF**

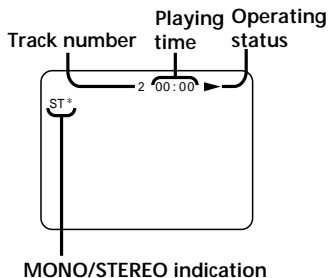

■ While playing a VIDEO CD with PBC functions

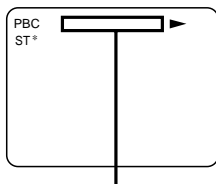

Scene number or video index number

* Settings of the ST/L/R, SHARPNESS, etc. are displayed for about a few seconds when you change the OSD modes.

Various indications displayed on the TV screen

Indication	What it means (page)
PBC	Playing a VIDEO CD with PBC functions with PBC ON (15)
SELECT	Waiting for you to select something (For instance, at the time of menu display) (15)
V INDEX	Video index search (19)
SCENE	Scene search (19)
FLASH*	In the Flash Motion mode (14)
MULTI*	In the Multi Flash mode (14)
DIGEST*	In the Track Digest mode (20)
RESUME	RESUME function works. (17)
NEXT XX	Next track number
PREV XX	Previous track number

Indications	What it shows (page)
▶	Playing (7)
	Pausing (7)
▶▶	Slow-motion playing (13)
▶▶▶	Searching forward (7, 18)
◀◀	Searching backwards (7, 18)
✋	The player cannot accept the operation
ST	Hearing stereo sound (12)
L	Hearing left channel sound (12)
R	Hearing right channel sound (12)
OSD OFF	OSD mode has been switched to "OSD OFF." (10)
OSD AUTO	OSD mode has been switched to "OSD AUTO." (10)
OSD ON	OSD mode has been switched to "OSD ON." (10)
PBC OFF	PBC mode has been switched to OFF. (16)
PBC ON	PBC mode has been switched to ON. (15)
NTSC	The NTSC/PAL switch is set to "NTSC". (6)
PAL	The NTSC/PAL switch is set to "PAL". (6)

* While selecting the mode, the indication flashes. Once the mode has been selected, the indication stops flashing.

Continue to the next page →

Indication	What it means (page)
SHARP	Picture quality is adjusted sharply. (13)
SOFT	Picture quality is adjusted softly. (13)
NORMAL	Picture quality is adjusted moderately. (13)
REP OFF	The repeat mode has been set to OFF. (16)
REP ALL**	Playing a whole VIDEO CD repeatedly (16)
REP 1**	Playing the current track repeatedly (16)

** Repeat play is not available during PBC playback.

Notes

- While playing an audio CD, the OSD mode cannot be displayed on the TV screen.
- When you record the playback picture of this player on another VCR, etc., be sure to select "OSD OFF". Otherwise, the display information will also be recorded on the VCR.
- The OSD mode returns to "OSD AUTO" when you turn off the player by pressing ■.

Playing multiplex VIDEO CDs

On multiplex VIDEO CDs, different sounds are recorded for the left and right channels. You can select either the left or the right channel and hear the sound of the selected channel. In this case, the stereo effect will be lost.

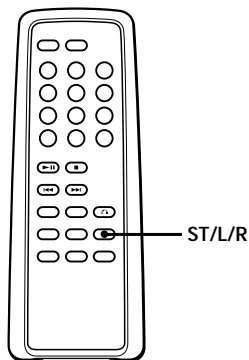

Press ST/L/R while playing a multiplex VIDEO CD.

Each time you press the button, the indication and sound you hear change as follows:

Press	Indication	You will hear
Once	L	Left channel sound
Twice	R	Right channel sound
Three times	ST	Stereo sound

The initial setting is "ST".

Adjusting the picture quality (Sharpness)

You can make the picture quality more distinct or softer by pressing the SHARPNESS button.

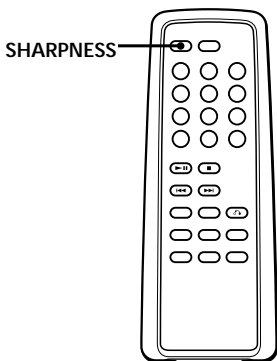

Press SHARPNESS while playing a VIDEO CD.

Each time you press the button, the indication changes as follows:



The initial setting is "NORMAL".

Playing VIDEO CDs in slow-motion (Slow-motion Play)

You can make the play speed slower. You can select two slow speeds.

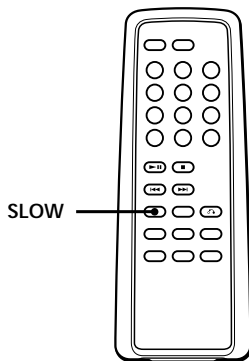

Press SLOW while playing a VIDEO CD. When you press SLOW again during slow play, the play speed will be much slower.

To cancel slow-motion play, press ►||.

When playback of the current track is finished, slow-motion play will be canceled automatically and return to normal play.

Playing in still picture mode (Flash Motion Play/Multi Flash Play)

You can change the pictures on the TV screen into the still pictures. While watching still pictures, you can hear the sound as usual.

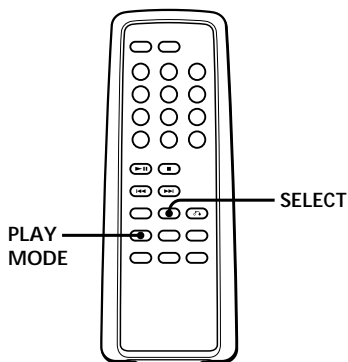

Flash Motion Play

While playing a VIDEO CD, press PLAY MODE twice to display "FLASH" on the TV screen and press SELECT. The player starts playing still pictures that change continually.

To cancel Flash Motion Play, press PLAY MODE repeatedly until the play mode indication disappears from the TV screen.

When playback of the current track is finished, Flash Motion Play will be canceled automatically and return to normal play.

Multi Flash Play

While playing a VIDEO CD, press PLAY MODE three times to display "MULTI" on the TV screen and press SELECT. The player starts playing the nine still pictures at one time. The pictures change one by one.

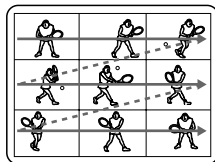

To cancel Multi Flash Play, press PLAY MODE repeatedly until the play mode indication disappears from the TV screen.

When playback of the current track is finished, Multi Flash Play will be canceled automatically and return to normal play.

Note

On some VIDEO CDs, intervals of the Flash Motion Play and the Multi Flash Play are longer or unstable.

Playing VIDEO CDs with PBC functions (PBC Play)

Using the PBC functions, you can play a VIDEO CD with PBC functions (Version 2.0) (simple interactive software, software with search functions, etc.).

Refer also to the instructions supplied with the VIDEO CD, as the operating procedure may differ depending on the VIDEO CD.

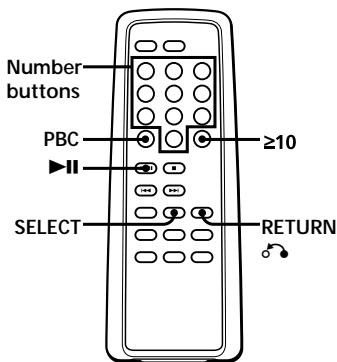

- 1 Insert a VIDEO CD with PBC functions (see page 6).
- 2 Press **▶||**. PBC playback starts, and the menu appears on the TV screen.
- 3 Press the number buttons to select item number of the menu you want to play.

For instance, to select item number 5, press 5.

To select an item number 10 or more, press ≥ 10 first, then the corresponding number buttons.

Examples:

For 12: ≥ 10 , then 1 and 2

For 24: ≥ 10 , then 2 and 4

For 135: ≥ 10 , ≥ 10 , then 1 and 3 and 5

On the player

Press MENU +/- to select the item number, then press SELECT.

- 4 Repeat the above procedure, following the instructions shown on the menu.

When	Press
You want to select an item number	Number button of the item you want on the wireless remote control. On the player: MENU +/- to select the item number, then SELECT.
"SELECT" is flashing on the TV screen while playing back moving pictures	Number buttons or MENU +/- and SELECT to select another scene even while playing back moving pictures.
You want to go back to the previous menus	RETURN  . (The actual operation varies among the VIDEO CDs. Refer to the instructions supplied with the VIDEO CDs.)

Note

When playing some VIDEO CDs, **▶** SELECT (or **▶**) appears on the TV screen, instead of SELECT. In that case, press SELECT on the remote control. If you press **▶||**, the player pauses.

To play the VIDEO CD in normal play mode and cancel play using PBC functions

Press PBC on the wireless remote control so that "PBC OFF" appears on the TV screen. "PBC" disappears from the display, and normal play starts (in the sequence of the track numbers). In this case, you cannot play still pictures such as menu screens.

To resume play using PBC functions, press PBC again.

When you change the PBC mode

When you change the PBC mode ("PBC ON" or "PBC OFF") and start play, the player plays the VIDEO CD from the beginning.

Playing VIDEO CDs repeatedly (Repeat Play)

You can play a whole VIDEO CD or a single track repeatedly.

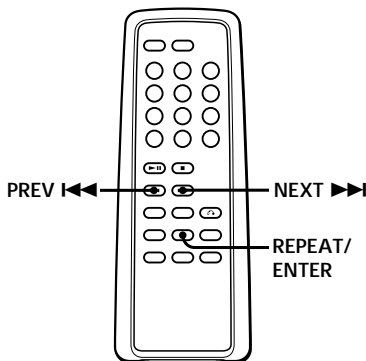

To repeat all the tracks on a VIDEO CD

While playing a VIDEO CD, press REPEAT/ENTER repeatedly until "REP ALL" appears on the TV screen.

To cancel repeat play, press REPEAT/ENTER until "REPEAT OFF" appears on the TV screen.

To repeat a single track

While the track you want to repeat is playing, press REPEAT/ENTER until "REP 1" appears on the TV screen.

To repeat another track, press ◀◀ or ▶▶ to select the track you want to repeat. While the track is playing, press REPEAT/ENTER.

To cancel repeat play, press REPEAT/ENTER until "REPEAT OFF" appears on the TV screen.

Note

This function is not available during PBC playback. To set PBC to OFF, see the left column.

Using other functions

To resume playing from the point you stopped the VIDEO CD (Resume Function)

Normally, every time you stop and play, playing starts from the beginning of the VIDEO CD. Resume play, however, lets you watch from the point where you last turned off the player.

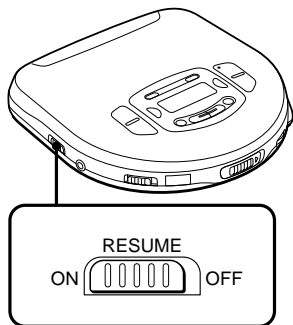

Set RESUME to ON.

To cancel resume play, set RESUME to OFF.

Notes

- When you open the lid, the memorized resume point is erased regardless of the setting of the RESUME switch. When you play the VIDEO CD the next time, it is played from the beginning.
- The resume point may be inaccurate by about 30 seconds.

Connecting to other video equipment

You can record a VIDEO CD on a video tape. Refer to the instruction manual supplied with other equipment for details.

Before making connections, turn off each equipment.

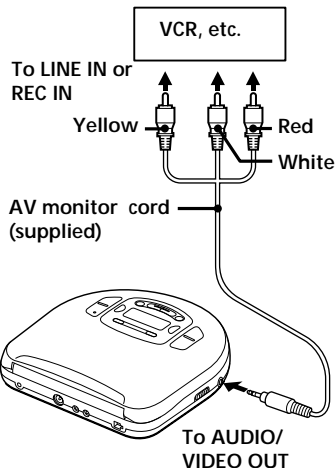

Note

- Before you play a disc, turn down the volume of the connected equipment so as not to damage the speakers.

► Locating a Scene or Track in VIDEO CDs

Locating a specific track by observing the TV screen (Search)

While playing a VIDEO CD, you can quickly locate any track or a specific point in a track by observing the TV screen.

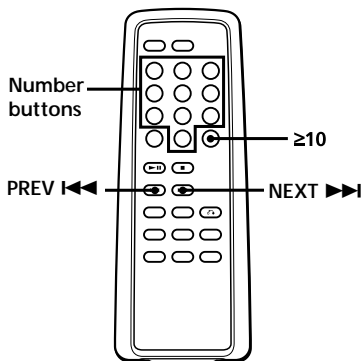

To	Do this
Locate the next or succeeding tracks	Press ▶▶1 repeatedly until you find the track.
Locate the current or preceding tracks	Press ◀◀1 repeatedly until you find the scene or track.
Locate a specific track directly	Press the number button of the track (wireless remote control only).
Locate a point in the track while monitoring the picture	Press ◀◀1 or ▶▶1 and hold it down until ◀◀1 or ▶▶1 appears on the TV screen.
Locate a point in the track quickly while monitoring the picture	While ◀◀1 or ▶▶1 appears on the TV screen, press ◀◀1 or ▶▶1 again and hold it down until ◀◀2 or ▶▶2 appears on the TV screen.

To directly locate a track number 10 or more

To select an item number 10 or more, press ≥ 10 first, then the corresponding number buttons.

Examples:

For 12: ≥ 10 , then 1 and 2

For 24: ≥ 10 , then 2 and 4

For 135: ≥ 10 , ≥ 10 , then 1 and 3 and 5

Locating a specific point directly

You can locate a specific point directly using the video index, scene numbers and the time of the point.

To locate a specific point using the video index numbers or the scene numbers (Video Index Search/ Scene Number Search)

Some VIDEO CDs with PBC functions have the video index numbers or the scene numbers. Some VIDEO CDs have both.

Check the current video index number or scene number by displaying it on the TV screen during playback. (See pages 11 and 12.)

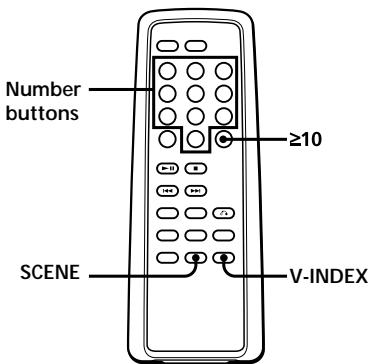

- 1 Press V-INDEX or SCENE while playing a VIDEO CD. "V INDEX" or "SCENE" appears on the TV screen.

The current video index number or scene number

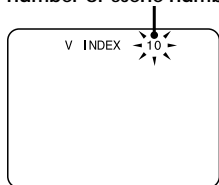

- 2 Press the number buttons to select the video index number or the scene number you want.

The selected video index number or the scene number appears on the TV screen.

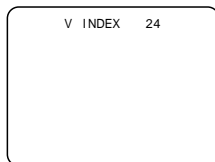

To select a number 10 or more, press ≥ 10 first, then the corresponding number buttons.

Examples:

For 12: ≥ 10 , then 1 and 2

For 24: ≥ 10 , then 2 and 4

For 135: ≥ 10 , ≥ 10 then 1 and 3 and 5

If you have made a mistake

Repeat the same procedure from Step 1 again.

To cancel the video index search or scene number search

Press V-INDEX or SCENE again.

Notes

- Some VIDEO CDs do not allow you to start playing from a particular scene. If you select a scene number while playing a VIDEO CD of this type, the selected scene number disappears from the TV screen, and the player keeps playing the current scene.
- You cannot use the Scene Search with tracks or VIDEO CDs which do not have scene numbers recorded.
- If you select the scene which has audio signals only, the scene will not be displayed on the TV screen.
- You cannot use Video Index Search with tracks or VIDEO CDs which do not have video index numbers recorded.
- You cannot search for video index numbers in different tracks.

To locate a specific point by inputting the time of the point (Time Jump Search)

You can locate a specific point directly by inputting the time of the point you want to find.

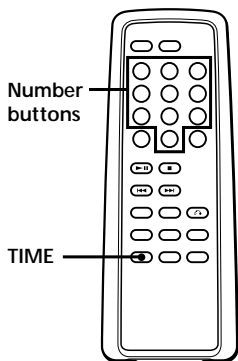

- 1 Press TIME while playing a VIDEO CD. "TIME" and "--:--" appear on the TV screen.

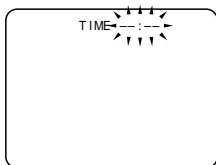

- 2 Press the number buttons to input the time of the point you want to find. The picture of the selected time appears on the TV screen.

To locate a specific point by observing nine scenes in the current track at one time (Track Digest Search)

You can locate a specific point directly by observing nine scenes in the current track at one time.

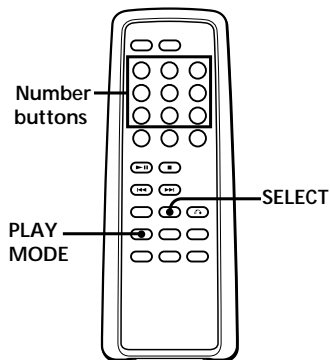

- 1 While playing a VIDEO CD, press PLAY MODE until "DIGEST" appears on the TV screen.

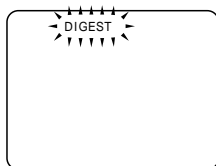

- 2 Press SELECT. The player separates the current track into nine parts automatically, and displays the first picture of each part on the TV screen numbering each picture 1 to 9.

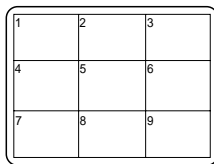

- 3 Press the number button of the picture you want to see. The player starts playing from the part you selected.

► *Playing Audio CDs in Various Modes*

Playing tracks repeatedly (Repeat Play)

You can play tracks repeatedly in normal, INTRO PGM, shuffle or RMS (Random Music Sensor) play modes. Repeat all the tracks or only one track.

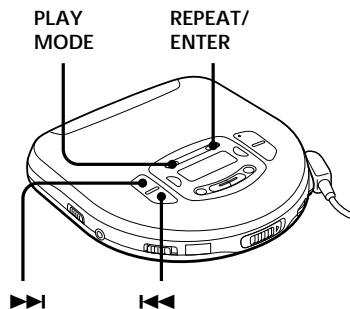

To repeat all the tracks

Press REPEAT/ENTER during play. The "REPEAT" indication appears.

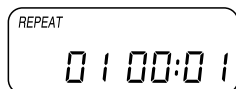

To cancel repeat play, press REPEAT/ENTER again.

To repeat a single track

1 Press REPEAT/ENTER while the track you want to repeat is playing. The "REPEAT" indication appears.



2 Press PLAY MODE repeatedly until "1" appears.

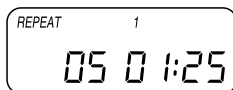

To repeat another track, press ◀◀ or ▶▶.

To cancel repeat play, press REPEAT/ENTER again.

Playing only the tracks you want (INTRO PGM Play)

You can choose and play your favorite tracks by scanning through the beginning of each track in a audio CD.

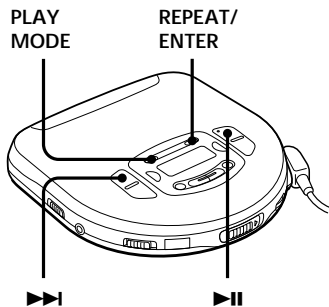

To finish programming before going through the whole audio CD, press ▶▶. The selected tracks will be played.

To cancel INTRO PGM play, press PLAY MODE repeatedly until the play mode indication disappears from the display.

- 1 During play, press PLAY MODE repeatedly until "INTRO PGM" flashes.

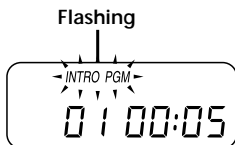

- 2 Press ▶▶ to start scanning. The player plays about the first 15 seconds of each track and "INTRO PGM" flashes faster.
- 3 Press REPEAT/ENTER while the track you want is playing. To skip the track, press ▶▶ or just wait for the next track.

After you have gone through the audio CD, "INTRO PGM" stops flashing and the tracks you have chosen play automatically.

Playing tracks in random order (Shuffle Play)

You can play the tracks in a audio CD in random order.

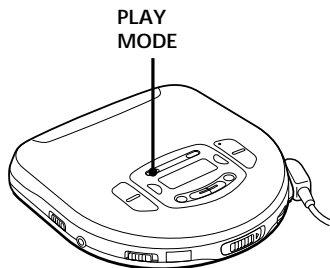

During play, press PLAY MODE repeatedly until "SHUFFLE" appears. The tracks play in random order.

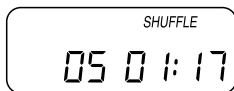

To cancel shuffle play, press PLAY MODE repeatedly until the play mode indication disappears from the display.

Notes

- During shuffle play, you cannot return to previous tracks by pressing ◀◀.
- If you locate a specific track using the number button on the wireless remote control, shuffle play is canceled.

Playing tracks in the order you want (RMS Play)

You can program up to 22 tracks to play in any order you choose.

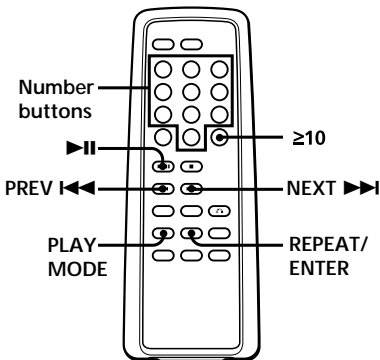

- 1 During play, press PLAY MODE repeatedly until "RMS*" flashes.

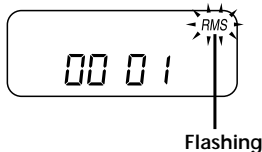

*RMS = Random Music Sensor

- 2 Press the number buttons (wireless remote control only), or ◀◀ or ▶▶ and REPEAT/ENTER to choose a track. The track number and the playing order appear.

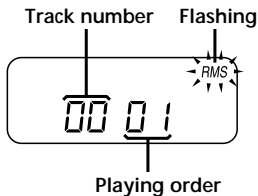

Continue to the next page →

To select an item number 10 or more, press ≥ 10 first, then the corresponding number buttons.
Examples:

For 12: ≥ 10 , then 1 and 2

For 24: ≥ 10 , then 2 and 4

For 135: ≥ 10 , ≥ 10 , then 1, 3 and 5

3 Repeat step 2 to program the remaining tracks.

4 Press **▶||**.
“RMS” stops flashing and the tracks you have chosen play in the order you specified.

To cancel RMS play, press **PLAY MODE** until “RMS” disappears.

To check the program

During programming:

Press **REPEAT/ENTER** before step 4.

During RMS play:

Press **PLAY MODE** repeatedly until “RMS” flashes, then press **REPEAT/ENTER**.

Each time you press **REPEAT/ENTER**, the track number and the playing order appear in the order you specified.

Note

- If you program another track after the 22nd track, the first track programed is cleared and the new track is programed instead.

Using other functions

To prevent sound from skipping (ESP)

The ESP (Electronic Shock Protection) function prevents the sound from skipping by using a buffer memory that stores music data for about 10 seconds. Use this function when listening in a car or during a walk.

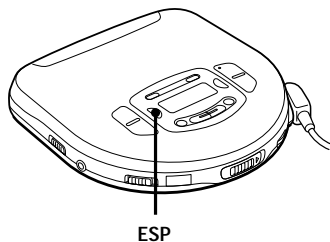

Press **ESP**.

The ESP indication appears.

To release the ESP function, press **ESP** again.

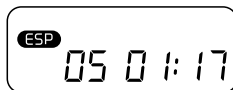

Notes

- Playing may stop when the player gets a strong shock even with the ESP function on.
- You may hear a noise or sound skip when:
 - listening to a dirty or scratched audio CD,
 - listening to an audio test CD or,
 - the player receives continuous shock.
- Sound may be intermittent for a while if you press **ESP** during play.
- While playing the **VIDEO CD**, the **ESP** function is disabled.

To enjoy more powerful bass sound (MEGA BASS Function)

You can enjoy a powerful bass-boosted sound.

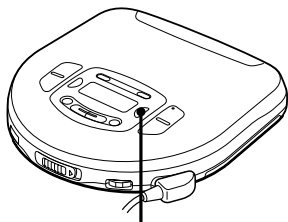

MEGA BASS

Press MEGA BASS to select "BASS ▲" or "BASS ▲▲". "BASS ▲▲" is more effective.

Note

- If the sound is distorted when emphasizing bass, turn down the volume.

To lock the buttons (HOLD Function)

You can lock your player against any accidental operations.

You can still operate the player with the remote control.

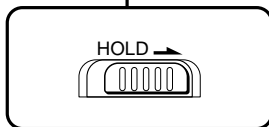
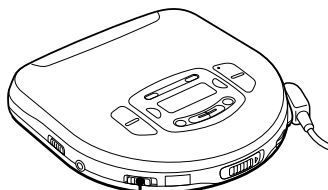

Slide HOLD in the direction of the arrow. When you press any button, "Hold" appears in the display and you cannot operate the player.

When you are using the supplied earphones with remote control, you can lock the buttons on the remote control by sliding HOLD in the direction of the arrow. You can still adjust the volume using VOL on the remote control.

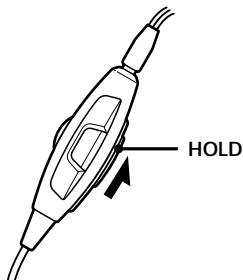

To unlock, slide HOLD back.

To resume playing from the point you stopped the audio CD (Resume function)

Normally, every time you stop and play, playing starts from the beginning of the audio CD. The resume play function, however, let you listen to from the point where you last turned off the player.

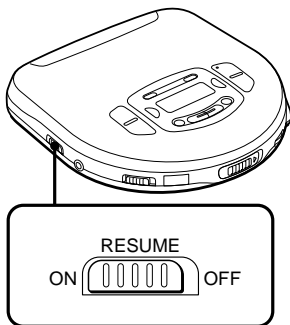

Set RESUME to ON.

To cancel resume play, set RESUME to OFF.

Notes

- Even if RESUME is set to ON, playing starts from the beginning when you open the lid.
- The resume point may be inaccurate by about 30 seconds.

To turn off the beep

You can turn off the beep that sounds as you operate your player.

Disconnect the power source (AC power adaptor or alkaline batteries). While you press and hold down ■, connect the power source again. To make the beep sound again, disconnect the power source, and then connect it without pressing ■.

Note

- While playing the VIDEO CD, the beep does not sound.

Connecting to other stereo equipment

You can play back a CD through other stereo equipment or record a CD on a cassette tape or video tape. Refer to the instruction manual supplied with other equipment for details.

Before making connections, turn off each equipment.

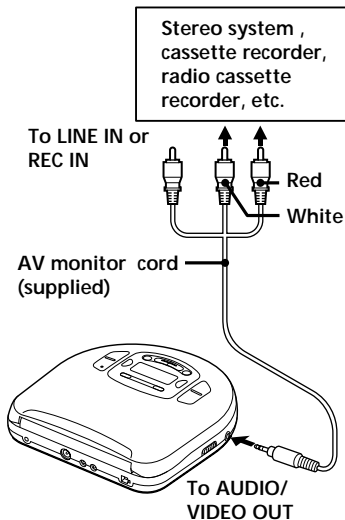

Notes

- Before you play the CD, turn down the volume of the connected equipment so as not to damage the connected speakers.
- The beep sound is not output from the AUDIO/VIDEO OUT jack.
- You cannot adjust the volume of output signals from the AUDIO/VIDEO OUT jack on this player.
- When you record a CD on a cassette tape using a tape recorder that has the blank search function, release the ESP function. If the ESP function is on, the blank search function does not work.

► Power Source

Using alkaline batteries

- 1 Open the lid of the battery compartment.

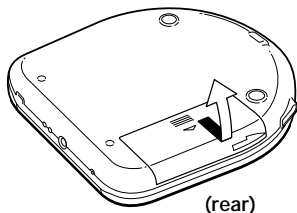

- 2 Insert two LR6 (size AA) alkaline batteries by matching the ⊕ and ⊖ to the diagram inside the battery compartment and close the lid.

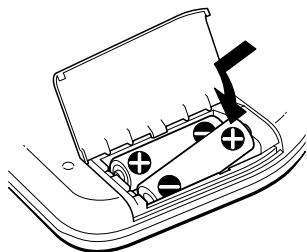

To take out the batteries

Pull out the ⊕ side of the battery as shown.

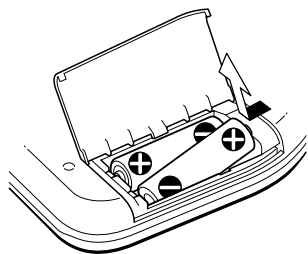

Using the battery case

You can use the unit for longer time by using the battery case, in addition to the batteries in the battery compartment of the unit. Batteries in the battery case and the batteries in the battery compartment are consumed together.

- 1 Hook the battery case onto the unit and fasten the screw.

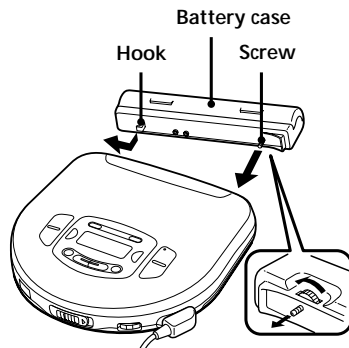

- 2 Open the lid of the battery case.

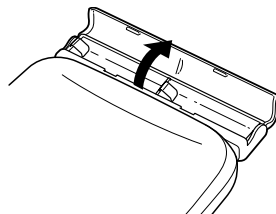

- 3 Insert two LR6 (size AA) alkaline batteries by matching the ⊕ and ⊖ to the diagram inside the battery case and close the lid.

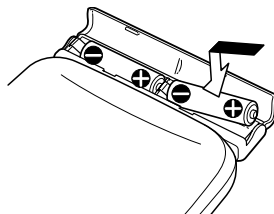

When to replace the dry batteries

If the batteries are used up, "Lo batt" appears in the display. Replace all the batteries with new ones.

Battery life

When you use the player on a flat and stable place.

(Approx. hours)

	Audio CD ESP function		VIDEO CD
	On	Off	
Two alkaline batteries	5.5	7	0.8
Two alkaline batteries + Battery case (two alkaline batteries)	11	14	2

Notes

To prevent the battery leakage or bursting, keep the following notes:

- Do not charge the dry batteries.
- Do not mix new batteries with old ones.
- Do not use different types of batteries together.
- Do not use manganese batteries for this unit.
- When the batteries are not to be used for a long time, remove them.

► **Additional Information**

Precautions

On safety

- As the laser beam used in this player is harmful to the eyes, do not attempt to disassemble the casing.
- Do not put any foreign objects in the DC IN 6 V (external power input) jack.
- Should any solid objects or liquid fall into the unit, unplug it and have it checked by qualified personnel before operating it any further.

On power sources

- When you are not using the player for a long time, disconnect all power sources from the unit.
- The nameplate indicating operating voltage, etc. is located on the bottom.

On the AC power adaptor

- Use only the supplied AC power adaptor.

Polarity of the plug



- To unplug the AC power adaptor from the wall outlet, grasp the adaptor itself, do not pull its cord.

On dry batteries

- Do not throw the batteries into fire.
- Do not carry the batteries with coins or other metallic objects. It can generate heat if the positive and negative terminals of the batteries are accidentally contacted with a metallic object.

On the player

- Keep the lens on the player clean and do not touch it. If you do so, the lens may be damaged and the player will not operate properly.
- Do not put any heavy object on top of the player. The player and the CD may be damaged.
- Do not leave the player in a location near heat sources, or in a place subject to direct sunlight, excessive dust or sand, moisture, rain, mechanical shock, unlevelled surface, or in a car with its windows closed.
- If the player causes interference to the radio reception, turn off the player or move it away from the radio.
- Do not wrap the player in a cloth or blanket during use as it may cause malfunction or serious accidents.

On headphones/earphones

Road safety

Do not use headphones/earphones while driving, cycling, or operating any motorized vehicle. It may create a traffic hazard and is illegal in some areas. It can also be potentially dangerous to play your headsets at high volume while walking, especially at pedestrian crossings. You should exercise extreme caution or discontinue use in potentially hazardous situations.

Preventing hearing damage

Avoid using headphones/earphones at high volume. Hearing experts advise against continuous, loud and extended play. If you experience a ringing in your ears, reduce volume or discontinue use.

Caring for others

Keep the volume at a moderate level. This will allow you to hear outside sounds and to be considerate to the people around you.

Troubleshooting

Should any problem persist after you have checked the following, consult your nearest Sony dealer.

The disc does not play or "no disc" appears on the display though a CD is placed in the player.

- The CD is dirty or defective.
- Insert the CD with the label side up.
- Moisture condensation has occurred.
Leave the player unused for several hours until the moisture evaporates.
- The lens is dirty. Clean the lens.
- Close the lid of the player and the battery compartment firmly.
- Make sure the dry batteries are inserted correctly.
- Connect the AC power adaptor to a wall outlet securely.

No sound, or noise is heard.

- Plugs are not connected firmly.
- Plugs are dirty. Clean the plugs with a dry soft cloth periodically.

Sound seems to lose the stereo effect and becomes monaural.

- Press ST/L/R on the wireless remote control repeatedly until "ST" appears on the TV screen. (Only when playing the VIDEO CD)

"Hold" appears on the display when you press a button.

- The buttons are locked. Slide HOLD back.

The player does not accept your operation.

- The operation procedure may differ depending on the VIDEO CD. (See pages 11 and 15.)

No picture appears on the TV screen.

- Make sure the TV is turned on.
- Make sure you select the correct video input on the TV.
- Connect the video connecting cord correctly.
- An audio CD is being played.
- Close the lid of the player and the battery compartment firmly.
- Make sure the following mark is on the VIDEO CD.



- You may not play back some illegally duplicated VIDEO CDs even though they have the above mark printed.
In this case, consult the shops where you bought the VIDEO CDs.

Picture is distorted.

- When you pause or use search, picture is distorted. This is not a malfunction.
- The VIDEO CD is defective. Replace the VIDEO CD.
- The VIDEO CD is dirty. Replace the VIDEO CD.
- The color system you have selected for this player is not the same as the one the VIDEO CD is recorded with.

Picture is blurred or becomes monochrome.

- Check the setting of the NTSC/PAL switch.

Picture is distorted, noise is heard or playback stops.

- Move a portable telephone, transceiver, etc. away from the player.

The wireless remote control does not function.

- ➔ If 5 minutes have already passed after you turned off the player by pressing ■, you cannot turn on the power using the wireless remote control. In this case, press ►|| on the player to turn on the power. Once the player is turned on, you can operate the player with the wireless remote control. (Only when using the player on alkaline batteries)
- ➔ Remove any obstacles between the wireless remote control and the remote sensor.
- ➔ Replace all the batteries in the wireless remote control with new ones if they are weak.

"Lo dc l n" or "Hi dc l n" appears in the display, and the player does not operate.

- ➔ Use the supplied AC power adaptor.

Maintenance

To clean the casing

Use a soft cloth slightly moistened in water or a mild detergent solution. Do not use alcohol, benzine or thinner.

Notes on handling CDs

- To keep the CD clean, handle it by its edge. Do not touch the surface.
- Do not stick paper or tape onto the CD.
- Do not expose the CD to direct sunlight or heat sources such as hot air ducts. Do not leave the CD in a car parked under direct sunlight.

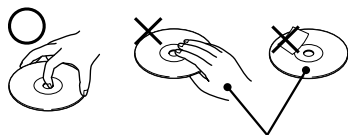

Not these ways

Specifications

System

Compact disc digital audio/video system

Laser diode properties

Material: GaAlAs

Wavelength: $\lambda=780$ nm

Emission duration: Continuous

Laser output power: Less than 44.6 μ W*

* This output is the value measured at a distance of 200 mm from the objective lens surface on the optical pick-up block with 7 mm aperture.

Error correction

Sony Super Strategy Cross Interleave Reed Solomon Code

D-A conversion

1-bit

Channel number

2 channels

Frequency response

20 - 20,000 Hz ± 1 dB (measured by EIAJ CP-307)

Output (at 6 V input level)

Headphones (stereo minijack)

10 mW + 10 mW at 16 ohms

Line output (stereo minijack)

Output level 0.7 V rms at 47 kilohms

Recommended load impedance over 10 kilohms

Video output (minijack)

Output level 1Vp-p at 75 ohms

Recommended load impedance 75 ohms

General

Power requirements

Player:

- Two LR6 (size AA) batteries: 3 V DC
- AC power adaptor (DC IN 6 V jack):
120 V, 60 Hz
220 - 230 V, 50/60 Hz
100 - 240 V, 50/60 Hz
(AC power required differs depending on where you purchased the player.)

Wireless remote control:

- Two R6 (size AA) batteries: 3 V DC

Dimensions (w/h/d) (incl. projecting parts and controls)

Approx. 132.0 x 30.8 x 135.6 mm
(5 $\frac{1}{4}$ x 1 $\frac{1}{4}$ x 5 $\frac{3}{8}$ in.)

Mass (excl. rechargeable batteries)

Approx. 306 g (10.8 oz)

Approx. 418 g (14.8 oz) (incl. alkaline batteries and a CD)

Operating temperature

5°C - 35°C (41°F - 95°F)

Supplied accessories

AC power adaptor (1)

AV monitor cord (1)

Wireless remote control (1)

Earphones with remote control (1)

Battery case (1)

Design and specifications are subject to change without notice.

Recommended accessories

Headphones MDR-E868/MDR-35
GLASSTRON PLM-A55

Your dealer may not handle some of the above listed accessories. Check with the dealer for detailed information about the accessories in your country.

Parts identification

For explanation of the use of each part, see pages indicated in parentheses.

Main unit

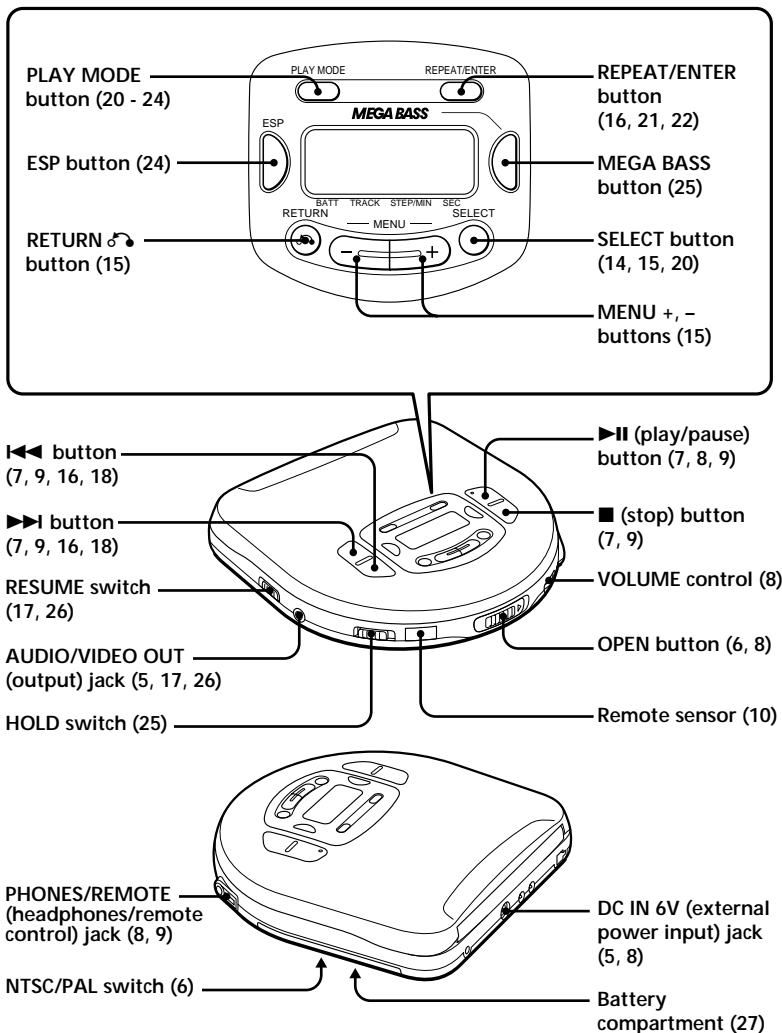

Continue to the next page →

Wireless remote control

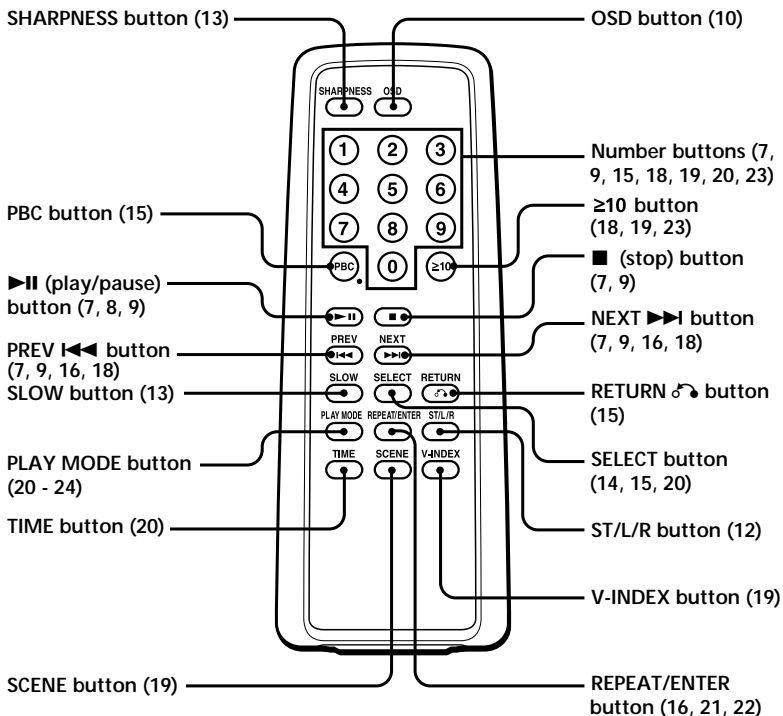

Earphones with remote control

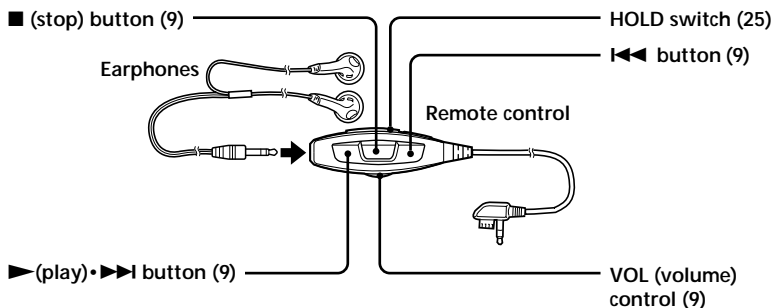

Glossary

Index

Markings assigned for particular points to divide a track or a whole disc. By using indexes you can easily find particular points you want. There are two types of index—one is for audio CDs and the other is for VIDEO CDs. This player only conforms to the latter type of index, called “Video Index.”

PBC Playback

Playback using the menus recorded on VIDEO CDs with PBC functions. You can enjoy simple interactive operations using the PBC Playback.

Playback Control (PBC)

Signals encoded on VIDEO CDs (Version 2.0) to control playback. By using menus recorded on VIDEO CDs with PBC functions, you can enjoy playing simple interactive software, software with search functions, and so on. When you insert a VIDEO CD with PBC functions on this player, “PBC” appears on the display.

Scene

Markings differentiating still pictures, moving picture or menus recorded on VIDEO CDs with PBC functions. Each scene is assigned with a number, called “Scene Number.”

Track

Markings differentiating pictures or songs recorded on VIDEO CDs or audio CDs. Each track is assigned with a number, called “Track Number.”

VIDEO CD

A compact disc containing moving pictures. Picture data is compressed to 1/120th of the original data in the MPEG 1 format (one of the worldwide standards of digital compression technologies) and recorded on a disc. A 12 cm VIDEO CD can reproduce up to 74 minute's length of moving pictures. Audio data is also compressed so that a VIDEO CD can contain 6 times as much audio data as an audio CD. There are 2 versions of VIDEO CDs.

- Version 1.1: You can play only moving pictures and sounds.
- Version 2.0: You can play still pictures and enjoy PBC functions.

Free Manuals Download Website

<http://myh66.com>

<http://usermanuals.us>

<http://www.somanuals.com>

<http://www.4manuals.cc>

<http://www.manual-lib.com>

<http://www.404manual.com>

<http://www.luxmanual.com>

<http://aubethermostatmanual.com>

Golf course search by state

<http://golfingnear.com>

Email search by domain

<http://emailbydomain.com>

Auto manuals search

<http://auto.somanuals.com>

TV manuals search

<http://tv.somanuals.com>