

SONY[®]

3-061-539-11(2)

Portable CD/DVD Player

Operating Instructions



DVP-FX1

© 2000 Sony Corporation

Download from [Www.Somanuals.com](http://www.Somanuals.com). All Manuals Search And Download.

WARNING

To prevent fire or shock hazard, do not expose the unit to rain or moisture. To avoid electrical shock, do not open the cabinet. Refer servicing to qualified personnel only.

Mains cord must only be changed at qualified service shop.

CAUTION

The use of optical instruments with this product will increase eye hazard. As the laser beam used in this CD/DVD player is harmful to eyes, do not attempt to disassemble the cabinet.

Refer servicing to qualified personnel only.

Precautions

Safety

- This unit operates on 100 - 240 V AC, 50/60 Hz. Check that the unit's operating voltage is identical with your local power supply.
- If anything falls into the cabinet, unplug the unit and have it checked by qualified personnel before operating it any further.
- The unit is not disconnected from the mains as long as it is connected to the mains outlet, even if the unit itself has been turned off.
- Unplug the unit from the wall outlet if you do not intend to use it for an extended period of time. To disconnect the cord, pull it out by the plug, never by the cord.

Installing

- Allow adequate air circulation to prevent internal heat buildup.
- Do not place the unit on surfaces (rugs, blankets, etc.) or near materials (curtains, draperies) that may block the ventilation slots.
- Do not install the unit near heat sources such as radiators or air ducts, or in a place subject to direct sunlight, excessive dust, mechanical vibration or shock.
- Do not install the unit in an inclined position. It is designed to be operated in a horizontal position only.
- Keep the unit and discs away from equipment with strong magnets, such as microwave ovens or large loudspeakers.
- Do not place heavy objects on the unit.
- If the unit is brought directly from a cold to a warm location, moisture may condense inside the CD/DVD player and cause damage to the lenses. When you first install the unit, or when you move it from a cold to a warm location, wait for about 30 minutes before operating the unit.

Welcome!

Thank you for purchasing the Sony CD/DVD Player. Before operating the unit, please read this manual thoroughly and retain it for future reference.

About this manual

Conventions

- Instructions in this manual describe the controls on the player. You can also use the controls on the remote if they have the same or similar names as those on the player.
- The icons on the right are used in this manual:





Icon	Meaning
	Indicates that you can use only the remote to do the task.
	Indicates tips and hints for making the task easier.
	Indicates that the function is for DVD VIDEOS.
	Indicates that the function is for VIDEO CDs.
	Indicates that the function is for Audio CDs.

Table of contents

- 3 About this manual
- 6 This Player Can Play the Following Discs
- 9 Precautions
- 12 Notes about the Discs

Getting Started

- 13 Unpacking
- 14 Using the LCD Screen
- 16 TV Hookups
- 19 Receiver (Amplifier) Hookups
- 22 5.1 Channel Surround Hookups
- 25 Connecting the AC Power Adaptor
- 26 Using the Rechargeable Battery Pack
- 28 Selecting the Language for the On-Screen Display

Playing discs

- 30 Playing discs
- 33 Searching for a Particular Point on a Disc
- 35 Resuming Playback from the Point Where You Stopped the Disc (Resume Play)
- 37 Using the DVD's Menu
- 39 Playing VIDEO CDs with PBC Functions (PBC Playback)
- 41 Using the Display Window

Using Various Functions with the Control Menu

- 45 Using the Control Menu Display
- 48 Control Menu Item List
- 50 Searching for a Title/Chapter/Track/Index/Scene
- 51 Checking the Playing Time and Remaining Time
- 52 Selecting a Starting Point Using the Time Code
- 53 Viewing the Disc Information
- 54 Changing the Sound
- 57 Displaying the Subtitles
- 58 Changing the Angles
- 60 Digital Cinema Sound Settings
- 63 Checking the Play Information
- 65 Locking Discs (Custom Parental Control)
- 68 Creating Your Own Program (Program Play)
- 72 Playing in Random Order (Shuffle Play)
- 73 Playing Repeatedly (Repeat Play)
- 74 Repeating a Specific Portion (A-B Repeat)

Settings and Adjustments

- 76** Using the Setup Display
- 79** Setup Display Item List
- 80** Setting the Display Language or Sound Track
(LANGUAGE SETUP)
- 83** Settings for the Display
(SCREEN SETUP)
- 85** Custom Settings
(CUSTOM SETUP)
- 91** Settings for the Sound
(AUDIO SETUP)
- 94** Preventing the Buttons from Pressed Accidentally

Additional Operations

- 95** Listening with Headphones
- 96** Watching the Picture without Connecting Cables
— LASER LINK
- 98** Watching the Picture of Other Equipment on the LCD Screen

Additional Information

- 99** Troubleshooting
- 104** Self-diagnosis Function
- 105** Specifications
- 107** Glossary
- 109** Language Code List
- 111** Index to Parts and Controls
- Back cover** Index

This Player Can Play the Following Discs

	DVD VIDEOS		VIDEO CDs		Audio CDs	
Disc logo						
Contents	Audio + Video		Audio + Video		Audio	
Disc size	12 cm	8 cm	12 cm	8 cm	12 cm	8 cm (CD single)
Play time	About 4 h (for single-sided DVD) / about 8 h (for double-sided DVD)	About 80 min. (for single-sided DVD) / about 160 min. (for double-sided DVD)	74 min.	20 min.	74 min.	20 min.

The "DVD VIDEO" logo is a trademark.

When you play an PAL disc, this player outputs the video signal in the PAL system only. In this case, if your TV uses the NTSC system, the picture becomes noisy.

Region code of DVDs you can play on this unit

Your DVD player has a region code printed on the bottom of the unit and will only play DVDs that are labeled with identical region codes.

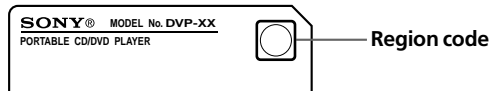

DVDs labeled  will also play on this unit.

If you try to play any other DVD, the message "Playback prohibited by area limitations." will appear on the screen. Depending on the DVD, no region code indication may be labeled even though playing the DVD is prohibited by area restrictions.

Note on playback operations of DVDs and VIDEO CDs

Some playback operations of DVDs and VIDEO CDs may be intentionally fixed by software producers. Since this player plays DVDs and VIDEO CDs according to the disc contents the software producers designed, some playback features may not be available. Also refer to the instructions supplied with the DVDs or VIDEO CDs.

Terms for discs

- **Title**
The longest section of a picture or music feature on a DVD, the movie, etc. in video software, or the name of an album in audio software.
- **Chapter**
Sections of a picture or a music feature that are smaller than titles. A title is composed of several chapters. Each chapter is assigned a chapter number enabling you to locate the chapter you want. Depending on the disc, no chapters may be recorded.
- **Track**
Sections of a picture or a music feature on a VIDEO CD or a CD. Each track is assigned a track number enabling you to locate the track you want.

DVD structure

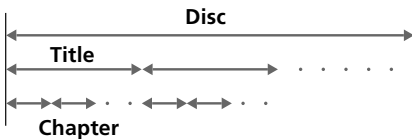

VIDEO CD or CD structure

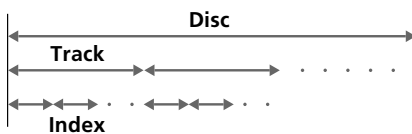

- **Index (CD) / Video Index (VIDEO CD)**
A number that divides a track into sections to easily locate the point you want on a VIDEO CD or a CD. Depending on the disc, no indexes may be recorded.
- **Scene**
On a VIDEO CD with PBC (playback control) functions, the menu screens, moving pictures and still pictures are divided into sections called "scenes." Each scene is assigned a scene number enabling you to locate the scene you want.

Note on PBC (Playback Control) (VIDEO CDs)

This player conforms to Ver. 1.1 and Ver. 2.0 of VIDEO CD standards. You can enjoy two kinds of playback according to the disc type.

Disc type	You can
VIDEO CDs without PBC functions (Ver. 1.1 discs)	Enjoy video playback (moving pictures) as well as music.
VIDEO CDs with PBC functions (Ver. 2.0 discs)	Play interactive software using menu screens displayed on the screen (PBC Playback), in addition to the video playback functions of Ver. 1.1 discs. Moreover, you can play high-resolution still pictures if they are included on the disc.

Discs that the player cannot play

The player cannot play discs other than the ones listed in the table on page 6. CD-ROMs including PHOTO CDs, data sections in CD-EXTRAS, DVD-ROMs, DVD-audio, HD (high density) layer of Super Audio CD etc., cannot be played.

Note

The player may not be able to play a CD-R if it is in poor recording condition.

This Player Can Play the Following Discs (continued)

When playing DTS*-encoded CDs, excessive noise will be heard from the analog stereo outputs. To avoid possible damage to the audio system, the consumer should take proper precautions when the analog stereo outputs of the DVD player are connected to an amplification system. To enjoy DTS Digital Surround™ playback, an external 5.1-channel DTS Digital Surround™ decoder system must be connected to the digital output of the DVD player.

This product incorporates copyright protection technology that is protected by method claims of certain U.S. patents and other intellectual property rights owned by Macrovision Corporation and other rights owners. Use of this copyright protection technology must be authorized by Macrovision Corporation, and is intended for home and other limited viewing uses only unless otherwise authorized by Macrovision Corporation. Reverse engineering or disassembly is prohibited.

* “DTS,” “DTS Digital Surround” and “DTS Digital Out” are trademarks of Digital Theater Systems, Inc.

Precautions

On safety

- Caution – The use of optical instruments with this product will increase eye hazard.
- Should any solid object or liquid fall into the cabinet, unplug the player and have it checked by qualified personnel before operating it any further.

On AC power adaptor and AC power cord

- Use only the supplied AC power adaptor. Do not use any other AC power adaptor. It may cause a malfunction.

Polarity of the plug



- If the AC power adaptor causes interference to the radio reception, move it away from the radio.
- Disconnect the DC IN 10V jack first, then disconnect from the mains, even if the player itself has been turned off.
- If you are not going to use the player for a long time, be sure to disconnect the player from the mains and/or detach the battery pack. To disconnect the AC power cord (mains lead), grasp the plug itself; never pull the cord.
- The nameplate indicating operating voltage, power consumption, etc. is located at the bottom of the AC power adaptor.
- Should the AC power cord (mains lead) need to be changed, have it done at a qualified service shop only.

On the bottom of the unit

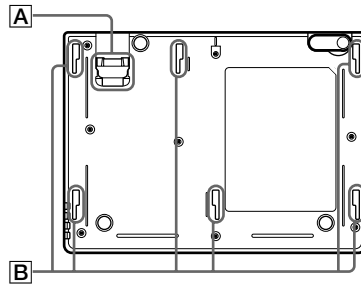

- Do not allow dust to come into contact with the terminals (A in the illustration) or holes (B in the illustration).
- Do not open the terminal covers (A in the illustration).

On rechargeable batteries

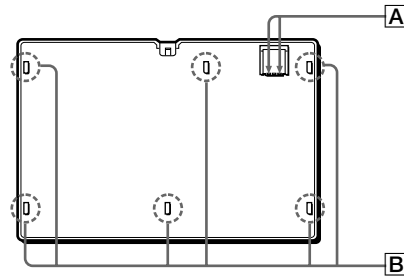

- Do not short the terminals (A in the illustration).
- Do not open the terminal covers (A in the illustration).
- Do not allow dust to come into contact with the terminals (A in the illustration) or projecting guides (B in the illustration).
- Do not expose to high temperatures (60 °C).
- The battery used in this device may present a fire or chemical burn hazard if mistreated. Do not disassemble, heat above 100 °C or incinerate.

continued

Precautions (continued)

- Danger of explosion if battery is incorrectly replaced. Replace battery with Sony NP-FX1 only. Use of another battery may present a risk of fire or explosion.
- Battery pack is suitable for use only with Sony Portable CD/DVD Player.
- Burn hazard if mistreated. Do not disassemble. Handle damaged or leaking lithium-ion battery with extreme care. If the battery is damaged, electrolyte may leak from the cells and may cause personal injury.
- There may be local restrictions on the disposal or recycling of batteries. Consult your local regulations or waste disposal provider.
- Dispose of use battery promptly.
- Keep away from children.

On placement

- Place the player in a location with adequate ventilation to prevent heat build-up in the player.
- Do not put any heavy object on top of the player. The unit and the disc may be damaged.
- Do not wrap the player in a cloth or blanket during use as it may cause malfunction or serious accidents.
- Do not leave the player in a location near heat sources, or in a place subject to direct sunlight, excessive dust or sand, moisture, rain, mechanical shock, unlevelled surface, or in a car with its windows closed.
- If the player causes interference to radio or television reception, turn off the player or move it away from the radio or television.

On operation

- If the player is brought directly from a cold to a warm location, or is placed in a very damp room, moisture may

condense on the lenses inside the player. Should this occur, the player may not operate properly. In this case, remove the disc and leave the player turned on for about half an hour until the moisture evaporates.

- While operating, do not move, shake, or otherwise allow any shock to the player. It may cause a malfunction.
- Use this player in a stable, horizontal position where it is not subject to vibration.
- Do not touch the disc if it is still spinning when you open the lid. Doing so may cause injury.

On adjusting volume

Do not turn up the volume while listening to a section with very low level inputs or no audio signals. If you do, the speakers may be damaged when a peak level section is played.

Turn the volume down before you start playback.

Road safety

Do not use headphones while driving, cycling, or operating any motorized vehicle. It may create a traffic hazard and is illegal in some areas. It can also be potentially dangerous to play your headsets at high volume while walking, especially at pedestrian crossing. You should exercise extreme caution or discontinue use in potentially hazardous situations.

On headphones

Preventing hearing damage

Avoid using headphones at high volume. Hearing experts advise against continuous, loud and extended play. If you experience a ringing in your ears, reduce volume or discontinue use.

Caring for others

Keep the volume at a moderate level. This will allow you to hear outside sounds and to be considerate to the people around you.

On cleaning

- Clean the cabinet, panel and controls with a soft cloth slightly moistened with a mild detergent solution. Do not use any type of abrasive pad, scouring powder or solvent such as alcohol or benzine.
- If the turntable does not work properly, check for dust or dirt on the turntable and clean using a soft cloth.
- Never remove the printed "Warranty void if removed." seal attached around the lens.
- If dust on the lens prevents the player from operating properly, clean the lens with a commercially available blower brush for the camera lens. Be careful not to touch the lens directly. Do not use the lens cleaning disc. If you do so, the lens may be damaged.

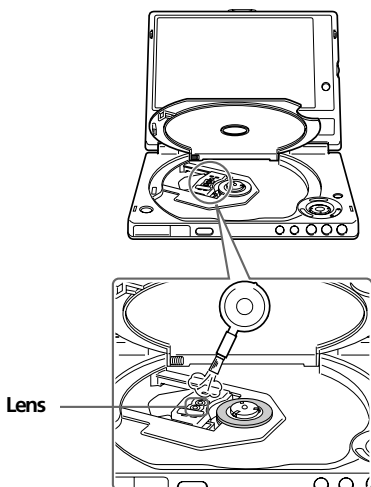

On transportation

- When you transport this player, use the original carton box and packing materials.
- Before you move this player, make sure to remove any discs from the player.

On handling the LCD screen

The LCD is manufactured using high-precision technology. You may, however, see tiny black points and/or bright points (red, blue, or green) that continuously appear on the LCD. This is a normal result of the manufacturing process and does not indicate a malfunction.

- Do not scratch the LCD or exert pressure on it. This could cause malfunction.
- Using the player in low temperature conditions may produce a residual image on the screen. This is not a malfunction. When the player returns to normal temperature, the screen returns to normal.
- A residual image may appear on the screen if the same image is displayed for a lengthy period of time. The residual image disappears in a while. You can use a screen saver to prevent residual images.
- The screen becomes warm during operation. This is normal and does not indicate a malfunction.

If you have any questions or problems concerning your player, please consult your nearest Sony dealer.

Precautions (continued)

IMPORTANT NOTICE

Caution: The enclosed DVD player is capable of holding a still video image or on-screen display image on your television screen indefinitely. If you leave the still video image or on-screen display image displayed on your TV for an extended period of time you risk permanent damage to your television screen. Projection televisions are especially susceptible to this.

Notes about the Discs

On handling discs

- To keep the disc clean, handle the disc by its edge. Do not touch the surface.
- Do not stick paper or tape on the disc. If there is glue (or a similar substance) on the disc, remove the glue completely before using the disc.

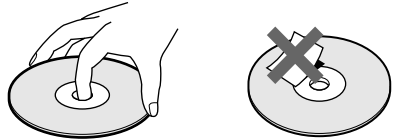

- Do not expose the disc to direct sunlight or heat sources such as hot air ducts, or leave it in a car parked in direct sunlight as the temperature may rise considerably inside the car.
- After playing, store the disc in its case.

On cleaning

- Before playing, clean the disc with a cleaning cloth. Wipe the disc from the center out.



- Do not use solvents such as benzene, thinner, commercially available cleaners or anti-static spray intended for vinyl LPs.

On novelty discs

- Do not use irregularly shaped CDs such as heart- or star-shaped CDs as they may cause the player to malfunction.

Unpacking

Check that you have the following items:

- Audio/video connecting cord (1)
- AC power adaptor AC-FX1 (1)
- AC power cord (1)
- Remote commander (remote) RMT-D114A (1)
- R6 (Size AA) batteries (2)
- Battery pack NP-FX1 (1)

Inserting batteries into the remote

You can control the player using the supplied remote. Insert two R6 (Size AA) batteries by matching the + and – ends on the batteries to the markings inside the compartment. When using the remote, point it at the remote sensor  on the player.

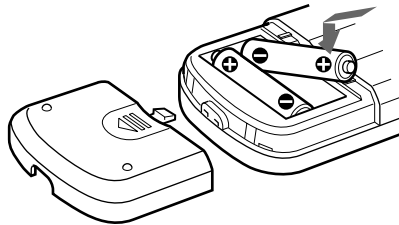

Notes

- Do not leave the remote in an extremely hot or humid place.
- Do not drop any foreign object into the remote casing, particularly when replacing the batteries.
- Do not expose the remote sensor to direct sunlight or lighting apparatuses. Doing so may cause a malfunction.
- If you do not use the remote for an extended period of time, remove the batteries to avoid possible damage from battery leakage and corrosion.

Using the LCD Screen

By using the LCD screen, you can watch discs recorded both in the PAL color system and in the NTSC color system.

Opening the LCD panel

- 1 When using the AC power adaptor, pull out the stabilizer tab on the bottom of the player to prevent the player from tipping over.

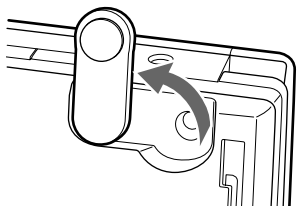

- 2 Press PUSH OPEN and lift open the LCD panel.

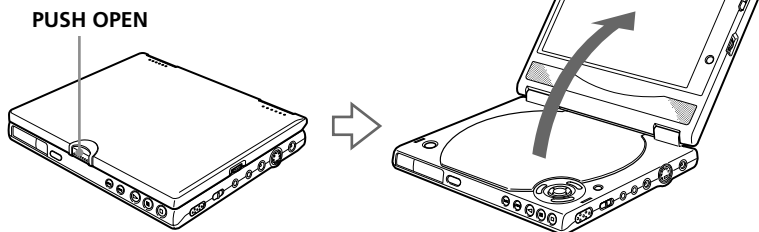

When using the LCD screen, you do not have to connect the TV or the receiver (amplifier). See "Connecting the AC power adaptor" on page 25 or "Using the rechargeable battery pack" on page 26.

Adjusting the brightness of the LCD screen

If necessary, adjust the brightness of the LCD screen using the BRIGHT dial.

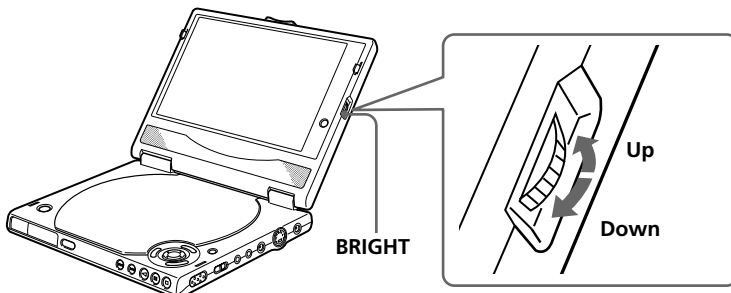

Selecting the display mode

You can select the display mode according to the aspect ratio (4:3 or 16:9) of the playback/input picture.

Each time you press DISPLAY MODE, the mode changes as follows:

→ Wide → Full → Cinema → Normal → Off

Selecting the display mode according to the aspect ratio of the picture

The aspect ratio of the picture recorded on the DVD is printed on the jacket of the DVD (4:3 , 16:9 LB , LB).

- Wide mode 4:3

Enlarge the 4:3 picture, while the upper and lower parts of the picture are condensed to fit the 16:9 screen.

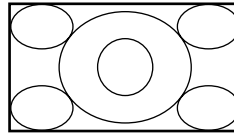

- Full mode 16:9 LB

Displays the 16:9 picture to fit the screen.

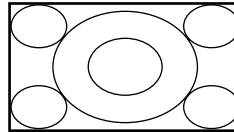

- Cinema mode LB

Enlarge the 4:3 letter box picture and cut off the black bands to fit the 16:9 screen.

Depending on the DVD, the edges of the picture may be distorted.

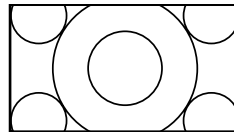

- Normal mode 4:3 16:9 LB LB

Displays the original picture as it is. The 4:3 picture will have black bands on both sides.

The 16:9/4:3 letter box picture will have black bands on all sides.

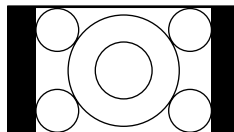

Adjusting the volume

When you listen to the sound through the built-in speakers, adjust the volume by turning the VOL dial.

You can also adjust the volume of external headphones with the VOL dial.

TV Hookups

This connection is for listening to the sound through TV speakers (L: left, R: right). Refer to the instructions supplied with the component to be connected.

Be sure to set the LINE SELECT switch to OUT.



You can enjoy surround sound using your TV's built-in speakers

You can use 3D sound imaging to create virtual rear speakers from the sound of built-in TV speakers without using actual rear speakers (VES TV: Virtual Enhanced Surround TV). For details, see page 60.

Required cords

Audio/Video connecting cord (supplied) (1)

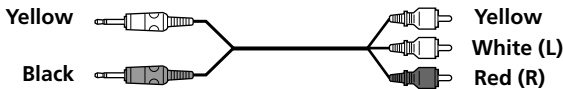

S video cord (not supplied) (1)



When connecting the cords, be sure to match the color-coded cord to the appropriate jacks on the components: Yellow (video) to Yellow, Red (right) to Red and White (left) to White. Connect the Black jack of the audio/video connecting cord to AUDIO OUT (White) on the player. Be sure to make connections firmly to avoid hum and noise.

If your TV has an S video input connector, connect the component via the S VIDEO OUT connector using an S video cord (not supplied) instead of the video connecting cord. You will get a better picture.

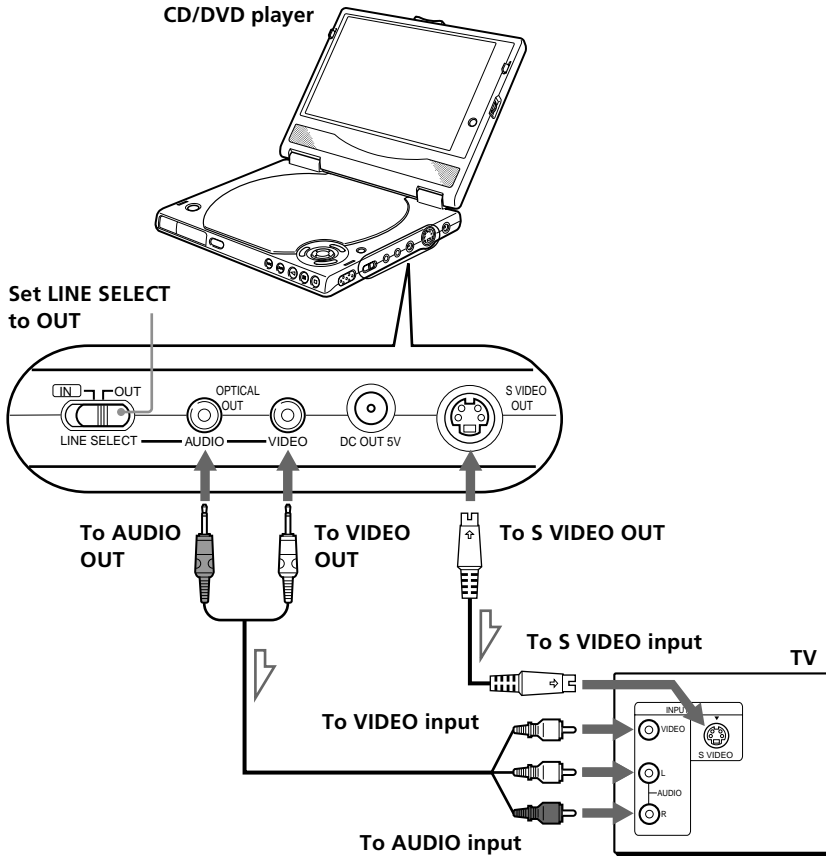

 : Signal flow

For DVP-FX1

- To turn off the LCD screen:
press the DISPLAY MODE button on the player repeatedly.
- To adjust the volume of the built-in speakers:
turn the VOL dial on the player.

continued

TV Hookups (continued)

Notes

- Refer to the instructions supplied with the component to be connected.
- Do not connect this player to a video deck. If you do, noise may appear in the picture.

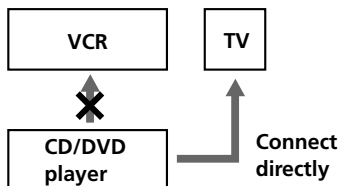

Setups for the player

Some setup adjustments are necessary for the player depending on the TV or other components to be connected.

Use the setup display to change the various settings.

For details on using the setup display, see page 76.

- **To connect the player to a wide-screen TV**

In the setup display, set "TV TYPE" in "SCREEN SETUP" to "16:9" (default setting). For details, see page 83.

- **To connect the player to a normal TV**

In the setup display, set "TV TYPE" in "SCREEN SETUP" to "4:3 LETTER BOX" or "4:3 PAN SCAN." For details, see page 83.

When you play a disc recorded in the PAL color system, the player outputs the video signal or the setup display etc. in the PAL color system and the picture may not appear on NTSC color system televisions. In this case, open the disc tray and remove the disc.

Receiver (Amplifier) Hookups

This connection is for listening to the sound through speakers connected to a receiver without a built-in DTS, Dolby* Digital or MPEG decoder. Refer as well to the instructions supplied with the component to be connected.

Be sure to set the LINE SELECT switch to OUT.

💡 You can enjoy surround sounds even if you connect front speakers only

You can use 3D sound imaging to create virtual rear speakers from the sound of the front speakers (L, R) without using actual rear speakers (VES:Virtual Enhanced Surround). For details, see page 60.

* Manufactured under license from Dolby Laboratories.

"Dolby," "Pro Logic" and the double-D symbol are trademarks of Dolby Laboratories.

Confidential unpublished works. ©1992-1997 Dolby Laboratories. All rights reserved.

Required cords

Audio/Video connecting cord (supplied) (1)

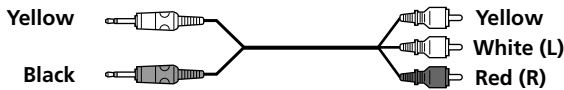

S video cord (not supplied) (1)



When connecting the cords, be sure to match the color-coded cord to the appropriate jacks on the components: Red (right) to Red and White (left) to White. Connect the Black jack of the audio/video connecting cord to AUDIO OUT (White) on the player. Be sure to make connections firmly to avoid hum and noise.

If you have a digital component such as a receiver (amplifier) with a digital connector, DAT or MD, connect the component via the OPTICAL OUT connector using an optical digital connecting cord (not supplied).

Optical digital connecting cord (not supplied) (1)

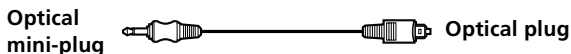

continued

Receiver (Amplifier) Hookups (continued)

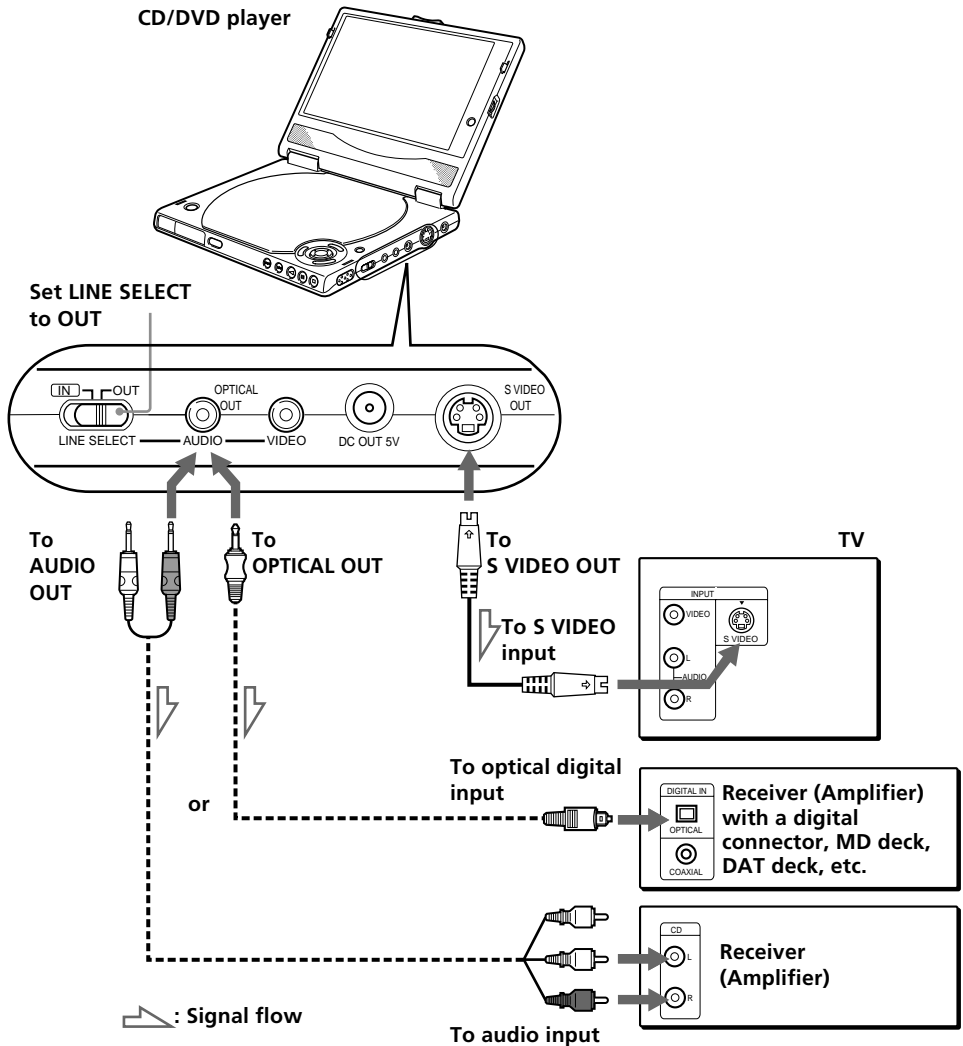

Note

You cannot enjoy a picture with an S video signal if your TV does not conform to the S video signal. When your TV does not have an S VIDEO input, connect the component via the VIDEO INPUT connector using the video connecting cord (not supplied) instead of the S video cord. For details, see page 17. Refer to the instructions supplied with your TV.

Setups for the optical digital connection

- To listen to the sound through speakers connected to a receiver (amplifier) which has a digital connector and lacks a built-in DTS, Dolby Digital or MPEG decoder, or to output the sound to a digital component such as a DAT or MD deck

Set the "AUDIO SETUP" items in the setup display (page 91) as shown in the illustration below. These are the default settings.

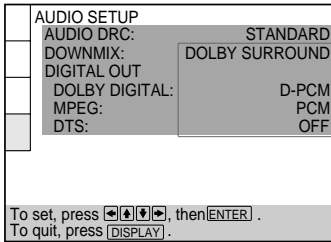

Set the items as shown

🔊 If you have a digital component with a built-in DTS, Dolby Digital or MPEG decoder

You can enjoy multi-channel surround sound by connecting the component via the OPTICAL OUT connector using an optical digital connecting cord (not supplied). For details on hookups and settings, see page 22.

Notes

When you have made the connections using an optical digital connecting cord, do not set "DOLBY DIGITAL" to "DOLBY DIGITAL," "MPEG" to "MPEG" and "DTS" to "ON" in "DIGITAL OUT." If you do, a loud noise will suddenly come out from the speakers, affecting your ears or causing the speakers to be damaged.

- When you have made the connections using an optical digital connecting cord, set "VES" to "OFF" in the Control Menu display (page 60). Otherwise, the player will not output the following signals from the OPTICAL OUT connector.
 - Dolby Digital signals (when you select "DIGITAL OUT" in "AUDIO SETUP" and set "DOLBY DIGITAL" to "D-PCM")
 - MPEG audio
- When you have made the connections using an optical digital connecting cord and output the signals which do not reproduce the Dolby Surround (Pro Logic) effect, set "DOWNMIX" to "NORMAL" in "AUDIO SETUP" in the setup display.
- You cannot make digital audio recordings of discs recorded in multi-channel surround format directly using an MD deck or DAT deck.

5.1 Channel Surround Hookups

With DVDs which contain DTS, Dolby Digital or MPEG audio sound, you can enjoy the surround sound while producing the effect of being in a movie theater or a concert hall using a digital component with a built-in DTS, Dolby Digital or MPEG decoder (not supplied). The player outputs the surround sound signals from the OPTICAL OUT connector.

Using a receiver (amplifier) having the OPTICAL OUT connector and 6 speakers, you can enjoy even greater real audio presence in the comfort of your own home.

Be sure to set the LINE SELECT switch to OUT.

Note

When a DVD has a sound track with 7.1 channels recorded in MPEG audio format, the output audio signals are mixed down to 5.1 channels.

Required cords

Optical digital connecting cord* (not supplied) (1)

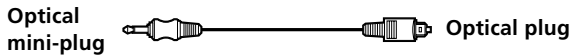

S video cord (not supplied) (1)



* Connect the component via the OPTICAL OUT connector using an optical digital connecting cord (not supplied). See the figure on the next page.

Notes

- Do not connect the power cord to an AC outlet before completing all connections.
- Refer to the instructions supplied with the component to be connected.
- The cord connectors should be fully inserted into the jacks. A loose connection may cause hum and noise.

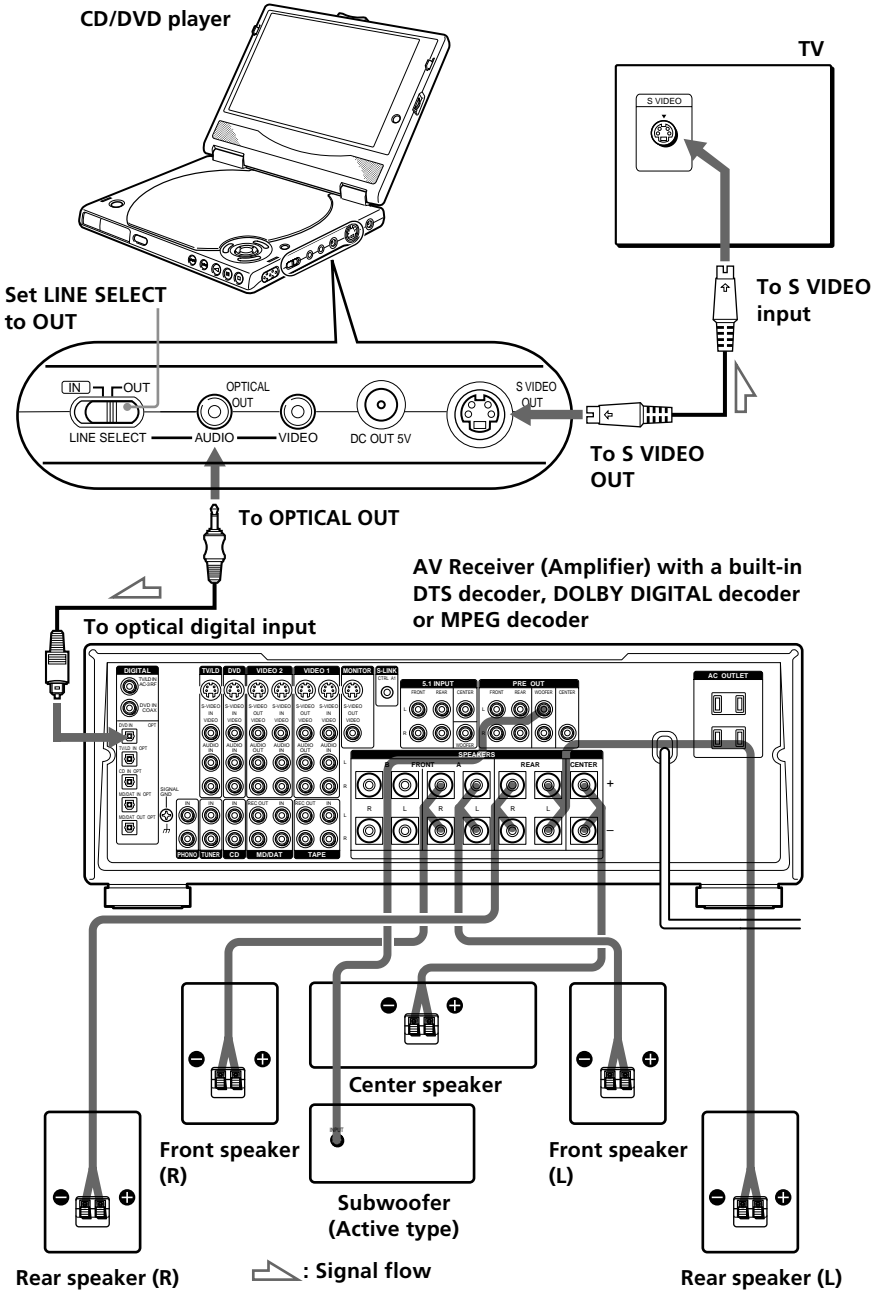

continued

5.1 Channel Surround Hookups (continued)

Setups for the player

Some setup adjustments are necessary for the player depending on the components to be connected.

Use the setup display to change the various settings.

For details on using the setup display, see page 76.

- **When you connect an audio component with a built-in Dolby Digital decoder **A****
Select "DOLBY DIGITAL" under "DIGITAL OUT" in the "AUDIO SETUP" display and set "DOLBY DIGITAL" to "DOLBY DIGITAL." (page 92)
- **When you connect an audio component with a built-in MPEG decoder **B****
Select "MPEG" under "DIGITAL OUT" in the "AUDIO SETUP" display and set "MPEG" to "MPEG." (page 93)
- **When you connect an audio component with a built-in DTS decoder **C****
Select "DTS" under "DIGITAL OUT" in the "AUDIO SETUP" display and set "DTS" to "ON." (page 93)

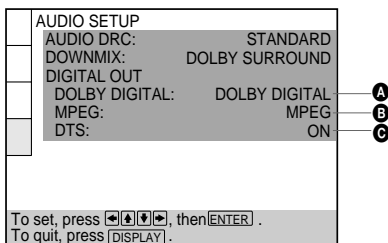

Notes

- **When you do not connect an audio component with a built-in Dolby Digital decoder, do not set "DOLBY DIGITAL" to "DOLBY DIGITAL."**
- **When you do not connect an audio component with a built-in MPEG decoder, do not set "MPEG" to "MPEG."**
- **When you do not connect an audio component with a built-in DTS decoder, do not set "DTS" to "ON."**

Connecting the AC Power Adaptor

- 1 Connect the supplied AC power cord to the AC power adaptor.
- 2 Connect the AC power adaptor to the player and then plug the cord into the AC outlet.

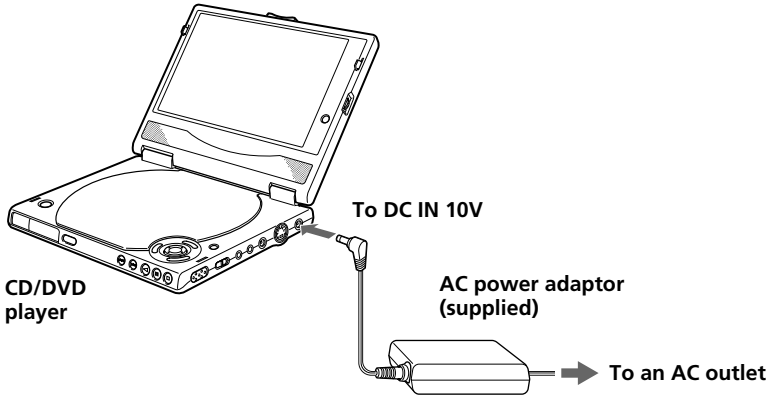

You can attach a battery pack

See "Using the rechargeable battery pack" on the next page.

Note

When you disconnect the AC power cord, be sure to stop playback. Disconnecting the AC power cord during playback may cause a malfunction.

Using the Rechargeable Battery Pack

You can use the NP-FX1 rechargeable battery pack to enjoy the player when an AC outlet is not available.

Battery life*

LCD screen	Playing time of		
	DVD VIDEO	VIDEO CD	AUDIO CD
Off	8.0	8.0	8.0
On	4.5	4.5	4.5

- * Approximate hours when played continuously at room temperature (20°C) while:
- using the power saving function (page 90)
 - using the headphones
 - the brightness of the LCD screen is set to the lowest level (page 14)

Attaching the battery pack

- 1 Fit the hooks of the battery pack to the holes on the bottom of the player, as shown below.

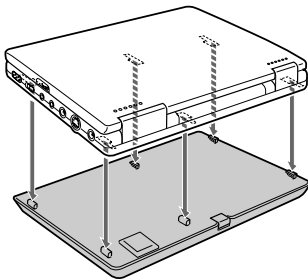

- 2 Slide the player forward in the direction of the arrow until it clicks.

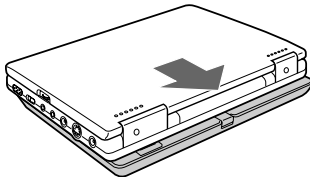

To prevent the buttons from being pressed accidentally

Turn the power off while attaching the battery pack.

Note

Do not touch the terminals on the unit and battery. Doing so may cause a malfunction.

Detaching the battery pack

Unlock the battery pack and slide the player.
Be careful not to drop the battery pack.

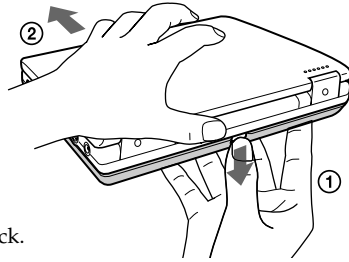

Note

Do not detach the battery pack during playback.

Charging the battery pack

After attaching the battery pack, connect the AC power adaptor, then charge the battery pack.

- 1 Attach the battery pack to the player.
- 2 Connect the AC power adaptor to the player and the plug into an AC outlet.





When charging starts, "CHG" appears on the display window.

- 3 Disconnect the AC power adaptor from the player and pull out the plug from the AC outlet after charging.

When charging is complete, "100%" appears on the display window.
This process takes approximately 8 hours.

When to charge the battery pack

You can check the remaining power of the battery on the display window.

-  Battery power is full.
↓
-  Battery power is getting low.
↓
-  Battery power is low.
↓
-  Batteries are depleted.

If "⚡" flashes, connect the AC power adaptor to start charging the battery pack.

Notes

- If you turn on the player while charging, charging is suspended until you turn off the player.
- If you press  while charging, charging is suspended and playback starts. Charging will resume when you turn off the player.
- If "⚡" flashes while charging, there may be a problem with charging. Disconnect the AC power adaptor and detach the battery pack. Then attach the battery pack and connect the AC power adaptor to start charging again.

Selecting the Language for the On-Screen Display

You can select the language for the setup display, the Control Menu display or the messages displayed on the screen. The default setting is "ENGLISH."

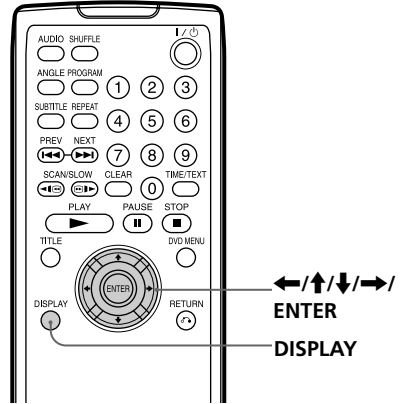
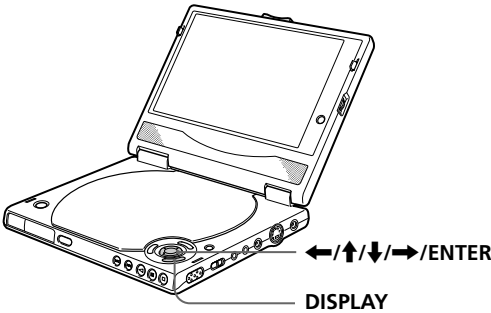

- 1 When the player is in stop mode, press DISPLAY and select "SETUP" using ↑/↓.

The on-screen menu items are different depending on whether there is a disc in the player or not.

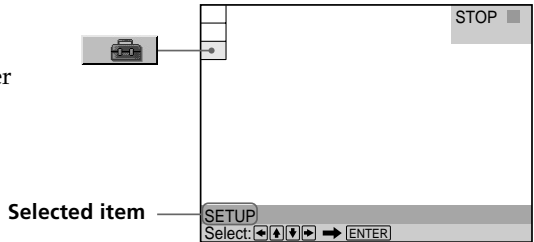

- 2 Press ENTER. The setup display appears on the screen.

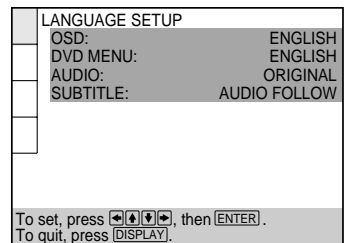

- 3** Select “LANGUAGE SETUP” using \uparrow/\downarrow , and then press ENTER.

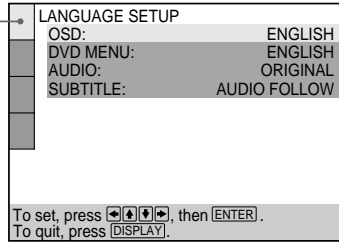

- 4** Select “OSD” using \uparrow/\downarrow , then press \rightarrow or ENTER.

The languages you can select are displayed. These languages are different depending on the player model.

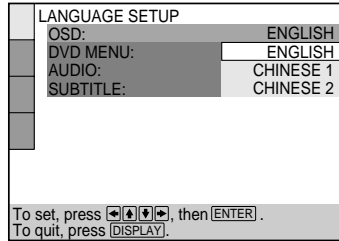

- 5** Select the desired language using \uparrow/\downarrow , then press ENTER.

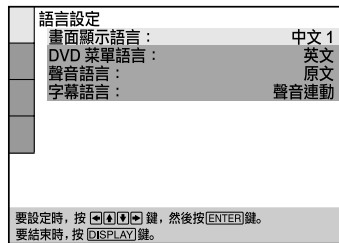

- 6** Press DISPLAY.
The setup display disappears.

- 7** Press DISPLAY repeatedly to turn off the on-screen display.

To return to the previous screen

Press \leftarrow RETURN.

To quit while making a selection

Press DISPLAY.

Note

The language you can select are the ones displayed in step 4. For details, see page 80.

Playing discs



Depending on the DVD or VIDEO CD, some operations may be different or restricted. Refer to the instructions supplied with your disc.

Be sure to set the LINE SELECT switch to OUT.

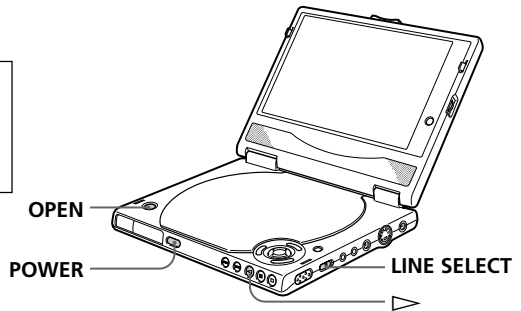

1 Press POWER to turn on the player.

The display window lights up.

When using the AC power adaptor, you can turn on the player with on the remote.

When connecting the player to a TV

Turn on the TV and select the video input so that you can view the pictures from this player.

When using a receiver (amplifier)

Turn on the receiver (amplifier) and select the appropriate position so that you can listen to the sound from this player.

2 Press OPEN to open the lid.

3 Insert a disc horizontally.

Push down the center of the disc gently with two fingers. Make sure the disc clicks into the position.

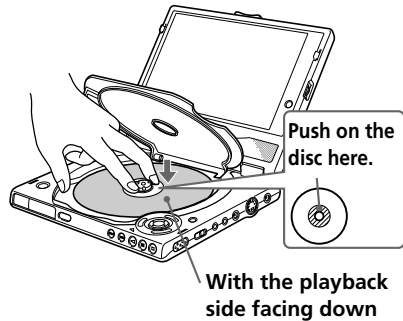

4 Close the lid, then press .

The player starts playback (continuous play). Adjust the volume on the player, the TV or the receiver (amplifier).

After following Step 4

- When playing a DVD
A DVD menu or title menu may appear on the screen (see page 37).
- When playing a VIDEO CD
A menu screen may appear on the screen depending on the VIDEO CD. You can play the disc interactively, following the instructions on the menu screen. (PBC Playback, see page 39.)

When using the battery pack

Normally you cannot use the remote to turn on the player. However, within 10 minutes after having turned off the player with the remote, you can use the remote to turn on the player.

Notes on playing DTS sound tracks on a CD

- Do not play DTS sound tracks without first connecting the player to an audio component having a built-in DTS decoder. The player outputs the DTS signal even if "DTS" in "DIGITAL OUT" is set to "OFF" in "AUDIO SETUP" in the setup display, and may affect your ears or cause your speakers to be damaged.
- Set the sound to "STEREO" when you play DTS sound tracks on a CD. (See "Changing the Sound" on page 54.) If you have made the connections using an optical digital connecting cord and set the sound to "1/L" or "2/R," no sound will come out.
- If you have made the connections using an audio connecting cord and play a CD with a DTS sound track, a loud noise may come out, affecting your ears or causing the speakers to be damaged.

Notes on playing DTS sound tracks on a DVD

The signals of the DTS sound tracks are output only when you have made the connections using an optical digital connecting cord. No sound will be output when you have made the connections using an audio connecting cord.

- If the player is connected to an audio component lacking a built-in DTS decoder, do not set "DTS" in "DIGITAL OUT" to "ON" in "AUDIO SETUP" in the setup display. Otherwise, when you play the DTS sound track, a loud noise will come out from the speakers, affecting your ears or causing the speakers to be damaged.
- When you set "DTS" in "DIGITAL OUT" to "OFF," no sound will come out even if you have made the connections using an optical digital connecting cord and play DTS sound tracks on DVDs.

Notes

- If you leave the player or the remote in pause or stop mode for 15 minutes, the screen saver image appears automatically. To make the screen saver image go away, press \triangleright . (If you want to set the screen saver function to off, see page 84.)
- While playing a disc, do not turn off the player. Doing so may cancel the settings of the menu. When you turn off the player, press ■ first to stop playback and then press POWER.
- The power is automatically turned off whenever,
 - a disc is not being played.
 - you do not operate the player or the remote for more than 30 minutes.

Playing Discs (continued)

Additional operations

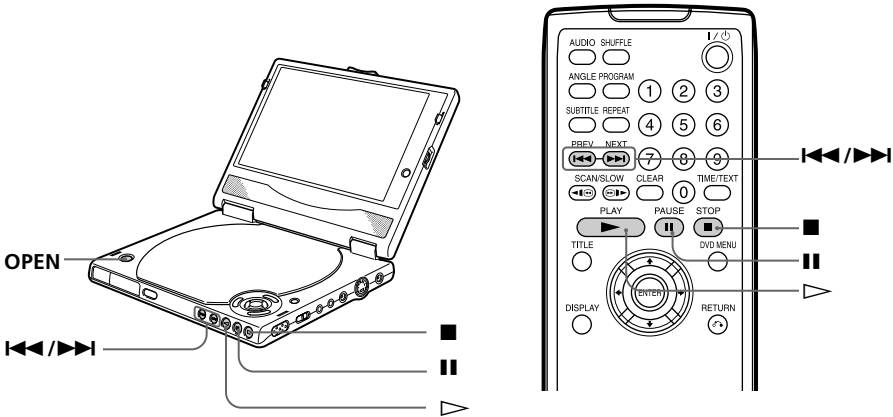

To	Operation
Stop	Press ■
Pause	Press
Resume playback after pause	Press or ▷
Go to the next chapter, track or scene in continuous play mode	Press ►►
Go back to the preceding chapter, track or scene in continuous play mode	Press ◄◄
Stop play and remove the disc	Press OPEN.

You can play discs in various modes such as Program Play using the on-screen menu (Control Menu). For Control Menu operations, see page 45.

Searching for a Particular Point on a Disc

DVD

VIDEO
CD

CD

You can locate a particular point on a disc quickly by monitoring the picture or playing back slowly.

Note

Depending on the DVD/VIDEO CD, you may not be able to do some of the operations described.

Locating a point quickly (Search)

While a disc is playing, keep ►►I pressed on the player to locate a point in playback direction at the FF1►►* speed or keep I◄◄ pressed on the player to locate a point in opposite direction at the FR1◄◄* speed. When you find the point you want, release the button to return to normal playback speed.

* The FF1►►/FR1◄◄ playback speed is one of the scan speed described on the next page.

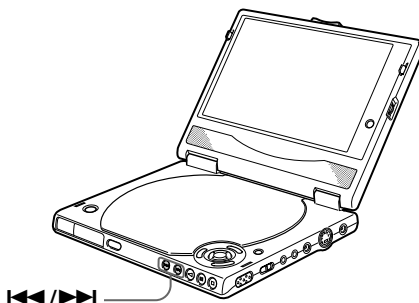

Searching for a Particular Point on a Disc (continued)

Locating a point quickly by playing a disc in fast forward or fast reverse (Scan)

Press ◀◀◀ or ▶▶▶ while playing a disc. When you find the point you want, press ▷ to return to normal speed.

Each time you press the ◀◀◀ or ▶▶▶ button during scan, the playback speed changes. Three speeds are available. With each press, the indication changes as follows:

Playback direction

×2▶▶▶ (DVD/CD only) → FF1▶▶▶ → FR2▶▶▶

Opposite direction

×2◀◀◀ (DVD only) → FR1◀◀◀ → FR2◀◀◀

The ×2▶▶▶/×2◀◀◀ playback speed is about twice the normal speed. The FF2▶▶▶/FR2◀◀◀ playback speed is faster than FF1▶▶▶/FR1◀◀◀.

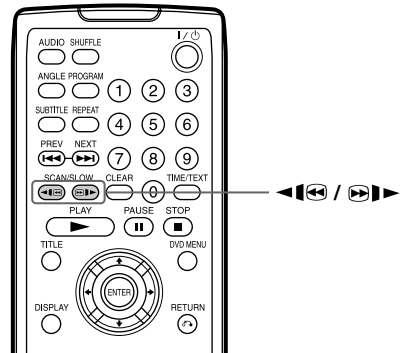

Locating a point slowly by watching the screen (Slow-motion play)

You can use this function only for DVDs or VIDEO CDs.

Press ◀◀◀ or ▶▶▶ when the player is in the pause mode. When you find the point you want, press ▷ to return to the normal speed.

Each time you press the ◀◀◀ or ▶▶▶ button during Slow-motion play, the playback speed changes. Two speeds are available. With each press, the indication changes as follows:

Playback direction

SLOW2▶▶▶ ↔ SLOW1▶▶▶

Opposite direction (DVD only)

SLOW2◀◀◀ ↔ SLOW1◀◀◀

The SLOW2▶▶▶/SLOW2◀◀◀ playback speed is slower than SLOW1▶▶▶/SLOW1◀◀◀.

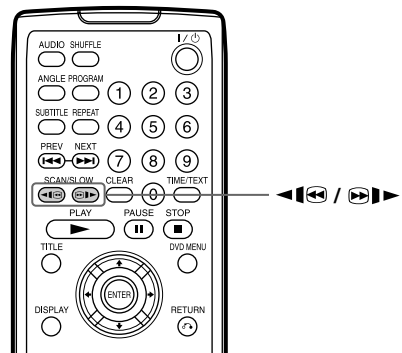

Resuming Playback from the Point Where You Stopped the Disc (Resume Play) **DVD** **VIDEO CD** **CD**

The player remembers the point where you stopped the disc, and when "RESUME" appears on the display window, you can resume playback from that point.

As long as you do not open the lid, Resume Play will work even if you press POWER.

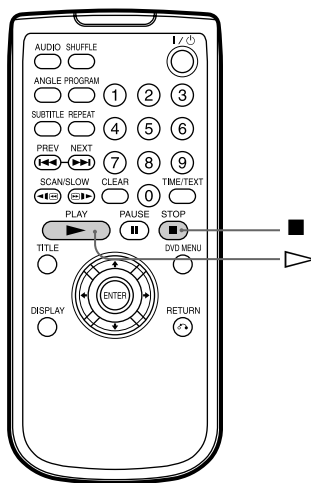
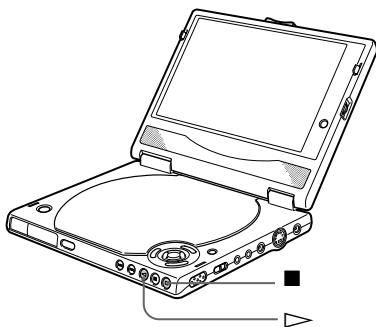

- 1** While playing a disc, press ■ to stop playback. "RESUME" appears on the display window and "Disc will restart from current point. To start from beginning, press [STOP] again." appears on the screen.
If "RESUME" does not appear, Resume Play is not available.

- 2** Press ▷.
The player starts playback from the point where you stopped the disc in Step 1.

To play from the beginning of the disc

When the playing time appears on the display window before you start playing, press ■ to reset the playing time, then press ▷.

Resuming Playback from the Point Where You Stopped the Disc (Resume Play) (continued)

Notes

- Resume Play may not be available on some DVDs.
- Resume Play is not available in Shuffle or Program Play mode.
- Depending on where you stopped the disc, the player may resume playback from a different point.
- The point where you stopped playing is cleared when:
 - you open the lid
 - you change the play mode
 - you start playback after selecting a title, chapter or track
 - you change the settings in the setup display
 - you disconnect the AC power adaptor
 - you detach the battery pack

Using the DVD's Menu

Some DVDs have a title menu or a DVD menu that is provided with DVDs only.

Using the title menu

A DVD is divided into long sections of a picture or a music feature called "titles." When you play a DVD which contains several titles, you can select the title you want using the title menu.

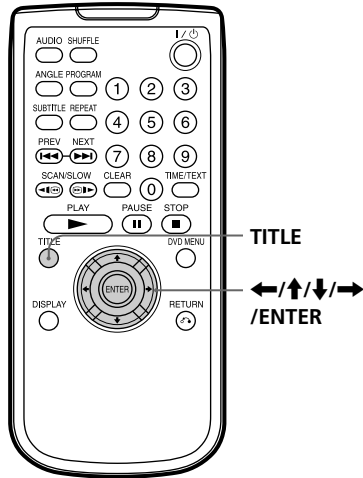
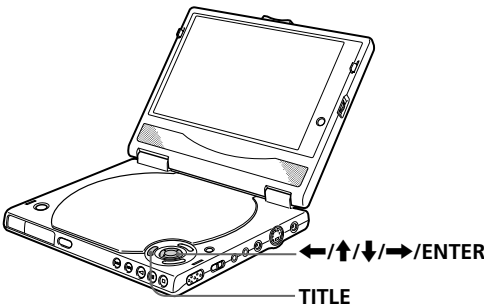

1

Press TITLE.

The title menu appears on the screen.
The contents of the menu vary from disc to disc.

2

Press ←/↑/↓/→ to select the title you want to play.

Depending on the disc, you can use the number buttons to select the title.

3

Press ENTER.

The player starts playing the selected title.

Notes

- On some DVDs, you may not be able to select the title.
- On some DVDs, a "title menu" may simply be called a "menu" or "title" in the instructions supplied with the disc. "Press ENTER." may also be expressed as "Press SELECT."

Using the DVD's Menu (continued)

Using the DVD menu

Some DVDs allow you to select the disc contents using a menu. When you play these DVDs, you can select the language for the subtitles, the language for the sound, etc., using the DVD menu.

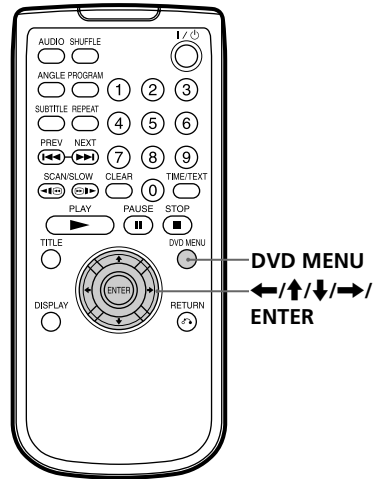
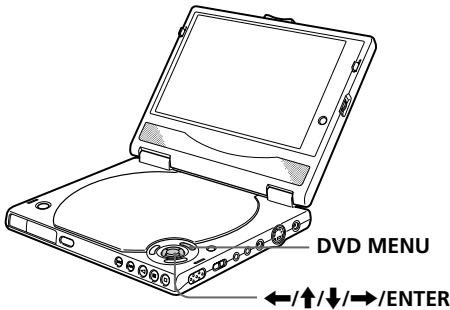

1

Press DVD MENU.

The DVD menu appears on the screen.
The contents of the menu vary from disc to disc.

2

Press ←/↑/↓/→ to select the item you want to change.

Depending on the disc, you can use the number buttons to select the item.

3

To change other items, repeat Step 2.

4

Press ENTER.



If you want to select the language for the DVD menu

Change the setting using "DVD MENU" in "LANGUAGE SETUP" in the setup display. For details, see page 80.

Note

Depending on the DVD, a "DVD menu" may simply be called a "menu" in the instructions supplied with the disc.

Playing VIDEO CDs with PBC Functions (PBC Playback)



When playing VIDEO CDs with PBC (Play Back Control) functions (Ver. 2.0 discs), you can enjoy simple interactive operations, search functions, and other such operations.

PBC Playback allows you to play VIDEO CDs interactively by following the menu on the screen.

On this player, you can use the number buttons, ENTER, **◀◀/▶▶**, **↑/↓** and **↻** RETURN during PBC Playback.

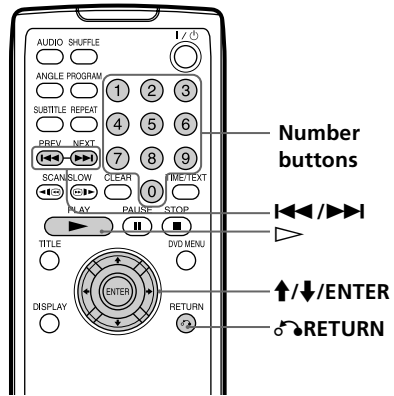
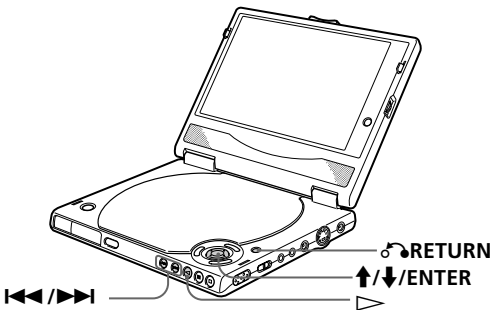

- 1 Start playing a VIDEO CD with PBC functions by following Steps 1 to 4 in "Playing Discs" on page 30.

- 2 Select the item number you want.
Press **↑/↓** to select the item number.
You can also select the item number with the number buttons on the remote.

- 3 Press ENTER.

- 4 Follow the instructions in the menu for interactive operations.
Refer to the instructions supplied with the disc, as the operating procedure may differ according to the VIDEO CD.

continued





Playing VIDEO CDs with PBC Functions (PBC Playback) (continued)

To go back to the menu



Press  RETURN,  or .

To cancel PBC playback of a VIDEO CD with PBC functions and play the disc in continuous play mode

There are two ways.

- Before you start playing, select the track you want using  or , then press ENTER or .
- Before you start playing, select the track number using the number buttons on the remote, then press ENTER or .

“Play without PBC.” appears on the screen and the player starts continuous play. You cannot play still pictures such as a menu.

To return to PBC playback, press  twice then press .

Notes

- Depending on the VIDEO CD, “Press ENTER” in Step 3 may be expressed as “Press SELECT” in the instructions supplied with the disc. In this case, press .
- The PBC functions of Super VCDs do not work with this player. Super VCDs are played in continuous play mode only.

Using the Display Window



You can check information about the disc, such as the total number of titles or tracks or remaining time, using the display window.

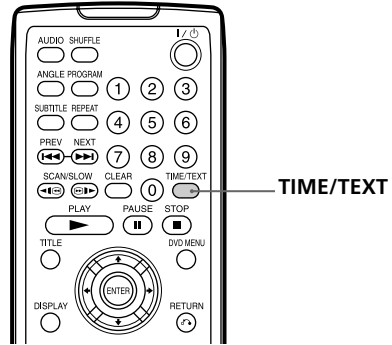

When playing back a DVD

Displaying information while playing the disc

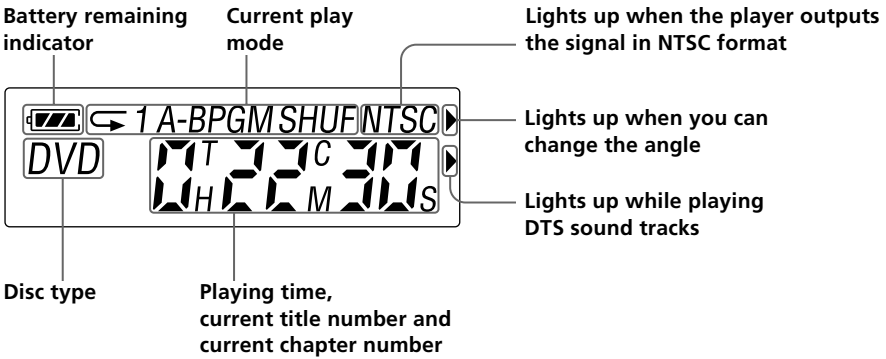

Using the Display window (continued)

Checking the remaining time

Press TIME/TEXT.

Each time you press TIME/TEXT while playing the disc, the display changes as shown in the following chart.

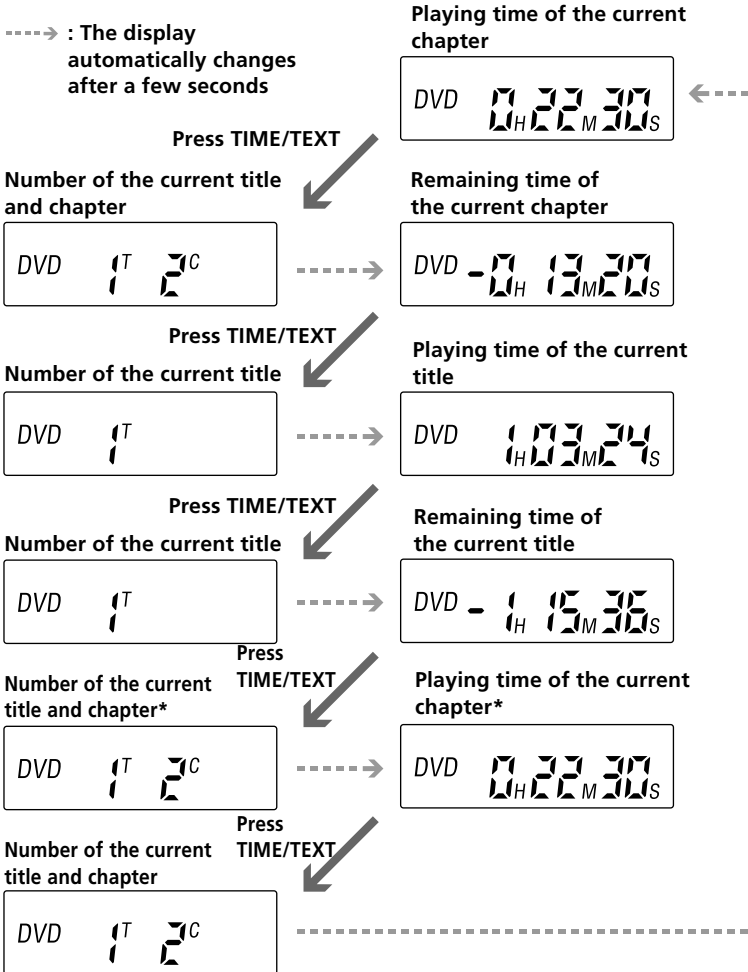

* The DVD TEXT is displayed on the screen.

Notes

- On some DVDs, the chapter number or time may not appear or you may not be able to change the display window.
- While you are doing Shuffle Play or Program Play, the playing time of the title and the remaining time of the title are not displayed.

When playing back a CD/VIDEO CD



Displaying information while playing the disc

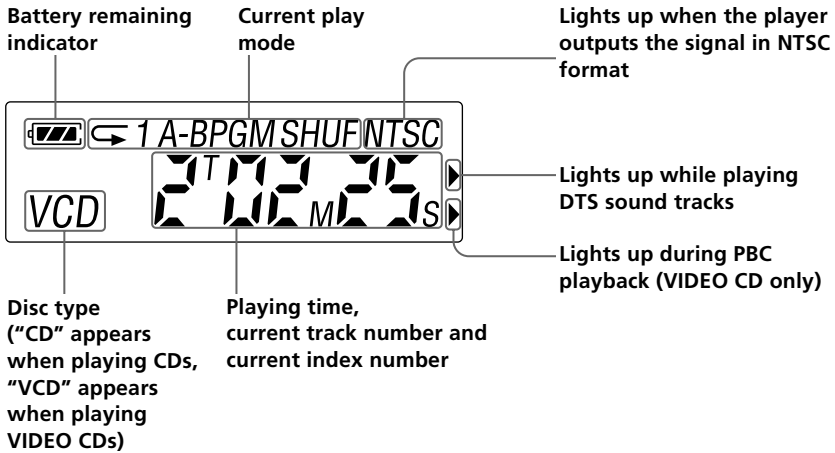

When playing VIDEO CDs with PBC functions

The current scene number is displayed instead of the current track number and the current index number. In this case, the display window does not change when you press TIME/TEXT (see page 51).

Using the Display window (continued)

Checking the remaining time

Press TIME/TEXT.

Each time you press TIME/TEXT while playing a disc, the display changes as shown in the following chart.

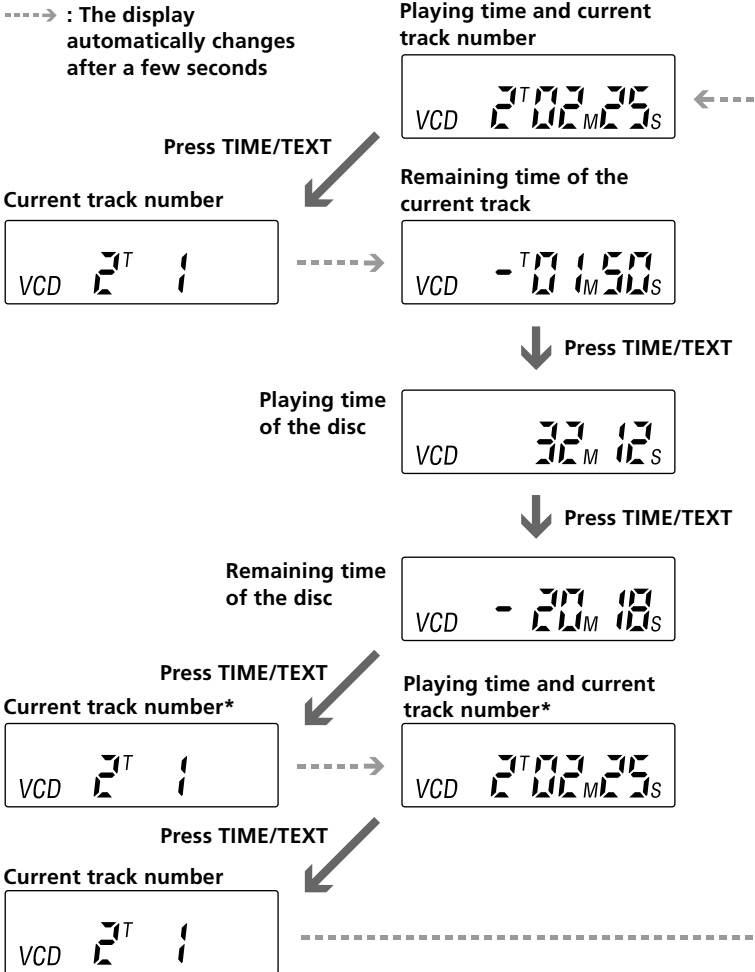

* The CD TEXT is displayed on the screen.

Note

While you are doing Shuffle Play, or Program Play, the playing time of the disc and the remaining time of the disc are not displayed.

Using the Control Menu Display



Using the Control Menu display, you can select the start point, play scenes in any order you like, change the viewing angles, make Digital Cinema Sound settings, and other such operations. The possible operations are different depending on the kind of disc.

For details on each Control Menu display item, see pages 48 to 75.

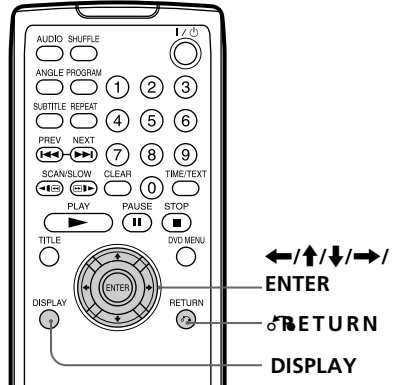
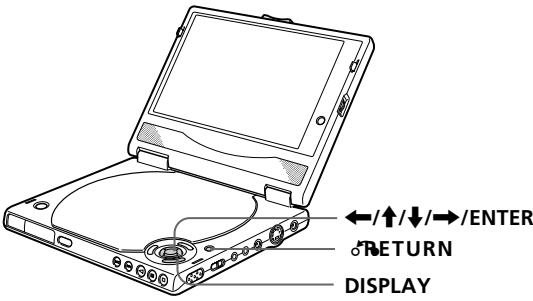

- 1 Press DISPLAY to show the Control Menu display on the screen.

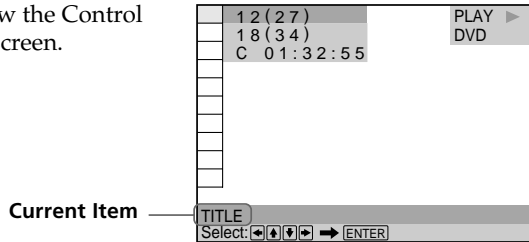

- 2 Select the item you want using \uparrow/\downarrow .

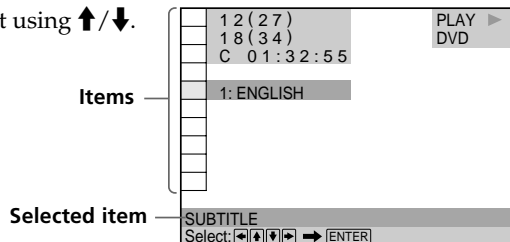

continued

Using the Control Menu Display (continued)

3 Press ENTER.

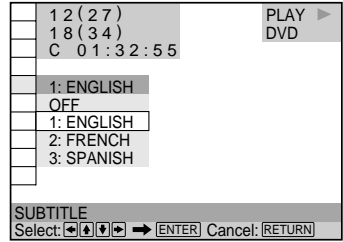

4 Select the item you want using ↑/↓.

Selected item

Items

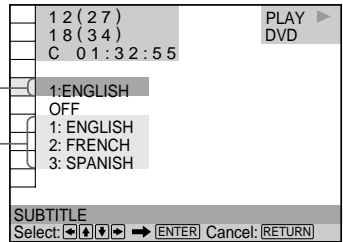

5 Press ENTER.

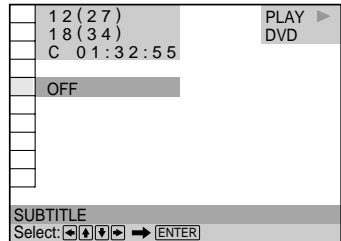

To cancel while making a selection

Press ⏪ RETURN.

To display other items

Each time you press DISPLAY, the Control Menu display changes as follows:

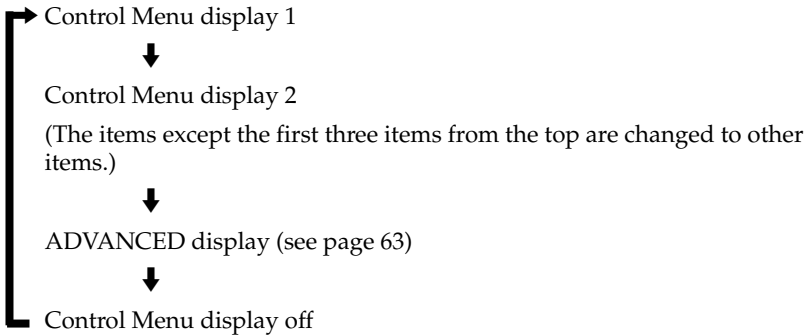

The Control Menu display items are different depending on the discs.

You can select some items directly

Some items can be displayed by pressing the corresponding button on the remote. In this case, only the item you selected is displayed. For instructions on using the remote, see the pages of each relevant item.

Note

Some Control Menu display items require operations other than selecting the setting. For details on these items, see the relevant pages.

Control Menu Item List



TITLE (DVD only) (page 50)/

SCENE (VIDEO CD during PBC playback only) (page 50)/

TRACK (VIDEO CD only) (page 50)



CHAPTER (DVD only) (page 50)/

INDEX (VIDEO CD only) (page 50)



TRACK (CD only) (page 50)



INDEX (CD only) (page 50)

You can search for a point on the DVD by selecting the title, chapter, track, index or scene.



TIME/TEXT (pages 51 to 53)

You can check the playing time and remaining time of the current title, chapter, track and the total playing time or remaining time of the disc.

You can also search by inputting the time code.

You can check the DVD TEXT or CD TEXT of the disc on the screen.



AUDIO (page 54)

If the DVD is recorded with multilingual tracks, you can select the language you want while playing the DVD.

If the DVD is recorded in multiple audio formats (PCM, Dolby Digital, MPEG or DTS), you can select the audio format you want while playing the DVD.

With multiplex CDs or VIDEO CDs, you can select the sound from the right or left channel and listen to the sound of the selected channel through both the right and left speakers.



SUBTITLE (DVD only) (page 57)

With DVDs on which multilingual subtitles are recorded, you can change the subtitle language whenever you want while playing the DVD, and turn it on or off whenever you want.



ANGLE (DVD only) (page 58)

With DVDs on which various angles (multi-angles) are recorded, you can change the angle of the scene.



VES (DVD only) (page 60)

Select a mode to enjoy multichannel surround sound such as Dolby Digital and MPEG.

Even if you connect only front speakers, Virtual Enhanced Surround (VES) lets you enjoy 3D sound by using 3D sound imaging to create virtual rear speakers from the sound of the front speakers (L, R) without using actual rear speakers.



ADVANCED (DVD only) (page 63)

You can check play information about the bit rate or the position where the disc is being played (layer).



CUSTOM PARENTAL CONTROL (page 65)

Using a registered password, you can set playback restrictions for a desired disc.

The same password is used for both Parental Control (page 85) and Custom Parental Control.



SETUP (page 76)

Using the setup display, you can do the initial setup, adjust the picture and sound and set the various outputs. You can also set a language for the subtitles and the setup display, limit playback by children, and so on. For details about the setup display, see page 76.



PROGRAM (page 68)

You can play the contents of the disc in the order you want by arranging the order of the titles, chapters or tracks on the disc to create your own program.



SHUFFLE (page 72)

You can have the player “shuffle” titles, chapters or tracks and play them in a random order. Subsequent “shuffling” may produce a different playing order.



REPEAT (page 73)

You can play all the titles/tracks on a disc or a single title/chapter/track repeatedly.



A-B REPEAT (page 74)

You can play a specific portion of a title, chapter, or track repeatedly.

Searching for a Title/Chapter/Track/ Index/Scene



You can search the disc by title, chapter, track, index or scene.

Select "TITLE," "CHAPTER," "TRACK," "INDEX" or "SCENE" after pressing DISPLAY.

When you play back a DVD, "TITLE" and "CHAPTER" are displayed.

When you play back a VIDEO CD/CD, "TRACK" and "INDEX" are displayed.

When you play back a VIDEO CD with PBC functions, "SCENE" is displayed.

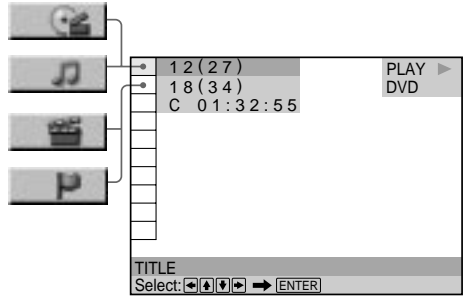

- 1 Select "TITLE," "CHAPTER," "TRACK," "INDEX" or "SCENE" using **↑/↓**.

"** (**)" is highlighted. (** refers to a number) The number in parentheses indicates the total number of titles, chapters, tracks, indexes or scenes.

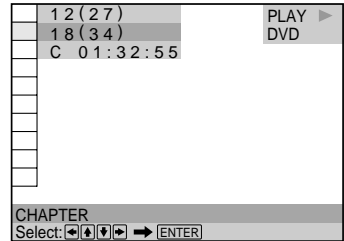

- 2 Press **→** or **ENTER**.

"** (**)" changes to "-- (**)".

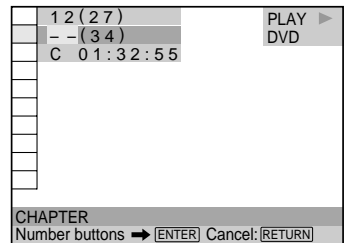

- 3 Select the number of the title, chapter, track, index or scene you want to search for using the number buttons, then press **ENTER**.

The player starts playback at the selected number.

To cancel the number, press **CLEAR** before pressing **ENTER**.

To cancel while making a selection

Press **↶** RETURN.

Notes

- The title, chapter or track number displayed is the same number recorded on the disc.
- The index numbers are not displayed during PBC playback of VIDEO CDs.

Checking the Playing Time and Remaining Time



You can check the playing time and remaining time of the current title, chapter or track and the total playing time or remaining time of the disc.

Press DISPLAY. Then press TIME/TEXT on the remote to change the time information.

You can also check the DVD TEXT or CD TEXT. See page 53.

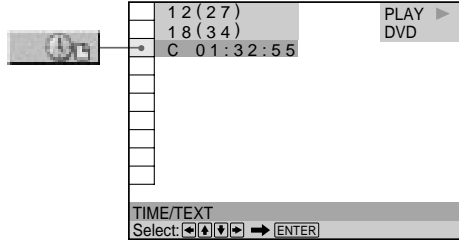

When playing a DVD

■ TIME/TEXT

- C **: **: **: **: **: Playing time of the current chapter
- C - **: **: **: **: **: Remaining time of the current chapter
- T **: **: **: **: **: Playing time of the current title
- T - **: **: **: **: **: Remaining time of the current title

When playing a VIDEO CD (during PBC playback)

■ TIME/TEXT

- **: **: **: **: Playing time of the current scene

When playing a VIDEO CD (in continuous play) or CD

■ TIME/TEXT

- T **: **: **: **: Playing time of the current track
- T - **: **: **: **: Remaining time of the current track
- D **: **: **: **: Playing time of the current disc
- D - **: **: **: **: Remaining time of the current disc

When playing a Super VCD

The remaining time cannot be displayed.

■ TIME/TEXT

- T **: **: **: **: Playing time of the current track



You can select "TIME/TEXT" directly

Press TIME/TEXT on the remote. Each time you press the button, the time information changes.

Selecting a Starting Point Using the Time Code

You can search for a starting point by inputting the time code.

Select "TIME/TEXT" after pressing DISPLAY.

The time code corresponds to the approximate actual playing time. For example, to search for a scene 2 hours 10 minutes 20 seconds past the beginning, input 2:10:20.

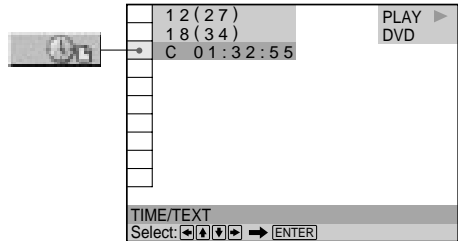

- 1 Select "C * * * : * * * " (playing time of the current chapter) when playing a DVD.

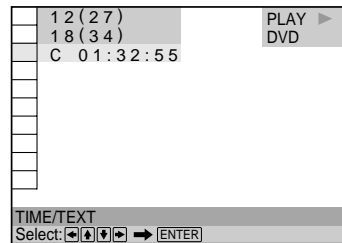

- 2 Press → or ENTER. Time code changes to "T - - : - - : - -".

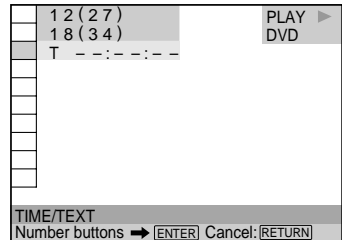

- 3 Input the time code using the number buttons, then press ENTER. The player starts playback at the selected time code. To cancel the number, press CLEAR before pressing ENTER.

To cancel while making a selection

Press  RETURN.

Note

When you input the time code, input the playing time of the title, not the chapter or track time.

Viewing the Disc Information



You can check the DVD TEXT or CD TEXT of the disc on the screen.

DVD TEXT and CD TEXT are information recorded on the disc which you cannot change.

Press DISPLAY. Then press TIME/TEXT on the remote until DVD/CD TEXT is displayed.

The information is displayed at the bottom of the display.

As DVD/CD text is not scrolled, some characters may not be displayed.

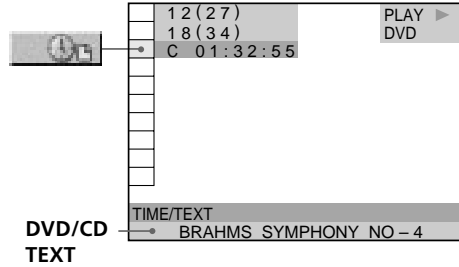

You can select "TIME/TEXT" directly

Press TIME/TEXT on the remote. To display DVD/CD TEXT, press TIME/TEXT until DVD/CD TEXT is displayed.

Notes

- DVD TEXT is displayed only in English.
- "NO TEXT" appears when the DVD/CD TEXT is not recorded on the disc.
- This player can only display the first level of DVD/CD TEXT information.
- When the DVD/CD TEXT is displayed, the operation guide does not appear.

Changing the Sound

If the DVD is recorded with multilingual tracks, you can select the language you want while playing the DVD.

If the DVD is recorded in multiple audio formats (PCM, Dolby Digital, MPEG or DTS), you can select the audio format you want while playing the DVD.

With multiplex CDs or VIDEO CDs, you can select the sound from the right or left channel and listen to the sound of the selected channel through both the right and left speakers. In this case, the sound loses its stereo effect. For example, with a disc containing a song, the right channel may output the vocals and the left channel may output the instrumental. If you only want to hear the instrumental, you can select the left channel and hear it from both speakers.

Select "AUDIO" after pressing DISPLAY.

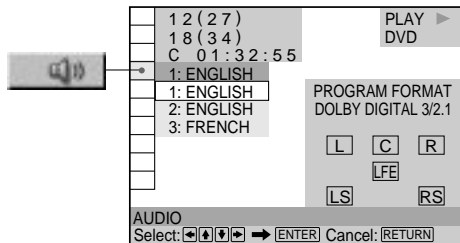

■ AUDIO

When playing a DVD

Select the language. The languages you can select are different depending on the DVD. When 4 digits are displayed, they represent the language code. Select the language code from the list on page 109.

When the same language is displayed two or more times, the DVD is recorded in multiple audio formats. The current audio format is shown on the "PROGRAM FORMAT" display.

When playing a VIDEO CD or a CD

The default setting is underlined.

- STEREO : The standard stereo sound
- 1/L : The sound of the left channel (monaural)
- 2/R : The sound of the right channel (monaural)

When playing a Super VCD

The default setting is underlined.

- 1:STEREO : The stereo sound of the audio track 1
- 1:1/L : The sound of the left channel of the audio track 1 (monaural)
- 1:2/R : The sound of the right channel of the audio track 1 (monaural)
- 2:STEREO : The stereo sound of the audio track 2
- 2:1/L : The sound of the left channel of the audio track 2 (monaural)
- 2:2/R : The sound of the right channel of the audio track 2 (monaural)

You can select "AUDIO" directly

Press AUDIO on the remote. Each time you press the button, the item changes.

Notes

- Depending on the DVD, you may not be able to change the languages even if multilingual tracks are recorded on the DVD.
- While playing the CD/VIDEO CD, standard stereo playback will be resumed when:
 - you open the lid
 - you turn the power off
- While playing the DVD, the sound may be changed when:
 - you open the lid
 - you change the title
 - you disconnect the AC power adaptor
 - you detach the battery pack
- While playing the Super VCD on which the audio track 2 is not recorded, no sound will come out when you select "2: Stereo," "2:1/L" or "2:2/R."

Displaying the audio information of the disc

When you select "AUDIO," the channels being played are displayed on the screen.

For example, in Dolby Digital format, multiple signals ranging from monaural to 5.1 channel signals can be recorded on a DVD. Depending on the DVD, the number of the recorded channels may be different.

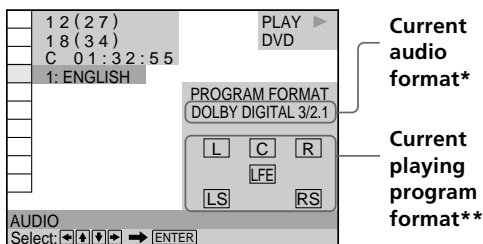

* "PCM," "DTS," "DOLBY DIGITAL" or "MPEG" is displayed. In case of "DOLBY DIGITAL," the channels in the playing track are displayed by numbers as follows:

For Dolby Digital 5.1 ch:

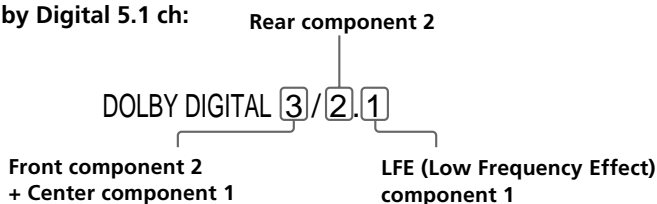

** The letters in the program format display mean the following:

- L: Front (left)
- R: Front (right)
- C: Center (monaural)
- LS: Rear (left)
- RS: Rear (right)
- S: Rear (monaural) – the rear component of the Dolby Surround processed stereo signal and the Dolby Digital signal.
- LFE: – LFE (Low Frequency Effect)

continued

Changing the Sound (continued)

The display examples are as follows:

- PCM (stereo)

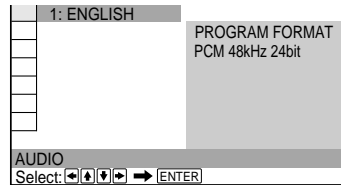

- Dolby Surround

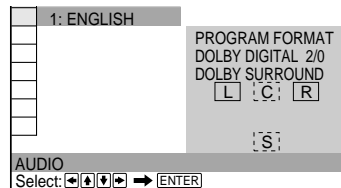

- Dolby Digital 5.1ch
"LFE" appears only when a disc contains an LFE signal component.
"LFE" remains on the "PROGRAM FORMAT" display even if the LFE signal component is not being output.

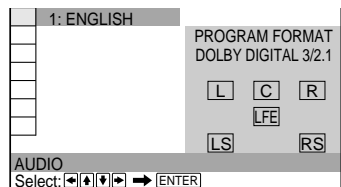

- MPEG

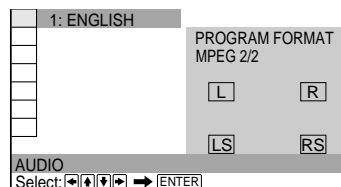

- DTS
"LFE" is always enclosed in a solid line regardless of the LFE signal component being output.

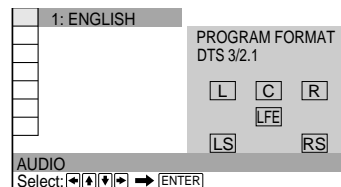

Note

When the signal does not contain rear signal components such as LS, RS or S, the Virtual Enhanced Surround (VES) effect cannot be heard (page 60).

Displaying the Subtitles

With DVDs on which subtitles are recorded, you can turn the subtitles on and off whenever you want while playing the DVD.

With DVDs on which multilingual subtitles are recorded, you can change the subtitle language whenever you want while playing the DVD, and turn it on or off whenever you want. For example, you can select the language you want to practice and turn the subtitles on for better understanding.

Select "SUBTITLE" after pressing DISPLAY.

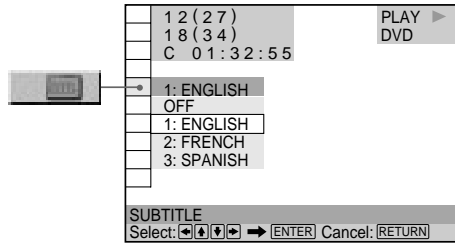

■ SUBTITLE

Select the language. The languages you can select are different depending on the DVD. When 4 digits are displayed, they indicate the language code. Select the language code from the list on page 109.

You can select "SUBTITLE" directly

Press SUBTITLE on the remote. Each time you press the button, the item changes.

Notes

- When playing a DVD on which no subtitles are recorded, no subtitles appear.
- Depending on the DVD, you may not be able to turn the subtitles on even if they are recorded on the DVD.
- Depending on the DVD, you may not be able to turn the subtitles off.
- The type and number of languages for subtitles vary from disc to disc.
- Depending on the DVD, you may not be able to change the subtitles even if multilingual subtitles are recorded on it.
- While playing the DVD, the subtitle may change when:
 - you open the lid
 - you change the title
 - you disconnect the AC power adaptor
 - you detach the battery pack

Changing the Angles



With DVDs on which various angles (multi-angles) for a scene are recorded, you can change the angles. For example, while playing a scene of a train in motion, you can display the view from either the front of the train, the left window of the train or from the right window without having the train's movement interrupted.

Select "ANGLE" after pressing DISPLAY. When the angles can be changed, the "ANGLE" indicator lights up in green.



Indicator

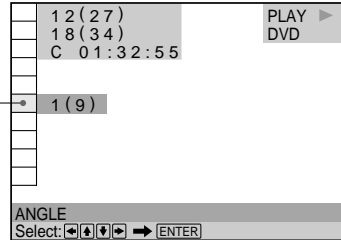

- 1 Select "ANGLE."

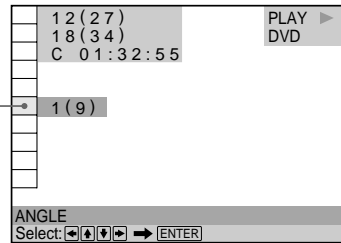

- 2 Press →.

The number of the angle changes to "-". The number in parentheses indicates the total number of angles.

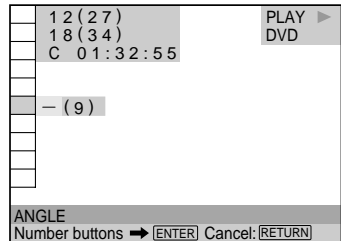

- 3 Select the angle number using the number buttons or ↑/↓, then press ENTER.

The angle is changed to the selected angle.

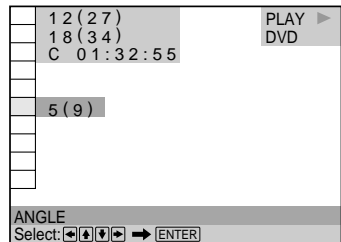

 **You can select "ANGLE" directly**

Press ANGLE on the remote. Each time you press the button, the angle changes.

Notes

- The number of angles varies from disc to disc or from scene to scene. The number of angles that can be changed on a scene is equal to the number of angles recorded for that scene.
- Depending on the DVD, you may not be able to change the angles even if multi-angles are recorded on the DVD.

Digital Cinema Sound Settings

Select a mode to enjoy multichannel surround sound such as Dolby Digital and MPEG.

Even if you connect only a stereo TV or front speakers, Virtual Enhanced Surround (VES) lets you enjoy 3D sound by using 3D sound imaging to create virtual rear speakers from the sound of the front speakers (L, R) without using actual rear speakers.

The surround sound signals are output when you have made the connections using an audio connecting cord.

When you select a surround mode, the player does not output the following signals when you have made the connections using an optical digital connecting cord.

- Dolby Digital signals (when you select "DIGITAL OUT" in "AUDIO SETUP" and set "DOLBY DIGITAL" to "D-PCM")
- MPEG audio signals

Select "VES" after pressing DISPLAY.
When you select any item except "OFF," the "VES" indicator lights up in green.

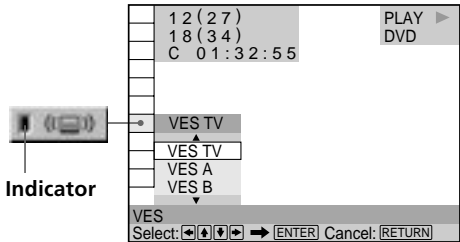

■ VES

Select the desired item. For details on each item, see "Effects of each item."
The default setting is underlined.

- OFF
- VES TV
- VES A
- VES B
- VIRTUAL SEMI MULTI DIMENSION

Effects of each item

OFF

Outputs 2-channel signals for stereo sound. 5-channel signals for Dolby Digital sound of a DVD are mixed down to 2-channels.

VES (Virtual Enhanced Surround) TV

Uses 3D sound imaging to create virtual rear speakers from the sound of the front speakers (L, R) without using actual rear speakers. This mode is effective when the distance between the front L and R speakers is short, such as built-in speakers on a stereo TV.

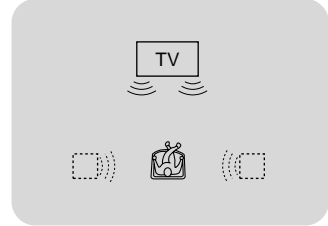

VES (Virtual Enhanced Surround) A

Uses 3D sound imaging to create virtual rear speakers from the sound of the front speakers (L, R) without using actual rear speakers. The virtual speakers are reproduced as shown in the illustration on the right.

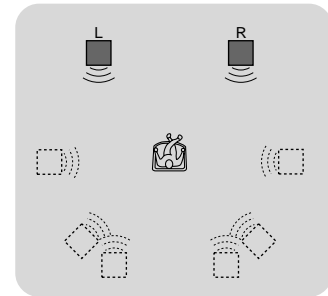

VES (Virtual Enhanced Surround) B

Uses 3D sound imaging to create virtual rear speakers from the sound of the front speakers (L, R) without using actual rear speakers. The virtual speakers are reproduced as shown in the illustration on the right.

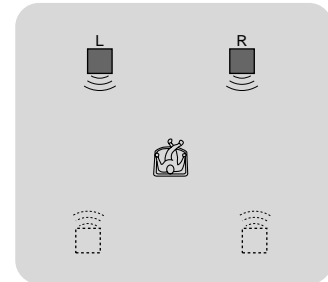

VIRTUAL SEMI MULTI DIMENSION

Uses 3D sound imaging to create virtual rear speakers from the sound of the front speakers (L, R) without using actual rear speakers. This mode creates 5 sets of virtual speakers surrounding the listener at a 30° angle of elevation.

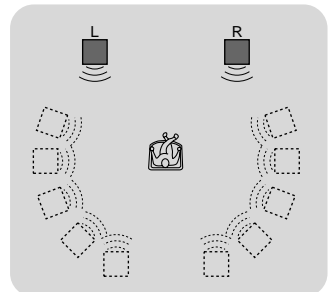

Digital Cinema Sound Settings (continued)

Notes

- When you select an item, the sound cuts off for a moment.
- When the playing signal does not contain the surround component, the effects may be difficult to hear even if you select "VES TV," "VES A," "VES B" or "VIRTUAL SEMI MULTI DIMENSION."
- Set the front speakers to form an equilateral triangle with the listening position at the top, or the effects may be difficult to hear even if you select "VES A," "VES B" or "VIRTUAL SEMI MULTI DIMENSION."
- When you select "VES TV," "VES A," "VES B" or "VIRTUAL SEMI MULTI DIMENSION," set the surround settings of the connected units, such as the amplifier, to OFF.
- You cannot use the headphone surround function and Virtual Enhanced Surround (VES) at the same time. When you turn on the headphone surround function, "VES" is automatically set to "OFF" (page 95).

Checking the Play Information DVD

You can check information such as the bit rate or the disc layer that is being played.

While playing a disc, the approximate bit rate of the playback picture is always displayed as Mbps (Mega bit per second) and the audio as kbps (kilo bit per second).

Select "ADVANCED" after pressing DISPLAY.

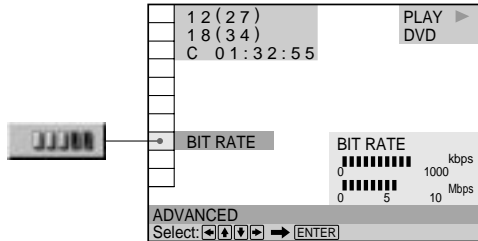

■ ADVANCED

The default setting is underlined.

When playing a DVD

- BIT RATE: displays the bit rate.
- LAYER: displays the layer and the pick-up point.
- OFF: turns off ADVANCED display.

continued

Checking the Play Information (continued)

Displays of each item

By pressing DISPLAY repeatedly, you can display either "BIT RATE" or "LAYER," whichever was selected in "ADVANCED."

BIT RATE

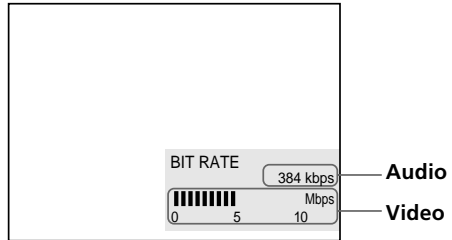

When you play MPEG audio sound tracks

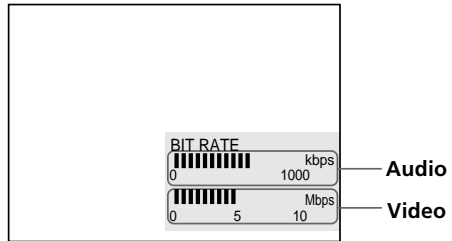

Bit rate refers to the amount of video/audio data per second in a disc. The higher the bit rate, the larger the amount of data. When the bit rate level is high, there is a large amount of data. However, this does not always mean that you can get higher quality pictures or sounds.

LAYER

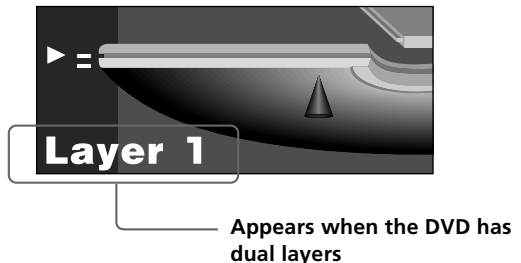

Indicates the approximate point where the disc is playing.
If it is a dual-layer DVD, the player indicates which layer is being read ("Layer 0" or "Layer 1").
For details on the layers, see page 107 (DVD).

Locking Discs (Custom Parental Control)



Using a registered password, you can set playback restrictions for the desired disc. You can set the same Custom Parental Control password for up to 50 discs. When you set the fifty-first disc, the first disc is canceled.

The same password is used for both Parental Control (page 85) and Custom Parental Control.

Select "CUSTOM PARENTAL CONTROL" after pressing DISPLAY.

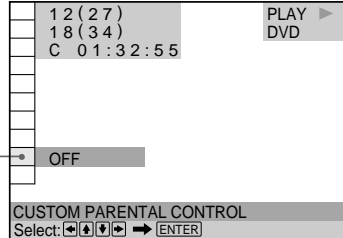

Setting the Custom Parental Control for a disc

- 1 Insert the disc you want to lock.
If a disc is playing, press **■** to stop playback.
- 2 Select "CUSTOM PARENTAL CONTROL" using **↑/↓**, then press ENTER.

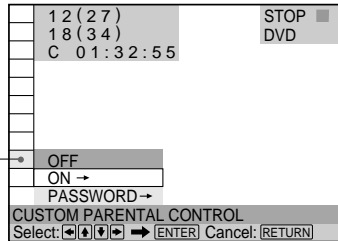

- 3 Select "ON→" using **↑/↓**, then press ENTER.

■ If you have not entered a password

The display for entering a password appears.

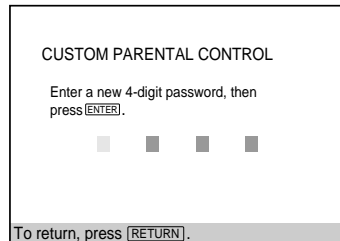

continued

Locking Discs (Custom Parental Control) (continued)

■ When you have already registered a password

The display for confirming the password appears. Skip Step 4.

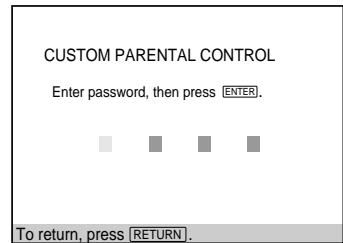

4 Enter a 4-digit password using the number buttons, then press ENTER.

The digits change to asterisks (*), and the display for confirming the password appears.

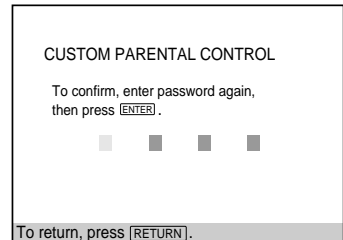

5 Enter the same 4-digit password using the number buttons, then press ENTER.

“Custom parental control is set.” appears and then the screen returns to the Control Menu display.

To return to the normal screen

Press **↩**RETURN.

To turn off the Custom Parental Control function

- 1 Select “CUSTOM PARENTAL CONTROL” using **↑/↓**, then press ENTER.
- 2 Select “OFF” using **↑/↓**, then press ENTER.
- 3 Enter your 4-digit password using the number buttons, then press ENTER.

To change the password

- 1 Select “CUSTOM PARENTAL CONTROL” using **↑/↓**, then press ENTER.
- 2 Select “PASSWORD→” using **↑/↓**, then press ENTER.
- 3 Enter your 4-digit password using the number buttons, then press ENTER.
The display for changing the password appears.
- 4 Enter a new 4-digit password using the number buttons, then press ENTER.
- 5 To confirm your password, re-enter it using the number buttons, then press ENTER.

Playing the disc for which the Custom Parental Control is set

- 1 Insert the disc.
The CUSTOM PARENTAL CONTROL display appears.

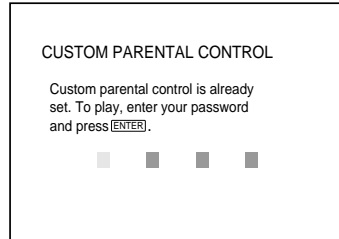

- 2 Enter your 4-digit password using the number buttons, then press ENTER.
The player starts playback.

If you forget your password

Enter the 6-digit number "199703" whenever the CUSTOM PARENTAL CONTROL display asks you for your password, then press ENTER. The display will ask you to enter a new 4-digit password.

Notes

- Unless you enter the password, the player cannot play the disc for which the Custom Parental Control is set. When you do not know the password, press OPEN and remove the disc.
- When you insert the disc for which the Custom Parental Control is set, "CPC" appears on the display window. To play the disc, follow the steps above.

Creating Your Own Program

(Program Play) **DVD** **VIDEO CD** **CD**

You can play the contents of the disc in the order you want by arranging the order of the titles, chapters or tracks on the disc and create your own program. One program can be stored in the player and contain up to 99 titles, chapters and tracks.

Select "PROGRAM" after pressing DISPLAY. When you select "ON," the "PROGRAM" indicator lights up in green.

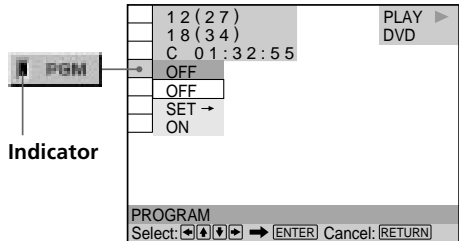

PROGRAM

The default setting is underlined.

- OFF: plays normally.
- SET →: allows you to create your own program.
- ON: plays Program Play.

Creating the program

- 1 Select "SET →" in "PROGRAM."
The programming display appears.

"TRACK" is displayed when you play a VIDEO CD or a CD.

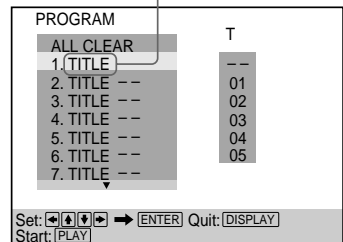

- 2 Press →.
"01" is highlighted. It is ready to set the first title or track for Program Play.

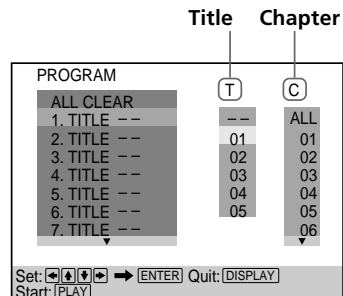

- 3** Select the title, chapter or track you want to program using \uparrow/\downarrow , then press ENTER.

For example, select title or track 2.

(You can also use the number buttons and ENTER button to make a selection. In this case, the selected number is displayed on the screen.)

■ When playing a DVD

When both titles and chapters are recorded on the disc, select the title, then the chapter.

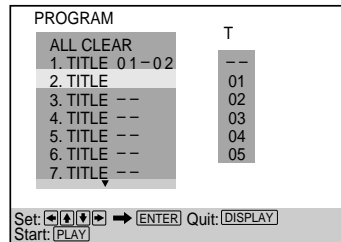
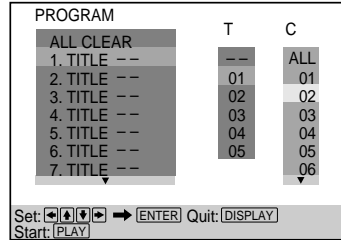

■ When playing a VIDEO CD or CD

Select the track you want to program.

Total time of the programmed tracks

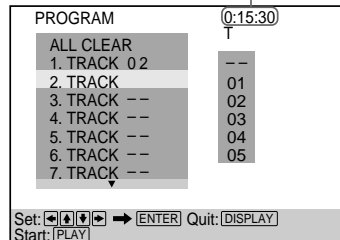

continued

Creating Your Own Program (Program Play) (continued)

- 4** To program other titles, chapters or tracks, repeat Step 3.
The programmed titles, chapters or tracks are displayed in the selected order.
- 5** Press \triangleright to start Program Play.

To stop Program Play

Press CLEAR on the remote.

To change the program

- 1** In Step 2, select the program number of the title, chapter or track you want to change using \uparrow/\downarrow .
- 2** Follow Step 3 for new programming.

To cancel the programmed order

To cancel all the titles, chapters or tracks in the programmed order, select "ALL CLEAR" in Step 2.

To cancel the selected program, select the program using \uparrow/\downarrow in Step 2 then press CLEAR, or select "--" in Step 3 then press ENTER.

The program remains even after Program Play ends

When you press \triangleright , you can play the same program again.

You can do Repeat Play or Shuffle Play of the programmed titles, chapters or tracks

During Program Play, set "REPEAT" or "SHUFFLE" to "ON" in the Control Menu display.

You can select "PROGRAM" directly

Press PROGRAM on the remote.

💡 You can select discs, titles, chapters and tracks for the program by looking at the display window

You can program by looking at the display window instead of using the programming display on the screen.

When you select Track 3 in a VIDEO CD for Program 1, the display window will appear as follows:

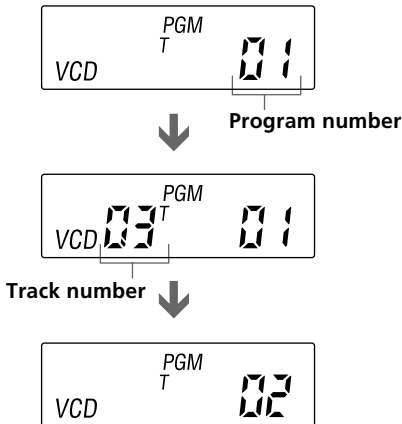

Notes

- The number of titles, chapters or tracks displayed are the same number of titles, chapters or tracks recorded on a disc.
- The program is canceled when:
 - you open the lid
 - you turn the power off
- Depending on the DVD, you may not be able to perform Program Play.
- If you are using the PBC playback function, you must first stop the disc before you can set a program.

Playing in Random Order (Shuffle Play)

You can have the player “shuffle” titles or tracks and play them in a random order. Subsequent “shuffling” may produce a different playing order.

Select “SHUFFLE” after pressing DISPLAY. When you select a shuffle mode other than “OFF,” the “SHUFFLE” indicator lights up in green.

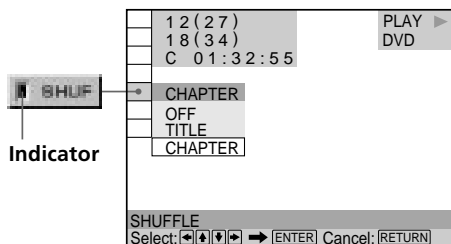

■ SHUFFLE

Selects the Shuffle Play setting.
The default settings are underlined.

When playing a DVD and when Program Play is set to OFF

- OFF: does not play a disc in random order.
- TITLE: has the player “shuffle” titles and play them in a random order.
- CHAPTER: has the player “shuffle” chapters and play them in a random order.

When playing a VIDEO CD or CD (when Program Play is set to OFF)

- OFF: does not play a disc in random order.
- TRACK: has the player “shuffle” tracks and play them in a random order.

When playing a VIDEO CD, CD or DVD (when Program Play is set to ON)

- OFF: does not play a disc in random order.
- ON: has the player “shuffle” titles or tracks selected in Program Play and play them in a random order.

To stop Shuffle Play

Press CLEAR on the remote.

You can set Shuffle Play while the disc is stopped

After selecting the “SHUFFLE” option, press .
The player starts Shuffle Play.

You can select “SHUFFLE” directly

Press SHUFFLE on the remote.

Notes

- Shuffle Play is canceled when:
 - you open the lid
 - you turn the power off
- Depending on the DVD, you may not be able to perform Shuffle Play.
- Up to 200 chapters in a disc can be played in random order when “CHAPTER” is selected.
- You cannot perform Shuffle Play during PBC playback of VIDEO CDs (page 39).

Playing Repeatedly (Repeat Play)



You can play all of the titles or tracks on a disc or a single title, chapter or track repeatedly.

In Shuffle or Program Play mode, the player repeats the titles or tracks in the shuffled or programmed order.

You cannot perform Repeat Play during PBC playback of VIDEO CDs (page 39).

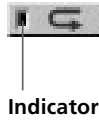

Indicator

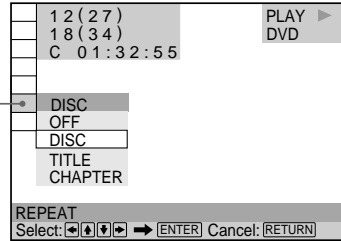

Select "REPEAT" after pressing DISPLAY. When you select a repeat mode other than "OFF," the "REPEAT" indicator lights up in green.

■ REPEAT

Selects the Repeat Play setting.
The default settings are underlined.

When playing a DVD and when Program Play and Shuffle Play are set to OFF

- OFF: does not play repeatedly.
- DISC: repeats all of the titles.
- TITLE: repeats the current title on a disc.
- CHAPTER: repeats the current chapter.

When playing a VIDEO CD/CD and when Program Play and Shuffle Play are set to OFF

- OFF: does not play repeatedly.
- DISC: repeats all of the tracks on a disc.
- TRACK: repeats the current track.

When Program Play or Shuffle Play is on

- OFF: does not play repeatedly.
- ON: repeats Program Play or Shuffle Play.

To stop Repeat Play

Press CLEAR on the remote.

💡 You can set Repeat Play while the disc is stopped

After selecting the "REPEAT" option, press \triangleright .
The player starts Repeat Play.

💡 You can select "REPEAT" directly

Press REPEAT on the remote.

Notes

- Repeat play is canceled when:
 - you open the lid
 - you turn the power off
- Depending on the DVD, you may not be able to perform Repeat Play.

Repeating a Specific Portion (A-B Repeat)

You can play a specific portion of a title, chapter or track repeatedly. This function is useful when you want to do such things as memorize lyrics. During PBC Playback of VIDEO CDs (page 39), this function is available only while playing moving pictures.

Select "A-B REPEAT" after pressing DISPLAY. During A-B Repeat Play, the "A-B REPEAT" indicator lights up in green.

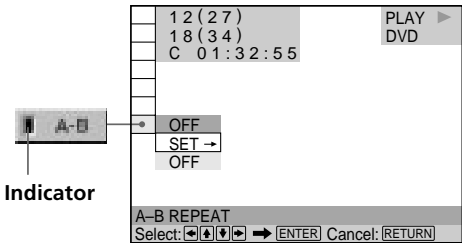

■ A-B REPEAT

The default setting is underlined.

- SET →: sets the A and B points.
- OFF: does not play a specific portion of a title/chapter/track repeatedly.

Setting a portion for A-B repeat

- 1 Select "SET →" in "A-B REPEAT."
The A-B REPEAT setting display appears.

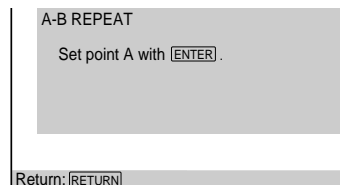
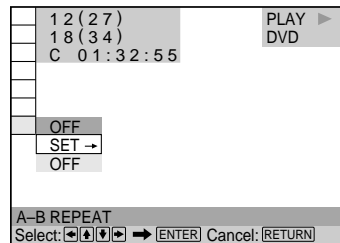

- 2** During playback, when you find the starting point (point A) of the portion to be played repeatedly, press ENTER.

The starting point (point A) is set.

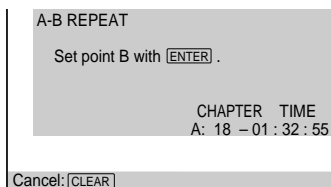

- 3** When you reach the ending point (point B), press ENTER again.
- The set points are displayed and the player starts repeating this specific portion.
- "A-B" appears on the display window during A-B repeat play.

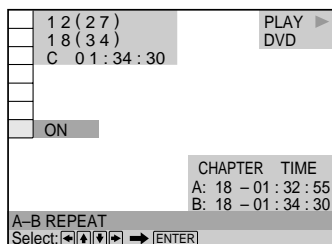

To stop A-B Repeat Play

Press CLEAR on the remote.

Notes

- You can set A-B Repeat for only one specific portion.
- A-B Repeat is canceled when:
 - you open the lid
 - you turn the power off
- When you set A-B Repeat, the settings for Shuffle Play, Repeat Play and Program Play are canceled.
- You may not be able to set A-B Repeat for some DVD or VIDEO CD scenes.

Using the Setup Display DVD VIDEO CD CD

Using the setup display, you can do the initial setup, adjust the picture and sound and set the various outputs. You can also set a language for the subtitles and the setup display, limit playback by children, and so on.

For details on each setup display item, see pages 79 to 93.

Note

You can display the setup display only when the player is in stop mode.

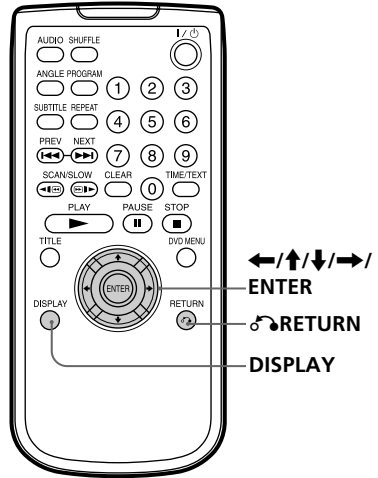
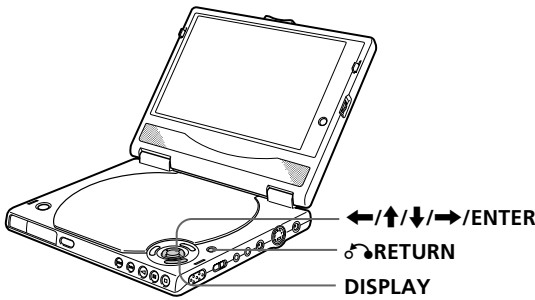

- 1 Press DISPLAY and select "SETUP" using ↑/↓.

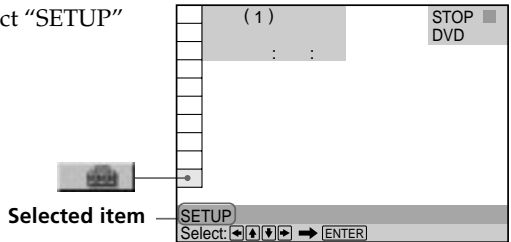

- 2 Press ENTER.
The setup display appears.

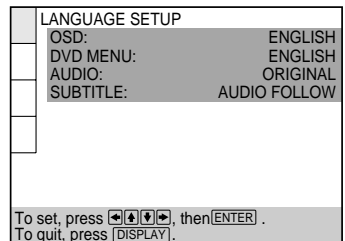

- 3** Select the main item you want using
 ↑/↓.

Main item

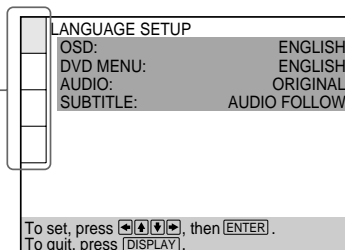

- 4** Press ENTER.
 The selected main item is highlighted.

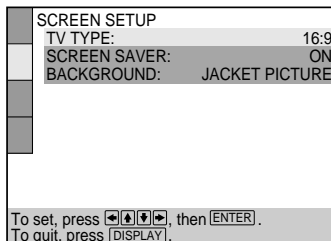

- 5** Select the item you want using
 ↑/↓.

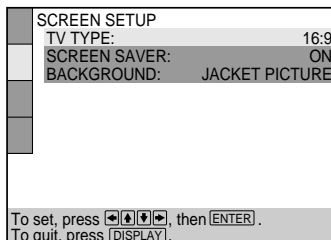

- 6** Press ENTER.

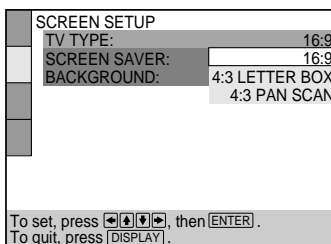

continued

Using the Setup Display (continued)

- 7** Select the setting you want using
←/↑/↓/→.

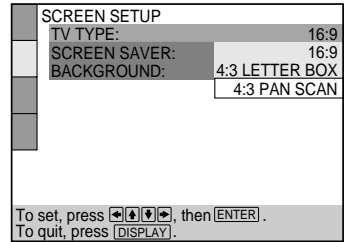

- 8** Press ENTER.

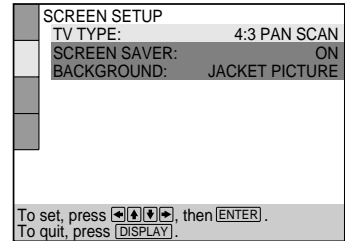

- 9** Press DISPLAY.
The setup display disappears.

- 10** Press DISPLAY repeatedly to turn off the on-screen menu.

To return to the previous screen

Press ⏪ RETURN.

To quit while making a selection

Press DISPLAY.

Note

Some setup display items require operations other than selecting the setting. For details on these items, see the relevant pages.

Setup Display Item List

Default settings are underlined.



LANGUAGE SETUP (page 80)

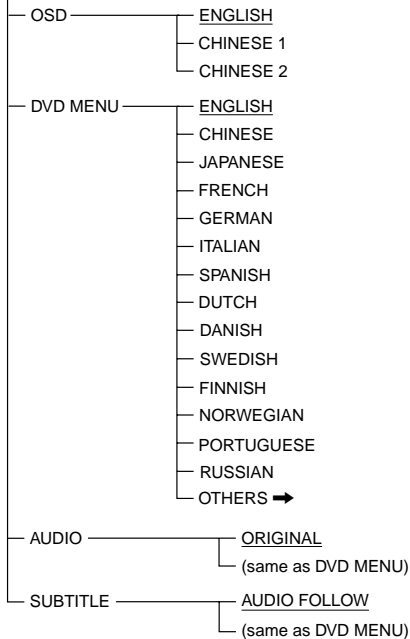

CUSTOM SETUP (page 85)

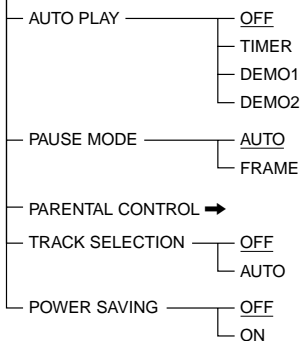

AUDIO SETUP (page 91)

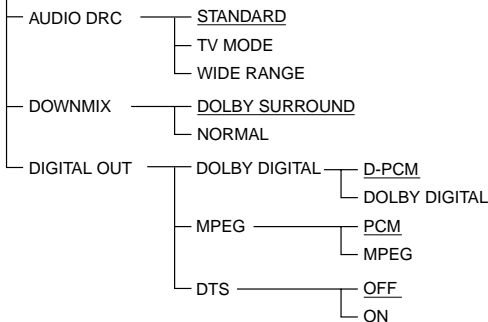

SCREEN SETUP (page 83)

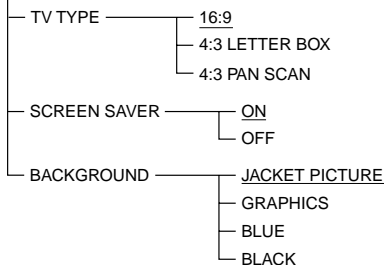

Setting the Display Language or Sound Track (LANGUAGE SETUP)

“LANGUAGE SETUP” allows you to set various languages for the on-screen display or sound track. The default settings are underlined. Select “LANGUAGE SETUP” in the setup display.

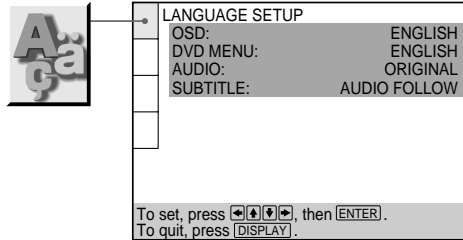

Notes

- When you select a language that is not recorded on the DVD, one of the recorded languages is automatically selected for the “DVD MENU,” “AUDIO” and “SUBTITLE” settings.
- Depending on the DVD, the player may not start playing with the selected language even when you select a language in “DVD MENU,” “AUDIO” or “SUBTITLE.”

■ OSD (On-Screen Display)

Selects the language for the on-screen display.

- ENGLISH
- CHINESE 1
- CHINESE 2

■ DVD MENU

Selects the language for the DVD menu.

- ENGLISH
- CHINESE
- JAPANESE
- FRENCH
- GERMAN
- ITALIAN
- SPANISH
- DUTCH
- DANISH
- SWEDISH
- FINNISH
- NORWEGIAN
- PORTUGUESE
- RUSSIAN
- OTHERS➡

When you select "OTHERS→," select and enter the language code from the list using the number buttons (page 109).
After you have made a selection, the language code (4 digits) is displayed.

■ AUDIO

Selects the language for the sound track.

- ORIGINAL: the language given priority in the disc
- ENGLISH
- CHINESE
- JAPANESE
- FRENCH
- GERMAN
- ITALIAN
- SPANISH
- DUTCH
- DANISH
- SWEDISH
- FINNISH
- NORWEGIAN
- PORTUGUESE
- RUSSIAN
- OTHERS→

When you select "OTHERS→," select and enter the language code from the list using the number buttons (page 109).
After you have made a selection, the language code (4 digits) is displayed.

continued

Setting the Display Language or Sound Track (LANGUAGE SETUP) (continued)

■ SUBTITLE

Selects the language for the subtitles.

- AUDIO FOLLOW*
- ENGLISH
- CHINESE
- JAPANESE
- FRENCH
- GERMAN
- ITALIAN
- SPANISH
- DUTCH
- DANISH
- SWEDISH
- FINNISH
- NORWEGIAN
- PORTUGUESE
- RUSSIAN
- OTHERS➡

When you select "OTHERS➡," select and enter the language code from the list using the number buttons (page 109).

After you have made a selection, the language code (4 digits) is displayed.

- * When you select "AUDIO FOLLOW," the language for the subtitles changes according to the language for the setting you selected in "AUDIO."

Settings for the Display (SCREEN SETUP)

DVD

VIDEO
CD

CD

“SCREEN SETUP” allows you to set the display according to the playback conditions.

The default settings are underlined.

Select “SCREEN SETUP” in the setup display.

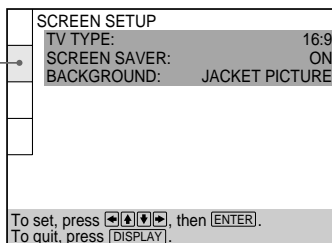
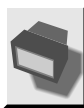

■ TV TYPE

Selects the aspect ratio of the TV to be connected.

- 16:9: select this when you connect a wide-screen TV to the player or when you use the LCD screen of the player.
- 4:3 LETTER BOX: select this when you connect a normal TV to the player. Displays a wide picture with bands on the upper and lower portions of the screen.
- 4:3 PAN SCAN: select this when you connect a normal TV to the player. Displays the wide picture on the whole screen automatically and cuts off the portions that do not fit.

16:9

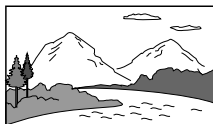

4:3 LETTER BOX



4:3 PAN SCAN

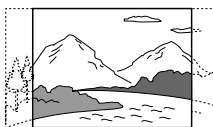

💡 To select the display mode

You can select the display mode of the LCD screen according to the TV TYPE setting. Press DISPLAY MODE on the player repeatedly to select the display mode. For details, see “Selecting the display mode” (page 15).

Note

Depending on the DVD, “4:3 LETTER BOX” may be selected automatically instead of “4:3 PAN SCAN” and vice versa.

continued

Settings for the Display (SCREEN SETUP) (continued)

■ SCREEN SAVER

Turns on and off the screen saver. If you turn on the screen saver, the screen saver image appears when you leave the player or the remote in pause or stop mode for 15 minutes, or when you play back a CD for more than 15 minutes. The screen saver will help prevent your display device from becoming damaged.

- ON: turns on the screen saver.
- OFF: turns off the screen saver.

■ BACKGROUND

Selects the background color or picture on the screen in stop mode or while playing a CD.

- JACKET PICTURE: The jacket picture appears in the background, but only when the jacket picture is already recorded on the disc.
- GRAPHICS: A preset picture stored in the player appears in the background.
- BLUE: The background color is blue.
- BLACK: The background color is black.

Note

If a disc which does not contain the jacket picture is played while "BACKGROUND" is set to "JACKET PICTURE," the picture stored in the player will automatically appear in the background.

Custom Settings (CUSTOM SETUP)

DVD

VIDEO
CD

CD

“CUSTOM SETUP” allows you to set the playback conditions. The default settings are underlined.

Select “CUSTOM SETUP” in the setup display.



CUSTOM SETUP	
AUTO PLAY:	OFF
PAUSE MODE:	AUTO
PARENTAL CONTROL:	→
TRACK SELECTION:	OFF
POWER SAVING:	OFF
To set, press [Left] [Up] [Down] [Right], then [ENTER].	
To quit, press [DISPLAY].	

■ AUTO PLAY

Selects the Auto Play setting when you connect the AC power cord to the AC outlet.

- OFF: does not use “TIMER,” “DEMO1” or “DEMO2” to start playback.
- TIMER: starts playing when the player is turned on, or at any time you want when connected to a timer (not supplied). Before setting the timer, detach the battery pack, connect the AC power adaptor and turn off the player.
- DEMO1: starts playing the first demonstration automatically.
- DEMO2: starts playing the second demonstration automatically.

■ PAUSE MODE (DVD only)

Selects the picture in pause mode.

- AUTO: A picture including subjects that move dynamically is output with no jitter. Normally select this position.
- FRAME: A picture including subjects that do not move dynamically is output with high resolution.

■ PARENTAL CONTROL →

Sets a password and playback limitation level for DVDs with playback limitation for children.

The same password is used for both Parental Control and Custom Parental Control (page 65).

For details, see “Limiting Playback by Children (Parental Control) .”

continued

Limiting Playback by Children (Parental Control)



Playback of some DVDs can be limited depending on the age of the users. The “Parental Control” function allows you to set a playback limitation level.

Select “CUSTOM SETUP” in the setup display.

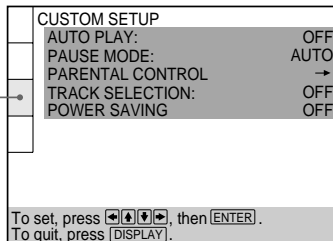

- 1 Select “PARENTAL CONTROL” using ↑/↓, then press ENTER.

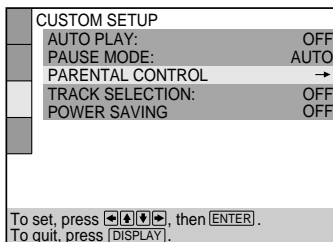

■ When you have not entered a password

The display for entering a password appears.

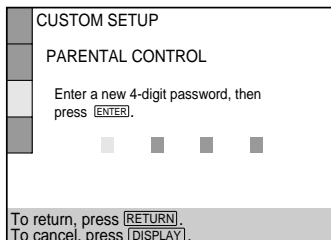

■ When you have already registered a password

The display for confirming the password appears. Skip Step 2.

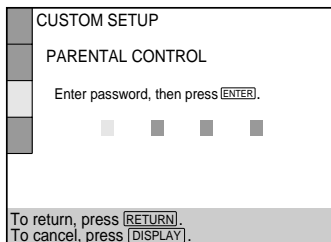

- 2** Enter a password in 4 digits using the number buttons, then press ENTER.

The digits change to asterisks (*), and the display for confirming the password appears.

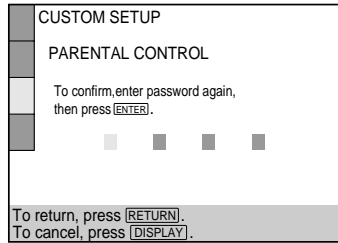

- 3** To confirm your password, enter it again using the number buttons, then press ENTER.

The display for setting the playback limitation level and changing the password appears.

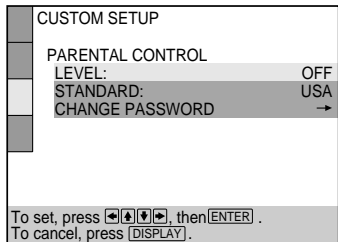

- 4** Select "STANDARD" using ↑/↓, then press →.

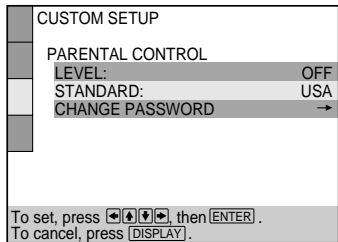

- 5** Select a geographic area as the playback limitation level standard using ↑/↓, then press →.

When you select "OTHERS→," select and enter the standard code in the table on page 89 using the number buttons.

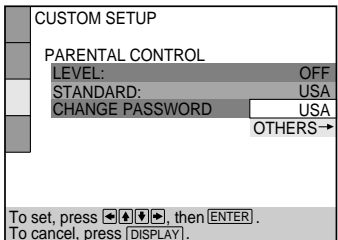

continued

Custom Settings (CUSTOM SETUP) (continued)

- 6 Select "LEVEL" using \uparrow/\downarrow , then press \rightarrow .

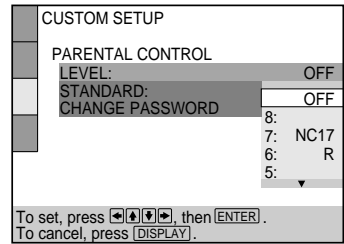

- 7 Select the level you want using \uparrow/\downarrow , then press ENTER.
The lower the value, the more strict the limitation.

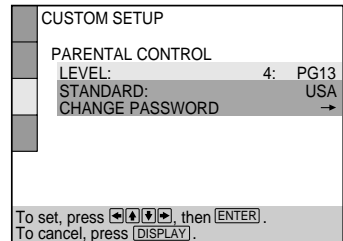

To return to the normal screen

Press DISPLAY.

To turn off the Parental Control function and play the DVD after entering your password

Set "LEVEL" to "OFF" in Step 7, then press \triangleright .

To change the password

- 1 After Step 3, select "CHANGE PASSWORD" using \uparrow/\downarrow , then press \rightarrow or ENTER.

The display for changing the password appears.

- 2 Follow Steps 2 and 3 to enter a new password.

Playing a disc which is blocked by the playback limitation level

- 1 Insert the disc and press \triangleright .

The PARENTAL CONTROL display appears.

- 2 Enter your 4-digit password using the number buttons, then press ENTER.
The player starts playback.

When you stop playing the DVD, the level returns to the original level.

If you forget your password

Enter the 6-digit number "199703" whenever the PARENTAL CONTROL display asks you for your password, then press ENTER. The display will ask you to enter a new 4-digit password.

Notes

- When you play DVDs which do not have the Parental Control function, playback cannot be limited on this player.
- If you do not set a password, you cannot change the settings for playback limitation.
- Depending on the DVD, you may be asked to change the parental control level while playing the disc. In this case, enter your password, then change the level. When you stop playing the DVD, the level returns to the original level.
- The same password is used for both Parental Control and Custom Parental Control (page 65).

Standard	Code number
Argentina	2044
Australia	2047
Austria	2046
Belgium	2057
Brazil	2070
Canada	2079
Chile	2090
China	2092
Denmark	2115
Finland	2165
France	2174
Germany	2109
Hong Kong	2219
India	2248
Indonesia	2238
Italy	2254
Japan	2276

Standard	Code number
Korea	2304
Malaysia	2363
Mexico	2362
Netherlands	2376
New Zealand	2390
Norway	2379
Pakistan	2427
Philippines	2424
Portugal	2436
Russia	2489
Singapore	2501
Spain	2149
Sweden	2499
Switzerland	2086
Taiwan	2543
Thailand	2528
United Kingdom	2184

continued

Custom Settings (CUSTOM SETUP) (continued)

■ TRACK SELECTION

Gives the sound track which contains the highest number of channels priority when you play a DVD on which multiple audio formats (PCM, DTS, MPEG audio or Dolby Digital format) are recorded.

- OFF : No priority given.
- AUTO : Priority given.

Notes

- When you set this item to "AUTO", the language may change depending on the "AUDIO" settings in "LANGUAGE SETUP."
The "TRACK SELECTION" setting has higher priority than the "AUDIO" settings in "LANGUAGE SETUP" (page 81).
- If you select "DIGITAL OUT" in "AUDIO SETUP" and set "DTS" to "OFF," the DTS sound track is not played even if you set this item to "AUTO" and the highest-numbered audio channel is recorded in DTS format.
- If PCM, DTS, MPEG audio and Dolby Digital sound tracks have the same number of channels, the player selects PCM, DTS, Dolby Digital and MPEG audio sound tracks in this order.
- Depending on the DVD, the audio channel with priority may be predetermined. In this case, you cannot give priority to the DTS, MPEG audio or Dolby Digital format by selecting "AUTO."

■ POWER SAVING

Turns on and off the power saving function. If you turn on the power saving function, the brightness of the LCD screen is reduced to conserve the battery life of the battery pack.

- OFF : turns off the power saving function.
- ON : turns on the power saving function. The player can reduce the power consumption by approximately 10 percent.

Note

Even if you set this item to "ON," the display window lights up whenever:

- you set the LINE SELECT switch to "IN" to watch the picture from other equipment
- you turn on the player

Settings for the Sound (AUDIO SETUP)

“AUDIO SETUP” allows you to set the sound according to the playback conditions.

The default settings are underlined.

Select “AUDIO SETUP” in the setup display.



AUDIO SETUP	
AUDIO DRC:	STANDARD
DOWNMIX:	DOLBY SURROUND
DIGITAL OUT	
DOLBY DIGITAL:	D-PCM
MPEG:	PCM
DTS:	OFF

To set, press , then [ENTER].
To quit, press [DISPLAY].

■ AUDIO DRC (Dynamic Range Control)

Makes the sound clear when the volume is turned down when playing a DVD. This function works only when you play a DVD which has the AUDIO DRC function.

This affects the output when:

- you have made the connections using an audio connecting cord
- you have made the connections using an optical digital connecting cord (when you set “DOLBY DIGITAL” to “D-PCM” and “MPEG” to “PCM” in “DIGITAL OUT”)

- STANDARD: Normally select this position.
- TV MODE: makes the low sounds clear even if you turn the volume down. It is especially recommended when you listen to the sound using the speakers of the TV.
- WIDE RANGE: It gives you the feeling of being at a live performance. When you use high quality speakers, it is more effective.

Note

When you play DVDs without the AUDIO DRC function, there may be no effect on the sound.

continued

Settings for the Sound (AUDIO SETUP) (continued)

■ DOWNMIX

Switches the mixing down methods when you play a DVD on which rear signal components such as LS, RS or S are recorded in Dolby Digital format. For details on the rear signal components, see "Displaying the audio information of the disc" (page 55).

This affects the output when:

- you have made the connections using an audio connecting cord
- you have made the connections using an optical digital connecting cord (when you set "DOLBY DIGITAL" to "D-PCM" in "DIGITAL OUT")
- **DOLBY SURROUND:** when the player is connected to an audio component that conforms to Dolby Surround (Pro Logic). The output signals which reproduce the Dolby Surround (Pro Logic) effect are mixed down to 2 channels.
- **NORMAL:** when the player is connected to an audio component that does not conform to Dolby Surround (Pro Logic). The signal without the Dolby Surround (Pro Logic) effect are output.

Setting the digital output signal (DIGITAL OUT)

Switches the methods of outputting audio signals when you connect 1. a digital component such as a receiver (amplifier) having a digital connector, 2. an audio component having a built-in decoder (Dolby Digital, MPEG or DTS), 3. a DAT or MD using an optical digital connecting cord. For connection details, see pages 19 and 22.

Note

When you have made the connections using an optical digital connecting cord and play sound tracks with a 96 kHz sampling frequency, the output signals are converted to 48 kHz (sampling frequency). When you have made the connections using an audio connecting cord, sampling frequency stays at 96 kHz and the output signals are converted to analog signals.

■ DOLBY DIGITAL

Selects the Dolby Digital signals to be output when you have made the connections using an optical digital connecting cord.

- **D-PCM** (Downmix PCM): when you play Dolby Digital sound tracks, the output audio signals are mixed down to 2 channels. You can select whether the signals conform to Dolby Surround (Pro Logic) or not by making adjustments to the "DOWNMIX" item in "AUDIO SETUP."
- **DOLBY DIGITAL:** when the player is connected to an audio component with a built-in Dolby Digital decoder.

If the player is connected to an audio component lacking a built-in Dolby Digital decoder, do not set this. Otherwise, when you play the Dolby Digital sound track, a loud noise or no sound will come out from the speakers, affecting your ears or causing the speakers to be damaged.

Note

When you select "D-PCM," set Virtual Enhanced Surround (VES) to "OFF." Otherwise, the player will not output signals when you have made the connections using an optical digital connecting cord.

■ MPEG

Selects the MPEG audio signals to be output when you have made the connections using an optical digital connecting cord.

- PCM: when the player is connected to an audio component lacking a built-in MPEG decoder. If you play MPEG audio sound tracks, the player outputs stereo signals when you have made the connections using an optical digital connecting cord.
- MPEG: when the player is connected to an audio component having a built-in MPEG decoder.

If the player is connected to an audio component lacking a built-in MPEG decoder, do not set this. Otherwise, when you play the MPEG audio sound track, a loud noise will come out from the speakers, affecting your ears or causing the speakers to be damaged.

■ DTS

Selects the DTS signals to be output when you have made the connections using an optical digital connecting cord.

- OFF: when the player is connected to an audio component lacking a built-in DTS decoder.
- ON: when the player is connected to an audio component having a built-in DTS decoder.

If the player is connected to an audio component lacking a built-in DTS decoder, do not set this. Otherwise, when you play the DTS sound track, a loud noise will come out from the speakers, affecting your ears or causing the speakers to be damaged.

continued

Preventing the Buttons from being Pressed Accidentally

You can prevent the buttons from being pressed accidentally on this player (when carrying, for example). After setting the HOLD switch to on, the buttons are locked. (You can still use the remote to operate the player.)

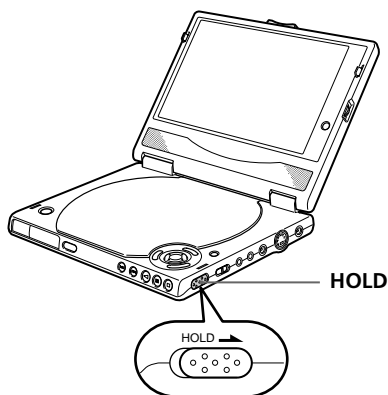

Slide HOLD in the direction of the arrow.

The buttons are locked.

If you press the buttons, "Hold" appears on the display window.

To cancel the Hold function

Slide HOLD back.

Listening with Headphones

You can enjoy the audio sound through headphones (not supplied) by connecting them to the PHONES jack. Turn VOL to adjust the volume.

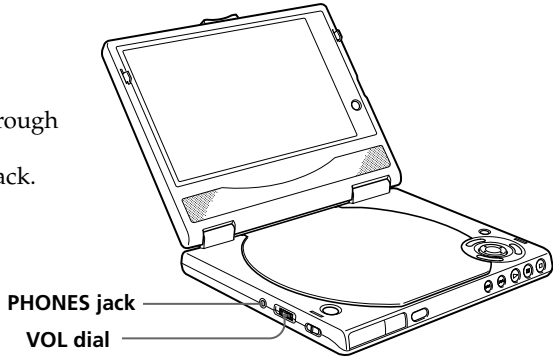

Before starting playback

Adjust the sound volume to MIN (lowest level), then press **▶** and turn up the volume little by little.

Using the headphone surround function

Even if you listen to the sound through headphones, the headphone surround function gives the sound a 3D surround effect for a more realistic listening experience. The headphone surround function uses the SRS HEADPHONE* technology.

Set HP SURROUND to ON to turn on the headphone surround function.

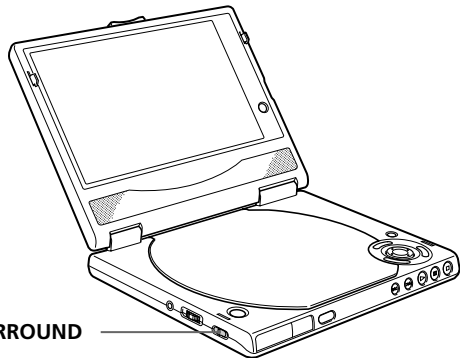

Notes

- You cannot use the headphone surround function and Virtual Enhanced Surround (VES) at the same time. When you turn on the headphone surround function, "VES" is automatically set to "OFF" (page 60).
- The sound may be interrupted for a moment when you switch HP SURROUND on or off.
- Depending on the disc, the headphone surround function may not work properly.

* SRS HEADPHONE and the  symbol are trademarks of SRS Labs, Inc. in the United States and selected foreign countries. SRS HEADPHONE technology is incorporated under license from SRS Labs, Inc.

Watching the Picture without Connecting Cables — LASER LINK

If you use the LASER LINK* function, you can easily view the picture on your TV without connecting cables. LASER LINK is a system which transmits and receives pictures and sound between LASER LINK compatible video equipment by using infrared rays.

To enjoy the LASER LINK function, the following accessories are needed:

- AV cordless IR transmitter IFV-FX1 (not supplied)
- AV cordless IR receiver IFT-R10/IFT-R20, etc. (not supplied)

*  LASER LINK is a trademark of Sony Corporation.

Hookups

- 1 Connect the IFV-FX1 AV cordless IR transmitter (not supplied) to the player.

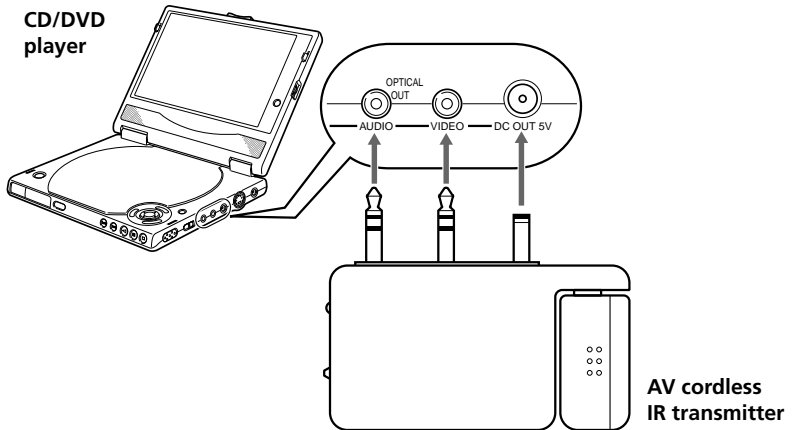

- 2 Connect the AV cordless IR receiver (ex. IFT-R10/IFT-R20, not supplied) to your TV.

For details, refer to the operating instructions of the receiver.

Operation

- 1 Turn on the TV and select the video input.
- 2 Turn on the AV cordless IR receiver.
- 3 Set the LINE SELECT switch on the player to OUT.
- 4 Press POWER to turn on the player.
- 5 Set the POWER switch on the AV cordless IR transmitter to ON.
The POWER indicator lights up.

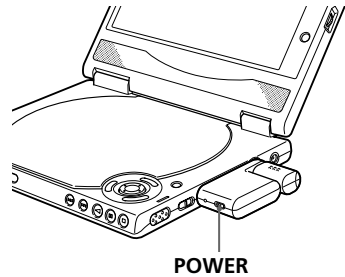

- 6 Adjust the angle and direction of the AV cordless IR transmitter to match the AV cordless IR receiver.
Place the player directly in front of the TV within the range specified on the right.

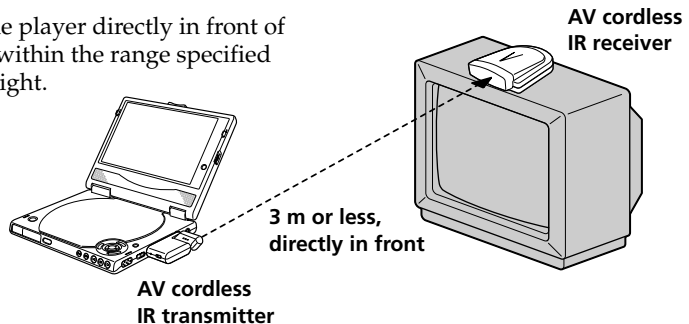

- 7 Start playback on the player.
- 8 Adjust the distance and angle between the AV cordless IR transmitter and the AV cordless IR receiver so that the playback picture appears clearly on the TV.

To turn off the equipment

Be sure to turn off the AV cordless IR transmitter before you turn off the player.

Notes

- Do not cover the AV cordless IR transmitter and the AV cordless IR receiver with your hands or other objects.
- Infrared rays cannot pass through walls or opaque glass. Be sure to place the player in an unobstructed position. Using LASER LINK through glass will shorten the transmission range.
- Do not place the player too close to the TV, as this may cause noise and/or beat.
- When using the battery pack, picture or sound noise may appear or the transmission range may be shortened if the battery power is low. Use the AC power adaptor or charge the battery pack.

Watching the Picture of Other Equipment on the LCD Screen

You can watch the picture of other connected equipment, such as a video camera on the LCD screen.

Be sure to set the LINE SELECT switch on the player to IN.

CD/DVD player



Set LINE SELECT to IN

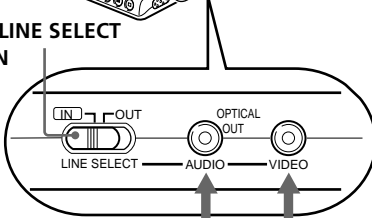

To AUDIO

To VIDEO

 : Signal flow

To VIDEO output

To AUDIO output

Other equipment

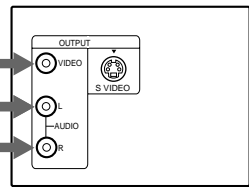

You can select the color system of the LCD screen

When LINE SELECT is set to IN, you can select the color system of the LCD screen (NTSC or PAL) according to the input signal.

Press DISPLAY on the player for more than two seconds.

When the color system is set to NTSC, "NTSC" appears on the display window.

When the color system is set to PAL, "NTSC" disappears.

Note

When LINE SELECT is set to IN, you cannot play discs on the player.

Troubleshooting

If you experience any of the following difficulties while using the player, use this troubleshooting guide to help remedy the problem. Should any problem persist, consult your nearest Sony dealer.

	Symptom	Remedy
Power	The power is not turned on.	<ul style="list-style-type: none"> • Check that the AC power cord is connected securely. • When using the battery pack, check the remaining battery life. • Make sure you use the supplied AC power adaptor. (Do not use any other AC power adaptor.) • Check that the HOLD switch is set to off. • Disconnect the AC power adaptor from this player for more than 10 minutes. Then connect the AC power adaptor and turn the power on again. If the power is still not turned on, disconnect the AC power adaptor and the battery pack and refer to your nearest Sony dealer.
	The power is turned off automatically.	<ul style="list-style-type: none"> • The Auto Power Off function is activated. (If you do not operate the player or the remote for more than 30 minutes when a disc is not being played, the power will be automatically turned off.) Press POWER on the player to turn the power on. • Batteries are depleted. Recharge the battery pack.
Picture	There is no picture.	<ul style="list-style-type: none"> • The LINE SELECT switch is set to IN. Set it to OUT. • Check that the player is connected securely. • The video connecting cord is damaged. Replace it with a new one. • Use only the supplied video connecting cord. • Make sure you connect the player to the video input connector on the TV (page 17). • Make sure you turn on the TV. • Make sure you select the video input on the TV so that you can view the pictures from the player. • The display mode is set to off. Press DISPLAY MODE to change the display mode. • Clean the disc. • If the video signal from your DVD player has to go through your VCR to get to your TV, the copy-protection applied to some DVD programs could affect picture quality. If you still experience problems after checking your connections, please try connecting your DVD player directly to your TV's S-video input, if your TV is equipped with this input (page 17).

continued

Troubleshooting (continued)

	Symptom	Remedy
Picture	Picture noise appears.	<ul style="list-style-type: none"> • Check that this player is placed in a horizontal position and there is no mechanical vibration or shock. • There is a flaw on the disc. • When you watch the picture of other equipment using the LCD screen, the picture noise may appear if the color system of the input signal is different from that of the LCD screen. Change the color system of the LCD screen by pressing DISPLAY on the player for more than two seconds (page 98). • Picture noise may appear when you use the LASER LINK function. Use the supplied audio/video connecting cord to get a clear picture.
	Even though you set the aspect ratio in "TV TYPE" in "SCREEN SETUP" of the setup display, the picture does not fill the screen.	<ul style="list-style-type: none"> • The aspect ratio is fixed on your DVD.
	The picture is black and white.	<ul style="list-style-type: none"> • Depending on the TV, the picture on the screen becomes black and white when you play a disc recorded in the PAL color system.
	The VIDEO CD menu does not appear.	<ul style="list-style-type: none"> • Make sure you play a VIDEO CD with PBC functions. • Make sure you follow the instructions for interactive operations. Refer to the instructions supplied with the disc.
	There is no sound.	<ul style="list-style-type: none"> • Check that the player is connected securely. • The audio connecting cord is damaged. Replace it with a new one. • Make sure you connect the player to the audio input connectors on the receiver (amplifier) (page 20). • Make sure you turn on the TV and the receiver (amplifier). • Make sure you select the appropriate input on the receiver (amplifier) so that you can listen to the sound from the player. • The player is in pause mode or in Slow-motion Play mode. Press ▷ to return to normal play mode. • The player is in fast forward or fast reverse mode. Press ▷ to return to normal play mode. • Check the speaker connections (page 23). Refer to the operating manual of your receiver (amplifier). • You selected a VES mode other than "OFF" in the Control Menu display when you connected the component using the optical digital connecting cord. Set "VES" to "OFF" in the Control Menu display (page 60).
Sound		

	Symptom	Remedy
Sound	There is no sound.	<ul style="list-style-type: none"> When you have made the connections using an audio connecting cord and play DTS sound tracks, no sound will come out (page 31). Check that the headphones plug connected to the headphones jack is firmly connected to this player. Check that the VOL dial is not set to "MIN." When you close the LCD panel, no sound will come out from the built-in speakers.
	Sound is noisy.	<ul style="list-style-type: none"> Clean the disc. There is a flaw on the disc. When you have made the connections using an audio connecting cord and play a CD with DTS sound tracks, sound noise will come out (page 31). Check that this player is placed in a horizontal position and there is no mechanical vibration or shock.
	The sound loses its stereo effect when you play a VIDEO CD or a CD.	<ul style="list-style-type: none"> Set "AUDIO" to "STEREO" in the Control Menu display (page 54). Make sure you connect the player correctly (pages 17, 20, 23).
	The surround effect is difficult to hear when you are playing a Dolby Digital or MPEG sound track.	<ul style="list-style-type: none"> Check the speaker connections (page 23). Refer to the operating manual of your receiver (amplifier). Depending on the DVD, the output signal may not be the entire 5.1 channels. It may be monaural or stereo even if the sound track is recorded in Dolby Digital or MPEG format.
Operation	The remote does not function.	<ul style="list-style-type: none"> Remove any obstacles between the remote and the player. Use the remote near the player. Point the remote at the remote sensor  on the player. Replace all of the batteries in the remote with new ones if they are weak. When using the battery pack, press POWER on the player to turn on it. When using the battery pack and 10 minutes have passed after turning off the player, you cannot turn on the player with the remote. Make sure you use the supplied remote.

continued

Troubleshooting (continued)

Symptom	Remedy
The disc does not play.	<ul style="list-style-type: none"> • There is no disc inside (“Insert disc.” appears on the screen). Insert a disc. • Insert the disc correctly with the playback side facing down. • Clean the disc. • There is a flaw on the disc. • The player cannot play CD-ROMs, etc (page 7). Insert a DVD, a VIDEO CD, or CD. • Check the region code of the DVD (page 6). • Moisture has condensed inside the player. Remove the disc and leave the player turned on for about half an hour (page 10). • Check that the player is placed in a horizontal position. • The buttons on the player are locked. Slide HOLD back to the off position. • The LINE SELECT switch is set to IN. Set it to OUT.
Operation VES (Virtual Enhanced Surround) does not function.	<ul style="list-style-type: none"> • The headphone surround function is turned on. Set HP SURROUND to OFF.
The player does not play from the beginning when playing a disc.	<ul style="list-style-type: none"> • Repeat Play, Shuffle Play or Program Play has been selected. Press CLEAR (pages 68 through 73). • Resume Play has been selected. Press ■ on the player or on the remote before you start playing (page 35). • A title menu or a DVD menu automatically appears on the TV screen when you play your DVD, or a setup display automatically appears on the TV screen when you play your VIDEO CD with PBC functions.
The player starts playing the disc automatically.	<ul style="list-style-type: none"> • The DVD features the auto playback function. • “AUTO PLAY” in “CUSTOM SETUP” is set to “TIMER.” (page 85)
Playback stops automatically.	<ul style="list-style-type: none"> • The disc may contain an auto pause signal. While playing such a disc, the player stops playback at the signal. • There is a flaw on the disc.
You cannot perform some functions such as Stop, Search, Slow-motion Play, Repeat Play, Shuffle Play or Program Play.	<ul style="list-style-type: none"> • Depending on the disc, you may not be able to do some of these operations.

Symptom	Remedy
Messages do not appear on the screen in the language you want.	<ul style="list-style-type: none"> In the setup display, select the desired language for the on-screen display in "OSD" under "LANGUAGE SETUP" (page 80).
The language for the sound track cannot be changed when you play a DVD.	<ul style="list-style-type: none"> Multilingual tracks are not recorded on the DVD. Changing the language for the track is prohibited on the DVD.
The subtitle language cannot be changed when you play a DVD.	<ul style="list-style-type: none"> Multilingual subtitles are not recorded on the DVD. Changing the language for the subtitles is prohibited on the DVD.
The subtitles cannot be turned off when you play a DVD.	<ul style="list-style-type: none"> Depending on the DVD, you may not be able to turn the subtitles off.
The angles cannot be changed when you play a DVD.	<ul style="list-style-type: none"> Multi-angles are not recorded on the DVD. Changing the angles is prohibited on the DVD.
The player does not operate properly.	<ul style="list-style-type: none"> Static electricity, etc., may affect the player's operation. Disconnect the AC power cord once, then connect it again. When using the battery pack, detach it once and attach it again.
"Lo dc In" appears on the display window.	<ul style="list-style-type: none"> When using the battery pack, the AC power adaptor is not connected to an AC outlet even if the AC power adaptor is connected to the player. Disconnect the AC power adaptor from the player. Check that the AC power adaptor is connected to an AC outlet, then disconnect from this player and connect again. Use only the supplied AC power adaptor.
"H l dc In" appears on the display window.	<ul style="list-style-type: none"> Use only the supplied AC power adaptor.
"H l b d t t" appears on the display window.	<ul style="list-style-type: none"> There may be a problem with the battery pack. Detach it and consult your nearest Sony dealer.
"□" flashes on the display window while charging the battery pack.	<ul style="list-style-type: none"> There may be a problem with charging. Disconnect the AC power adaptor and detach the battery pack. Then attach the battery pack and connect the AC power adapter to start charging again. If "□" still flashes, consult your nearest Sony dealer.
"H t t E M P" appears and "□" flashes on the display window.	<ul style="list-style-type: none"> The player and the battery pack unusually heat up while charging. Charge the battery pack at a temperature between 5 °C to 35 °C.
"d c o u t" appears on the display window.	<ul style="list-style-type: none"> There may be a problem with the AV cordless IR transmitter. Detach it and consult your nearest Sony dealer.
5 numbers or letters are displayed on the screen and on the display window.	<ul style="list-style-type: none"> The self diagnosis function was activated. See the table on page 104.

Self-diagnosis Function

When the self-diagnosis function activates to prevent the player from malfunctioning, a five-character service number (combination of a letter and digits) flashes on the screen and on the display window. In this case, check the following table.

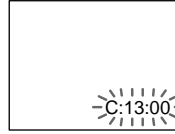

First three characters	Cause and/or Corrective Action
C13	<ul style="list-style-type: none">• The disc is dirty. ➔ Clean the disc with a cleaning cloth (page 12).
C31	<ul style="list-style-type: none">• The player cannot play the disc. ➔ Make sure that the disc is compatible (page 6).
Exx (xx is any number)	<ul style="list-style-type: none">• To prevent a malfunction, the player has performed the self-diagnosis function. ➔ When you contact your Sony dealer or local authorized Sony service facility, give the 5-character service number. (example: E:61:10)

Specifications

CD/DVD player

Laser
Semiconductor laser
Signal format system
NTSC/PAL

Audio characteristics

Frequency response
DVD (PCM 96 kHz): 4 Hz to 44 kHz (± 1 dB)*
DVD (PCM 48 kHz): 4 Hz to 22 kHz (± 0.5 dB)*
CD: 4 Hz to 20 kHz (± 0.5 dB)*
Signal-to-noise ratio
More than 115 dB*
(AUDIO OUT connectors only)
Harmonic distortion
Less than 0.005 %*
Dynamic range
More than 99 dB* (DVD)
More than 98 dB* (CD)
Wow and flutter
Less than detected value*
(± 0.001 % W PEAK)
Speaker output level
More than 1 W + 1 W

* The signals from AUDIO OUT connectors are measured. When you play PCM sound tracks with a 96 kHz sampling frequency, the output signals from the OPTICAL OUT are converted to 48 kHz (sampling frequency).

General

Power requirements
Power supply jack
DC IN 10V jack accepts the AC-FX1 AC power adaptor (supplied),
100-240V AC, 50/60 Hz
Battery pack
Power consumption
10 W (DVD VIDEO playback with the LCD screen turned on)
0.1 W (standby)
Dimensions (approx.)
189 × 26.1 × 137 mm(w/h/d)
incl. projecting parts
Mass (approx.)
641 g
Operating temperature
5 °C to 35 °C
Operating humidity
5% to 80%

Outputs and inputs

	Jack type	Output level	Input level	Load impedance
AUDIO	Stereo mini jack	2 Vrms (at 50 kilohms)	2 Vrms	Over 10 kilohms
OPTICAL OUT	Optical output connector	-18 dBm		Wave length: 660 nm
VIDEO	Mini jack	1.0 Vp-p	1.0 Vp-p	75 ohms, sync negative
S VIDEO OUT	4-pin mini DIN	Y: 1.0 Vp-p C: 0.286 Vp-p (NTSC) 0.3 Vp-p (PAL)		75 ohms, sync negative 75 ohms terminated
PHONES	Stereo mini jack	12 mW + 12 mW		32 ohms

continued

Specifications (continued)

Supplied accessories

See page 13.

Optional accessories

- Battery pack
NP-FX1
- AV cordless IR transmitter
IFV-FX1
- Optical digital connecting cord
POC-15B/15AB
- AV cordless IR receiver
IFT-R10/R20

Some accessories may not be available depending on the area.

Design and specifications are subject to change without notice.

Glossary

Bit rate (page 64)

Value indicating the amount of video data compressed in a DVD per second. The unit is Mbps (Mega bit per second). 1 Mbps indicates that the data per second is 1,000,000 bits. The higher the bit rate, the larger the amount of data. However, this does not always mean that you can get higher quality pictures.

Chapter (page 7)

Sections of a picture or a music piece on a DVD that are smaller than titles. A title is composed of several chapters. Each chapter is assigned a chapter number enabling you to locate the chapter you want.

Digital Cinema Sound (DCS) (page 60)

The general name of technology that Sony developed to enjoy surround sound in a home. It simulates the sound of a movie editing studio instead of the usual concert hall so that you can enjoy the surround sound of a movie theater in the comfort of your own home. The VES (Virtual Enhanced Surround) system contained in DCS programs can create the sound image of virtual rear speakers from the sound of the front speakers (L, R) without using actual rear speakers.

Dolby Digital (pages 22, 93)

Digital audio compression technology developed by Dolby Laboratories. This technology conforms to 5.1-channel surround sound. The rear channel is stereo and there is a discrete subwoofer channel in this format. Dolby Digital provides the same 5.1 discrete channels of high quality digital audio found in Dolby Digital cinema audio systems. Good channel separation is realized because all of the channel data is recorded discretely and processed in digital.

Dolby Pro Logic (page 92)

Audio signal processing technology that Dolby Laboratories developed for surround sound. When the input signal contains a surround component, the Pro Logic process outputs the front, center and rear signals. The rear channel is monaural.

DTS (page 8, 93)

Digital audio compression technology that Digital Theater Systems, Inc. developed. This technology conforms to 5.1-channel surround. The rear channel is stereo and there is a discrete subwoofer channel in this format. DTS provides the same 5.1 discrete channels of high quality digital audio. Good channel separation is realized because all of the channel data is recorded discretely and processed in digital.

DVD (page 6)

A disc that contains up to 8 hours of moving pictures even though its diameter is the same as a CD.

The data capacity of a single-layer and single-sided DVD is 4.7 GB (Giga Byte) which is 7 times that of a CD. The data capacity of a dual-layer and single-sided DVD is 8.5 GB, a single-layer and double-sided DVD is 9.4 GB, and a dual-layer and double-sided DVD is 17 GB.

The picture data uses the MPEG 2 format, one of the worldwide standards of digital compression technology. The picture data is compressed to about 1/40 of its original size. The DVD also uses a variable rate coding technology that changes the data to be allocated according to the status of the picture.

continued

Glossary (continued)

Audio data is recorded in Dolby Digital as well as in PCM, allowing you to enjoy a more real audio presence.

Furthermore, various advanced functions such as the multi-angle, multilingual, and Parental Control functions are provided with the DVD.

MPEG audio (page 93)

International standard coding system used to compress audio digital signals authorized by ISO/IEC. MPEG 1 conforms to up to 2-channel stereo. MPEG 2 used on DVDs conforms to up to 7.1-channel surround.

Multi-angle function (page 58)

Various angles for the scene (viewpoints of the video camera) are recorded on some DVDs.

Multilingual function (pages 28, 57, 80)

Several languages for the audio track or sub-titles in a picture are recorded on some DVDs.

Parental Control (page 85)

A function of the DVD used to limit playback of the disc according to the age of the user and the limitation level in each country. The limitation varies from disc to disc; when it is activated, playback is completely prohibited, violent scenes are skipped or replaced with other scenes, and so on.

Playback Control (PBC) (page 39)

Signals encoded on VIDEO CDs (Version 2.0) to control playback.

By using menus recorded on VIDEO CDs with PBC functions, you can enjoy playing simple interactive programs, programs with search functions, and so on.

Title (page 7)

The longest section of a picture or a music piece on a DVD; a movie, etc., for a picture piece on video software; or an album, etc., for a music piece on audio software. Each title is assigned a title number enabling you to locate the title you want.

Track (page 7)

Sections of a picture or a music piece on a CD or VIDEO CD. Each track is assigned a track number enabling you to locate the track you want.

VIDEO CD (page 6)

A compact disc that contains moving pictures.

The picture data uses the MPEG 1 format, one of the worldwide standards of digital compression technology. The picture data is compressed to about 1/140 of its original size. Consequently, a 12 cm VIDEO CD can contain up to 74 minutes of moving pictures.

VIDEO CDs also contain compact audio data. Sounds outside the range of human hearing are compressed while the sounds we can hear are not compressed. VIDEO CDs can hold 6 times the audio information of conventional audio CDs.

There are 2 versions of VIDEO CDs.

- Version 1.1: You can play only moving pictures and sounds.
- Version 2.0: You can play high-resolution still pictures and enjoy PBC functions.

This player conforms to both versions.

Language Code List

For details, see pages 54, 57 and 81.

The language spellings conform to the ISO 639: 1988 (E/F) standard.

Code	Language	Code	Language	Code	Language
1027	Afar	1151	Basque	1297	Kazakh
1028	Abkhazian	1157	Persian	1298	Greenlandic
1032	Afrikaans	1165	Finnish	1299	Cambodian
1039	Amharic	1166	Fiji	1300	Kannada
1044	Arabic	1171	Faroese	1301	Korean
1045	Assamese	1174	French	1305	Kashmiri
1051	Aymara	1181	Frisian	1307	Kurdish
1052	Azerbaijani	1183	Irish	1311	Kirghiz
1053	Bashkir	1186	Scots Gaelic	1313	Latin
1057	Byelorussian	1194	Galician	1326	Lingala
1059	Bulgarian	1196	Guarani	1327	Laothian
1060	Bihari	1203	Gujarati	1332	Lithuanian
1061	Bislama	1209	Hausa	1334	Latvian; Lettish
1066	Bengali; Bangla	1217	Hindi	1345	Malagasy
1067	Tibetan	1226	Croatian	1347	Maori
1070	Breton	1229	Hungarian	1349	Macedonian
1079	Catalan	1233	Armenian	1350	Malayalam
1093	Corsican	1235	Interlingua	1352	Mongolian
1097	Czech	1239	Interlingue	1353	Moldavian
1103	Welsh	1245	Inupiak	1356	Marathi
1105	Danish	1248	Indonesian	1357	Malay
1109	German	1253	Icelandic	1358	Maltese
1130	Bhutani	1254	Italian	1363	Burmese
1142	Greek	1257	Hebrew	1365	Nauru
1144	English	1261	Japanese	1369	Nepali
1145	Esperanto	1269	Yiddish	1376	Dutch
1149	Spanish	1283	Javanese	1379	Norwegian
1150	Estonian	1287	Georgian	1393	Occitan

continued

Language Code List (continued)

Code	Language	Code	Language	Code	Language
1403	(Afan) Oromo	1506	Slovenian	1535	Tonga
1408	Oriya	1507	Samoaan	1538	Turkish
1417	Punjabi	1508	Shona	1539	Tsonga
1428	Polish	1509	Somali	1540	Tatar
1435	Pashto; Pushto	1511	Albanian	1543	Twi
1436	Portuguese	1512	Serbian	1557	Ukrainian
1463	Quechua	1513	Siswati	1564	Urdu
1481	Rhaeto-Romance	1514	Sesotho	1572	Uzbek
1482	Kirundi	1515	Sundanese	1581	Vietnamese
1483	Romanian	1516	Swedish	1587	Volapük
1489	Russian	1517	Swahili	1613	Wolof
1491	Kinyarwanda	1521	Tamil	1632	Xhosa
1495	Sanskrit	1525	Telugu	1665	Yoruba
1498	Sindhi	1527	Tajik	1684	Chinese
1501	Sangho	1528	Thai	1697	Zulu
1502	Serbo-Croatian	1529	Tigrinya	1703	Not specified
1503	Singhalese	1531	Turkmen		
1505	Slovak	1532	Tagalog		

Index to Parts and Controls

Refer to the pages indicated in parentheses for details.

Console

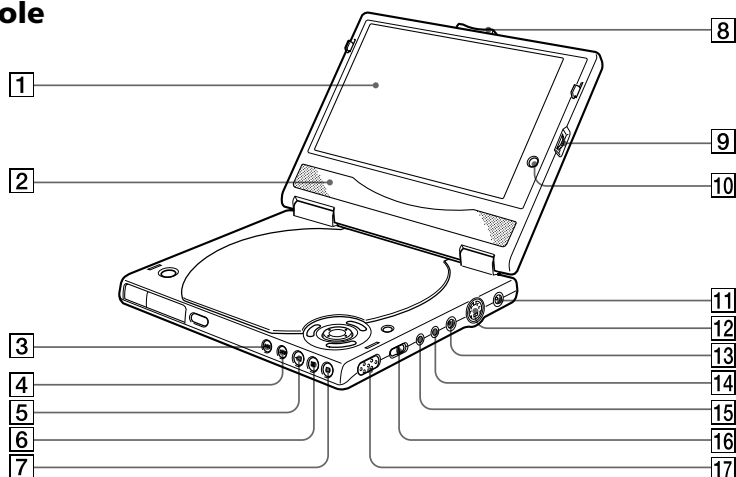

1 LCD screen (14)

Displays the playback picture, etc.

2 Speaker (15)

Emits the sound.

3 ◀◀ PREV button (32)

Press to go back to the previous chapter or track.

4 ▶▶ NEXT button (32)

Press to go to the next chapter or track.

5 ▷ PLAY button (31)

Plays a disc.

6 || PAUSE button (32)

Pauses playing a disc.

7 ■ STOP button (32, 35)

Stops playing a disc.

8 PUSH OPEN button (14)

Press to lift open the LCD panel.

9 BRIGHT dial (14)

Adjusts the brightness of the LCD screen.

10 DISPLAY MODE button (15)

Changes the display mode of the LCD screen.

11 DC IN 10V connector (25)

Connect to the AC power adaptor.

12 S VIDEO OUT connector (17, 20)

Connect to the S video input connector on your TV or monitor.

13 DC OUT 5V connector (96)

Connect the DC IN 5V connector of another component requiring a power source.

14 VIDEO IN/OUT connector (17, 98)

Connect to the video input/output connector on your TV or monitor.

15 AUDIO IN/OUT / OPTICAL OUT connector (17, 20, 23, 98)

Connect to the audio input/output connector on your TV or receiver (amplifier), or connect to an audio component using an optical digital connecting cord.

16 LINE SELECT switch (17, 20, 98)

Switches input/output of the VIDEO and AUDIO connectors.

17 HOLD switch (94)

Turns on and off the hold function.

Index to Parts and Controls (continued)

Console

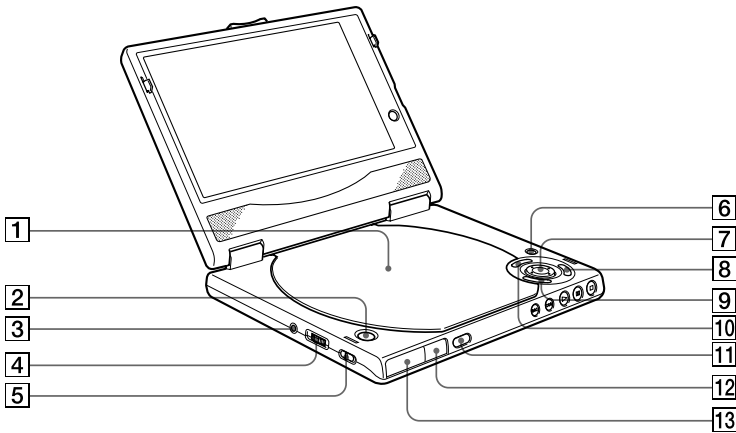

1 Lid (30)

2 OPEN button (30)

Opens the lid.

3 PHONES connector (95)

Connect the headphones.

4 VOL dial (95)

Adjusts the volume of the built-in speakers and the headphones.

5 HP SURROUND switch (95)

Turns on and off the headphone surround function.

6 ↶RETURN button (39, 46)

Press to return to the previously selected screen, etc.

7 ←/↑/↓/→/ENTER button

Selects and executes the items or settings.

8 DISPLAY button (45)

Displays the Control Menu display on the screen to set or adjust the Control Menu items.

9 TITLE button (37)

Displays the title menu on the screen.

10 DVD MENU button (38)

Displays the DVD menu on the screen.

11 POWER button (30)

Turns on and off the power of the player.

12  (remote sensor) (13)

Accepts the remote control signals.

13  Display window (41)

Indicates the playing time, etc.

Bottom

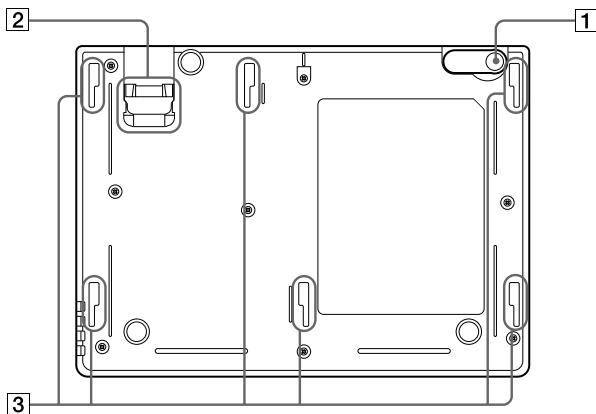

1 Stabilizer tab (14)

Pull out to prevent the player from tipping over when using the LCD screen.

2 Battery terminals (9)

3 Slots for the battery (9)

Index to Parts and Controls (continued)

Remote commander

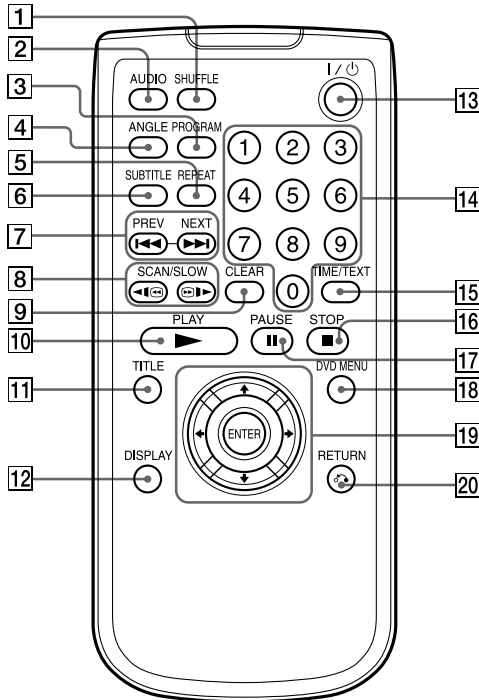

1 SHUFFLE button (72)

Changes the "SHUFFLE" mode.

2 AUDIO button (54)

Changes the sound while playing a DVD or VIDEO CD.

3 PROGRAM button (68)

Displays the "PROGRAM" display on the screen.

4 ANGLE button (59)

Changes the angles when playing a DVD.

5 REPEAT button (73)

Changes the "REPEAT" mode.

6 SUBTITLE button (57)

Changes the subtitles when playing a DVD.

7 << / >> PREV/NEXT buttons (32)

Press to go to the next chapter or track, or to go back to the previous chapter or track.

8 << / >> SCAN/SLOW buttons (34)

Locate a point quickly while monitoring the picture or play a disc in slow motion.

9 CLEAR button (70, 72, 73, 75)

Press to return to continuous play etc.

-
- 10 ▷PLAY button (31)**
Plays a disc.
- 11 TITLE button (37)**
Displays the title menu on the screen.
- 12 DISPLAY button (45)**
Displays the Control Menu display on the screen to set or adjust the Control Menu items.
- 13 I/⏻ button (30)**
Turns on and off the power of the player.
- 14 Number buttons**
Selects the items or settings.
- 15 TIME/TEXT button (41)**
Displays the playing time of the disc, etc., on the display window.
- 16 ■STOP button (32, 35)**
Stops playing a disc.
- 17 II PAUSE button (32)**
Pauses playing a disc.
- 18 DVD MENU button (38)**
Displays the DVD menu on the screen.
- 19 ←/↑/↓/→/ENTER buttons**
Selects and executes the items or settings.
- 20 ↶RETURN button (39, 46)**
Press to return to the previously selected screen, etc.

Index

Numerics

- 4:3 LETTER BOX 83
- 4:3 PAN SCAN 83
- 5.1 Channel Surround 22
- 16:9 83

A

- A-B REPEAT 74
- AC power adaptor 25
- ADVANCED 63
- ANGLE 58
- AUDIO 54, 81
- AUDIO DRC 91
- AUDIO SETUP 91
- AUTO PLAY 85
- Auto power off 31

B

- BACKGROUND 84
- Batteries 13
- Battery pack
 - Attaching 26
 - Charging 27
 - Detaching 27
- BIT RATE 63, 64, 107

C

- CD 6
- CD TEXT 53
- Chapter 7, 50
- CHAPTER 50
- Connecting 16, 19, 22
- Continuous play
 - CD/VIDEO CD 30
 - DVD 30
- Control Menu display 45
- CUSTOM PARENTAL CONTROL 65
- CUSTOM SETUP 85

D, E

- Digital Cinema Sound 60, 107
- DIGITAL OUT 92
- Digital output 21, 24, 92
- Display
 - Control Menu display 45
 - Display window 41
 - Setup display 76

- DOLBY DIGITAL
 - 22, 56, 92, 108
- DOWNMIX 92
- DTS 8, 22, 56, 93, 107
- DVD 6
- DVD menu 38
- DVD MENU 80
- DVD TEXT 53

F, G

- Fast Forward 34
- Fast Reverse 34

H

- Handling discs 12
- Headphones 95
- Headphone surround 95
- Hooking up 16, 19, 22

I, J, K

- Index 7, 50
- INDEX 50

L

- LANGUAGE SETUP 80
- LAYER 63, 64
- LCD screen 14, 98
- LETTER BOX 83
- Locating
 - a specific point 33, 34
 - by watching the TV screen 34

M, N

- MPEG 22, 56, 93, 109
- Multi-angle 58
- Multi-language 54

O

- On-screen display
 - Control Menu display 45
 - Setup display 76
- OSD 80

P, Q

- PAN SCAN 83
- PARENTAL CONTROL 85
- PAUSE MODE 85
- PBC functions 39

- PBC Playback 39, 108
- POWER SAVING 90
- Pro Logic 92, 107
- PROGRAM 68
- Program Play 68

R

- Remote 13
- REPEAT 73
- Resume Play 35

S

- S video output 17, 20
- Scan 34
- Scene 7, 50
- SCENE 50
- SCREEN SAVER 84
- SCREEN SETUP 83
- Searching. See Locating.
- SETUP 76
- Setup display 76
- SHUFFLE 72
- Shuffle Play 72
- Slow-motion Play 34
- Speakers hookup 23
- SUBTITLE 57, 82

T

- TIME/TEXT 51, 52, 53
- Title 7, 50, 108
- TITLE 50
- Title menu 37
- Track 7, 50, 108
- TRACK 50
- TRACK SELECTION 90
- Troubleshooting 99
- TV TYPE 83

U

- Usable discs 6

V, W, X, Y, Z

- VIDEO CD 6
- VES 60

Sony  line

<http://www.world.sony.com/>

Free Manuals Download Website

<http://myh66.com>

<http://usermanuals.us>

<http://www.somanuals.com>

<http://www.4manuals.cc>

<http://www.manual-lib.com>

<http://www.404manual.com>

<http://www.luxmanual.com>

<http://aubethermostatmanual.com>

Golf course search by state

<http://golfingnear.com>

Email search by domain

<http://emailbydomain.com>

Auto manuals search

<http://auto.somanuals.com>

TV manuals search

<http://tv.somanuals.com>