

Portable CD/DVD Player

Operating Instructions _____ **US**

Manual de instrucciones _____ **ES**



DVP-FX950

WARNING

To reduce the risk of fire or electric shock, do not expose this apparatus to rain or moisture.

To avoid electrical shock, do not open the cabinet.

Refer servicing to qualified personnel only.

The AC power cord must be changed only at a qualified service shop.

Batteries or batteries installed apparatus shall not be exposed to excessive heat such as sunshine, fire or the like.

CAUTION

The use of optical instruments with this product will increase eye hazard. As the laser beam used in this CD/DVD player is harmful to eyes, do not attempt to disassemble the cabinet.

Refer servicing to qualified personnel only.

CAUTION CLASS 1M VISIBLE AND INVISIBLE LASER RADIATION WHEN OPEN AND INTERLOCKS DEFEATED. DO NOT VIEW DIRECTLY WITH OPTICAL INSTRUMENTS.

This label is located on the bottom of the unit.



 This symbol is intended to alert the user to the presence of uninsulated "dangerous voltage" within the product's enclosure that may be of sufficient magnitude to constitute a risk of electric shock to persons.



This symbol is intended to alert the user to the presence of important operating and

maintenance (servicing) instructions in the literature accompanying the appliance.

Precautions

- Install this system so that the AC power cord can be unplugged from the wall socket immediately in the event of trouble.
- The player is not disconnected from the AC power source as long as it is connected to the wall outlet, even if the player itself has been turned off.
- To prevent fire or shock hazard, do not place objects filled with liquids, such as vases, on the apparatus.

For customers in the U.S.A. Owner's Record

The model and serial numbers are located at the bottom of the unit. Record the serial number in the space provided below. Refer to them whenever you call upon your Sony dealer regarding this product. Model No. DVP-FX950
Serial No. _____

CAUTION

You are cautioned that any changes or modifications not expressly approved in this manual could void your authority to operate this equipment.



This equipment has been tested and found to comply with the limits for a Class B digital device, pursuant to Part 15 of the FCC Rules. These limits are designed to provide reasonable protection against harmful interference in a residential installation. This equipment generates, uses, and can radiate radio frequency energy and, if not installed and used in accordance with the instructions, may cause harmful interference to radio communications.

However, there is no guarantee that interference will not occur in a particular installation. If this equipment does cause harmful interference to radio or television reception, which can be determined by turning the equipment off and on, the user is encouraged to try to correct the interference by one or more of the following measures:

- Reorient or relocate the receiving antenna.
- Increase the separation between the equipment and receiver.
- Connect the equipment into an outlet on a circuit different from that to which the receiver is connected.
- Consult the dealer or an experienced radio/TV technician for help.

IMPORTANT SAFETY INSTRUCTIONS

- 1) Read these instructions.
- 2) Keep these instructions.
- 3) Heed all warnings.
- 4) Follow all instructions.
- 5) Do not use this apparatus near water.
- 6) Clean only with dry cloth.
- 7) Do not block any ventilation openings. Install in accordance with the manufacturer's instructions.
- 8) Do not install near any heat sources such as radiators, heat registers, stoves, or other apparatus (including amplifiers) that produce heat.
- 9) Do not defeat the safety purpose of the polarized or grounding-type plug. A polarized plug has two blades with one wider than the other. A grounding type plug has two blades and a third grounding prong. The wide blade or the third prong are provided for your safety. If the provided plug does not fit into your

outlet, consult an electrician for replacement of the obsolete outlet.

- 10) Protect the power cord from being walked on or pinched particularly at plugs, convenience receptacles, and the point where they exit from the apparatus.
- 11) Only use attachments/accessories specified by the manufacturer.
- 12) Use only with the cart, stand, tripod, bracket, or table specified by the manufacturer, or sold with the apparatus. When a cart is used, use caution when moving the cart/apparatus combination to avoid injury from tip-over.



- 13) Unplug this apparatus during lightning storms or when unused for long periods of time.
- 14) Refer all servicing to qualified service personnel. Servicing is required when the apparatus has been damaged in any way, such as power-supply cord or plug is damaged, liquid has been spilled or objects have fallen into the apparatus, the apparatus has been exposed to rain or moisture, does not operate normally, or has been dropped.

RECYCLING LITHIUM-ION BATTERIES

Lithium-Ion batteries are recyclable. You can help preserve our environment by returning your used rechargeable batteries to the collection and recycling location nearest you. For more information regarding recycling of rechargeable batteries, call toll free 1-800-822-8837, or visit <http://www.rbrcc.org/>



Caution: Do not handle damaged or leaking Lithium-Ion batteries.

IMPORTANT NOTICE

Caution: This player is capable of holding a still video image or on-screen display image on your television screen indefinitely. If you leave the still video image or on-screen display image displayed on your TV for an extended period of time you risk permanent damage to your television screen. Plasma display panel televisions and projection televisions are susceptible to this.

If you have any questions or problems concerning your player, please consult your nearest Sony dealer.

Copyrights and trademarks

- This product incorporates copyright protection technology that is protected by U.S. patents and other intellectual property rights. Use of this copyright protection technology must be authorized by Macrovision, and is intended for home and other limited viewing uses only unless otherwise authorized by Macrovision. Reverse engineering or disassembly is prohibited.

- Manufactured under license from Dolby Laboratories. Dolby and the double-D symbol are trademarks of Dolby Laboratories.
- “DVD+RW,” “DVD-RW,” “DVD+R,” “DVD+R DL,” “DVD-R,” “DVD VIDEO,” and “CD” logos are trademarks.
- MPEG Layer-3 audio coding technology and patents licensed from Fraunhofer IIS and Thomson.

About this manual



- In this manual, “disc” is used as a general reference for the DVDs or CDs unless otherwise specified by the text or illustrations.
- Icons, such as , listed at the top of each explanation indicate what kind of media can be used with the function being explained. For details, see “Playable Media” (page 27).
- NEED-to-know information (to prevent incorrect operation) is listed under the  icon. NICE-to-know information (tips and other useful information) is listed under the  icon.

Table of Contents

WARNING	2
Guide to Parts and Controls	5
Rotating and Folding Down the LCD Panel	8
<hr/>	
Preparations	9
Checking the Accessories	9
Charging the Battery Pack	9
Using the Car Battery Adaptor	11
Connecting to Other Equipment	12
<hr/>	
Playback	13
Playing Discs	13
Playing MP3 and JPEG Files	16
Adjusting the Picture Size and Quality	18
<hr/>	
Settings and Adjustments	19
Using the Setup Display	19
<hr/>	
Additional Information	22
Troubleshooting	22
Precautions	24
Playable Media	27
Specifications	29
Index	30

Guide to Parts and Controls

For more information, see the pages indicated in parentheses.

Player

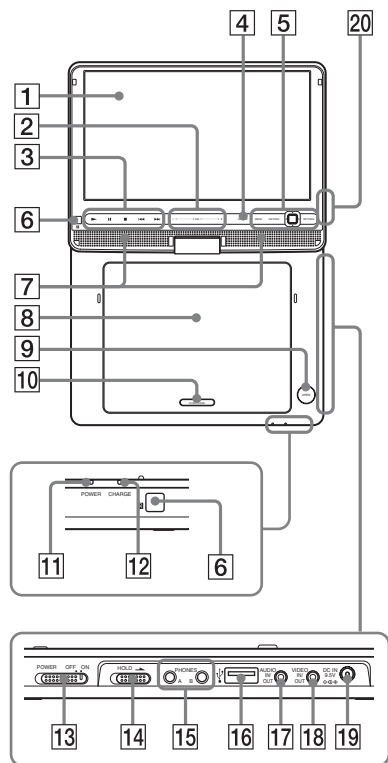

Buttons **2** **3** **4** and **5** (but not **←/↑/↓/→/ENTER**) can be operated with a single touch.

The VOL+ and **▶** (play) buttons have a tactile dot. Use the tactile dot as a reference when operating the player.

1 LCD panel (page 8)

2 VOL (sound volume) +/-

Adjusts the volume.

Operate with a single touch of + or – on the player. You can also adjust the volume by sliding your finger along the touch slider. Sliding toward + from center increases volume; sliding toward – from center decreases volume. (The same operation in “LCD Mode” can be used to adjust the picture quality level. See page 18.)

3 **▶** (play) (page 13)

Starts or re-starts playback.

|| (pause) (page 13)

Pauses or re-starts playback.

■ (stop) (page 13)

Stops playback.

◀◀ (previous)

Skips to the beginning of the current chapter/track/scene.

To go to the beginning of the previous chapter/track/scene, press twice.

▶▶ (next)

Skips to the next chapter/track/scene.

4 DISPLAY

Displays the playback information.

- When playing a DVD: Displays the playback information and changes the playback mode. See page 15.
- When playing a CD: Each time you press the button, the time information switches.

5 MENU

- When playing a DVD: Displays the menu.
- When playing a CD: Each time you press the button, switches Repeat Play, Random Play, and Play.
- When playing a JPEG file: Displays the list of thumbnails and plays a slideshow. See page 16.

RETURN

Returns to the previous display.

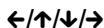

Moves the highlight to select a displayed item.

- When playing a DVD or CD: on the player works as the same as on the remote.

Center button (ENTER)

Enters the selected item.

- When playing a DVD or CD: ENTER on the player works as the same as .

OPTIONS

Displays the menu for adjusting the LCD screen (page 18) and using the setup display (page 19).

6 (remote sensor)

When operating by the remote, point it at the remote sensor .

7 Speaker

8 Disc Lid (page 13)

9 OPEN button (page 13)

Opens the disc lid.

10 PUSH CLOSE (page 13)

Closes the disc lid.

11 POWER indicator (page 13)

12 CHARGE indicator (page 10)

13 POWER switch (page 13)

Turns the player on or off.

14 HOLD switch

To avoid accidental button operation of the player, set the HOLD switch to the direction of the arrow.

All the buttons on the player are locked, while the buttons on the remote remain operable.

15 PHONES (headphone) jack A, B

16 USB jack (type A) (page 17)

Connect a USB device to this jack.

17 AUDIO IN/OUT jack (page 12)

18 VIDEO IN/OUT jack (page 12)

19 DC IN 9.5V jack (page 10, 11)

Connect the AC power adaptor or car battery adaptor.

20 INPUT SELECT button (page 12)

Each time you press the button, the LCD screen image switches as follows:

- Disc mode (default): When playing an inserted disc.
- USB mode: When playing DATA files on a connected USB device. Appears “USB” on the LCD screen when you select this mode.
- Line In mode: When inputting a playback signal from connected A/V equipment. Appears “Line In” on the LCD screen when you select this mode.

Remote

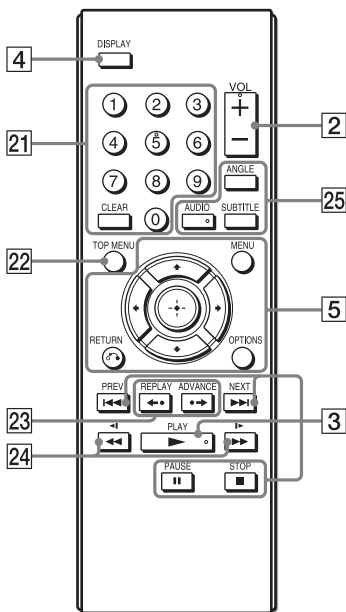

The VOL +, number 5, ► and AUDIO buttons have a tactile dot. Use the tactile dot as a reference when operating the player.

21 Number buttons

Enters the title/chapter numbers, etc.

- When playing a DVD VIDEO or CD: Search directly by entering the title/chapter/track number using the number buttons, and press ENTER. To switch a title or chapter, press ◀/→.

CLEAR button

Clears the entry field.

22 TOP MENU button

- When playing a DVD VIDEO: Displays the top menu.
- When playing a DVD VR: Switches between “Original” and “Play List” on the disc created Playlist. During playback, you cannot switch. Press ■ twice, and press TOP MENU.

23 ◀◀REPLAY/▶▶ADVANCE buttons

Replays the scene/briefly fast forward the current scene (DVD only).

24 ◀◀◀◀/▶▶▶▶ (scan/slow) buttons

Fast reverses/ fast forwards when pressed during playback. Press repeatedly to change the speed.

- When playing a DVD: Slow reverses/ slow forwards when pressed during pause. Press repeatedly to change the speed.

25 ANGLE button

Changes the angle. When “◻◻” (Angle Mark) appears, you can change angles. Depending on the disc, you may not be able to change the angle. (DVD VIDEO only)

AUDIO button

Changes the audio signal.

- When playing a DVD VIDEO: Each time you press the button, the language of the sound track switches. Depending on the disc, the choice of language varies.
- When playing a DVD VR: Each time you press the button, the type of sound tracks recorded on a disc switches between main, sub and main/sub sound.
- When playing a CD: Each time you press the button, the mode switches between stereo and monaural (left/right).

SUBTITLE button

Changes the subtitle. Each time you press the button, the subtitle switches. Depending on the disc, the choice of language varies. (DVD only)

Rotating and Folding Down the LCD Panel

Open the LCD panel to the vertical position, then slowly rotate it 180 degrees in the direction indicated by the arrow (clockwise).

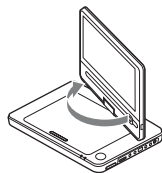

After rotating the LCD panel 180 degrees clockwise, push the LCD panel down onto the main body of the player. In this position the panel is facing up.

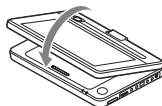

To return the LCD panel to its original position

Open the LCD panel to the vertical position and rotate the LCD panel counter-clockwise slowly.



- Do not rotate the LCD panel over 180 degrees. In addition, do not rotate in the opposite direction. Doing so will break the LCD panel.
- Return the LCD panel to its original positions after use, so the LCD panel will not be damaged by sudden shocks or rough treatment.
- Do not rotate the LCD panel while keeping it closed or out of vertical. It may scratch the player.

Checking the Accessories

Check that you have the following items:

- Battery pack (NP-FX110) (1)
- AC power adaptor (1)
- Car battery adaptor (1)
- Audio/video cord (mini plug × 2 ↔ phono plug × 3) (1)
- Remote (1)
- Size AA (R6) batteries (2)

Preparing the remote

Insert two Size AA (R6) batteries by matching the ⊕ and ⊖ ends on the batteries to the markings inside the compartment.

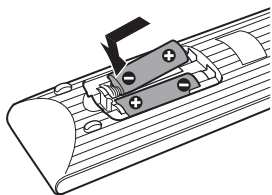

Charging the Battery Pack

Charge the battery pack (supplied) before using the player for the first time, or when the battery is depleted.

1 Attach the battery pack to the player.

Align the battery pack with the lines on the bottom of the player.

Engage the hooks of the battery pack into the holes on the bottom of the player.

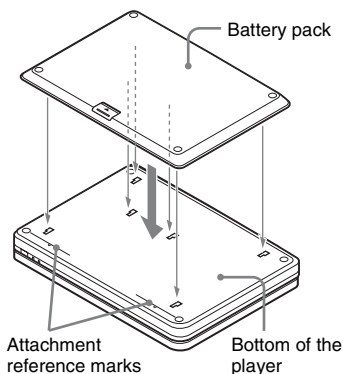

Slide the battery pack in the direction of the arrow until it clicks into place.

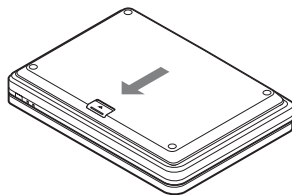

2 Connect the AC power adaptor.

When charging begins, the CHARGE indicator lights up in orange.

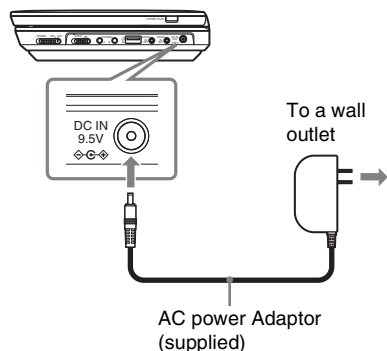

When charging ends, the CHARGE indicator lights off.
Disconnect the AC power adaptor.



If the POWER indicator lights up instead of the CHARGE indicator, the POWER switch is set to "ON." Set the POWER switch to "OFF," and make sure that the CHARGE indicator lights up.



Charge the battery in an ambient temperature of between 5°C (41°F) to 35°C (95°F).

Charging time and playing time

Charging time: approx. 6 hours

Playing time: approx. 7.5 hours

Times indicated are under the following conditions:

- Moderate temperature (20°C (68°F))
- Headphone use
- Backlight set to minimum

Depending on the ambient temperature or battery pack condition, charging time may be longer, or playing time may be reduced.

To check the battery level

When the player is stopped, the battery indicator is displayed. When the battery is empty,  is displayed or the CHARGE indicator flashes. Set the POWER switch to "OFF," connect the AC power adaptor, and recharge the battery.



To remove the battery pack

Push the release knob and slide the battery pack in the direction of the arrow.

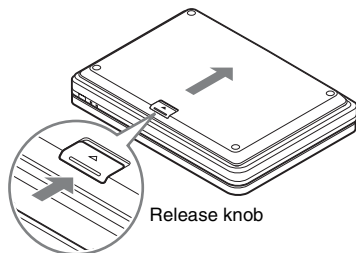

CAUTION

Danger of explosion if battery is incorrectly replaced.

Replace only with the same or equivalent type.

Using the Car Battery Adaptor

The car battery adaptor (supplied) is for a 12V car battery, negative earth (do not use it with a 24V car battery, positive earth).

- 1 Start the engine.
- 2 Connect the car battery adaptor.

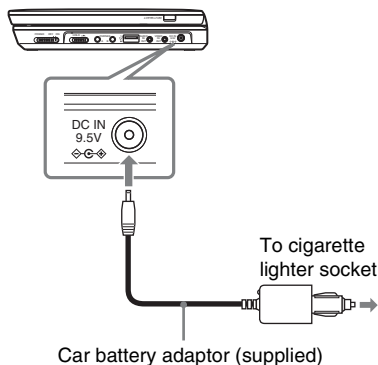

- 3 Turn on the player.

- The driver should not connect or disconnect the car battery adaptor while driving.
- Arrange the cord so as not to interfere with the driver. Also, do not place the LCD panel where the driver can watch.
- Clean the cigarette lighter socket. If it is dirty, it may cause contact failure or malfunction.
- Use the car battery adaptor with the car engine running. If it is used with the car engine off, the car battery may become depleted.

After using the player in a car

- 1 Turn off the player.
 - 2 Disconnect the car battery adaptor.
 - 3 Turn off the engine.
- Do not disconnect the car battery adaptor or turn off the car engine before you turn off the player. Doing so may damage the player.
 - Disconnect the car battery adaptor after use. If it is left connected, the car battery may become depleted.
 - Do not leave the player or accessories in the car.

Connecting to Other Equipment

By connecting the player to your TV or other equipment, you can increase your viewing options.



- Refer to the instructions supplied with the equipment to be connected.
- Before connecting, turn off the player and the equipment to be connected, then unplug from their wall sockets.

Enjoying images on a connected TV

- 1** Connect the player to your TV or monitor using the audio/video cord (supplied).

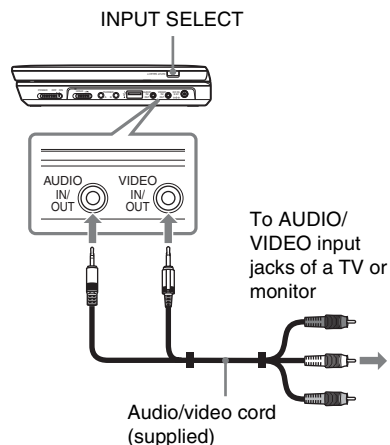

- When you play back a disc after enjoying images by “Line In” or “USB,” press INPUT SELECT repeatedly to select the disc mode. See page 7.
- The player can connect to an AV amplifier in the same way as a TV. Although connecting is the same as a TV, the yellow plug of the audio/video cord is not used.

Enjoying images on other equipment

- 1** Connect the player to your video player or camcorder using the audio/video cord (supplied).

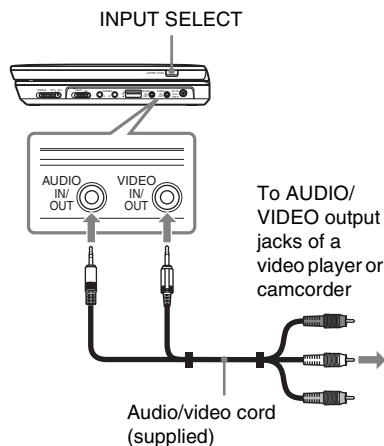

- 2** Turn on the player and press INPUT SELECT repeatedly to select “Line In.”

Playing Discs

DVDVideo **DVD**VR **CD** **DATA**

Depending on the disc, some operations may be different or restricted. Refer to the operating instructions supplied with the disc.

Connect the AC power adaptor or attach the battery pack.

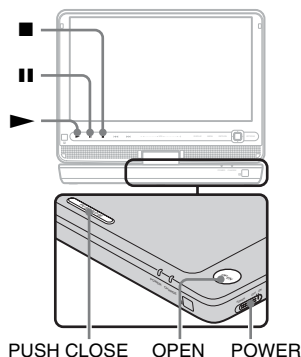

1 Open the LCD panel.

2 Slide the **POWER** switch to “ON.”

The player turns on and the **POWER** indicator lights up in green.

3 Press **OPEN** to open the disc lid.

4 Insert the disc to be played.

Place with the playback side down and push gently until it clicks.

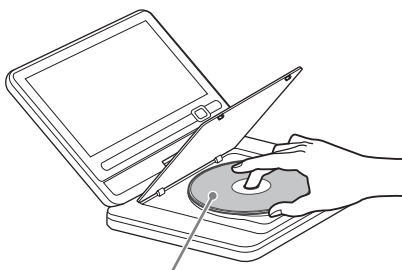

Playback side facing down

5 Push the **PUSH CLOSE** on the disc lid to shut the disc lid.

6 Press **▶**.

The player starts playback.
Depending on the disc, a menu may appear. Press **←/↑/↓/→** to select the item, and press **ENTER**.

To stop playback

Press **■**.

To pause playback

Press **⏸**.



When you play back a disc after enjoying images by “Line In” or “USB,” press **INPUT SELECT** repeatedly to select the disc mode. See page 7.



- Discs created on DVD recorders must be correctly finalized to play on the player. For more information about finalizing, refer to the operating instructions supplied with the DVD recorder.
- The disc may be still spinning when the disc lid is opened. Wait until the spinning stops before removing the disc.

To resume playback from the point where you stopped the disc (Resume Play)

Play **DVDVideo** **DVDVr** **CD**

When you press **▶** again after you stop playback, the player starts playback from the point when you pressed **■**.



- To play from the beginning of the disc, press **■** twice, and press **▶**.
- When turning power on again after power off, resume play starts automatically.



- Depending on the stop point, Resume play may not start from exactly the same point.
- The resume point is cleared when:
 - you open the disc lid.
 - you press INPUT SELECT.
 - you disconnect the adaptor or remove the battery pack before turning off the player.

Notes on the screen saver

- A screen saver image appears when you leave the player in pause or stop mode without operation for more than 15 minutes. The image disappears when you press **▶**. For the setup of “Screen Saver,” see page 20.
- The player goes to standby, 15 minutes after starting the screen saver function. Press **▶** to come out of standby mode.

About various playback operations

To	Operation
Change the LCD picture size	Press OPTIONS to select “LCD Mode” (page 18).
Display the DVD menu	Press MENU (page 6) or TOP MENU (page 7).
Check the DVD playback information	Press DISPLAY (page 15).
Play DVDs* repeatedly (Repeat Play)	Press DISPLAY to select “Repeat” (page 15).
Play DVDs in fast reverse or fast forward (Scan Play)	Press ◀/▶ repeatedly on the player to select the speed (page 6).
Switch between original and Playlist in DVD (VR mode)	Press TOP MENU repeatedly (page 7).
Change the CD playback information	Press DISPLAY repeatedly (page 6).
Play CDs repeatedly (Repeat Play)	Press MENU repeatedly (page 6).
Play CDs randomly (Random Play)	Press MENU repeatedly (page 6).
Play CDs in fast reverse or fast forward (Scan Play)	Press ◀/▶ repeatedly on the player to select the speed (page 6).

* DVD VIDEO only

Using the Playback Information Display

DVDvideo DVDvr

While playing a DVD, you can check the current playback information. The playback information display also allows you to set a title/chapter or change sound/subtitle, and so on.

When entering the numbers, operate the number buttons on the remote.

1 Press DISPLAY while playing a DVD.

The current playback information appears.

Example: When playing a DVD VIDEO

Items Current playback information*

Menu	
Title	02/07
Chapter	03/20
Audio	01 5.1CH DDD English
Subtitle	01 English
▶ Title Elapsed 00:12:01	

Elapsed or remaining time

* When a DVD (VR mode) is played, "PL" (playlist) or "ORG" (original) is displayed next to the title number.

2 Press ↑/↓ to select items and press ENTER.

- Title: Select the title number by pressing ↑/↓ or number buttons.
- Chapter: Select the chapter number by pressing ↑/↓ or number buttons.
- Audio: Select the sound by pressing ↑/↓.
- Subtitle: Select the subtitle by pressing ↑/↓.
- Angle: Select the angle by pressing ↑/↓.
- T.Time: Time appears while playing a title. "00:00:00" will appear by

pressing ENTER. Enter the desired time code by pressing the number buttons.

- C.Time: Time appears while playing a chapter. "00:00:00" will appear by pressing ENTER. Enter the desired time code by pressing the number buttons.
- Repeat: Select "⏮ Chapter," "⏮ Title," "⏮ All," or "Off" by pressing ↑/↓.
- A-B Repeat: Select "Set" by pressing ↑/↓, and press ENTER. Select point A and point B by pressing ENTER.
- Time Disp.: "Title Elapsed" is displayed. Select "Title Elapsed," "Title Remain," "Chapter Elapsed," or "Chapter Remain" by pressing ↑/↓.

3 Press ENTER.

To turn off the display

Press DISPLAY or RETURN.



Depending on the disc, you may not be able to set some items.

Playing MP3 and JPEG Files **DATA**

You can play MP3 and JPEG files. For details on playable files, see “Playable Media” (page 27).

When you set a DATA media, a list of albums appears.

DATA CDs recorded in KODAK Picture CD format automatically start playing when inserted.

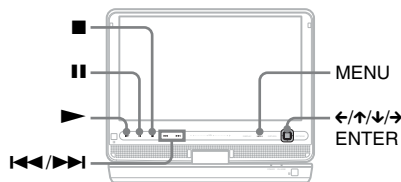

1 Press \uparrow/\downarrow to select the album, and press ENTER.

The list of files in the album appears.
Example: The list of MP3 files

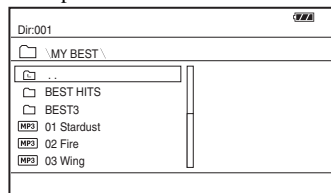

- To go to the next or previous page, press \ggg or \lll .
- To return to the list of albums, press \uparrow/\downarrow to select \square and press ENTER.

2 Press \uparrow/\downarrow to select the file, and press ENTER.

Playback starts from the selected file.

To go to the next or previous file

Press \ggg or \lll .

To stop playback

Press \blacksquare .

The display will return to the list of files.

To pause playback (MP3 only)

Press \parallel .

To restart playback, press \parallel again.



Depending on the file, playback may take time to start or may not be able to start. For details on playable files, see “Playable Media” (page 27).

Selecting a JPEG file

To rotate a JPEG image

Press $\leftarrow/\uparrow/\downarrow/\rightarrow$ while viewing the image file. Rotate every file.

\rightarrow : Rotates the image 90 degrees clockwise.

\leftarrow : Rotates the image 90 degrees counter clockwise.

\uparrow : Reverses the image vertically (up and down).

\downarrow : Reverses the image horizontally (left and right).

To display the list of thumbnails

Press MENU.

The image files in the album appear in 12 sub-screens.

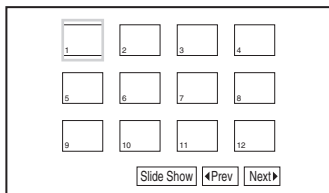

- To go to the previous or next list of thumbnails, select “◀Prev” or “Next▶” at the bottom of the screen, and press ENTER.
- To exit the list of thumbnails, press MENU.

Playing a Slide Show

- 1 Press MENU.**
The list of thumbnails appears.
- 2 Press ←/↑/↓/→ to select “Slide Show” at the bottom of the screen, and press ENTER.**
A slideshow starts.

To stop slideshow

Press ■ to return to the list of files.
Press MENU to return to the list of thumbnails.

To pause slideshow

Press ■.

Playing data on a USB device

You can play back DATA files on a USB device.

- 1 Press INPUT SELECT repeatedly to select “USB.”**
- 2 Connect a USB device to the USB jack.**

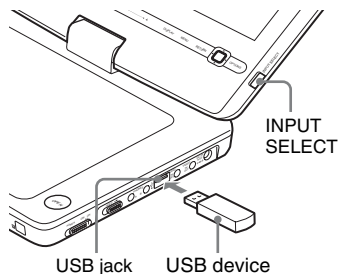

To disconnect a USB device

- 1 Press INPUT SELECT to deselect “USB.”**
- 2 Disconnect the USB device.**

About supported Sony USB devices

The following Sony USB Memory Stick reader/writer and USB flash drive “Micro Vault” are supported: MSAC-US40, USM-J series, USM-JX series, USM-J/B series, USM-L series, and USM-LX series.



- Do not disconnect the USB device while its access indicator is flashing. Doing so may cause data corruption or loss of data.
- USB devices which can connect to the player are flash memory and multiple card readers. Other devices (digital still camera, USB hub, etc.) cannot be connected. When an unsupported device is connected, an error message appears.

→ continued

Adjusting the Picture Size and Quality

DVDVideo DVDVR DATA

You can adjust the picture displayed on the LCD screen.

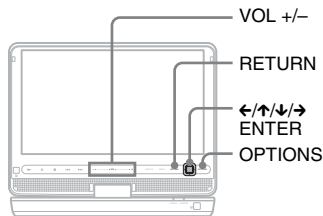

1 Press OPTIONS.

The menu display appears.

2 Press \uparrow/\downarrow to select “LCD Mode” and press ENTER.

The “LCD Mode” display appears.

items

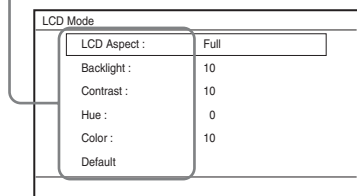

3 Press \uparrow/\downarrow to select items and press ENTER.

- LCD Aspect: Change the picture size. Select “Normal,” “Full” or “Zoom” by pressing \uparrow/\downarrow *¹.
- Backlight: Adjust the brightness by pressing \leftarrow/\rightarrow or VOL +/-*².

- Contrast: Adjust the difference between light and dark areas by pressing \leftarrow/\rightarrow or VOL +/-*².
- Hue: Adjust the red and green color balance by pressing \leftarrow/\rightarrow or VOL +/-*².
- Color: Adjust the richness of colors by pressing \leftarrow/\rightarrow or VOL +/-*².
- Default: Return all settings to the factory defaults.

4 Press ENTER.

*¹ In “Normal,” pictures are displayed in their original configuration, retaining the aspect ratio. 4:3 pictures are displayed with black bands on both sides of the screen. 4:3 letter box pictures are displayed with bands on all sides of the screen.

In “Full,” pictures are adjusted to fill the entire screen. 16:9 pictures are displayed in their original configuration. (Black band recorded in a 16:9 picture cannot be erased.) 4:3 pictures appear stretched.

In “Zoom,” 4:3 pictures are displayed full width. The upper and lower areas of the picture will be slightly cut.

*² Operate with a single touch of + or – on the player. You can also adjust the level by sliding your finger along the touch slider. For VOL +/-, see page 5.

To turn off the menu display

Press OPTIONS or RETURN twice.



Depending on the disc, the screen size you can select differs.

Using the Setup Display

By using the setup display, you can make various settings to items such as picture and sound.

Some discs have stored playback settings, which take priority.

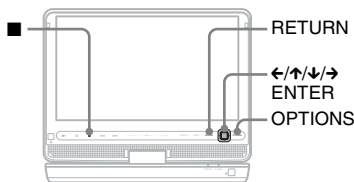

1 Press **OPTIONS** when the player is in stop mode.

The menu display appears. During Resume Play, you cannot use the setup display. Press **■** twice to clear Resume Play, and press **OPTIONS**.

2 Press **↑/↓** to select “Setup,” and press **ENTER**.

The setup display appears.

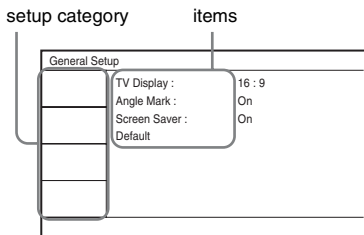

3 Press **↑/↓** to select the setup category and press **ENTER**.

- : General Setup (page 19)
Makes the player-related settings.
- : Audio Setup (page 20)
Makes the audio settings according to playback conditions.
- : Language Setup (page 20)
Makes the language settings for the on-screen display or sound track.
- : Parental Control (page 21)
Sets the parental control limit.

4 Select and adjust each of the following items by pressing **↑/↓** and **ENTER**.

To turn off the setup display

Press **OPTIONS** or **RETURN** twice.

General Setup

The default settings are underlined.

◆ TV Display (DVD only)

Selects the aspect ratio of the connected TV.

4:3 Pan Scan	Select this when you connect a 4:3 screen TV. Automatically displays a wide picture on the entire screen and cuts off the portions that do not fit.
4:3 Letter Box	Select this when you connect a 4:3 screen TV. Displays a wide picture with bands on the upper and lower portions of the screen.
<u>16:9</u>	Select this when you connect a wide-screen TV or a TV with a wide mode function.

4:3 Pan Scan

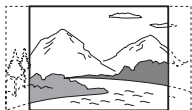

4:3 Letter Box



16:9



Depending on the disc, “4:3 Letter Box” may be selected automatically instead of “4:3 Pan Scan” or vice versa.

◆ Angle Mark (DVD VIDEO only)

Displays the angle mark when you can change the viewing angles during playback of DVDs recorded with multi-angles.

<u>On</u>	Display the angle mark.
Off	Hide the angle mark.

◆ Screen Saver

The screen saver image appears when you leave the player in pause or stop mode for 15 minutes. The screen saver will help prevent your display equipment from becoming damaged (ghosting). Press ► to turn off the screen saver.

<u>On</u>	Activates the screen saver function.
Off	Deactivates the screen saver function.

◆ Default

Each function returns to its original factory settings. Note that all of your settings will be lost.

🔊 Audio Setup

The default setting is underlined.

◆ Audio DRC (Dynamic Range Control) (DVD only)

Makes the sound clear when the volume is turned down when playing a DVD that conforms to “Audio DRC.”

<u>Standard</u>	Standard sound.
<u>TV Mode</u>	Makes low sounds clear even if you turn the volume down.
Wide Range	Gives you the feeling of being at a live performance.

⌨ Language Setup

◆ OSD (On-Screen Display)

Switches the display language on the screen.

◆ Disc Menu (DVD VIDEO only)

Switches the language for the disc’s menu. When you select “Original,” the language given priority in the disc is selected.

◆ Subtitle (DVD VIDEO only)

Switches the subtitle language. When you select “Off,” no subtitle is displayed.

◆ Audio (DVD VIDEO only)

Switches the language of the sound track. When you select “Original,” the language given priority in the disc is selected.



If you select a language in “Disc Menu,” “Subtitle,” or “Audio” that is not recorded on the disc, one of the recorded languages will be automatically selected.

Parental Control

You can limit playback of a DVD that has the parental control function.

When you operate this setting, use the remote.

◆ Password (DVD VIDEO only)

Enter or change a password. Set the password for the parental control function. Enter your 4-digit password using the number buttons on the remote.

To change the password

- 1 Press **↑/↓** to select “Password,” and press ENTER.
- 2 Check “Change” is selected and press ENTER.
The display for entering the password appears.

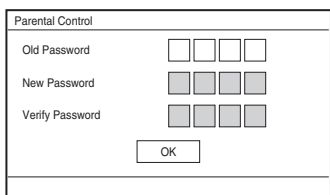

- 3 Enter your current password in “Old Password,” your new password in “New Password” and “Verify Password,” and press ENTER.

If you make a mistake entering your password

Press CLEAR, or press **←** to return one by one before pressing ENTER in step 3, and re-enter the password.

If you forget your password

Enter “1369” in “Old Password,” and enter your new password in “New Password” and “Verify Password.”

◆ Parental Control (DVD VIDEO only)

Set the limitation level. The lower the value, the stricter the limitation.

To set the parental control, you need to set the password first.

To set the parental control (limited playback)

- 1 Press **↑/↓** to select “Parental Control,” and press ENTER.
- 2 Press **↑/↓** to select the limitation level, and press ENTER. The lower the value, the stricter the limitation. The display for entering the password appears.

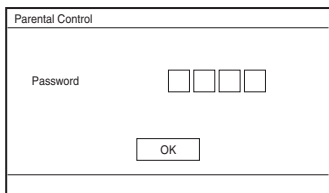

- 3 Enter your password, and press ENTER.

To play a disc for which Parental Control is set

Insert the disc and press **▶**. The display for entering your password appears. Enter your password using the number buttons on the remote, and press ENTER.

⚡

- When you play discs which do not have the Parental Control function, playback cannot be limited on the player.
- Depending on the disc, you may be asked to change the parental control level while playing the disc. In this case, enter your password, then change the level. If the Resume Play mode is canceled, the level returns to the previous level.

Troubleshooting

If you experience any of the following difficulties while using the player, use this troubleshooting guide to help remedy the problem before requesting repairs. Should any problem persist, consult your nearest Sony dealer.

Power

The power is not turned on.

- ➔ Check that the AC power adaptor is connected securely (page 9).
- ➔ Check that the battery pack is attached securely (page 9).
- ➔ Check that the battery pack is sufficiently charged (page 10).

The battery pack cannot be charged.

- ➔ You cannot charge the battery pack when power is turned on. Set the POWER switch to "OFF" (page 9).

Picture

There is no picture/picture noise appears.

- ➔ The disc is dirty or flawed (page 26).
- ➔ The brightness is set at minimum. Adjust the brightness of the LCD (page 18).
- ➔ When "USB" or "Line In" is displayed, press INPUT SELECT repeatedly to select the disc mode (page 7).

The black points appear and the red, blue, green points remain on the LCD.

- ➔ This is a structural property of the LCD and not malfunction.

Sound

There is no sound.

- ➔ The player is in pause mode or in slow play mode.
- ➔ The player is in fast forward or fast reverse mode.

The sound volume is low.

- ➔ The sound volume is low on some DVDs. The sound volume may improve if you set "Audio DRC" in "Audio Setup" to "TV Mode" (page 20).

Operation

Nothing happens when buttons are pressed.

- ➔ The HOLD switch is set in the direction of the arrow (page 6).

The disc does not play.

- ➔ If the disc is turned over, a "No Disc" or "Cannot play this disc." message appears. Insert the disc with the playback side facing down (page 13).
- ➔ The disc is not set until it clicks (page 13).
- ➔ The disc that cannot be played is inserted. Check the region code matches the player, and that the disc has been finalized (page 27).
- ➔ When "USB" or "Line In" is displayed, press INPUT SELECT repeatedly to select the disc mode (page 7).
- ➔ Parental Control has been set. Change the setting (page 21).
- ➔ Moisture has condensed inside the player (page 25).

The player starts and stops playing the disc automatically.

- ➔ The disc features an auto playback function.
- ➔ While playing discs with an auto pause signal, the player stops playback at the

auto pause signal.

The disc does not start playing from the beginning.

- ➔ Repeat Play or Random Play is selected (page 14).
- ➔ Resume play has taken effect (page 14).
- ➔ The Playlist of the created disc is automatically played. To play original titles, press TOP MENU to set “Original” (page 7).

Playback may take time to start.

- ➔ Playback may take time to start in DVD (VR mode).

Playback freezes.

- ➔ When the playback layer of a DVD+R DL/-R DL disc changes, playback may freeze.

The subtitles disappear.

- ➔ When you change playback speed, or skip scenes during playback, the subtitles may disappear temporarily.

“⊙” appears and the player does not function according to the button.

- ➔ Depending on the disc, you may not be able to perform certain operations. Refer to the operating instructions supplied with the disc.

“Copyright Lock” appears and the screen turns blue when playing a DVD (VR mode) disc.

- ➔ Images taken from digital broadcasts, etc., may contain copy protection signals, such as complete copy protection signals, single copy signals, and restriction-free signals. When images that contain copy protection signals are played, a blue screen may appear instead of the images. It may take a while when looking for playable images. (For player that cannot

play images that contain a copy protection only.)

⏪/⏩ does not work on menu display.

- ➔ Depending on the disc, you may not be able to use ⏪/⏩ on the player for the disc menu. In this case, use ⏪/⏩ on the remote.

The remote does not function.

- ➔ Batteries in the remote are weak.
- ➔ There are obstacles between the remote and the player.
- ➔ The distance between the remote and the player is too far.
- ➔ The remote is not pointed at the remote sensor on the player.
- ➔ Direct sunlight or strong illumination is striking the remote sensor.
- ➔ When the AUDIO/SUBTITLE/ANGLE buttons do not work, select and operate it from the DVD menu.

The MP3 or JPEG file cannot be played (page 28).

- ➔ The file format does not conform.
- ➔ The extension does not conform.
- ➔ The file is damaged.
- ➔ The file size is too large.

The file or album names are not displayed correctly.

- ➔ The player can only display numbers and alphabet. Other characters are displayed as “*” (page 28).

The player does not operate properly or the power does not turn off.

- ➔ When static electricity, etc., causes the player to operate abnormally, set the POWER switch to “OFF” and disconnect the adaptor and remove the battery pack.

Hookup

There is no picture or sound on the connected equipment.

- ➔ Re-connect the connecting cord securely (page 12).
- ➔ The connecting cord is damaged.
- ➔ Check the setting of a connected TV or amplifier.
- ➔ When “USB” or “Line In” is displayed, press INPUT SELECT repeatedly to select the disc mode (page 7).

There is no picture or sound from a connected equipment.

- ➔ Press INPUT SELECT to select “Line In” (page 12).

USB

The player does not recognize a USB device connected to the player.

- ➔ Re-connect the USB device securely (page 17).
- ➔ The USB device is damaged.
- ➔ Press INPUT SELECT repeatedly to select “USB” (page 17).

Precautions

Road safety

Do not use the monitor unit and headphones while driving, cycling, or operating any motorized vehicle. Doing so may create a traffic hazard and is illegal in some areas. It can also be potentially dangerous to play your headsets at high volume while walking, especially at pedestrian crossings. You should exercise extreme caution or discontinue use in potentially hazardous situations.

On safety

Should any solid object or liquid fall into the cabinet, unplug the player and have it checked by qualified personnel before operating it any further.

On power sources

- If you are not going to use the player for a long time, be sure to disconnect the player from the wall outlet. To disconnect the AC power adaptor, grasp the plug itself; never pull the cord.
- Do not touch the AC power adaptor with wet hands. Doing so may cause shock hazard.
- Use a commercially available AC plug adaptor, if necessary, depending on the design of the wall outlet.

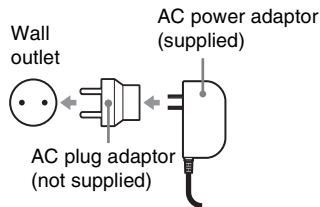

- Do not connect the AC power adaptor to a traveler's electric transformer, which may generate heat and cause a malfunction.

On temperature increases

Heat may build up inside the player during charging or if it is being used for a long time. This is not a malfunction.

On placement

- Do not place the player in a confined space such as a bookshelf or similar unit.
- Do not cover the ventilation of the player with newspapers, tablecloths, curtains, etc. And do not place the player on a soft surface, such as a rug.
- Do not place the player and adaptors in a location near heat sources, or in a place subject to direct sunlight, excessive dust, sand, moisture, rain, or mechanical shock, or in a car with its windows closed.
- Do not place the player in an inclined position. It is designed to be operated in a horizontal position only.
- Keep the player and discs away from equipment with strong magnet, such as microwave ovens, or large loudspeakers.
- Do not drop or apply strong shock. Do not place heavy objects on the player and accessories.

On operation

- If the player is brought directly from a cold to a warm location, or is placed in a very damp room, moisture may condense on the lenses inside the player. Should this occur, the player may not operate properly. In this case, remove the disc and leave the player for about half an hour until the moisture evaporates. Wipe off moisture attached to the LCD surface with tissue etc. Turn on the power again later.
- Keep the lens on the player clean and do not touch it. Touching the lens may damage the lens and cause the player to malfunction. Leave the disc lid closed except when you insert or remove discs.
- Turn off the power before disconnecting the AC power adaptor, the car battery

adaptor or the battery pack. Failure to do so may cause a malfunction.

On Liquid Crystal Display

- Although manufactured with high precision technology, the LCD may occasionally display dots of various colors. That is not a malfunction.
- Do not place or drop any object onto the LCD surface. Also, do not apply pressure from hands or elbows.
- Do not damage the LCD surface with a sharp edged tool.

On battery pack

- Certain countries may regulate disposal of the battery used to power this product. Please consult with your local authority.
- Because of the battery's limited life, its capacity gradually deteriorates over time and repeated use. Purchase a new one when the battery holds about only half the normal period.
- The battery may not be charged to its fullest capacity when charged for the first time, or when it has not been used for a long time. The capacity recovers after being charged and discharged several times.
- Do not leave the battery pack in a car or direct sunlight, where temperature goes up above 60 °C (140°F).
- Do not expose to water.
- Avoid short-circuiting the battery connecting jacks with metal objects such as a necklace.
- Make sure dust or sand does not enter the battery connecting jacks and the guide holes located on the bottom of the player.

On AC power adaptor and car battery adaptor

- Use the supplied adaptors for the player, as other adaptors may cause a malfunction.
- Do not disassemble or reverse-engineer.

→ continued

- Do not touch the metal parts, as it may cause a short and damage the adaptors, especially if touched by other metal objects.

On adjusting volume

Do not turn up the volume while listening to a section with very low level inputs or no audio signals. If you do, the speakers may be damaged when a peak level section is played.

On headphones

- Preventing hearing damage: Avoid using headphones at high volumes. Hearing experts advice against continuous, loud, and extended play. If you experience a ringing in your ears, reduce the volume or discontinue use.
- Showing consideration for others: Keep the volume at a moderate level. This will allow you to hear outside sounds and still be considerate to the people around you.

On cleaning

- Clean the cabinet, panel, and controls with a soft cloth slightly moistened with a mild detergent solution. Do not use any type of abrasive pad, scouring powder or solvent such as alcohol or benzine.
- Wipe the LCD surface with the soft dry cloth lightly. To prevent dirt buildup, wipe it frequently.
Do not wipe the LCD surface with a wet cloth. If water enters, a malfunction may result.
- If picture/sound is distorted, the lens may be covered with dust. In this case, use a commercially-available blower brush for camera lenses to clean the lens.
Avoid touching the lens directly during cleaning.

On cleaning discs, disc/lens cleaners

Do not use cleaning discs or disc/lens cleaners (including wet or spray types). These may cause the apparatus to malfunction.

Notes About the Discs

- To keep the disc clean, handle the disc by its edge. Do not touch the surface.













- Do not expose the disc to direct sunlight or heat sources such as hot air ducts, or leave it in a car parked in direct sunlight as the temperature may rise considerably inside the car.
- After playing, store the disc in its case.
- Clean the disc with a cleaning cloth.
Wipe the disc from the center out.



- Do not use solvents such as benzine, thinner, disc/lens cleaners, or anti-static spray intended for vinyl LPs.
- If you have printed the disc's label, dry the label before playing.
- Do not use the following discs:
 - A disc that has a non-standard shape (e.g., card, heart).
 - A disc with a label or sticker on it.
 - A disc that has cellophane tape or sticker adhesive on it.

Playable Media

Type	Disc Logo	Icon	Characteristics
DVD	     		<ul style="list-style-type: none"> • Commercial DVD • DVD+RWs/DVD+Rs/ DVD+R DLs in +VR mode • DVD-RWs/DVD-Rs/ DVD-R DLs in video mode
			DVD-RWs/DVD-Rs/DVD-R DLs in VR (Video Recording) mode
CD			<ul style="list-style-type: none"> • Music CDs • CD-Rs/CD-RWs in music CD format
DATA disc or USB	—		DATA CD/DATA DVD or USB devices containing MP3 or JPEG files.



Notes about recordable media

Some recordable media cannot be played on the player due to the recording quality or physical condition of the media, or the characteristics of the recording device and authoring software.

The disc will not play if it has not been correctly finalized. For more information, refer to the operating instructions for the recording device. Note that some playback functions may not work with some DVD+RWs/+Rs/+R DLs, even if they have been correctly finalized. In this case, view the disc by normal playback.

For player that cannot play images that contain a copy protection only

Images in DVD (VR mode) with CPRM* protection may not be played if they contain a copy protection signal. "Copyright Lock" appears.

* CPRM (Content Protection for Recordable Media) is a coding technology that protects the copyright of images.

Notes on MP3 and JPEG files

- The player can play the following files:
 - MP3 files with the extension “.mp3”^{*1}.
 - JPEG files with the extension “.jpg”^{*2}.
 - JPEG image files that conform to the DCF (Design rule for Camera File system) image file format.
- DATA CDs must be recorded according to ISO 9660 Level 1, or its extended format, Joliet.
- DATA DVDs must be recorded according to UDF (Universal Disk Format).

^{*1} Files in mp3PRO format cannot be played.

^{*2} Files with the extension “.jpe” or “.jpeg” can be played by changing the extension to “.jpg.”



- To play a complex hierarchy of folders may take some time. Create albums as follows:
 - The number of hierarchies in the media should be no more than two.
 - The number of albums in the media should be 50 or less.
 - The number of files in one album should be 100 or less.
 - The total number of albums and files in the media should be 600 or less.
- The player plays the files in an album in the order the media was recorded.



- The player will play any file in the above table, even if the file format differs. Playing such data may generate noise that can result in speaker damage.
- Some DATA discs created in Packet Write format cannot be played.
- Some DATA discs created in multiple sessions may not be playable.
- Some JPEG files cannot be played.
- The player cannot play the JPEG file that is larger than 3078 (width) x 2048 (height) in normal mode, or larger than 2000 (width) x 1200 (height) in progressive JPEG. (Some progressive JPEG files cannot be displayed even if the size is within this specified capacity.)

- The player can display a file or album name up to 14 characters. Special character appears as “*.”
- The player can display only the currently playing album name.
- Playback information of some files may not be displayed correctly.

Notes on commercial discs

Region code

It is the system that is used to protect copyrights. The region code is shown on the DVD VIDEO packages according to the region of sale. DVD VIDEOS labeled “ALL” or “1” will play on the player.



DVD playback operations

Some playback operations of DVDs may be intentionally set by software producers. Since the player plays DVDs according to the disc contents the software producers designed, some playback features may not be available. Also, refer to the instructions supplied with the DVDs.

Notes on discs

This product is designed to playback discs that conform to the Compact Disc (CD) standard.

DualDiscs and some music discs encoded with copyright protection technologies do not conform to the Compact Disc (CD) standard. Therefore, these discs may not be compatible with this product.

Specifications

System

Laser: Semiconductor laser

Signal format system: NTSC

Inputs/Outputs

VIDEO (video input/output):

Minijack

AUDIO (audio input/output):

Stereo minijack

PHONES (headphones) A/B:

Stereo minijack

USB: USB jack Type A (For connecting USB memory)

Liquid Crystal Display

Panel size: 9 inches wide (diagonal)

Driving system: TFT active matrix

Resolution: 800 × 480 (effective pixel rate: more than 99.99%)

General

Power requirements:

DC 9.5 V (AC power Adaptor/Car battery adaptor)

DC 7.4 V (Battery pack)

Power consumption (DVD VIDEO Playback):

6.5 W (when used with a headphone)

Dimensions (approx.):

227 × 34.4 × 170.8 mm (9 × 1 ³/₈ × 6 ³/₄ inches) (width/height/depth) incl. projecting parts

Mass (approx.): 880 g (1.94 lbs)

Operating temperature: 5 °C to 35 °C (41°F to 95°F)

Operating humidity: 25 % to 80 %

AC Power Adaptor: 110-240 V AC, 50/60 Hz

Car Battery Adaptor: 12 V DC

Supplied accessories

See page 9.

Specifications and design are subject to change without notice.

Index

Numerics

- 16:9 19
- 4:3 Letter Box 19
- 4:3 Pan Scan 19

A

- Angle Mark 7, 20
- Audio 8, 20
- Audio DRC 20
- Audio Setup 20

C

- CD 13, 27
- Charging time and playing time 10

D

- DATA 16, 27
- Disc Menu 20
- DVD 13, 27

G

- General Setup 19

J

- JPEG 16, 28

L

- Language Setup 20
- LCD Aspect 18
- LCD Mode 18

M

- MP3 16, 28

O

- OSD (On-Screen Display) 20

P

- Parental Control 21
- Password 21
- Playable Media 27
- Playback Information Display 15

R

- Random Play 14
- Region code 28
- Repeat Play 14
- Resume Play 14

S

- Screen Saver 14, 20
- Setup 19
- Slide Show 17
- Subtitle 8, 20

T

- Troubleshooting 22
- TV Display 19

U

- USB 17

Índice

Este manual explica los preparativos y el funcionamiento básico del reproductor portátil de CD/DVD. Para obtener más información, consulte el Manual de Instrucciones en inglés.

Preparativos	3
Control de accesorios	3
Carga de la batería	3
Uso del adaptador para batería de automóvil	5

Reproducción	6
Reproducción de discos	6
Rotación y plegado del panel LCD	8

Control de accesorios

Compruebe que dispone de los siguientes elementos:

- Batería (NP-FX110) (1)
- Adaptador de alimentación de CA (1)
- Adaptador para batería de automóvil (1)
- Cable de audio/video (clavija mini × 2
↔ clavija fono × 3) (1)
- Control remoto (1)
- Pilas R6 (tamaño AA) (2)

Preparación del control remoto

Inserte dos pilas AA (R6) de manera tal que los extremos ⊕ y ⊖ coincidan con las marcas del interior del compartimiento.

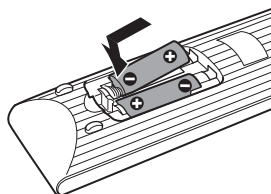

Carga de la batería

Cargue la batería (suministrada) antes de utilizar el reproductor por primera vez o cuando la batería esté agotada.

1 Sujete la batería al reproductor.

Alinee la batería con las líneas ubicadas en la parte inferior del reproductor.

Ubique los ganchos de la batería en los orificios ubicados en la parte inferior del reproductor.

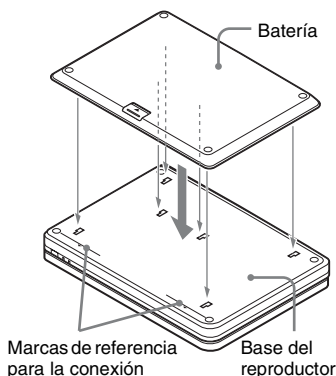

Deslice la batería en la dirección que indica la flecha hasta que se ajuste con un clic.

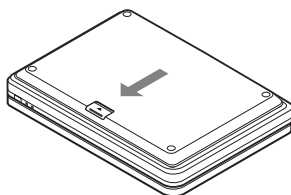

2 Conecte el adaptador de alimentación de CA.

Cuando comienza el proceso de carga, se enciende la luz naranja del indicador CHARGE.

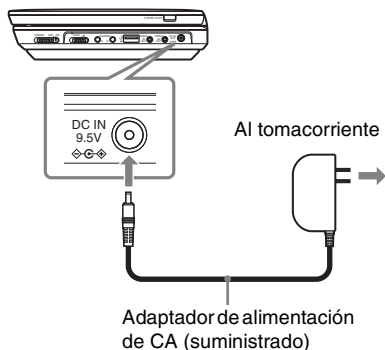

Cuando termina el proceso de carga, el indicador CHARGE se apaga. Desconecte el adaptador de alimentación de CA.



Si se enciende el indicador POWER en vez del indicador CHARGE, el interruptor POWER está ubicado en "ON". Ubique el interruptor POWER en "OFF" y asegúrese de que el indicador CHARGE se encienda.



Cargue la batería a una temperatura ambiente de entre 5 °C (41 °F) y 35 °C (95 °F).

Tiempo de carga y tiempo de reproducción

Tiempo de carga: aproximadamente 6 horas

Tiempo de reproducción: aproximadamente 7.5 horas

Los tiempos indicados dependen de las siguientes condiciones:

- Temperatura normal (20 °C (68 °F))
- Uso de auriculares
- Configuración del ajuste de luz de fondo al mínimo

El tiempo de carga puede ser mayor o el tiempo de reproducción puede reducirse, según el estado de la batería y la temperatura ambiente.

Para controlar el nivel de batería

El indicador de batería se muestra cuando el reproductor está detenido.

Cuando la batería esté vacía, aparecerá el símbolo o el indicador CHARGE parpadeará. Coloque el interruptor POWER en "OFF", conecte el adaptador de alimentación de CA y recargue la batería.

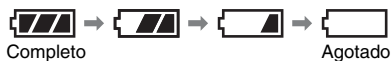

Para retirar la batería

Empuje la lengüeta de liberación y deslice la batería en la dirección que indica la flecha.

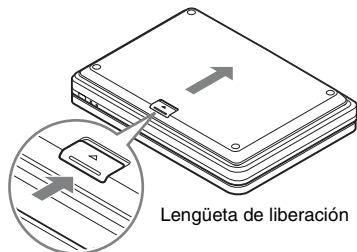

Uso del adaptador para batería de automóvil

El adaptador para batería de automóvil (suministrado) está diseñado para una batería de automóvil de 12 V, con conexión a tierra negativa (no lo utilice con baterías de automóvil de 24 V y conexión a tierra positiva).

1 Arranque el motor.

2 Conecte el adaptador para batería de automóvil.

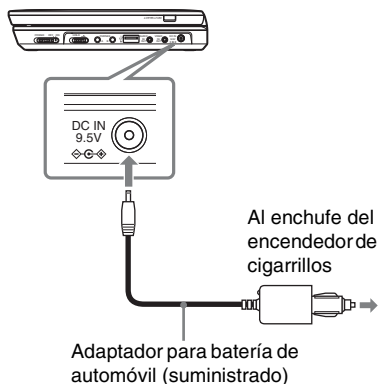

3 Encienda el reproductor.

- ⚡ El conductor no debe conectar ni desconectar el adaptador para batería de automóvil mientras conduce.
- Arregle el cable de manera que no moleste al conductor. Además, no coloque el panel LCD donde el conductor pueda verlo.
- Limpie el enchufe del encendedor de cigarrillos. Si está sucio, puede causar fallas en el contacto o el funcionamiento.

- Use el adaptador para batería de automóvil con el motor del vehículo en funcionamiento. Si se utiliza con el motor del vehículo apagado, la batería del automóvil puede agotarse.

Después de usar el reproductor en el vehículo

- 1 Apague el reproductor.
- 2 Desconecte el adaptador para batería de automóvil.
- 3 Apague el motor.



- No desconecte el adaptador para batería de automóvil ni apague el motor del vehículo antes de que haya apagado el reproductor. De lo contrario, puede dañar el reproductor.
- Desconecte el adaptador para batería de automóvil después de usarlo. Si lo deja conectado, la batería del automóvil puede agotarse.
- No deje el reproductor ni los accesorios en el auto.

Reproducción de discos

DVDVideo DVDVR CD DATA

De acuerdo con el disco, algunas operaciones pueden ser diferentes o estar restringidas. Consulte las instrucciones de operación proporcionadas con el disco. Conecte el adaptador de alimentación de CA o la batería.

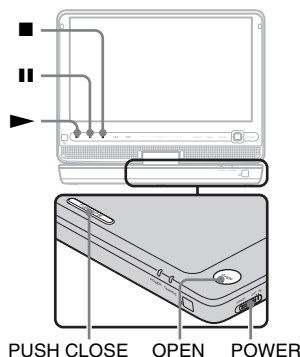

- 1** Abra el panel LCD.
- 2** Deslice el interruptor POWER a "ON".
El reproductor se enciende y el indicador POWER se muestra verde.
- 3** Presione OPEN para abrir la tapa del disco.

4 Inserte el disco a reproducir.

Ubíquelo con la cara de reproducción hacia abajo y empuje suavemente hasta que se ajuste con un clic.

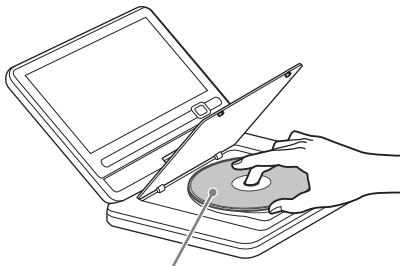

La cara de reproducción debe mirar hacia abajo

5 Presione el PUSH CLOSE en la tapa del disco para cerrarla.

6 Presione ►.

El reproductor comienza la reproducción.
De acuerdo con el disco, puede aparecer un menú. Presione ◀/▶/⏪/⏩ para seleccionar el elemento y presione ENTER.

Para detener la reproducción

Presione ■.

Para poner en pausa la reproducción

Presione ■■.



Al reproducir un disco después de observar las imágenes mediante "Entrada De Línea" o "USB", pulse INPUT SELECT.



- Los discos creados en grabadoras de DVD deben finalizarse correctamente para reproducirlos en este reproductor. Para más información sobre la finalización, consulte las instrucciones de operación suministradas con la grabadora de DVD.
- El disco todavía puede estar girando al abrir la tapa del disco. Espere hasta que el disco se detenga antes de retirarlo.

Para reanudar la reproducción desde donde detuvo el disco (Reanudar reproducción) **DVDVideo** **DVDVR** **CD**

Cuando vuelve a presionar **▶** después de detener la reproducción, el reproductor comienza con la reproducción desde donde presionó **■**.



- Para iniciar la reproducción desde el principio del disco, presione **■** dos veces y luego **▶**.
- Al encender nuevamente el reproductor después de apagarlo, la reproducción se reanuda automáticamente.



- Dependiendo del lugar donde se detuvo, la reproducción puede no comenzar desde exactamente el mismo punto.
- El punto donde detuvo la reproducción se borra cuando:
 - usted abre la tapa del disco.
 - presiona INPUT SELECT.
 - desconecte el adaptador o retire la batería antes de desactivar el reproductor.

Notas sobre el salva pantalla

- Un salva pantalla aparece cuando deja el reproductor en modo detenido o en pausa sin funcionar durante más de 15 minutos. La imagen desaparece cuando usted presiona **▶**.
- El reproductor queda en modo de espera durante 15 minutos después de comenzar la función de salva pantalla. Presione **▶** para salir del modo de espera.

Información sobre varias operaciones de reproducción

Para	Operación
Cambiar el tamaño de la imagen LCD	Presione OPTIONS para seleccionar "Modo LCD".
Mostrar el menú del DVD	Presione MENU o TOP MENU .
Verificar la información de reproducción del DVD	Presione DISPLAY .
Reproducir un DVD* repetidamente (Repetir reproducción)	Presione DISPLAY para seleccionar "Repetir".
Reproducir el DVD en retroceso o avance rápido (Reproducción rápida)	Presione ←/→ repetidamente en el reproductor para seleccionar la velocidad.
Alternar entre original y Lista de reproducción en DVD (modo VR)	Presione TOP MENU repetidamente.
Cambiar la información de reproducción del CD	Presione DISPLAY repetidamente.
Reproducir un CD repetidamente (Repetir reproducción)	Presione MENU repetidamente.
Reproducir un CD en forma aleatoria (Reproducción aleatoria)	Presione MENU repetidamente.

Para	Operación
Reproducir el CD en retroceso o avance rápido (Reproducción rápida)	Presione \leftarrow/\rightarrow repetidamente en el reproductor para seleccionar la velocidad.

* DVD VIDEO solamente

Rotación y plegado del panel LCD

Abra el panel LCD en la posición vertical y luego rótelo lentamente 180 grados siguiendo la dirección que indica la flecha (en sentido de las agujas del reloj).

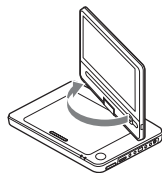

Después de rotar el panel LCD 180 grados en sentido horario, empuje el panel LCD hacia abajo sobre la carcasa del reproductor. En esta posición, el panel queda mirando hacia arriba.

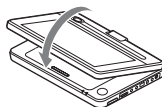

Para volver a colocar el panel LCD en su posición original

Abra el panel LCD en la posición vertical y rótelo lentamente en sentido antihorario.



- No rote el panel LCD más de 180 grados. Además, no lo rote en la dirección contraria. Si lo hace, el panel LCD se romperá.
- Coloque el panel LCD nuevamente en su posición original después de usarlo para que éste no se dañe por sacudidas violentas o un tratamiento similar.
- No rote el panel LCD cuando esté cerrado o en otra posición que no sea vertical. Podría rayar el reproductor.

4-169-963-11(1)



* 1 - 4 1 6 9 9 6 3 1 1 8 *

Sony Corporation Printed in China

<http://www.sony.net/>

Download from [Www.Somanuals.com](http://www.Somanuals.com). All Manuals Search And Download.

Free Manuals Download Website

<http://myh66.com>

<http://usermanuals.us>

<http://www.somanuals.com>

<http://www.4manuals.cc>

<http://www.manual-lib.com>

<http://www.404manual.com>

<http://www.luxmanual.com>

<http://aubethermostatmanual.com>

Golf course search by state

<http://golfingnear.com>

Email search by domain

<http://emailbydomain.com>

Auto manuals search

<http://auto.somanuals.com>

TV manuals search

<http://tv.somanuals.com>