

# *AIT Drive*

---

User's Guide

*SDX-400 Series*  
*SDX-410 Series*

This document contains proprietary information which is protected by copyright.

All rights reserved. No part of this document may be photocopied, reproduced or translated to another language without prior written consent of Sony.

The information contained in this document is subject to change without notice.

**SONY MAKES NO WARRANTY OF ANY KIND WITH REGARD TO THIS DOCUMENT.**

Sony shall not be liable for error contained herein, indirect, special, incidental or consequential damages in connection with the furnishing, performance or use of this document.

## **VORSICHT**

Diese Ausrüstung erfüllt die Europäischen EMC-Bestimmungen für die Verwendung in folgender / folgenden Umgebung(en):

- Wohngebieten
- Gewerbegebiete
- Leichtindustrialgebiete

(Diese Ausrüstung erfüllt die Bestimmungen der Norm EN55022, Klasse B.)

## 사용자 안내문

이 기기는 가정용으로 전자파 적합등록을 한 기기로서 주거지역에서는 물론 모든 지역에서 사용할 수 있습니다.

---

# Contents

Introduction .....	4
Product Features .....	4
Precautions .....	5
Installation .....	7
SCSI Connection/Setting the SCSI ID .....	7
Option Switches (DIP Switch) ..	8
Mounting Holes .....	9
Remodeling from 5.25" Model to 3.5" Model .....	12
Orientation .....	13
Operation .....	14
Location of 3 LEDs .....	14
LED Indication for Drive Status .....	15
Drive Operation .....	16
Emergency Tape Removal Procedure .....	17
Interface Implementation .....	20
Supported SCSI Messages .....	20
Supported SCSI Commands .....	20
Specification .....	21
Product Specifications .....	21
Third Party Support Contacts (In the USA) .....	23
Sony Contacts .....	25

---

# SDX-400 Tape Drive

The Sony SDX-400 series drive is a high capacity data storage device using Advanced Intelligent tape (AIT) technology. The SDX-400 series drive achieves high data reliability through Read-After-Write, an additional level of Error Correction Code, and other features.

The Sony SDX-400 series drive stores data on tape using a standard format called AIT (Advanced Intelligent Tape) and ALDC formats.

# Introduction

## Product Features

	SDX-400 series
Data Capacity	35 GB uncompressed (with AIT-1 230 m tape) 91 GB compressed* (with AIT-1 230 m tape)
Transfer Rate (sustained)	4 MB/s uncompressed

\* Assuming a 2.6 : 1 compression ratio.

(The compression ratio varies according to the type of data.)

- Supported Format : AIT-1
- Burst Transfer Rate
  - 12 MB/s Asynchronous
  - 40 MB/s Synchronous
- Large 10 MB Buffer Memory
- 3.5” Standard Height, 5.25” Half Height
- Embedded SCSI Interface  
(ULTRA/WIDE and LVD/SE model (SDX-400C) or HVD model (SDX-410C) are available)
- Supports Variable or Fixed Record Length
- Supports SCSI Disconnection/Arbitration
- Frame Rewrite Function
- Three levels of Error Correction Code (ECC)
- High Speed search (120 times normal Read/Write speed)
- Random Read, Append Write

## Precautions

### Installation

Avoid placing the drive in a location subject to:

- high humidity
- high temperature
- mechanical shock and vibration
- direct sunlight

### Operation

- Do not move the drive while it is operating. It may cause malfunction.
- Avoid exposing the drive to sudden changes from a low to high in temperature. This may cause water condensation to collect inside the drive. If the ambient temperature should suddenly rise while the drive is turned on, wait at least one hour before turning on the drive. If you attempt to operate the drive immediately after a sudden increase in temperature, a malfunction may occur.
- Turning off the power to the drive while it is writing to tape may cause the tape to become unreadable. All previously negotiated parameters will be lost, whenever power to the drive is cycled.

### Transportation

- Keep the original packing materials to facilitate transportation of the drive.
- Always remove the tape before moving the drive. After removing the drive from the computer, repack the drive into its original packing.

## Notice of SCSI Termination

The SDX-400C conforms to the Microsoft PC97 standard which requires the internal (naked) drive to be terminated with an external terminator.

### Microsoft PC97 SCSI requirements

SCSI peripherals must not terminate the bus. Both internal and external cable ends are instead terminated by plug-in connectors.

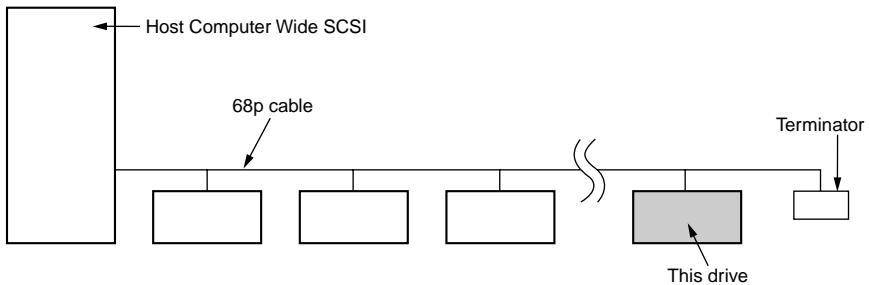

**Example of SCSI set-up**

# Installation

## SCSI Connection/Setting the SCSI ID

SCSI ID	
SCSI ID	P.D. N.C. 3 2 1 0
0	<input type="checkbox"/> <input type="checkbox"/> <input checked="" type="checkbox"/> <input checked="" type="checkbox"/>
1	<input type="checkbox"/> <input type="checkbox"/> <input checked="" type="checkbox"/> <input type="checkbox"/>
2	<input type="checkbox"/> <input type="checkbox"/> <input checked="" type="checkbox"/> <input type="checkbox"/>
3	<input type="checkbox"/> <input type="checkbox"/> <input type="checkbox"/> <input checked="" type="checkbox"/>
4	<input type="checkbox"/> <input type="checkbox"/> <input type="checkbox"/> <input checked="" type="checkbox"/>
5	<input type="checkbox"/> <input type="checkbox"/> <input type="checkbox"/> <input type="checkbox"/>
6	<input type="checkbox"/> <input checked="" type="checkbox"/> <input type="checkbox"/> <input type="checkbox"/>
7	<input type="checkbox"/> <input checked="" type="checkbox"/> <input type="checkbox"/> <input type="checkbox"/>
8	<input type="checkbox"/> <input type="checkbox"/> <input checked="" type="checkbox"/> <input checked="" type="checkbox"/>
9	<input type="checkbox"/> <input type="checkbox"/> <input checked="" type="checkbox"/> <input type="checkbox"/>
10	<input type="checkbox"/> <input type="checkbox"/> <input type="checkbox"/> <input checked="" type="checkbox"/>
11	<input type="checkbox"/> <input type="checkbox"/> <input checked="" type="checkbox"/> <input type="checkbox"/>
12	<input type="checkbox"/> <input type="checkbox"/> <input type="checkbox"/> <input checked="" type="checkbox"/>
13	<input type="checkbox"/> <input type="checkbox"/> <input type="checkbox"/> <input type="checkbox"/>
14	<input type="checkbox"/> <input type="checkbox"/> <input type="checkbox"/> <input checked="" type="checkbox"/>
15	<input type="checkbox"/> <input type="checkbox"/> <input type="checkbox"/> <input type="checkbox"/>

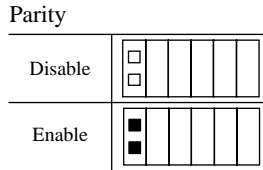
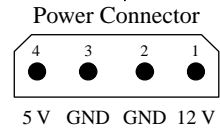
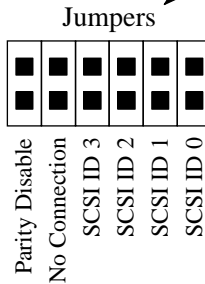
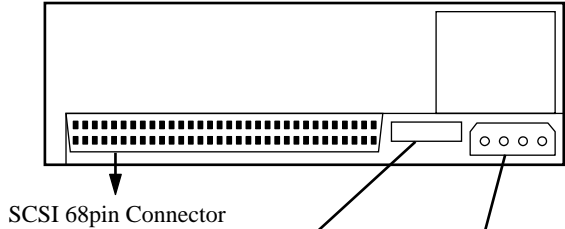

**Note :**  = CLOSED/Jumper  
 = OPEN/Jumper not installed  
 Don't care

### Parity Disable Jumper

Parity check function can be disabled by Jumper. Parity check is disabled while left end jumper is installed. Parity generate function is always enabled.

## Option Switches (DIP Switch)

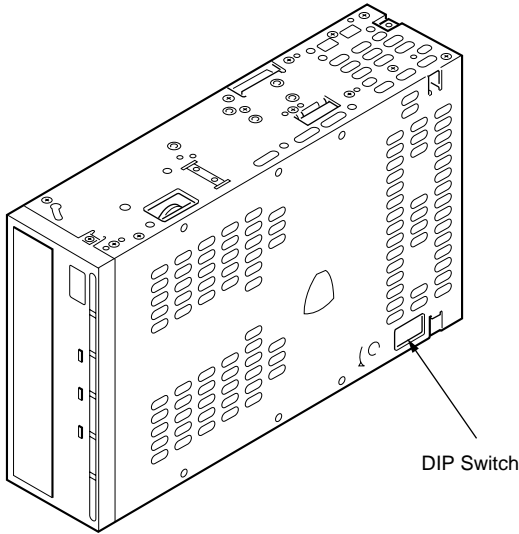

### DIP Switch Positions

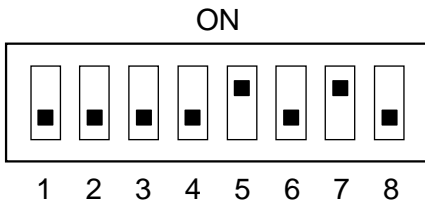

- 1 Reserved (OFF)
- 2 Reserved (OFF)
- 3 Reserved (OFF)
- 4 Reserved (OFF)
- 5 Terminator Power (ON)
- 6 Reserved (OFF)
- 7 DC Control (1) (ON)
- 8 DC Control (2) (OFF)

### Data Compression Control DIP switch

Data compression can be selected by DIP switches. Data compression is enabled while position 7 [DC Control (1)] is ON. Control by host can be disabled when position 8 [DC Control (2)] is ON.



# Mounting Holes

For 3.5" Standard Height (SDX-400C)

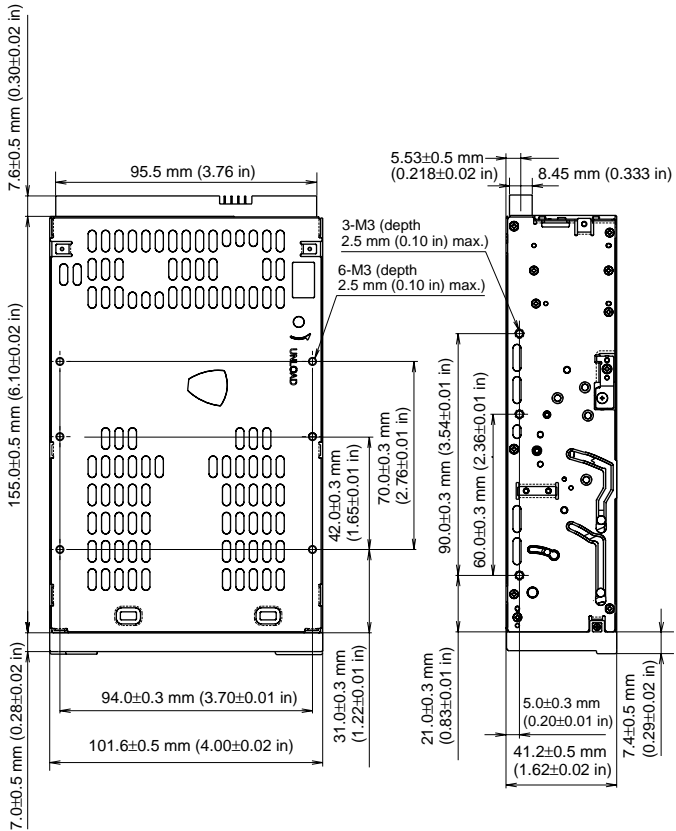

# For 3.5" Standard Height (SDX-410C)

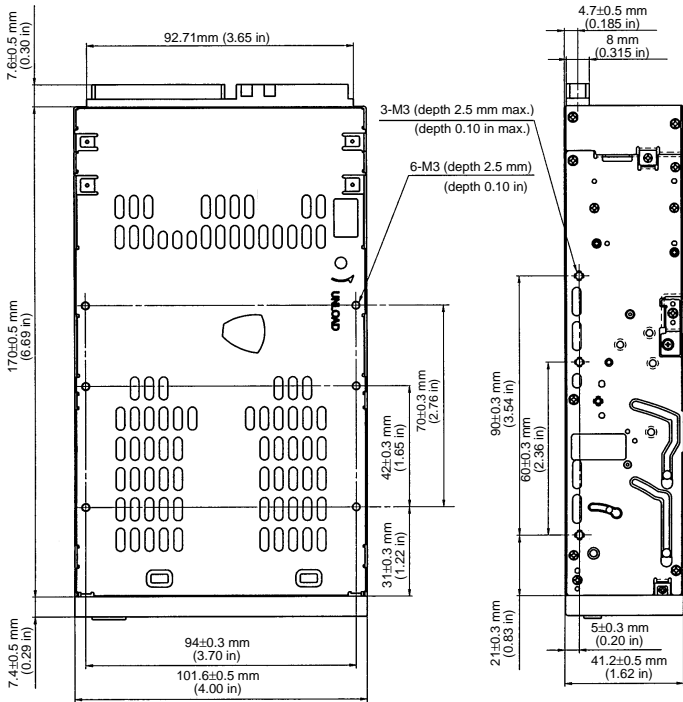

# For 5.25" Half Height (SDX-400C/R)

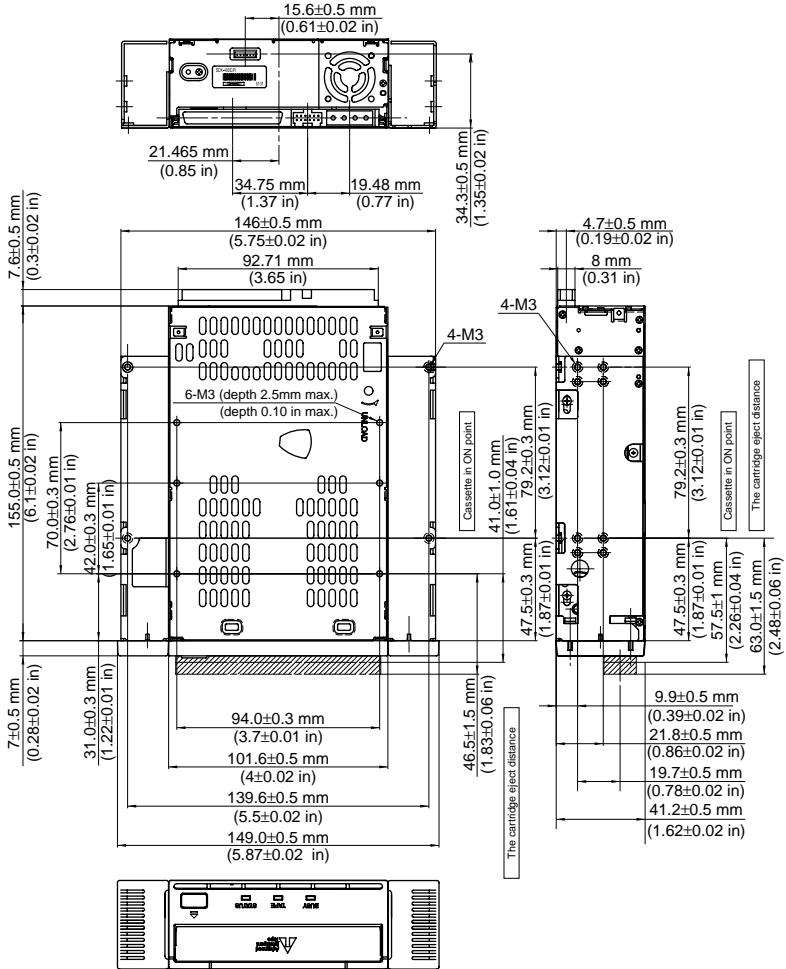

## Remodeling from 5.25" Model to 3.5" Model

You can remodel the SDX-400C/R (5.25" model) to the SDX-400C (3.5" model) yourself.

- 1** Remove the 2 screws for each side rail.
- 2** Take the side rail off.

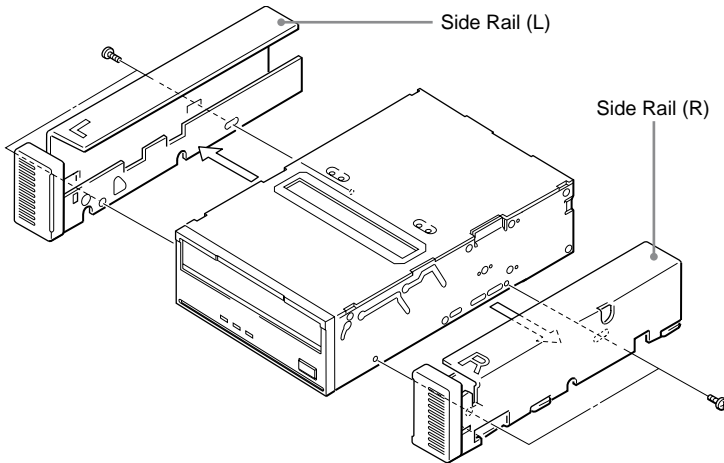

## Orientation

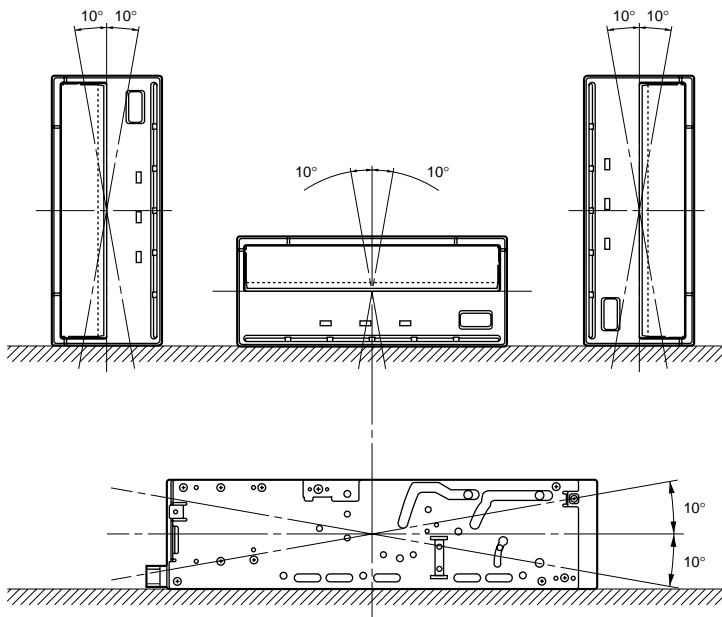

---

# Operation

## Location of 3 LEDs

There are three LED indications (BUSY, TAPE and STATUS) and an EJECT button on the front panel of the unit.

### Front Panel (for 3.5" Standard Height)

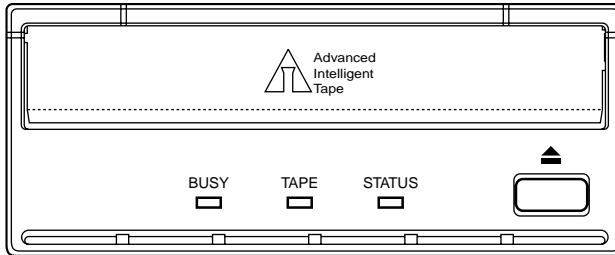

## LED Indication for Drive Status

The LED indicators are defined as follows.

LED			State		
BUSY	TAPE	STATUS	Activity	Cartridge	Other
			None	None	None
			SCSI	None	None
			Drive	Loading/Unloading	None
			Drive	Loading/Unloading	Write Protected
			None	Loaded	Cleaning Tape at EOM
			None	Loaded	None
			SCSI	Loaded	None
			SCSI/Drive	Loaded	None
Independent			*	Loaded	Write Protected
Independent		Independent	*	Loaded	Error Rate Warning
*	*		*	*	Cleaning Request
*	*		*	*	Self test Failure
	*	*	*	*	Waiting for Reset
*		*	*	*	Waiting for Eject

\* : Not defined.



## Drive Operation

### Loading a Tape

Insert a cassette into the slot on the front panel with the arrow on the cassette pointing towards the drive. As the cassette is inserted, the drive takes it and automatically loads it into drive mechanism.

### Unloading a Tape

The cassette can be removed from the SDX-400/SDX-410 either in response to a SCSI Unload Command, or by pressing the eject bottom.

By pressing Eject button, the tape goes to BOT, the drive unthreads it, and ejects the cassette from the slot.

### Write-protecting a Tape

Cassettes can be write-protected by sliding the tab on the back of the cassette. In this state, data can be read from the tape but not written onto it.

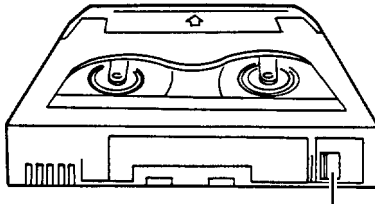

AIT-1



Using your fingernail, push the switch in the direction of the arrow to protect the tape from writing or accidental erasure.



Return the switch to its original position to re-enable writing.

### Using a Cleaning Cassette

In case of SDX-400 series/SDX-410 series, a cleaning function is built into the drive and hence the use of a cleaning cartridge is not needed. If however the drive experiences excessive errors, the use of a cleaning cartridge is recommended.



## Emergency Tape Removal Procedure

- 1** Remove the drive from the chassis or enclosure to allow access to the bottom and right side of the drive.
- 2** Remove the drive's top cover.
- 3** Locate the small opening in the bottom of the drive and insert the tip of a precision screwdriver so that the Threading motor shaft can be rotated.
- 4** Rotate the motor shaft counterclockwise to bring the threading mechanism back to the initial position. (Refer to the photo-1 on page 19.)
- 5** Before manual eject procedure, tape slack must be removed in order to prevent tape damage. Press and rotate the gear mechanism located on the right side of the drive clockwise to tighten the tape.
- 6** After the tape slack has been removed, turn the screw located on the right side of the drive clockwise by a precision screwdriver until the tape cartridge is lifted out of the drive mechanism and is ejected.

## 7 Return the drive to Sony for repair.

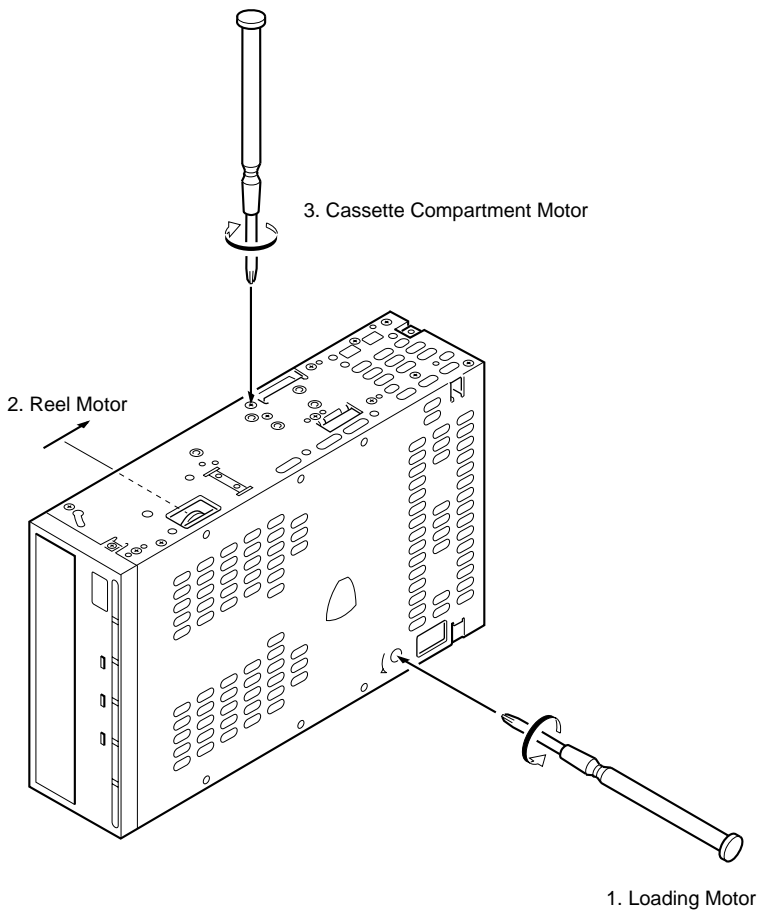

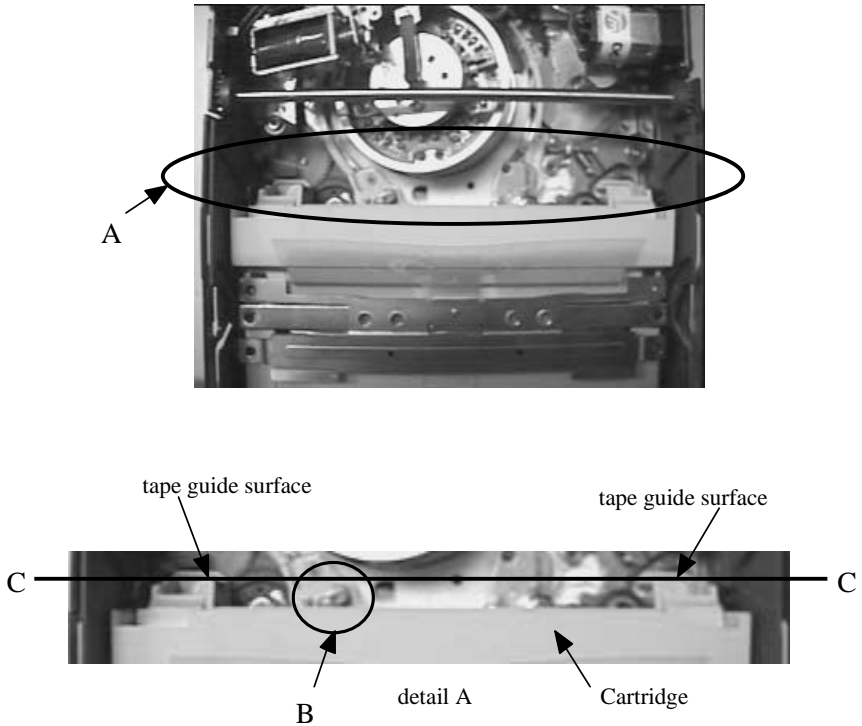

**Photo-1: The Initial Position of the Threading Mechanism**

**Caution**

Stop rotating the motor shaft immediately, when the guide B (see detail A of Photo-1) gets to the area below the line C-C (This line is defined by 2 circular tape guide surfaces of the cartridge). Otherwise the gear of the drive can be damaged.

---

# Interface Implementation

## Supported SCSI Messages

Abort	Message Parity Error
Bus Device Reset	Message Reject
Command Complete	No Operation
Disconnect	Restore Pointers
Extended Message	Save Data Pointer
– Synchronous Data Transfer Request	
– Wide Data Transfer Request	
Identify ( w/&w/o Disconnect )	
Ignore Wide Residue	

## Supported SCSI Commands

Erase	Receive Density Support
Inquiry	Report Luns
Load/Unload	Request Block Address
Locate	Request Sense
Log Sense	Reserve Unit
Log Select	Rewind
Mode Select	Seek Block
Mode Sense	Send Diagnostic
Prevent Allow Medium Removal	Space
Read	Test Unit Ready
Read Block Limits	Verify
Read Buffer	Write
Read Position	Write Buffer
Report Diagnostic Result	Write Filemarks
Release Unit	

# Specification

## Product Specifications

### Dimensions

	SDX-400C	SDX-410C	SDX-400C/R
Height	41.2 mm (1.62 in)	41.2 mm (1.62 in)	41.2 mm (1.62 in)
Width	101.6 mm (4.0 in)	101.6 mm (4.0 in)	146.0 mm (5.75 in)
Depth	155.0 mm (6.1 in)	170.0 mm (6.7 in)	155.0 mm (6.1 in)

### Altitude

Operating	0 to 10,000 feet
-----------	------------------

### Vibration

Operating	Swept Sine 5 to 500 Hz *0.25 G Peak 1 Octave/min. 3 axes, 3 directions
Non-Operating	Swept Sine 5 to 500 Hz *0.5 G Peak 1 Octave/min. 3 axes, 3 directions

### Acoustic Noise (A) curve weight

Streaming Write/Read	35 db (A)
Insert/Eject	60 db (A)

#### Note

The sound-meter on (A) scale is located 1m in front of the center of the drive front panel.

### Shock

Operating	No Data Loss Half Sine 5 G Peak 3 ms 3 axes, 3 directions *Interval 10 seconds
Non-Operating	No Device Damage Half Sine 90 G Peak 3 ms (30 G Peak 11 ms) 3 axes, 3 directions

## Temperature and Humidity Range

### Temperature

Operating	5 °C to 40 °C ( $\Delta T < 10$ °C/h)
Non-Operating (mech.)	- 40 °C to 70 °C ( $\Delta T < 20$ °C/h)
Non-Operating (tape)	- 40 °C to 45 °C ( $\Delta T < 20$ °C/h)

### Humidity

Operating	20 to 80% RH, non-condensing Maximum wet bulb temperature = 26 °C
Non-Operating (mech.)	5 to 95% RH ( $\Delta T < 30$ %/h)
Non-Operating (tape)	20 to 80% RH ( $\Delta T < 30$ %/h)

## Power Requirements

Model	Voltage	Max Ripple	Current	
			Typical	Maximum
SDX-400 series	5 V +/- 5 %	100 mVp-p	1.3 A	2.5 A
	12 V +/- 10 %	150 mVp-p	0.4 A	1.2 A
SDX-410 series	5 V +/- 5 %	100 mVp-p	1.5 A	2.5 A
	12 V +/- 10 %	150 mVp-p	0.45 A	1.2 A

## Suspended Particulate

Operating	Less than 150 microgram/m <sup>3</sup> Based Sampling period 24 hours
-----------	--

## ESD

Discharge	< 15 kV: No operation failure
Voltage	< 20 kV: No drive damage

## Air-cooling Requirement

Surrounding temperature	< 40 °C
-------------------------	---------

Clean air flow is recommended to minimize the possibility of data loss.

# Third Party Support Contacts (In the USA)

Host Adapter Vendors	Phone Numbers
Adaptec	408-945-8600
ATTO	716-691-1999
Bus Logic	408-492-9090
DPT	407-830-5522
Future Domain	714-253-0400
Initio	408-988-1919
Qlogic	714-438-2200
Ultra Systems Inc.	714-367-8800

Operating Systems	Backup Software Vendors	Phone Numbers
DOS	Arcada	407-333-7500
	Cheyenne	516-484-5110
	Columbia Data Products	407-869-6700
	Corel	613-728-8200
	NovaStor	805-579-6700
	Palindrome	708-505-3300
	ST. Bernard Software	619-676-2277
	Sytron	508-898-0100
Macintosh	Tapedisk	715-235-3388
	Cheyenne	516-484-5110
	Corel	613-728-8200
	Dantz	510-253-3000
OS/2	NovaStor	805-579-6700
	Cheyenne	516-484-5110
	Corel	613-728-8200
	IBM	800-426-3333
	NovaStor	805-579-6700
Windows	Sytron	407-333-7500
	Arcada	407-333-7500
	Cheyenne	516-484-5110
	Corel	613-728-8200
	Creata	909-595-8811
	NovaStor	805-579-6700
	ST. Bernard Software	619-676-2277
Windows NT	Sytron	508-898-0100
	Arcada	407-333-7500
	Cheyenne	516-484-5110
	Creata	909-595-8811
	Microsoft	206-882-8080
	NovaStor	805-579-6700
Windows NT Advanced Server	Avail Systems	303-444-4018
	Microsoft	206-882-8080

\* All phone numbers listed are in the USA.

Add the country code (1) prior to those numbers when calling from outside the USA.

<b>Operating Systems</b>	<b>Backup Software Vendors</b>	<b>Phone Numbers</b>
Windows 95	NovaStor	805-579-6700
DEC Unix	Cheyenne	516-484-5110
	NovaStor	612-933-8790
	Software Moguls	612-933-8790
	Work Station Solutions	603-880-0080
SUN Unix	Legato	415-812-6000
	NovaStor	818-707-9900
	Software Moguls	612-933-8790
	Sun Soft	310-348-8649
	Work Station Solutions	603-880-0080
Solaris Unix	Cheyenne	516-484-3150
	Legato	415-812-6000
	NovaStor	818-707-9900
	Software Moguls	612-933-8790
	Sun Soft	310-348-8649
	Work Station Solutions	603-880-0080
SCO Unix	Cheyenne	516-484-3150
	Legato	415-812-6000
	Software Moguls	612-933-8790
	Work Station Solutions	603-880-0080
NCR Unix	NovaStor	818-707-9900
	Work Station Solutions	603-880-0080
HP Unix	Cheyenne	516-484-3150
	NovaStor	818-707-9900
	Work Station Solutions	603-880-0080
AIX Unix	Cheyenne	516-484-3150
	Legato	415-812-6000
	NovaStor	818-707-9900
	Software Moguls	612-933-8790
	Work Station Solutions	603-880-0080
Interactive Unix	Sun Soft	310-348-8649
SGI Unix	Software Moguls	612-933-8790
	Work Station Solutions	603-880-0080
Novell UNIXware	Novell	801-263-3500
Novell NLM	Arcada	407-263-3500
	Avail Systems	303-444-4018
	Cheyenne	516-484-3150
	Columbia Data Products	407-682-0265
	Creata	909-595-8811
	Legato	415-812-6000
	NovaStor	818-707-9900
	Novell	801-419-5544
	Palindrome	708-505-3300
	Performance Tech	210-979-2110
	ST. Bernard Software	619-676-2277
	Symantec	310-449-4156
	Sytron	508-898-0100
Banyan	Performance Tech	210-979-2110
Lantastic	NovaStor	818-707-9900
Amiga	Moonlighter	407-384-9484
RS6000	Legato	415-812-6000
	NovaStor	818-707-9900
	Software Moguls	612-933-8790



---

# Sony Contacts

**For further information, please contact:**

**Sony Electronics Inc., Technical Support**

3300 Zanker Road San Jose, CA95134, 1940. USA

TEL: (1) 800-801-7927

URL: <http://sony.storagesupport.com/>

E-mail: [tape.support@am.sony.com](mailto:tape.support@am.sony.com)

**Sony Corporation**

**Electronic Devices Marketing Group, Product Marketing Div.**

**Computer Peripherals Dept. Tape Streamer Section**

Osaki Gate City East Tower, 1-11-1, Osaki

Shinagawa-ku, Tokyo, 141-0032 Japan

TEL: (81) 3-5435-3486      FAX: (81) 3-5435-3565

**Sony of Canada Ltd., AV/IT Marketing Group**

**Computer Peripherals Product Marketing**

115 Gordon Baker Road Toronto, Ontario, M2H 3R6 Canada

TEL: (416) 499-1414 or (1) 800-961-7669

FAX: (416) 499-8541

**Sony Computer Peripherals & Components Europe**

URL: <http://www.sonyisstorage.com/>

**Electronics Devices Marketing (Singapore)**

**(A division company of Sony Electronics (S) Pte. Ltd.)**

**Enterprise Storage Solutions Dept.**

2 International Business Park, #01-10 Tower One,

The Strategy, Singapore 609930

TEL:65-6544-8000      FAX:65-6544-7390

**Sony Corporation of Hong Kong Ltd.**

**Computer Peripheral Sales & Marketing Division**

**Electronic Devices Marketing Hong Kong**

45/F, The Lee Gardens, 33 Hysan Avenue, Causeway Bay, Hong Kong

TEL: (852) 2909-1008      FAX: (852) 2909-2001

**Sony Corporation of Hong Kong Ltd. Beijing Rep. Office**

**Computer Peripheral Div.**

Full Link Plaza Tower A 11/F., No.18 Chaoyangmenwai Ave., Beijing  
100020 P.R.C.

TEL:86-10-6588-0558      FAX:86-10-6588-0855

URL: <http://www.sony.com.cn>

**Sony Corporation of Hong Kong Ltd. Shanghai Rep. Office**

44F., HSBC Tower, 101 Yin Cheng East Road, Pudong, New Area,  
Shanghai, P.R.C. Postcode 200120

TEL: 86-21-6841-3222      FAX: 86-21-6841-0280

**Sony Brasil Ltda.**

Rua Inocência Tobias, 125-BlocoA, CEP01144-000, São Paulo -SP-Brasil

TEL: (55) 11-3824-6586 to 6598 FAX: (55) 11-3611-9064

URL: <http://www.sonybrasil.com>

**Sony Australia Ltd., Information Technology Products Division**

P.O. Box 377, NSW 1670, Australia

TEL: 1800-226-429 FAX: (61) 2-9870-8564      A.C.N. 001 215 354

URL: <http://www.sony.com.au/home.asp>

E-mail: [informatica@ssp.br.sony.com](mailto:informatica@ssp.br.sony.com)

**Sony Chile Ltda**

Av. Kennedy 8017, Las Condes, Santiago, Chile

TEL: (02) 210-6000      FAX: (02) 210-5417

**Sony Taiwan Limited****Optical Devices Storage Dept. Data Storage Section**

5F, 145 Changchun Road, Taipei 104, Taiwan

TEL: 886-2-2522-7920      FAX: 886-2-2522-2153

**Sony Korea Corporation EDMK CP Sales & Marketing Team**

34F, ASEM Tower, World Trade Center, 159-1, Samsung-Dong,  
Kangnam-Ku, Seoul, 135-798, Korea

TEL: 82-2-6001-4249      FAX: 82-2-6001-4115

URL: <http://www.sony.co.kr/cp/>

**Sony Gulf FZE Computer Display & Peripheral Div.**

P.O.BOX 16871, Jebel Ali, Dubai, U.A.E.

TEL: 971-4-8815488 or 8816912      FAX: 971-4-8817210 or 8816259

**Sony Marketing of Japan**

Business Solution Dept. Server Solution Marketing Section

URL: <http://www.sony.co.jp/STORAGE>



<http://www.sony.net/>

Printed on recycled paper

Printed in Japan

Download from [Www.Somanuals.com](http://www.somanuals.com). All Manuals Search And Download.

## Free Manuals Download Website

<http://myh66.com>

<http://usermanuals.us>

<http://www.somanuals.com>

<http://www.4manuals.cc>

<http://www.manual-lib.com>

<http://www.404manual.com>

<http://www.luxmanual.com>

<http://aubethermostatmanual.com>

Golf course search by state

<http://golfingnear.com>

Email search by domain

<http://emailbydomain.com>

Auto manuals search

<http://auto.somanuals.com>

TV manuals search

<http://tv.somanuals.com>