

Digital Photo Printer

DPP-FP55

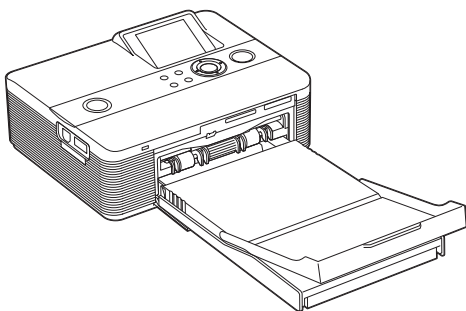

Operating Instructions

Before operating this printer, please read this manual thoroughly and retain it for future reference.

Owner's Record

The model and serial numbers are located on the bottom. Record the serial number in the space provided below. Refer to these numbers whenever you call upon your Sony dealer regarding this product.

Model No. DPP-FP55

Serial No. _____

Before you begin

Preparations

Making basic printing

Making various printing

Printing from a PictBridge camera

Printing from a PC

Troubleshooting

Additional information

**SUPER
COAT 2**

MEMORY STICK™

 **PictBridge**

WARNING

To reduce fire or shock hazard, do not expose the unit to rain or moisture.

For the customers in the U.S.A. CAUTION

You are cautioned that any changes or modifications not expressly approved in this manual could void your authority to operate this equipment.

If you have any questions about this product, you may call:

*Sony Customer Information Services Center
1-800-222-SONY (7669)*

The number below is for the FCC related matters only.

Regulatory Information

Declaration of Conformity

Trade Name: SONY

Model No.: DPP-FP55

Responsible Party:

Sony Electronics Inc.

Address: 16530 Via Esprillo,
San Diego, CA 92127 U.S.A.

Telephone No.: 858-942-2230

This device complies with part 15 of the FCC Rules. Operation is subject to the following two conditions:

(1) this device may not cause harmful interference, and (2) this device must accept any interference received, including interference that may cause undesired operation.

Note:

This equipment has been tested and found to comply with the limits for a Class B digital device, pursuant to Part 15 of the FCC Rules.

These limits are designed to provide reasonable protection against harmful interference in a residential installation. This equipment generates, uses, and can radiate radio frequency energy and, if not installed and used in accordance with the instructions, may cause harmful interference to radio communications. However, there is no guarantee that interference will not occur in a particular installation. If this equipment does cause harmful interference to radio or television reception, which can be determined by turning the equipment off and on, the user is encouraged to try to correct the interference by one or more of the following measures:

- Reorient or relocate the receiving antenna.
- Increase the separation between the equipment and receiver.
- Connect the equipment into an outlet on a circuit different from that to which the receiver is connected.
- Consult the dealer or an experienced radio/TV technician for help.

For the Customer in Europe

This product has been tested and found compliant with the limits set out in the EMC Directive for using connection cables shorter than 3 meters (9.8 feet).

Attention

The electromagnetic fields at the specific frequencies may influence the picture of this digital photo printer.

Notice

If static electricity or electromagnetism causes data transfer to discontinue midway (fail), restart the application or disconnect and connect the communication cable (USB, etc) again.

Disposal of Old Electrical & Electronic Equipment (Applicable in the European Union and other European countries with separate collection systems)

This symbol on the product or on its packaging





indicates that this product shall not be treated as household waste. Instead it shall be handed over to the applicable collection point for the recycling of electrical and electronic equipment. By ensuring this product is disposed of correctly, you will help prevent potential negative consequences for the environment and human

health, which could otherwise be caused by inappropriate waste handling of this product. The recycling of materials will help to conserve natural resources. For more detailed information about recycling of this product, please contact your local Civic Office, your household waste disposal service or the shop where you purchased the product.

NOTICE FOR CUSTOMERS IN THE UNITED KINGDOM

A moulded plug complying with BS 1363 is fitted to this equipment for your safety and convenience.

Should the fuse in the plug supplied need to be replaced, a fuse of the same rating as the supplied one and approved by ASTA or BSI to BS 1362, (i.e. marked with  or  mark) must be used.

If the plug supplied with this equipment has a detachable fuse cover, be sure to attach the fuse cover after you change the fuse. Never use the plug without the fuse cover. If you should lose the fuse cover, please contact your nearest Sony service station.

Duplication, edition, or printing of a CD, TV programs, copyrighted materials such as pictures or publications, or any other materials except for your own recording or creation is limited to private or domestic use only. Unless you hold copyright or have permission of copyright holders for the materials to be duplicated, use of those materials beyond this limit may infringe the provisions of the copyright law and be subject to the copyright holder's claim for damages.

When using photo images with this printer, pay special attention not to infringe the provisions of the copyright law. Any unauthorized use or modification of others' portrait may also infringe their rights.

For some demonstrations, performances, or exhibits, photography may be forbidden.

Backup recommendations

To avoid potential risk of data loss caused by accidental operation or malfunction of the printer, we recommend that you save a backup copy of your data.

Information



IN NO EVENT SHALL SELLER BE LIABLE FOR ANY DIRECT, INCIDENTAL OR CONSEQUENTIAL DAMAGES OF ANY NATURE, OR LOSSES OR EXPENSES RESULTING FROM ANY DEFECTIVE PRODUCT OR THE USE OF ANY PRODUCT.

Sony shall assume no responsibility for any accidental or consequential damages or loss of the recording contents which may be caused by use or malfunction of the printer or memory card.

Notes on LCD screen

- The displayed image on the screen is not identical in picture quality and colors with the printed image because phosphor methods or profiles differ. Please regard the displayed image as just a reference.
- Do not press against the LCD screen. The screen may be discolored and that may cause a malfunction.
- Exposing the LCD screen to direct sunlight for long periods may cause malfunctions.
- The LCD screen is manufactured using extremely high-precision technology so over 99.99% of the pixels are operational for effective use. However, there may be some tiny black points and/or bright points (white, red, blue or green in color) that constantly appear on the LCD screen. These points are normal in the manufacturing process and do not affect the recording in any way.
- Images may trail across on the LCD screen in a cold location. This is not a malfunction.

On trademarks and copyrights

- Cyber-shot is the trademark of Sony Corporation.
 -  "Memory Stick",  "Memory Stick PRO", **MEMORY STICK PRO**, "Memory Stick Duo", **MEMORY STICK DUO**, "Memory Stick PRO Duo" **MEMORY STICK PRO DUO**, "MagicGate", and **MAGIC GATE** are trademarks of Sony Corporation.
 - Microsoft, Windows® and DirectX are registered trademarks of Microsoft Corporation in the United States and other countries.
 - IBM and PC/AT are registered trademarks of International Business Machines Corporation.
 - Intel and Pentium are the registered trademarks or trademarks of Intel Corporation.
 - All other companies and product names mentioned herein may be the trademarks or registered trademarks of their respective companies. Furthermore, "TM" and "®" are not mentioned in each case in this manual.
 - The raster process of true type fonts is based on the FreeType Team software.
 - This software is based in part on the work of the independent JPEG Group.
 - Libtiff
- Copyright © 1988-1997 Sam Leffler
Copyright © 1991-1997 Silicon Graphics, Inc.
Permission to use, copy, modify, distribute, and sell this software and its documentation for any purpose is hereby granted without fee.- Zlib

© 1995- 2002 Jean-loup Gailly and Mark Adler

Notice for users

Program © 2006 Sony Corporation
Documentation ©2006 Sony Corporation

All rights reserved. This manual or the software described herein, in whole or in part, may not be reproduced, translated or reduced to any machine readable form without prior written approval from Sony Corporation.

IN NO EVENT SHALL SONY CORPORATION BE LIABLE FOR ANY INCIDENTAL, CONSEQUENTIAL OR SPECIAL DAMAGES, WHETHER BASED ON TORT, CONTACT, OR OTHERWISE, ARISING OUT OF OR IN CONNECTION WITH THIS MANUAL, THE SOFTWARE OR OTHER INFORMATION CONTAINED HEREIN OR THE USE THEREOF.

By breaking the seal of the envelope of the CD-ROM package, you accept all the terms and conditions of this agreement. If you do not accept these terms and conditions, please return this disk envelope unopened, along with the rest of the package, immediately to the dealer where you obtained it.

Sony Corporation reserves the right to make any modification to this manual or the information contained herein at any time without notice. The software described herein may also be governed by the terms of a separate user license agreement.

Any design data such as sample pictures provided in this software cannot be modified or duplicated except for the purpose of personal use. Any unauthorized duplication of this software is prohibited under copyright law.

Please note that unauthorized duplication or modification of others' portraits or copyrighted work could infringe the rights reserved by right holders.

Table of contents

Before you begin

What you can do with this printer	6
Identifying the parts	8

Preparations

1 Checking the contents of the package	10
2 Preparing the print pack	11
Size of print paper	11
Optional print packs	11
3 Loading the print cartridge	12
4 Inserting the print paper	13
5 Connecting the AC power source ...	16
Inserting a memory card	17
Inserting a "Memory Stick"	17
Inserting an SD card	18
Connecting a camera or other external device	18

Making basic printing

Printing selected images	20
Printing an image	20
Printing multiple images	22
Using the LCD screen	24
An image preview	24
Image list	25

Making various printing

Editing an image	26
Displaying the Edit menu	26
Enlarging and reducing an image size	27
Moving an image	27
Rotating an image	27
Adjusting an image	28
Adding a special filter to an image	28
Reducing the red-eye phenomenon	29
Printing and saving an image	30

Making split images and a calendar

(Creative Print)	31
Displaying the Creative Print menu	31
Making split images	32
Making a calendar	34

Making easy printing

(Index/DPOF/All)	35
------------------------	----

Viewing a slideshow

37

Searching for an image

38

Deleting images

39

Deleting selected images	40
--------------------------------	----

Formatting a "Memory Stick"	40
-----------------------------------	----

Changing the print settings

(Set Up)	41
----------------	----

Changing the printer preferences

(Option)	44
----------------	----

Printing from a PictBridge camera

Printing images from the digital

camera	46
--------------	----

Printing from a PC

Installing the software	47
System requirements	47
Installing the printer driver	48
Installing the Picture Motion Browser	51

Printing photos from the Picture

Motion Browser	53
Printing from other application software	60

Troubleshooting

If trouble occurs	62
If an error message appears	77
If paper jams	80
Cleaning the inside of the printer	80

Additional information

Precautions	82
About the Memory Cards	83
About the "Memory Stick"	83
About the SD card	86
Specifications	87
Printing range	89
Glossary	90
Index	91

What you can do with this printer

You can print from a memory card or an external device

➔ pages 20 to 25

“Memory Stick”
 (“Memory Stick Duo”),
 or SD card

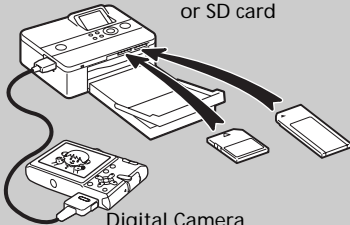

Digital Camera
 or other
 external device

You can print from a PictBridge-compliant camera

➔ page 46

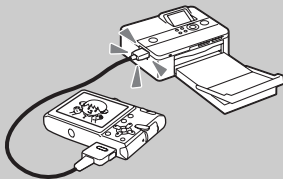

You can print from a PC

➔ pages 47 to 61



You can print using the printer's LCD screen



You can select and print an image

➔ page 20



Basic one-image
 print

You can make a variety of printing

➔ pages 26 to 36



Enlarged/Reduced/
 Moved/Rotated
 image prints
 (➔ page 27)



Easy printing
 (Index/DPOF/
 All) (➔ page
 35)



Split images
 print (➔ page
 32)



Calendar print
 (➔ page 34)

You can view a slideshow.

➔ page 37

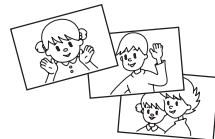

You can search or delete an image.

➔ pages 38 to 40

You can change print and printer settings.

➔ pages 40 to 45

Convenient printing operations

- Easy-to-view, 2.0 type color TFT liquid crystal display allows you to preview, edit, process, save, and print an image easily. In addition, guide messages will navigate you through the operations.
- High-speed CPU greatly shortens the time required for displaying and printing an image.
- A 20-sheet paper tray allows you to print up to 20 sheets of paper at one time. (➡ page 13)

Versatility of printing

- You can select border or borderless prints (➡ page 42)
- You can view a slideshow of the images in a memory card or an external device. (➡ page 37)
- Supplied application software allows you to print an image easily from your PC. (➡ page 47)
- You can print an image easily from a PictBridge-compliant digital camera. (➡ page 46)
- You can print an image easily from your camera or an external mass storage device*. (➡ page 18)
(*Not all types of mass storage devices' operations are guaranteed.)



Supreme picture quality functions enabling photo-realistic printing

- Professional high-performance printing system reproduces photo realistic printing.
- Super Coat 2 feature enables high durability of a print and resistance against moisture and fingerprint.
- Auto Fine Print 3 analyses an image and corrects the picture to optimum quality. (➡ page 42)
- Exif 2.21 (Exif Print) feature utilises shooting conditions data stored in an image file of an Exif 2.21-compliant camera to adjust and print it with improved quality. (➡ page 42)
- Red-eye phenomenon reduction, brightness, hue, and other corrections or adjustments enable high-quality printing. (➡ page 29)

Exif Print

Identifying the parts

For details, see the pages indicated in the parentheses.

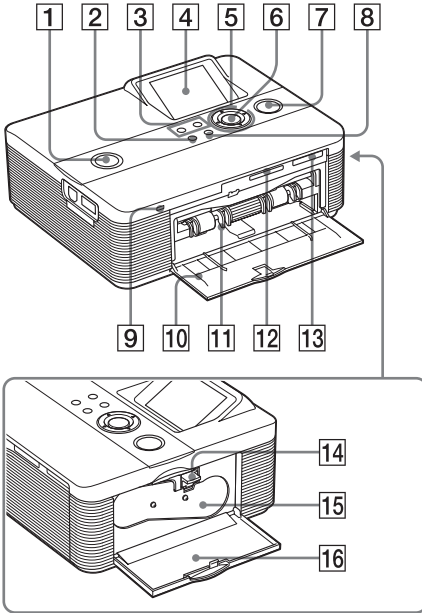

Printer front panel

- 1 (on/standby) switch/indicator (pages 16, 20)
- 2 MENU button
- 3 (zoom out)/ (zoom in) buttons (page 24)
- 4 LCD screen (page 24)
- 5 Direction (///) buttons
- 6 ENTER button
- 7 PRINT button/indicator (page 21)
- 8 CANCEL button
- 9 Access indicator (pages 17, 18)
- 10 Paper tray compartment door (page 15)
- 11 Paper tray compartment (page 15)
- 12 SD CARD slot (pages 18)
- 13 MEMORY STICK PRO STD/DUO slot (page 17)

Printer right side panel

- 14 Print cartridge eject lever (page 12)
- 15 Print cartridge (pages 12, 13)
- 16 Print cartridge compartment door (pages 12, 13)

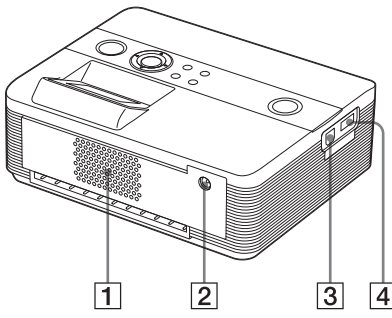

Printer rear panel

- 1** Ventilation holes
- 2** DC IN 24V jack (page 16)
Connect the supplied AC power adaptor into this connector.

Printer left side panel

- 3** USB connector (page 49)
When using the printer in PC mode, connect a PC into this connector.
- 4** PictBridge connector (pages 19, 46)

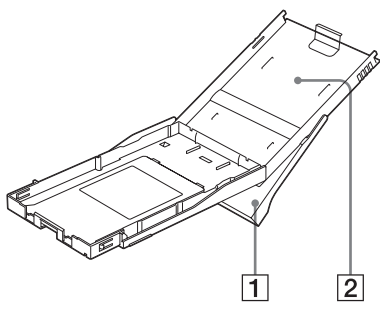

Paper tray

- 1** Paper eject tray (pages 13, 14)
- 2** Paper tray lid (pages 13, 14)

1 Checking the contents of the package

Make sure that the following accessories are supplied with your printer.

Paper tray (1)

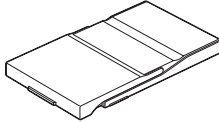

AC adaptor (AC-S2425) (1)

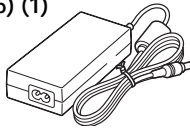

AC power cord * (1)

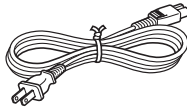

* The AC power cord illustrated is for 120V only. The plug shape and specifications of the AC power cord differ depending on the region you purchased the printer.

Cleaning cartridge (1)

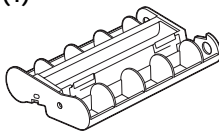

CD-ROM (1)

- Sony DPP-FP55 Printer Driver Software for Windows® XP Professional/Windows® XP Home Edition/Windows® 2000 Professional/Windows® Millennium Edition
- Picture Motion Browser Ver.1.1

- Sample color print pack (Post card size, 10 sheets)
- Operating Instructions (this booklet, 1)
- Quick Start Guide (1)
- Warranty (1)*
- Sony End User Software License Agreement (1)

* In some regions, the warranty is not supplied.

2 Preparing the print pack

To print an image, you need a print pack designed for the printer. The sample color print pack contains a set of 10 sheets of post card size print paper and a print cartridge for 10 prints.



Size of print paper

The size of the post card size print paper is as follows:

- Post card (4 x 6 inch/10 x 15 cm) size (101.6 x 152.4 mm) (the maximum borderless printing size)

Optional print packs

You can use the following optional print packs for the printer:

Post card size print pack

SVM-F40P

- 40 sheets of 4 x 6 inch print paper (20-sheet-pack x 2)
- Print cartridge for 40 prints

SVM-F80P

- 80 sheets of 4 x 6 inch print paper (20-sheet-pack x 4)
- 2 print cartridges each for 40 prints

SVM-F120P

- 120 sheets of 4 x 6 inch print paper (20-sheet-pack x 6)
- 3 print cartridges each for 40 prints

Note

Not all models are available in all countries.

Notes on using print packs

- Always use the print pack designed for this printer only. If you use different types of print pack, printing may not be possible or malfunction may occur.
- The side without the imprinting is the printing surface. Inferior print quality may result if the printing surface is contaminated with dust or fingerprints. Be careful to avoid touching the printing surface.
- **Do not bend the paper or tear it off at the perforations before printing.**
- **Do not print on used sheets of print paper or attempt to rewind the ribbon inside the print cartridge. Doing so could result in damages to the printer.**
- Please do not disassemble the print cartridge.
- Do not pull out the ribbon from the print cartridge.

Notes on storing print packs (for quality prints)

- When you are going to store a partially-used pack of the print cartridge and print paper for an extended period of time, store it in its original bag or in a similar container.
- Avoid placing the print pack in locations that are subject to high temperature, high humidity, excessive dust, or direct sunlight.
- Use print pack within two years from the date of production.

Note on storing printouts

Do not affix cellophane tape or plastic erasers to printouts. Also avoid leaving printouts under plastic desk mats.

3 Loading the print cartridge

- 1 Pull and open the cartridge compartment door.

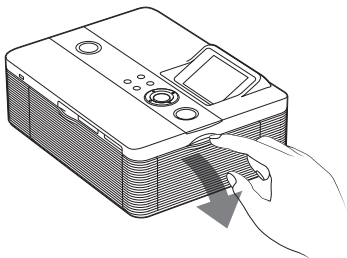

- 2 Insert the print cartridge in the arrow direction until it clicks into place.

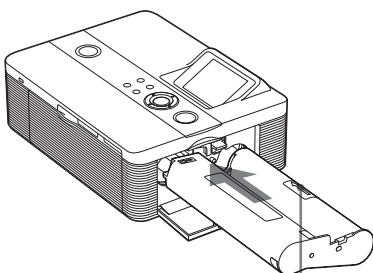

Arrow

- 3 Close the cartridge compartment door.

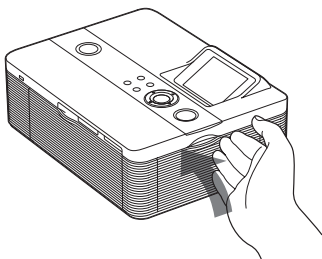

Removing the print cartridge

When the print cartridge runs out, the cartridge error message appears on the LCD screen.

Open the cartridge compartment door, push up the eject lever, and remove the used print cartridge.

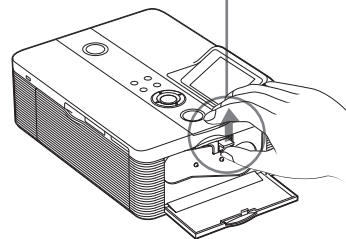
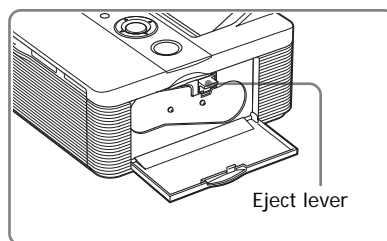

Notes

- Use the print cartridge contained in the same box with the print paper.
- Do not touch the ink ribbon or place the print cartridge in a dusty location. Fingerprints or dust on the ink ribbon may result in imperfect printing.

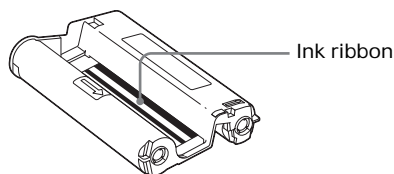

- Never put your hand into the cartridge compartment. The thermal head reaches high temperatures, especially after repeated printing.

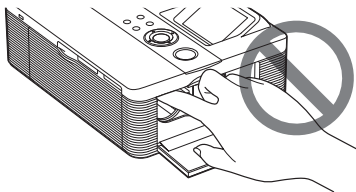

- Do not rewind the ink ribbon and use the rewound print cartridge for printing. Otherwise, proper printing result will not be obtained, or even a malfunction may occur.
- If the print cartridge does not click into place, remove it and then re-insert it. If the ink ribbon is too slack to be loaded, wind the ink ribbon in the direction of the arrow to remove the slack.

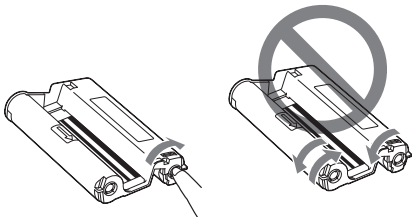

- Do not remove the print cartridge while printing.

Notes on storing the print cartridge

- Avoid placing the print cartridge in a location subject to high temperatures, high humidity, excessive dust or direct sunlight.
- When you are going to store a partially-used cartridge, store it in its original bag.

4 Inserting the print paper

- 1 Open the paper eject tray.

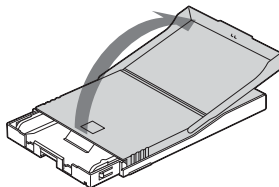

- 2 Slide the paper tray lid in the opposite direction to the paper feeding direction (1) and then lift it up (2).

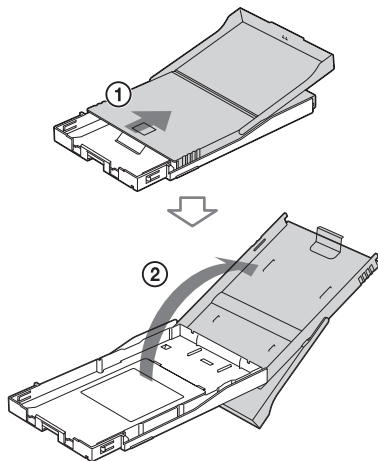

Continued

- 3** Set the print paper into the tray. You can set up to 20 sheets of print paper. Riffle the print paper thoroughly. Insert the print paper into the tray, with the protective sheet at the top. If there is no protective sheet: Riffle the print paper thoroughly. Then insert the print paper with its printing surface (the side with no imprint) facing up.

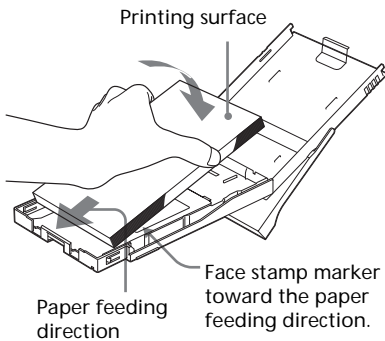

To set the print paper, face the stamp marker toward the paper feeding direction.

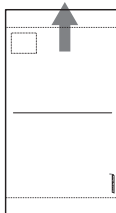

Note

Do not touch the printing surface. Fingerprints on the printing surface may result in imperfect printing.

- 4** Remove the protective sheet.

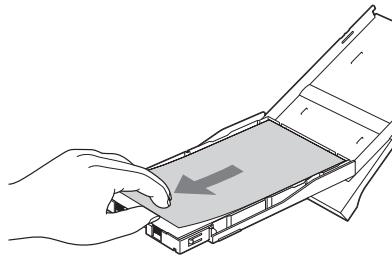

- 5** Close the paper tray lid (①) and slide it to the paper feeding direction (②). Keep the paper eject tray open.

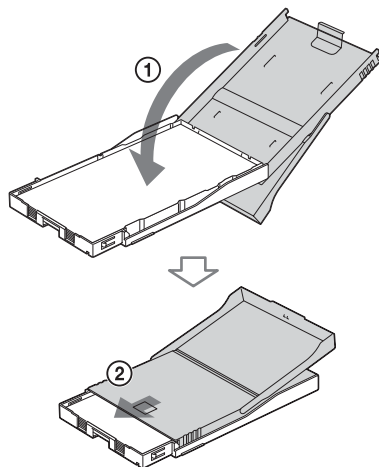

- 6** Pull and open the printer's paper tray compartment door.

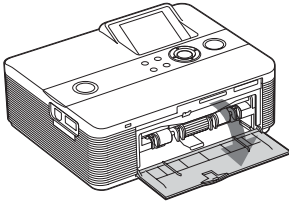

- 7** Insert the paper tray into the printer.
Insert the paper tray straight in until it reaches the end.

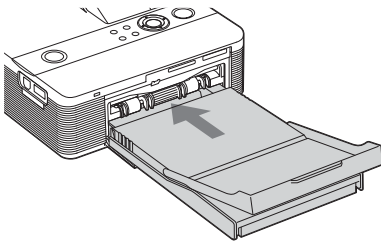

Note

Make sure that the paper tray is not inserted at any angle. If it is, the printer will not print properly.

If print paper runs out during printing, the paper error message appears on the LCD screen of the printer. Remove the paper tray and feed the print paper.

Notes

- Do not remove the paper tray during printing.
- To avoid paper jam or malfunctions of the printer, make sure the following before printing:
 - Do not write or type on the print paper. Use the oil ink pen to write on the paper after printing. You cannot type on the print paper using an ink-jet printer, etc.
 - Do not attach sticker or stamps on the print paper.
 - Do not fold or bend the print paper.
 - Total number of print paper does not exceed 20 sheets.
 - Do not print on the used print paper. Printing an image twice on the same paper will not make the printed image thicker.
 - Use the print paper for this printer only.
 - Do not use the print paper ejected without printed.

Notes on storing the print paper

- Avoid storing the paper with the printed faces touching each other or in contact with rubber or plastic products including vinyl chloride or plasticizer for an extended period of time; color changes or deterioration of the printed image may occur.
- Avoid placing the print paper in a location subject to high temperatures, high humidity, excessive dust or direct sunlight.
- When you are going to store partially-used print paper, store it in its original bag.

5 Connecting the AC power source

- 1 Insert one plug of the supplied AC power cord to the supplied AC adaptor.
- 2 Insert the other plug of the AC power cord to the wall outlet close by (wall socket).
- 3 Insert the plug of the AC adaptor to the DC IN 24V jack of the printer.
The ⏻ (on/standby) indicator lights in red.

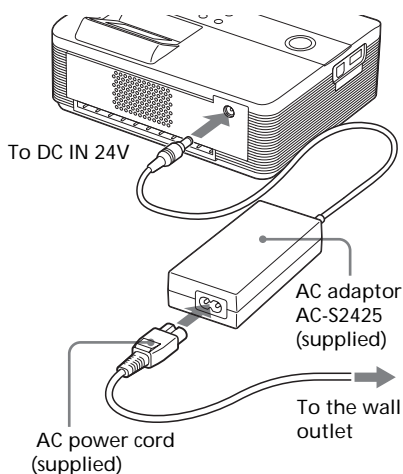

Notes

- Connect the AC adaptor to an easily accessible wall outlet close by. If some trouble occurs while using the adaptor, immediately shut off the power by disconnecting the plug from the wall outlet.
- When you have finished using the AC adaptor, disconnect it from the DC IN 24V jack of the printer.
- The printer is not disconnected from the AC power source (mains) as long as it is connected to the wall outlet, even if the printer itself has been turned off.
- The print paper emerges from the rear a few times during printing. Do not block the rear with the AC adaptor or AC power cord.
- Be sure to use the AC adaptor supplied with the printer. Do not use other AC adaptor, as this may cause malfunction.
- In case the cord of the AC adaptor is damaged, never use it any longer, as this may cause danger.
- Do not short the DC plug of the AC adaptor with a metallic object, as this may cause malfunction.
- Do not use the AC adaptor in a narrow space, such as the one between the printer and the wall.

Inserting a memory card

To print an image stored on a “Memory Stick” (or “Memory Stick Duo”), or SD card, insert it into the relevant card slot.

When multiple memory cards are inserted, the card inserted first will have the first priority. When you turn on the printer with multiple cards being inserted, the printer detects in the order of “Memory Stick” (or “Memory Stick Duo”), and SD card.

For the types of the memory card that you can use with the printer, see pages 83 through 86.

On using a memory card

- Do not attempt to insert a memory card forcibly into or out of the slot. If you do so, the memory card or the printer may be damaged.
- Do not remove the memory card while the access indicator is flashing; the memory card or printer may be damaged.
- To avoid loss of data, make a backup copy of the contents of the memory card. We cannot compensate for any damage to or loss of data.
- Check the memory card and insert it in the correct direction. If a memory card is forcibly inserted in the wrong direction, the memory card and its slot may be damaged.
- Check the memory card type and make sure to insert it to the slot designed for the particular card type. If you insert a memory card to a different slot, the memory card may be damaged or you may not be able to remove the card from the slot.
- When you remove a memory card, make sure to hold it with your hands to prevent it from popping out and hitting your eye, as this may cause injuries.

Inserting a “Memory Stick”

Insert a “Memory Stick” or “Memory Stick Duo” into the MEMORY STICK PRO STD/DUO slot until it clicks into place.

As this printer is equipped with a “Memory Stick”/“Memory Stick Duo” slot a Memory Stick Duo adaptor is not necessary.

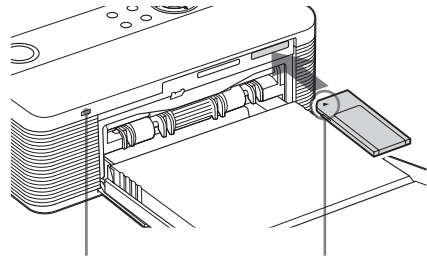

Access indicator flashes while the printer is accessing the memory card.

Insert it so that the ◀ mark is on the upper left corner.

To eject a “Memory Stick”

Push the “Memory Stick” lightly into the insertion slot. After it pops out, remove it slowly.

Inserting an SD card

Insert the SD card into the SD CARD slot until it fits into place.

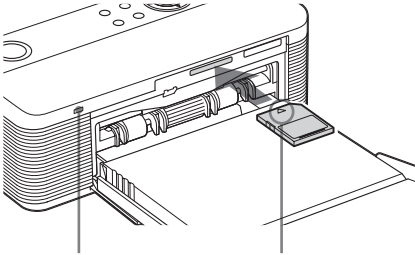

Access indicator flashes while the printer is accessing the memory card.

Insert it in the ◀ mark direction.

In the SD CARD slot of this printer, you can use the following media;

- SD Memory card
- MiniSD card (you need to use a miniSD card adaptor)
- MMC standard memory card
- RS-MMC card (you need to use an MMC adaptor)

To eject an SD card

Push the SD card lightly into the insertion slot. After it pops back out, remove it slowly.

Notes

- When you remove the SD card, make sure to hold it with your hands to prevent it from popping out and hitting your eye, as this may cause injuries.
- When you use a miniSD card, use a miniSD card adaptor. If you insert a miniSD card without the adaptor into a slot of the printer, you may not be able to remove it.

Connecting a camera or other external device

To print an image from a camera or other external device, connect it to the printer. You can connect an external device that supports mass storage system. For how to connect the PictBridge-compliant digital camera, see page 46.

Note

If a memory card is inserted in the printer, the printer cannot read the signal from an external device connected to the PictBridge connector of the printer. Remove the memory card, if any.

- 1 Set your digital camera or other external device ready for printing with the Mass Storage-compliant printer.

The settings and operations that are necessary before connection differ depending on the external device you use. For details, see the operating instructions of the external device. (In case of Sony Cyber-shot digital camera, for example, select “Normal” mode or “Mass Storage” mode for the “USB Connect”.)

- 2 Connect a camera or an external device to the PictBridge connector of the printer.

Use the USB cable supplied with the digital camera or other external device.

To PictBridge connector
(USB A-TYPE)

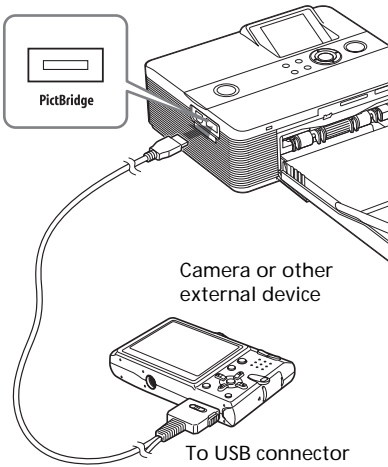

Notes

- The type of USB cable you should use may differ depending on the digital camera. Use a USB cable with an A-TYPE connector for the printer and an appropriate type for your digital camera.
- We cannot guarantee connection with all types of mass storage devices.
- If you use a commercially available USB cable, please use the one shorter than 3m in length.
- While the access indicator of the external device is flashing, never turn off the power of the printer or an external device nor remove the USB cable. The data inside the external device may be damaged. We cannot guarantee any damages that may be caused by data loss or damage.

Printing selected images

This section explains how to display the images of a memory card or an external device on the printer's LCD screen and print the selected images.



Borderless standard print

Before you begin

You need preparations **1** through **5** (pages 10 to 16), and the following:

- “Inserting a memory card” (page 17) or “Connecting a camera or other external device” (page 18)

Note



The print paper emerges from the rear a few times during printing. Make sure to spare enough space behind the printer during printing.

Selecting an input signal with the printer

The printer is not equipped with the input select switch. When you connect a memory card or an external device with the printer, the images of the connected media are displayed automatically. If multiple memory cards or an external device are connected, the media first connected has the priority. When you turn on the printer with multiple media being inserted or connected, the printer detects in the order of “Memory Stick” (or “Memory Stick Duo”), SD card, and an external device connected to the PictBridge connector, and a PC connected to the USB connector.

Before you start, make sure to insert or connect only a media that contains the images you want to print. The name of the media whose images are being displayed appears on the upper left corner of the LCD screen.

Printing an image

- 1 Press  (on/standby) switch to turn on the printer. The  (on/standby) indicator of the printer lights in yellow green.

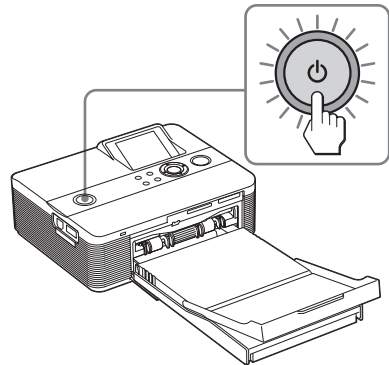

An image contained in the memory card or external device is displayed on the LCD screen.



- 2** Press $\triangleleft/\triangleright/\triangle/\nabla$ repeatedly until the image that you want to print appears.
The images are displayed in the image list.

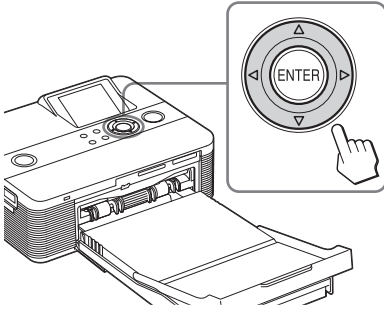

To print multiple copies

- 1 Press ENTER to display the print quantity.
- 2 Press \triangle/∇ to increase or decrease the print quantity.
- 3 Press ENTER to fix the quantity.

To select an image in the image list
Press \ominus (zoom out). One image preview changes to image list display.
Press $\triangleleft/\triangleright/\triangle/\nabla$ to move the cursor to the image you want to print.

- 3** Press PRINT.
Printing of the selected image starts.
During printing the PRINT indicator flashes and the printing process is displayed on the LCD screen.

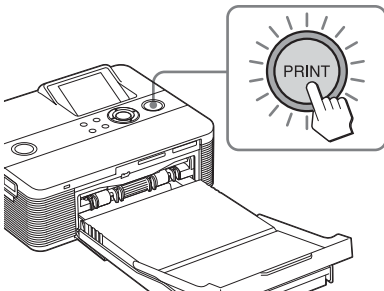

Tip

When the printer is ready for printing, the PRINT indicator lights in blue green. (If not, check to see that the print paper and print cartridge are properly set.)

- 4** When printing is complete and the print paper automatically emerges, remove the printed paper from the paper tray.

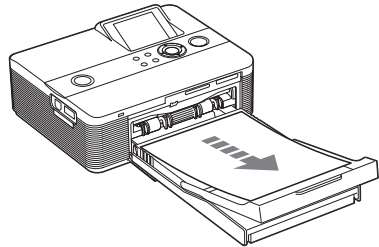

Notes on printing

- Do not remove or connect a memory card or an external device while the access indicator is flashing or the access indication is displayed on the LCD screen.
- Never move or turn off the printer while it is printing; the print cartridge or paper may become stuck. In case you turn off the power, keep the paper tray inserted and then turn on the printer. If paper being printed remains in the printer, remove the paper that emerged automatically and resume printing from the step 1.
- The print paper emerges a few times during printing. Do not touch nor pull the emerged paper. Wait for the print paper to be fully ejected after printing ends.
- As the print paper emerges from the rear a few times during printing, make sure to spare enough space behind the printer during printing.

Printing multiple images

This section explains how to select multiple images, specify print quantity for each of them and print them at a time.

- 1 Press \odot (on/standby) switch to turn on the printer.

The \odot (on/standby) indicator of the printer lights in yellow green. An image contained in the memory card or external device is displayed on the LCD screen.

- 2 Press Q (zoom out) to display the image list.
The one image preview changes to the image list display. The orange frame shows the cursor.

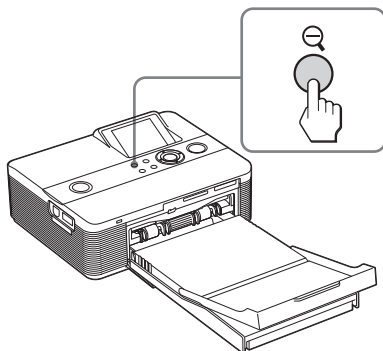

Cursor (orange frame)



To display another page

- To display the next page, move the cursor to the bottom line of the image list and press ∇ .
- To display the previous page, move the cursor to the top line and press Δ .

To display one image preview again
Move the cursor to the desired image and press Q (zoom in).

- 3 Press $\blacktriangleleft/\blacktriangleright/\Delta/\nabla$ to move the cursor to the image you want to print, and press ENTER.

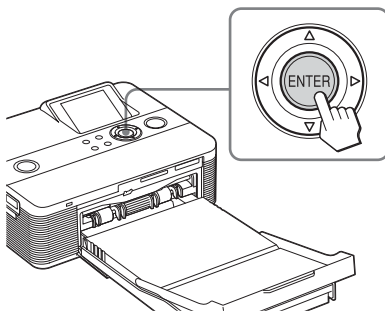

The print quantity indication becomes "1".

Print quantity indication



- 4** Press Δ/∇ to set the print quantity.
- To increase the print quantity one by one, press Δ repeatedly.
 - To reduce the print quantity one by one, press ∇ briefly repeatedly.
 - To reset the print quantity to zero immediately, press ∇ for more than two seconds.

You can set up to 20 copies of print quantity for an image.

- To display another image, press $\triangleleft/\triangleright$.
- To cancel the selection, press CANCEL.

- 5** Repeat steps 3 and 4 to select other images and set print quantity for each of them. The selected images are displayed with the cursor .

To cancel the selection

- 1 Press $\triangleleft/\triangleright/\Delta/\nabla$ to move the cursor to the image you want to cancel in the image list and press ENTER.
- 2 Press ∇ repeatedly until the print quantity becomes "0."
The image selection is canceled.

- 6** Press PRINT.
The selected images will be printed. During printing, the PRINT indicator flashes and the printing process is displayed on the LCD screen.

To stop printing

Press CANCEL. When you are printing multiple copies, the next printing after the one currently printing will be canceled.

- 7** When printing is complete and the print paper automatically emerges, remove the printed paper from the paper tray.

Tip

Even if the remaining volume of the print cartridge is shorter than the print quantity, you can proceed with printing. If the print cartridge runs out in the middle of printing and a message appears, follow the displayed instructions to replace the printing cartridge (page 12).

Using the LCD screen

You can switch an image preview and the image list display to view and check a picture before printing.

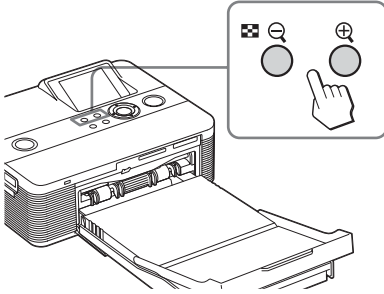

- Press (zoom out) repeatedly. An image is reduced up to the original scale and then the display changes from an image preview to the image list.
- Press (zoom in) repeatedly. The display changes from the image list to an image preview. Then the image is enlarged up to 5 times the original scale.

To display or select another image

Press ///. In one image preview, the displayed image switches. In the image list, the cursor (showing the selected image) moves.

An image preview

Selected input media (Memory card or external device)*

Print cartridge type (P: Postcard/C: cleaning cassette)

Associated file/DPOF/Protect indications**

Number of the selected images/ Total number of image

0000/0042

JPEG
2304*1728
SONY
DSC-P43
1/8
F2.8
+0.0EV

101-0001

2006/06/01

Image number (folder- file number)

Saved date (year/ month/day)

Image data display when the "Image data display" in the Options menu is set to "ON".

Operation tips

Scroll bar indicating the position of the image among the total number of images.

to move/[ENTER] for QTY.

* Input indications

The icon of the connected media is displayed:

: "Memory Stick" or "Memory Stick Duo"

: SD Card

: External Device

****Associated file/DPOF/Protect indications**



- Associated file indication: 
The image, in addition to the displayed image, has an associated file such as a motion file or a miniature e-mail image file.
- DPOF indication: 
The image is DPOF preset with a digital camera.
- Protect indication: 
The image is protected with a digital camera.

Image list

Cursor (orange frame)



Operation tips

Scroll bar indicating the position of the image among the total number of images.

Editing an image

Displaying the Edit menu

You can display the Edit menu and edit or add an effect to an image.

Buttons to be used in the Edit menu

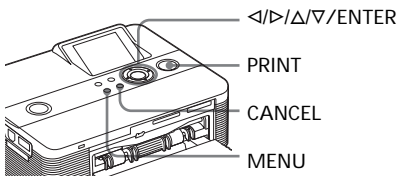

- 1 Display the image that you want to edit.
Display the image in the image preview window or move the Cursor to the desired image in the image list.

- 2 Press MENU on the printer.
The menu bar is displayed.











To exit the menu mode

Press MENU again. The previous window is displayed.

- 3 Press ◀/▶ to select  (Edit) and then press ENTER.
The Edit menu is displayed.



Items	Procedures
	Increases or reduces the size of an image by pressing the buttons on the printer.
	Moves an image.
	Rotates an image.
	Adjusts the picture quality of an image.
	Adds a filter to an image.
	Reduces the red-eye phenomenon.
	Undoes the editing just done and resets the image to the status before editing.
	Saves the edited image.
	Exits the Edit menu.

Tip

You can press MENU while editing an image and set part of the Set Up menu items.

Enlarging and reducing an image size

- 1 Display the Edit menu (page 26).
- 2 Press \oplus (zoom in) to enlarge an image or \ominus (zoom out) to reduce the size of it.
Each time you press the button, the image becomes larger or smaller:

\oplus : up to 200%

\ominus : up to 60%



Note

The picture quality of an enlarged image may be deteriorated depending on its size.

Moving an image

- 1 Display the Edit menu (page 26).
- 2 Press \leftarrow/\rightarrow to select Hand (Position) and then press ENTER.
The $\leftarrow/\rightarrow/\uparrow/\downarrow$ appears on the right/left/above/down the image and you can move the image.

- 3 Move the image with $\leftarrow/\rightarrow/\uparrow/\downarrow$.
The image moves to the selected direction.



- 4 Press ENTER.
The image is fixed to the position.

Tip

To print the image previewed, press PRINT (page 30).

Rotating an image

- 1 Display the Edit menu (page 26).
- 2 Press \leftarrow/\rightarrow to select Rotate (Rotate) and then press ENTER.
The Rotate menu is displayed.

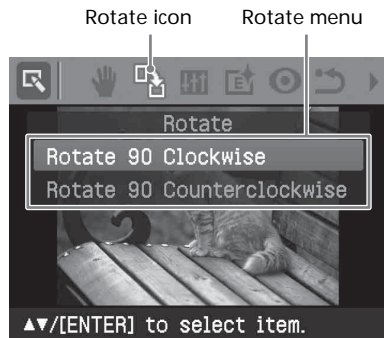

Continued

- 3** Press Δ/∇ to select the direction to rotate the image and then press ENTER.
- Rotate 90° Clockwise: Each time you press ENTER, the image rotates 90° clockwise.
 - Rotate 90° Counterclockwise: Each time you press ENTER, the image rotates 90° counterclockwise.

Tip

To print the image previewed, press PRINT (page 30).

Adjusting an image

- 1 Display the Edit menu (page 26).
- 2 Press $\triangleleft/\triangleright$ to select  (Adjust) and then press ENTER. The Adjust menu is displayed.



- 3 Press Δ/∇ to select the desired adjustment tool and press ENTER. The adjustment slider appears.

When "Brightness" is selected.



Adjustment slider

- 4 Move the slider to the desired position to adjust the level.
 - Brightness: Press \triangleright to brighten the picture or \triangleleft to darken it.
 - Tint: Press \triangleright to make the picture bluish or \triangleleft to make it reddish.
 - Saturation: Press \triangleright to deepen the colors or \triangleleft to lighten the colors.
 - Sharpness: Press \triangleright to sharpen the outlines or \triangleleft to reset them.
- 5 Press ENTER. The adjustment takes effect.

Tip

To print the image previewed, press PRINT (page 30).

Adding a special filter to an image

- 1 Display the Edit menu (page 26).
- 2 Press $\triangleleft/\triangleright$ to select  (Filter) and then press ENTER.

The Filter menu is displayed.

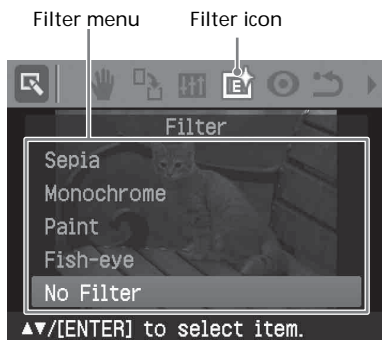

- 3 Press ▲/▼ to select the desired filter you want to add to the image.
 - Sepia: Changes the image like an old photograph with faded colors.
 - Monochrome: Changes the image into a black and white picture.
 - Paint: Makes the image look like a painted picture.
 - Fish-eye: Makes the image look like a photo taken with a fish-eye lens.
 - No Filter: No special filter on the image (default setting).

- 4 Press ENTER.
The filter takes effect.

Tip

To print the image previewed, press PRINT (page 30).

Reducing the red-eye phenomenon

You can reduce the red-eye phenomenon of a subject shot using a flash.

Note

If you perform additional editing, such as enlarging, reducing the image size, rotating or moving an image, after the red-eye reduction adjustment, the red-eye reduction may not take effect. Perform the red-eye reduction after these editorial operations.

- 1 Display the Edit menu (page 26).
- 2 Press </> to select  (Red-eye reduction) and then press ENTER. The adjustment frame appears on the image, which indicates the range for red-eye reduction adjustment.

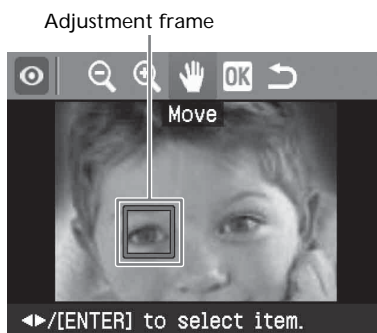

- 3 Adjust the position and size of the adjustment frame. Make the red-eye reduction adjustment for the right and left eyes separately.

To move the adjustment frame

- ① Press </> to select  (Position) and press ENTER.



Continued

- ② Move the frame with </>/Δ/∇.
The frame moves in the selected direction.
- ③ Press ENTER.
The frame is fixed in the current position.

To change the size of the adjustment frame

Press </> to select  (Enlarge) or  (Reduce) and press ENTER.

Each time you press ENTER, the frame becomes larger or smaller.

You can also enlarge or reduce the size by pressing  (zoom in) or  (zoom out) buttons on the printer.

Tip

Make the size of the adjustment frame two to seven times as large as the eye size.

- 4 Press </> to select  and press ENTER.
The range of red-eye reduction adjustment is enlarged.
- 5 Press ENTER.
The adjustment takes effect.
The Red-eye reduction menu is displayed.
To make a red-eye reduction adjustment for other eyes, repeat steps 3 to 5.

To reset the adjustment

Press CANCEL in step 5 instead of ENTER. The red-eye reduction adjustment is canceled and the window of step 2 is displayed.

Tip

To print the image previewed, press PRINT (page 30).

Printing and saving an image

Printing an image

- 1 Press PRINT.
The dialog box to specify the print quantity is displayed.
- 2 Press Δ/∇ to increase or decrease the print quantity.
 - To increase the print quantity one by one, press Δ repeatedly.
 - To reduce the print quantity one by one, press ∇ briefly repeatedly.
 - To reset the print quantity to zero, press ∇ for more than two seconds.
- 3 Press PRINT to start printing.
The image previewed is printed.

Saving an image

When you select  (save) in the Edit or Creative Print menu, the dialog box to select the destination to save the image is displayed. You can save the image under a new image number.

Tip

The selected image will not be overwritten.

- 1 Select the destination to save an image.
Press Δ/∇ to select the media ("Memory Stick", or "SD Card") and press ENTER.



The dialog box for setting date is displayed. You can save the date with the image.

- 2 Set date.
Press Δ/∇ to select the number and press \leftarrow/\rightarrow to select the day, month or year. Then press ENTER.



The edited or Creative Print image is saved as a new image. The dialog box to notify the new image numbers (folder number-file number) is displayed.

For example, when "100-0001" is displayed, "100" is folder number and "0001" is file number.

- 3 Press ENTER.

Note

While saving the image, do not turn off the printer or remove a memory card from the printer. The memory card may be damaged.

Making split images and a calendar

(Creative Print)

Displaying the Creative Print menu

You can display the Creative Print menu and make a calendar or split images prints using the images of a memory card or an external device.

Buttons to be used in Creative Print

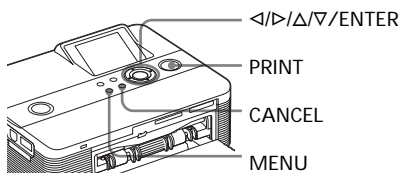

- 1 Press MENU.
The menu bar is displayed.

Creative Print menu icon Menu bar



To exit the menu mode

Press MENU. The previous window is displayed.

Continued

- 2** Press $\triangleleft/\triangleright$ to select  (Creative Print) and then press ENTER. The Creative Print menu is displayed.

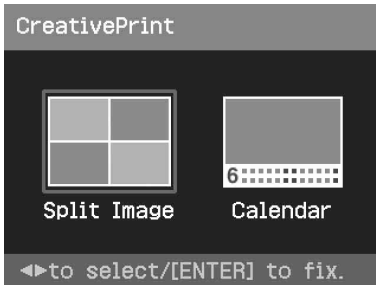

To undo the operation midway

Press CANCEL. The window of the previous step is displayed. Depending on the step, you cannot undo the operation.

Tip

You can press MENU while making a Creative Print and set part of the Set Up menu items.

To save Creative Print (page 30)

- To save an image, select  on the window.

To exit the Creative Print menu

- Press MENU in the middle of the operations and select "Creative Print Complete".
- Display the preview image and then press $\triangleleft/\triangleright/\triangle/\nabla$ to select  and press ENTER.

The dialog box for saving an image may be displayed (page 30).

Making split images

You can make a print with 2-split, 4-split, 9-split, 13-split, or 16-split images.



- 1** Display the Creative Print menu (page 31).
- 2** Press $\triangleleft/\triangleright$ to select "Split Image", then press ENTER. The split image templates are displayed.

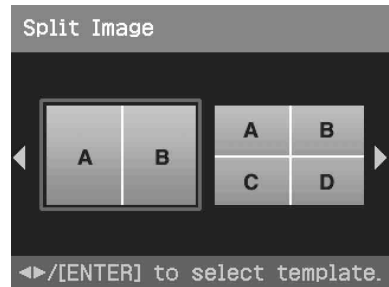

- 3** Press $\triangleleft/\triangleright$ to select the desired template, then press ENTER. The preview of the selected template is displayed.



Tip

You can select and set each area in any order.

- 4** Press </>/Δ/▽ to select the desired image area and press ENTER.
The window for selecting an image is displayed.



- 5** Press </>/Δ/▽ to select the desired image, and then press ENTER.
The window used for adjusting the image position is displayed.

Adjustment tools

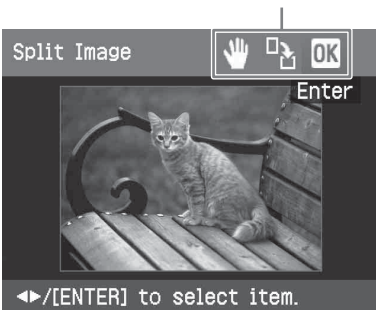

- 6** Adjust the size and position of the selected image.
Press </> to select the desired adjustment item, then press ENTER.

Items Procedures

Increases or reduces the size of an image by pressing the buttons on the printer.

Move the adjustment frame with </>/Δ/▽, and then press ENTER.

Each time you press ENTER, the image rotates 90° clockwise.

- 7** Press </>/Δ/▽ to select **OK** and press ENTER.
The selected image is added to the image area. When you select a template with multiple images, repeat the steps 3 through 7 to select an image for each area.



Tip

To print the image previewed, press PRINT (page 30).

Continued

Making a calendar

You can make calendars with your favorite images.



- 1 Display the Creative Print menu (page 31).
- 2 Press $\triangleleft/\triangleright$ to select "Calendar", then press ENTER.
The window used for selecting the calendar template, is displayed.

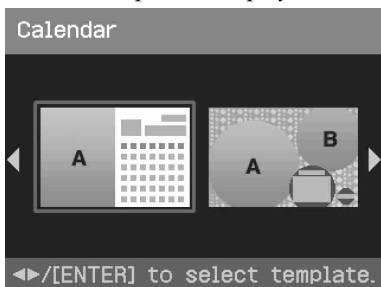

- 3 Press $\triangleleft/\triangleright$ to select the desired template, and then press ENTER.
The preview of the selected template is displayed.

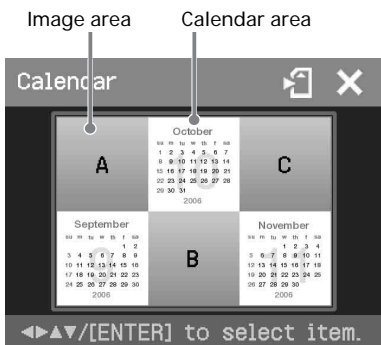

Tip

You can select and set an image area or calendar area in any order.

- 4 Select an image.
When you select a template with multiple images, repeat the procedures below to select an image for each area.
 - ① Press $\triangleleft/\triangleright/\triangle/\nabla$ to select an image area, then press ENTER.
The image list is displayed (page 32).
 - ② Press $\triangleleft/\triangleright/\triangle/\nabla$ to select the desired image, then press ENTER.
The window used for adjusting the image size and position is displayed. For information on adjustment, see step 6 on page 33.
 - ③ Press $\triangleleft/\triangleright$ to select **OK** and then press ENTER.
The image is selected and displayed in the relevant area.

- 5 Set the calendar.
 - ① Press $\triangleleft/\triangleright/\triangle/\nabla$ to select the calendar area and press ENTER to display the calendar setting window.

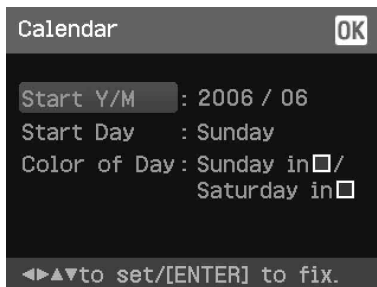

- ② Press \triangle/∇ to select the following items and then press $\triangleleft/\triangleright$ to select an option.

Item Procedures

Start Y/M

Set the first month and the year starting the calendar. Press $\triangleleft/\triangleright$ to select the month or year and press \triangle/∇ to set the number. Press ENTER.

Start Day

Set the day of the week (placed furthest left in the calendar). Press \triangle/∇ to select "Sunday" or "Monday". Then press ENTER.

Color of Day

Set the color of Sunday and Saturday to be displayed in the calendar. Press \triangleright and then \triangle/∇ to select the desired color for Sunday and Saturday. Then press ENTER.

- ③ Press $\triangleleft/\triangleright/\triangle/\nabla$ to select **OK** and then press ENTER.

The calendar is displayed in the calendar area.



Tip

To print the image previewed, press PRINT (page 30).

Making easy printing (Index/DPOF/All)

The Easy Printing menu allows you to print multiple images stored on a memory card or an external device at one time.

The printer provides the following three easy printing methods:

- **Index printing**

You can print a list (index) of all the images contained in a memory card or an external device, which allows you to check the contents of the selected media easily.

The number of split panes on a sheet will be calculated automatically. Images are printed with their corresponding image numbers (folder number-file number).

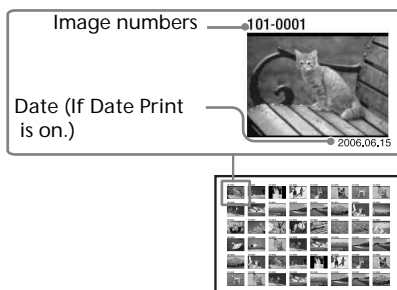

- **DPOF preset image printing**

The images which are DPOF (Digital Print Order Format) preset for printing are displayed with the print mark () in the image list. You can print those images at one time. The images are printed with the preset number of copies in the order they were displayed.

- **All images printing**

You can print all the images stored in a memory card or an external device at one time.

Continued

Notes

- For how to preset images for printing, see the manual of your digital camera.
- Some types of digital camera do not support the DPOF function, or the printer may not support some of the functions of the digital camera.

- 1 Press MENU on the printer. The menu bar is displayed.

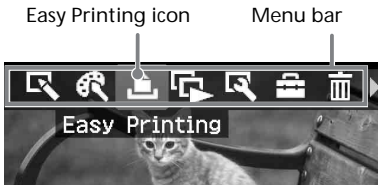

To exit the menu mode

Press MENU again. The previous window is displayed.

- 2 Press $\langle \rangle$ to select  (Easy Printing) and then press ENTER. The Easy Printing menu is displayed.

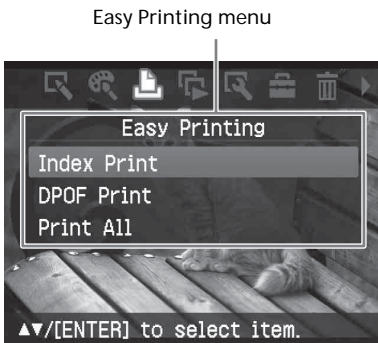

- 3 Press Δ/∇ to select "Index Print", "DPOF Print", or "Print All" and then press ENTER. The confirmation dialog box is displayed.

Note

If there are no DPOF preset images when you selected "DPOF Print," an error message will be displayed.

- 4 Press $\langle \rangle$ to select "Yes" to start printing or "No" to cancel printing, and then press ENTER. When you select "Yes," printing starts. During printing, the PRINT indicator flashes and the printing process is displayed.

To stop printing

Press CANCEL. When you are printing multiple copies, the next printing after the one currently printing will be canceled.

- 5 When printing is complete and the print paper automatically emerges, remove the printed paper from the paper tray.

Tips

- Even if the remaining volume of the print cartridge is shorter than the print quantity, you can proceed with printing. If the print cartridge runs out in the middle of printing and a message appears, follow the displayed instructions to replace the printing cartridge (page 12).
- When the "Date Print" item of the Set Up menu is set to "On", the date the image was shot or saved is printed (page 43).

Viewing a slideshow

You can perform a slideshow of the images saved in a memory card or an external device. You can also manually print an image being displayed.

Buttons to be used in this section

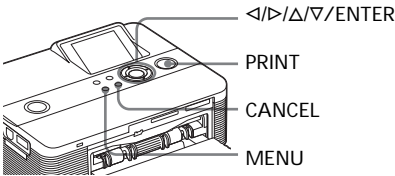

- 1 Press MENU.
The menu bar is displayed.



- 2 Press ◀/▶ to select  (Slideshow) and then press ENTER.
The Slideshow menu is displayed.

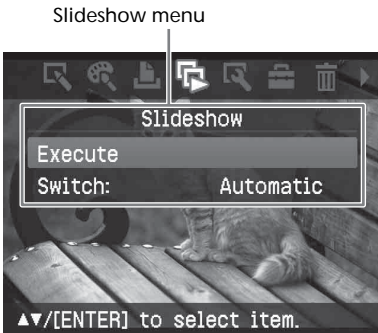

- 3 Press △/▽ to select "Switch", and then press ENTER.
The window to specify the way how images are switched is displayed.
- 4 Press △/▽ to select "Automatic" to switch images automatically or "Manual" to switch them manually. Then press ENTER.
- 5 Press △/▽ to select "Execute", and press ENTER.

- When "Automatic" is selected: The images in the memory card or an external device are displayed automatically one after another.
- When "Manual" is selected: The image with the cursor in the image list is displayed. To switch images, press ◀/▶/△/▽. The image to the left, right, above, or below the current image in the image list will be displayed.

To stop slideshow

Press CANCEL.

Printing a displayed image

While playing the slideshow manually, you can print a displayed image by pressing PRINT.

Notes

- Depending on the image, it may take time to be displayed.
- You cannot display the images that are not displayed as thumbnails because they are damaged or for some other reason.

Searching for an image

The Search menu allows you to search a memory card or an external device for an image by image number or date.

Buttons to be used in this section

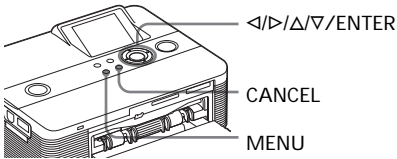

- 1 Press MENU.
The menu bar is displayed.

Image Search menu icon

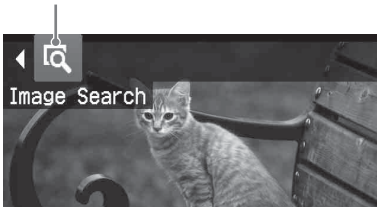

To exit the menu mode
Press MENU. The previous window is displayed.

- 2 Press </> to select  (Image Search) and then press ENTER.
The Image Search menu is displayed.

Image Search menu



- 3 Press Δ/∇ to select the search key and press ENTER.

The dialog box used for specifying the criteria for searching is displayed.

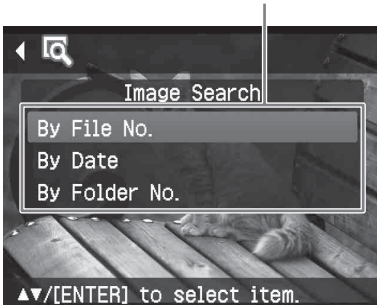
- 4 Press </> to select an item and press Δ/∇ to specify numbers.

- When you select "By File No.":
Specify the starting and ending numbers of the files (folder and file numbers) that you want to search for:

Starting image number Ending image number



Tip

To search for a specific file, enter the same file number in both the boxes.

- When you select "By Date":
Specify the starting and ending dates of the files that you want to search for:

Starting date Ending date

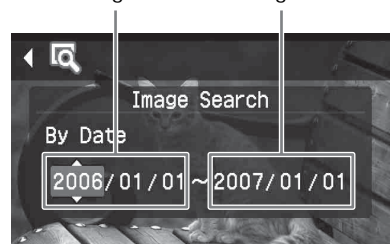

Tip

To search for images of a specific day, enter the same date in both the boxes.

- When you select “By Folder No.”: Specify the folder number of the images you want to search for:

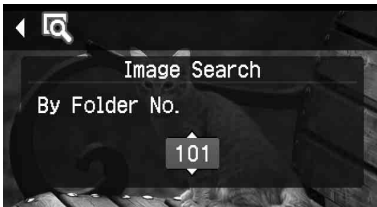

- 5 Press ENTER. Searching starts. When the search is complete, the search results will be displayed.

If no images have been found
“No images were found” will be displayed.
- 6 Press ENTER. The image list is displayed.
 - If you selected “By File No.” and “By Date”, “01” is displayed on the images found to indicate their print quantity. You can easily check the images you selected on the image list.
 - If you selected “By Folder No.”, the first or last image in the selected folder is displayed.

Printing a searched image

Press $\triangleleft/\triangleright/\Delta/\nabla$ to select the image that you want to print and then press ENTER. Press Δ/∇ to set the print quantity and then press ENTER again.

If you want to print multiple images, repeat these procedures.

Press PRINT to start printing. The specified number of copies of the selected images are printed.

Deleting images

You can delete the selected images or format the “Memory Stick”.

Buttons to be used in this section

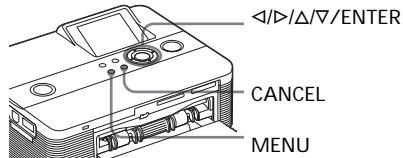

Notes

- During deleting or formatting, do not turn off the printer or remove the memory card. The printer, the memory card or an external device may be damaged. Or the image may be damaged.
- An image, once deleted, will be lost forever. Before deleting an image, double-check that it is the right one.
- When formatting a “Memory Stick”, all the files including the image files will be deleted.
- You cannot delete an image of an external device.
- You cannot format a memory card other than the “Memory Stick”.

Deleting selected images

You can select and delete images on a memory card.

- 1 Press MENU.
The menu bar is displayed.

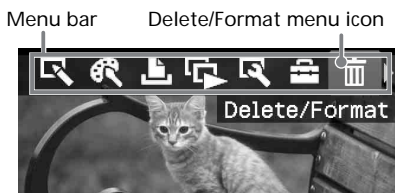

To exit the menu mode, press MENU.
The previous window is displayed.

- 2 Press $\triangleleft/\triangleright$ to select  (Delete/Format) and then press ENTER.
The Delete/Format menu is displayed.

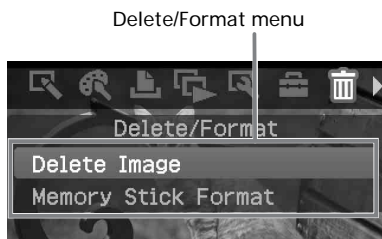

- 3 Press $\triangleup/\triangledown$ to select "Delete Image" and press ENTER.
The image list is displayed.





- 4 Press $\triangleleft/\triangleright/\triangleup/\triangledown$ to move the trash icon to the image you want to delete, then press ENTER.
A confirmation dialog box is displayed.

- 5 Press $\triangleleft/\triangleright$ to select "OK" and press ENTER.
The selected image is deleted. To delete other images, repeat steps 4 through 5.

Tip

To exit the Delete/Format menu, press MENU or CANCEL.

Notes

- When you delete an image with the associated file indication () , the associated motion or e-mail file will be also deleted.
- You cannot delete a protected image with the protect indication () or a waiting-to-print indication () displayed.

Formatting a "Memory Stick"

You can format a "Memory Stick".

- 1 Press MENU.
The menu bar is displayed.
- 2 Press $\triangleleft/\triangleright$ to select  (Delete/Format) and then press ENTER.
The Delete/Format menu is displayed.
- 3 Press $\triangleup/\triangledown$ to select "Memory Stick Format" and press ENTER.
The confirmation dialog box is displayed.
- 4 Press $\triangleleft/\triangleright$ to select "OK" and press ENTER.
The "Memory Stick" is formatted.

Note

When you format a "Memory Stick", all the images inside are deleted.

Changing the print settings (Set Up)

The Set Up menu allows you to change various print settings listed on pages 42 and 43.

Buttons to be used in this section

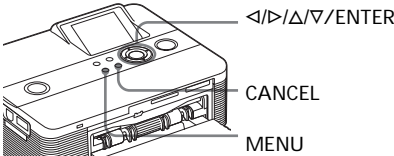

- 1 Press MENU.
The menu bar is displayed.



To exit the menu mode, press MENU.
The previous window is displayed.

- 2 Press </> to select  (Set Up) and then press ENTER.
The Set Up menu is displayed.



Note

Setting items which cannot be changed are displayed in gray and cannot be selected.

- 3 Press Δ/∇ to select the desired setting item, and press ENTER.
The setting window for the selected item is displayed (next page).
- 4 Press Δ/∇ to select the desired setting and press ENTER.
The setting is fixed.

Tip

To exit the Set Up menu, press MENU.

Continued

Item	Settings	Contents
Auto Fine Print 3	Photo*/Vivid	<ul style="list-style-type: none"> • Photo: Adjusts an image automatically so that the image is printed with natural and beautiful pictures. (Recommended) • Vivid: Adjusts an image automatically so that the image is printed with stronger sharpness correction and more vivid pictures than the Photo mode. <p>Notes</p> <ul style="list-style-type: none"> • The image data is not corrected. • When printing in PC mode, the Auto Fine Print 3 setting with the printer driver has priority over the setting here. In the PictBridge mode, this setting holds effective.
	Off	Prints an image without any corrections.
Exif Print	On*	Adjusts an image shot by an Exif Print (Exif 2.21)-compliant digital camera to its optimum picture quality. <p>Note</p> The image data is not corrected.
	Off	Prints an image without any adjustments.
Borders	Yes	Prints an image with borders around the image. <p>Note</p> Depending on an image, its top and bottom edges or right and left edges may be trimmed and printed.
	No*	Prints an image without blank space around the image. <p>Note</p> When printing a standard 4:3 picture shot by a digital camera, the top and bottom edges of the image are cut and it is printed as a 3:2 picture.

*: Factory settings

Item	Settings	Contents
Date Print	On	Prints the date of shooting with an image when the image is a file recorded in the DCF (Design rule for Camera File system) format. To make a print with the date of shooting, shoot an image in the DCF file format. When the image is saved with the printer, the date of saving is printed.
	Off*	Prints an image without the date.
Color Setting		<p>Adjusts the colors and sharpness of a print. Press </> to select a color element ("R" (red), "G" (green), or "B" (blue)) or "S" (Sharpness), and then press Δ/∇ to set the level. You can set the levels for R, G, B in the range from +4 to -4 and for S in the range from +7 to 0.</p> <p>R: Adjusts the red and blue elements. The higher you set the level, the more reddish the picture becomes as if it receives red light. The lower you set the level, the darker the picture becomes as if light blue is added.</p> <p>G: Adjusts the green and purple elements. The higher you set the level, the more greenish the picture becomes as if it receives green light. The lower you set the level, the darker the picture becomes as if red purple is added.</p> <p>B: Adjusts the blue and yellow elements. The higher you set the level, the more bluish the picture becomes as if it receives blue light. The lower you set the level, the darker the picture becomes as if yellow is added.</p> <p>S: The higher you set the level, the more distinct the outlines become.</p> <p>(*R: 0/G:0/B:0/S:0)</p>

*: Factory settings

To cancel settings

Press CANCEL. The settings will be returned to the state they were in before you made changes.

Changing the printer preferences (Option)

The Option menu allows you to change the preferences listed on page 45.

Buttons to be used in this section

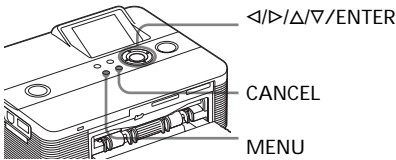

- 1 Press MENU.
The menu bar is displayed.



To exit the menu mode, press MENU.
The previous window is displayed.

- 2 Press </> to select  (Option) and then press ENTER.
The Option menu is displayed.



- 3 Press Δ/∇ to select the desired setting item, and press ENTER.
The setting window for the selected item is displayed (next page).
To display the hidden setting items, scroll the window with Δ/∇.

Note

Items which cannot be changed are displayed in gray and cannot be selected.

- 4 Press Δ/∇ to select the desired setting and press ENTER.
The setting is fixed.

Tip

To exit the Set Up menu, press MENU.

Item	Settings	Contents
Listing Order	Ascending*	In the image list window, the images are displayed in the order of their image numbers, starting from the smallest number.
	Descending	In the image list window, the images are displayed in the order of their image numbers, starting from the largest number.
Icon	On*	In the image list window, the images without thumbnail (miniature image used as index) data will be displayed as an icon.
	Off	In the image list window, the images without thumbnail (miniature image used as index) data will be displayed as its original image.
Image Data Display	On	In an image preview window, image information (file type, shooting conditions, etc.) will be displayed.
	Off*	In an image preview window, no image information will be displayed.
Date Display Order	Set the displayed order of the date (Year, Month, and Day) from the following: • Y/M/D* • M/D/Y • D/M/Y	
LCD Backlight	Set the brightness level of the LCD backlight from the following: Bright*/Dark	
Demonstration Mode	On*	A flash file demonstration to explain the functions of the printer starts automatically after the printer has been left unused for about 3 minutes without any media connected. To stop the demonstration, press any button.
	Off	No demonstration flash file will be started.
Language	You can select the language of menu or messages. Depending on the region you purchased the unit, some of the following languages will appear: English*/French/Italian/German/Spanish/Russian/Korean/Chinese (Simplified)	

*: Factory settings

Note

To display the hidden setting items, scroll the window with Δ/∇ .

To cancel settings

Press CANCEL. The settings will be returned to the state they were in before you made changes.

Printing images from the digital camera

You can connect a PictBridge-compliant digital camera and print an image directly from your digital camera.

Before you begin

You need preparations **1** through **4** (pages 10 to 15), and the following:

- 1** Set your digital camera ready for printing with a PictBridge-compliant printer.
The settings and operations that are necessary before connection differ depending on the digital camera. For details, see the operating instructions of the digital camera you use. (In case of Sony Cyber-shot digital camera, for example, select “PictBridge” or “Auto” mode for the “USB Connect”.)

Note

When you use a DSC-T1, you need to update software version.

- 2** Connect the printer to the AC power source (page 16).
- 3** Press \odot (on/standby) switch to turn on the printer (page 20). The \odot (on/standby) indicator of the printer lights in yellow green.
- 4** Connect a PictBridge-compliant digital camera to the PictBridge connector of the printer (page 18). When you connect a PictBridge-compliant digital camera to the printer, “The printer is being connected to PictBridge camera.” is displayed on the display window of the printer.

- 5** Operate the digital camera to print an image.
The printer supports the following prints:

- Single-image print.
- All images print
- Index print
- DPOF print
- Border/Borderless print
- Date print

For notes during printing, see page 21.

Notes

- If you replace a print cartridge while the printer is connected to a PictBridge-compliant digital camera, an image may not be printed properly. If this occurs, disconnect and then connect the digital camera.
- If you print an image from your digital camera without picture quality settings, it will be printed according to the settings of the Set Up menu.

To PictBridge connector
(USB A-TYPE)

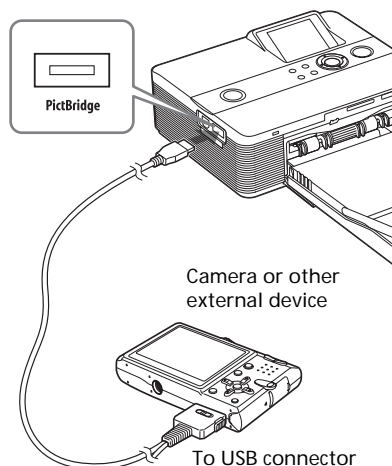

You can print the images from a PC by installing the supplied software on your PC and connecting it to the printer .

This section explains how to install the supplied software on your PC and how to use the supplied Picture Motion Browser software to print an image.

Please also refer to the operating instructions supplied with your PC.

Installation of the software is necessary only when you connect the printer to your PC for the first time.

On the supplied CD-ROM

The supplied CD-ROM contains the following software:

- Printer driver for DPP-FP55: The software describes the printer's requirements and enables printing from the computer.
- Picture Motion Browser: Sony's original software application that allows you to handle photographs and moving images—capturing, managing, processing, and printing.

Installing the software

System requirements

To use the supplied printer driver and Picture Motion Browser, your PC must meet the following system requirements:

OS: Microsoft Windows[®] XP Professional/Windows[®] XP Home Edition/Windows[®] 2000 Professional/Windows[®] Millennium Edition, pre-installed (IBM PC/AT compatible)

(Windows 95, Windows 98 Gold Edition, Windows 98 Second Edition, Windows NT, other versions (ex. Server) of Windows 2000 are not supported.)

CPU: Pentium III 500MHz or faster (Pentium III 800MHz or faster is recommended.)

RAM: 128 MB or more (256 MB or more is recommended.)

Hard disk space: 200 MB or more (Depending on the Windows version you use, more space will be required. To handle image data, you will need additional hard disk space.)

Display:
Screen area: 800 x 600 pixels or more
Colors: High Color (16-bit) or more
Required software: DirectX 9.0 or higher (Required for the Picture Motion Browser.)

Notes

- If a hub is used to connect the printer and your PC, or if two or more USB devices including other printers are connected to your PC, a trouble may occur. If this occurs, simplify the connections between your PC and the printer.
- You cannot operate the printer from another USB device being used simultaneously.

Continued

- Do not remove the USB cable from or connect it to the printer during data communication or printing. The printer may not work properly.
- Do not allow the PC connected to the printer to switch to standby mode or hibernation mode during printing. If you do so, the printer may not print properly.
- We cannot guarantee operations with all personal computers, even though they may meet or exceed the system requirements.
- Picture Motion Browser supports the DirectX technology and the DirectX installation may be required.
- If the Picture Motion Browser is installed on a PC on which the Cyber-shot Viewer is already installed, the Cyber-shot Viewer will be overwritten and replaced by the Picture Motion Browser. The browsing folders once registered in the Cyber-shot Viewer will be automatically registered in the Picture Motion Browser. When using the Picture Motion Browser, you can view the folders easier than you can when using the Cyber-shot Viewer, as the registered folders are displayed by group when viewing folders. With its improved red-eye reduction adjustment and newly-added tone curve adjustment, the Picture Motion Browser also offers more powerful editorial features. You can also use the software to write data into an external memory card for taking it outside.+-

Installing the printer driver

- 1 Make sure that the printer is **disconnected** from the computer.

Note

If you connect the printer to your PC in this stage, either of the following dialog boxes are displayed:

- When using Windows Me: Add New Hardware Wizard
- When using Windows 2000/XP: Found New Hardware Wizard

If this occurs, disconnect the printer from the PC and then click "Cancel" in the dialog box.

- 2 Turn on your computer and start Windows.

- When installing or uninstalling the software in Windows[®] 2000 Professional, log on to Windows as "Administrator" or "Power user".
- When installing or uninstalling the software with Windows[®] XP Professional/Windows[®] XP Home Edition, log on using a "Computer administrator" user account.

Notes

- Be sure to close all running programs before installing the software.
- The dialog boxes in this section are those in Windows XP Professional, unless otherwise specified. The installation procedures and the dialog boxes shown differ depending on the operating system.

- 3 Insert the supplied CD-ROM into the CD-ROM drive of your computer.

The setup starts automatically and the installation window is displayed.

Note

In case the installation window is not automatically displayed, double-click the "Setup.exe" of the CD-ROM.

- 4 Click "Installing Printer Driver".

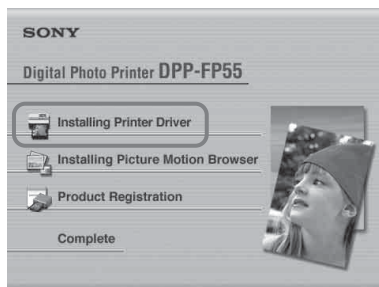

The "Sony DPP-FP55 - InstallShield Wizard" dialog box appears.

5 Click “Next”.
The license agreement dialog box is displayed.

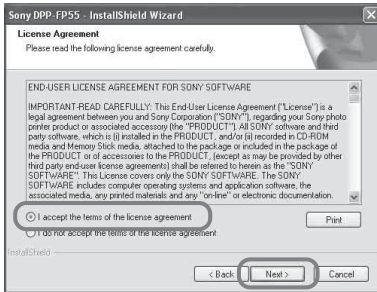

6 Check “I accept the terms of the license agreement” and click “Next”.
If you check “I do not accept the terms of the license agreement”, you cannot proceed to the next step.



The “Ready to install the program” dialog box is displayed.

7 Click “Install”.
The “Printer connection” dialog box is displayed.

8 Connect the printer to the AC power source (page 16).

9 Press  (on/standby) switch to turn on the printer (page 20).
The  (on/standby) indicator of the printer lights in yellow green.

10 Click “Next”.



11 Connect the USB connectors of the printer and your computer.

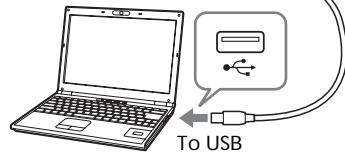
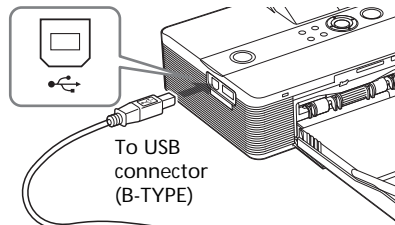

Windows PC

Note

In case you use commercially available USB cable, use a B-type USB cable shorter than 3m in length.

The printer automatically enters the PC mode and the printer setup will start automatically.

When the printer setup is complete, the “InstallShield Wizard Complete” dialog box is displayed.

12 Click “Finish”.
The installation of the printer driver is complete. When you are prompted to restart your computer, restart the computer.

13 • To finish installation, click “Complete” and remove the CD-ROM from your computer and keep it for future use.
• To continue to install the Picture Motion Browser software, click “Installing the Picture Motion Browser” and follow the procedures on page 51.

Notes

- If the printer driver CD-ROM is prompted during the installation, specify the following directory:
C:\WINDOWS\Temp\dpp-fp55
Replace “C:\WINDOWS” with the Windows folder location of your PC.
- The supplied CD-ROM will be required when you uninstall or re-install the printer driver. Keep it in good order for possible future use.
- If the installation fails, remove the printer from your computer, restart your computer, and then do the installation procedures from the step 3.
- After installation, the “Sony DPP-FP55” is not set as the default printer. Set the printer you use for each application.
- Before you use the printer, read the Readme file (the Readme folder of the CD-ROM→English folder→Readme.txt).

Checking the installation

Open the “Printers and Faxes” (in case of Windows® XP Professional/Windows® XP Home Edition) or “Printers” from the “Control Panel”. When the “Sony DPP-FP55” is displayed in the “Printers and Faxes” or “Printers” window, the printer driver has been successfully installed.

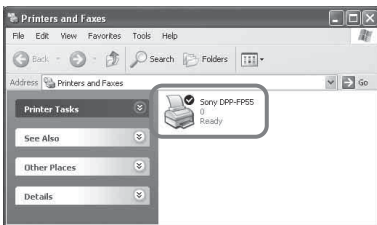

Uninstalling the printer driver

When the printer driver becomes unnecessary, remove it from your PC hard disk as follows:

- 1 Disconnect the USB cable from your printer and the computer.
- 2 Insert the supplied CD-ROM into the CD-ROM drive of your computer.
The setup starts automatically and the installation window is displayed.
- 3 Click “Installing Printer Driver”. The “Sony DPP-FP55 - InstallShield Wizard” dialog box appears.
- 4 Click “Next”.
The license agreement dialog box is displayed.
- 5 Check “I accept the terms of the license agreement” and click “Next”.
The dialog box used for confirming uninstallation is displayed.
- 6 Click “Yes”.

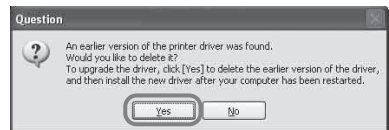

The dialog box used for restarting the computer is displayed.

7 Check "Yes, I want to restart my computer now" and click "OK".

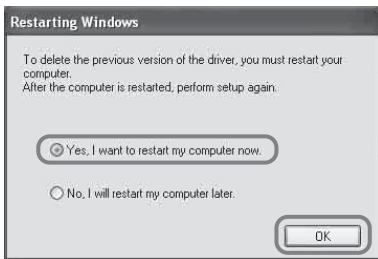

After the computer is restarted, the relevant files will be deleted and uninstallation is complete.

To check uninstallation

Select "Printers and Faxes" (in case of Windows® XP Professional/Windows® XP Home Edition) or "Printers" from the "Control Panel" to check if the "Sony DPP-FP55" is displayed. If not, the printer driver is successfully removed.

Installing the Picture Motion Browser

1 Turn on your computer and start Windows.

- When installing or uninstalling the software in Windows® 2000 Professional, log on Windows as the user name of "Administrator" or "Power user".
- When installing or uninstalling the software in Windows® XP Professional/Windows® XP Home Edition, log on as a user name with the "Computer administrator" user account.

Notes

- Be sure to close all running programs before installing the software.
- The dialog boxes in this section are those in Windows XP Professional, unless otherwise specified. The installation procedures and the dialog boxes shown differ depending on the operation system.

2 Insert the supplied CD-ROM into the CD-ROM drive of your computer.

The setup starts automatically and the installation window is displayed.

Note

In case the installation window is not automatically displayed, double-click the "Setup.exe" of the CD-ROM.

3 Click "Installing Picture Motion Browser."

The "Picture Motion Browser Setup" starts and the "Choose Setup Language" dialog box is displayed.

4 Select the language to be used during installation and click "Next."

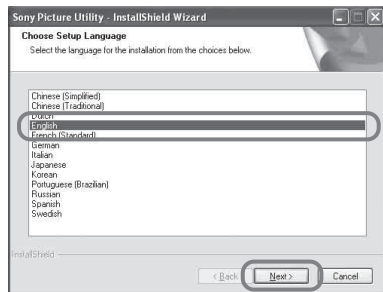

The "Sony Picture Utility Setup" dialog box is displayed.

5 Click "Next."

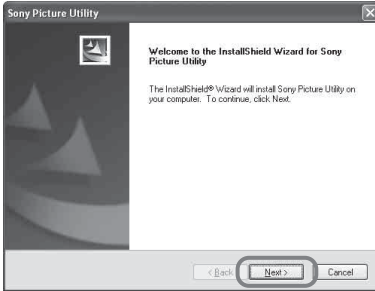

The license agreement dialog box is displayed.

6 Check "I accept the terms of the license agreement" and click "Next."

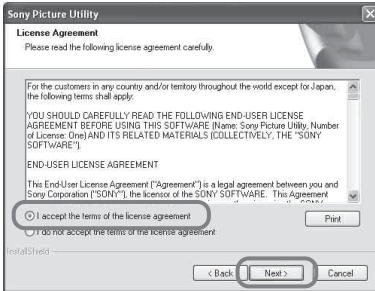

The dialog box used to specify the destination folder is displayed.

7 Check the destination and then click "Next."

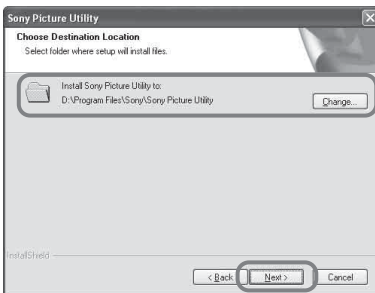

The "Ready to install the program" dialog box is displayed.

8 Click "Install."

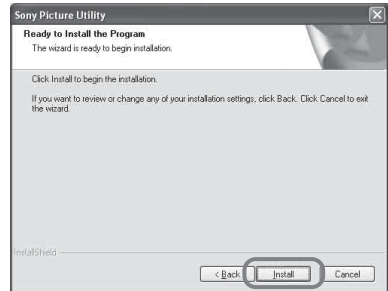

The "Setup Status" dialog box is displayed.

When the printer setup is complete, the "InstallShield Wizard Complete" dialog box is displayed.

9 Click "Finish."

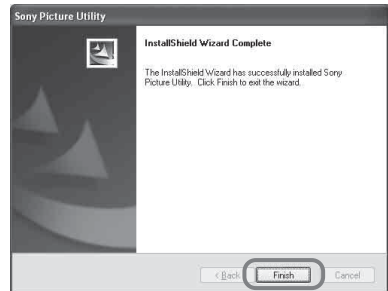

The installation of the Picture Motion Browser is complete. When you are prompted to restart your computer, restart it.

10 Remove the CD-ROM from your computer and keep it for future use.

Notes

- If the installation fails, perform the installation procedures from step 2 again.
- The supplied CD-ROM will be required when you uninstall or re-install the Picture Motion Browser. Keep it in a safe place for possible future use.

When the software is installed

The  is displayed on the Windows desktop, as well as a shortcut to the web site for printer customer registration. If you finish registration, you can find support information at:
<http://www.sony.net/registration/di/>

Uninstalling the Picture Motion Browser

When this software is no longer needed, remove it from your computer as follows:

- 1 Click "Start" - "Setting" - "Control Panel" (or "Start" - "Control Panel" with Windows XP).
- 2 Double-click "Add/Remove Programs."
The Control Panel is displayed.
- 3 Select "Sony Picture Utility" and click "Change/Remove" ("Remove" with Windows XP).
The software is uninstalled.

Printing photos from the Picture Motion Browser

You can use the Picture Motion Browser to print an image from your PC using post card size print paper.

- 1 Start the Picture Motion Browser window using either of the following methods:

- Double-click  (Picture Motion Browser) on the Windows desktop.
- Click "Start" - "All Programs" (or "Programs" with Windows 2000) - "Sony Picture Utility" - "Picture Motion Browser."

When the Picture Motion Browser is started for the first time, the registration window is displayed. If images have already been saved in the "My Pictures" folder, click "Register Now."

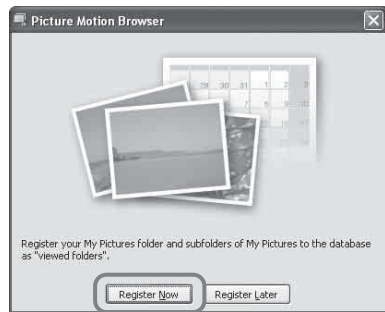

If you have saved images in a folder other than the "My Pictures" folder, click "Register Later." Refer to "To register a browsing folder" (page 59).

Continued

How to access the “My Pictures” folder

- In Windows Me/2000:
Click “My Documents” - “My Pictures” on the desktop.
- In Windows XP:
Click “Start” - “My Pictures” from the taskbar.

The main window of the Picture Motion Browser is displayed.

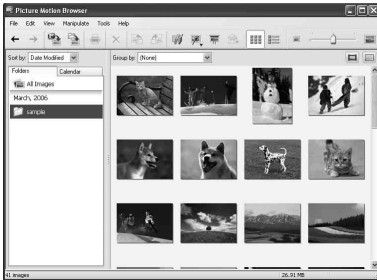

To switch the display of the main window

There are 2 different versions of photo view used in the main window as follows:

To switch the view, click the tab “Folders” or “Calendar.”

- “Folders” view
The images will be classified in each registered folder and are displayed as thumbnails.
- “Calendar” view
The images will be classified according to the shot date and are displayed as thumbnails on each date of the calendar. In “Calendar” view, you can switch the display according to the year, month, or hour.

- 2** Click the folder containing the photos you want to print.
As an example, the “sample” folder is selected in the following explanation.

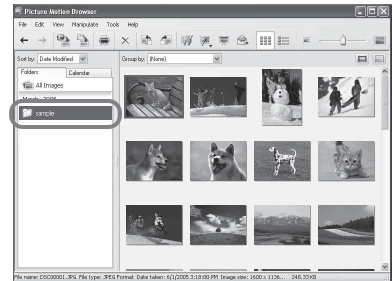

- 3** Select the photos that you want to print and click  (print).

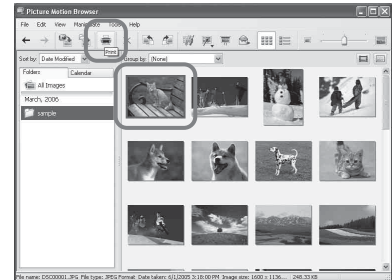

The Print dialog box is displayed.

- 4** In the “Print” drop-down list box, select “Sony DPP-FP55” and then click “Print.”
The preparations for printing start.

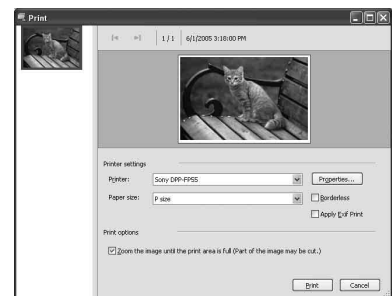

Items Functions

Printer Select “Sony DPP-FP55”.

Paper size

From the drop-down list box, select the paper size you actually use for printing:

- P size
- L size

Note

In some regions, L size print paper is not sold.

Print options

- When checked, an image will be printed over the entire printing area of the paper. An edge of the photo may not be printed.
- When unchecked, an image will be printed without cutting off an edge.

Tip

To print an image without margins around it (Borderless Print), you must check this option.

Borderless

- When checked, an image will be printed without margins around it.
- When unchecked, an image will be printed with margins around it.

Tip

When you make a Borderless Print, you must check the “Zoom the image until the print area is full” item for Print options.

Items Functions

Apply Exif Print

- When checked, **an image shot with a Exif Print (Exif 2.21)-compliant digital camera** will be adjusted and printed with its optimum picture quality.

Note

The image displayed on the monitor will not be adjusted.

- When unchecked, an image will be printed without adjustments.

Note

Even if you uncheck the item, “Color reproduction/Picture quality” is still set to “Auto Fine Print 3”. To change the “Color reproduction/Picture quality” settings, follow the Properties steps.

Properties

Specifies orientation, picture quality and other details.

To make detailed settings, click “Properties,” so that the properties dialog box for the selected printer is displayed.

Continued

5 In the “Paper/Output” tab, specify the paper size.

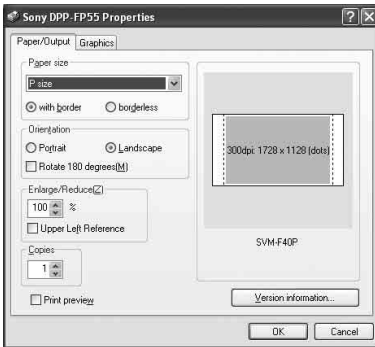

Items Functions

Paper size

From the drop-down list box, select the paper size you actually use for printing:

- P size
- L size

Then check either of the following to specify the margins around the image:

- with border: an image is printed with borders around it.
- borderless: an image is printed without borders around it.

Tip

The settings in the properties dialog box will be reflected in the Print dialog box.

Orientation

Select the orientation of an image when printed:

- Portrait
 - Landscape
 - Rotates 180 degrees
-

Items Functions

Copies Specify the number of copies to be printed.

Enlarge/Reduce

Specify the percentage to enlarge or reduce the size of an image when printed.

You can set the reference point when an image is enlarged or reduced by checking “Upper left reference”.

- When unchecked, an image is enlarged or reduced with the center as the reference point. Usually, use this option.
 - When checked, an image is enlarged or reduced with the upper left corner as the reference point.
-

Print preview

Check this option to display a preview of an image before printed.

6 In the “Graphics” tab, set the color reproduction and picture quality.

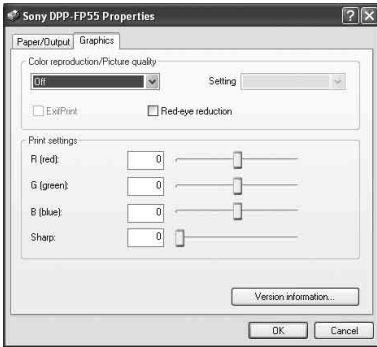

Items Functions

Color reproduction/Picture quality

Select the setting from the drop-down list box:

- Off: An image will be printed without adjustment. **In this case “ExifPrint” is disabled.**
- Auto Fine Print 3: From the “Settings” drop-down list box, select either of the following correction method:
 - Photographical: An image will be adjusted automatically and printed with natural and beautiful pictures. (Recommended option)
 - Vivid: An image will be adjusted automatically and printed with more vivid pictures. (In this setting, a stronger sharpness correction is given, making pictures more vivid.)

Items Functions

- ICM (system): From the “Settings” drop-down list box, select either of the following correction method:
 - Graphics: when graphics or vivid colors are used.
 - Match: when you want to match colors.
 - Pictures: when a photograph or pictures are printed.

ExifPrint

Check it to adjust and print an image shot with a Exif Print (Exif 2.21)-compliant digital camera. The printer driver uses the color conversion and Exif shooting data to adjust the image. **This option is effective only with Picture Motion Browser.**

Tip

The settings in the properties dialog box will be reflected in the Print dialog box.

Red-eye reduction

Check it to automatically reduce the red-eye phenomenon of the subject shot by using a flash light.

Notes

- When you check this option, make sure to select “Preview” to display the preview image before printing and check that the red-eye reduction has been correctly processed to the image.

Continued

Items Functions

- Red-eye phenomenon will be detected automatically, and it may not be corrected.
If red-eye phenomenon is not corrected, use the Picture Motion Browser correction function.
- Red-eye reduction is enabled only when you have installed the printer driver from "Setup.exe" in the supplied CD-ROM. For the details see the Readme.txt.

Print settings

Adjusts the color elements and sharpness.

R (red): Adjusts the red and blue elements. The higher you set the level, the more reddish the picture becomes as if it receives red light.

The lower you set the level, the darker the picture becomes as if light blue is added.

G (green): Adjusts the green and purple elements. The higher you set the level, the more greenish the picture becomes as if it receives green light. The lower you set the level, the darker the picture becomes as if red purple is added.

B (blue): Adjusts the blue and yellow elements. The higher you set the level, the more bluish the picture becomes as if it receives blue light. The lower you set the level, the darker the picture becomes as if yellow is added.

Sharp (sharpness): The higher you set the sharpness level, the more distinct the outlines become.

7 Click "OK."

The print dialog box is displayed.

Tip

When "Print preview" is checked in step 5, the preview window is displayed. Check the results of any adjustments and then click "Print."



Printing resumes. Make sure to read "Notes on printing" on page 21, as well.

For the details of the properties of the Picture Motion Browser, see the Picture Motion Browser online Help.

Note

You cannot print a motion-picture file or RAW data files.

Tips

- To select serial still images in the image area of the main window, click the first image in the series and then click the last image while pressing the Shift key.
- To select multiple still images not in a sequence, click the images individually while pressing the Ctrl key.
- You can print from an image preview.
- The Picture Motion Browser is compatible with the ICM.

To register a browsing folder

The Picture Motion Browser does not allow you to view images saved on the PC hard disk directly. You must to register the browsing folder as follows:

- 1 Click "File" - "Register Viewed Folder," or click  (Register Folders to View). The browsing folder registration window is displayed.

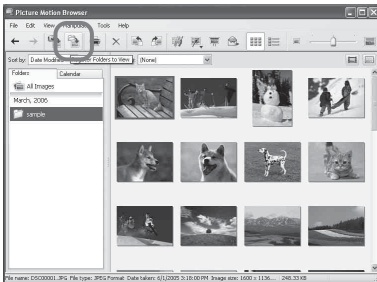

- 2 Select the folder you want to register and then click "Register."



Note

You cannot register the whole drive.

- 3 Click "Yes."
Registration of the image information in the data base starts.

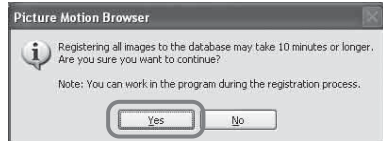

- 4 Click "Close."



Notes

- The folder you select as the destination of the imported images will be registered automatically.
- You cannot cancel registration of the folder you register here.

To change the browsing folder

Click "Tools" - "Settings" - "Viewed folders."

Tips

- If a sub folder is contained in the source folder, the images in the sub folder will also be registered.
- When the software is first started, the message prompting you to register "My Pictures" will be displayed.
- Depending on the number of images, it may take some tens of minutes to register images.

Continued

To stop printing

- 1 Double-click on the printer icon on the taskbar, and open the “Print” dialog box.
- 2 Click the document name that you want to cancel printing of and then click “Cancel” from the “Document” menu.

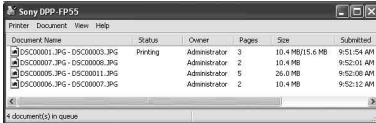

The dialog box used for confirming the deletion is displayed.

- 3 Click “Yes.”
The printing job is canceled.

Note

Do not cancel the printing job during the printing process, which may cause a paper jam.

Printing from other application software

You can use a commercially-available application software to print an image from the DPP-FP55. Select “DPP-FP55” in the print dialog box and select the print paper size in the page setup dialog box. For details in print settings, see steps 5 and 6 on pages 56 and 57.

On “borderless” setting in the “Paper size” section

When using an application other than the Picture Motion Browser, an image might be printed with borders even if you select borderless print in the “Paper size” section of the “Paper/Output” tab in the “Sony DPP-FP55 Properties” dialog box.

When you select the borderless print option, the printing range information for borderless print will be supplied to the application. Some applications, however, may arrange and print the image with borders within the specified range.

If this occurs, do either of the following to print an image without borders:

- When you can set print range with an application, set an image to be printed fully in the print range. For example, select “Full page photo print” or a similar option.
- Set a larger value in the “Enlarge/Reduce” text box in the “Paper/Output” tab of the “Sony DPP-FP55 Properties” dialog box.

If borders remain on the right and bottom sides of a printed image even after you set a larger value, check “Upper left reference”.

In either case, make sure to display and check the preview image before printing.

Orientation setting

Depending on the application software you use, orientation may not change even if you change portrait or landscape setting.

With border/borderless setting of the printer driver

When the application software you use has border/borderless setting, we suggest you select borderless as the printer driver setting.

Print quantity setting in the Properties dialog box

Depending on the application software you use, the print quantity setting of the application you use may have priority over the setting specified in the printer driver dialog box.

Exif Print Settings in the “Graphics” tab

The Exif Print setting in the “Color reproduction/Picture quality” section supports the Picture Motion Browser only. If you use other application to print an image with this option checked, the image may be printed with incorrect colors. If this occurs, remove the check.

If trouble occurs





If you run into any problems using the printer, use the following guidance to solve the problem. If the problem persists, consult your Sony dealer.

Power

Symptom	Check	Cause/Solutions
The ⏻ (on/standby) switch cannot be turned on.	<ul style="list-style-type: none"> • Is the AC power cord properly connected? 	<p>→ Connect the AC power cord to an AC outlet securely. (→ page 16)</p>

Displaying images

Symptom	Check	Cause/Solutions
The LCD screen displays no images.	<ul style="list-style-type: none"> • Does the LCD screen of the printer show “The printer is being connected to a PictBridge camera.” or “The printer is being connected to a PC.”? 	<p>→ When a PictBridge camera or a PC is connected to the printer and the printer operates on the PictBridge/PC mode, no images will be displayed on the window.</p> <p>When a memory card or an external device is connected, the images will be displayed in the following priority: “Memory Stick”→“SD Card”→ “External Device”</p>
	<ul style="list-style-type: none"> • Are any error messages displayed (cause/remedies) on the LCD screen? 	<p>→ Follow the directions of the messages, if any, and try to solve the problem. (→ page 77)</p>
	<ul style="list-style-type: none"> • Is the memory card or an external device properly inserted? 	<p>→ Insert a memory card or an external device properly. (→ pages 17 to 19)</p>
	<ul style="list-style-type: none"> • Does the memory card or an external device contain images recorded with a digital camera or other device? 	<p>→ Insert a memory card or an external device that contains the recorded images.</p>

Symptom	Check	Cause/Solutions
Some images in the image list are not displayed or not printed even if they are displayed.	<ul style="list-style-type: none"> • Are thumbnail images displayed in the image list? 	<ul style="list-style-type: none"> → If the image is displayed but cannot be printed, the file used for printing is damaged. → If there are no images stored in the memory card or an external device, the "No image file" message appears. → If an image is not compatible with DCF (Design rule for Camera File system), it may not be printed with the printer even if it is displayed on the PC monitor.
	<ul style="list-style-type: none"> • Does the mark displayed below appear in the image list?  <ul style="list-style-type: none"> • Was the image created on your PC? 	<ul style="list-style-type: none"> → If the mark shown on the left is displayed, the image may be a JPEG file created with your computer, or the thumbnail data is not contained. Select the mark and press  (zoom in) repeatedly to display its image preview. If an image is displayed, you can print the image. If the same mark is displayed again, the image is of incompatible file format and you cannot print it with the printer.
	<ul style="list-style-type: none"> • Does the mark displayed below appear in the image list? 	<ul style="list-style-type: none"> → If the mark shown on the left is displayed, the image is of compatible file format but its thumbnail data or the data itself cannot be opened. Select the mark and press  (zoom in) repeatedly to display its image preview. If an image is displayed, you can print the image. If the same mark is displayed again, you cannot print it with the printer.
	<ul style="list-style-type: none"> • Are there more than 9 999 images saved in the memory card or an external device? 	<ul style="list-style-type: none"> → The printer can display, save, delete or handle up to 9 999 image files. If there are more than 9 999 images stored in a memory card or an external device, use the PC or PictBridge mode to display and handle the remaining images.

Symptom	Check	Cause/Solutions
Some images in the image list are not displayed or not printed even if they are displayed.	<ul style="list-style-type: none"> • Did you name or rename an image file with your PC? 	<p>→ When you name or rename an image file on your computer and its file name includes characters other than alphanumeric characters, the file name may not be displayed correctly or the image may not be displayed on the printer (read error).</p>
	<ul style="list-style-type: none"> • Did you specify the print quantity in the image list? 	<p>→ Once you have selected images in the "Printing multiple images" procedures, you cannot print an image with which the cursor is just placed. Press ENTER to select it and specify the print quantity for the image. (→ page 22)</p>
	<ul style="list-style-type: none"> • There are 8 or more hierarchies in the memory card or an external device. 	<p>→ The printer cannot display the images saved in a folder of the 8th or higher hierarchy.</p>
The file name is not displayed correctly.	<ul style="list-style-type: none"> • Did you change the file name of the image with your PC? 	<p>→ When you name or rename an image file on your computer and its file name includes characters other than alphanumeric characters, the file name may not be displayed correctly. For a file created with a PC application, the first 8 characters of its file name will be displayed as the file name.</p>
In the Edit menu, there are blank areas at the top and bottom of the previewed image.	<ul style="list-style-type: none"> • Is the previewed image extremely stretched vertically or horizontally? 	<p>→ If an image is extremely stretched vertically or horizontally, blank areas may appear in the Edit menu.</p> <p>→ The standard aspect ratio of an image shot with a digital camera is 3:4. When an image is edited or printed in the postcard size, it is saved as a more horizontal print image and its top and bottom edges will be cut and displayed in black.</p>

Printing

Symptom	Check	Cause/Solutions
Paper does not feed.	<ul style="list-style-type: none"> • Is the print paper properly set in the paper tray? 	<p>→ If print paper is not properly loaded, the printer may develop trouble. Check the following:</p> <ul style="list-style-type: none"> • Is the correct set of print paper and print cartridge loaded? (→ page 11) • Is the print paper loaded in the correct direction in the tray? (→ page 14) • Did you place more than 20 sheets of print paper in the paper tray? (→ page 14) • Did you riffle the print paper thoroughly? • Did you bend or fold the print paper before printing?
	<ul style="list-style-type: none"> • Are you using print paper that was not designed for the printer? 	<p>→ Use print paper designed for the printer. If you use incompatible print paper, the printer may develop trouble. (→ page 11)</p>
	<ul style="list-style-type: none"> • Is the print paper jammed? 	<p>→ When the printer cannot feed the print paper, an error message is displayed. Remove the paper tray and check paper jam. (→ page 80)</p>
The print paper emerges partially during printing in process.	<ul style="list-style-type: none"> • Is it in the middle of the printing process? 	<p>→ The print paper may emerge a few times during printing. Do not touch nor pull the emerged paper. Wait for the print paper to be fully ejected after printing ends. As the print paper emerges from the rear a few times during printing, make sure to spare enough space behind the printer during printing.</p>

Printed results

Symptom	Check	Cause/Solutions
The printed pictures are inferior in quality.	<ul style="list-style-type: none"> • Did you print preview image data? 	<ul style="list-style-type: none"> → Depending on the type of digital camera used, preview images may be displayed along with the primary images in the thumbnail list. The printed quality of the preview images will not be as good as the primary images. Note that if you delete the preview images, the data for the primary images may be damaged.
	<ul style="list-style-type: none"> • Did you print an image whose size (width or height) is smaller than 480 dots? Is the following mark displayed in the image list? 	<ul style="list-style-type: none"> → When the image is displayed as the mark shown on the left, it is a small image. The printing quality is rough due to this small image size. → Change the image size setting of the digital camera you are using.
	<ul style="list-style-type: none"> • Did you use the Edit menu to enlarge the image? 	<ul style="list-style-type: none"> → An enlarged image, depending on its image size, will be printed with deteriorated picture quality.
	<ul style="list-style-type: none"> • Did you allow dust to get on the print cartridge? 	<ul style="list-style-type: none"> → Wipe the plastic part of the print cartridge and remove dust.
	<ul style="list-style-type: none"> • Did you allow dust or finger prints to get on the printed surface? 	<ul style="list-style-type: none"> → Do not touch the printing surface (the shiny-side with no imprint). Fingerprints on the printing surface may result in imperfect printing.
	<ul style="list-style-type: none"> • Did you use used print paper? 	<ul style="list-style-type: none"> → Do not print on used print paper. Printing an image twice on the same paper will not make the printed image thicker.

Symptom	Check	Cause/Solutions
<p>The printed pictures are inferior in quality.</p>	<ul style="list-style-type: none"> • Did you shoot an image in the RAW file format? 	<p>→ When you shoot an image in the RAW file format, a highly-compressed JPEG file may be also recorded. As the printer does not support the RAW file format, it may use the JPEG file to print an image. A RAW file can be printed from a PC. For details, see the operating instructions of the digital camera you are using.</p> <p>What is a RAW file? A RAW file is an original image file format to save uncompressed, unprocessed still image data captured from a digital camera. For whether or not a digital camera can capture an image in the RAW file format, see the operating instructions of the digital camera.</p>
	<ul style="list-style-type: none"> • Did you use an AdobeRGB-compliant digital camera, not compatible with the DCF 2.0, to shoot an image in the AdobeRGB mode? 	<p>→ An AdobeRGB image file that supports the DCF 2.0 will undergo color corrections, but an AdobeRGB image file that does not support the DCF 2.0 will be printed in vague colors without color corrections.</p> <p>What is an AdobeRGB? An AdobeRGB is a color space that the Adobe Systems Incorporated employs and uses as the default setting for image processing software including the Adobe Photoshop. The AdobeRGB, an optional color space extended with the DCF 2.0, determines the color ranges widely used in printing industry. For whether or not a digital camera supports the AdobeRGB, see the operating instructions of the digital camera.</p>

Symptom	Check	Cause/Solutions
The picture quality and colors of the image previewed on the screen differs from those printed.		<p>→ Because of differences in the phosphor method or profiles of a LCD screen, please regard the image being displayed on the display as just a reference. To adjust picture quality, do either of the following:</p> <ul style="list-style-type: none"> - Menu - Set Up - Color Setting (→ page 43) - Menu-Edit-Adjust (→ page 28)
The printed image differs when an image is directly printed from the memory card or an external device inserted into the printer's slot and when it is printed via a PC.		<p>→ Because of the differences in the printer's internal processing and PC software processing, the printed images will be different.</p>
The date cannot be printed.	• Is "Date Print" set to "On"?	→ Set "Date Print" in the Set Up menu to "On". (→ page 43)
	• Does the image support DCF?	→ The "Date Print" function of this unit supports an image that is compatible with the DCF standards.
The date is printed unintentionally.	• Is "Date Print" set to "Off"?	→ Set "Date Print" in the Set Up menu to "On". (→ page 43)
	• Was the date saved with the image when it was shot with the digital camera?	→ Change the camera settings.

Symptom	Check	Cause/Solutions
The image cannot be printed fully in the print range.	<ul style="list-style-type: none"> • Did you set "Borders" in the Set Up menu to "Yes"? 	<p>→ Set "Borders" to "No" by selecting Menu - Set Up - Borders. (→ page 42)</p>
	<ul style="list-style-type: none"> • Is the aspect ratio of the image correct? 	<p>→ Depending on the type of digital camera used, the aspect ratio of the recorded image differs, so the image may not be printed covering the entire printable area.</p>
Even if "Borders" is set to "No", the image is printed with borders on both sides.	<ul style="list-style-type: none"> • Is the image edited and saved with "Borders" set to "Yes"? 	<p>→ When you edit and save an image in the postcard size, it is saved as a print image including the blank areas. Even if you print it with "Borders" set to "No", you cannot eliminate the borders on both sides of a print. To print without borders, edit and save an image with "Borders" set to "No". (→ page 42)</p>
Only part of an image is printed.	<ul style="list-style-type: none"> • Did you set "Borders" in the Set Up menu to "Yes"? 	<p>→ Set "Borders" to "Yes" to print the whole area of an image. (→ page 42)</p>
The image is stretched horizontally when printed.	<ul style="list-style-type: none"> • Did you rotate the image or add other process? 	<p>→ Depending on the type of digital camera used, the image may be stretched vertically if it has been rotated or processed using your digital camera. This is not because of trouble with the printer, but because the image was rewritten with your digital camera.</p>
The image is printed at an angle.	<ul style="list-style-type: none"> • Is the paper tray inserted properly? 	<p>→ Re-insert the paper tray firmly straight in to the end.</p>
There are white lines or dots on the printed pictures.		<p>→ The print head or paper path may be soiled. Use the supplied cleaning cartridge to clean the head and path. (→ page 80)</p>

Symptom	Check	Cause/Solutions
The picture is too bright, dark, reddish, yellowish, or greenish.		→ Adjust an image by selecting Menu - Edit - Adjust. (→ page 28)
The eyes of the subject are red.		→ Adjust for the red-eye phenomenon by selecting Menu - Edit - Red-eye reduction. (→ page 29)
Red-eye reduction does not take effect.		→ Set the size of the adjustment frame to be two to seven times as large as the eye. (→ page 29)
	<ul style="list-style-type: none"> • Did you enlarge, reduce the size of, rotate, or move an image after the red-eye reduction? 	→ Red-eye reduction may not work properly if other editorial operations such as enlarging, reducing the size of, rotating, or moving an image. Perform these editorial operations first and then perform red-eye reduction.

Settings

Symptom	Check	Cause/Solutions
The "Borders" "Yes/No" setting does not take effect.	<ul style="list-style-type: none"> • Are you operating the Creative Print menu? 	→ In the Creative Print menu, templates are used and you cannot select border/borderless prints.

Saving or deleting an image

Symptom	Check	Cause/Solutions
You cannot save an image.	• Is the memory card or an external device protected?	→ Release the protection and try saving again.
	• Is the write-protect switch of the memory card in the LOCK position?	→ Slide the write-protect switch to the write enable position. (→ page 85)
	• Is the memory card full?	→ Delete unnecessary images (→ page 39), or replace it with a new memory card with sufficient free memory space. Save the image again.
You cannot delete an image.	• Is the memory card or an external device protected?	→ Release the protection and try printing again.
	• Is the image DPOF-preset?	→ Release the DPOF preset with your digital camera.
	• Is the write-protect switch of the memory card in the LOCK position?	→ Slide the write-protect switch to the write enable position. (→ page 85)
	• Are you using a "Memory Stick-ROM"?	→ You cannot delete an image from or format a "Memory Stick-ROM".
An image was deleted accidentally.		→ You cannot recover an image once it is deleted.
The "Memory Stick" cannot be formatted.	• Is the write-protect switch of the memory card is in the LOCK position?	→ Slide the write-protect switch to the write enable position. (→ page 85)
	• Is it a "Memory Stick-ROM"?	→ You cannot delete an image from or format a "Memory Stick-ROM".
The "Memory Stick" was formatted accidentally.		→ Once the "Memory Stick" is formatted, all the data is deleted and cannot be recovered. To prevent accidental format, set the write - protect switch to the LOCK position. (→ page 85)

Others

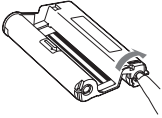
Symptom	Check	Cause/Solutions
You cannot insert the print cartridge smoothly.		<p>→ If the print cartridge does not click into place, remove it and then re-insert it. Only when the ink ribbon is too slack to be loaded, wind the ink ribbon in the direction of the arrow to remove the slack. (→ page 13)</p> 
The print cartridge cannot be removed.		<p>→ Turn off the ⏻ (on/standby) switch and then turn it on. After the motor sound stops, try to remove the cartridge. If this does not solve the problem, contact Sony service facilities or your Sony dealer.</p>
The print paper jams.	<ul style="list-style-type: none"> • Is an error message displayed ? 	<p>→ Paper is jammed. See “If paper jams” (→ page 80) and remove jammed paper from the printer. If jammed paper cannot be removed, contact the Sony service facilities.</p>
Printing stops midway.	<ul style="list-style-type: none"> • Does the access indicator flash in orange? 	<p>→ The data size of an image is large and it takes longer to process it for printing. As soon as the data processing finishes, the printer starts printing.</p>
	<ul style="list-style-type: none"> • Is an error message displayed? 	<p>→ Paper is jammed. See “If paper jams” (→ page 80) and remove jammed paper from the printer. If jammed paper cannot be removed, contact the Sony service facilities.</p>
	<ul style="list-style-type: none"> • Is any indicator lit? 	<p>→ If no indicator is lit, the thermal head may be overheated. Leave the printer until the head cools down and the printer resumes printing.</p>

Connecting with a digital camera

Symptom	Check	Cause/Solutions
The PictBridge mark does not appear on the LCD screen of the digital camera.	• Is the digital camera connected correctly?	→ Connect the cable correctly.
	• Is the ⏻ (on/standby) switch turned on?	→ Turn on the ⏻ (on/standby) switch
	• Does your digital camera support PictBridge?	→ Refer to the operating instructions supplied with the digital camera you are using or consult the digital camera manufacturer.
	• Is "The printer is being connected to a PictBridge camera." displayed?	→ The message is not displayed while the printer is in the Edit, Creative Print, or other menu modes. Exit the menu and then connect the cable again. → Disconnect the digital camera and the printer and then connect them again. Or turn off and then on the printer and the digital camera.
	• Is the USB setting of your camera in PictBridge mode?	→ Set the USB setting of your camera to the PictBridge mode.
	• Is printing in process?	→ Connect the cable again after printing is complete.
You connect and disconnect the USB cable, but nothing happens.		→ The printer has developed an over-current error. Unplug the AC power cord of the printer, plug it in again, and then press the ⏻ (on/standby) switch to recover from the error.
You cannot stop printing even if you pressed CANCEL.		→ The next print from the one currently printed will be canceled. → Depending on the digital camera you use, you cannot cancel printing from the printer. Operate the digital camera to stop printing. Refer to the operating instructions of the digital camera.
You cannot make Index printing.	• Is the message "There were images for which printing data could not be created." displayed?	→ The printer cannot print Index print of the DPOF printing. To make Index printing, insert the memory card directly (➡ page 17) or use a mass storage external device (➡ page 18).

Connecting with a computer

Symptom	Check	Cause/Solutions
The images of the memory card or an external device inserted in the printer are not displayed on the PC.		→ The printer does not provide the function for viewing the memory card or an external device images from the printer.
You lost the supplied CD-ROM and want to obtain a new one.		→ Please download the printer driver from the Customer support home page (→ page 88). Or contact your Sony dealer.
The printer driver cannot be installed.	• Are you sure that you have followed the installation procedures correctly?	→ Follow the procedures in the operating instructions to install the driver (→ page 48). If an error occurs, restart your computer and do the installation procedures again.
	• Is another application program running?	→ Exit all applications and then install the driver again.
	• Did you specify the CD-ROM as the installation CD-ROM correctly?	→ Double-click My Computer, and then the CD-ROM icon in the open window. Follow the procedures in the operating instructions to install the driver.
	• Is the USB driver installed?	→ The USB driver may not be installed properly. Follow the operating instructions to install the USB driver again.
	• Can you read the CD-ROM with Explorer?	→ If there is an error with the CD-ROM, you may not be able to read it. If an error message is displayed on your PC, check the contents and remove the source of the problem. Then install the printer driver again. For details on the error contents, see the operating instructions of your PC.

Symptom	Check	Cause/Solutions
The printer driver cannot be installed.	<ul style="list-style-type: none"> • Is there an anti-virus program or other program running on the system? 	<p>→ If there is an anti-virus program or other program running on the system, exit it and then start installing the driver.</p>
	<ul style="list-style-type: none"> • Did you log onto Windows XP/2000 Professional using an Administrator user account? 	<p>→ To install the driver in Windows XP/2000 Professional, log onto Windows using an Administrator user account.</p>
The printer does not respond to the printing order from the PC.	/	<p>→ If there is no trouble displayed on the Windows desktop, check the printer's LCD screen. If the printer shows trouble, do the following:</p> <ol style="list-style-type: none"> 1. Turn off the ⏻ (on/standby) switch then turn it on again. 2. Disconnect the power cable, wait for 5 to 10 seconds, and then connect the cable again. 3. Restart your computer. <p>If these do not solve the problem, consult with your Sony dealer or service facilities.</p>
	<ul style="list-style-type: none"> • Is an error message displayed stating that an error was detected in output of documents via USB? 	<p>→ Remove the USB cable and then connect it again.</p>
An image is printed with borders even if I set "Borders" to "No".	<ul style="list-style-type: none"> • Are you using an application software other than Picture Motion Browser? 	<p>→ When using an application other than the Picture Motion Browser, an image might be printed with borders even if you select borderless print. If this occurs, do either of the following to print an image without borders:</p> <ul style="list-style-type: none"> – When you can set print range with an application, set an image to be printed fully in the print range even if it is printed over the range. – Set a larger value in the "Enlarge/Reduce" text box in the "Paper/Output" tab of the "Sony DPP-FP55 Properties" dialog box. (→ page 56)

Symptom	Check	Cause/Solutions
Colors are not reproduced correctly.	• Is "Exif Print" checked in the "Graphics" tab of the "Sony DPP-FP55 Properties" dialog box?	→ The Exif Print setting in the "Color reproduction/Picture quality" section supports the Picture Motion Browser only. To print from other application, uncheck "Exif Print".
	• Is "ICM" selected in the "Graphics" tab of the "Sony DPP-FP55 Properties" dialog box?	→ The ICM setting may be valid only when you are using an ICM-compliant application. Check to see if the application software you are using supports ICM.
Preview image does not reflect the print settings in the "Graphics" tab of the "Sony DPP-FP55 Properties" dialog box.		→ The print settings adjusts the printer itself and cannot influence the preview image.
Print quantity specified in the "Paper/Output" tab of the "Sony DPP-FP55 Properties" dialog box does not take effect.		→ Depending on the application you use, the print quantity setting of the application you use may have priority over the setting specified in the printer driver dialog box.

If an error message appears

If an error occurs, the following error messages may be displayed on the LCD screen. Follow the solution described here to solve the problem.

Printer

Error messages	Meaning/Solutions
Errors occurred with printer. Turn it off and on, then retry.	→ An error has occurred with the printer. Unplug the AC power cord of the printer, connect it again and then try operating again. If this occurs again, consult with your Sony dealer or Sony service facilities.

Storage media

Error messages	Meaning/Solutions
No Memory Stick./No SD Card./No External Device.	→ The “Memory Stick”, SD card is not inserted into their slot. Or the external device is not connected. Insert the memory card or an external device. (→ pages 17, 18)
The Memory Stick is protected.	→ A protected “Memory Stick” is inserted. To save or edit the images with the printer, cancel protection of the “Memory Stick”.
An incompatible Memory Stick/SD Card/External Device is inserted.	→ A “Memory Stick”, SD card, or an external device that the printer does not support are inserted. Use a compatible media. (→ pages 83 to 86)
No image file.	→ There are no image files in the memory card or an external device that the printer can handle. Connect a media that contains images that can be displayed with the printer.
No DPOF file.	→ There are no DPOF-preset image files in the memory card or an external device. Specify the print (DPOF) mark with your camera.
Cannot delete a protected image.	→ To delete a protected image, cancel protection on your camera.
You cannot delete a DPOF image.	→ To delete a DPOF-preset image, cancel the print (DPOF) mark on your camera.

Error messages	Meaning/Solutions
Protected. Cancel protect then try again.	→ The "Memory Stick" is write-protected. Release the write-protection. (→ page 85)
The Memory Stick/SD Card is full.	→ There is no free memory space in the selected media. Delete unnecessary images or replace with a one having sufficient memory space.
The Memory Stick/SD card/ External Device has trouble.	→ An error may have occurred. If these messages appear frequently, check the memory card or an external device status with another device.
Write error in Memory Stick/SD card.	
Memory Stick Format Error	

Print cartridge

Error messages	Meaning/Solutions
No print cartridge. Set a new print cartridge and press [PRINT].	→ The print cartridge is not inserted in the printer. Set the print cartridge into the printer. (→ page 12) If "cleaning cartridge" is displayed, set the cleaning cartridge. (→ page 80)
No print cartridge. Set the print cartridge for the P Size and press [PRINT].	
Print cartridge is empty.	→ Replace it with a new print cartridge. (→ page 12)
Print cartridge is empty. Set a new print cartridge for the P Size and press [PRINT].	
Wrong print cartridge. Set the print cartridge for the P Size and press [PRINT].	→ Set a print cartridge and print paper of the displayed size. (→ pages 12 to 15)

Print paper

Error messages	Meaning/Solutions
<p>No paper tray. Set the print paper for the P Size and press [PRINT].</p> <p>No print paper. Set the print paper for the P Size and press [PRINT].</p>	<p>→ There is no print paper in the printer.</p> <ul style="list-style-type: none"> – The paper tray is not set in the printer. – The print paper is not set in the paper tray. – The print paper has run out. <p>In either case, set the print paper in the tray and set the paper tray into the printer. (→ pages 13 to 15)</p>
<p>Cleaning sheet is not placed. Set the cleaning sheet and press [PRINT].</p>	<p>→ There is no cleaning sheet (protective sheet) in the paper tray. Insert the protective sheet into the paper tray and set the paper tray into the printer. (→ page 80)</p>
<p>Wrong print paper. Set the print paper for the P Size and press [PRINT].</p>	<p>→ The print paper and print cartridge do not match. Check the print cartridge size actually loaded in the printer and set the print paper for the identical size. (→ page 14)</p>
<p>Paper jam. Remove Print Paper.</p>	<p>→ Paper jams. See “If paper jams” (→ page 80) and remove jammed paper from the printer. If the jammed paper cannot be removed, contact the Sony service facilities.</p>

If paper jams

If the print paper jams, an error message is displayed and printing stops.

Unplug the AC power cord of the printer and remove the jammed paper from the paper outlet or take out the paper tray to remove the jammed paper.

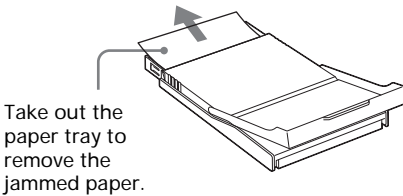
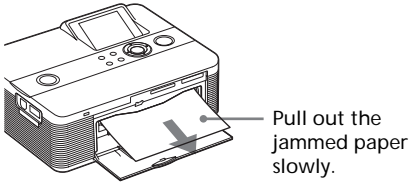

Note

If you cannot remove the jammed paper, contact your Sony dealer.

Cleaning the inside of the printer

If white lines or periodical dots are printed on the pictures, use the cleaning cartridge supplied and the protective sheet of the supplied printing pack to clean inside the printer.

Tip

You can also use the protective sheet supplied in the optional printing pack.

- 1** Open the cartridge compartment door and if there is a print cartridge, remove it (page 12).
- 2** Insert the supplied cleaning cartridge into the printer and close the cartridge compartment door.

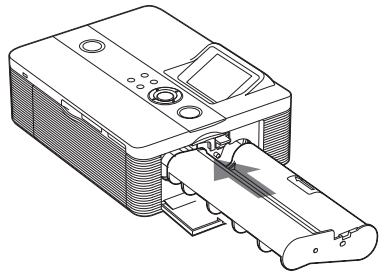

- 3** Remove the paper tray from the printer. If there is print paper in the tray, remove the print paper from the tray.

- 4** Place the protective sheet into the paper tray **with the no-imprint side facing up**.

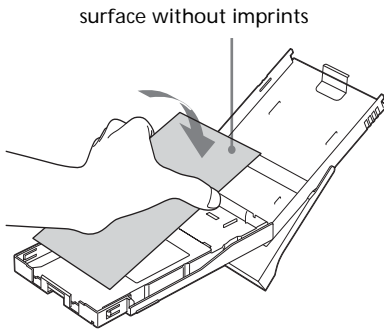

If the protective sheet sticks to the ink ribbon, that may cause damage to the printer. Check the following before you start cleaning.

- The protective sheet has been inserted with the no-imprint side facing up.
- The protective sheet you are using is the one designed for this printer.

- 5** Set the paper tray into the printer and press **PRINT**.
The cleaning cartridge and protective sheet will clean inside the printer.

During printing the **PRINT** indicator flashes.

After the cleaning is finished, the protective sheet is automatically ejected.

- 6** Remove the cleaning cartridge and protective sheet from the printer.

Tip

Keep the cleaning cartridge and protective sheet together for future cleaning.

When cleaning ends

Set the print cartridge and print paper into the printer.

Notes

- Carry out cleaning only when there are white lines or dots on the print.
- When you can obtain proper printing performances, cleaning will not improve the printed picture quality.
- The maximum cleaning times that you can carry out is approximately 20. As the number of cleaning times increases, the cleaning loses its effect.
- Do not place the protective sheet on the print paper and carry out cleaning, which may cause paper jam or other troubles.
- If a cleaning does not improve printed picture quality, please carry out cleaning a couple of times.
- You cannot clean the printer while it is connected to a PC or a PictBridge camera.

Precautions

On safety

- Be careful not to set or drop any heavy objects on the power cord, or to damage the power cord in any way. Never operate this printer with a damaged power cord.
- Should any solid object or liquid fall into the cabinet, unplug the printer and have it checked by qualified personnel before operating it any further.
- Never disassemble the printer.
- To disconnect the power cord, pull it out by the plug. Never pull the power cord itself.
- When the printer is not going to be used for an extended period of time, disconnect the power cord from the wall outlet.
- Do not handle the printer roughly.
- To reduce the risk of electrical shock, always unplug the printer from the electrical outlet before cleaning and servicing the printer.

On installation

- Avoid placing the printer in a location subject to:
 - vibration
 - high humidity
 - excessive dust
 - direct sunlight
 - extremely high or low temperatures
- Do not use electrical equipment near the printer. The printer will not work properly in electromagnetic fields.
- Do not place heavy objects on the printer.
- Leave enough room around the printer so that the ventilation holes are not blocked. Blocking these holes may cause internal heat build-up.

On the AC adaptor

- Be sure to use the AC adaptor supplied with the printer. Do not use other AC adaptors, as this may cause a malfunction.
- Do not use the supplied AC adaptor to other devices.
- Do not use an electrical transformer (travel converter), as this may cause overheating or a malfunction.
- In case the cord of the AC adaptor is damaged, never use it any longer, as this may cause danger.

On moisture condensation

If the printer is brought directly from a cold location to a warm location or placed in an extremely warm or humid room, moisture may condense inside the unit. In such cases the printer will probably not work properly and may even develop a fault if you persist in using it. If moisture condensation occurs, unplug the AC power cord of the printer and do not use the printer for at least one hour.

On transport

When you transport the printer, remove the print cartridge, paper tray, AC adaptor, the memory card, or an external device from the printer and put the printer and its peripherals in the original box with the protective packaging.

If you no longer have the original box and packing parts, use similar packing material so that the printer will not be damaged while being transported.

On cleaning

Clean the cabinet, panel and controls with a soft dry cloth, or a soft cloth lightly moistened with a mild detergent solution. Do not use any type of solvent, such as alcohol or benzene, which may damage the finish.

On restrictions on duplication

If duplicating documents with the printer, pay special attention to the following:

- Duplication of banknotes, coins, or securities is against the law.
- Duplication of blank certificates, licenses, passports, private securities, or unused postal stamps is also against the law.
- TV program, films, video tapes, others' portraits or other materials may be copyrighted. Unauthorized video printing of such materials may infringe the provisions of the copyright law.

About the Memory Cards

About the "Memory Stick"

What is "Memory Stick"?

"Memory Stick" is a compact-size IC recording medium with a large capacity. It has been designed not only for exchanging/sharing digital data among "Memory Stick" compliant products, but also for serving as an insertable/removable external storage medium that can save data.

Types of "Memory Stick"

"Memory Stick" is available in the following types to meet various functional requirements:

- "Memory Stick" (Not compatible with "MagicGate"): "Memory Stick" stores any type of data except copyright-protected data that requires the "MagicGate" copyright protection technology.
- "MagicGate Memory Stick" : Equipped with the "MagicGate" copyright protection technology.
- "Memory Stick" (Compatible with "MagicGate"): Equipped with the "MagicGate" copyright protection technology and compatible with high speed data transfer. This "Memory Stick" can be used with the "Memory Stick" compliant devices. (Data transfer speed depends on the "Memory Stick"-compatible device.)

Continued

- “Memory Stick PRO” : Equipped with the “MagicGate” copyright protection technology. The “Memory Stick PRO” can be used only with “Memory Stick PRO” compliant devices.
- “Memory Stick-ROM” : “Memory Stick-ROM” stores pre-recorded, read-only data. You cannot record on “Memory Stick-ROM” or erase pre-recorded data.

■ About “Memory Stick Duo” and “Memory Stick PRO Duo”

“Memory Stick Duo” is smaller than the standard-size “Memory Stick” media. By attaching a Duo adaptor, it can become the same size as the standard-size “Memory Stick” so it can also be used in products compatible with standard-size “Memory Stick” media.

■ About “Memory Stick Micro” (“M2”) media

“Memory Stick Micro” (“M2”) media is even smaller than the “Memory Stick Duo” media. The M2 media comes with an adaptor for the standard size and that for the “Memory Stick Duo” size. By attaching either of the adaptors, the “Memory Stick Micro” media can also be used in products compatible with standard-size “Memory Stick PRO” or “Memory Stick PRO Duo”.

Types of “Memory Stick” that the printer can use

With the printer, you can use the following types of “Memory Stick”⁴:

Function	Memory Stick media type		
	Media other than Memory Stick PRO ²		Memory Stick PRO ^{2*3}
	Memory Stick (Not compatible with MagicGate)	Memory Stick (MagicGate Compatible) MagicGate Memory Stick	
Displaying/Printing	OK	OK*1	OK*1
Deleting/Saving/Formatting	OK	OK*1	OK*1

*1 Data reading/recording that requires “MagicGate” copyright protection cannot be performed.

*2 The printer is equipped with a slot compatible with both standard-size and Duo-size media. Without a Memory Stick Duo adaptor, you can use both standard-size “Memory Stick” and compact-size “Memory Stick Duo”.

*3 When using the “Memory Stick Micro” with the printer, always insert it into an M2 adaptor. If you insert the “Memory Stick Micro” into the printer without an M2 adaptor, you may be unable to remove the “Memory Stick Micro”.

*4 The printer supports FAT32. The printer has been demonstrated as operable with a “Memory Stick” with a capacity of 4GB or smaller manufactured by Sony Corporation. However, we do not guarantee the operations of all the “Memory Stick” media.

What is “MagicGate”?

“MagicGate” is the general name of a copyright protection technology developed by Sony. This technology provides authentication and encryption; mutual confirmation is performed between the “Memory Stick” media and the “MagicGate” compliant device that the other can record and play the copyright-protected data correctly. When the authentication is established, the data encryption is performed.

When the data is played, the authentication is also performed. Only when authentication is established, the data is decrypted to the original status and played. Copyright-protected data cannot be played with a device other than authenticated ones.

The printer is not equipped with the “MagicGate” technology and cannot read or write the data subject to the “MagicGate” copyright protection.

Notes on use

- Do not insert multiple “Memory Stick” at the same time, which may cause trouble with the printer.
- When using a “Memory Stick”, make sure to check correct insertion direction. Wrong usage may cause trouble with the printer.
- Do not place the “Memory Stick Duo” or “Memory Stick Micro” within the reach of a small child to prevent him from swallowing it by accident.
- Avoid removing the “Memory Stick” from the printer while the printer is reading or writing data.
- Data may be damaged in such occasions:
 - “Memory Stick” is removed or the printer is turned off during a read or write operation.
 - “Memory Stick” is used in a location subject to static electricity or electrical noises.
- We recommend that you save backup of the important data.

- The data processed with the computer may not be played with the printer.
- When you format a “Memory Stick”, use the format function of the printer or your digital camera. If you format a “Memory Stick” with your computer, images may not be displayed properly.
- When you format a “Memory Stick”, all the data including the protected image files will be erased. To avoid erasing important data by accident, make sure to check the content before formatting.

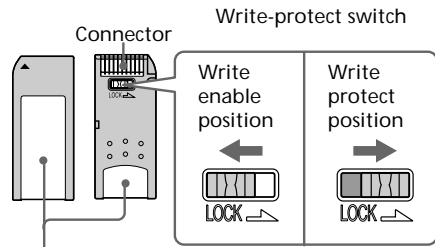

Place the label here.

- You cannot record, edit or delete data if you slide the write-protect switch to LOCK.
- When you use a “Memory Stick Duo” without the write-protect switch, be careful not to edit or delete the data by accident.
- When you slide the write-protect switch of the “Memory Stick Duo”, use a thin-pointed device.
- Do not attach any other material than the supplied label on the labeling position. When you attach the supplied label, be sure to attach it to the labeling position. Be careful that the label does not stick out.
- When you write on the memo area of the attached label, do not write forcefully.
- When you carry or store the “Memory Stick”, put it in the case supplied with it.
- Do not touch the terminal of the “Memory Stick” with your hand or a metal object.
- Do not strike, bend or drop the “Memory Stick”.
- Do not disassemble or modify the “Memory Stick”.
- Do not expose the “Memory Stick” to water.

Continued

- Do not use or store the “Memory Stick” under the following conditions:
 - Locations beyond the required operational conditions including locations such as the hot interior of a car parked in the sun or/ and in the summer, the outdoors exposed to direct sunlight, or a place near a heater.
 - Humid locations or locations with corrosive substances present
 - direct sunlight, or a place near a heater.
 - direct sunlight
 - high humidity or corrosive substances
 - static electricity or electrical noises
- When you carry or store a card, put it in the case supplied with it.
- Do not remove a card or turn off the printer while the printer is reading or writing data and the access indicator is flashing. Otherwise, data may be rendered unreadable or erased.

About the SD card

The SD card slot of the printer allows you to use an SD memory card^{*1} and MMC standard memory card^{*2}.

*1 The printer supports FAT32. The printer has been demonstrated as operable with an SD card with a capacity of 2 GB or smaller. To use a miniSD card, you need an adaptor.

*2 The printer has been demonstrated as operable with an MMC standard memory card with a capacity of 128 MB or smaller .

We do not guarantee proper operations for all types of SD cards/MMC standard memory cards.

Notes on use

- When using a card, make sure to check correct insertion direction of the card and correct insertion slot.
- You cannot read or write the data subject to the copyright protection. (SD card)
- Do not strike, drop, or bend a card.
- Do not disassemble or modify a card.
- Do not expose a card to water.
- Avoid using a card in areas subject to high humidity, since it may be easily affected by the humidity.
- Do not use or store a card in a location subject to:
 - extremely high temperature such as the hot inside of a car or the outdoors exposed to a

Specifications

■ Printer

Printing method

Dye sublimation printing (Yellow/
Magenta/Cyan 3 pass)

Resolution

300 (H) x 300 (V) dpi

(Equivalent to

3 color Ink-Jet 4800 dpi x 4800 dpi^{*1})

6 color Ink-Jet 3810 dpi x 3810 dpi^{*2})

Image processing per dot

256 levels (8 bits for each Yellow/
Magenta/Cyan), approx. 16 770 000
colors

Printing size

Post Card (4 x 6 inch) size:

101.6 x 152.4 mm (maximum,
borderless)

Printing time (per sheet)^{*3}

Memory card^{*4}: Approx. 63 seconds

PictBridge mode^{*5}: Approx. 71 seconds

PC mode^{*6}: Approx. 60 seconds

Input/Output connectors

USB for PC connection USB 1.1
(Type B)

Highspeed is not supported.

PictBridge connector

Slot

“Memory Stick” insertion slot

SD Card insertion slot

Compatible image file formats

JPEG: DCF 2.0 compatible, Exif 2.21
compatible, JFIF^{*7}

TIFF: Exif 2.21 compatible

BMP^{*8}: 24bit Windows format

Some image file formats are not
compatible.

Maximum number of pixels to be handled

6 400(H) x 4 800(V) dots

(Excluding Index Print and part of
Creative Print)

Maximum number of files to be handled

9 999 files for a memory card/an
external device

Print cartridge/Print Paper

See “Preparing the print pack” on
page 11.

LCD panel

5.0 cm (2.0 type) TFT drive

Total number of dots:

86636 (358 x 242) dots

Power requirements

DC IN jack, DC 24V

Power consumption

While printing: 75 W (maximum)

On standby mode: less than 1W

Operating temperature

5 °C to 35 °C (41 °F to 95 °F)

Dimensions

Approx. 175 x 60 x 137 mm

(7 x 2 ³/₈ x 5 ¹/₂ inches)

(w/h/d, excluding protruding parts)

(306 mm (12 ¹/₈ inches) of depth when
the paper tray is installed.)

Mass

Approx. 1.1 kg (2 lb 7 oz)

(excluding the paper tray, print
cartridge, AC power adaptor)

Supplied accessories

See “Checking the contents of the
package” on page 10.

Continued

■ AC power adaptor AC-S2425

Power requirements

AC 100 to 240 V, 50/60 Hz, 1.5 to 0.75 A

Rated output voltage

DC 24 V, 2.2 A

Operating temperature

5 °C to 35 °C (41 °F to 95 °F)

Dimensions

Approx. 60 x 30.5 x 122 mm

(2 ³/₈ x 1 ¹/₄ x 4 ⁷/₈ inches)

(w/h/d, excluding protruding parts)

Mass

Approx. 305 g (11 oz)

Design and specifications are subject to change without notice.

- *1: When the 16 x 16 matrix is used: 300 x 16 = 4,800 dpi
- *2: When the 12.7 x 12.7 matrix is used: 300 x 12.7 = 3,810 dpi
- *3: When photo of 3.11MB file size containing effective picture elements of 7,200,000 is taken by DSC-T30 (7Mega Cyber-shot)
- *4: Time from when the PRINT button is pressed to when printing is finished while printing from a "Memory Stick PRO Duo" inserted in the printer 's slot (The printing time may vary depending on a used equipment, a format of an image, a used memory card, settings of an application and operating conditions.)
- *5: Time from when the print button on the display window of the camera is pressed to when printing is finished via DSC-T30 connected by USB cable
- *6: The time for data processing and transferring is excluded.
- *7: Baseline JPEG with 4:4:4, 4:2:2, or 4:2:0 format
- *8: You cannot print using the Picture Motion Browser.

Customer support home page

The latest support information is available at the following home page address:

<http://www.sony.net/>

Printing range

Postcard size

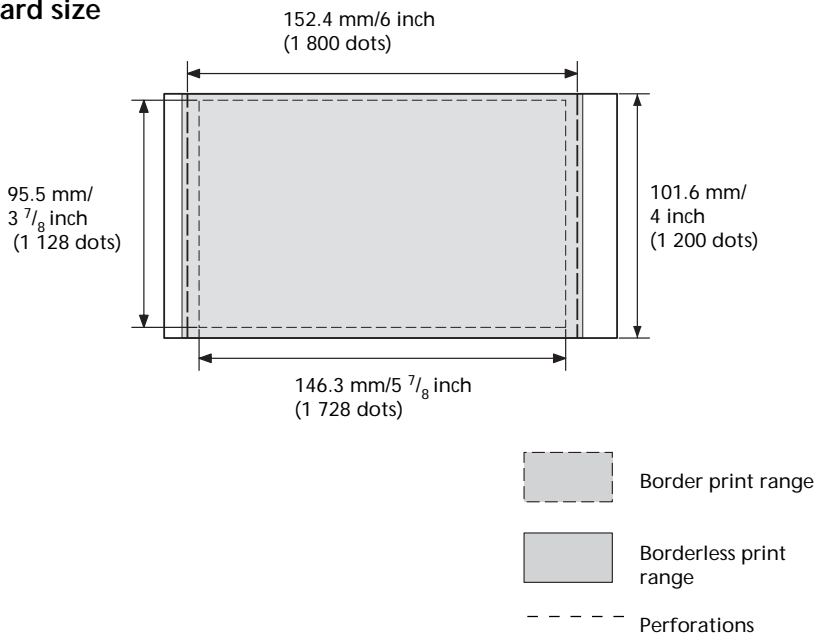

The above illustrations are those when an image with a 2:3 aspect ratio is printed. The printing range differs for a border or a borderless print.

Glossary

Auto Fine Print 3

The function automatically corrects the picture quality so that an image may be printed in more vivid, clear and beautiful pictures. It is especially effective for a darker image with low contrast. The pictures are corrected to reproduce natural skin colors, vivid tree leaf green, or clear sky blue.

DCF (Design rule for Camera File system)

This camera conforms with the DCF (Design rule for Camera File system) standard established by JEITA (Japan Electronics and Information Technology Industries Association) to maintain file exchangeability and compatibility between digital cameras and related products. Complete exchangeability and compatibility, however, are not guaranteed.

DPOF (Digital Print Order Format)

The format used to record the information necessary for automatically printing images shot by a digital camera at a printing shop or with a home-use printer. The printer supports DPOF printing and can automatically print the preset number of copies of the DPOF preset images.

Exif 2.21 (Exif Print)

Exif (Exchangeable image file format for digital cameras) Print is a global standard for digital photo printing. A digital camera supporting Exif Print stores the data relevant to the conditions of shooting as each shot is taken. The printer utilises the Exif Print data stored in each image file to ensure the printed result matches the original shot as closely as possible^{*1}.

*1 When the "Auto Fine Print 3" is enabled and an image (JPEG file) is shot by an Exif Print (Exif 2.21)-compliant digital camera, the image is automatically adjusted to its optimum picture quality and printed.

Mass Storage System

Various types devices for storing large amounts of data, including all types of disk drives (floppy disks, hard disks, optical disks) or tape media. Unlike flash memory, mass storage devices retain data even when the PC or unit is turned off.

"Memory Stick"/SD card

Compact, light, removable storage media. For details see pages 83 to 86.

PictBridge

A standard specified by Camera & Imaging Products Association that allows you to connect PictBridge-complaint digital camera directly to the printer without a PC, enabling direct printing on the spot.

Thumbnails

Miniature images for representing the original images that are stored in the image files taken by a digital camera. The printer uses thumbnails in the image list.

Index

A

- AC adaptor 16
- Access indicator 17, 18
- Adjusting an image 28
- All printing 35
- Auto Fine Print 3 42

B

- Borders/borderless print 42

C

- Calendar 34
- Changing the display 24
- Cleaning 80
- Color Setting 43
- Connecting the AC power source 16
- Creative Print 31

D

- Date Display Order 45
- Date print 43
- DC IN 24V 16
- Deleting an image 39
- Demonstration mode 45
- DPOF 35

E

- Easy printing 35
- Edit menu 26
- Enlarging and reducing an image size 27
- Exif Print 42
- External device 18

F

- Filter 28
- Fish-eye effect 29
- Format 40

I

- Icon 45
- Image Data Display 24, 45
- Image list 25
- Index printing 35
- Input indications 24
- Inserting
 - Memory card 17
 - Print cartridge 12
 - Print paper 13
- Installing
 - Picture Motion Browser 51
 - Printer driver 48

L

- Language 45
- LCD backlight 45
- LCD screen 24
- Listing Order 45

M

- Memory Stick
 - Format 40
 - Inserting 17
 - Notes on use 85
 - Types 83
- Moving an image 27

O

- On/standby indicator 16, 20, 22, 46, 49
- On/standby switch 20, 22, 46, 49
- Option 44
- Overview 6

P

- Paper jams 80
- Paper tray 13
- Paper tray lid 13
- PictBridge camera 46
- PictBridge connector 19, 46
- Picture Motion Browser 47
- Precautions 82
- Preview 24
- PRINT 21
- Print cartridge 12
- Print pack 11
- Print paper 11, 14
- Print quantity 21, 23, 30
- Printing
 - Edited/Creative Print image 30
 - From a PC 47
 - From a PictBridge camera 46
 - From memory card/external device 20
 - Multiple copies 21
 - Multiple images 22
 - Printing range 89

R

- Red-eye phenomenon 29
- Rotating an image 27

S

- Saving an image 30
- Saving/printing an edited image 30
- SD Card
 - Inserting 18
 - Types 86
- Searching for an image 38
- Selecting an input signal 20
- Sepia 29
- Set Up 41
- Slideshow 37
- Special filter 28
- Specifications 87
- Split images 32
- Supplied accessories 10
- System requirement 47

T

- Troubleshooting 62

U

- USB connector 49

W

- Write-protect switch 85

Z

- Zoom in/out 24



Printed using VOC (Volatile Organic Compound)-free vegetable oil based ink.

Free Manuals Download Website

<http://myh66.com>

<http://usermanuals.us>

<http://www.somanuals.com>

<http://www.4manuals.cc>

<http://www.manual-lib.com>

<http://www.404manual.com>

<http://www.luxmanual.com>

<http://aubethermostatmanual.com>

Golf course search by state

<http://golfingnear.com>

Email search by domain

<http://emailbydomain.com>

Auto manuals search

<http://auto.somanuals.com>

TV manuals search

<http://tv.somanuals.com>