

# Digital Photo Printer

## DPP-FP65/FP75

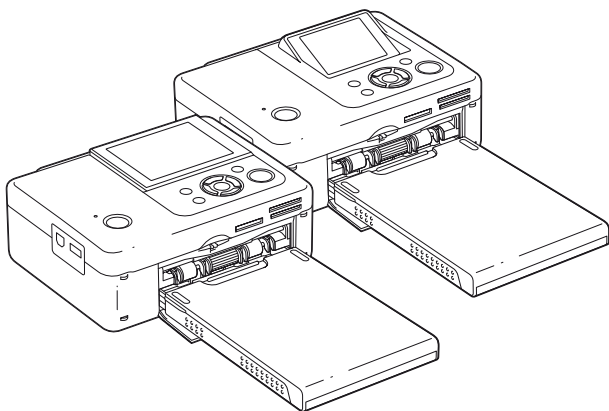

### Operating Instructions

Before operating this unit, please read “Read This First” and “About the Print Packs” supplied and this manual, “Operating Instructions”, thoroughly and retain them for future reference.

#### Owner’s Record

The model and serial numbers are located on the bottom. Record the serial number in the space provided below. Refer to these numbers whenever you call upon your Sony dealer regarding this product.

Model No. DPP-FP65/FP75

Serial No. \_\_\_\_\_

Before you begin

Preparations

Direct printing

Printing from a PictBridge camera

Printing from a Bluetooth-compliant device

Printing from a PC

Error messages

Troubleshooting

Additional information



# WARNING

**To reduce fire or shock hazard, do not expose the unit to rain or moisture.**

**For the Customers in the U.S.A. who purchased the DPP-FP75**

## CAUTION

You are cautioned that any changes or modifications not expressly approved in this manual could void your authority to operate this equipment.

*If you have any questions about this product, you may call:*

*Sony Customer Information Services Center  
1-800-222-SONY (7669)*

The number below is for the FCC related matters only.

## Regulatory Information

### Declaration of Conformity

Trade Name: SONY  
Model No.: DPP-FP75  
Responsible Party: Sony Electronics Inc.  
Address: 16530 Via Esprillo, San Diego,  
CA 92127 U.S.A.  
Telephone No.: 858-942-2230  
This device complies with part 15 of the FCC Rules. Operation is subject to the following two conditions:  
(1) this device may not cause harmful interference, and (2) this device must accept any interference received, including interference that may cause undesired operation.

## Note:

This equipment has been tested and found to comply with the limits for a Class B digital device, pursuant to Part 15 of the FCC Rules.

These limits are designed to provide reasonable protection against harmful interference in a residential installation. This equipment generates, uses, and can radiate radio frequency energy and, if not installed and used in accordance with the instructions, may cause harmful interference to radio communications. However, there is no guarantee that interference will not occur in a particular installation. If this equipment does cause harmful interference to radio or television reception, which can be determined by turning the equipment off and on, the

user is encouraged to try to correct the interference by one or more of the following measures:

- Reorient or relocate the receiving antenna.
- Increase the separation between the equipment and receiver.
- Connect the equipment into an outlet on a circuit different from that to which the receiver is connected.
- Consult the dealer or an experienced radio/TV technician for help.

## For Customers in Europe

This product has been tested and found compliant with the limits set out in the EMC Directive for using connection cables shorter than 3 meters (9.8 feet).

## Attention

The electromagnetic fields at the specific frequencies may influence the picture of this digital photo printer.

## Notice

If static electricity or electromagnetism causes data transfer to discontinue midway (fail), restart the application or disconnect and connect the communication cable (USB, etc) again.

## Notice for the customers in the countries applying EU Directives

The manufacturer of this product is Sony Corporation, 1-7-1 Konan Minato-ku Tokyo, 108-0075 Japan.

Than Authorized Representative for EMC and product safety is Sony Deutschland GmbH, Hedelfinger Strasse 61, 70327 Stuttgart, Germany.

For any service or guarantee matters, please refer to the addresses given in separate service or guarantee documents.



## Disposal of Old Electrical & Electronic Equipment (Applicable in the European Union and other European countries with separate collection systems)



This symbol on the product or on its packaging indicates that this product shall not be treated as household waste. Instead it shall be handed over to the applicable collection point for the recycling of electrical and electronic equipment. By ensuring this product is disposed of correctly, you will help prevent potential

negative consequences for the environment and human health, which could otherwise be caused by inappropriate waste handling of this product. The recycling of materials will help to conserve natural resources. For more detailed information about recycling of this product, please contact your local Civic Office, your household waste disposal service or the shop where you purchased the product.

## NOTICE FOR CUSTOMERS IN THE UNITED KINGDOM

A moulded plug complying with BS 1363 is fitted to this equipment for your safety and convenience. Should the fuse in the plug supplied need to be replaced, a fuse of the same rating as the supplied one and approved by ASTA or BSI to BS 1362, (i.e. marked with  or  mark) must be used. If the plug supplied with this equipment has a detachable fuse cover, be sure to attach the fuse cover after you change the fuse. Never use the plug without the fuse cover. If you should lose the fuse cover, please contact your nearest Sony service station.

Duplication, edition, or printing of a CD, TV program, copyrighted materials such as pictures or publications, or any other materials except for your own recording or creation is limited to private or domestic use only. Unless you hold copyright or have permission from copyright holders for the materials to be duplicated, use of those materials beyond this limit may infringe the provisions of the copyright law and be subject to the copyright holder's claim for damages.

When using photo images with this printer, pay special attention not to infringe the provisions of the copyright law. Any unauthorized use or modification of portraits may also infringe their rights.

For some demonstrations, performances, or exhibits, photography may be forbidden.

## Backup recommendations

To avoid potential risk of data loss caused by accidental operation or malfunction of the printer, we recommend that you save a backup copy of your data.

## Information



IN NO EVENT SHALL SELLER BE LIABLE FOR ANY DIRECT, INCIDENTAL OR CONSEQUENTIAL DAMAGES OF ANY NATURE, OR LOSSES OR EXPENSES RESULTING FROM ANY DEFECTIVE PRODUCT OR THE USE OF ANY PRODUCT.

Sony shall assume no responsibility for any accidental or consequential damages or loss of the recorded content which may be caused by use or malfunction of the printer or memory card.

## Notes on LCD screen

- The displayed image on the screen is not identical in picture quality and colors with the printed image because display methods or profiles differ. Please regard the displayed image as just a reference.
- Do not press against the LCD screen. The screen may be discolored and that may cause a malfunction.
- Exposing the LCD screen to direct sunlight for long periods may cause malfunctions.
- The LCD screen is manufactured using extremely high-precision technology, so over 99.99% of the pixels are operational for effective use. However, there may be some tiny black points and/or bright points (white, red, blue or green in color) that constantly appear on the LCD screen. These points are normal in the manufacturing process and do not affect the printing in any way.
- Images may trail across the LCD screen in a cold location. This is not a malfunction.

## On trademarks and copyrights

- Cyber-shot,  , “Memory Stick”, **MEMORY STICK** , “Memory Stick Duo”, **MEMORY STICK DUO** , “MagicGate Memory Stick”, “Memory Stick PRO”, **MEMORY STICK PRO** , “Memory Stick PRO Duo”, **MEMORY STICK PRO DUO** , “Memory Stick PRO-HG Duo”, **MEMORY STICK PRO-HG DUO** , “Memory Stick Micro”, **MEMORY STICK MICRO** , **M2** , “Memory Stick-ROM”, **MEMORY STICK-ROM** , “MagicGate”, and **MAGIC GATE** are trademarks of Sony Corporation.
- Microsoft, Windows, Windows Vista and DirectX are either registered trademarks or trademarks of Microsoft Corporation in the United States and/or other countries.
- Intel and Pentium are the registered trademarks or trademarks of Intel Corporation.
-  or xD-Picture Card™ is a trademark of Fuji Photo Film Co., Ltd.



- **FotoNation** is a trademark of FotoNation Inc. in the U.S.A.
- All other companies and product names mentioned herein may be the trademarks or registered trademarks of their respective companies. Furthermore, “™” and “®” are not mentioned in each case in this manual.
- The Bluetooth word mark and logos are owned by the Bluetooth SIG, Inc. and any use of such marks by Sony Corporation is under license. Other trademarks and trade names are those of their respective owners.

## Notice for users

Program © 2008 Sony Corporation  
Documentation © 2008 Sony Corporation

All rights reserved. This manual or the software described herein, in whole or in part, may not be reproduced, translated or reduced to any machine readable form without prior written approval from Sony Corporation.

IN NO EVENT SHALL SONY CORPORATION BE LIABLE FOR ANY INCIDENTAL, CONSEQUENTIAL OR SPECIAL DAMAGES, WHETHER BASED ON TORT, CONTACT, OR OTHERWISE, ARISING OUT OF OR IN CONNECTION WITH THIS MANUAL, THE SOFTWARE OR OTHER INFORMATION CONTAINED HEREIN OR THE USE THEREOF.

By breaking the seal of the envelope of the CD-ROM package, you accept all the terms and conditions of this agreement. If you do not accept these terms and conditions, please return this disk envelope unopened, along with the rest of the package, immediately to the dealer where you obtained it.

Sony Corporation reserves the right to make any modification to this manual or the information contained herein at any time without notice. The software described herein may also be governed by the terms of a separate user license agreement.

Any design data such as sample pictures provided in this software cannot be modified or duplicated except for the purpose of personal use. Any unauthorized duplication of this software is prohibited under copyright law.

Please note that unauthorized duplication or modification of portraits or copyrighted work could infringe the rights reserved by rights holders.

You may be referred to the supplied “Read This First” and “About the Print Packs” when there are detailed explanations in the leaflet.

### On the illustrations and screen shots used in this manual

The illustrations and screen shots used in this manual are of the DPP-FP75 unless noted otherwise.

---

# Table of Contents

Notice for users .....4

---

## Before you begin

Identifying the parts .....7

---

## Preparations

Checking the contents of the package .....9  
Setting the ink ribbon .....9  
Inserting the print paper .....10  
Connecting to the AC power source .....12

---

## Direct printing

LCD screen display .....13  
    An image preview .....13  
    Image list .....14  
    List of icons .....15  
Basic printing .....16  
    Inserting a memory card .....16  
    Printing selected images .....16  
Enjoying various printing .....18  
Red-eye Correction .....20

Editing an image .....21  
    Enlarging and reducing an image size .....21  
    Moving an image .....21  
    Rotating an image .....21  
    Adjusting an image .....21  
    Printing an edited image .....22  
    Undoing the operations .....22  
    Exiting the menu .....23  
Making layout prints .....23  
Making an ID photo .....24  
Making Batch Print (Index Print/DPOF Print/Print All) .....25  
Changing the settings .....26  
    Setting the Date Print .....26  
    Setting the print finish (Borders/Borderless print) .....26  
    Setting the On-screen Display .....27  
    Changing the Color Setting .....28  
    Hiding or showing the Printer information display .....29  
    Resetting to the Default Setting .....29  
Printing from a USB memory .....30

---

## Printing from a PictBridge camera

Printing from a PictBridge camera .....31

---

## **Printing from a Bluetooth-compliant device**

Printing from a Bluetooth-compliant device .....	32
Compatible profiles for Bluetooth communication .....	32
Printing procedures .....	32

---

## **Printing from a PC**

Printing from a PC .....	34
Installing the software .....	34
System requirements .....	34
Installing the printer driver .....	35
Uninstalling the printer driver .....	37
Installing the Picture Motion Browser .....	38
Uninstalling the Picture Motion Browser .....	39
Printing photos from the Picture Motion Browser .....	39
Registering a browsing folder .....	43
Stopping printing .....	43
Printing from a commercially-available software application .....	44

---

## **Error messages**

If an error display appears .....	45
-----------------------------------	----

---

## **Troubleshooting**

If trouble occurs .....	48
If paper jams .....	58
Cleaning .....	59

---

## **Additional information**

Precautions .....	60
On safety .....	60
On installation .....	60
On cleaning .....	60
On restrictions on duplication .....	61
About the Memory Cards .....	61
"Memory Stick" .....	61
SD Memory Card .....	62
xD-Picture Card .....	62
Notes on using a memory card .....	63
Specifications .....	63
Printing range .....	65
Glossary .....	66
Index .....	67

## Identifying the parts

For details, see the pages indicated in the parentheses.

Illustrations are of the DPP-FP75. The button locations and names of the DPP-FP65 are identical, although the LCD screen size is different.

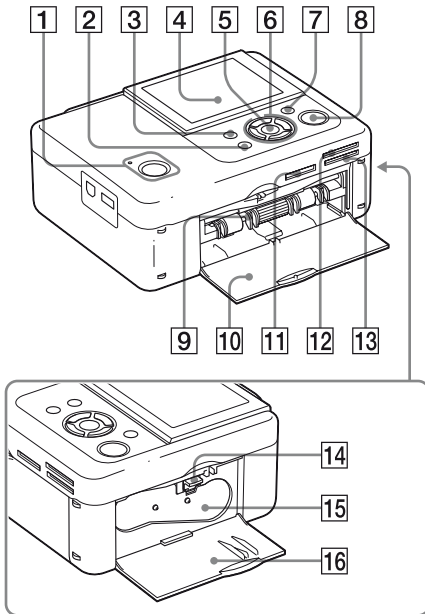

## Printer front panel

- 1 (on/standby) button/(standby) indicator
- 2 CANCEL/ (Index View) button
- 3 MENU button
- 4 LCD screen

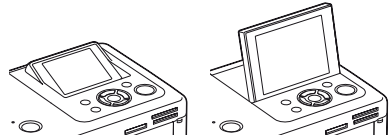

- 5 ENTER button
- 6 Direction (</>/</>/</>) buttons
- 7 (Red-eye Correction) button  
(→ page 20)
- 8 PRINT button/indicator
- 9 Paper tray compartment  
(→ page 10)
- 10 Paper tray compartment door
- 11 “Memory Stick PRO” (Standard/  
Duo) slot (→ pages 16, 61)
- 12 xD-Picture Card slot  
(→ pages 16, 62)
- 13 SD Memory Card slot  
(→ pages 16, 62)
- 14 Ink ribbon eject lever (→ page 9)
- 15 Ink ribbon (not supplied)  
(→ page 9)
- 16 Ink ribbon compartment door  
(→ page 9)

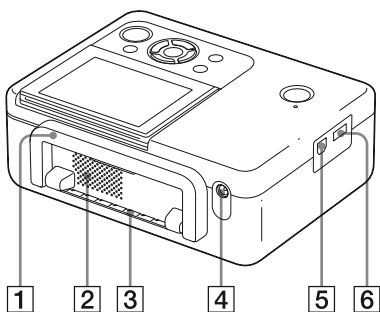

## Printer left side panel

### 5 USB connector (→ page 36)

When using your computer, connect it via a USB cable to this connector.

### 6 PictBridge/EXT INTERFACE connector (→ pages 31 to 32)

When using a PictBridge-compliant digital camera, a USB memory, a Bluetooth USB adaptor (DPPA-BT1\*), or other external USB device, connect it to this connector.

(\*In some regions, the DPPA-BT1 Bluetooth USB adaptor is not sold.)

## Printer rear panel

### 1 Handle

As illustrated below, raise the handle when you carry the printer.

When you use the printer, close the handle to its original position.

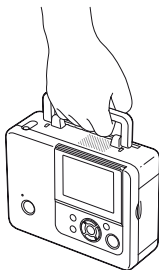

### Notes

- When you carry the printer, make sure to remove memory cards, USB memory, the paper tray, AC adaptor, and other cables. Otherwise malfunctions may occur.
- When using the DPP-FP75, set the LCD panel to its original position.

### 2 Ventilation holes

### 3 Paper outlet

### 4 DC IN 24 V jack (→ page 12)

Plug the supplied AC adaptor into this connector. Then connect the AC adaptor and AC outlet with the power cord.



## Checking the contents of the package

Make sure that the following accessories are supplied with your printer.

- Paper tray (1)
- AC adaptor (1)
- AC power cord\*1 (1)
- Cleaning cartridge (1)/Cleaning sheet (1)
- CD-ROM (Windows Printer Driver Software Ver.1.0 and Picture Motion Browser Ver.3.0)
- Operating Instructions (this booklet)
- Read This First (1)
- About the Print Packs (1)
- Warranty (In some regions, the warranty is not supplied.)
- Sony End User Software License Agreement

\*1 The plug shape and specifications of the AC power cord differ depending on the region in which you purchased the printer.

## About Sony Print Packs (not supplied)

Please use a Sony optional color print pack designed for the printer. For details, see the supplied "About the Print Packs".

## Setting the ink ribbon

- 1 Pull and open the ink ribbon compartment door.
- 2 Insert the ink ribbon in the direction of the arrow until it clicks into place.

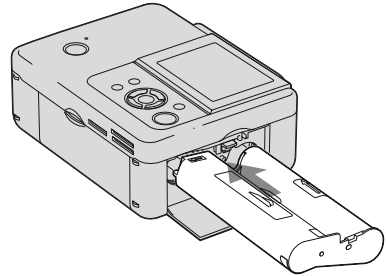

- 3 Close the ink ribbon compartment door.

### Removing the ink ribbon

Push up the eject lever, and remove the used ink ribbon.

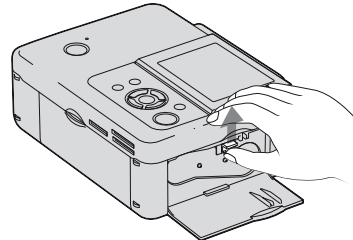

## Notes

- Do not touch the ink ribbon or store the ink ribbon in a dusty location. Fingerprints or dust on the ink ribbon may result in imperfect printing.
- Do not rewind the ink ribbon and use the rewind ink ribbon for printing. Otherwise, proper printing results will not be obtained, or a malfunction may occur. If the ink ribbon does not click into place, remove it and then re-insert it. Only when the ink ribbon is too slack to be loaded, keep pressing the core of the ribbon and wind the ink ribbon in the direction of the arrow to remove the slack.

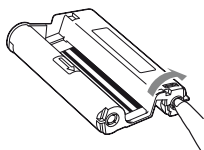

Do not wind the ribbon in the directions shown here

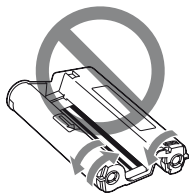

- Do not disassemble the ink ribbon.
- Do not pull out the ribbon from the ink ribbon.
- Do not remove the ink ribbon while printing.
- Avoid placing the ink ribbon in a location subject to high temperatures, high humidity, excessive dust or direct sunlight. Please store it in a cool and dark place and use it within a short period from the date of production. Depending on the storage conditions, the ink ribbon may deteriorate. Use of such an ink ribbon may affect the printed results, for which we cannot guarantee or compensate.

## Inserting the print paper

- 1** Open the paper tray cover.  
Hold the parts on both sides of the paper tray cover (shown with arrows) and open the paper tray cover.

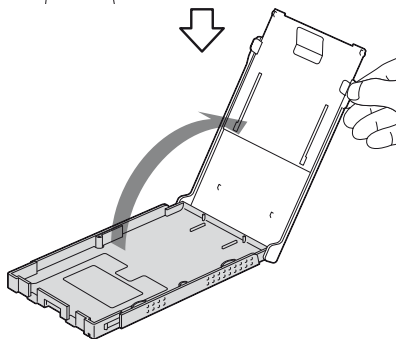
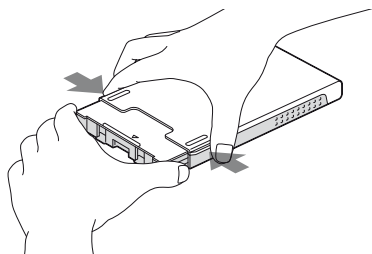

- 2** Set the print paper into the paper tray.

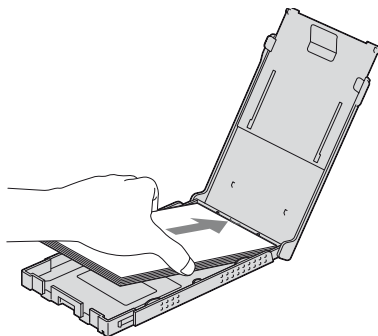

### 3 Close the paper tray cover.

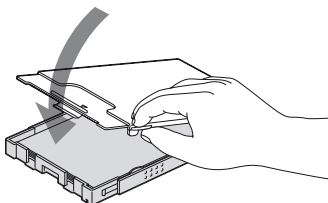

### 4 Open the slide cover.

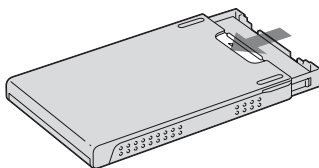

### 5 Insert the paper tray into the printer.

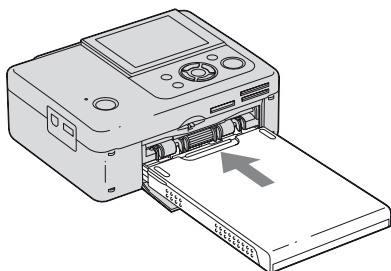

#### Notes

- You can set up to 20 sheets of print paper. Riffle the print paper thoroughly. Insert the print paper with the protective sheet facing up. Then remove the protective sheet.
- Insert the print paper with its printing surface (the side with no imprint) facing up.
- Do not touch the printing surface. Fingerprints or contamination on the printing surface may result in imperfect printing.
- Do not bend the print paper, or cut the print paper from the perforations before printing.

- To avoid paper jam or malfunctions of the printer, make sure of the following before printing:
  - Do not write or type on the print paper.
  - Do not attach a sticker or stamps on the print paper.
  - When adding print paper to the paper tray, be sure that the total number of print paper sheets does not exceed 20 sheets.
  - Do not insert different types of print paper together into the paper tray.
  - Do not print on used print paper. Printing an image twice on the same paper will not make the printed image thicker.
  - Use the print paper for this printer only.
  - Do not use print paper ejected without printing.

#### Notes on storing the print paper

- To store print paper in the tray, remove the paper tray from the printer and close the slide door of the paper tray.
- Avoid storing the paper with the printed faces touching each other or in contact with rubber or plastic products, including vinyl chloride or plasticizer for an extended period of time; color changes or deterioration of the printed image may occur.
- Avoid placing the print paper in a location subject to high temperatures, high humidity, excessive dust or direct sunlight.
- When you are going to store partially-used print paper, store it in its original bag or a similar container.

# Connecting to the AC power source

- 1 Insert the plug of the AC adaptor into the DC IN 24 V jack on the back of the printer.
- 2 Connect one plug of the AC power cord to the connector of the AC adaptor and the other plug to the wall outlet.

## Notes

- Do not place the printer in an unstable location such as on a wobbly table.
- Leave enough room around the printer. The print paper emerges from the back a few times during printing. Keep 10 cm (13/32 inch) or more space at the rear of the printer.
- Connect the AC adaptor to an easily accessible wall outlet close by. If trouble occurs while using the adaptor, immediately shut off the power by disconnecting the plug from the wall outlet.
- Do not short the plug of the AC adaptor with a metallic object, as this may cause a malfunction.
- Do not use the AC Adaptor placed in a narrow space, such as between a wall and furniture.
- When you have finished using the AC adaptor, disconnect the AC power cord from the DC IN 24 V jack of the printer and from the AC power sources.
- The printer is not disconnected from the AC power source (mains) as long as it is connected to the wall outlet, even if the printer itself has been turned off.

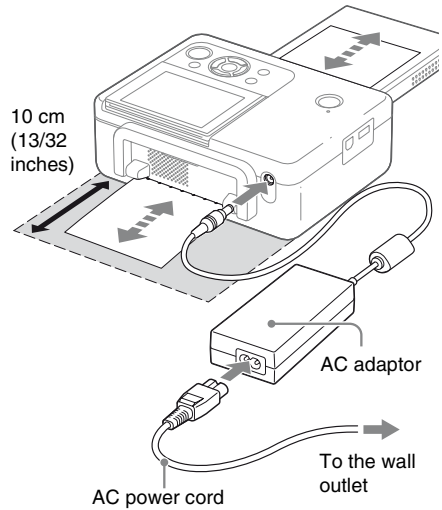

## To use your Printer abroad - Power sources

You can use your Printer and the AC Adaptor (supplied) in any country or region where the power supply is within 100 V to 240 V AC, 50/60 Hz. Use a commercially available AC plug adaptor [a], if necessary, depending on the wall outlet (wall socket) [b].

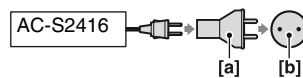

Do not use an electronics transformer (travel converter), as this may cause a malfunction.

## LCD screen display

### An image preview

On-screen Display: On

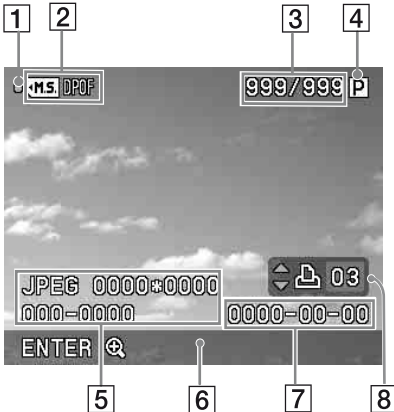

On-screen Display: Off

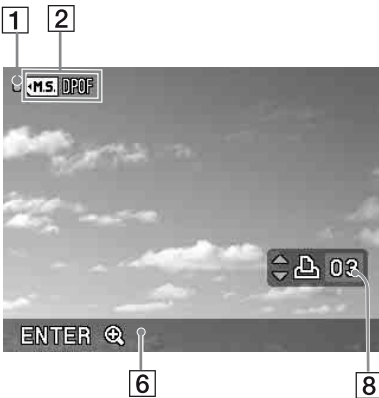

You can change the image preview view by setting the “On-screen Display” from the menu. (page 27)

#### 1 Access indication





Appears while the printer is accessing a memory card or a USB memory.

#### Note

While the access indication is displayed, do not remove a memory card or a USB memory, or do not turn off the power. Data may be damaged.

#### 2 Input/setting indications

Input indications and settings information for an image are displayed.

Icons	Meaning
	“Memory Stick” input
	SD Memory Card input
	xD-Picture Card input
	USB Memory input
	DPOF print preset indication

#### 3 Number of selected images/Total number of image

#### 4 Ink ribbon indication

 : P size

 : Cleaning cartridge

#### 5 Image file information (file format, file size, image number (folder- file number)\*)

(\*DCF-compatible files only. In case of other file formats, only part of file name will be displayed.)

#### 6 Operation tips

#### 7 Shot or Saved date (year/month/day)

#### 8 Print quantity setting

Continued

## Image list

Displays a list of the images stored in the selected media.

### DPP-FP65

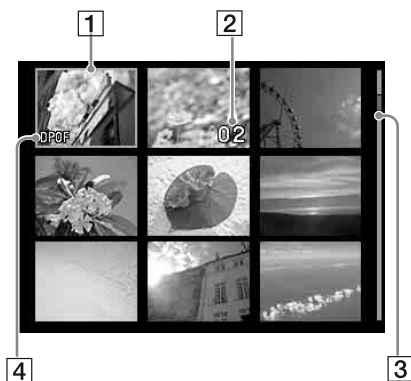

### DPP-FP75



#### 1 Cursor (orange frame)

You can move the cursor (selection) by pressing  $\triangleleft/\triangleright/\triangle/\nabla$ .

#### 2 Print quantity setting

Appears only when the print quantity is being set.

#### 3 Scroll bar

Indicates the position of the image among the total number of images.

#### 4 DPOF DPOF print preset indication

### Switching an image preview and image list

You can switch the display as follows:

- **To display the image list**

In an image preview, press the  (Index View) button.

When there are multiple pages, you can switch pages by pressing  $\triangle/\nabla$ .

- **To display an image preview**

In the image list, press  $\triangleleft/\triangleright/\triangle/\nabla$  to move the cursor to the desired image and press ENTER.

In an image preview, you can change the displayed image by pressing  $\triangleleft/\triangleright$ .

- **To enlarge an image**

In the image preview window, press ENTER. Each time you press the button, the image is enlarged up to 5 times the original scale: x1.5, x2, x3, x4, and then x5. In an enlarged image preview, you can change the portion to be displayed by pressing  $\triangleleft/\triangleright/\triangle/\nabla$ .

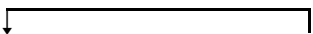











  
x1 → x1.5 → x2 → x3 → x4 → x5











## List of icons

The following are the icons displayed on the LCD screen.

You can proceed with operations by selecting a desired icon with  $\triangleleft/\triangleright/\Delta/\nabla$ , and then pressing ENTER.

For detailed explanations, see the pages in the parentheses.

Icons	Meaning
	Edit (21)
	Layout Print (23)
	ID Photo (24)
	Batch Print (25)
	Print setup (26)
Edit/Layout Print/ID Photo	
	Enlarging and reducing an image size (21)
	Moving an image (21)
	Rotating an image (21) (Rotates 90° Clockwise.)
	Adjusting the picture quality of an image (21)
	Changing a photo into a monochrome one (24) * This option is available only in ID Photo operations.
	Resetting edits (22)
	Printing an edited image (22)
	Exiting the menu (23)

Icons	Meaning
Batch Print	
	Index Print (25) (Prints all the images in split screens.)
	Print All (25) (Prints one copy each for all the images.)
	DPOF Print (25) (Prints the images with the print mark (  ) in an image preview with the preset number of copies in the order they are displayed.)
Print setup	
	Date Print (26)
	Borders/Borderless (26)
	On-screen Display (27)
	Color Setting (28)
	Printer information display (29)
	Default Setting (29) (Resets the settings to the factory-preset default settings.)

# Basic printing

## Inserting a memory card

Prepare a memory card that contains images for printing: “Memory Stick”, “Memory Stick Duo”, SD Memory Card, or an xD-Picture Card.

Insert the desired card **with its labelled surface facing up** into the proper slot until it clicks firmly into place.

For the types of memory cards you can use with the printer, please see pages 61 to 63.

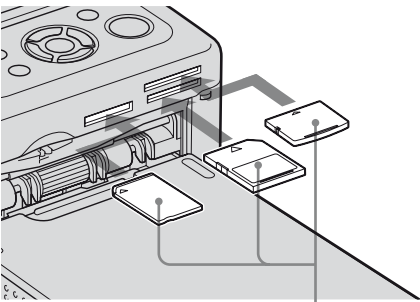

From the left, with the label side facing up, “Memory Stick”, (“Memory Stick Duo”), SD Memory Card, and xD-Picture Card

### To eject a memory card

Remove the memory card from the slot slowly in the reverse direction it was inserted.

## Notes

- Insert only the memory card that you want to use for printing. When multiple memory cards are inserted, the memory card inserted first will have the first priority.
- The printer supports both standard and small sizes. A “Memory Stick Duo” adaptor is not necessary.
- To use a memory card, follow the notes described on pages 61 to 63.

## Printing selected images

This section explains how to display the images of a memory card or a USB memory on the printer’s LCD screen and print the selected images (direct printing). For how to print from a USB memory, see page 30.

### Setting the print quantity

- 1** Press  $\text{⏻}$  (on/standby) to turn on the printer.  
The standby indicator turns off. An image stored in the memory card or USB memory is displayed on the LCD screen.
- 2** Press  $\text{⏪}$  to display the image that you want to print.
- 3** Set the print quantity.  
To print one copy of the displayed image, skip this procedure and go on to the next step.  
Press  $\Delta$  to display the print quantity indication. Then specify the print quantity with  $\Delta/\nabla$ .



## 4 Press PRINT.

While the PRINT button is lit in green, the printer is ready for printing. The image being displayed is printed.

### To print multiple images

Repeat steps 2 and 3.

### To change the print quantity

Display the image whose print quantity you want to change, and change the print quantity with  $\Delta/\nabla$ .

If you select "0", printing is canceled.

## Enlarging an image to be printed (Trimming Print)

Press ENTER repeatedly until the image is enlarged to the desired size. You can enlarge an image up to the 5 times the original scale. Press  $\leftarrow/\rightarrow/\Delta/\nabla$  to move an image.

Press PRINT to display the image preview for printing. Then press PRINT again to print the previewed image.

Even if you have set a print quantity for other images, only the previewed image is printed.

### Notes

- Never move or turn off the printer while it is printing; the ink ribbon or print paper may become stuck. If you turn off the power accidentally, keep the paper tray inserted and turn on the printer again. If paper being printed remains in the printer, remove the paper that emerges automatically and resume printing.
- Do not remove the paper tray during printing. Otherwise, a malfunction may occur.
- The print paper emerges a few times during printing. Do not touch nor pull the emerged paper during the printing process.
- If print paper is jammed, see page 58.

## On selecting input

The printer is not equipped with an input select switch. When you connect a memory card or a USB memory to the printer, images from the connected media are displayed automatically. If multiple memory cards or a USB memory are connected, the media first connected has the priority.

When you turn on the printer with multiple media inserted or connected, the printer detects the media in the order of "Memory Stick", SD Memory Card, xD-Picture Card, and then a USB memory connected to the PictBridge/EXT INTERFACE connector.

# Enjoying various printing

## ● Operation using the printer buttons

### 👁 Red-eye Correction

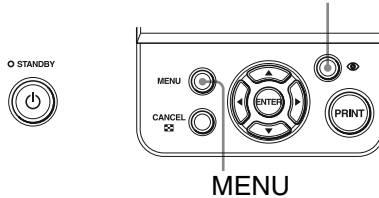

## Red-eye Correction → page 20

Press the 👁 (Red-eye Correction) button to correct the red-eye phenomenon of an image automatically.

## A variety of printing

Press MENU and then select an icon of the desired operation.

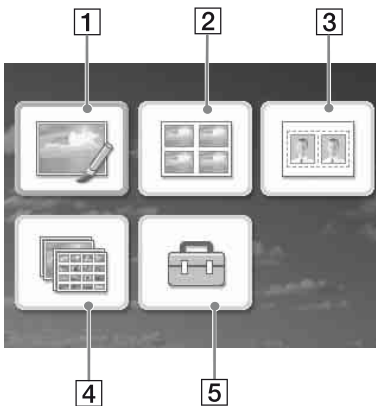

- Press </>/>/Δ/▽ to select the desired icon and press ENTER.

- 1 Edit
- 2 Layout Print
- 3 ID Photo Print
- 4 Batch Print
- 5 Print setup

- To exit the menu, press MENU again.

## 1 Edit → page 21

You can adjust the size, position, hue or other picture property of the selected image.



For the icons you can use, see page 15.

## 2 Layout Print → page 23

You can place multiple photos on split screens to make a print



You can make a print with 2-split, 4-split, 9-split, 13-split or 16-split images.

## 3 ID Photo Print → page 24

You can specify the desired width and height of a photo.



You can use a photo for an identification card such as a passport.

## 4 Batch Print → page 25

You can print a large number of images of a memory card or USB memory at one time.



You can select from batch print options such as “Print All”, “Index Print”, and “DPOF Print”.

## 5 Print setup → page 26

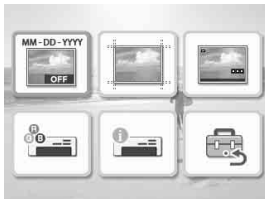

You can change the settings during printing, the printer settings, and on-screen display settings.



# Red-eye Correction

- 1 Display an image that you want to adjust and then press  (Red-eye Correction). Red-eye Correction of the selected image starts. The results of the adjustment will be displayed on the screen.

## To display the original image (Before correction) again

Press  (Red-eye Correction). To display the adjusted image, press  again.

## To cancel correction

Press CANCEL.

### Tip

Although you can check the red-eye correction status by pressing ENTER and enlarging an image, the image to be printed is not enlarged. To print an enlarged and red-eye-corrected image, first enlarge an image and then perform red-eye correction.

## If you have set print quantity for multiple images

All the images with print quantity settings are adjusted. To display other images, press </>.

## To set the print quantity

Before you start red-eye correction, set the print quantity (page 16). You cannot set or change print quantity after you finish the red-eye correction. To change the print quantity setting, cancel the red-eye correction.

### Tips

- If there are no images with print quantity settings, the Red-eye Correction adjusts the image being previewed.
- If there are other images with print quantity setting, and print quantity is not specified for the image being previewed, the image being previewed will not be corrected. The images with print quantity settings will be adjusted.
- If you enlarged an image, only the enlarged image will be adjusted and then printed.

## 2 Press PRINT.

Printing of the image being adjusted starts. When the print quantity setting is specified, the specified number of copies are printed.

### Tips

- Adjustment takes effect only on the image being printed. The original image will not be adjusted.
- You cannot perform editing on an image after Red-eye Correction.



### Notes

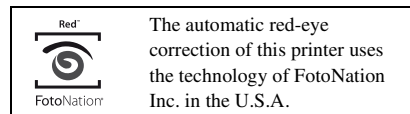

- Depending on the image, the red-eye phenomenon may not be corrected.
- When you cancel the edits by selecting  (Reset) in the Edit menu, the Red-eye Correction will also be cancelled.
- During the Red-eye Correction process, an animation to show reading and handling of data from a memory card or a USB memory will be displayed. While the animation is displayed, do not remove the memory card or disconnect USB memory.





# Editing an image

## Enlarging and reducing an image size

**1** From the  Edit menu (page 19), press  $\triangleleft/\triangleright$  to select  (Enlarge) to enlarge an image or  (Reduce) to reduce it, and then press ENTER.

Each time you press the button, the image becomes larger or smaller. You can also use the  (zoom in) and  (zoom out) buttons to enlarge or reduce the image size:



 : up to 200%

 : down to 60%

### Note

The picture quality of an enlarged image may deteriorate depending on its size.

## Moving an image

**1** From the  Edit menu (page 19), press  $\triangleleft/\triangleright$  to select  (Move) and then press ENTER.

The  $\triangleleft/\triangleright/\triangleup/\triangledown$  indicators appear on the left/right/above/below the image and you can move the image.



**2** Press  $\triangleleft/\triangleright/\triangleup/\triangledown$  to move an image. The image moves in the selected direction.

**3** Press ENTER.

The image is fixed in its current position.

**4** Press PRINT.



## Rotating an image

**1** From the  Edit menu (page 19), press  $\triangleleft/\triangleright$  to select  (Rotate) and then press ENTER.





Each time you press ENTER, the image rotates 90° clockwise.

**2** Press PRINT.

## Adjusting an image

**1** From the  Edit menu (page 19), press  $\triangleleft/\triangleright$  to select  (Adjust) and then press ENTER.

The Adjust menu is displayed.

Icons	Meaning
 Brightness	Adjusting the Brightness
 Tint	Adjusting the Tint
 Saturation	Adjusting the Saturation
 Sharpness	Adjusting the Sharpness
	Exiting the Adjust menu. Saves and reflects the editions made and returns to the previous step.

**2** Press  $\triangleleft/\triangleright$  to select the desired adjustment tool and press ENTER. The adjustment screen of the selected tool appears.

When  (Brightness) is selected

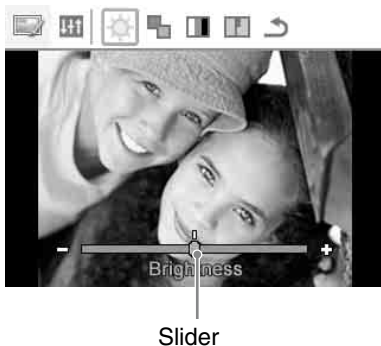

Press  $\leftarrow/\rightarrow$  to adjust an image while checking the level of brightness, for example.

- **Brightness:** Press  $\rightarrow$  to brighten the picture or  $\leftarrow$  to darken it.
- **Tint:** Press  $\rightarrow$  to make the picture greenish or  $\leftarrow$  to make it reddish.
- **Saturation:** Press  $\rightarrow$  to deepen the colors or  $\leftarrow$  to lighten the colors.
- **Sharpness:** Press  $\rightarrow$  to sharpen the outlines or  $\leftarrow$  to soften them.

### 3 Press ENTER.

The adjustment is executed and you can select other adjustment option.

### 4 Press $\leftarrow/\rightarrow$ to select (Exit) and then press ENTER.

The Adjust menu will be closed.

### 5 Press PRINT.

## Printing an edited image

### 1 Press $\leftarrow/\rightarrow$ to select (Print) and then press ENTER. Or, press PRINT.

The print window is displayed. The print quantity is displayed.

### 2 Set the print quantity.

- To increase the print quantity one by one, press  $\Delta$  repeatedly.
- To reduce the print quantity one by one, press  $\nabla$  briefly repeatedly.

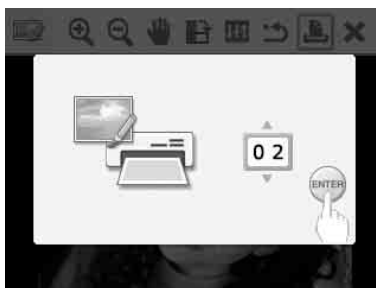

### 3 Press ENTER.

## Undoing the operations

### 1 Press $\leftarrow/\rightarrow$ to select (Reset) and then press ENTER.

The confirmation window is displayed.

### 2 Press $\Delta/\nabla$ to select "OK", and press ENTER.

The settings in the Edit menu and Red-eye Correction are disabled, and the image is reset to the state it was in before editing.

The Edit screen or Adjust screen is displayed again. If you press CANCEL or select "CANCEL" and press ENTER, the previous window is displayed.

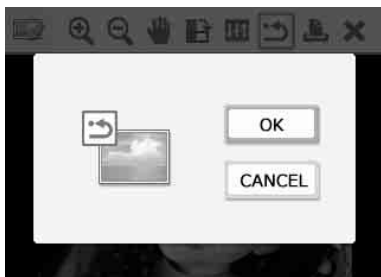

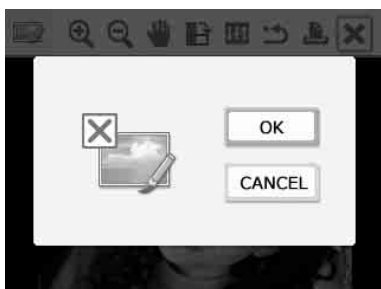

## Exiting the menu ✕

- 1** Press  $\langle \rangle$  to select ✕ (Exit) and then press ENTER.  
The confirmation window is displayed.
- 2** Press  $\Delta/\nabla$  to select “OK”, and press ENTER.  
The menu operations are terminated and the window displayed before entering the menu is displayed again.  
If you press CANCEL or select “CANCEL” and press ENTER, the previous window is displayed.



## Making layout prints

- 1** From the main menu (page 18), press  $\langle \rangle$ / $\Delta/\nabla$  to select  (Layout Print), then press ENTER.  
The Layout Print templates are displayed.
- 2** Press  $\langle \rangle$ / $\Delta/\nabla$  to select the desired template, then press ENTER.  
The preview of the selected template is displayed.
- 3** Select an image.  
When you select a template with multiple images, repeat the procedures below to select an image for each area.
  - ① Press  $\langle \rangle$ / $\Delta/\nabla$  to select an image area, then press ENTER.  
The image list is displayed.
  - ② Press  $\langle \rangle$ / $\Delta/\nabla$  to select the desired image, then press ENTER.  
The window used for adjusting the image is displayed.  
For adjustment, see “Adjusting an image” on page 21.  
You can adjust red-eye phenomenon automatically by pressing the  (Red-eye Correction) button (page 20).  
After the Red-eye Correction is performed, you cannot do other adjustments. Make sure to perform the Red-eye Correction after you finish other adjustments.
- 4** Press  $\langle \rangle$  to select **OK** and press ENTER.  
The selected image is added to the image area.
- 5** Press PRINT.

Continued

# Making an ID photo

- 1 From the main menu (page 18), press  $\langle \text{I} \rangle / \Delta / \nabla$  to select  (ID Photo) and then press ENTER. The window used for setting the height and width of an ID Photo is displayed.

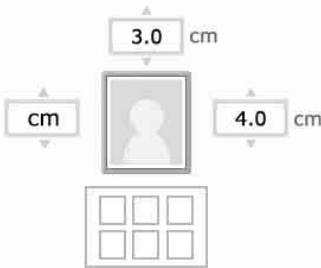

## Tip

You can set a maximum size of 7.0 (width) x 9.0 (height) cm.

- 2 Press  $\langle \text{I} \rangle / \Delta / \nabla$  to select “Height” or “Width” to be adjusted and press ENTER. The cursor moves to the number input area of the selected item.
  - To specify the unit: Select either “cm” or “inch”.
  - To specify the height: Select the figure box at the right of the photo frame.
  - To specify the width: Select the figure box in the upper of the photo frame.
- 3 Press  $\Delta / \nabla$  to set the size and then press ENTER. The ID photo preview of the specified size is displayed.
- 4 If you want to specify another size, repeat steps 2 and 3.

- 5 Press  $\Delta / \nabla$  to select  and press ENTER.

The window used for selecting an image is displayed.

- 6 Press  $\langle \text{I} \rangle / \Delta / \nabla$  to select the desired image, and then press ENTER.

The window used for adjusting the image position is displayed.

For adjustment, see step “Adjusting an image” on page 21.

You can also change a color photo into a monochrome one. Select  (Monochrome) and press ENTER. You can select this option while making an ID Photo.

- 7 Press  $\langle \text{I} \rangle / \Delta$  to select  and press ENTER.

A preview of the ID photo print is displayed.

- 8 Press PRINT.

## Note

An ID photo printed may not be able to be acceptable for use in an identification card or passport. Please check the requirements for the photo to be used in the instructions before you submit the card or passport.



# Making Batch Print

## (Index Print/DPOF Print/Print All)

### • Index Print

You can print a list (index) of all the images stored in a memory card or a USB memory, which allows you to check the contents of the selected media easily.

The number of split panes on a sheet is fixed to 8 horizontally by 6 vertically.



### • Print All

You can print all the images stored on a memory card or a USB memory at one time.

### • DPOF Print



The images which are DPOF (Digital Print Order Format) preset for printing are displayed with the print mark (  ) in an image preview. You can print those images at one time. The images are printed with the preset number of copies in the order they were displayed.

#### Notes

- For how to preset images for printing, see the manual of your digital camera.
- Some types of digital cameras do not support the DPOF function, or the printer may not support some of the functions of the digital camera.

- 1 From the main menu (page 18), press  $\triangleleft/\triangleright/\triangle/\nabla$  to select  (Batch Print) and then press ENTER. The Batch Print menu is displayed.



- 2 Press  $\triangleleft/\triangleright$  to select  (Index Print),  (Print All), or  (DPOF Print) and then press ENTER. The confirmation dialog box is displayed.

#### Note

If there are no DPOF preset images when you selected “DPOF Print”, an error message will be displayed.

- 3 To start printing, press  $\triangle/\nabla$  to select “OK” and press ENTER. When you select “OK” printing starts.



#### Tips

- To stop printing, press CANCEL and press ENTER in step 3.
- When the “Date Print” item of the Print setup menu is set to “ON”, the date the image was shot or saved is not printed in the Index Print mode.



# Changing the settings

## Setting the Date Print

When the image is recorded using the DCF (Design rule for Camera File system) format, you can print an image with the date of shooting that is recorded as part of shooting information. You can select “ON” or “OFF” of Date Print and the order of year/month/day.

- 1 From the  (Print setup) menu, press  $\langle \! / \! \rangle / \Delta / \nabla$  to select  (Date Print) and then press ENTER. The Print setup menu is displayed.





- 2 Press  $\langle \! / \! \rangle$  to select  (Date Print) or  (no Date Print), and press ENTER.
- 3 To set the order of the date print, press  $\nabla$  to select  (Y-M-D), and then press  $\langle \! / \! \rangle$  to select the desired order:
  - D-M-Y: The date is displayed in the order of day, month and year.
  - M-D-Y: The date is displayed in the order of month, day and year.
  - Y-M-D: The date is displayed in the order of year, month and day.

- 4 Press ENTER. The setting is fixed. The Print setup window is displayed again.

### To redo the operations







Press CANCEL. The Print setup window is displayed again.

## Setting the print finish (Borders/Borderless print)

- 1 From the  (Print setup) menu, press  $\langle \! / \! \rangle / \Delta / \nabla$  to select  (Borders/Borderless Print) and then press ENTER. The Borders/Borderless Print menu is displayed.



- 2** Press  $\triangleleft/\triangleright$  to select the desired print finish.

Items	Procedures
	Borderless: Prints an image without blank space around the image. 
	Borders (Pattern 1): Prints an image with borders around the image, without cutting the image. 
	Borders (Pattern 2): Prints an image while leaving almost-equal borders in the top, bottom, right and left around the image. 

- 3** Press ENTER.  
The setting is fixed. The Print setup window is displayed again.

### To redo the operations



Press CANCEL. The Print setup window is displayed again.

#### Notes

- When you select “Borderless”, a standard 4:3 picture shot by a digital camera may be printed with the top and bottom edges cut and it is printed as a 3:2 picture.
- When you select “Borders (Pattern 2)”, the top and bottom edges or right and left edges may be trimmed and printed depending on the image.



## Setting the On-screen Display



- 1** From the  (Print setup) menu, press  $\triangleleft/\triangleright/\triangle/\nabla$  to select  (On-screen Display) and then press ENTER.  
The On-screen Display menu is displayed.



- 2** Press  $\triangleleft/\triangleright$  to select the desired setting item.

Items	Procedures
	On-screen Display is off. In an image preview, information other than the print quantity and input setting is not displayed.
	On-screen Display is on. In an image preview, information such as the number of selected images, shot date, and the details of an image file will be displayed in addition to the print quantity setting and input setting.

### 3 Press ENTER.

The setting is fixed. The Print setup window is displayed again.



#### To redo the operations

Press CANCEL. The Print setup window is displayed again.

#### Tip

The year, month and day of the shot date are displayed in the same order as the Date Print setting.

## Changing the Color Setting

- 1 From the  (Print setup) menu, press  $\triangleleft/\triangleright/\triangle/\nabla$  to select  (Color Setting) and then press ENTER. The Color Setting menu is displayed.





- 2 Press  $\triangleleft/\triangleright$  to select the desired color element, and press  $\triangle/\nabla$  to set the level.  
You can set the levels for a color element: “R” (red), “G” (green) or “B” (blue) in the range from +4 to -4.  
**R:** Adjusts the red and blue elements. The higher you set the level, the more reddish the picture becomes as if it is subjected to red light. The lower you set the level, the darker the picture becomes, as if light blue is added.  
**G:** Adjusts the green and purple elements. The higher you set the level, the more greenish the picture becomes as if it is subjected to green light. The lower you set the level, the darker the picture becomes, as if reddish purple is added.  
**B:** Adjusts the blue and yellow elements. The higher you set the level, the more bluish the picture becomes as if it is subjected to blue light. The lower you set the level, the darker the picture becomes, as if yellow is added.

- 3** Press ENTER.  
The setting is fixed. The Print setup window is displayed again.

**To redo the operations**

Press CANCEL. The Print setup window is displayed again.

### Hiding or showing the Printer information display



- 1** From the  (Print setup) menu, press  $\triangleleft/\triangleright/\triangle/\nabla$  to select  (Printer information display) and then press ENTER.  
The Printer information display menu is displayed. You can check the version number and total print quantity of the printer.



- 2** Press ENTER.  
The Printer information display window is closed.

### Resetting to the Default Setting

You can reset all the settings to the default settings.

- 1** From the  (Print setup) menu, press  $\triangleleft/\triangleright/\triangle/\nabla$  to select  (Default Setting) and then press ENTER.  
The confirmation window is displayed.
- 2** Press  $\triangle/\nabla$  to select "OK" and press ENTER.  
The printer settings are reset to their default settings.



# Printing from a USB memory

You can connect a USB memory and the printer, and print an image directly from the USB memory.

## Notes

- We cannot guarantee connection with all types of USB memory.
- We cannot guarantee connection with a mass storage-compliant digital camera or photo storage.
- If a memory card is inserted in the printer, the printer cannot read the signal from a USB memory connected to the PictBridge/EXT INTERFACE connector of the printer. Remove the memory card, if any.

- 1** Connect the printer to the AC power source (page 12).
- 2** Press the  (on/standby) button to turn on the printer.
- 3** Connect a USB memory into the PictBridge/EXT INTERFACE connector of the printer.

To PictBridge/EXT  
INTERFACE connector

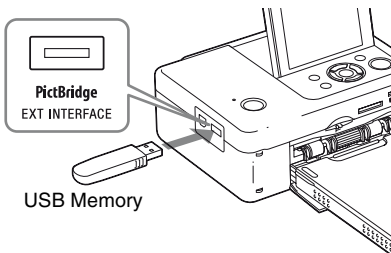

## Notes

- While the access indicator of a USB memory is flashing, never turn off the power of the printer. The data stored in the USB memory may be damaged. We cannot compensate for any damages that may be caused by data loss or damage.
- You cannot use a USB hub or a USB device equipped with a USB hub.
- Encoded or compressed data by fingerprint authentication or password cannot be used.

## Printing from a PictBridge camera

You can connect a PictBridge-compliant digital camera and print an image directly from your digital camera.

When printing in the PictBridge mode, make sure to remove memory card(s) and your computer from the printer in advance.

### 1 Set your digital camera ready for printing with a PictBridge-compliant printer.

The required settings and operations that must be completed before connection differ depending on the digital camera. For details, see the operating instructions of your digital camera. (In case of Sony Cyber-shot digital camera, for example, select “PictBridge” mode for “USB Connect”.)

### 2 Connect the printer to the AC power source (page 12).

### 3 Press the (on/standby) button to turn on the printer.

### 4 Connect the PictBridge-compliant digital camera to the PictBridge/EXT INTERFACE connector of the printer.

When you connect a PictBridge-compliant digital camera to the printer, “PictBridge” is displayed on the LCD display of the printer.

### 5 Operate the digital camera to print an image.

The printer supports the following prints:

- Single-image print
- All images print
- Index Print
- DPOF Print
- Borders/Borderless Print
- Date Print

To PictBridge/EXT  
INTERFACE connector

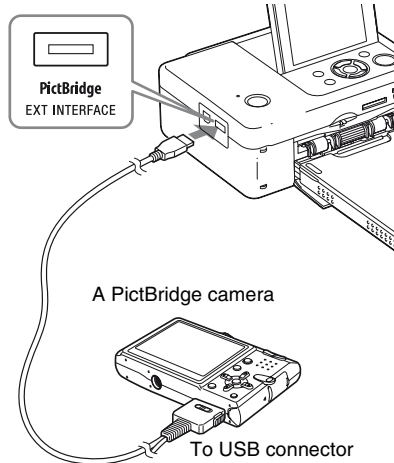

#### Notes

- If you replace an ink ribbon while the printer is connected to a PictBridge-compliant digital camera, an image may not be printed properly. If this occurs, disconnect and then re-connect the digital camera.
- When printing via the PictBridge/EXT INTERFACE connector, an image will be printed according to the settings of the Print setup menu of the printer. When you set the Date Print or Borders/Borderless options with your digital camera, the digital camera settings will have priority. If you select “Borderless” with the printer and “Borders” with your camera, “Borders (Pattern 1)” will be used for printing.
- You cannot use a USB hub or a digital camera containing a USB hub.
- For error messages displayed on your digital camera, refer to the operating instructions of your digital camera.

## Printing from a Bluetooth-compliant device

By connecting the Sony DPPA-BT1 Bluetooth USB adaptor to the PictBridge/EXT INTERFACE connector of your printer, you can print an image from a Bluetooth-compliant mobile phone, digital camera, or other device.

### Notes

- Do not use the DPPA-BT1 outside the area you purchased it. Depending on the area, the use of the adaptor may violate the local radio wave regulations and may be subject to penalty.
- In some regions, the Sony DPPA-BT1 Bluetooth USB adaptor is not sold.

## Compatible profiles for Bluetooth communication

The DPP-FP65/FP75 supports the following profiles:

- BIP (Basic Imaging Profile)
- OPP (Object Push Profile)

For the profiles that your Bluetooth device supports, please refer to its manual.

### What is a “Profile”?

A profile consists of the standards that enable Bluetooth wireless communication. There are several profiles available, depending on the purposes and product to be used. To make Bluetooth communication possible, the devices used in the communication should support the same profile.

### Compatible image file formats that can be printed

JPEG: DCF 2.0 compatible, Exif 2.21 compatible, JFIF (4:4:4, 4:2:2, 4:2:0 formats Baseline JPEG)

TIFF: Exif 2.21 compatible

BMP: 1, 4, 8, 16, 24, 32 bit Windows format

Some image file formats are not compatible.

### Maximum number of pixels that can be handled

8 000(H) × 6 000(V) dots (Maximum 3.5 MB or less)

## Printing procedures

When printing from the PictBridge/EXT INTERFACE connector, make sure to remove memory card(s) from the printer in advance.

- 1 Connect the printer to the AC power source.
- 2 Press the  (on-standby) button to turn on the printer.
- 3 Insert the Bluetooth adaptor into the PictBridge/EXT INTERFACE connector of your printer.

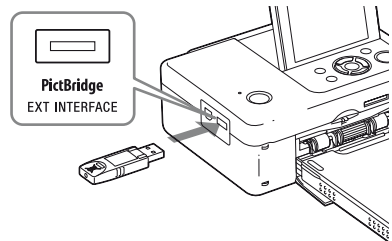

### Note

If any device, other than the Bluetooth adaptor, such as a memory card, camera, PC, or other USB memory or a USB cable is connected to any of the memory card slots, the PictBridge/EXT INTERFACE connector, or USB connector of your printer, disconnect it from the printer and then connect the Bluetooth adaptor.

- 4 Print from the Bluetooth-compliant mobile phone, or other device. For printing procedures, refer to the manual of your Bluetooth device.



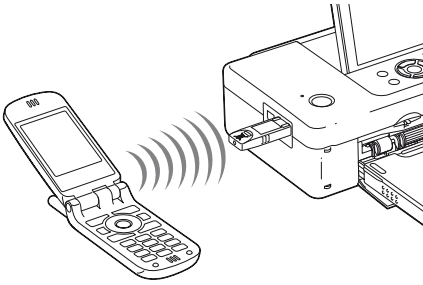

To select the printer from a Bluetooth-compliant device, select “Sony DPP-FP65 ##”/“Sony DPP-FP75 ##”. (“##” stands for the two figures from the right of the address displayed in the LCD screen.:



### When input of Passkey\* is required

Input “0000”. You cannot change the Passkey with the printer.

\* A Passkey is often referred to as a “pass code” or “PIN code”.

#### Notes

- Do not use the DPPA-BT1 outside the area you purchased it. Depending on the areas, the use of this product may violate the local radio wave regulations and may be subject to its penalty.
- The communication distance of the product may vary depending on the obstacles between the product (a human body, metal object, or wall) and the mobile phone or other device.
- The sensitivity of the Bluetooth communication may be affected in the following conditions:
  - When there is an obstacle between the product and the mobile phone or other product such as a human body, metal object, or a wall.

- Where a wireless LAN is established or a microwave oven is being used near-by, or other electromagnetic waves are emitted.
- Since a Bluetooth device and a wireless LAN (IEEE802.11b/g) device use the same frequency ranges, wave interference may occur when the product is used near a device equipped with a wireless LAN. This may cause deterioration in the communication speed and connection conditions. If this occurs, take the following measures:
  - Keep a distance of at least 10 m from a wireless LAN device when you connect the product to a mobile phone.
  - Turn off the wireless LAN device in case you want to use the product closer than 10 m from the wireless LAN device.
- We can not guarantee that this product works with all devices enabled with Bluetooth wireless technology.
- Sony cannot assume any responsibility for any information leakage that may be caused in Bluetooth communications.
- Sony cannot accept responsibilities for any failure to satisfy the protection requirements resulting from a non-recommended modification or use of the product.
- For customer support information, please refer to the operating instructions of your printer.

### ⚠ Caution

- Radio waves from a Bluetooth device may adversely affect the operation of electrical and medical devices, and could lead to accidents due to malfunctions. Make sure to turn off the product and mobile phone and do not use this product in the following places:
  - Inside medical facilities, trains, airplanes, gas stations or other places that may emit flammable gas.
  - near automatic doors or fire alarms or other automatically controlled devices.
- Keep this product at least 22 cm away from cardiac pacemakers. Radio waves from this product may adversely affect the operation of cardiac pacemakers.
- Do not disassemble or modify this product. Doing so could result in injury, electric shock, or fire.

## Printing from a PC

You can print the images from a PC by installing the supplied software on your PC and connecting it to the printer.

This section explains how to install the supplied software on your PC and how to use the supplied Picture Motion Browser software to print an image.

Please also refer to the operating instructions supplied with your PC for information on operating the PC.

Installation of the software is necessary only when you connect the printer to your PC for the first time.

### On the supplied CD-ROM

The supplied CD-ROM contains the following software:

- Printer driver for the DPP-FP65/FP75: The software describes the printer's requirements and enables printing from the PC.
- Picture Motion Browser: Sony's original software application that allows you to handle photographs and moving images—this includes capturing, managing, processing, and printing.

## Installing the software

### System requirements

To use the supplied printer driver and Picture Motion Browser, you need a PC that meets the following system requirements:

Operating System<sup>(\*)</sup> Microsoft Windows Vista <sup>(\*)</sup>/Windows XP SP2 <sup>(\*)</sup>/Windows 2000 Professional SP4 (Factory-installed)

<sup>(\*)</sup>This printer driver does not run on Windows 2000 Professional SP2 or Windows Me operating systems. This printer driver does not run on Macintosh.

<sup>(\*)</sup>The Picture Motion Browser, 64-bit editions and starter (Edition) are not supported.

CPU:	Pentium III 500MHz or faster (Pentium III 800MHz or faster is recommended.)
RAM:	256 MB or more (512 MB or more is recommended.)
Hard disk space:	400 MB or more (Depending on the Windows version you are using, more space will be required. To handle image data, you will need additional hard disk space.)
Display setting:	Screen resolution: 1024 × 768 dots or more Screen colors: High Color (16-bit) or greater
Connector	USB connector
Drive	CD-ROM drive (to be used for software installation)

## Notes

- If a hub is used to connect the printer and your PC, or if two or more USB devices, including other printers, are connected to your PC, trouble may occur. If this occurs, simplify the connections between your PC and the printer.
- You cannot operate the printer from another USB device being used simultaneously.
- Do not remove the USB cable from or connect it to the printer during data communication or printing. The printer may not work properly.
- The printer does not support standby, sleep, and hibernation modes and restarting from those modes. Do not allow the PC connected to the printer to switch to one of those modes during printing. If you do so, printing may be failed.
- When printing is failed, remove a USB cable and then connect it, or restart your computer. Then try printing again.
- If you pause a printing job in process, and resume printing after a while, printing may not be performed correctly.
- We cannot guarantee operations with all PCs, even though they may meet or exceed the system requirements.
- Picture Motion Browser supports DirectX technology and DirectX installation may be required. DirectX is available on the CD-ROM.
- If the Picture Motion Browser is installed on a PC on which the Cyber-shot Viewer is already installed, the Cyber-shot Viewer will be overwritten and replaced by the Picture Motion Browser. The browsing folders once registered in the Cyber-shot Viewer will be automatically registered in the Picture Motion Browser. When using the Picture Motion Browser, you can view the folders easier than you can when using the Cyber-shot Viewer, as the registered folders are displayed by group when viewing folders. With its improved red-eye reduction adjustment and newly-added tone curve adjustment, the Picture Motion Browser also offers more powerful editorial features. You can also use the software to write data onto an external memory card for it.

## Installing the printer driver

Follow the procedures below to install the driver.

### Notes

- Do not connect the printer to the PC before installing the driver.
- Please log on to Windows using a “Computer administrator” user account.
- Be sure to close all running programs before installing the software.
- The dialog boxes shown in this section are from Windows Vista, unless otherwise specified. The installation procedures and the dialog boxes shown differ depending on the operating system.

- 1 Turn on your PC, start Windows, and insert the supplied CD-ROM into the CD-ROM drive of your PC. The installation window is displayed.



### Notes

- If the installation window is not displayed automatically, double-click the “Setup.exe” file on the CD-ROM.
- In Windows Vista, the AutoPlay window may appear. Even if this occurs, select “Setup.exe” execution and install the driver according to the instructions on the screen.

- 2 Click “Installing Printer Driver”. The “InstallShield Wizard” dialog box is displayed.

**3** Click “Next”.  
The license agreement dialog box is displayed.

**4** Read the agreement thoroughly, and if you agree, check “I accept this agreement” and click “Next”.



**5** Click “Install”.  
Installation starts.

**6** When the “Sony DPP-FP65/75 printer driver has been successfully installed.” dialog is displayed, click “Finish”.

**7** Press the  (on/standby) button to turn on the printer.

**8** Connect the USB connectors of the printer and your PC with a USB cable (not supplied).  
Printer driver installation starts automatically.

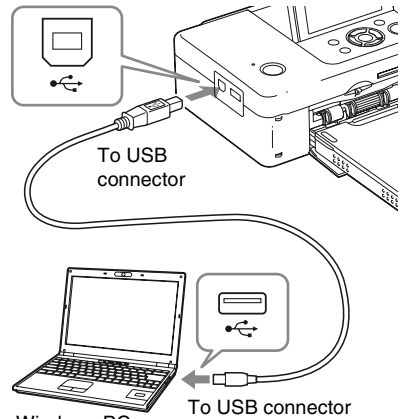

#### Note

Use a B-type USB cable shorter than 3m in length.

**9** Wait for a while, then check to see that “Sony DPP-FP65” or “Sony DPP-FP75” has been added to the “Printers” or “Printers and Faxes”.

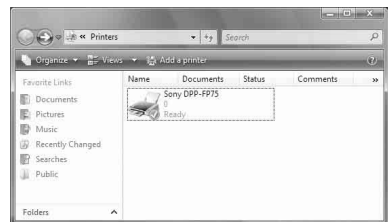

**10** When the installation is complete, remove the CD-ROM from your PC and keep it for future use.  
To continue the process and install the Picture Motion Browser software, follow the procedures from step 2 on page 38.

## Notes

- If the installation fails, remove the printer from your PC, restart your PC, and then follow the installation procedures from step 2 again.
- After installation, the “Sony DPP-FP65” or “Sony DPP-FP75” is not yet set as the default printer. Set the printer you use for each application.
- The supplied CD-ROM will be required when you uninstall or re-install the printer driver. Keep it for possible future use.
- Before you use the printer, read the Readme file (the Readme folder of the CD-ROM → English folder → Readme.txt).

### When the software is installed

The  icon is displayed on the Windows desktop, as well as a shortcut to the web site for printer customer registration. After you finish registration, you can find support information at: <http://www.sony.net/registration/di/>

## Uninstalling the printer driver

When the printer drive becomes unnecessary, please follow the procedures below to remove the printer driver:

- 1** Disconnect the USB cable (not supplied) from your printer and the PC.
- 2** Insert the supplied CD-ROM into the CD-ROM drive of your PC.  
The installation window is displayed.

### Note

If the installation window is not displayed automatically, double-click the “Setup.exe” file on the CD-ROM.

- 3** Click “Installing Printer Driver”.  
The “InstallShield Wizard” dialog box is displayed.
- 4** Click “Next”.  
The license agreement dialog box is displayed.

- 5** Read the agreement thoroughly, and if you agree, check “I accept this agreement” and click “Next”.  
The confirmation dialog box used for removing the software is displayed.
- 6** Click “Yes”.  
The confirmation dialog box used for restart is displayed.
- 7** Check “Yes, I want to restart my computer now” and click “OK”.  
After the computer is restarted, the relevant files will be deleted and uninstallation is complete.

## Installing the Picture Motion Browser

Follow the procedures below to install the Picture Motion Browser.

### Notes

- Please log on to Windows using a “Computer administrator” user account.
- Be sure to close all running programs before installing the software.
- The dialog boxes shown in this section are from Windows Vista, unless otherwise specified. The installation procedures and the dialog boxes shown differ depending on the operating system.

- 1** Turn on your PC, start Windows, and insert the supplied CD-ROM into the CD-ROM drive of your PC. The installation window is displayed (page 35).
- 2** Click “Installing Picture Motion Browser”. The “Choose Setup Language” dialog box is displayed.
- 3** Select your language and click “Next”. The “InstallShield Wizard” dialog box is displayed.
- 4** Click “Next”. The license agreement dialog box is displayed.

- 5** Read the agreement thoroughly, and if you agree, check “I accept the terms of the license agreement” and click “Next”.

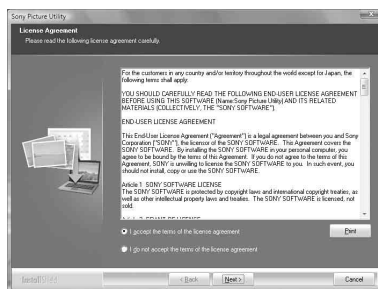

The dialog box used to specify the destination is displayed.

- 6** Check the destination and then click “Next”. The dialog box notifying you that the program is ready to be installed is displayed.
- 7** Click “Install” and follow the instructions on the screen to proceed with installation. When you are prompted to restart your PC, follow the displayed instructions to restart it.
- 8** When the installation is complete, remove the CD-ROM from your PC and keep it for future use.

### Notes

- If the installation fails, perform the installation procedures from step 2 again.
- The supplied CD-ROM will be required when you uninstall or re-install the Picture Motion Browser. Keep it in a safe place for possible future use.

## Uninstalling the Picture Motion Browser

When this software is no longer needed, remove it from your PC as follows:

- 1** Click “Start” - “Control Panel”.  
The Control Panel is displayed.
- 2** Open “Add or Remove Programs”.
- 3** Select “Sony Picture Utility” and click “Change/Remove”.  
The software uninstallation process starts.

## Printing photos from the Picture Motion Browser

You can use the Picture Motion Browser to print an image from your PC using P size print paper.

- 1** Start the Picture Motion Browser window using either of the following methods:
  - Double-click  (Picture Motion Browser) on the Windows desktop.
  - Click “Start” - “All Programs” (or “Programs” with Windows 2000) - “Sony Picture Utility” - “Picture Motion Browser”.

When the Picture Motion Browser is started for the first time, the dialog box used to register a viewed folder is displayed. If images have already been saved in the “Pictures” folder, click “Register Now”.

If you have saved images in a folder other than the “Pictures” folder, click “Register Later”. Refer to “Registering a browsing folder” on page 43.

### Tip

In Windows XP/Windows 2000, please read “Pictures” as “My Pictures”.

### How to access the “Pictures” folder

- In Windows 2000:  
Click “My Documents” - “Pictures” on the desktop.
- In Windows Vista/XP:  
Click “Start” - “Pictures” from the taskbar.

## 2 Click “Start”.

The main window of the Picture Motion Browser is displayed



In main window, there are the following two different views. To switch the view, click the “Folders” or “Calendar” tab in the right frame.

### • “Folders” view

The images will be classified in each registered folder and are displayed as thumbnails.

### • “Calendar” view

The images will be classified according to the shot date and are displayed as thumbnails on each date of the calendar.

In “Calendar” view, you can switch the display by year, by month, or by hour.

In this section, “Folders” view windows are used as examples.

## 3 Click the folder containing the photos you want to print.

As an example, the “sample” folder is selected in the following explanation.

## 4 Select the photos that you want to print and click (print).

The Print dialog box is displayed.

## 5 In the “Printer” drop-down list box, select “Sony DPP-FP65” or “Sony DPP-FP75”. To set the paper orientation or other print options, go to step 6. To print, skip to step 11.

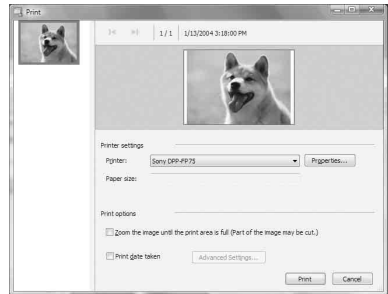

Items	Functions
Printer	Select the printer you are using: “Sony DPP-FP65” or “Sony DPP-FP75”
Paper size	To change the size, click “Properties”. <b>Note:</b> In some regions, L size print paper is not sold.
Print Options	<ul style="list-style-type: none"> <li>• Zoom the image until the print area is full: When checked, an image will be printed over the entire printing area of the paper. An edge of the photo may be cut. When unchecked, an image will be printed without cutting off any portions</li> <li>• Print date taken: When checked, an image is printed with the date of shooting if the image is a file recorded in the DCF (Design rule for Camera File system) format.</li> </ul>



Items	Functions
Properties	Specifies paper size, orientation, picture quality and other details.

**6** To set the paper orientation or other print options, click “Properties”. The “Properties” dialog box of the selected printer is displayed. The printer driver of the printer utilizes the Universal Printer Driver, a Microsoft common printer driver. In the dialog boxes, there are some items that are not used within this printer.

**7** In the “Layout” tab, specify the paper orientation or other options.

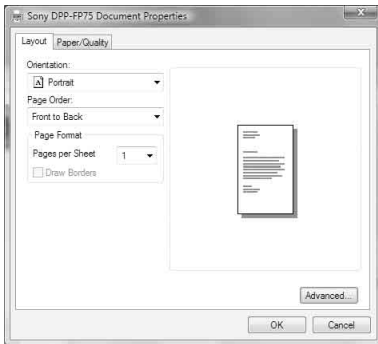

Items	Functions
Orientation	Select the orientation of an image when printed: <ul style="list-style-type: none"> <li>• Portrait</li> <li>• Landscape</li> </ul>
Page Order	Select the order of the pages when printed: <ul style="list-style-type: none"> <li>• Front to Back</li> <li>• Back to Front</li> </ul>
Pages Per Sheet	Specify the number of copies per sheet to be printed. Select “1”.
Advanced	Specifies the paper size or other options.

**8** Click “Advanced”. The “Sony DPP-FP65/75 Advanced Options” dialog box is displayed.

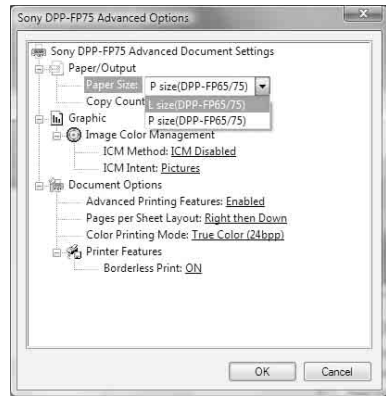

Items	Functions
Paper/ Output	<ul style="list-style-type: none"> <li>• Paper Size: From the drop-down list box, select the paper size you actually use for printing: P size (post card size)/L size</li> <li><b>Note:</b> L size print paper is not sold in some regions.</li> <li>• Copy Count: Specify the number of copies to be printed.</li> </ul>
Graphic - Image Color Management	<ul style="list-style-type: none"> <li>• ICM Method: The printer does not support the ICM method settings. Even if you select an option other than “ICM Disabled”, the printed results will not reflect the setting. Leave the option as it is.</li> <li>• ICM Intent: The printer does not support the ICM Intent settings. Leave the option as it is.</li> </ul>

Items	Functions
Document Options	<ul style="list-style-type: none"> <li>Advanced Printing Features: Select “Enabled” to turn on advanced printing options such as “Page Order”. If a compatibility problem occurs, disable this feature.</li> <li>Color Printing Mode: To print in colors, select “True Color (24bpp)”. To print in monochrome, select “Monochrome”.</li> </ul>
Printer Features	<ul style="list-style-type: none"> <li>Borderless Print: To print an image without borders, select “ON”. To print with borders, select “OFF”. Depending on the software application, an image will be printed with borders even if “ON” is selected. Set an image to be printed fully in the print range.</li> </ul>

## 9 On the “Paper/Quality” tab, specify the color or paper source.

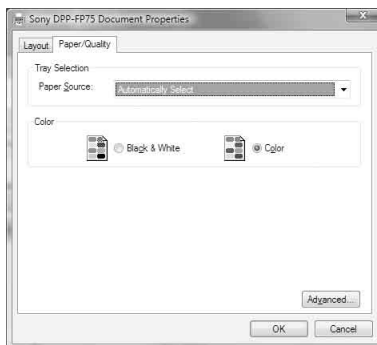

Items	Functions
Tray Selection	From the “Paper Source” drop-down list box, select “Automatically Select”.
Color	To print in colors, select “Color”. To print in monochrome, select “Black & White”.
Advanced	The “Sony DPP-FP65/75 Advanced Options” dialog box is displayed. (page 41) For details, see step 8.

## 10 Click “OK”.

The “Print” dialog box is displayed again.

## 11 Click “Print”.

Printing starts. For the details of the properties of the Picture Motion Browser, see the Picture Motion Browser help.

### Note

You cannot print a motion-picture file or RAW data files.

## Tips

- To select a series of still images in the image area of the main window, click the first image in the series and then click the last image while pressing the Shift key. To select multiple still images not in a sequence, click the images individually while pressing the Ctrl key.
- You can also print from an image preview.

## Registering a browsing folder

The Picture Motion Browser does not allow you to view images saved on the PC hard disk directly. You must first register the browsing folder as follows:

- 1 Click “File”-“Register Viewed Folder”, or click  . The “Register Folders to View” dialog box is displayed.
- 2 Select the folder you want to register and then click “Register”.

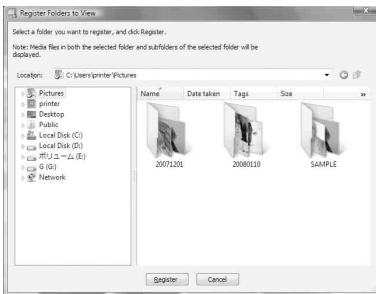

### Note

You cannot register the whole drive.

The confirmation dialog box used for registration is displayed.

- 3 Click “Yes”. Registration of the image information in the data base starts.

- 4 Click “Close”.

## Notes

- The folder you select as the destination of the imported images will be registered automatically.
- You cannot cancel registration of the folder you register here.

## To change the browsing folder

Click “Tools” - “Settings” - “Viewed folders”.

## Tips

- If a sub folder is contained in the source folder, the images in the sub folder will also be registered.
- When the software is first started, a message prompting you to register “Pictures” will be displayed.
- Depending on the number of images, it may take some tens of minutes to register images.

## Stopping printing

- 1 Double-click on the printer icon on the taskbar, and open the “Print” dialog box.
- 2 Click the document name that you want to cancel printing of and then click “Cancel” from the “Document” menu.  
The dialog box used for confirming the deletion is displayed.
- 3 Click “Yes”.  
The printing job is canceled.

### Note

Do not remove the job being printed. Doing so may cause a paper jam.

## Printing from a commercially-available software application

You can use a commercially-available software application to print an image from the DPP-FP65/FP75. Select “DPP-FP65” or “DPP-FP75” as a printer in the print dialog box, and select the print paper size in the page setup dialog box. For details of print settings, see steps 5 and 7 on pages page 40 and 41.

### On the “Borderless Print” setting in “Printer Features”

When using an application other than the Picture Motion Browser, an image might be printed with borders even if you select “ON” for “Borderless Print” in “Printer Features” of the “Sony DPP-FP65/75 Advanced Options” dialog box.

When you select the borderless print option, the printing range information for borderless printing will be supplied to the application. Some applications, however, may arrange and print the image with borders within the specified range.

If this occurs, do the following to print an image without borders:

- When you can set the print range with an application, set an image to be printed fully within the available print range. For example, select “Full page photo print” or a similar option.

### Orientation setting

Depending on the software application you use, orientation may not change even if you change portrait or landscape setting.

### With the Borders/Borderless setting of the printer driver





When the software application you use has Borders/Borderless setting, we suggest you select “ON” for “Borderless Print” in “Printer Features” of the “Sony DPP-FP65/75 Advanced Options” dialog box as the printer driver setting.







### Print quantity setting

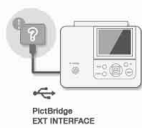

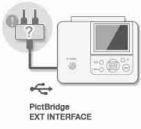

Depending on the software application you are using, the print quantity setting of the application may have priority over the setting specified in the printer driver dialog box.

## If an error display appears

If an error occurs, the following error display may appear on the LCD screen. Follow the solution described here to solve the problem.

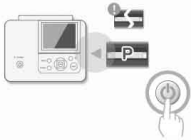
Error display	Meaning/Solutions
	<p>→ There are no image files on the memory card or a USB memory that the printer can handle. Connect a memory card or device that contains images that can be displayed with the printer.</p>
	<p>→ There are no DPOF-preset image files on the memory card or a USB memory. Specify the print (DPOF) mark with your camera.</p>
	<p>→ The image may be an incompatible file such as a JPEG file created with your computer, or a compatible file that does not contain thumbnail, portion of an image file for displaying. Select the mark in the image list and press ENTER to display its image preview. If an image is displayed, you can print the image. If the same mark is displayed again, the image is in an incompatible file format and you cannot print it with the printer.</p>
	<p>→ The image is in a compatible file format but its thumbnail data or the data itself cannot be opened. Select the mark in the image list and press ENTER to display its image preview. If an image is displayed, you can print the image. If the same mark is displayed again, you cannot print it with the printer.</p>
	<p>→ A USB device that the printer does not support may be connected. Or, the USB settings of the connected device may be incompatible. Refer to the operating instructions of the USB device you are using.</p>

Error display	Meaning/Solutions
 <p>PictBridge EXT INTERFACE</p>	<p>→ The printer does not support a USB hub or a drive with a built in USB hub. Connect the device directly to the printer or use a device that does not contain a USB hub function.</p>
 <p>M.S./xD/SD</p>	<p>→ An incompatible memory card is inserted. Use a memory card or a USB memory that the printer supports. (→ pages 61 to 63)</p>
 <p>M.S./xD/SD</p>	<p>→ An error may have occurred with a memory card or a USB memory. If these messages appear frequently, check the memory card or a USB memory status with another device.</p>
	<p>→ No ink ribbon is inserted in the printer. Insert an ink ribbon of the displayed size as follows and press PRINT. (→ page 9) – P: P size ink ribbon</p>
	<p>→ The ink ribbon has run out. Insert a new ink ribbon of the displayed size as follows and press PRINT. (→ page 9) – P: P size ink ribbon</p>
	<p>→ The wrong ink ribbon is inserted. Do not use the size struck through, but set the displayed size as follows and press PRINT. (→ page 9) – P: P size ink ribbon</p>

Error display	Meaning/Solutions
	<p>→ The ink ribbon is stuck.</p> <p>Unplug the AC power cord of the printer, connect it again.</p> <p>When the printer motor is stopped, remove the ink ribbon and insert a new ink ribbon. If you cannot remove the ink ribbon, consult with your Sony dealer or Sony service facilities.</p>
	<p>→ No print paper or cleaning sheet is set in the paper tray. Set the print paper of the displayed size as follows in the paper tray, insert the paper tray into the printer, and then press PRINT. (→ page 10)</p> <ul style="list-style-type: none"> <li>– P: P size print paper</li> <li>– C: Cleaning sheet (→ page 59)</li> </ul>
	<p>→ The wrong print paper or cleaning sheet is set in the paper tray. Set the print paper of the displayed size as follows in the paper tray, insert the paper tray into the printer, and then press PRINT. (→ page 10)</p> <ul style="list-style-type: none"> <li>– P: P size print paper</li> <li>– C: Cleaning sheet (→ page 59)</li> </ul>
	<p>→ Paper jams. See “If paper jams” (→ page 58) and remove jammed paper from the printer. If the jammed paper cannot be removed, contact the nearest Sony service facilities.</p>
	<p>→ No paper tray is inserted in the printer. Set the print paper or cleaning sheet into the paper tray, insert the paper tray into the printer, and then press PRINT. (→ page 10)</p>

## If trouble occurs

If you run into any problems using the printer, use the following guidance to solve the problem. If the problem persists, consult your Sony dealer.

### Power

Symptom	Check	Cause/Solutions
The printer cannot be turned on	<ul style="list-style-type: none"> <li>Is the AC power cord properly connected?</li> </ul>	<ul style="list-style-type: none"> <li>→ Connect the AC power cord to an AC outlet securely. (→ page 12)</li> </ul>

### Displaying images

Symptom	Check	Cause/Solutions
The LCD screen displays no images.	<ul style="list-style-type: none"> <li>Is the memory card or a USB memory properly inserted?</li> </ul>	<ul style="list-style-type: none"> <li>→ Insert a memory card or connect a USB memory properly. (→ page 16, 30)</li> </ul>
	<ul style="list-style-type: none"> <li>Does the memory card or a USB memory contain images recorded with a digital camera or other device?</li> </ul>	<ul style="list-style-type: none"> <li>→ Insert a memory card or connect a USB memory that contains the recorded images.</li> <li>→ Check the file formats that can be printed with the printer. (→ page 63)</li> </ul>
	<ul style="list-style-type: none"> <li>Is the file format compatible with the DCF?</li> </ul>	<ul style="list-style-type: none"> <li>→ If an image is not compatible with the DCF, it may not be printed with the printer even if it is displayed on the PC monitor.</li> </ul>
Some images in the image list are not displayed or not printed even if they are displayed.	<ul style="list-style-type: none"> <li>Are thumbnail images displayed in the image list (index)?</li> </ul>	<ul style="list-style-type: none"> <li>→ If the image is displayed but cannot be printed, the file used for printing is damaged.</li> <li>→ If an image is not compatible with DCF (Design rule for Camera File system), it may not be printed with the printer even if it is displayed on the PC monitor.</li> </ul>
	<ul style="list-style-type: none"> <li>Are there more than 999 images saved in the memory card or a USB memory?</li> </ul>	<ul style="list-style-type: none"> <li>→ The printer can display, or handle up to 999 image files. If there are more than 999 images stored on a memory card or a USB memory, use the PC or PictBridge mode to display and handle the remaining images.</li> </ul>
	<ul style="list-style-type: none"> <li>Did you name or rename an image file with your PC?</li> </ul>	<ul style="list-style-type: none"> <li>→ When you name or rename an image file on your computer and its file name includes characters other than alphanumeric characters, the file name may not be displayed correctly or the image may not be displayed on the printer.</li> </ul>



Symptom	Check	Cause/Solutions
Some images in the image list are not displayed or not printed even if they are displayed.	<ul style="list-style-type: none"> <li>• There are 7 or more hierarchies on the memory card or a USB memory.</li> </ul>	<ul style="list-style-type: none"> <li>→ The printer cannot display images saved in a folder of the 7th or higher hierarchy.</li> </ul>
The file name is not displayed correctly.	<ul style="list-style-type: none"> <li>• Did you change the file name of the image with your PC?</li> </ul>	<ul style="list-style-type: none"> <li>→ When you name or rename an image file on your computer and its file name includes characters other than alphanumeric characters, the file name may not be displayed correctly. For a file created with a PC application, the first 8 characters of its file name will be displayed as the file name.</li> </ul>
In the Edit menu, there are blank areas at the top and bottom of the previewed image.	<ul style="list-style-type: none"> <li>• Is the previewed image extremely stretched vertically or horizontally?</li> </ul>	<ul style="list-style-type: none"> <li>→ If an image is extremely stretched vertically or horizontally, blank areas may appear in the Edit menu.</li> <li>→ The standard aspect ratio of an image shot with a digital camera is 3:4. When you use a recording/editing device other than the printer to edit and save an image, the image is often saved as a printing image wider than 3:4 aspect ration. In the image list, those images are displayed with upper and edges cut and displayed in black.</li> </ul>



## Printing

Symptom	Check	Cause/Solutions
Paper does not feed.	<ul style="list-style-type: none"> <li>• Is the print paper properly set in the paper tray?</li> </ul>	<p>→ If print paper is not properly loaded, the printer may develop trouble. (➡ page 9, 10)</p> <p>Check the following:</p> <ul style="list-style-type: none"> <li>• Insert the correct set of print paper and ink ribbon.</li> <li>• Load the print paper in the correct direction in the tray.</li> <li>• You can insert a maximum of 20 sheets of print paper into the tray. If the sheets exceed 20, remove the extra sheets.</li> <li>• Riffle the print paper thoroughly and insert it into the tray.</li> <li>• Do not bend or fold the print paper before printing, as this may cause malfunctions of the printer.</li> </ul>
	<ul style="list-style-type: none"> <li>• Are you using print paper that was not designed for the printer?</li> </ul>	<p>→ Use print paper designed for the printer. If you use incompatible print paper, the printer may develop trouble. (➡ About the Print Pack)</p>
The print paper is ejected without being printed.	<ul style="list-style-type: none"> <li>• Is this perforations of the print paper removed?</li> <li>• Are you using print paper that was not designed for the printer?</li> </ul>	<p>→ Use print paper designed for the printer. If you use incompatible print paper, the printer may develop trouble. (➡ About the Print Pack)</p>

## Printed results

Symptom	Check	Cause/Solutions
The printed pictures are inferior in quality.	<ul style="list-style-type: none"> <li>• Did you print preview image data?</li> </ul>	<p>→ Depending on the type of digital camera used, preview images may be displayed along with the primary images in the thumbnail list. The printed quality of the preview images will not be as good as the primary images. Note that if you delete the preview images, the data for the primary images may be damaged.</p>
	<ul style="list-style-type: none"> <li>• Did you print an image whose size (width or height) is smaller than 480 dots? Is the thumbnail image displayed properly?</li> </ul>	<p>→ If a thumbnail image is not displayed properly, it is a small image. The printing quality is rough due to this small image size.</p>
	<ul style="list-style-type: none"> <li>• Did you use the Edit menu to enlarge the image?</li> </ul>	<p>→ An enlarged image, depending on its image size, will be printed with deteriorated picture quality.</p>
	<ul style="list-style-type: none"> <li>• Did you shoot an image in the RAW file format?</li> </ul>	<p>→ When you shoot an image in the RAW file format, a highly-compressed JPEG file may be also recorded. As the printer does not support the RAW file format, it may use the JPEG file to print an image. A RAW file can be printed from a PC. For details, see the operating instructions of the digital camera you are using.</p> <p><b>What is a RAW file?</b> A RAW file is an original image file format to save uncompressed, unprocessed still image data captured from a digital camera.</p> <p>For whether or not a digital camera can capture an image in the RAW file format, see the operating instructions of the digital camera.</p>

Symptom	Check	Cause/Solutions
The picture quality and colors of the image previewed on the screen differs from those printed.	—	<p>→ Because of differences in the display method or profiles of an LCD screen, please regard the image being displayed on the display as just a reference. To adjust picture quality, do either of the following:</p> <ul style="list-style-type: none"> <li>– Changing the Color Setting (→ page 28)</li> <li>– Adjusting an image (→ page 21)</li> </ul> <p>The settings take effect on the displayed images only.</p>
The printed image differs when an image is printed directly from the memory card inserted into the printer's slot and when it is printed via a PC.	—	<p>→ Because of the differences in the printer's internal processing and PC software processing, the printed images will be different.</p>
The date cannot be printed.	• Is "Date Print" set to "ON"?	→ Set "Date Print" to "ON". (→ "Setting the Date Print" on page 26)
	• Does the image support DCF?	→ The "Date Print" function of this unit supports an image that is compatible with the DCF standards.
The date is printed unintentionally.	• Is "Date Print" set to "OFF"?	→ Set "Date Print" to "OFF". (→ "Setting the Date Print" on page 26)
	• Was the date saved with the image when it was shot with the digital camera?	→ If the date was saved with the image, you cannot make a print without a date.
The image cannot be printed fully in the print range. Borders remain.	• Did you select "Borders (Pattern 1)" or "Borders (Pattern 2)"?	→ Select "Borders". (→ "Setting the print finish (Borders/Borderless print)" on page 26)
	• Is the aspect ratio of the image correct?	→ Depending on the type of digital camera used, the aspect ratio of the recorded image differs, so the image may not be printed covering the entire printable area.

Symptom	Check	Cause/Solutions
Even if “Borderless” is selected, the image is printed with borders on both sides.	—	→ When you use an editing/recording device other than the printer to edit or save an image, the image is saved with blank areas around the image. Even if you print it with the “Borderless” setting, you cannot eliminate the borders on both sides of a print.
The whole area of an image cannot be printed.	• Did you select “Borders (Pattern 1)”?	→ You can print the whole area of an image by selecting “Borders (Pattern 1)”. (→ “Setting the print finish (Borders/Borderless print)” on page 26)
The image is printed at an angle.	• Is the paper tray inserted properly?	→ Re-insert the paper tray firmly straight in to the end.
There are white lines or dots on the printed pictures.	—	→ The print head or paper path may be soiled. Use the supplied cleaning cartridge and sheet to clean the head and path.
The picture is too bright, dark, reddish, yellowish, or greenish.	—	→ You can adjust the image. (→ “Adjusting an image” on page 21)
The Edit menu cannot be used.	• Did you enlarge, reduce the size of, rotate, or move an image after performing Red-eye Correction with the  button?	→ You cannot use the Edit menu after performing Red-eye Correction with the  button. Select the Edit menu and perform these editorial operations first, and then perform Red-eye Correction.

## Settings

Symptom	Check	Cause/Solutions
The Borders/Borderless setting does not take effect.	• Are you using the Layout Print menu?	→ In the Layout Print menu, templates are used and you cannot select Borders/Borderless Print.

## Others

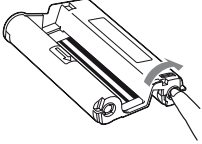
Symptom	Check	Cause/Solutions
You cannot insert the ink ribbon smoothly.	—	<p>→ If the ink ribbon does not click into place, remove it and then re-insert it. Only when the ink ribbon is too slack to be loaded, wind the ink ribbon in the direction of the arrow to remove the slack. (→ page 9)</p> 
The ink ribbon cannot be removed.	—	<p>→ Turn off the printer using the ⏻ (on/standby) button and then turn it on again. After the motor sound stops, try to remove the ink ribbon. If this does not solve the problem, contact Sony service facilities or your Sony dealer.</p>

## Connecting with a digital camera or other external device

Symptom	Check	Cause/Solutions
The PictBridge mark does not appear on the LCD screen of the digital camera.	• Is the digital camera connected correctly?	→ Connect the cable correctly.
	• Is the ⏻ (on/standby) button turned on?	→ Turn on the ⏻ (on/standby) button.
	• Does your digital camera support PictBridge?	→ See the manual supplied with your camera, or consult with the manufacturer.
	—	→ Is a memory card inserted in a slot of the printer? If there is a memory card inserted, remove it.
	• Is the USB setting of your camera in PictBridge mode?	→ Set the USB setting of your camera to the PictBridge mode.
You connect and disconnect the USB cable, but nothing happens.	—	→ The printer has developed an over-current error. Unplug the AC power cord of the printer, plug it in again, and then press the ⏻ (on/standby) button to recover from the error.
You cannot stop printing even if you pressed CANCEL.	—	→ The next print from the one currently printed will be canceled. → Depending on the digital camera you are using, you cannot cancel printing from the printer. Operate the digital camera to stop printing. Refer to the operating instructions of the digital camera.
You cannot make Index prints	—	→ The printer cannot print Index prints during DPOF printing. To make Index prints, insert the memory card directly (→ page 25).

## Connecting with a computer

Symptom	Check	Cause/Solutions
The images on the memory card or a USB memory inserted in the printer are not displayed on the PC.	—	→ The printer does not provide a function for viewing the memory card or a USB memory images from the printer.
You lost the supplied CD-ROM and want to obtain a new one.	—	→ Please download the printer driver from the Customer support home page (➡ page 65). Or contact your Sony dealer.
The printer driver cannot be installed.	• Are you sure that you have followed the installation procedures correctly?	→ Follow the procedures in the operating instructions to install the driver (➡ page 35). If an error occurs, restart your computer and perform the installation procedures again.
	• Is another application program running?	→ Exit all applications and then install the driver again.
	• Did you specify the CD-ROM as the installation CD-ROM correctly?	→ Double-click My Computer and then the CD-ROM icon in the open window. Follow the procedures in the operating instructions to install the driver.
	—	→ The USB driver may not be installed properly. Follow the operating instructions to install the USB driver again.
	• Is there an anti-virus program or other program running on the system?	→ If there is an anti-virus program or other program running on the system, exit it and then start installing the driver.
	• Did you log on using an Administrator user account?	→ To install the driver, you must log onto Windows using an Administrator user account.



Symptom	Check	Cause/Solutions
The printer does not respond to the printing order from the PC.	—	<p>→ If there is no trouble displayed on the Windows desktop, check the printer's LCD screen.</p> <p>If the printer shows trouble, do the following:</p> <ol style="list-style-type: none"> <li>1. Turn off the ⏻ (on/standby) button of the printer.</li> <li>2. Disconnect the power cable, wait for 5 to 10 seconds, and then connect the cable again.</li> <li>3. Restart your computer.</li> </ol> <p>If these do not solve the problem, consult your Sony dealer or service facilities.</p>
An image is printed with borders even if I select "Borderless".	<ul style="list-style-type: none"> <li>• Are you using an software application other than Picture Motion Browser?</li> </ul>	<p>→ When using an application other than the Picture Motion Browser, an image might be printed with Borders even if you select Borderless Print.</p> <p>If you can set Borders/Borderless with an application, set an image to be printed fully in the print range even if it is printed over the range.</p>
The print quantity specified in "Pages Per Sheet" on the "Layout" tab of the "Sony DPP-FP65/FP75 Properties" dialog box does not match the actual print quantity and printed results.	—	<p>→ Depending on the application you are using, the print quantity setting of the application may have priority over the setting specified in the printer driver dialog box.</p>
Colors of the printed image from a PC are different from those printed from a memory card.	—	<p>→ Since the process used in printing an image from a memory card differs from that used in printing from a PC, the colors may not be exactly identical.</p>

# If paper jams

- 1** Turn off the power of the printer and then turn it on again.  
Please wait for the print paper to be ejected automatically.

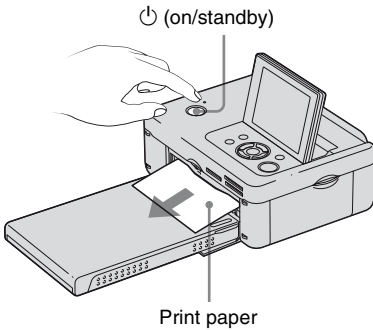

- 2** Remove the ejected print paper from the printer.
- 3** Remove the paper tray and ink ribbon from the printer and check to ensure if there is no jammed print paper inside.

Check to see if there is jammed paper. If there is, remove it.

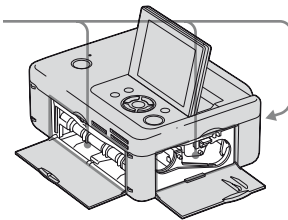

## Note

If you cannot remove the jammed paper, contact your Sony dealer.

# Cleaning

If white lines or period-like dots are printed on the pictures, use the cleaning cartridge and cleaning sheet supplied to clean inside the printer.

Before you start cleaning the printer, please remove any memory cards, USB memories, or USB cables from the printer.

- 1 Open the ink ribbon compartment door and if there is an ink ribbon inserted, remove it.
- 2 Insert the supplied cleaning cartridge into the printer and close the ink ribbon compartment door.

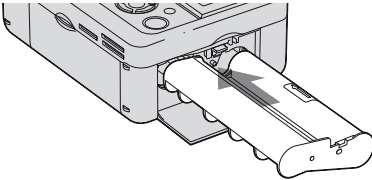

- 3 Remove the paper tray from the printer. If there is print paper in the tray, remove it.
- 4 Place the cleaning sheet into the paper tray **with the no-imprint side facing up**.

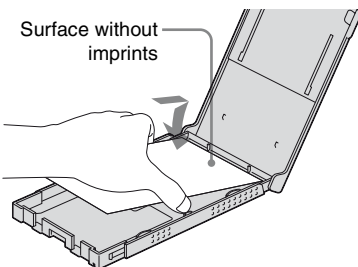

- 5 Set the paper tray into the printer and press PRINT.  
The cleaning cartridge and cleaning sheet will clean inside the printer. After the cleaning is finished, the cleaning sheet is automatically ejected.
- 6 Remove the cleaning cartridge and sheet from the printer.

## Tip

Keep the cleaning cartridge and cleaning sheet together for future cleanings.

## Notes

- If you already enjoy proper printing performances, cleaning will not improve the printed picture quality.
- Do not place the cleaning sheet on top of print paper and carry out cleaning, as this may cause a paper jam or other troubles.
- If a cleaning does not improve printed picture quality, please carry out the cleaning process a couple of times.
- You cannot clean the printer while it is connected to a PC or a PictBridge camera.

# Precautions

## On safety

- Be careful not to set or drop any heavy objects on the power cord, or to damage the power cord in any way. Never operate this printer with a damaged power cord.
- Should any solid object or liquid fall into the cabinet, unplug the printer and have it checked by qualified personnel before operating it any further.
- Never disassemble the printer.
- To disconnect the power cord, pull it out by the plug. Never pull the power cord itself.
- When the printer is not going to be used for an extended period of time, disconnect the power cord from the wall outlet.
- Do not handle the printer roughly.
- To reduce the risk of electrical shock, always unplug the printer from the electrical outlet before cleaning and servicing the printer.

## On installation

- Avoid placing the printer in a location subject to:
  - vibration
  - humidity
  - excessive dust
  - direct sunlight
  - extremely high or low temperatures
- Do not use electrical equipment near the printer. The printer will not work properly in electromagnetic fields.
- Do not place heavy objects on the printer.
- Leave enough room around the printer so that the ventilation holes are not blocked. Blocking these holes may cause internal heat build-up.

## On the AC adaptor

- Be sure to use the AC adaptor supplied with the printer. Do not use other AC adaptors, as this may cause a malfunction.
- Do not use the supplied AC adaptor for other devices.
- In case the cord of the AC adaptor is damaged, do not use it any longer, as this may be dangerous.

## On moisture condensation

If the printer is brought directly from a cold location to a warm location or placed in an extremely warm or humid room, moisture may condense inside the unit. In such cases the printer will probably not work properly and may even develop a fault if you persist in using it. If moisture condensation occurs, unplug the AC power cord of the printer and do not use the printer for at least one hour.

## On transport

When you transport the printer, remove the ink ribbon, paper tray, AC adaptor, the memory card, or a USB memory from the printer and put the printer and its peripherals in the original box with the protective packaging.

If you no longer have the original box and packing parts, use similar packing material so that the printer will not be damaged while being transported.

## On cleaning

Clean the cabinet, panel, and controls with a soft dry cloth, or a soft cloth lightly moistened with a mild detergent solution. Do not use any type of solvent, such as alcohol or benzene, which may damage the finish.

## On restrictions on duplication

When duplicating documents with the printer, pay special attention to the following:

- Duplication of banknotes, coins, or securities is against the law.
- Duplication of blank certificates, licenses, passports, private securities, or unused postal stamps is also against the law.
- TV programs, films, video tapes, portraits of other people or other materials may be copyrighted. Unauthorized video printing of such materials may infringe the provisions of the copyright law.

## About the Memory Cards

### “Memory Stick”

#### Types of “Memory Stick” that the printer can use

With the printer, you can use the following types of “Memory Stick”<sup>\*1</sup>:

Type of “Memory Stick”	Displaying/ Printing
“Memory Stick” <sup>*2</sup> (Not compatible with “MagicGate”)	OK
“Memory Stick” <sup>*2</sup> (“MagicGate” Compatible)	OK <sup>*5</sup>
“MagicGate Memory Stick” <sup>*2</sup>	OK <sup>*5</sup>
“Memory Stick PRO-HG” <sup>*2</sup>	OK <sup>*5*6</sup>
“Memory Stick PRO” <sup>*2</sup>	OK <sup>*5</sup>
“Memory Stick Micro” <sup>*3</sup> (“M2” <sup>*4</sup> )	OK <sup>*5</sup>

<sup>\*1</sup> The printer supports FAT32. The printer has been demonstrated as operable with a “Memory Stick” with a capacity of 8GB or less manufactured by Sony Corporation. However, we do not guarantee the operations of all the “Memory Stick” media.

<sup>\*2</sup> The printer is equipped with a slot compatible with both standard-size and Duo-size media. Without a Memory Stick Duo adaptor, you can use both a standard-size “Memory Stick” and the compact-size “Memory Stick Duo”.

<sup>\*3</sup> When using a “Memory Stick Micro” with the printer, always insert it into an M2 adaptor.

<sup>\*4</sup> “M2” is an abbreviation for “Memory Stick Micro”. In this section, “M2” is used to describe “Memory Stick Micro”.

<sup>\*5</sup> Data reading that requires “MagicGate” copyright protection cannot be performed. “MagicGate” is the general name of a copyright protection technology developed by Sony using authentication and encryption.

<sup>\*6</sup> The printer does not support 8 bit parallel data transfer.

## Notes on use

- For the latest information on the “Memory Stick” types that the printer supports, see the “Memory Stick” compatibility information on the Sony web site:

<http://www.memorystick.com/en/support/support.html>

(Select the area where you use your printer, and then select “Digital Printer” from each area page.)

- Do not insert more than one “Memory Stick” at the same time, which may cause trouble with the printer.
- If you insert a “Memory Stick Micro” into the printer without an “M2” adaptor, you may be unable to remove the “Memory Stick Micro”.
- If you insert a “Memory Stick Micro” into an “M2” adaptor, and insert the “M2” adaptor into a “Memory Stick Duo” adaptor, the printer may not operate properly.
- When you format a “Memory Stick”, use the format function of your digital camera. If you format a “Memory Stick” with your computer, images may not be displayed properly.
- When you format a “Memory Stick”, all the data including protected image files will be erased. To avoid erasing important data by accident, make sure to check the contents of the “Memory Stick” before formatting.

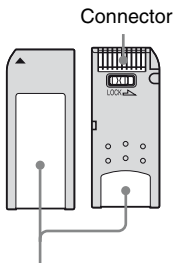

Place the label here.

- Do not attach any other material than the supplied label on the labelling position. When you attach the supplied label, be sure

to attach it to the labelling position. Be careful that the label does not stick out.

## SD Memory Card

The SD Memory Card slot of the printer allows you to use the following:

- SD memory card\*<sup>1</sup>
- miniSD card, microSD card  
(An adaptor is necessary.)\*<sup>2</sup>
- SDHC memory card\*<sup>2</sup>
- MMC standard memory card\*<sup>3</sup>

We do not guarantee proper operations for all types of SD memory cards and MMC standard memory cards.

\*<sup>1</sup> The printer has been demonstrated as operable with an SD Memory Card with a capacity of 2 GB or smaller.

\*<sup>2</sup> The printer has been demonstrated as operable with an SDHC card with a capacity of 8 GB or less.

\*<sup>3</sup> The printer has been demonstrated as operable with an MMC standard memory card with a capacity of 2 GB or less.

## Notes on use

Data reading that requires copyright protection cannot be performed.

## xD-Picture Card

With the xD-Picture Card slot of the printer, you can use an xD-Picture Card\*<sup>5</sup>. Not all the memory card operations are supported and we do not guarantee proper operations for all types of xD-Picture Card.

\*<sup>5</sup> The printer has been demonstrated as operable with an xD-Picture Card with a capacity of 2 GB or less.

## Notes on using a memory card

- The printer cannot write, delete, or format on a memory card.
- When using a card, make sure to check the correct insertion direction of the card and the correct insertion slot.
- Do not remove a card or turn off the printer while the printer is reading or accessing data, or the access indicator is flashing. Otherwise, data may be rendered unreadable or erased.
- We recommend that you save a backup of important data.
- Data processed with the computer may not be printed with the printer.
- When you carry or store a card, put it in the case supplied with it.
- Do not touch the terminal of a card with your hand or a metal object.
- Do not strike, bends or drop a card.
- Do not disassemble or modify a card.
- Do not expose a card to water.
- Do not use or store a card under the following conditions:
  - Locations beyond the required operational conditions including locations such as the hot interior of a car parked in the sun and/or in the summer, the outdoors exposed to direct sunlight, or a place near a heater.
  - Humid locations or locations with corrosive substances present
  - Locations subject to static electricity or electrical noises

## Specifications

### ■ Printer

#### Printing method

Dye sublimation printing (Yellow/Magenta/Cyan 3 pass)

#### Resolution

300 (H) × 300 (V) dpi

#### Image processing per dot

256 levels of processing (8 bits each for Yellow/Magenta/Cyan)

#### Printing range

1 800 dots x 1 200 dots

#### Printing size

P (Post Card/4 × 6 inch) size:  
101.6 × 152.4 mm (maximum, borderless)

#### Printing time (per sheet)

Memory card<sup>\*1\*</sup>\*2\*3\*4 : Approx. 63 sec.  
PictBridge<sup>\*3\*5</sup>: Approx. 63 sec.  
Via PC<sup>\*6</sup>: Approx. 60 sec.

#### Input/Output connectors

USB (Full Speed) for PC connection  
PictBridge/EXT INTERFACE connector

#### Slots

“Memory Stick” slot  
SD Memory Card slot  
xD-Picture Card slot

#### Compatible image file formats

JPEG: DCF 2.0 compatible, Exif 2.21 compatible, JFIF<sup>\*7</sup>  
TIFF: Exif 2.21 compatible  
BMP<sup>\*8</sup>: 1, 4, 8, 16, 24, 32 bit Windows format

Some image file formats are not compatible.

#### Maximum number of pixels that can be handled

8 000(H) × 6 000(V) dots (Excluding Index Print)

#### File system

FAT12/16/32

## Image file name

DCF format, 8.3 format, less than 6th or higher hierarchy

## Maximum number of files that can be handled

999 files for a memory card/a USB memory

## Ink ribbon/Print Paper

See the supplied "About the Print Packs".

## LCD screen

LCD panel:

DPP-FP65: 6.0 cm (2.4 type) TFT drive

DPP-FP75: 8.8 cm (3.5 type) TFT drive

Total number of dots:

DPP-FP65: 112 320 (480 × 234) dots

DPP-FP75: 230 400 (320 RGB × 240) dots

## Power requirements

DC IN jack,  $\equiv$  24 V

## Power consumption

While printing: 72 W (maximum)

On standby mode: less than 1W

## Operating temperature

5 °C to 35 °C (41 °F to 95 °F)

## Dimensions

[DPP-FP65]

Height: Approx. 65 mm (2  $\frac{5}{8}$  inches)

Approx. 72 mm (2  $\frac{7}{8}$  inches)

(including LCD projecting parts)

Width: Approx. 180 mm (7  $\frac{1}{8}$  inches)

Depth: Approx. 137 mm (5  $\frac{1}{2}$  inches)

Approx. 148.5 mm (5  $\frac{7}{8}$  inches)

(including the handle)

[DPP-FP75]

Height: Approx. 66.8 mm (2  $\frac{3}{4}$  inches)

Width: Approx. 180 mm (7  $\frac{1}{8}$  inches)

Depth: Approx. 137 mm (5  $\frac{1}{2}$  inches)

Approx. 148.5 mm (5  $\frac{7}{8}$  inches)

(including the handle)

Depth when the paper tray is installed:

Approx. 316 mm (12  $\frac{1}{2}$  inches) longer than the above depth.

## Mass

DPP-FP65: Approx. 1.0 kg (2 lb 4 oz)

DPP-FP75: Approx. 1.1 kg (2 lb 7 oz)

(excluding the paper tray, ink ribbon, AC adaptor)

## Supplied accessories

See page 9 of "Operating Instructions" (this booklet)

## ■ AC adaptor AC-S2416

### Power requirements

~ 100 V to 240 V, 50/60 Hz, 1.2 A MAX

### Rated output voltage

$\equiv$  24 V, 1.6 A (Peak 3.0A, 9.2 s)

### Operating temperature

5 °C to 35 °C (41 °F to 95 °F)

### Dimensions

Approx. 60 × 30.5 × 122 mm

(2  $\frac{3}{8}$  × 1  $\frac{1}{4}$  × 4  $\frac{7}{8}$  inches) (w/h/d,

excluding protruding parts and cables)

### Mass

Approx. 300 g (11 oz)

Design and specifications are subject to change without notice.

\* The total number of sheets of P size print paper that the printer can print is estimated to be approximately 2,000. For the total number of sheets printed, please check "Printer information display" of the "Print setup" menu, by pressing the MENU button (page 29).

\*1: Print Settings: Borderless, No date print

\*2: When printing a photo (4.4 MB file size) taken by a Sony digital still camera containing effective picture elements of approximately 12,100,000 pixels or equivalent.

\*3: Time required from when the PRINT button is pressed to when printing is finished. (The printing time may vary depending on the equipment used, the size and format of image data, type of memory card, the settings of an application and operating conditions.)

\*4: When printing from a "Memory Stick PRO Duo" inserted in the printer's slot

\*5: Time from when the PRINT button on the OSD of a DSC-W200 digital camera, connected by a USB cable, is pressed to when the printing is finished, while printing via the camera.



- \*6: The time for data processing and transferring is excluded.
- \*7: Baseline JPEG with 4:4:4, 4:2:2, or 4:2:0 format
- \*8: You cannot print using the Picture Motion Browser.

**Customer support home page**  
 The latest support information is available at the following home page address:  
<http://www.sony.net/>

## Printing range

### P size

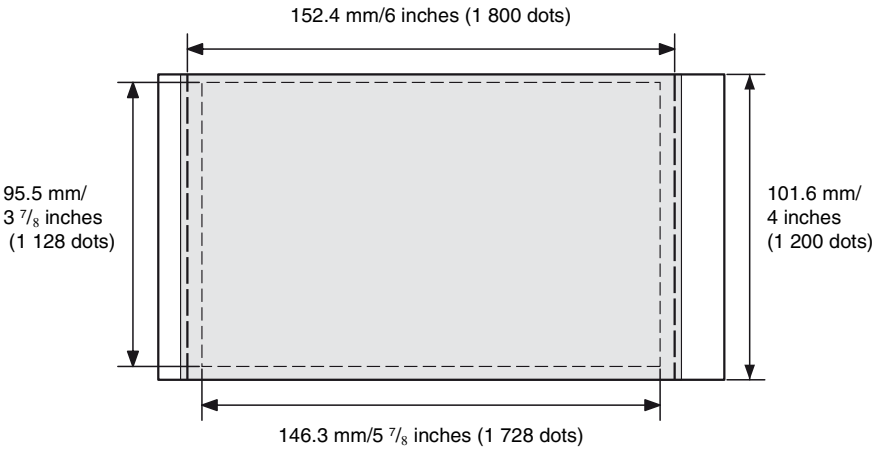

- Borders print range
- Borderless Print range
- Perforations

The above illustrations are those when an image with a 2:3 aspect ratio is printed.  
 The printing range differs for a border or a borderless print.

Additional information

---

# Glossary

## **DCF (Design rule for Camera File system)**

This printer conforms to the DCF (Design rule for Camera File system) standard established by JEITA (Japan Electronics and Information Technology Industries Association) to maintain file exchangeability and compatibility between digital cameras and related products. Complete exchangeability and compatibility, however, are not guaranteed.

## **DPOF (Digital Print Order Format)**

The format used to record the information necessary for automatically printing images shot by a digital camera at a printing shop or with a home-use printer. The printer supports DPOF printing and can automatically print the preset number of copies of the DPOF preset images.

## **Exif 2.21 (Exif Print)**

Exif (Exchangeable image file format for digital cameras) Print is a global standard for digital photo printing. A digital camera supporting Exif Print stores the data relevant to the conditions of shooting as each shot is taken.

## **“Memory Stick”/SD Memory Card/xD-Picture Card**

Compact, light, removable storage media. For details see pages 61 to 63.

## **PictBridge**

A standard specified by the Camera & Imaging Products Association that allows you to connect a PictBridge-complaint digital camera directly to the printer without a PC, enabling direct printing on the spot.

## **Thumbnails**

Miniature images for representing the original images that are stored in the image files taken by a digital camera. The printer uses thumbnails in the image list.

---

# Index

## A

AC power source 12  
Adjusting an image 21

## B

Batch Print 25  
Bluetooth device 32  
Borders/Borderless print 26, 42  
Brightness 22

## C

Cleaning 59  
Color settings 28  
Connecting  
    AC power source 12  
    Bluetooth device 32  
    Digital camera 31, 32  
    External device 31, 32  
    PC 36

## D

Date Print 26  
DC IN 24 V 12  
DPOF 13, 25

## E

Editing an image 21  
Ejecting a memory card 16  
Enlarging and reducing an image size 14, 21  
Error messages 45  
Exiting the menu 23  
External device 31, 32

## F

Front panel 7

## H

Handle 8

## I

Icons 15  
ID photo 24  
Image data display 13  
Image preview 13  
Index Print 25  
Index View 14  
Input indications 13  
Inserting a memory card 16  
Inserting an ink ribbon 9  
Inserting the print paper 10  
Installing  
    Picture Motion Browser 38  
    Printer driver 35

## L

Layout print 23  
LCD screen 8  
LCD screen display 13

## M

Memory Stick  
    Notes on use 62  
    Types 61  
Moving an image 21

## O

On/standby button 16, 30, 31, 32, 36  
On-screen Display 13, 27  
Orientation 41

## P

Paper jams 58  
Parts and controls 7  
PictBridge camera 31, 32  
PictBridge/EXT  
INTERFACE 30, 31, 32  
Picture Motion Browser 39  
Precautions 60  
Preview 13

Print All 25  
Print quantity 13, 14, 16, 22  
Printer information display 29

## Printing

    a memory card image 16  
    Edited image 22  
    Enlarged image 17  
    From a Bluetooth device 32  
    From a commercially available application 44  
    From a PC 34  
    From a PictBridge camera 31, 32  
    From an external device 33  
    ID photo 24  
    Layout print 23  
    Multiple images at one time 25  
    Using the Picture Motion Browser 39  
Printing range 65

## R

Rear panel 8  
Red-eye correction 20  
Registering a browsing folder 43  
Resetting operations 22  
Rotating an image 21

## S

Saturation 22  
Screen indications 13  
SD Memory Card  
    Notes on use 62  
    Types 62  
Setting the print quantity 16  
Sharpness 22  
Specifications 63

**Continued**

67 <sup>GB</sup>

Stopping printing 43  
Supplied accessories 9  
Switching the screen display  
14  
System requirement 34

## **T**

Tint 22  
Trimming Print 17  
Troubleshooting 48

## **U**

Uninstalling  
    Picture Motion Browser  
    39  
    Printer driver 37  
USB memory 30

## **V**

Various printing 18

## **X**

xD-Picture Card  
    Notes on use 62  
    Types 62

## **Z**

Zooming in/out 14, 21









Printed using VOC (Volatile  
Organic Compound)-free  
vegetable oil based ink.

Sony Corporation Printed in China



## Free Manuals Download Website

<http://myh66.com>

<http://usermanuals.us>

<http://www.somanuals.com>

<http://www.4manuals.cc>

<http://www.manual-lib.com>

<http://www.404manual.com>

<http://www.luxmanual.com>

<http://aubethermostatmanual.com>

Golf course search by state

<http://golfingnear.com>

Email search by domain

<http://emailbydomain.com>

Auto manuals search

<http://auto.somanuals.com>

TV manuals search

<http://tv.somanuals.com>