



Operating Instructions

© 2004 Sony Corporation

Owner's Record

The model and serial numbers are located at the rear of the projection TV, below the Sony logo, on the sticker, and also on the TV box (white label). Record these numbers in the spaces provided below. Refer to them whenever you call upon your Sony dealer regarding this product.

Model No. _____

Serial No. _____

WARNING

To reduce the risk of fire or electric shock, do not expose this apparatus to rain or moisture.

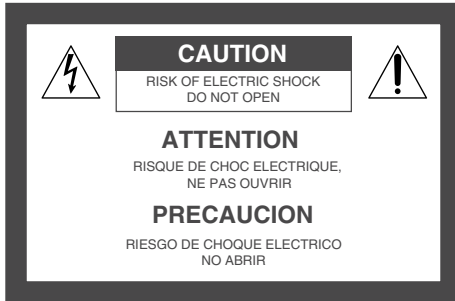

This symbol is intended to alert the user to the presence of uninsulated "dangerous voltage" within the product's enclosure that may be of sufficient magnitude to constitute a risk of electric shock to persons.



This symbol is intended to alert the user to the presence of important operating and maintenance (servicing) instructions in the literature accompanying the appliance.

Do not expose the TV to dripping or splashing. Avoid placing liquid-filled objects, such as vases, on top of the TV.

CAUTION

To prevent electric shock, do not use this polarized AC plug with an extension cord, receptacle or other outlet unless the blades can be fully inserted to prevent blade exposure.

CAUTION

If a fixed (non-moving) pattern, such as a station logo, is left on the screen for long periods of time, especially at a high brightness or picture setting, the image can be permanently imprinted onto the screen. These types of imprints are known as "image retention."

How to Reduce the Risk of "Image Retention" on the Screen

Please take the following steps to reduce the risk of causing image retention:

- When using video games, computers, and similar products with your projection TV, or viewing a TV station whose logo always stays on the screen, keep the Brightness and Picture functions at low settings. (See page 62 for instructions on adjusting Brightness and Picture settings.)
- View a variety of programming material. Changing the program material viewed reduces the possibility that a single image will become imprinted on the screens.
- This TV was designed primarily for viewing TV broadcasts in wide screen mode (16:9 aspect ratio). Therefore when viewing conventional (4:3) aspect ratio TV programs, select Wide Mode settings that fill the image on your screen. This will reduce the possibility of the gray sidebars becoming permanently imprinted.

Please see page 62 for instructions on adjusting picture settings. See pages 53-54 for information about using Wide Mode.

IMAGE RETENTION IS NOT COVERED BY YOUR WARRANTY



As an ENERGY STAR® Partner, Sony has determined that this product or product models meets the ENERGY STAR guidelines for energy efficiency. ENERGY STAR is a U.S. registered mark.

Note on Caption Vision

This television receiver provides display of television closed captioning in accordance with §15.119 of the FCC rules.

Note on Convergence Adjustment

Before you use your projection TV, make sure to adjust convergence. For details, see "Adjusting the Convergence Automatically (Flash Focus)" on page 40.

Use of this television receiver for other than private viewing of programs broadcast on UHF or VHF or transmitted by cable companies for the use of the general public may require authorization from the broadcaster/cable company and/or program owner.

NOTIFICATION

This equipment has been tested and found to comply with the limits for a Class B digital device, pursuant to Part 15 of the FCC Rules. These limits are designed to provide reasonable protection against harmful interference in a residential installation. This equipment generates, uses, and can radiate radio frequency energy and, if not installed and used in accordance with the instructions, may cause harmful interference with radio communications. However, there is no guarantee that interference will not occur in a particular installation. If this equipment does cause harmful interference to radio or television reception, which can be determined by turning the equipment off and on, the user is encouraged to try to correct the interference by one or more of the following measures:

- Reorient or relocate the receiving antenna.
- Increase the separation between the equipment and receiver.
- Connect the equipment into an outlet on a circuit different from that to which the receiver is connected.
- Consult the dealer or an experienced radio/TV technician for help.

You are cautioned that any changes or modifications not expressly approved in this manual could void your authority to operate this equipment.

Safety

- Operate the projection TV only on 120 V AC.
- The plug is designed, for safety purposes, to fit into the wall outlet only one way. If you are unable to insert the plug fully into the outlet, contact your dealer.
- If any liquid or solid object should fall inside the cabinet, unplug the projection TV immediately and have it checked by qualified service personnel before operating it further.
- If you will not be using the projection TV for several days, disconnect the power by pulling the plug itself. Never pull on the cord.
- For details concerning safety precautions, see "Important Safety Instructions" on page 3.

Installing

- To prevent internal heat buildup, do not block the ventilation openings.
- Do not install the projection TV in a hot or humid place, or in a place subject to excessive dust or mechanical vibration.
- Avoid operating the projection TV at temperatures below 5°C (41°F).
- If the projection TV is transported directly from a cold to a warm location, or if the room temperature changes suddenly, the picture may be blurred or show poor color due to moisture condensation. In this case, please wait a few hours to let the moisture evaporate before turning on the projection TV.

- To obtain the best picture, do not expose the screen to direct illumination or direct sunlight. It is recommended to use spot lighting directed down from the ceiling or to cover the windows that face the screen with opaque drapery. It is desirable to install the projection TV in a room where the floor and walls are not of a reflective material.

Trademark Information

TruSurround, SRS and the  symbol are trademarks of SRS Labs, Inc. TruSurround technology is incorporated under license from SRS Labs, Inc.

Licensed by BBE Sound, Inc. under USP4638258, 4482866. "BBE" and BBE symbol are trademarks of BBE Sound, Inc.

HDMI This TV incorporates High-Definition Multimedia Interface (HDMI™) technology. HDMI, the HDMI logo and High-Definition Multimedia Interface are trademarks or registered trademarks of HDMI Licensing LLC.

Steady Sound, Digital Reality Creation, CineMotion, and Twin View are registered trademarks of Sony Corporation. ClearEdge VM, and HD Detailer are trademarks of Sony Corporation.

For Safety

Be careful when moving the projection TV

When you place the projection TV in position, be careful not to drop it on your foot or fingers.

Watch your footing while installing the projection TV.

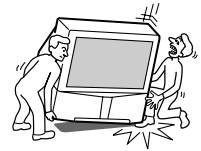

Carry the projection TV in the specified manner

If you carry the projection TV in a manner other than the specified manner and without the specified number of persons, it may drop and a serious injury may be caused. Be sure to follow the instructions mentioned below.

- Carry the projection TV with the specified number of persons (see "Carrying Your Projection TV" on page 10).
- Do not carry the projection TV holding the speaker grill.
- Hold the projection TV tightly when carrying it.

Important Safety Instructions

- 1 Read these instructions.
- 2 Keep these instructions.
- 3 Heed all warnings.
- 4 Follow all instructions.
- 5 Do not use this apparatus near water.
- 6 Clean only with dry cloth.
- 7 Do not block any ventilation openings. Install in accordance with the manufacturer's instructions.
- 8 Do not install near any heat sources such as radiators, heat registers, stoves, or other apparatus (including amplifiers) that produce heat.
- 9 Do not defeat the safety purpose of the polarized or grounding-type plug. A polarized plug has two blades with one wider than the other. A grounding type plug has two blades and a third grounding prong. The wide blade or the third prong are provided for your safety. If the provided plug does not fit into your outlet, consult an electrician for replacement of the obsolete outlet.
- 10 Protect the power cord from being walked on or pinched particularly at plugs, convenience receptacles, and the point where they exit from the apparatus.
- 11 Only use attachments/accessories specified by the manufacturer.
- 12 Use only with the cart, stand, tripod, bracket, or table specified by the manufacturer, or sold with the apparatus. When a cart is used, use caution when moving the cart/apparatus combination to avoid injury from tip-over.
- 13 Unplug this apparatus during lightning storms or when unused for long periods of time.
- 14 Refer all servicing to qualified service personnel. Servicing is required when the apparatus has been damaged in any way, such as power-supply cord or plug is damaged, liquid has been spilled or objects have fallen into the apparatus, the apparatus has been exposed to rain or moisture, does not operate normally, or has been dropped.



Additional Cleaning Instructions

Clean the cabinet of the projection TV with a dry, soft cloth. To clean the screen of your projection TV, please use only a clean, soft cloth lightly dampened with water. Stubborn stains such as fingerprints can be removed with a clean, soft cloth lightly dampened with a solution of mild soap and warm water. Never use alcohol or strong solvents (such as thinner, benzene, ammonia, or alcohol-based), or abrasive cleaning solutions to clean your TV screen.

If the picture becomes dark after using the projection TV for a long period of time, it may be necessary to clean the inside of the projection TV. Consult qualified service personnel.

Contents

Introducing the Projection TV

Welcome	7
Package Contents.....	7
Features	7

Setting Up the Projection TV

Overview	9
Carrying Your Projection TV	10
Positioning the TV	10
TV Controls and Connectors	11
Front Video Inputs	11
Front Panel	12
Rear Panel	12
Basic Connections: Connecting a Cable or Antenna	14
Cable or Antenna Only	15
Cable and Antenna Only	16
Cable Box and Cable Only	18
Cable Box Only	20
Connecting Optional Equipment	21
Making Video Connections	22
About Using S VIDEO	23
VCR and Cable	24
VCR and Cable Box	26
Satellite Receiver	28
Satellite Receiver and VCR	30
DVD Player with Component Video Connectors	32
DVD Player with S VIDEO and Audio Connectors	33
Camcorder	34
Audio Receiver	35
DVI-Equipped Device	36
HDMI-Equipped Device	37
Using the CONTROL S Feature	38
Setting Up the Channel List	39
Using Auto Program	39
Adjusting the Convergence Automatically (Flash Focus)	40
Notes on Flash Focus	40
Adjusting the Convergence Manually	41
Notes on Adjusting the Convergence Manually	42

Using the Remote Control

Overview	43
Inserting Batteries	43
Button Descriptions	44
Programming the Remote Control	46
Using Other Equipment with Your TV Remote Control	48
All Equipment.....	48
Operating a VCR	48
Operating a Satellite Receiver	48
Operating a Cable Box.....	49
Operating a DVD Player	49
Using the F1 and F2 Buttons.....	49

Using the Features

Overview	51
Watching TV	52
Using Wide Mode	53
Using Wide Mode with Standard Definition (480i/480p) Sources.....	53
Using Wide Mode with High-Definition (720p/1080i) Sources.....	54
Using Twin View	55
Displaying Twin Pictures	55
Factors Affecting Twin View	55
Activating the Picture	56
Changing the Picture Size.....	57
Using Favorite Channels	58
Creating a List of Favorite Channels.....	58
Displaying a List of Favorite Channels	58
Using the Freeze Function	59

Using the Menus

Overview	61
Navigating Through Menus	61
Using the Video Menu	62
Using the Audio Menu	64
Using the Screen Menu	66
Using the Channel Menu	67
Using the Parent Menu	69
Using the Setup Menu	72

Other Information

Overview	75
Glossary	76
Contacting Sony	77
Troubleshooting	77
Specifications	81
Optional Accessories	82
Index	83

Introducing the Projection TV

Welcome

This chapter describes the contents of the package in which the TV is shipped and provides an overview of the features of your projection TV.

Package Contents

Along with your new projection TV, the package contains a remote control and two AA batteries. No additional cables are included. These items are all you need to set up and operate the projection TV in its basic configuration.

Most components (VCRs, DVD players, etc.) come with the necessary cables to connect them. If you want to set up a complex system, you may need to buy extra cables, connectors, etc. Be sure to have these on hand before you start to connect your system.

Features

Some of the features that you will enjoy with your new TV include:

- ❑ **Wide Screen Mode:** Watch conventional 4:3 aspect ratio broadcasts in wide screen (16:9) mode.
- ❑ **DRC[®] (Digital Reality Creation) Multifunction:** Unlike conventional line doublers, the DRC Multifunction feature replaces the signal's NTSC waveform with the HD equivalent, while doubling the number of vertical and horizontal lines. This results in four times the density for quality sources, such as DVD, satellite, and digital camcorders. The Video Menu allows you to select interlaced, progressive, or CineMotion[™] output.
- ❑ **Favorite Channels:** Allows you to preview and select from 16 of your favorite channels.
- ❑ **Twin View[™]:** Using the Multi-Image Driver (MIDX), Twin View allows you to watch two programs side by side, with the ability to zoom in one picture. You can watch pictures from two different sources (1080i, 720p, 480p, and 480i) simultaneously. (Only the left Twin View window can display 1080i, 720p, and 480p sources.)
- ❑ **ClearEdge VM[™] Velocity Modulation:** Sharpens picture definition by enhancing vertical lines.
- ❑ **Steady Sound[®]:** Equalizes volume levels so there is consistent output between programs and commercials.

- ❑ **Component Video Inputs:** Offers high quality video for DVD (480p, 480i), and digital set-top box (HD1080i, 720p) connections.
- ❑ **HD Detailer™:** Wideband video amplifier has a high bandwidth frequency rating, which allows it to send more video information to the screen, resulting in finer picture quality, especially for HD sources.
- ❑ **CineMotion™:** Reverse 3-2 pulldown processing provides optimal picture quality for film-based sources (media originally shot in 24 frames-per-second format).
- ❑ **Parental Control:** V-Chip technology allows parents to block unsuitable programming from younger viewers.
- ❑ **HDMI (High-Definition Multimedia Interface):** Provides an uncompressed, all-digital audio/video interface between this TV and any HDMI-equipped audio/video component, such as a set-top box, DVD player, and A/V receiver. HDMI supports enhanced, or high-definition video, plus two-channel digital audio.

Setting Up the Projection TV

Overview

This chapter includes illustrated instructions for setting up your TV.

<i>Topic</i>	<i>Page(s)</i>
Carrying Your Projection TV/Positioning the TV	10
TV Controls and Connectors	11-13
Basic Connections: Connecting a Cable or Antenna	14-20
Connecting Optional Equipment	
VCR and Cable	24
VCR and Cable Box	26
Satellite Receiver	28
Satellite Receiver and VCR	30
DVD Player with Component Video Connectors	32
DVD Player with S VIDEO and Audio Connectors	33
Camcorder	34
Audio Receiver	35
DVI-Equipped Device	36
HDMI-Equipped Device	37
Using the CONTROL S Feature	38
Setting Up the Channel List	39
Adjusting the Convergence Automatically (Flash Focus)	40
Adjusting the Convergence Manually (Manual Convergence)	41

Carrying Your Projection TV

Carrying the TV requires four or more people.

Models KP-51/57WS520 provide casters. Be sure to move your projection TV using these casters.

Positioning the TV

Setup

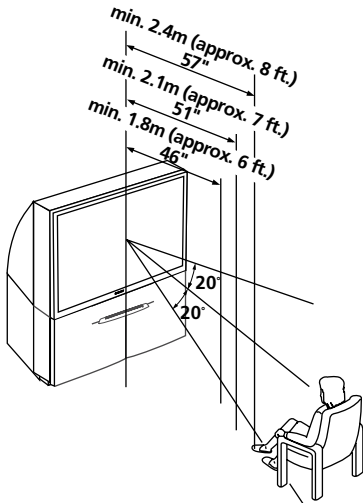

Recommended Vertical Viewing Angle

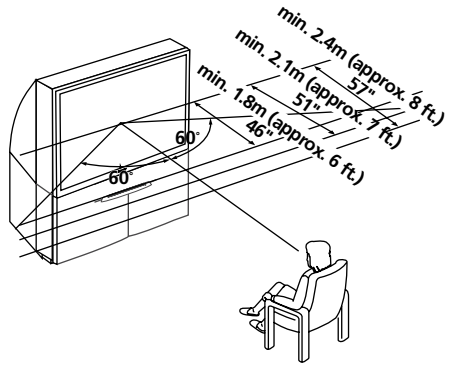

Recommended Horizontal Viewing Angle

TV Controls and Connectors

Model KP-46WT520 provides video inputs (Video 2) on the side. To access, push in and release as shown.

Models KP-51/57WS520 provide video inputs (Video 2) on the front. To access, push up and release as shown.

KP-46WT520

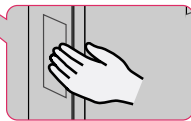
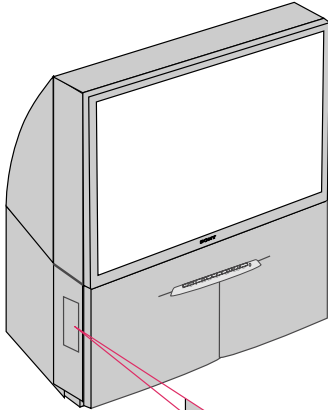

Push in
and release

KP-51/57WS520

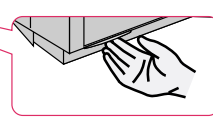
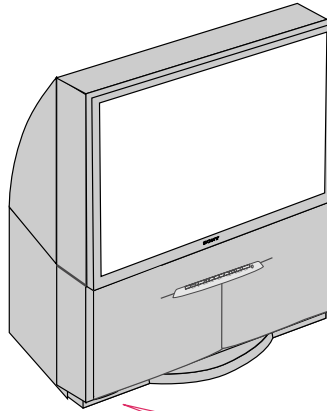

Push up
and release

Front Video Inputs

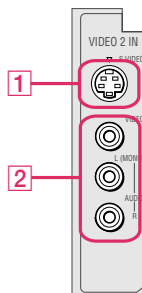

KP-46WT520

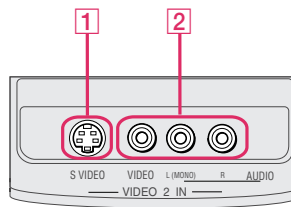

KP-51/57WS520

1 S VIDEO
VIDEO 2 INPUT

Connects to the S VIDEO OUT jack on your camcorder or other video equipment that has S VIDEO. Provides better picture quality than composite video (**2**).

2 VIDEO/L(MONO)-
AUDIO-R
VIDEO 2 INPUT

Connects to the composite A/V output jacks on your camcorder or other video equipment.

Front Panel

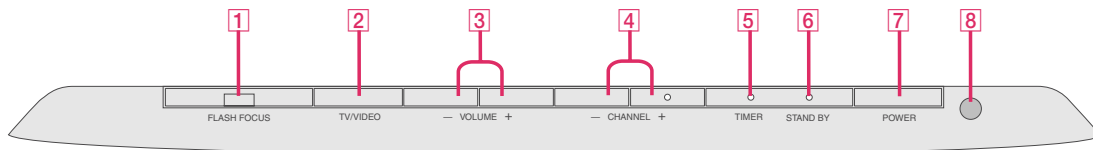

Item	Description
1 FLASH FOCUS	Press to adjust the convergence (see page 40).
2 TV/VIDEO	Press repeatedly to cycle through the video equipment connected to the TV's video inputs.
3 -VOLUME +	Press to adjust the volume.
4 -CHANNEL+	Press to scan through channels. To scan quickly through channels, press and hold down either CHANNEL button.
5 TIMER LED	When lit, indicates one of the timers is set. When the timer is set, this LED will remain lit even if the TV is turned off. For details, see page 73.
6 STAND BY LED	Blinks when the TV is turned on, then shuts off when the picture is displayed. If the LED blinks continuously, this may indicate the TV needs service (see "Contacting Sony" on page 77).
7 POWER	Press to turn on and off the TV.
8 Infrared Receiver (IR)	Receives IR signals from the TV's remote control.

Rear Panel

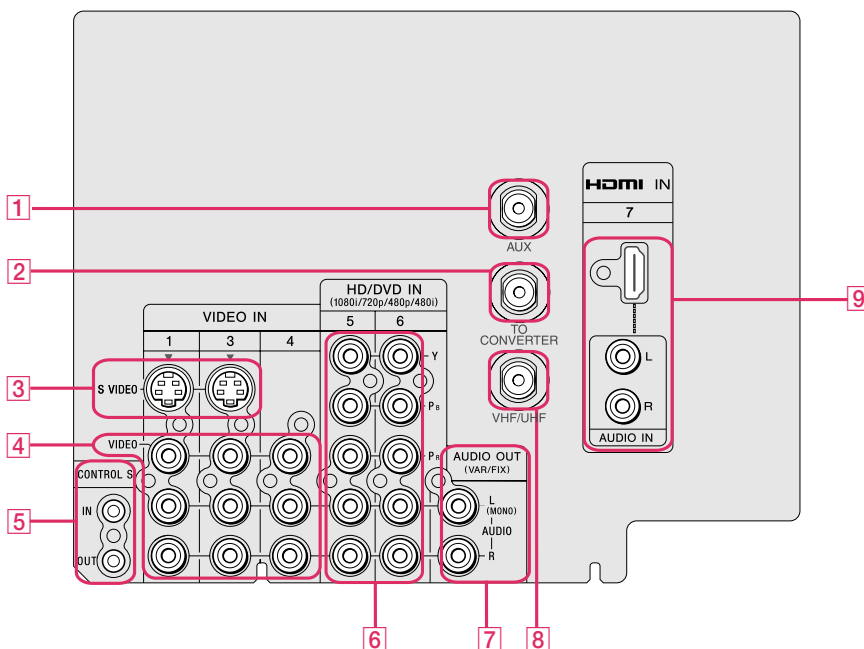

Jack	Description
1 AUX	Auxiliary RF input that connects to your antenna, CATV cable, or cable box output jack. This is convenient if you are using two VHF/UHF sources (antenna, CATV cable, or cable box). For details, see pages 16 to 19.
2 TO CONVERTER	Connects to your cable box input jack. This VHF/UHF output jack lets you set up your TV to switch between scrambled channels (coming through a cable box) and unscrambled cable channels. Use this jack instead of a splitter to get better picture quality when you need to switch between scrambled and unscrambled cable channels. For details, see pages 18 to 19.
3 S VIDEO IN 1/3	Connects to the S VIDEO OUT jack of your VCR or other video equipment that has S VIDEO. S VIDEO provides better picture quality than either composite video (4) or VHF/UHF (8) connections.
4 VIDEO IN 1/3/4 VIDEO/L(MONO) -AUDIO-R	Connect to the composite A/V output jacks on your VCR or other video component. A fourth component A/V input jack (VIDEO 2) is located on the front of the TV. These video connections provide better picture quality than the VHF/UHF (8) connections.
5 CONTROL S IN/OUT	Allows the TV to receive (IN) and send (OUT) remote control signals to other Sony infrared-controlled audio or video equipment that has the CONTROL S function.
6 HD/DVD IN 5/6 (1080i/720p/480p/480i)	Connect to your DVD player's or digital set-top box's component video (Y, PB, PR) and audio (L/R) jacks. Component video provides better picture quality than 3 , 4 , or 8 .
7 AUDIO OUT (VAR/FIX) L (MONO)/R	Connects to the left and right audio input jacks of your audio or video equipment. You can use these outputs to listen to your TV's audio through your stereo system.
8 VHF/UHF	Primary RF input that connects to your VHF/UHF antenna or cable box.
9 HDMI (VIDEO 7 IN)	HDMI (High-Definition Multimedia Interface) provides an uncompressed, all-digital audio/video interface between this TV and any HDMI-equipped audio/video component, such as a set-top box, DVD player, and A/V receiver. HDMI supports enhanced, or high-definition video, plus two-channel digital audio.

Basic Connections: Connecting a Cable or Antenna

The way in which you will connect your TV varies, depending on how your home receives a signal (cable, cable box, antenna) and whether or not you plan to connect a VCR.

<i>If You Are Connecting</i>	<i>See Page</i>
Cable or Antenna Only	15
<input type="checkbox"/> No cable box or VCR	
Cable and Antenna Only	16
<input type="checkbox"/> No cable box or VCR	
Cable Box and Cable Only	18
<input type="checkbox"/> Cable box unscrambles only some channels (usually premium channels)	
<input type="checkbox"/> No VCR	
Cable Box Only	20
<input type="checkbox"/> Cable box unscrambles all channels	
<input type="checkbox"/> No VCR	

If you are connecting a VCR

- See the connections described on pages 24 and 26.

Cable or Antenna Only

For best results, use one of the following connections if you are connecting a cable or an antenna and you:

- ❑ Do not need a cable box to unscramble channels. (If you have a cable box, see pages 18-20.)
- ❑ Do not intend to connect a VCR. (If you have a VCR, see pages 24 and 26.)

The connection you choose depends on the cable type you have in your home, as described below.

75-ohm coaxial cable (usually found in newer homes)

Cable Type

Connect As Shown

VHF Only or
combined
VHF/UHF or
Cable

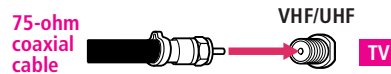

300-ohm twin lead cable (usually found in older homes)

Cable Type

Connect As Shown

VHF Only or
UHF Only or
combined
VHF/UHF

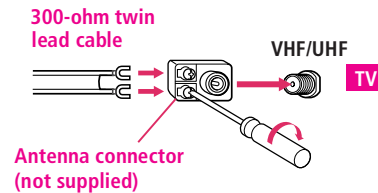

75-ohm coaxial and 300-ohm twin lead cable (found in some homes)

Cable Type

Connect As Shown

VHF and UHF

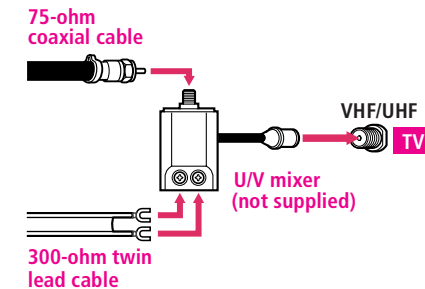

Cable and Antenna Only

For best results, use this connection if you:

- ❑ Have a cable and an antenna.
(This is convenient if you are using a separate rooftop antenna to receive additional channels, such as HDTV channels, that are not provided by your cable company.)
- ❑ Do not have a cable box or VCR. (if you have a cable box, see pages 18 to 20. If you have a VCR, see pages 24 and 26.)

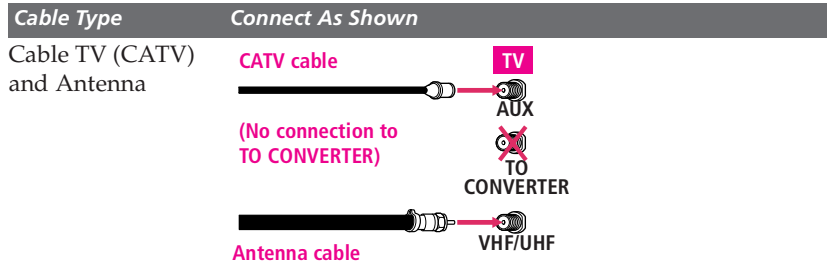

About Using This Connection with Dual Picture (Twin View, etc.) Features

With this connection, you cannot view CATV channels in the right dual picture window.

Notes on Using This Connection

<i>To Do This ...</i>	<i>Do This ...</i>
Switch the TV's input between the cable and antenna	Press ANT to switch back and forth between the TV's VHF/UHF and AUX inputs.

Cable Box and Cable Only

 **DIGITAL CABLE BOX USERS:** Do not use this connection. The TO CONVERTER jack is not compatible with digital cable boxes.

For best results, use this connection if:

- ❑ Your cable company scrambles some channels, such as premium channels (which requires you to use a cable box), but does not scramble all channels.
- ❑ You do not have a VCR. (If you have a VCR, see pages 24 and 26.)

With this connection you can:

- ❑ Use the TV remote control to change channels coming through the cable box to the TV's AUX input jack. (You must first program the remote control for your specific cable box; see "Programming the Remote Control" on page 46.)
- ❑ Use the TV remote control to change channels coming directly into the TV's VHF/UHF input. (The TV's tuner provides a better signal than the cable box.)

About Using This Connection with Dual Picture (Twin View, etc.) Features

With this connection, you can use all the dual picture features for unscrambled channels coming directly into the TV's VHF/UHF input jack.

However, you can use only some of the dual picture features for channels coming through the cable box to the TV's AUX input jack. For example, when you switch the TV's input to AUX — to select the cable box input — the picture displays only in the left window. For example, if you turn on Twin View, you can watch cable channels coming into the VHF/UHF jack in the right window, but you cannot swap the pictures between the left and right windows.

To connect the cable box and cable

- 1 Connect the cable from your cable company to the TV's VHF/UHF jack.
- 2 Use a coaxial cable to connect the TV's TO CONVERTER jack to the cable box's input jack. (The TV's internal converter lets you switch between unscrambled signals coming straight into the TV and scrambled signals coming in through the cable box, eliminating the need for an external splitter.)
- 3 Use a coaxial cable to connect the cable box's output jack to the TV's AUX jack.
- 4 Run Auto Program, as described in "Setting Up the Channel List" on page 39.

If you have a digital cable box, you cannot use this connection because the TO CONVERTER jack is not compatible with digital cable boxes.

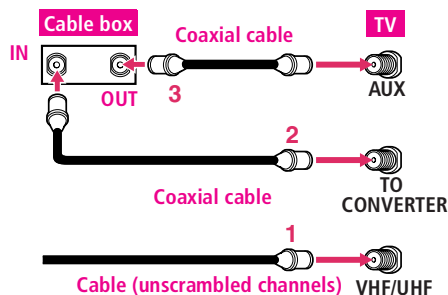

Notes on Using This Connection

To Do This ...	Do This ...
Use the cable box	Tune the TV to the channel the cable box is set to (usually channel 3 or 4) and then use the cable box to switch channels.
Set up the TV remote control to operate the cable box	Program the remote control. See "Programming the Remote Control" on pages 46-47.
Activate the remote control to operate the cable box	Press SAT/CABLE FUNCTION .
Prevent the accidental switching of TV channels	When using the cable box, you need the TV to stay on the channel the cable box is set to (usually channel 3 or 4). You can use the TV's Channel Fix feature to lock in a specific channel. For details, see "Using the Channel Menu" on page 67.
Switch the TV's input between the cable box and cable	Press ANT to switch back and forth between the TV's VHF/UHF and AUX inputs.

Cable Box Only

For best results, use this connection if:

- ❑ Your cable company scrambles all channels, which requires you to use a cable box.
- ❑ You do not have a VCR. (If you have a VCR, see pages 24 and 26.)

With this connection you can:

- ❑ Use the TV remote control to change channels coming through the cable box to the TV's VHF/UHF jack. (You must first program the remote control for your specific cable box.)

About Using This Connection with Dual Picture (Twin View, etc.) Features

With this connection, all channels come into the TV through your cable box and only one unscrambled signal is sent to the TV, so you cannot use the dual picture features. If some of your channels are scrambled, but others are not, consider using the "Cable Box and Cable" connection on page 18 instead.

To connect the cable box

- 1 Connect the CATV cable to the cable box's input jack.
- 2 Use a coaxial cable to connect the cable box's output jack to the TV's VHF/UHF jack.
- 3 Run Auto Program, as described in "Setting Up the Channel List" on page 39.

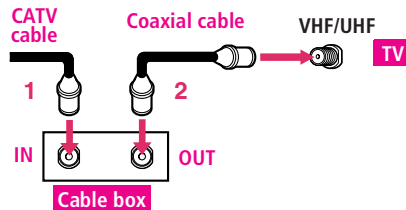

Notes on Using This Connection

To Do This ...	Do This ...
Use the cable box	Tune the TV to the channel the cable box is set to (usually channel 3 or 4) and then use the cable box to switch channels.
Set up the TV remote control to operate the cable box	Program the remote control. See "Programming the Remote Control" on pages 46-47.
Activate the remote control to operate the cable box	Press SAT/CABLE FUNCTION .
Prevent the accidental switching of TV channels	When using the cable box, you need the TV to stay on the channel the cable box is set to (usually channel 3 or 4). You can use the TV's Channel Fix feature to lock in a specific channel. For details, see "Using the Channel Menu" on page 67.

Connecting Optional Equipment

Use the directions in this section to connect the following optional equipment:

<i>If You Are Connecting</i>	<i>See Page</i>
VCR and Cable	24
VCR and Cable Box	26
Satellite Receiver	28
Satellite Receiver and VCR	30
DVD Player with Component Video Connectors	32
DVD Player with S VIDEO and Audio Connectors	33
Camcorder	34
Audio Receiver	35
DVI-Equipped Device	36
HDMI-Equipped Device	37

Making Video Connections

Your TV includes several types of video inputs. When connecting your TV, use the inputs that are available on your components that provide the best video performance, as described below.

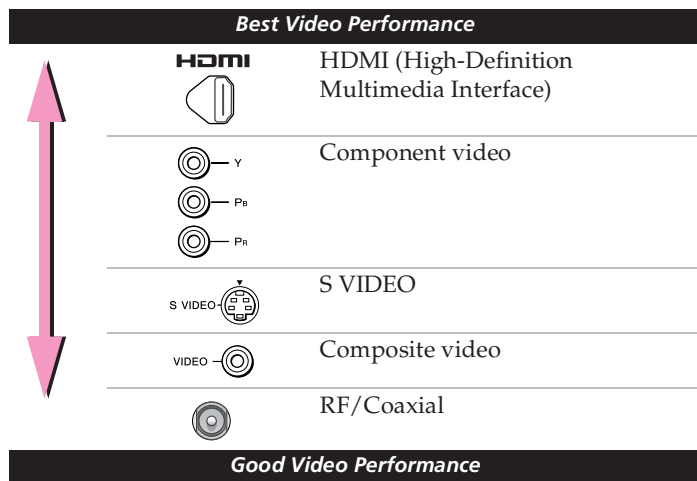

About Using S VIDEO



If the optional equipment you are connecting has an S VIDEO jack (shown at left), you can use an S VIDEO cable for improved picture quality (compared to an A/V cable). Because S VIDEO carries only the video signal, you also need to connect audio cables for sound, as shown below.

Example of an S VIDEO Connection

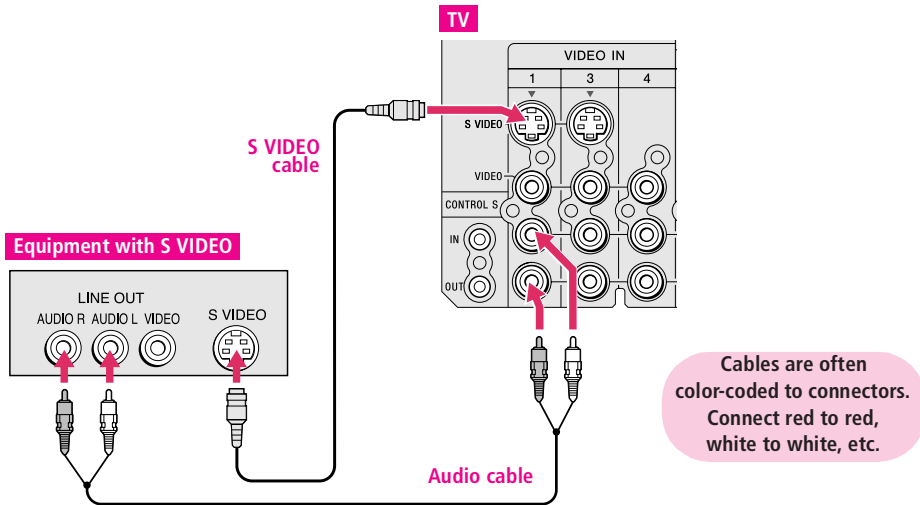

VCR and Cable

For best results, use this connection if:

- ❑ Your cable company does not require you to use a cable box.

About Using This Connection with Dual Picture (Twin View, etc.) Features

With this connection, you can use all the dual picture features.

To connect the VCR and cable

- 1 Connect the CATV cable to the VCR's VHF/UHF input jack.
- 2 Use a coaxial cable to connect the VCR's VHF/UHF output jack to the TV's VHF/UHF jack.
- 3 Use an A/V cable to connect the VCR's A/V output jacks to the TV's A/V input jacks.
- 4 Run Auto Program, as described in "Setting Up the Channel List" on page 39.



Using
S VIDEO jacks?
See page 23.

TV

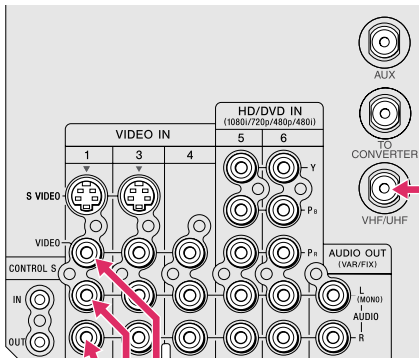

Cables are often color-coded to connectors. Connect red to red, white to white, etc.

Coaxial cable

VCR

CATV cable

A/V cable

Notes on Using This Connection

<i>To Do This ...</i>	<i>Do This ...</i>
Watch the VCR	Press TV/VIDEO repeatedly to select the VCR input (VIDEO 1 in the illustration).
Watch cable channels	Press TV/VIDEO repeatedly to select the cable input (VHF/UHF in the illustration).
Set up the TV remote control to operate the VCR	If you have a non-Sony VCR, you must program the remote control. See "Programming the Remote Control" on pages 46-47.
Activate the TV remote control to operate the VCR	Press DVD/VCR FUNCTION .
Control VCR functions with the TV remote control	See "Operating a VCR" on page 48.
Label video inputs to easily identify equipment connected to the TV	See the instructions for setting up Video Labels on pages 72-73.

VCR and Cable Box

For best results, use this connection if:

- ❑ Your cable company scrambles some channels, such as premium channels (which requires you to use a cable box), but does not scramble all channels.

About Using This Connection with Dual Picture (Twin View, etc.) Features

With this connection, you can use all the dual picture features.

With this connection you can:

- ❑ Use the TV remote control to change channels coming through the cable box. (You must first program the remote control for your specific cable box; see “Programming the Remote Control” on page 46.)
- ❑ Use the TV remote control to change channels coming directly into the TV’s VHF/UHF jack. (The TV’s tuner provides a better signal than the cable box.)
- ❑ Record channels coming through the cable box and channels coming directly into the TV.

To connect a VCR and cable box, you need:

- ❑ A splitter, which is a small, inexpensive device that you can purchase at your local electronics store.
- ❑ Three coaxial cables.
- ❑ Two A/V cables or S VIDEO cables with audio cables.

To connect the VCR and cable box

- 1 Connect the CATV cable to the single (input) jack of the splitter.
- 2 Use a coaxial cable to connect one of the splitter’s two output jacks to the TV’s VHF/UHF jack.
- 3 Use a coaxial cable to connect the splitter’s other output jack to the cable box’s input jack.
- 4 Use a coaxial cable to connect the cable box’s output jack to the VCR’s RF input jack.
- 5 Use an A/V cable to connect the cable box’s A/V output jacks to the TV’s A/V input jacks.
- 6 Use an A/V cable to connect the VCR’s A/V output jacks to the TV’s A/V input jacks.
- 7 Run Auto Program, as described in “Setting Up the Channel List” on page 39.



Using
S VIDEO jacks?
See page 23.

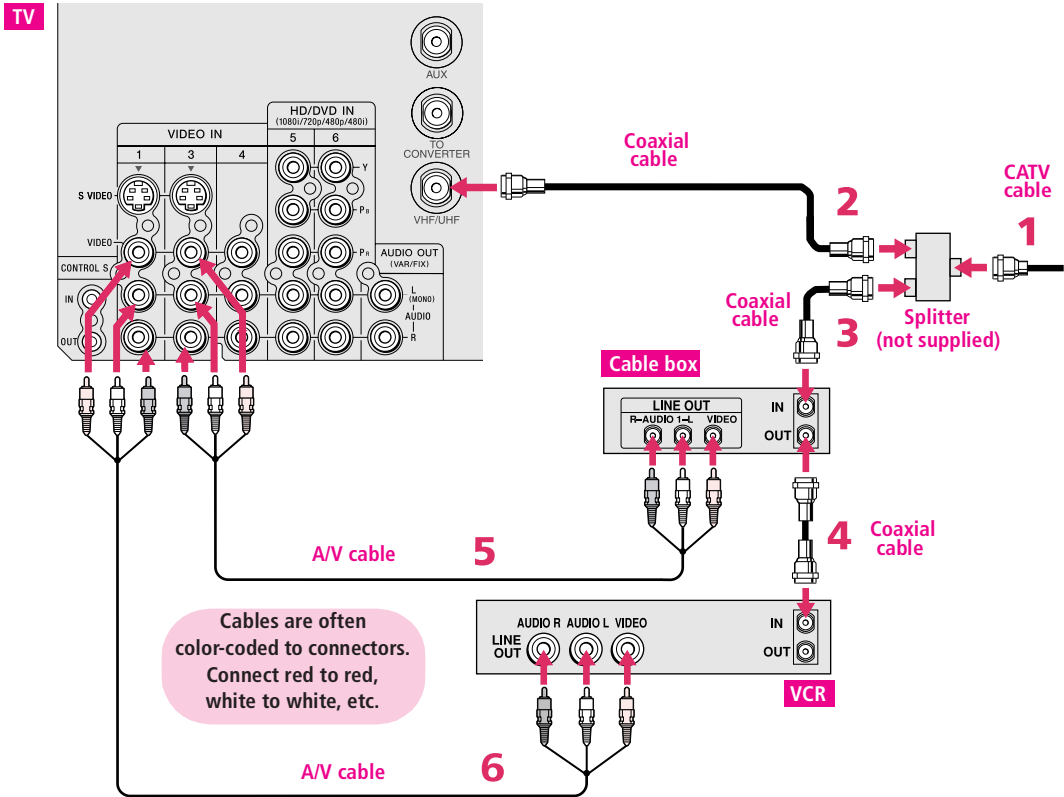

Notes on Using This Connection

To Do This ...	Do This ...
Watch cable (unscrambled) channels	Press TV/VIDEO repeatedly to select the cable input (VHF/UHF in the illustration).
Watch cable box (scrambled) channels	Press TV/VIDEO repeatedly to select the cable box input (VIDEO 3 in the illustration). Use the cable box to change channels.
Watch the VCR	Press TV/VIDEO repeatedly to select the VCR input (VIDEO 1 in the illustration).
Set up the TV remote control to operate the cable box or VCR	If you have a non-Sony VCR, you must program the remote control. See "Programming the Remote Control" on pages 46-47.
Activate the remote control to operate the cable box or VCR	For the cable box, press SAT/CABLE FUNCTION . For the VCR, press DVD/VCR FUNCTION .
Control specific cable box and VCR functions with the TV remote control	See "Operating a Cable Box" on page 49 and "Operating a VCR" on page 48.
Label video inputs to easily identify equipment connected to the TV	See the instructions for setting up Video Labels on pages 72-73.

Satellite Receiver



Using S VIDEO jacks?
See page 23.

To connect a satellite receiver

- 1 Connect the satellite antenna cable to the satellite receiver's satellite input jack.
- 2 Use an A/V cable to connect the satellite receiver's A/V output jacks to the TV's A/V input jacks.
- 3 Connect your cable or antenna to the satellite receiver's VHF/UHF input jack.
- 4 Use a coaxial cable to connect the satellite receiver's VHF/UHF output jack to the TV's VHF/UHF jack.
- 5 Run Auto Program, as described in "Setting Up the Channel List" on page 39.

TV

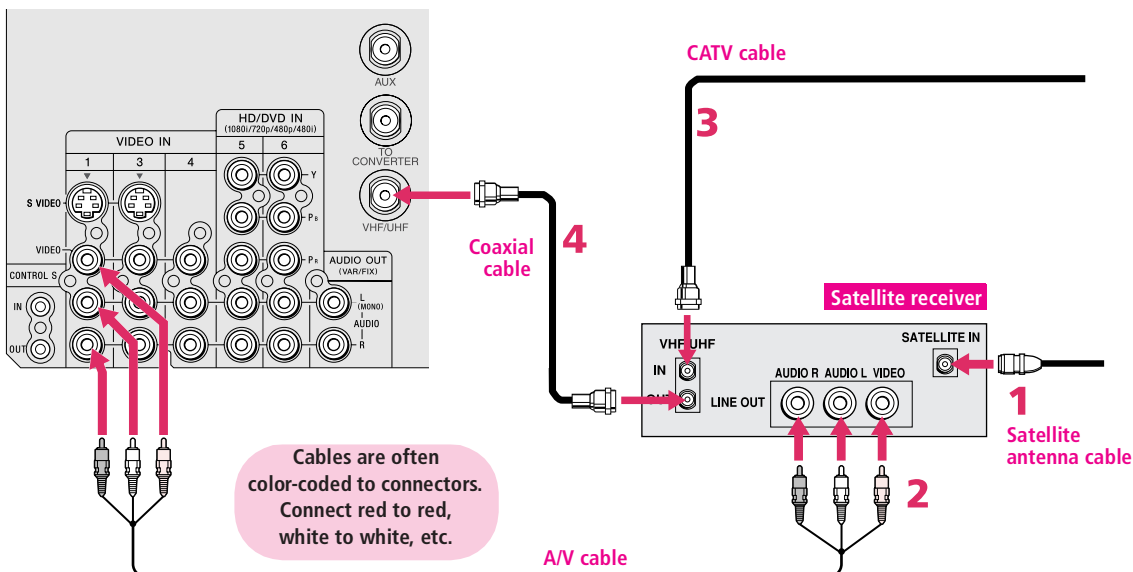

Notes on Using This Connection

To Do This ...	Do This ...
Watch the satellite receiver	Press TV/VIDEO repeatedly to select the satellite receiver input (VIDEO 1 in the illustration).
Set up the TV remote control to operate the satellite receiver	If you have a non-Sony satellite receiver, you must program the remote control. See "Programming the Remote Control" on pages 46-47.
Activate the TV remote control to operate the satellite receiver	Press SAT/CABLE FUNCTION .
Control satellite receiver functions with the TV remote control	See "Operating a Satellite Receiver" on page 48.
Label video inputs to easily identify equipment connected to the TV	See the instructions for setting up Video Labels on pages 72-73.

Satellite Receiver and VCR



Using
S VIDEO jacks?
See page 23.

To connect a satellite receiver and VCR

- 1 Connect the CATV cable to the single (input) jack of the splitter.
- 2 Use a coaxial cable to connect one of the splitter's two output jacks to the TV's VHF/UHF jack.
- 3 Use a coaxial cable to connect the splitter's other output jack to the satellite receiver's VHF/UHF input jack.
- 4 Connect the satellite antenna cable to the satellite receiver's satellite input jack.
- 5 Use a coaxial cable to connect the satellite receiver's VHF/UHF output jack to the VCR's VHF/UHF input jack.
- 6 Use an A/V cable to connect the satellite receiver's A/V output jacks to the TV's A/V input jacks.
- 7 Use an A/V cable to connect the VCR's A/V output jacks to the TV's A/V input jacks.
- 8 Run Auto Program, as described in "Setting Up the Channel List" on page 39.

Notes on Using This Connection

To Do This ...	Do This ...
Watch the satellite receiver	Press TV/VIDEO repeatedly to select the satellite receiver input (VIDEO 3 in the illustration).
Watch the VCR	Press TV/VIDEO repeatedly to select VCR input (VIDEO 1 in the illustration).
Set up the TV remote control to operate the satellite receiver or VCR	If you have a non-Sony VCR or satellite receiver, you must program the remote control. See "Programming the Remote Control" on pages 46-47.
Activate the TV remote control to operate the satellite receiver or VCR	For the satellite receiver, press SAT/CABLE FUNCTION . For the VCR, press DVD/VCR FUNCTION .
Control satellite receiver and VCR functions with the TV remote control	See "Operating a Satellite Receiver" on page 48 and "Operating a VCR" on page 48.
Label video inputs to easily identify equipment connected to the TV	See the instructions for setting up Video Labels on pages 72-73.

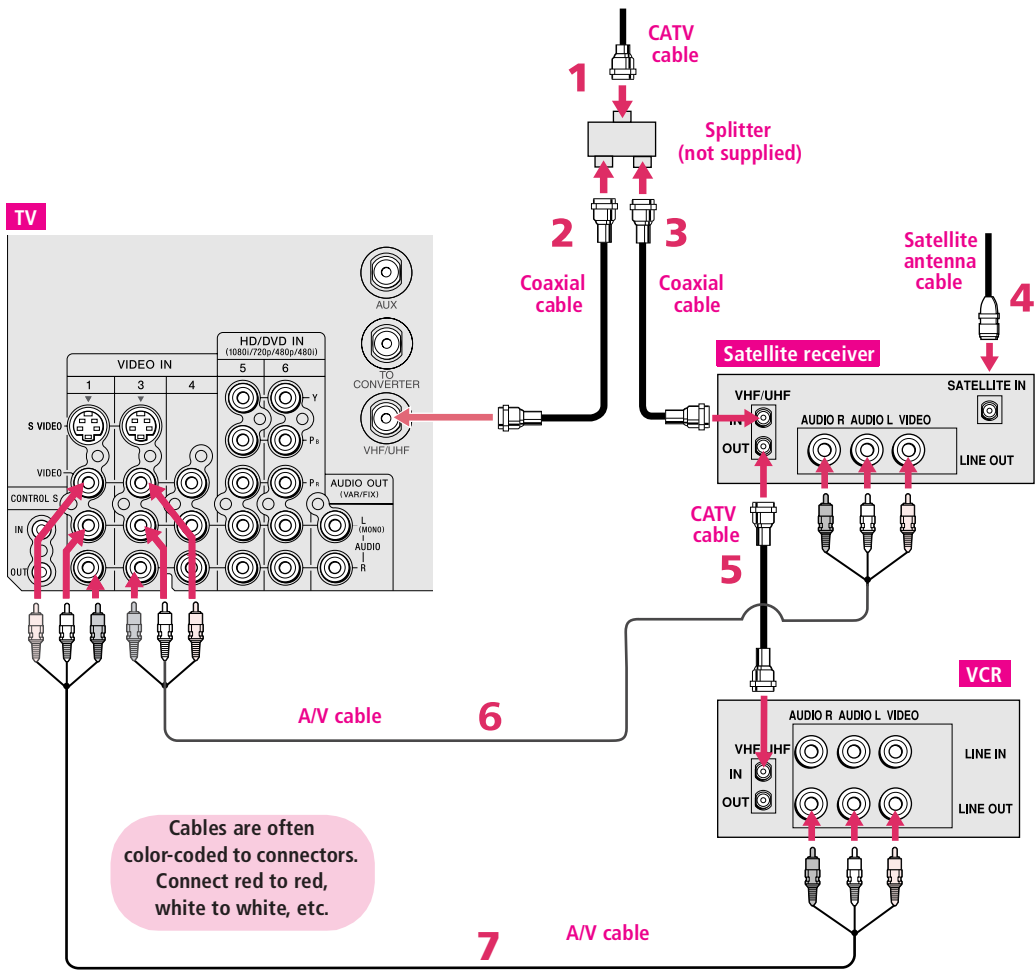

Cables are often color-coded to connectors. Connect red to red, white to white, etc.

DVD Player with Component Video Connectors

For best results, use this connection if your DVD player has component video (Y, PB, PR) jacks.

To connect a DVD player with component video connectors

- 1 Use component video cables to connect the DVD player's Y, PB and PR jacks to the Y, PB and PR jacks (VIDEO 5) on the TV.

 The Y, PB and PR jacks on your DVD player are sometimes labeled Y, CB and CR, or Y, B-Y and R-Y. If so, connect the cables to like colors.

- 2 Use an audio cable to connect the DVD player's audio output jacks to the TV's VIDEO 5 audio input jacks.

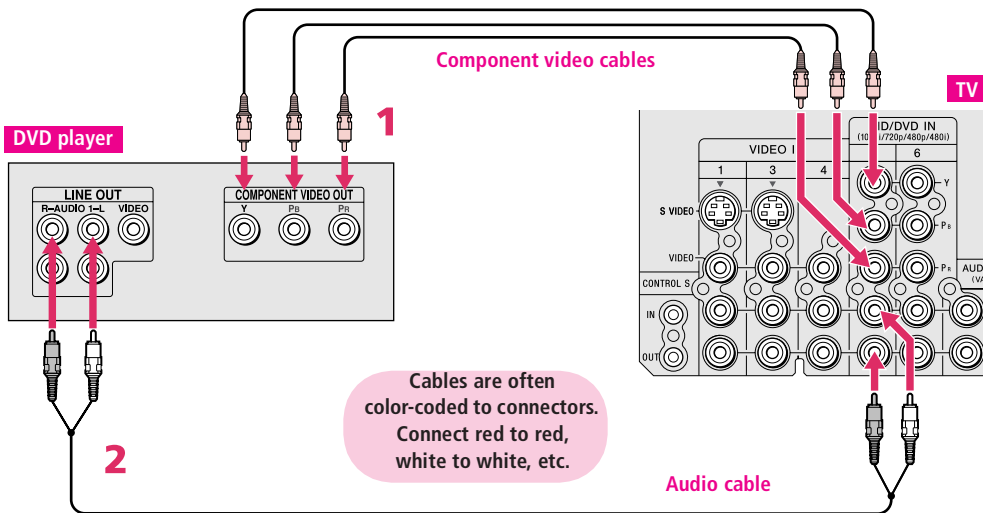

Notes on Using This Connection

To Do This ...	Do This ...
Watch the DVD player	Press TV/VIDEO repeatedly to select the DVD input (VIDEO 5 in the illustration).
Set up the TV remote control to operate the DVD player	If you have a non-Sony DVD player, you must program the remote control. See "Programming the Remote Control" on pages 46-47.
Activate the TV remote control to operate the DVD player	Press DVD/VCR FUNCTION .
Control DVD functions with the TV remote control	See "Operating a DVD Player" on page 49.
Label video inputs to easily identify equipment connected to the TV	See the instructions for setting up Video Labels on pages 72-73.

 You cannot record the signal from any equipment connected into the Y, PB, PR jacks.

DVD Player with S VIDEO and Audio Connectors

Use this connection if your DVD player does not have component video (Y, PB, PR) jacks.

To connect a DVD player with A/V connectors

- 1 Use an audio cable to connect the DVD player's audio output jacks to the TV's audio input jacks.
- 2 Use an S VIDEO cable to connect the DVD player's S VIDEO jack to the TV's S VIDEO jack.

Cables are often color-coded to connectors. Connect red to red, white to white, etc.

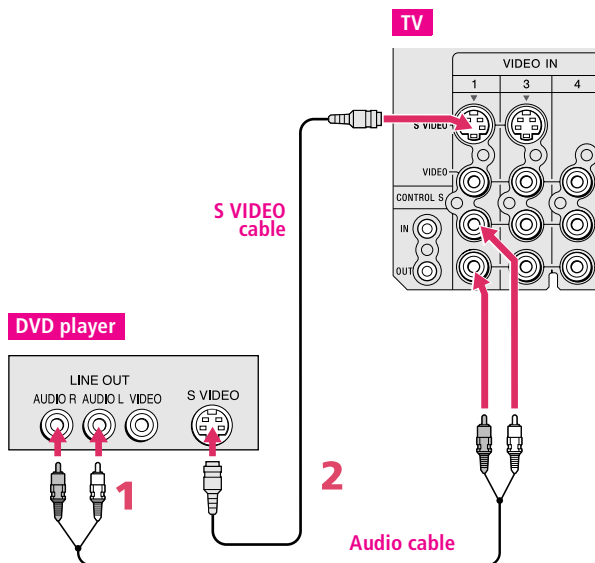

Notes on Using This Connection

To Do This ...	Do This ...
Watch the DVD player	Press TV/VIDEO repeatedly to select the DVD input (VIDEO 1 in the illustration).
Set up the TV remote control to operate the DVD player	If you have a non-Sony DVD player, you must program the remote control. See "Programming the Remote Control" on pages 46-47.
Activate the TV remote control to operate the DVD player	Press DVD/VCR FUNCTION .
Control DVD functions with the TV remote control	See "Operating a DVD Player" on page 49.
Label video inputs to easily identify equipment connected to the TV	See the instructions for setting up Video Labels on pages 72-73.

Camcorder



Using
S VIDEO jacks?
See page 23.

For easy connection of a camcorder, the TV has front A/V input jacks. If you prefer, however, you can connect the camcorder to the TV's rear A/V input jacks.

To connect a camcorder

- 1 Open the front video panel, as shown on page 11.
- 2 Use A/V cables to connect the camcorder's A/V output jacks to the TV's A/V input jacks.

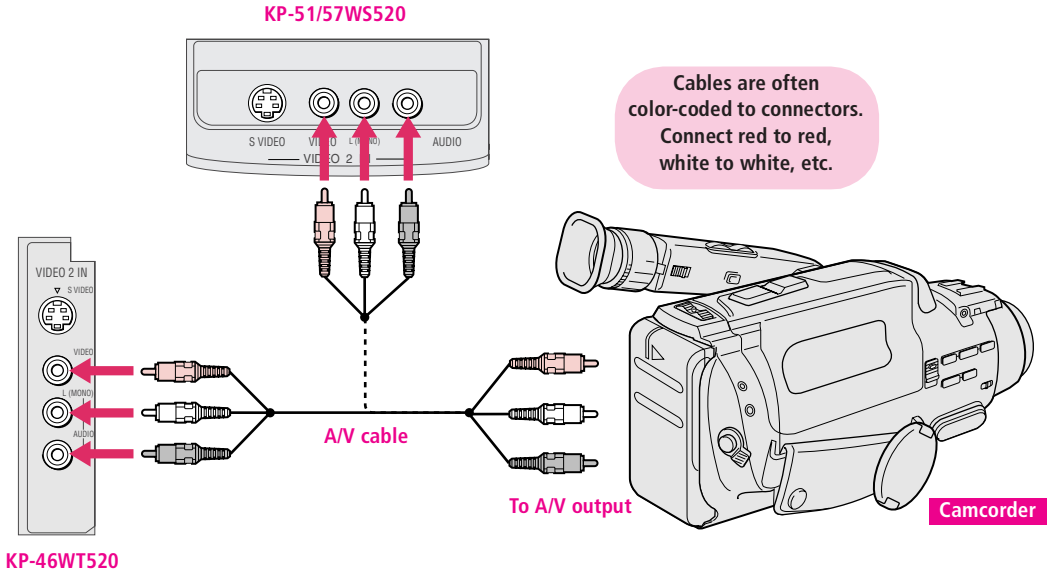

If you have a mono camcorder, connect its audio output jack to the TV's L MONO audio jack.

Notes on Using This Connection

To Do This ...

Watch the camcorder

Label video inputs to easily identify equipment connected to the TV

Do This ...

Press **TV/VIDEO** repeatedly to select the camcorder input (VIDEO 2 in the illustration).

See the instructions for setting up Video Labels on pages 72-73.

Audio Receiver

For improved sound quality, you may want to play the TV's audio through your stereo system.

To connect an audio system

- 1 Use an audio cable to connect the TV's audio output jacks to the audio receiver's line input jacks.

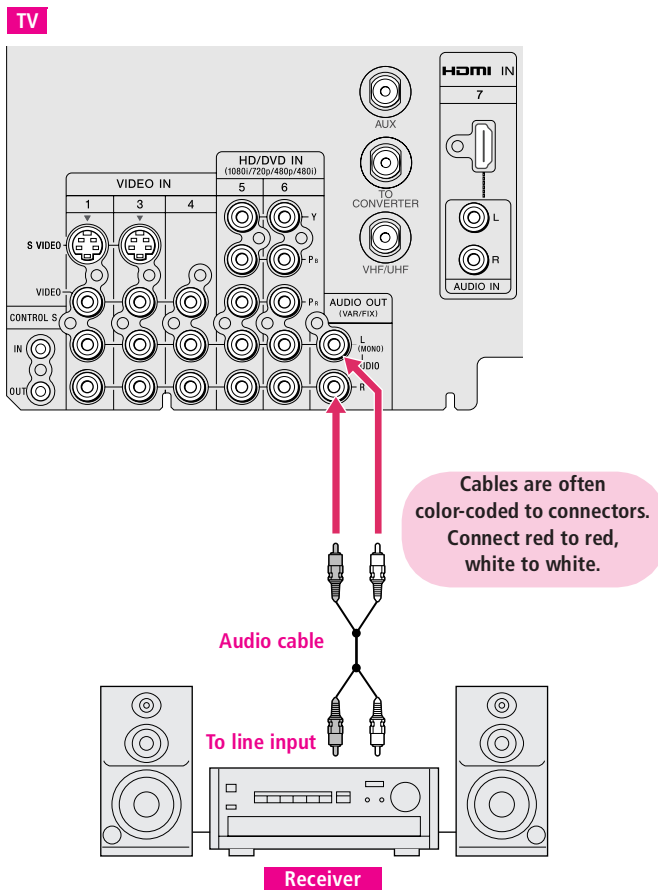

- 2 Using the TV's Audio Menu, set the **Speaker** option to **Off**. Then set the **Audio Out** option to **Fixed** or **Variable**, depending on how you want to control the volume. For details, see "Using the Audio Menu" on page 64.
- 3 Turn on the audio receiver, and then set the receiver's line input to the jack into which you connected the TV.

DVI-Equipped Device

If you have a device, such as an HDTV receiver, that has DVI (Digital Video Interface) output, use the following connection.

To connect a device that has DVI OUT:

- 1 Use an HDMI-to-DVI cable to connect the device's DVI OUT jack to the TV's HDMI IN jack.

 You can purchase HDMI cables (or cable adapters) at your local electronics store.

- 2 Use an audio cable to connect the device's audio output jacks to the TV's HDMI analog audio input jacks.

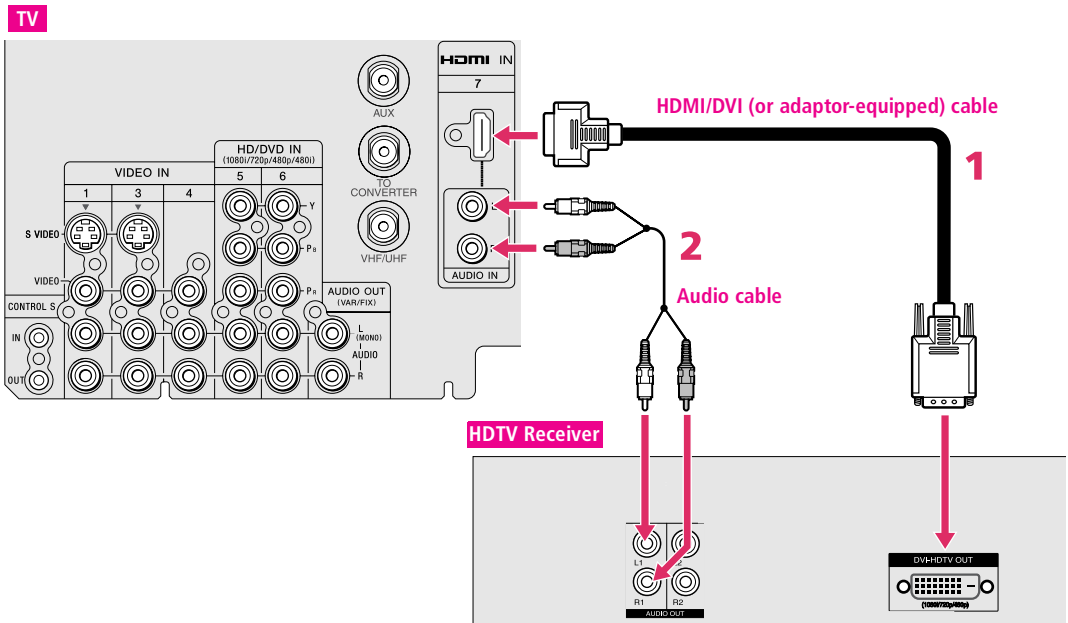

Notes on Using This Connection

To Do This ...

Watch the DVI device

Label video inputs to easily identify equipment connected to the TV

Do This ...

Press **TV/VIDEO** repeatedly to select the VIDEO 7 input.

See the instructions for setting up Video Labels on pages 72-73.

HDMI-Equipped Device

If you have a device, such as an HDTV receiver, that has a High-Definition Multimedia Interface (HDMI), use the following connection.

To connect a device that has HDMI OUT:

- 1 Use the HDMI cable that came with your device to connect the device's HDMI OUT jack to the TV's HDMI IN jack.

 HDMI cables transmit both audio and video signals. (Separate audio cables are not necessary.) You can purchase HDMI cables at your local electronics store.

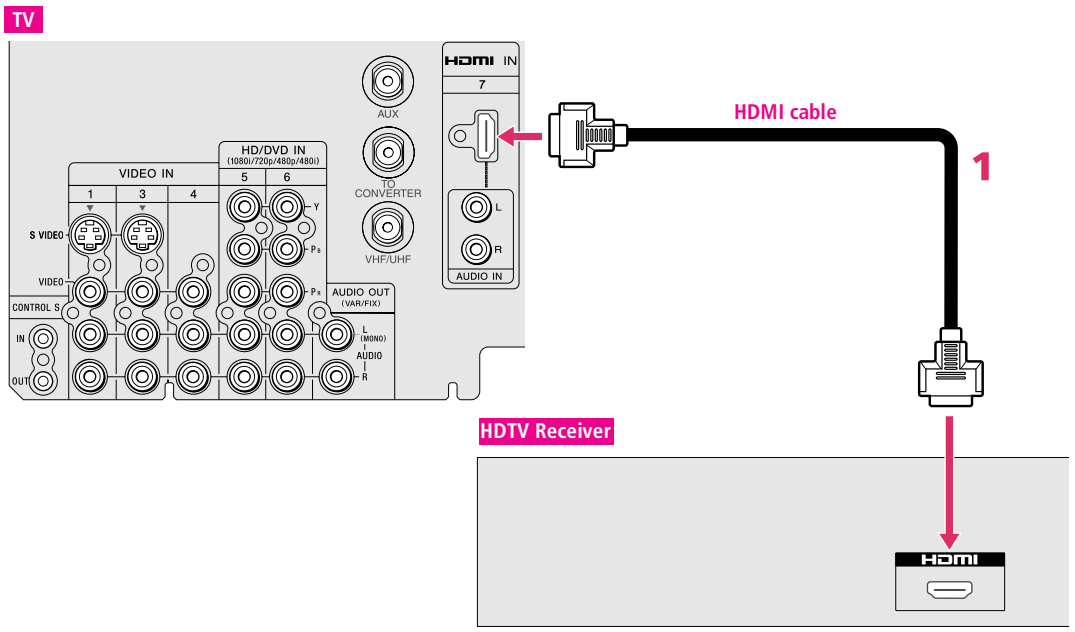

Notes on Using This Connection

To Do This ...	Do This ...
Watch the HDMI device	Press TV/VIDEO repeatedly to select the VIDEO 7 input.
Label video inputs to easily identify equipment connected to the TV	See the instructions for setting up Video Labels on pages 72-73.

Using the CONTROL S Feature

CONTROL S allows you to control your system and other Sony equipment with one remote control. In addition to allowing you to control multiple devices with one remote control, the CONTROL S feature allows you to always point your remote control at your TV, instead of having to point it at the other equipment, which might be hidden or out of direct line of sight.

Use CONTROL S IN to send signals to the TV.

Use CONTROL S OUT to send signals to connected equipment.

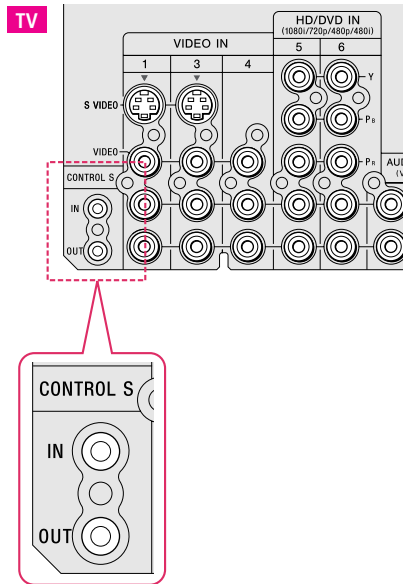

Setting Up the Channel List

After you finish connecting the TV, you need to run the Auto Program feature, which automatically creates a list of available channels. The Auto Program screens appear when you turn on your TV for the first time after hooking it up.

Using Auto Program

To run Auto Program the first time you turn on your TV

- 1 Press **POWER** to turn on the TV.
The Initial Setup screen appears.
- 2 When prompted to start Auto Program, press the **CH+** button to start Auto Program.

To run Auto Program again at a later time

- Use the Auto Program feature as described on page 67.

To reset the TV to factory settings

- 1 Press **POWER** to turn on the TV.
- 2 Hold down **RESET** on the remote control.
- 3 Press **TV POWER** on the TV. (The TV will turn itself off, then back on.)
- 4 Release **RESET**.

Adjusting the Convergence Automatically (Flash Focus)

The projection tube image appears on the screen in three colors (red, green and blue). If they do not converge, the color is poor and the picture blurs. Before you use your TV, be sure to adjust the convergence. The Flash Focus feature allows you to adjust the convergence automatically.

 It is recommended that you perform Flash Focus about 30 minutes after the TV is first turned on.

 You can also access Flash Focus in the Setup Menu. For details, see page 72.

- 1 Tune to a TV or cable TV program.
- 2 Press the **FLASH FOCUS** button on the front panel of the TV (see page 12).

The cross pattern appears and Flash Focus begins to work.

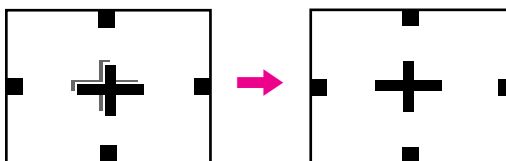

The adjustment is completed when the TV picture returns.

To Perform Additional Fine Manual Adjustments

Use the Manual Convergence feature, described on page 41.

Notes on Flash Focus



- You cannot perform any other functions until Flash Focus has completed its cycle. If you perform any other operation while Flash Focus is in progress, the Flash Focus operation is canceled.

Adjusting the Convergence Manually

The Convergence feature gives you more control over the picture's convergence than the Flash Focus feature, allowing you to fine-tune the convergence.

 Before adjusting the convergence manually for the first time, you must first perform Flash Focus (as described on page 40).





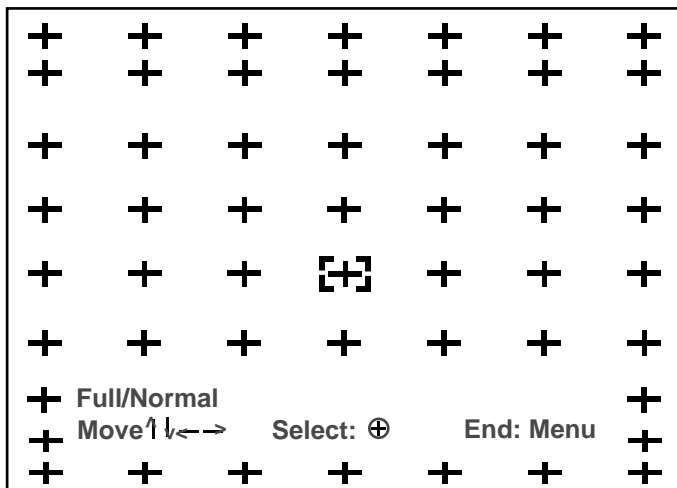

 For details on using the Setup Menu, see page 72.

- 1 Press **MENU** to display the Menu.
- 2 Press **◀** or **▶** to highlight the Setup icon and press .
- 3 Highlight **Convergence** and press .

A pattern of white crosses appears, with a yellow  around one of the crosses. Aligned crosses (which do not need adjustment) look white and have little or no red or blue showing. Crosses that are not aligned show red or blue shades beyond their edges.



You can scroll up and down through the 9 x 7 field of crosses to manually converge all portions of the screen.

- 4 Move the  to surround a cross that you want to adjust. Press . The  changes to red.
- 5 If the cross that you selected has red edges, move until the red image is replaced with a white cross. Once you have finished this (or the cross does not have red edges), press . The  changes to blue.
- 6 If the cross you selected has blue edges, move until the blue image is replaced with a white cross. Once you have finished this, press . The  changes to yellow again.
- 7 Repeat steps 4 to 6 to adjust other crosses. When finished, press **MENU** to exit the Setup Menu.

Notes on Adjusting the Convergence Manually

- ❑ Allow the TV to warm up for about 30 minutes before you adjust the convergence.
- ❑ For best results, stand about 3 to 5 feet back from the picture when adjusting the convergence. Begin with the crosses in the center area of the screen and, once those are adjusted, move to the crosses on the edges of the screen.
- ❑ You can make separate adjustments in each of the following viewing modes:
 - ❑ For standard-definition (480i/480p) sources: **Wide Zoom**, **Normal/Full**, and **Zoom** modes (see page 53).
 - ❑ For high-definition (720p/1080i) sources: **Full**, **Wide Zoom**, and **Zoom** modes (see page 54); in Twin View (see page 55).

In each of these viewing modes, the cross pattern looks different, but the adjustment procedure is the same.

- ❑ To optimize the conditions for convergence adjustment, in the Video Menu, set **Mode** to **Pro** or **Movie** and lower the **Picture** level settings (see page 62).
- ❑ You can reset the adjustments by pressing the **RESET** button on the remote control.

Using the Remote Control

Overview

This chapter describes how to set up, program, and use the TV's remote control.

Topic	Page
Inserting Batteries	43
Button Descriptions	44
Programming the Remote Control	46
Using Other Equipment with Your TV Remote Control	48

Inserting Batteries

- 1 Remove the battery cover from the remote control.
- 2 Insert two size AA (R6) batteries (supplied) by matching the \oplus and \ominus terminals on the batteries to the diagram inside the battery compartment.
- 3 Replace the battery cover.

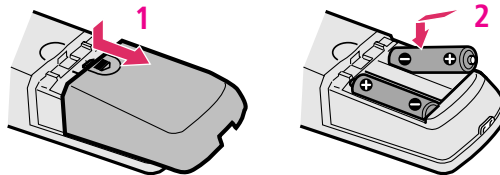

 Remove the batteries to avoid damage from possible battery leakage whenever you anticipate that the remote control will not be used for an extended period.







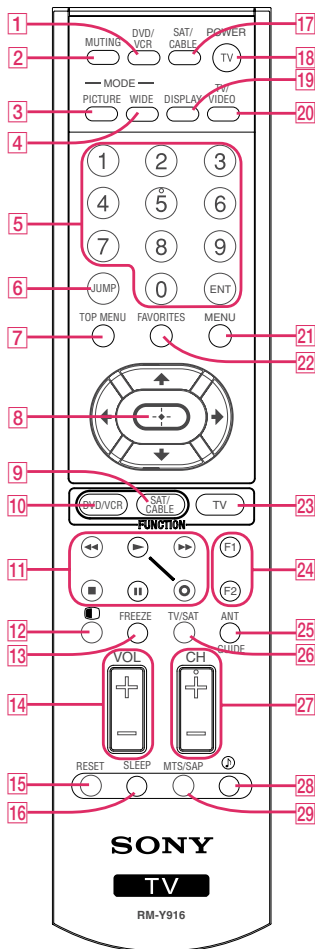

Handle the remote control with care.

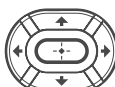
Avoid dropping it, getting it wet, placing it in direct sunlight, near a heater, or where the humidity is high.

Button Descriptions

Remote Control



Button	Description
1 DVD/VCR POWER	Press to turn on and off the DVD player or VCR.
2 MUTING	Press to mute the sound. Press again or press VOL+ to restore the sound. *
3 PICTURE MODE	Press repeatedly to cycle through the available video picture modes: Vivid , Standard , Movie , Pro . Also available in the Video Menu. For details, see "Selecting Video Options" on page 62.
4 WIDE MODE	Press repeatedly to step through the Wide Mode settings. Also available in the Screen Menu. For details, see pages 53 and 66.
5 0 - 9 ENT	Press 0 - 9 to select a channel; the channel changes after 3 seconds. Press ENT (ENTER) to change channels immediately.
6 JUMP	Press to jump back and forth between two channels. The TV alternates between the current channel and the last channel that was selected.
7 TOP MENU	Press to display the DVD Menu.
8 	Press ↑ ↓ ← → to move the on-screen cursor. To select an item, press ↵ .
9 SAT/CABLE FUNCTION	Press to have the remote control operate the satellite receiver or cable box.
10 DVD/VCR FUNCTION	Press to have the remote control operate the DVD player or VCR.
11 Transport Buttons	<ul style="list-style-type: none">  Rewind  Play  Fast forward  Stop  Pause  Record (press together with )
12 	Press to turn on and off Twin View. For details, see pages 55-57.
13 FREEZE	Press to freeze the window picture. Press again to restore the picture. For details see page 59.
14 VOL +/-	Press to adjust the volume. *

* **MUTING** and **VOL +/-** buttons also function with Sony DVD Dream™ Systems

Button	Description
15 RESET	Press to reset the settings to the factory defaults. See pages 63 and 65. Also used to clear Favorite Channels, (see page 58), and Manual Convergence (see page 42).
16 SLEEP	Press repeatedly until the TV displays the time in minutes (15, 30, 45, 60, or 90) that you want the TV to remain on before shutting off automatically. To cancel press until Sleep Off appears. While the Sleep feature is set, press once to display the remaining time.
17 SAT/CABLE POWER	Press to turn on and off the satellite receiver or cable box.
18 TV POWER	Press to turn on and off the TV.
19 DISPLAY	Press once to display the current channel number, current time, and program information banner (if set). Press again to turn Display off.
20 TV/VIDEO	Press repeatedly to cycle through the video equipment connected to the TV's video inputs.
21 MENU	Press to display the Menu. Press again to exit from the Menu. For details, see page 61.
22 FAVORITES	Press to display the Favorite Channels list. For details, see page 58.
23 TV FUNCTION	Press to have the remote control operate the TV.
24 F1/F2	Functions only while the remote control is in DVD/VCR FUNCTION mode. For details, see "Using the F1 and F2 Buttons" on page 49.
25 ANT	Press to switch between the sources connected to the TV's VHF/UHF and AUX inputs.
GUIDE	When the remote control is set to operate the satellite receiver, press to display the program guide.
26 TV/SAT	When the remote control is set to operate the satellite receiver, press to switch between the satellite receiver's TV and SAT (satellite) inputs.
27 CH +/-	Press to scan through channels. To scan quickly through channels, press and hold down either CH button.
28 	Press repeatedly to step through the Audio Effect options. Also available in the Audio Menu. For details, see page 64.
29 MTS/SAP	Press repeatedly to cycle through the Multi-channel TV Sound (MTS) options: Stereo , Auto SAP (Second Audio Program), and Mono . Also available in the Audio Menu. For details, see "Using the Audio Menu" on page 64.

Programming the Remote Control

The remote control is preset to operate Sony brand video equipment. If you have video equipment other than Sony brand that you want to control with the TV's remote control, use the following procedure to program the remote control.

 **The equipment must have infrared (IR) remote capability in order to be used with the remote control.**

- 1 Turn to the list of "Manufacturer's Codes" on page 47, and find the three-digit code number for the manufacturer of your equipment. (If more than one code number is listed, try the number listed first.)
- 2 While holding down **DVD/VCR FUNCTION** or **SAT/CABLE FUNCTION**, press **RESET**. Then release both buttons. (The **DVD/VCR FUNCTION** and **SAT/CABLE FUNCTION** buttons will flash.)
- 3 Press either **DVD/VCR FUNCTION** or **SAT/CABLE FUNCTION**, depending on which button you want to program.
- 4 Enter the three-digit manufacturer's code number.
- 5 Press **ENT**.

 **You must do step 5 within 10 seconds of step 4, or you must redo steps 3 through 5.**

- 6 To check if the code number works, aim the TV's remote control at the equipment and press the **POWER** button that corresponds with that equipment. If it responds, you are done. If not, try using another code listed for that manufacturer.

Notes

- ❑ If more than one code number is listed, try entering them one by one until you come to the correct code for your equipment.
- ❑ If you enter a new code number, the code number you previously entered at that setting is erased.
- ❑ In some cases, you may not be able to operate your equipment with the supplied remote control. In such cases, use the equipment's own remote control.
- ❑ Whenever you remove the batteries to replace them, the code numbers may revert to the factory setting and must be reset.

Manufacturer's Codes

VCRs

Manufacturer	Code
Sony	301, 302, 303
Admiral (M. Ward)	327
Aiwa	338, 344
Audio Dynamic	314, 337
Broksonic	319, 317
Canon	309, 308
Citizen	332
Craig	302, 332
Curtis Mathes	304, 338, 309
Daewoo	341, 312, 309
DBX	314, 336, 337
Dimensia	304
Emerson	319, 320, 316, 317, 318, 341
Fisher	330, 335
Funai	338
General Electronics	329, 304, 309
Go Video	322, 339, 340
Goldstar	332
Hitachi	306, 304, 305, 338
Instant Replay	309, 308
JC Penney	309, 305, 304, 330, 314, 336, 337
JVC	314, 336, 337, 345, 346, 347
Kenwood	314, 336, 332, 337
LG	332
LXI (SEARS)	332, 305, 330, 335, 338
Magnavox	308, 309, 310
Marantz	314, 336, 337
Marta	332
Memorex	309, 335
Minolta	305, 304
Mitsubishi/MGA	323, 324, 325, 326
Multitech	325, 338, 321
NEC	314, 336, 337
Olympic	309, 308
Optimus	327
Orion	317
Panasonic	308, 309, 306, 307
Pentax	305, 304
Philco	308, 309
Philips	308, 309, 310
Pioneer	308
Quasar	308, 309, 306
RCA/PROSCAN	304, 305, 308, 309, 311, 312, 313, 310, 329
Realistic	309, 330, 328, 335, 324, 338

Manufacturer	Code
Sansui	314
Samsung	322, 313, 321
Sanyo	330, 335
Scott	312, 313, 321, 335, 323, 324, 325, 326
Sharp	327, 328
Shintom	315
Signature 2000 (M.Ward)	338, 327
SV 2000	338
Sylvania	308, 309, 338, 310
Symphonic	338
Tashiro	332
Tatung	314, 336, 337
Teac	314, 336, 338, 337
Technics	309, 308
Toshiba	312, 311
Wards	327, 328, 335, 331, 332
Yamaha	314, 330, 336, 337
Zenith	331

DVD Changers

Manufacturer	Code
Sony	765
Panasonic	766

DVD/VCR Combination Units

Manufacturer	Code
Sony	767
Broksonic	776
JVC	775
Panasonic	777
Samsung	774
Toshiba	773
Zenith	768

HDD/DVD Combination Units

Manufacturer	Code
Sony	770, 771, 772

DVD 5.1 Ch

Manufacturer	Code
Sony (DAV)	601, 602, 603, 604

A/V Receivers

Manufacturer	Code
Sony	764

DVD Players

Manufacturer	Code
Sony	751
General Electric	755
Hitachi	758
JVC	756
Magnavox	757
Mitsubishi	761
Panasonic	753
Philips	757
Pioneer	752
RCA/Proscan	755
Samsung	758
Toshiba	754
Zenith	760

Cable Boxes

Manufacturer	Code
Sony	230
Hamlin/Regal	222, 223, 224, 225, 226
Jerrold/G.I./ Motorola	201, 202, 203, 204, 205, 206, 207, 208, 218, 222
Oak	227, 228, 229
Panasonic	219, 220, 221
Pioneer	214, 215
Scientific Atlanta	209, 210, 211
Tocom	216, 217
Zenith	212, 213

Satellite Receivers

Manufacturer	Code
Sony	801
Dish Network	810
Echostar	810
General Electric	802
Hitachi	805
Hughes	804
Mitsubishi	809
Panasonic	803
RCA/PROSCAN	802, 808
Toshiba	806, 807

Using Other Equipment with Your TV Remote Control

All Equipment

To Do This ...	Do This ...
Switch the TV's input to the VCR, DVD player, or other connected equipment	Press TV/VIDEO repeatedly to cycle through the video equipment connected to the TV's video inputs.
Set up the TV remote control to operate non-Sony equipment	You must program the remote control the first time you use it. See "Programming the Remote Control" on pages 46 to 47.

Operating a VCR

To Do This ...	Press
Activate the remote control to operate the VCR	DVD/VCR FUNCTION
Change channels	CH +/-
Record	▶ and ● simultaneously
Play	▶
Stop	■
Fast forward	▶▶
Rewind the tape	◀◀
Pause	
Search the picture forward or backward	▶▶ or ◀◀ during playback (release to resume normal playback)

Operating a Satellite Receiver

To Do This ...	Press
Activate the remote control to operate the satellite receiver	SAT/CABLE FUNCTION
Turn on/off	SAT/CABLE POWER
Select a channel	0-9, ENT
Change channels	CH +/-
Back to previous channel	JUMP
Display channel number	DISPLAY
Display SAT Guide	GUIDE
Display SAT Menu	MENU
Move highlight (cursor)	▲ ▼ ◀ ▶
Select item	◁ ⊕ ▷

Operating a Cable Box

To Do This ...	Press
Activate the remote control to operate the cable box	SAT/CABLE FUNCTION
Turn on/off	SAT/CABLE POWER
Select a channel	0-9, ENT
Change channels	CH +/-
Back to previous channel	JUMP

Operating a DVD Player

To Do This ...	Press
Activate the remote control to operate the DVD	DVD/VCR FUNCTION
Play	▶
Stop	■
Pause	⏸
Step through different tracks of the disc	▶▶ to step forward or ◀◀ to step backward
Step through different chapters of a video disc	CH+ to step forward or CH- to step backward
Display the DVD player Menu (Setup)	MENU
Display the DVD Menu	TOP MENU
Move highlight (cursor)	▲ ▼ ◀ ▶

Using the F1 and F2 Buttons

Using this Sony Device ...	F1 Selects	F2 Selects
DVD/VCR Combination	DVD source	VCR source
DVD HDD Combination	HDD source	DVD source
DVD Dream™ System	Input Select function (toggles through all inputs)	Disc Skip function
DVD Five- and Mega-Disc Changers	Disk Skip function	(no function)

Using the Features

Overview

This chapter describes how to use the features of your TV.

<i>Topic</i>	<i>Page</i>
Watching TV	52
Using Wide Mode	53
Using Twin View	55
Using Favorite Channels	58
Using the Freeze Function	59

Watching TV

 For a complete list of all the functions of the remote control, see pages 43-47.

To Do This ...	Do This ...
Activate the remote control to operate the TV	Press TV FUNCTION
Turn on/off the TV	Press TV POWER
Tune directly to a channel	To tune to channels, press 0-9 and then ENT.
Adjust the volume	Press VOL +/-
Mute the sound	Press MUTING (press again to unmute)
Alternate back and forth between two channels	Press JUMP The TV alternates between the current channel and the last channel tuned.
Display the current channel number (and other information)	Press DISPLAY once to display the channel number, current time, and channel label (if set). Press DISPLAY again to turn Display off.
Switch the TV's input to the VCR, DVD player, or other connected equipment	Press TV/VIDEO repeatedly to cycle through the video equipment connected to the TV's video inputs.
Change video and audio options, customize the TV's setup, set parental controls, and more	Press MENU to display the Menu. For details, see "Using the Menus" on page 61.
Switch the TV's input between sources connected to the TV's VHF/UHF and AUX inputs	Press ANT to alternate between sources connected to the TV's VHF/UHF and AUX inputs.









Using Wide Mode

 You can also access the Wide Mode settings in the Screen Menu. For details, see page 66.

The Wide Mode feature lets you change the picture size for both standard-definition (480i/480p) and high-definition (720p/1080i) sources.









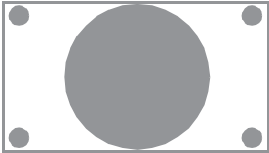

- Press **WIDE MODE** repeatedly to toggle through the following Wide Mode settings.

Using Wide Mode with Standard Definition (480i/480p) Sources

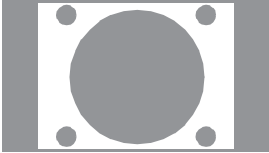
Example	Description
  Wide Zoom	Wide Zoom enlarges the center portion of the picture proportionately. The left and right edges of the picture are stretched to fill the 16:9 screen.
  Normal	Normal displays the 4:3 picture in its original size. Bars are shown to fill the 16:9 screen.
  Full	Full stretches the 4:3 picture horizontally, to fill the 16:9 screen.
  Zoom	Zoom enlarges the 4:3 picture proportionately to fill the 16:9 screen. Some clipping may occur. Zoom is useful for watching Letterbox movies.

When you change channels or inputs, the Wide Mode settings revert to the **4:3 Default** setting in the Screen Menu. To retain the current Wide Mode setting as channels and inputs are changed, set **4:3 Default** to **Off**. For details, see page 66.

Using Wide Mode with High-Definition (720p/1080i) Sources

Example	Description
  Full (native 16:9)	<p>Full displays the picture at its original size. If the source is a 16:9 high-definition (720p/1080i) signal, the picture fills the screen.</p> 
 Full (upconverted 4:3) ↓	<p>If the source is a 4:3 standard-definition signal that has been upconverted, bars are shown to fill the 16:9 screen.</p> 
  Wide Zoom	<p>Wide Zoom enlarges the center portion of the picture proportionately. The left and right edges of the picture are stretched to fill the 16:9 screen.</p> 
  Zoom	<p>Zoom enlarges the 4:3 picture proportionately to fill the 16:9 screen. Some clipping may occur. Zoom is useful for watching Letterbox movies.</p> 

When you change channels or inputs, the Wide Mode settings revert to the **4:3 Default** setting in the Screen Menu (only if the input source is 480i or 480p).

Using Twin View

Twin View lets you see two pictures from two sources — from an antenna, VCR, DVD, etc. — on the screen at the same time. You hear the sound from only one of the sources at a time, but you can choose which source's sound is selected. You can also change the relative size of each of the pictures.

Displaying Twin Pictures

- 1 Tune the TV to a working channel.
- 2 Press .

A second picture appears. The active picture is highlighted in blue.

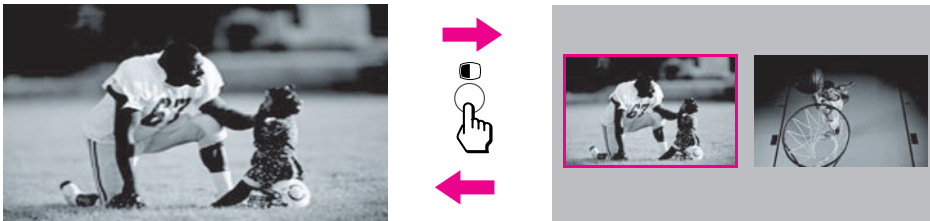

To cancel Twin View and watch the active picture

- Press  or .

Factors Affecting Twin View

- If you use a cable box to view all channels, the same channel appears in both windows of Twin View because the cable box unscrambles only one channel at a time.
- If you use a cable box, you can view the cable box output in one Twin View window and view a different source (such as a VCR or DVD player) in the second window by using the **TV/VIDEO** button. For details, see “Connecting Optional Equipment” on page 21.
- Sources connected to the AUX, VIDEO 5, VIDEO 6, and VIDEO 7 inputs display in the left Twin View window, but not the right.
- If you are viewing a 4:3 source and a 16:9 enhanced source (such as a DVD) side by side in Twin View, the 4:3 source appears larger.
- Twin View does not display channels that are blocked by parental settings (see page 69).

Activating the Picture

You can use the ◀ and ▶ buttons to activate the left and right pictures while using Twin View.

To Do This ...

To activate the picture in the right window

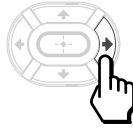

To activate the picture in the left window



Functions Available in the Active (Highlighted) Window

To Do This ...	Do This ...
Tune directly to a channel	To tune to channels, press 0-9 and then ENT or Press CH+/-
Adjust the volume	Press VOL +/-
Mute the sound	Press MUTING (press again to unmute)
Switch the TV's input between sources connected to the TV's VHF/UHF and AUX inputs	Press ANT (left window only)
Switch the TV's input between sources connected to the TV's A/V inputs	Press TV/VIDEO
Change the picture size	Press ▲ or ▼ . (For details, see "Changing the Picture Size" on page 57.)

Changing the Picture Size

The zoom feature lets you vary the relative size of the left and right pictures.

To Do This ...

Do This ...

Enlarge the active picture



Make the active picture smaller



When you adjust the picture sizes, the TV memorizes the change. The next time you use the Twin View function, the memorized sizes appear.



Using Favorite Channels

The Favorite Channels feature lets you select programs from a list of up to 16 favorite channels that you specify.

Creating a List of Favorite Channels



 For details on using the Channel Menu, see page 67.

- 1 Press **MENU** to display the Menu.
- 2 Press **◀** or **▶** to highlight the Channel icon and press **⏏**.
- 3 Press **⏏** to select **Favorite Channels**.
- 4 Press **▲** or **▼** to highlight a Favorite Channel number (1-16) and press **⏏**.
- 5 Press **▲** or **▼** to highlight a channel you want to assign to the Favorite Channel number. A preview of the highlighted channel appears in the upper right of the screen. Press **⏏** to select that channel as a Favorite Channel.
- 6 To add more channels to your favorites list, repeat steps 4-5. To clear a Favorite Channel, press **▲** or **▼** to highlight the channel you want to clear. Press **⏏** and then press **RESET**.
- 7 Press **MENU** to exit the Menu.

Displaying a List of Favorite Channels



 To assign Channel Labels (e.g., ABC, HBO, MTV, etc.) to channel numbers, as shown at right, use the Channel Label feature in the Channel Menu (see page 68).

- 1 Press **FAVORITES**. The Favorite Channels list appears.

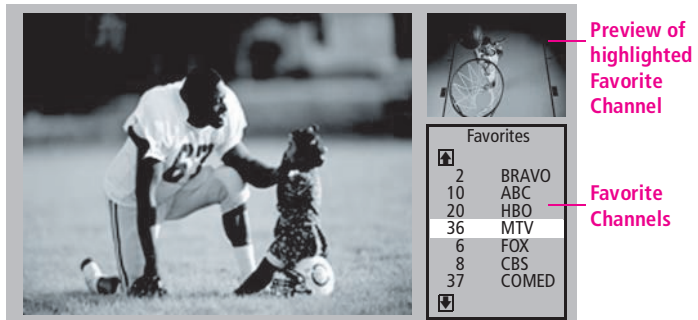

- 2 Press **▲** or **▼** to highlight the channel you want to watch. A preview of the highlighted Favorite Channel appears.
- 3 Press **⏏** to select the channel you want to watch.

Using the Freeze Function

The **FREEZE** button allows you to temporarily capture a program's picture. You can use this feature to write down information such as phone numbers, recipes, etc.

 **The Freeze feature is not available while you are using the Twin View.**

- 1 When the program information you want to capture is displayed, press **FREEZE**.
- 2 The TV switches to Twin View mode and displays the "frozen" picture on the right, while the current program continues on the left.



Current
program
in progress









Frozen
picture

- 3 To cancel and return to normal viewing, press **FREEZE** (or just tune to another channel).

Using the Menus



Overview

The Menu gives you access to the following features:

Menu Icon	Description	Page
	Allows you to make adjustments to your picture settings. It also allows you to customize the Picture Mode based on the type of program you are viewing, select Advanced Video options, and more.	62
	Offers enhanced audio options such as listening to second audio programming (SAP) or customizing the Effect of the sound on your TV.	64
	Allows you to make Wide Mode adjustments and make changes to the screen's vertical center.	66
	Allows you to set up a Favorite Channels list, run the Auto Program function, skip and label channels, and more.	67
	Lets you control the viewing of programs based on their ratings.	69
	Provides options for setting up your system, including selecting closed caption modes, setting the Timer, labeling video inputs, selecting the language of the on-screen menus, and more.	72

 Press **MENU** to enter and exit Menus.

Navigating Through Menus

To Do This ...	Press
Display the Menu	MENU
Move through the Menu	← →
Move through the Menu options	↑ ↓
Select an option to change	
Change an option's settings	↑ ↓ ← →
Select (confirm) changed setting	 or ←
Exit the Menu	MENU

 Menus include navigation help text that appears at the bottom of each Menu.

Using the Video Menu



To access the Video Menu, follow these steps:

1. Display Menu

MENU



2. Highlight



3. Select



To change settings, press **↑ ↓ ← →**.
Press **⊕** to confirm the selection.

To exit the Menu, press **MENU**.

Selecting Video Options



To change from one Mode to another, use the **PICTURE MODE** button on the remote control.





You can alter the Video Menu settings (**Picture**, **Brightness**, **Color**, etc.) for each Mode.

The Video Menu includes the following options:

Option	Description
Mode	
Vivid	Select for enhanced picture contrast and sharpness.
Customized picture viewing	
Standard	Select for standard picture settings.
Movie	Select to display a film-like picture.
Pro	Select to display a picture with minimum enhancements.
Picture	Adjust to increase picture contrast and deepen the color, or decrease picture contrast and soften the color.*
Brightness	Adjust to brighten or darken the picture.*
Color	Adjust to increase or decrease color intensity.
Hue	Adjust to increase or decrease the green tones.
Sharpness	Adjust to sharpen or soften the picture.
Color Temp.	
Cool	Select to give the white colors a blue tint.
White intensity adjustment	
Neutral	Select to give the white colors a neutral tint.
Warm	Select to give the white colors a red tint (NTSC-Standard).
ClearEdge VM Velocity Modulation	Sharpens picture definition to give every object a sharp, clean edge. Select from High , Medium , Low , Off .

* Image retention is accelerated by higher "Brightness" and "Picture" settings. See page 1 for information on image retention.

 **DRC Mode** options are not available (grayed out) when watching 480p, 720p, and 1080i sources.

 For best results, use CineMotion with Video 5 or 6 (HD/DVD IN) or Video 7 (HDMI IN).

Option	Description
Advanced Video	Select Program to choose among the DRC Mode and Noise Reduction options while viewing NTSC sources.
DRC Mode	Creates a high-resolution picture with 4x density, for high quality sources (i.e., DVD player, satellite receiver).
Interlaced	Recommended for moving pictures.
Progressive	Recommended for still images and text.
CineMotion	Provides an optimized display by automatically detecting film content and applying a reverse 3-2 pulldown process. Moving pictures will appear clearer and more natural-looking.
Noise Reduction	On Reduces repetitive random noise. Off Turns off Noise Reduction.

* Image retention is accelerated by higher "Brightness" and "Picture" settings. See page 1 for information on image retention.

To restore the factory default settings for the Video settings (excluding DRC Mode) of the Mode setting (Vivid, Standard, etc.) the TV is set to:

- Press **RESET** on the remote control when in the Video Menu.

Using the Audio Menu



To access the Audio Menu, follow these steps:

1. Display Menu

MENU



2. Highlight

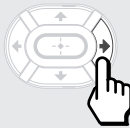

3. Select

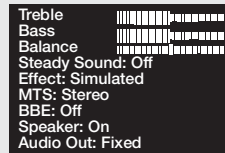

To change settings, press **↑ ↓ ← →**.
Press **⏏** to confirm the selection.

To exit the Menu, press **MENU**.

Selecting Audio Options

The Audio Menu includes the following options:

Option	Description
Treble	Adjust to decrease or increase higher-pitched sounds.
Bass	Adjust to decrease or increase lower-pitched sounds.
Balance	Adjust to emphasize left or right speaker balance.
Steady Sound	On Select to stabilize the volume.
	Off Select to turn off Steady Sound.
Effect	TruSurround Select for surround sound (for stereo programs only).
	Simulated Adds a surround-like effect to mono programs.
	Off Normal stereo or mono reception.
MTS <i>Enjoy stereo, bilingual and mono programs</i>	Stereo Select for stereo reception when viewing a program broadcast in stereo.
	Auto SAP Select to automatically switch the TV to second audio programs when a signal is received. (If no SAP signal is present, the TV remains in Stereo mode.)
	Mono Select for mono reception. (Use to reduce noise during weak stereo broadcasts.)
BBE	On Select to give sound more impact by compensating for phase effects in speakers.
	Off Select for normal stereo or mono reception.

 To change quickly from one Effect to another, use the **⏏** button on the remote control.

<i>Option</i>	<i>Description</i>
Speaker	On Select to turn on the TV speakers.
	Off Select to turn off the TV speakers and listen to the TV's sound only through your external audio system speakers.
Audio Out <i>Easy control of volume adjustments</i>	This option can be set only when the Speaker option is set to Off .
	Variable The TV's speakers are turned off, but the audio output from your audio system can still be controlled by the TV's remote control.
	Fixed The TV's speakers are turned off and the audio output of the TV is fixed. Use your audio receiver's remote control to adjust the volume (and other audio settings) through your audio system.

To restore the factory default settings for Treble, Bass, and Balance

- Press **RESET** on the remote control when in the Audio Menu.

Using the Screen Menu



To access the Screen Menu, follow these steps:

1. Display Menu



2. Highlight

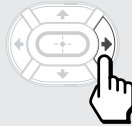

3. Select



Wide Mode: Wide Zoom
4:3 Default: Wide Zoom
Vertical Center

To change settings, press **↑ ↓ ← →**.
Press **⊕** to confirm the selection.

To exit the Menu, press **MENU**.

Selecting Screen Options



To change from one Wide Mode to another, use the **WIDE MODE** button on the remote control.

The Screen Menu includes the following options:

Option	Description
Wide Mode	Enables you to change the picture size for both standard-definition (480i/480p) and high-definition (720p/1080i) sources. For 480i/480p sources Select from: Wide Zoom, Normal, Full, Zoom . For details, see page 53. For 720p/1080i sources Select from: Full, Wide Zoom, Zoom . For details, see page 54. Wide Mode is unavailable while in Twin View. In some cases, wide-screen programs will be shown in aspect ratios that require the display of bars at the top and bottom of your 16:9 screen. For more details, see page 79.
4:3 Default	Select the default Wide Mode to use for 4:3 sources. To select a Wide Mode to use when channels or inputs are changed, select from: Wide Zoom, Normal, Full, Zoom . For details, see page 53. To continue using the current Wide Mode setting when the channel or input is changed, select Off .
Vertical Center	Allows you to move the position of the picture up and down in the window. (Available only in Wide Zoom and Zoom modes.) Press ↑ or ↓ and press ⊕ to choose a correction between +15 and -15 (Zoom mode), and +10 and -10 (Wide Zoom mode).

Using the Channel Menu



To access the Channel Menu, follow these steps:

1. Display Menu



2. Highlight

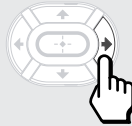

3. Select



Favorite Channels
Cable: On
Channel Fix: Off
Auto Program
Channel Skip/Add
Channel Label

To change settings, press **↑ ↓ ← →**.
Press **⏏** to confirm the selection.

To exit the Menu, press **MENU**.

Selecting Channel Options

The Channel Menu includes the following options:

Option	Description
Favorite Channels	Lets you set up a list of your favorite channels. For details, see "Using Favorite Channels" on page 58.
Cable	<p>On Select if you are receiving cable channels with a CATV cable.</p> <p>Off Select if you are using an antenna.</p> <p> You should run Auto Program after changing this option.</p>
Channel Fix	<p>Off Turns off Channel Fix.</p> <p>2-6 "Fix" your TV's channel setting to 2-6 and use the cable box or satellite receiver to change channels. Select one of these settings if you connected the equipment to the VHF/UHF jack.</p> <p>AUX 2-6 Same as 2-6, except you select one of these settings if you connected the equipment to the AUX jack (see page 13).</p> <p>Video 1 Use this setting if you have connected the equipment to the A/V input jacks.</p>
Auto Program	Automatically sets up the channel list on the TV for all receivable channels.



Channels that you set to be skipped can be accessed only by direct (0-9 buttons) tuning.

<i>Option</i>	<i>Description</i>
Channel Skip/Add	<p>Allows you to customize the channels that appear when you use the CH+/- buttons.</p> <ol style="list-style-type: none">1 Press ▲ or ▼ to scroll through the channels until you find the channel you want to skip or add. Then press ⏪ to select it.2 Press ▲ or ▼ to toggle between Add or Skip. Then press ⏪ to select.3 To add or skip more channels, repeat steps 1 and 2.4 Press ◀ to return to the Channel Menu, or press MENU to exit the Menus.
Channel Label	<p>Allows you to assign labels (such as station call letters) to channel numbers. You can label up to 40 channels.</p> <ol style="list-style-type: none">1 Highlight Channel and press ⏪.2 Press ▲ ▼ to scroll through the channel numbers. Then press ⏪ to select the channel number that you want to assign a label.3 Highlight Label and press ⏪.4 Press ▲ ▼ to scroll through the label characters (A-Z, 0-9, etc.). Then press ⏪ to select the highlighted character. Repeat to add up to 5 characters to the label.5 To assign labels to more channels, repeat steps 1-4.6 Press ◀ to return to the Channel Menu, or press MENU to exit the Menus.

Using the Parent Menu



The Parent Menu allows you to set up the TV to block programs according to their content and rating levels.

To access the Parent Menu, follow these steps:

1. Display Menu



2. Highlight



3. Select

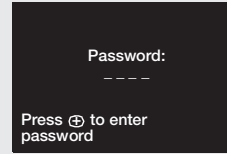

Use the 0-9 buttons on the remote control to enter a four-digit password.

If this is the first time you are creating this password, confirm the password by entering it again. (The Parent Menu options appear.)

To change settings, press **↑ ↓ ← →**. Press **[OK]** to confirm the selection.

To exit the Menu, press **MENU**.

🔑 You need your password for any future access into the Parent Menu. If you lose your password, see "Lost password" on page 80.

Setting Parent Menu Options

💡 If you are not familiar with the Parental Guideline rating system, you should select **Child**, **Youth**, or **Young Adult** to help simplify the rating selection. To set more specific ratings, select **Custom**.

💡 For descriptions of **Child**, **Youth**, and **Young Adult** ratings, see page 70.

The Parent Menu includes the following options:

Option	Description
Parental Lock	Off Parental lock is off. No programs are blocked from viewing.
Turn ratings on/off and select a rating system	<p>Child Maximum ratings permitted are:</p> <ul style="list-style-type: none"> <input type="checkbox"/> US: TV-Y, TV-G, G <input type="checkbox"/> Canada: C, G, TV-Y <p>Youth Maximum ratings permitted are:</p> <ul style="list-style-type: none"> <input type="checkbox"/> US: TV-PG, PG <input type="checkbox"/> Canada: C8+, PG, 8 ans+, TV-PG <p>Y. Adult Maximum ratings permitted are:</p> <ul style="list-style-type: none"> <input type="checkbox"/> US: TV-14, PG-13 <input type="checkbox"/> Canada: 14+, 13 ans+, TV-14 <p>Custom Select to set ratings manually.</p> <ul style="list-style-type: none"> <input type="checkbox"/> US: See page 70 for details. <input type="checkbox"/> Canada: See page 71 for details.
Change Password	For changing your password.
Select Country	<p>U.S.A. Select to use USA ratings (see page 70).</p> <p>Canada Select to use Canadian ratings (see page 71).</p>

US Models: Selecting Custom Rating Options

 The Content-Based Ratings are linked to the level of the Age-Based Rating. For example, a program with an Age-Based Rating of TV-PG V (Violence) rating may contain moderate violence, while a TV-14 V (Violence) rating may contain more intense violence.

 To ensure maximum blocking capability, set the Age-Based Ratings.

 If you block unrated TV programs, be aware that the following types of programs may be blocked: emergency broadcasts, political programs, sports, news, public service announcements, religious programs and weather.

For US models, the Custom Rating Menu includes the following options. (For Canadian models, see page 71.)

Option	Description
Movie Rating	G All children and General Audience.
	PG Parental Guidance suggested.
	PG-13 Parental Guidance for children under 13.
	R Restricted viewing, parental guidance is suggested for children under 17.
	NC-17 and X No one 17 or under allowed.
TV Rating <i>Block programs by their rating, content or both</i>	Age-Based Ratings
	TV-Y All children.
	TV-Y7 Directed to children age 7 and older.
	TV-G General Audience.
	TV-PG Parental Guidance suggested.
	TV-14 Parents Strongly cautioned.
	TV-MA Mature Audience only.
Content-Based Ratings	
FV Fantasy Violence.	
D Suggestive Dialogue.	
L Strong Language.	
S Sexual situations.	
V Violence.	
Unrated <i>Block programs or movies that are broadcast without a rating</i>	Block Blocks all programs and movies that are broadcast without a rating.
	Allow Allows programs and movies that are broadcast without a rating.

Viewing Blocked Programs

You can view blocked programs by entering the password. Press the **ENT** (ENTER) button when tuned to a blocked program, then enter the password. This temporarily switches off the Parental Lock. To reactivate the Parental Lock settings, turn off the TV. When the TV is turned on again, your Parental Lock settings are reactivated.

Canadian Models: Selecting Custom Rating Options

For Canadian models, the Custom Rating Menu includes the following options. (For US models, see page 70.)

Option	Description	
English Rating	C	All children.
	C8+	Children 8 years and older.
	G	General programming.
	PG	Parental Guidance.
	14+	Viewers 14 and older.
	18+	Adult programming.
French Rating	G	General programming.
	8 ans+	Not recommended for young children.
	13 ans+	Not recommended for ages under 13.
	16 ans+	Not recommended for ages under 16.
	18 ans+	Programming restricted to adults.
U.S.A. Rating	See "US Models" on page 70 for details.	

Viewing Blocked Programs

You can view blocked programs by entering the password. Press the **ENT** (ENTER) button when tuned to a blocked program, then enter the password. This temporarily switches off the Parental Lock. To reactivate the Parental Lock settings, turn off the TV. When the TV is turned on again, your Parental Lock settings are reactivated.

Using the Setup Menu



To access the Setup Menu, follow these steps:

1. Display Menu

MENU



2. Highlight

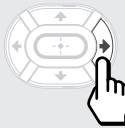

3. Select



Caption Vision: Off
Info Banner
Video Label
Language: English
Clock/Timers
Flash Focus
Convergence

To change settings, press **↑ ↓ ← →**.
Press **⏏** to confirm the selection.

To exit the Menu, press **MENU**.

Selecting Setup Options

 If DISPLAY is on, Caption Vision automatically dims after three seconds to prevent image burn-in.

The Setup Menu includes the following options:

Option	Description	
Caption Vision	Allows you to select from three closed caption modes (for programs that are broadcast with closed caption).	
	CC1, CC2, CC3, CC4	Displays a printed version of the dialog or sound effects of a program. (Should be set to CC1 for most programs.)
	Text1, Text2, Text3, Text4	Displays network/station information presented using either half or the whole screen (if available). For closed captioning, set to CC1 .
Off	Turns off Caption Vision.	
Info Banner	Displays the program name and the time remaining in the program (if the broadcaster offers this service). Displays when the channel is changed or the DISPLAY button is pressed. Set to On or Off .	







Option	Description							
Video Label	<p>Allows you to identify A/V equipment you connected to the TV, such as a VCR, DVD, etc. For example, if you have a DVD player connected to the VIDEO 5 jack, you can select the label DVD for the VIDEO 5 input. Then when you press the TV/VIDEO button to change inputs, the Video Label you assigned to that input appears on screen.</p> <ol style="list-style-type: none"> Press ▲ or ▼ to highlight the video input (VIDEO 1-7) to which you want to assign a label. Then press ⏪ to select the input. Press ▲ or ▼ to highlight one of the displayed labels. Then press ⏪ to select the label. <p>You can select from the following labels for each input:</p> <table border="1"> <tr> <td>Video 1/2/3/4</td> <td>VHS, DVD, Receiver, Satellite, Cable Box, 8mm, DTV, LD, Beta, Skip</td> </tr> <tr> <td>Video 5/6/7</td> <td>DVD, Satellite, Cable Box, DTV, HD, Skip</td> </tr> </table> <p> If you select Skip, your TV skips this input when you press the TV/VIDEO button.</p>	Video 1/2/3/4	VHS, DVD, Receiver, Satellite, Cable Box, 8mm, DTV, LD, Beta, Skip	Video 5/6/7	DVD, Satellite, Cable Box, DTV, HD, Skip			
Video 1/2/3/4	VHS, DVD, Receiver, Satellite, Cable Box, 8mm, DTV, LD, Beta, Skip							
Video 5/6/7	DVD, Satellite, Cable Box, DTV, HD, Skip							
Language	Select to display all on-screen Menus in your language of choice.							
Clock/Timers	<p>Select to set the clock and to program your TV to turn on and off at two scheduled viewing times.</p> <table border="1"> <tr> <td>Timer 1</td> <td rowspan="2">You can use the Timers to program the TV to turn on and off and tune to a specific channel at two scheduled viewing times.</td> </tr> <tr> <td>Timer 2</td> </tr> </table> <p>Timer 1 and Timer 2 are not available to be set until you set the Current Time.</p> <ol style="list-style-type: none"> Press ▲ or ▼ to highlight Timer 1 or Timer 2. To set the timer, press ➡. Press ▲ or ▼ to highlight one of the following options, then press ⏪. <table border="1"> <tr> <td>Program</td> <td>Select to set the Timer by day, time, duration, and channel.</td> </tr> <tr> <td>Off</td> <td>Select to turn off the Timer. (Your previous settings are saved.)</td> </tr> </table> If you selected Program in step 2, press ▲ and ▼ to set the day(s), hour, minute, duration, and channel number. Press ⏪ or press ➡ to confirm each setting and move to the next setting. Press ◀ to go back to the previous setting. Press MENU to exit the Menu. An LED on the front panel will light, indicating the timer has been set. 	Timer 1	You can use the Timers to program the TV to turn on and off and tune to a specific channel at two scheduled viewing times.	Timer 2	Program	Select to set the Timer by day, time, duration, and channel.	Off	Select to turn off the Timer. (Your previous settings are saved.)
Timer 1	You can use the Timers to program the TV to turn on and off and tune to a specific channel at two scheduled viewing times.							
Timer 2								
Program	Select to set the Timer by day, time, duration, and channel.							
Off	Select to turn off the Timer. (Your previous settings are saved.)							

 The **Skip** label is useful for inputs that do not have equipment connected to them.

 To go directly to programming Timer 1 or 2, press **⊕** instead of pressing **➡**.



You can also access Flash Focus by pressing the **FLASH FOCUS** button on the front panel of the TV.

<i>Option</i>	<i>Description</i>
Clock/Timers (continued)	Current Time <hr/> <ol style="list-style-type: none">1 Press  to select Current Time.2 Press  and  to set the current time (day, hour, and minute). Press  (or press ) to confirm each setting and move to the next setting. Press  to go back to the previous setting.3 Press MENU to exit the Menu. <hr/>
Flash Focus	Allows you to adjust the convergence automatically. For details, see page 40.
Convergence	Allows you to fine-tune the convergence manually. For details, see page 41.

Other Information

Overview

This chapter includes the following topics:

<i>Topic</i>	<i>Page</i>
Glossary	76
Contacting Sony	77
Troubleshooting	77
Specifications	81
Optional Accessories	82
Index	83

Glossary

analog signal

A signaling method that uses continuous changes in the amplitude or frequency of an electronic transmission to convey information.

aspect ratio

Refers to the ratio between the width and height of the screen. This TV has a 16:9 (widescreen) aspect ratio, as opposed to a 4:3 aspect ratio.

4:3 aspect ratio



16:9 aspect ratio



component video



Component video is sent through three cables: two color shade (chrominance) signals and one brightness (luminance) signal. Component video achieves greater color accuracy than composite video or S VIDEO by splitting chrominance into two separate portions.

composite video



Composite video is sent through a single cable. Composite video combines the color shade (chrominance) and brightness (luminance) information into one video signal.

HDMI (High-Definition Multimedia Interface)

Provides an uncompressed, all-digital audio/video interface between this TV and any HDMI-equipped audio/video component, such as a set-top box, DVD player, and A/V receiver. HDMI supports enhanced, or high-definition video, plus two-channel digital audio.

National Television System Committee (NTSC)

A unit of the Federal Communications Commission, Washington, DC, that establishes television standards in the United States, such as NTSC Color, the standard used in this TV.

RF

Radio Frequency. That part of the frequency spectrum that is used to transmit TV and radio signals.

S VIDEO



S VIDEO requires a single cable, which carries the brightness (luminance) and color (chrominance) signals of the picture separately. S VIDEO provides better resolution than composite video, which carries the signals together.

VHF/UHF

VHF (Very High Frequency) is the part of the frequency spectrum from 30 to 300 megahertz. UHF (Ultra High Frequency) is the part of the frequency spectrum from 300 to 3,000 megahertz.

480i

Provides 480 lines of resolution. Displays images using interlaced scanning, which first transmits all the odd lines on the TV screen and then the even lines.

480p

Provides 480 lines of resolution. Displays images using progressive scanning, which transmits each line from top to bottom.

720p

Provides 720 lines of resolution. Displays images using progressive scanning, which transmits each line from top to bottom.

1080i

Provides 1080 lines of resolution. Displays images using interlaced scanning, which first transmits all the odd lines on the TV screen and then the even lines. 1080i is one of the formats used by HDTV (High Definition TV).

Contacting Sony

If, after reading these operating instructions, you have additional questions related to the use of your Sony television, please call our Customer Information Services Center at 1-800-222-SONY (7669) (US residents only) or (416) 499-SONY (7669) (Canadian residents only).

Before calling Sony customer support, please write down the model and serial numbers of your TV. You'll find this information on the front cover of this manual.

Troubleshooting

If you are having problems with your TV, you can reset all the TV's settings to their original factory default settings, as follows.

 **Notice:** The following procedure resets all custom settings, channel lists, etc., to the factory default settings.

- 1 Turn on the TV.
- 2 Hold down the **RESET** button on the remote control.
- 3 Press the **POWER** button on the front panel of the TV.
- 4 Release the **RESET** button on the remote control.

Twin View

Problem	Possible Remedies
I cannot get Twin View to work	<ul style="list-style-type: none">❑ If you are using a cable box to unscramble all channels (as shown on page 20), you cannot use the Twin View feature. This is because the cable box can unscramble only one channel at a time. But if you need the cable box to unscramble only some (usually premium) channels, you can use Twin View for unscrambled channels if you connect both a cable and cable box, as shown on page 18.❑ You can use Twin View to view a signal from a different source that is connected to the TV's A/V jacks (such as a VCR or DVD player) in the second window by pressing the TV/VIDEO button while in Twin View.❑ Sources connected to the AUX, VIDEO 5, VIDEO 6, and VIDEO 7 inputs, as well as digital sources, display in the left Twin View window, but not the right.
There is no Twin View window, or it is just static	<ul style="list-style-type: none">❑ Be sure the Twin View window is set to a video input or channel that has a signal airing.❑ You might be tuned to a video input with nothing connected to it. Try cycling through the video inputs by pressing the TV/VIDEO button.
Twin View cannot display anything but TV channels	<ul style="list-style-type: none">❑ Try cycling through the video inputs by pressing the TV/VIDEO button. Check that the Video Label option is not set to Skip. (See the Setup Menu on page 73.)
Twin View displays the same program in both windows	<ul style="list-style-type: none">❑ Both Twin View windows might be set to the same channel. Try changing channels in either window.

Remote Control

Problem	Possible Remedies
Remote control does not operate	<ul style="list-style-type: none">❑ The batteries could be weak. Replace the batteries.❑ Check the orientation of the batteries.❑ Press the TV FUNCTION button. You may have inadvertently pressed the SAT/CABLE FUNCTION button, which changes the remote control to SAT or CABLE mode.❑ Make sure the TV's power cord is connected securely to the wall outlet.❑ Locate the TV at least 3-4 feet away from fluorescent lights.
Cannot change channels with the remote control	<ul style="list-style-type: none">❑ If you are using the TV to change channels, first press the TV FUNCTION button.❑ If you are using another device to change channels, be sure you have not inadvertently switched your TV from the channel 3 or 4 setting. Use the Channel Fix option to "fix" the channel based on the hookup you used (see page 67).❑ If you are using another device to change channels, be sure to press the FUNCTION button for that device. For example, if you are using your cable box to change channels, be sure to press the SAT/CABLE FUNCTION button.
Remote control does not operate non-Sony video equipment	<ul style="list-style-type: none">❑ If you replaced the batteries to the remote recently, the code numbers for the video equipment may need to be reset.❑ There may be more than one code for the equipment that you are attempting to operate.❑ There is a possibility that some non-Sony equipment cannot be operated by your Sony TV remote. You may need to use the equipment's original remote control.

Channels

Problem	Possible Remedies
Cannot receive upper channels (UHF) when using an antenna	<ul style="list-style-type: none">❑ Use Auto Program in the Channel Menu to add receivable channels that are not presently in the TV's memory (see page 67).
TV is fixed to one channel	<ul style="list-style-type: none">❑ Use Auto Program in the Channel Menu to add receivable channels that are not presently in the TV's memory (see page 67).❑ Check your Channel Fix settings (see page 67).
Cannot receive any channels when using cable TV	<ul style="list-style-type: none">❑ Use Auto Program in the Channel Menu to add receivable channels that are not presently in the TV's memory (see page 67).
Cannot receive or select channels	<ul style="list-style-type: none">❑ Use Auto Program in the Channel Menu to add receivable TV channels that are not presently in TV memory (see page 67).

Video

Problem	Possible Remedies
No picture (screen not lit), no sound	<ul style="list-style-type: none">❑ If your TV does not turn on, and a red light keeps flashing, your TV may need service. Call your local Sony Service Center.❑ Make sure the power cord is plugged in.❑ Press the POWER button on the front of the TV.❑ Press the TV/VIDEO button to cycle through the connected video sources.❑ Try another channel; it could be station trouble.
Dark, poor or no picture (screen lit), good sound	<ul style="list-style-type: none">❑ Adjust the Picture option in the Video Menu (see page 62).❑ Adjust the Brightness option in the Video Menu (see page 62).❑ Check the antenna/cable connections.
No Video on VIDEO 3 Input	<ul style="list-style-type: none">❑ Check to be sure that you have not connected both S VIDEO and composite video cables to the VIDEO 3 input. You can use S VIDEO or composite video inputs for VIDEO 3, but not both.
No color	<ul style="list-style-type: none">❑ Adjust the Color option in the Video Menu (see page 62).
Only snow and noise appear on the screen	<ul style="list-style-type: none">❑ Check the antenna/cable connections.❑ Try another channel; it could be station trouble.❑ Press ANT to change the input mode (see page 45).
Dotted lines or stripes	<ul style="list-style-type: none">❑ Adjust the antenna.❑ Move the TV away from noise sources such as cars, neon signs, or hair-dryers.
Double images or ghosts	<ul style="list-style-type: none">❑ Using a highly directional outdoor antenna or a cable may solve the problem.
“Black box” on screen	<ul style="list-style-type: none">❑ You have selected a text option in the Setup Menu and no text is available. (See page 72 to reset Setup selections.) To turn off this feature, set the Caption Vision option to Off. If you were trying to select closed captioning, select CC1 instead of Text 1-4.
Bars appear at the top and bottom of the screen	<ul style="list-style-type: none">❑ Some wide-screen programs are filmed in aspect ratios that are greater than 16:9 (this is especially common with theatrical releases). Your TV will show these programs with bars at the top and bottom of the screen. For more details, check the documentation that came with your DVD (or contact your program provider).
Certain programs on DVD or other digital sources display a loss of detail, especially during fast-motion or dark scenes	<ul style="list-style-type: none">❑ The compression used by certain digital broadcasts and DVDs may cause your TV's screen to display less detail than usual, or cause artifacts (small blocks or dots, pixelations) to appear on your screen. This is due to your TV's large screen and ability to show very fine detail, and is normal for certain digitally recorded programs.

Audio

Problem	Possible Remedies
Good picture, no sound	<ul style="list-style-type: none">❑ Press MUTING so that Muting disappears from the screen (see page 44).❑ Make sure the Speaker option is set to On in the Audio Menu (see page 65).
Cannot gain enough volume when using a cable box	<ul style="list-style-type: none">❑ Increase the volume of the cable box using the cable box's remote control. Then press TV FUNCTION and adjust the TV's volume.
Sound seems weak or insufficient	<ul style="list-style-type: none">❑ The TV's audio might be set to Auto SAP or Mono, when it might be better set to Stereo. In the Audio Menu (see page 64), set the MTS setting to Stereo. If already set to Stereo, switch to Mono (which may reduce background noise during weak stereo broadcasts).
Cannot raise the volume on external audio speakers	<ul style="list-style-type: none">❑ If the Speaker option is set to Off and the Audio Out option is set to Fixed (in order to output the sound to your audio system) use your audio receiver to adjust the sound (see page 64). Or, to use the TV remote control, set the Audio Out option to Variable.❑ To turn on the TV speakers, set the Speaker option to On (see page 64).

General

Problem	Possible Remedies
How to reset TV to factory settings	<ul style="list-style-type: none">❑ Turn on the TV. While holding down the RESET button on the remote control, press the POWER button on the TV. (The TV will turn itself off, then back on again.) Release the RESET button.
How to restore Video settings to factory settings	<ul style="list-style-type: none">❑ Press the RESET button on the remote control while in the Video Menu (see page 63).
How to restore Audio settings to factory settings	<ul style="list-style-type: none">❑ Press the RESET button on the remote control while in the Audio Menu (see page 65).
Cannot cycle through the other video equipment connected to the TV	<ul style="list-style-type: none">❑ Be sure the Video Label option is not set to Skip (see page 73).
Cannot operate Menu	<ul style="list-style-type: none">❑ If a menu option appears in gray, this indicates that the TV is in a state in which the menu option is not available.
Lost password	<ul style="list-style-type: none">❑ In the password screen (see page 69), enter the following master password: 4357. The master password clears your previous password; it cannot be used to temporarily unblock channels.
LED on front panel is lit	<ul style="list-style-type: none">❑ The STAND BY LED (see page 12) blinks when the TV is turned on, then shuts off when the picture is displayed. If the LED blinks continuously, this may indicate the TV needs service.❑ The TIMER LED (see page 12) indicates that the timer is set. When the timer is set, this LED will remain lit even when the TV is turned off.

Specifications

Projection System	3 picture tubes, 3 lenses, horizontal in-line system	
Picture Tube	7-inch high-brightness monochrome tubes (6.3 raster size), with optical coupling and liquid cooling system	
Projection Lenses	High performance, large diameter hybrid lens F1.1	
Antenna	75 ohm external terminal for VHF/UHF	
Television System	NTSC	American TV Standard
Channel Coverage	VHF	2-13
	UHF	14-69
	CATV	1-125
Power Requirements	120V, 60 Hz	
Inputs/Outputs		
HDMI IN	Video	1080i, 720p, 480p, 480i
	Audio	Two channel linear PCM 32, 44.1 and 48 kHz, 16, 20 and 24 bit
Video (IN)	4 total (1 on front panel)	1 Vp-p, 75 ohms unbalanced, sync negative
S Video (IN)	3 total (1 on front panel)	Y: 1 Vp-p, 75 ohms unbalanced, sync negative
		C: 0.286 Vp-p (Burst signal), 75 ohms
Audio (IN)	7 total (1 on front panel)	500 mVrms (100% modulation) Impedance: 47 kilohm
Component Video Input	2 (Y, P _B , P _R)	Y: 1.0 Vp-p, 75 ohms unbalanced, sync negative; P _B : 0.7 Vp-p, 75 ohms P _R : 0.7 Vp-p, 75 ohms
CONTROLS (IN/OUT)	1	
Variable/Fixed Audio (OUT)	1	More than 408 mVrms at the maximum volume setting (Variable)
		More than 408 mVrms (Fixed)
		Impedance (output): 2 kilohms
Supplied Accessories	Remote Control	RM-Y916
	AA (R6) Batteries	2 supplied for remote control
Screen Size (measured diagonally)	KP-46WT520	46 inches
	KP-51WS520	51 inches
	KP-57WS520	57 inches
Speaker Output	20W x 2	
Dimensions (W x H x D)	KP-46WT520	1086 x 1017 x 609 mm (42 3/4 x 40 x 24 in)
	KP-51WS520	1194 x 1280 x 666 mm (47 x 50 1/2 x 26 1/4 in)
	KP-57WS520	1326 x 1377 x 692 (52 1/4 x 54 1/4 x 27 1/4 in)
Mass	KP-46WT520	61.3 Kg (135 lbs)
	KP-51WS520	77.2 Kg (170 lbs)
	KP-57WS520	88 Kg (194 lbs)
Power Consumption	In Use	235 W
	In Standby	Under 1 W

Design and specifications are subject to change without notice.

Optional Accessories

- ❑ A/V Cable (VMC-810/820/830 HG)
- ❑ Audio Cable (RKC-515HG)
- ❑ Component Video Cable (VMC-10/30 HG)
- ❑ Control S Cable (RK-G69HG)
- ❑ TV Stand for KP-46WT520 (SU-46WT11)

Index

0-9 buttons 44, 52, 56
4:3 Default settings 66

A

Advanced Video 63
ANT button 45, 52
antenna, connecting 15
Audio Menu 61
Audio Out 65
AUDIO OUT jack 13
audio receiver, connecting 35
Auto Program (channel setup) 39, 67
Auto SAP, MTS setting 64
AUX jack, described 13

B

balance, adjusting 64
bass, adjusting 64
batteries, inserting in remote 43
BBE 64
bilingual audio 64
blocking programs. *See ratings.*
brightness, adjusting 62

C

cable
connecting 15
with VCR, connecting 24
cable box
connecting with VCR 26
Twin View issues 55
using with TV remote control 49
Cable setting 67
Caption Vision 72
carrying the TV 10
CATV. *See cable*
CH buttons 12, 45
changing picture size, in Twin View 57

Channel Fix 67
Channel Menu 61
Channel Skip/Add 68
channels, creating labels 68
CineMotion 8, 63
ClearEdge VM 7, 62
clearing, Favorite Channels 58
closed caption modes 61, 72
color, adjusting 62
CONTROL S 38
CONTROL S IN/OUT jacks, described 13
Convergence 12, 74
adjusting automatically 40
adjusting manually 41
convergence 74
Cool, Color Temperature 62

D

Digital Reality Creation 7
DISPLAY button 45, 52, 72
DRC Mode 63
DRC. *See Digital Reality Creation.*
DVD Dream™ System 49
DVD Five- and Mega-Disc Changers 49
DVD HDD Combination 49
DVD player
connecting 32, 33
using with TV remote control 49
DVD/VCR Combination 49
DVD/VCR FUNCTION button 44
DVD/VCR POWER button 44
DVI (Digital Video Interface) 36

E

Effect button 45
ENTER button 44, 52, 56

F

F1/F2 buttons 45
Fast-forward button 44
Favorite Channels
clearing 58
in Channel Menu 67
using 58
FAVORITES button 45
features 7
Fixed audio setting 65
Flash Focus 40, 74
FLASH FOCUS button 12
FREEZE button 44, 59
Freeze, using 59
Full 53, 54

G

GUIDE button 45

H

HD Detailer 8
HD/DVD IN (1080i/720p/480p/480i) jacks, described 13
High-Definition Multimedia Interface (HDMI) 8, 13, 36, 37, 76
hue, adjusting 62

I

Info Banner 72
Infrared Receiver 12
interlaced 7, 63, 76

J

JUMP button 44, 52

L

label, channels 68
Language, setting 73

- M**
 MENU button 45, 52, 58, 61
 Menus
 Audio 61
 Channel 61
 Parent 61, 69
 Screen 61
 Setup 61, 72
 Video 61
 Mono, MTS setting 64
 Movie mode 62
 MTS 64
 MTS/SAP button 45
 MUTING button 44, 52
- N**
 Neutral, Color Temperature 62
 Noise Reduction 63
 Normal 53
- O**
 off, turning off the TV 12
 on, turning on the TV 12
- P**
 Parent Menu 61, 69
 parental control, described 8
 password, changing 69
 Pause button 44
 picture contrast, adjusting 62
 Picture in Picture. *See Twin View.*
 PICTURE MODE button 44
 Play button 44
 POWER button 12
 powering on/off, the TV 12
 presetting channels 67
 Pro (Video) mode 62
 problems, troubleshooting 77–80
 progressive 7, 63, 76
- R**
 ratings, setting 69–71
 ratings, viewing blocked programs 70, 71
 Record buttons 44
- remote control
 inserting batteries 43
 programming 46–47
 removing, Favorite Channels 58
 RESET button 45
 resetting, Audio options 65
 Rewind button 44
- S**
 S VIDEO jack, described 11, 13
 SAT/CABLE FUNCTION button 44
 SAT/CABLE POWER button 45
 satellite receiver, using with TV remote control 48
 Screen Menu 61
 Setup Menu 61, 72
 sharpness, adjusting 62
 Simulated, Effect 64
 sizing, picture in Twin View 57
 SLEEP button 45
 speakers
 turning on/off 65
 using external speakers 65
 specifications 81
 STAND BY indicator 12, 80
 Standard mode 62
 Steady Sound
 described 7
 setting 64
 Stereo, MTS setting 64
 Stop button 44
 surround sound 64
- T**
 Timer 73
 TIMER indicator 80
 TIMER LED 12
 timers, setting 73
 TO CONVERTER 13
 TOP MENU 44
 transport buttons 44
 treble, adjusting 64
 troubleshooting 77–80
- TruSurround 64
 TruSurround, Effect 64
 turning on/off the TV 12
 TV FUNCTION button 45, 52
 TV POWER button 45, 52
 TV/SAT button 45
 TV/VIDEO button 12, 45, 52
 Twin View
 button 44
 described 7
 using 55–57
- V**
 Variable audio setting 65
 VCR
 using with TV remote control 48
 with cable box, connecting 26
 with cable, connecting 24
 with satellite receiver, connecting 30
 Vertical Center, adjusting 66
 VHF/UHF jack, described 13
 VIDEO (L/R)/AUDIO jacks, described 13
 Video 2 access 11
 Video Menu 61
 Video modes, selecting 62
 Vivid mode 62
 VOL buttons 12, 44, 52
- W**
 Warm, Color Temperature 62
 Wide Mode 53, 66
 WIDE MODE button 44, 53
 Wide Zoom 53, 54
- Z**
 Zoom 53, 54
 zoom feature, with Twin View 57

Free Manuals Download Website

<http://myh66.com>

<http://usermanuals.us>

<http://www.somanuals.com>

<http://www.4manuals.cc>

<http://www.manual-lib.com>

<http://www.404manual.com>

<http://www.luxmanual.com>

<http://aubethermostatmanual.com>

Golf course search by state

<http://golfingnear.com>

Email search by domain

<http://emailbydomain.com>

Auto manuals search

<http://auto.somanuals.com>

TV manuals search

<http://tv.somanuals.com>