

Projection TV

Operating Instructions

KP-43HT20

KP-53HS20

KP-53HS30

KP-61HS20

KP-61HS30

Hi-Scan
1080i

DRC-MF
Digital Reality Creation

WARNING

To prevent fire or shock hazard, do not expose the projection TV to rain or moisture.

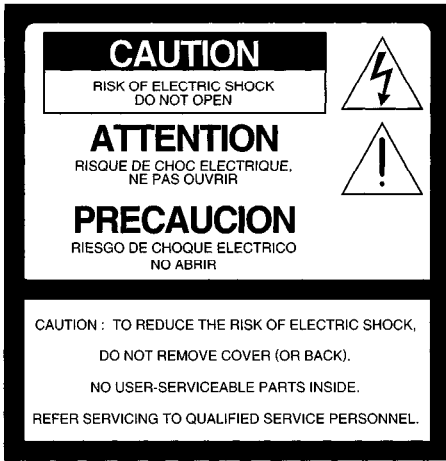

This symbol is intended to alert the user to the presence of uninsulated “dangerous voltage” within the product’s enclosure that may be of sufficient magnitude to constitute a risk of electric shock to persons.



This symbol is intended to alert the user to the presence of important operating and maintenance (servicing) instructions in the literature accompanying the appliance.

CAUTION

To prevent electric shock, do not use this polarized AC plug with an extension cord, receptacle or other outlet unless the blades can be fully inserted to prevent blade exposure.

CAUTION

When using TV games, computers, and similar products with your projection TV, or viewing a TV station whose logo always stays on the screen, keep the brightness and contrast functions at low settings. If a fixed (non-moving) pattern such as a station logo is left on the screen for long periods of time, especially at a high brightness or contrast setting, the image can be permanently imprinted onto the screen. These types of imprints are not covered by your warranty.

Note on Caption Vision

This television receiver provides display of television closed captioning in accordance with §15.119 of the FCC rules.

Note to CATV system installer

This reminder is provided to call the CATV system installer’s attention to Article 820-40 of the NEC that provides guidelines for proper grounding and, in particular, specifies that the cable ground shall be connected to the grounding system of the building, as close to the point of cable entry as practical.

Use of this television receiver for other than private viewing of programs broadcast on UHF, VHF, transmitted by cable companies or satellite for the use of the general public may require authorization from the broadcaster/cable company and/or program owner.

NOTIFICATION

This equipment has been tested and found to comply with the limits for a Class B digital device pursuant to Part 15 of the FCC Rules. These limits are designed to provide reasonable protection against harmful interference in a residential installation. This equipment generates, uses, and can radiate radio frequency energy and, if not installed and used in accordance with the instructions, may cause harmful interference with radio communications. However, there is no guarantee that interference will not occur in a particular installation. If this equipment does cause harmful interference to radio or television reception, which can be determined by turning the equipment off and on, the user is encouraged to try to correct the interference by one or more of the following measures:

- Reorient or relocate the receiving antennas.
- Increase the separation between the equipment and receiver.
- Connect the equipment into an outlet on a circuit different from that to which the receiver is connected.
- Consult the dealer or an experienced radio/TV technician for help.

You are cautioned that any changes or modifications not expressly approved in this manual could void your warranty and your authority to operate this equipment.

This document is for the remote control RM-Y908.
MODELS: KP-43HT20, KP-53HS20, KP-53HS30, KP-61HS20, KP-61HS30

Please keep this notice with the instruction manual.

Safety

- ❑ Operate the projection TV only on 120 V AC.
- ❑ The plug is designed, for safety purposes, to fit into the wall outlet only one way. If you are unable to insert the plug fully into the outlet, contact your dealer.
- ❑ If any liquid or solid object should fall inside the cabinet, unplug the projection TV immediately and have it checked by qualified service personnel before operating it further.
- ❑ If you will not be using the projection TV for several days, disconnect the power by pulling the plug itself. Never pull on the cord.

For details concerning safety precautions, see “Important Safeguards” on page 4.

Installing

- ❑ To prevent internal heat buildup, do not block the ventilation openings.
- ❑ Do not install the projection TV in a hot or humid place, or in a place subject to excessive dust or mechanical vibration.
- ❑ Avoid operating the projection TV at temperature below 5°C (41°F).
- ❑ If the projection TV is transported directly from a cold to a warm location, or if the room temperature changes suddenly, the picture may be blurred or show poor color. In this case, please wait a few hours to let the moisture evaporate before turning on the projection TV.
- ❑ To obtain the best picture, do not expose the screen to direct illumination or direct sunlight. It is recommended to use spot lighting directed down from the ceiling or to cover the windows that face the screen with opaque drapery. It is desirable to install the projection TV in a room where the floor and walls are not of a reflective material.



As an ENERGY STAR® Partner, Sony Corporation has determined that this product meets the ENERGY STAR® guidelines for energy efficiency.

ENERGY STAR® is a U.S. registered mark.

Note on convergence adjustment

Before you use your projection TV, make sure to adjust convergence. For details, see “Adjusting the Convergence Automatically – FLASH FOCUS™ –” on page 33.



TruSurround is a trademark of SRS Labs, Inc. SRS and the SRS symbol are registered trademarks of SRS Labs, Inc. in the United States and selected foreign countries. SRS and TruSurround are incorporated under license from SRS Labs, Inc. and is protected under United States Patent Nos. 4,748,669 and 4, 841, 572 with numerous additional issued and pending foreign patents. Purchase of this product does not convey the right to sell recordings made with the TruSurround technology.

BBE and BBE Symbol are trademarks of BBE Sound, Inc. and are licensed by BBE Sound, Inc. under U.S. Patent No. 4,638,258 and 4,482,866.

ATTENTION

Pour prévenir les chocs électriques, ne pas utiliser cette fiche polarisée avec un prolongateur, une prise de courant ou une autre sortie de courant, sauf si les lames peuvent être insérées à fond sans en laisser aucune partie à découvert.

Owner's Record

The model and serial numbers are located at the rear of the projection TV, below the Sony logo, on the sticker, and also on the TV box (white label). Record these numbers in the spaces provided below. Refer to them whenever you call upon your Sony dealer regarding this product.

Model No. _____

Serial No. _____

Important Safeguards

For your protection, please read these instructions completely, and keep this manual for future reference.

Carefully observe and comply with all warnings, cautions and instructions placed on the set or described in the operating instructions or service manual.

WARNING

To guard against injury, the following basic safety precautions should be observed in the installation, use and servicing of the set.

Use

Power Sources

This set should be operated only from the type of power source indicated on the type of power source indicated on the serial/model plate. If you are not sure of the type of electrical power supplied to your home, consult your dealer or local power company. For those sets designed to operate from battery power, refer to the operating instructions.



Grounding or Polarization

This set is equipped with a polarized AC power cord plug (a plug having one blade wider than the other), or with a three-wire grounding type plug (a plug having a third pin for grounding). Follow the instructions below:

For the set with a polarized AC power cord plug

This plug will fit into the power outlet only one way. This is a safety feature. If you are unable to insert the plug fully into the outlet, try reversing the plug. If the plug still fails to fit, contact your electrician to have a suitable outlet installed. Do not defeat the safety purpose of the polarized plug by forcing it in.



Alternate Warning for the set with a three-wire grounding type AC plug

This plug will only fit into a grounding-type power outlet. This is a safety feature. If you are unable to insert the plug into the outlet, contact your electrician to have a suitable outlet installed. Do not defeat the safety purpose of the grounding plug.

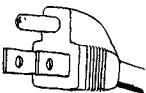

Overloading

Do not overload wall outlets, extension cords or convenience receptacles beyond their capacity, since this can result in fire or electric shock.

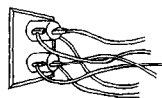

Always turn the set off when it is not being used. When the set is left unattended and unused for long periods of time, unplug it from the wall outlet as a precaution against the possibility of an internal malfunction that could create a fire hazard.



If a snapping or popping sound from a TV set is continuous or frequent while the TV is operating, unplug the TV and consult your dealer or service technician. It is normal for some TV sets to make occasional snapping or popping sounds, particularly when being turned on or off.

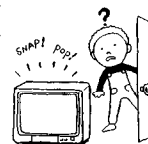

Object and Liquid Entry

Never push objects of any kind into the set through the cabinet slots as they may touch dangerous voltage points or short out parts that could result in a fire or electric shock. Never spill liquid of any kind on the set.

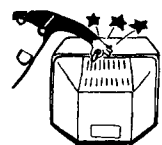

Attachments

Do not use attachments not recommended by the manufacturer, as they may cause hazards.

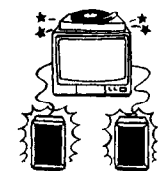

Cleaning

Clean the cabinet of the projection TV with a dry soft cloth. To remove dust from the screen, wipe it gently with a soft cloth. Stubborn stains may be removed with a cloth slightly dampened with solution of mild soap and warm water. Never use strong solvents such as thinner or benzine for cleaning.



If the picture becomes dark after using the projection TV for a long period of time, it may be necessary to clean the inside of the projection TV. Consult qualified service personnel.

Installation

Water and Moisture

Do not use power-line operated sets near water — for example, near a bathtub, washbowl, kitchen sink, or laundry tub, in a wet basement, or near a swimming pool, etc.

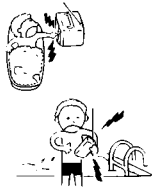

Accessories

Do not place the set on an unstable cart, stand, table or shelf. The set may fall, causing serious injury to a child or an adult and serious damage to the set. Use only a cart or stand recommended by the manufacturer for the specific model of projection TV. An appliance and cart combination should be moved with care. Quick stops, excessive force, and uneven surfaces may cause the appliance and cart combination to overturn.



Ventilation

The slots and openings in the cabinet and in the back or bottom are provided for necessary ventilation. To ensure reliable operation of the set, and to protect it from overheating, these slots and openings must never be blocked or covered.

- Never cover the slots and openings with a cloth or other materials.
- Never block the slots and openings by placing the set on a bed, sofa, rug or other similar surface.
- Never place the set in a confined space, such as a bookcase or built-in cabinet, unless proper ventilation is provided.
- Do not place the set near or over a radiator or heat register, or where it is exposed to direct sunlight.

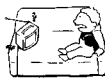

Power-Cord Protection

Do not allow anything to rest on or roll over the power cord, and do not place the set where the power cord is subject to wear or abuse.



Antennas

Outdoor Antenna Grounding

If an outdoor antenna is installed, follow the precautions below. An outdoor antenna system should not be located in the vicinity of overhead power lines or other electric light or power circuits, or where it can come in contact with such power lines or circuits.

WHEN INSTALLING AN OUTDOOR ANTENNA SYSTEM, EXTREME CARE SHOULD BE TAKEN TO KEEP FROM CONTACTING SUCH POWER LINES OR CIRCUITS AS CONTACT WITH THEM IS ALMOST INVARIABLY FATAL.

Be sure the antenna system is grounded so as to provide some protection against voltage surges and built-up static charges.

Section 810 of the National Electrical Code (NEC) in USA and Section 54 of the Canadian Electrical Code in Canada provides information with respect to proper grounding of the mast and supporting structure, grounding of the lead-in wire to an antenna discharge unit, size of grounding conductors, location of antenna discharge unit, connection to grounding electrodes, and requirements for the grounding electrode.

Antenna Grounding According to the NEC

Refer to section 54-300 of Canadian Electrical Code for Antenna Grounding.

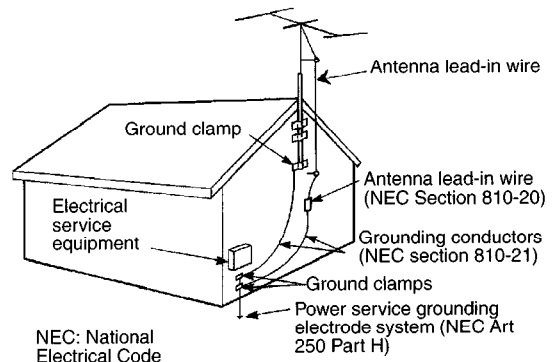

Lightning

For added protection for this television receiver during a lightning storm, or when it is left unattended and unused for long periods of time, unplug it from the wall outlet and disconnect the antenna. This will prevent damage to the receiver due to lightning and power-line surges.

Service

Damage Requiring Service

Unplug the set from the wall outlet and refer servicing to qualified service personnel under the following conditions:

- When the power cord or plug is damaged or frayed.
- If liquid has been spilled into the set.
- If the set has been exposed to rain or water.
- If the set has been subject to excessive shock by being dropped, or the cabinet has been damaged.
- If the set does not operate normally when following the operating instructions. Adjust only those controls that are specified in the operating instructions. Improper adjustment of other controls may result in damage and will often require extensive work by a qualified technician to restore the set to normal operation.
- When the set exhibits a distinct change in performance, it indicates a need for service.

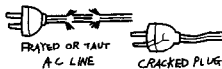

Safety Check

Upon completion of any service or repairs to the set, ask the service technician to perform routine safety checks (as specified by the manufacturer) to determine that the set is in safe operating condition, and to so certify. When the set reaches the end of its useful life, improper disposal could result in a picture tube implosion. Ask a qualified service technician to dispose of the set.



For Safety

Be careful when moving the projection TV

When you place the projection TV in position, be careful not to drop it on your foot or fingers.

Watch your footing while installing the projection TV.

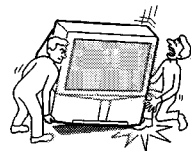

Carry the projection TV in the specified manner

If you carry the projection TV in a manner other than the specified manner and without the specified number of persons, it may drop and a serious injury may be caused. Be sure to follow the instructions mentioned below.

- Carry the projection TV with the specified number of persons. (see page 10)
- Do not carry the projection TV holding the speaker grill.
- Hold the projection TV tightly when carrying it.

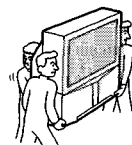

Servicing

Do not attempt to service the set yourself since opening the cabinet may expose you to dangerous voltage or other hazards. Refer all servicing to qualified service personnel.



Replacement Parts

When replacement parts are required, be sure the service technician certifies in writing that he has used replacement parts specified by the manufacturer that have the same characteristics as the original parts.

Unauthorized substitutions may result in fire, electric shock or other hazards.

Contents

Important Safeguards	4
----------------------------	---

Introducing the Sony Projection TV

Presenting the Sony Projection TV	8
Using this manual	9

Installing and Connecting the Projection TV

Contents	10
Inserting Batteries into the Remote Control	10
Carrying Your Projection TV	10
Installing the Projection TV	11
Connector Types	12
Projection TV Controls and Connectors	13
Basic Connections (Connecting Cable TV or Antenna).....	16
Connecting a VCR and Cable	19
Connecting a VCR and Cable Box	20
Connecting Two VCRs for Tape Editing	22
Connecting a Satellite Receiver	23
Connecting a Satellite Receiver with a VCR.....	24
Connecting an Audio Receiver	25
Connecting a DVD Player with Component Video Connectors	26
Connecting a DVD Player with A/V Connectors	27
Connecting a Digital TV Receiver.....	28
Connecting a Camcorder	29
Connecting an AV Receiver	30
Using the CONTROL S Feature.....	31
Setting Up the Projection TV Automatically.....	32
Adjusting the Convergence Automatically – FLASH FOCUS™ –	33

Using the Features

Using the Remote Control	34
Watching the TV	37
Watching the Digital TV	39
Using Favorite Channels.....	40
Using Twin View™	41
Using the Freeze Function	44
Using Channel Index	45

Using the Menus

Overview.....	47
Using the Video Menu.....	48
Using the Audio Menu.....	50
Using the Channel Menu	52
Using the Parent Menu	54
Using the Timer Menu.....	62
Using the Setup Menu	63

Other Information

Programming the Remote Control.....	65
Operating Other Components with Your Projection TV Remote Control.....	68
Troubleshooting.....	70
Specifications.....	73

Introducing the Sony Projection TV

Presenting the Sony Projection TV

Thank you for purchasing the Sony Projection TV.

This manual is for models KP-43HT20, KP-53HS20, KP-53HS30, KP-61HS20 and KP-61HS30.

Model KP-53HS30 is used for illustration purposes.

Features

Some of the features that you will enjoy with your new projection TV include:

- ❑ **Hi Scan 1080™**: Enables you to receive the 1080i, 720p, 480p and 480i digital TV formats. By using the VIDEO 5/6 IN jacks, you can connect a DTV (digital television) receiver to view DTV programs.
- ❑ **DRC™ Multi-Function**: Unlike conventional line doublers, the DRC feature doubles vertical and horizontal lines, resulting in four times the density for quality sources such as DVD, Satellite and Digital camcorder.
- ❑ **CineMotion™**: Using the 2-3 Pull-Down technology, the CineMotion feature allows you to obtain a smooth picture movement when playing back movies or other video sources on film.
- ❑ **Twin View™**: Using Multi-Image Driver (MID-X), Twin View allows you to watch two programs side by side with the ability to zoom in on one picture and listen to the program in the selected window. You can watch pictures from two different sources (1080i, 720p, 480p or 480i) simultaneously.
- ❑ **16:9 Enhancement**: Vertical Compression technology that maximizes picture resolution on “anamorphic” or “enhanced for wide screen” sources, including selected DVDs.
- ❑ **Steady Sound™**: Equalizes volume levels so there is consistent output between programs and commercials.
- ❑ **Parental Control**: V-Chip technology allows parents to block unsuitable programming for younger viewers.
- ❑ **Component Video Inputs**: Offers the best video quality for DVD (480p, 480i) and Digital Set-top box (1080i, 720p, 480p, 480i) connections.
- ❑ **S-VIDEO Inputs**: Provides a high-quality image for connected equipment.

- ❑ **Favorite Channel Preview:** Preview up to eight favorite channels without leaving the current channel.
- ❑ **Channel Index:** Allows you to view and choose from twelve programs.
- ❑ **Flash Focus™:** Allows you to adjust convergence automatically.

Using this manual

We recommend that you carefully review the contents of the following three sections in the order shown to ensure that you fully understand the operation of your new projection TV.

1 Installing and Connecting the Projection TV

This section guides you through your initial setup. It shows you how to install your projection TV, to connect your new components and to connect the antenna and cable.

2 Using the Features

This section shows you how to begin using your new projection TV. It also shows you how to use your remote control functions.

3 Using the menus

This section teaches you how to access on-screen menus and adjust your projection TV settings.

Instructions in this manual are written for the remote control. Similar controls are also found on the projection TV console.

Installing and Connecting the Projection TV

Contents

The box contains your new projection TV, a remote control and two AA batteries. No peripheral cables are included. If you intend to add additional equipment to your projection TV, please check the hookup instructions for your desired setup before you begin. You may need to purchase cables and/or splitters to complete the hookup properly.

Inserting Batteries into the Remote Control

Insert two size AA (R6) batteries (supplied) by matching the + and - on the batteries to the diagram inside the battery compartment.

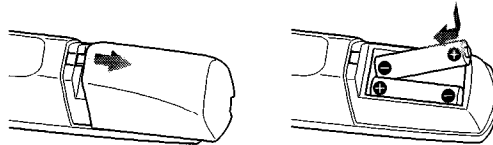

- ✓ Remove the batteries to avoid damage from possible battery leakage whenever you anticipate that the remote control will not be used for an extended period.
- ✓ Handle the remote control with care. Avoid dropping it, getting it wet, or placing it in direct sunlight, near a heater, or where the humidity is high.
- ✓ Your remote control can be programmed to operate most video equipment. (See "Programming the Remote Control" on page 65.)

Carrying Your Projection TV

Carrying the projection TV requires three or more people.

The projection TV has been equipped with casters for easy movement on a hard surface. (for KP-53HS20, KP-53HS30, KP-61HS20 and KP-61HS30 only)

Please move your projection TV using the casters.

Installing the Projection TV

Recommended viewing area (Horizontal)

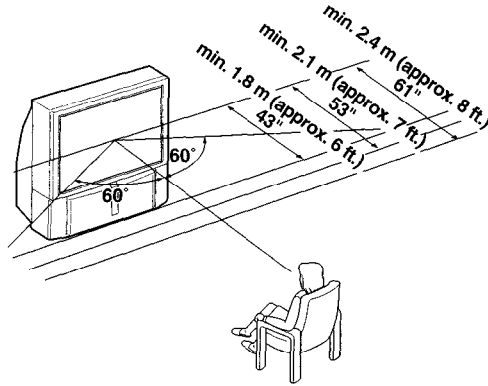

Recommended viewing area (Vertical)

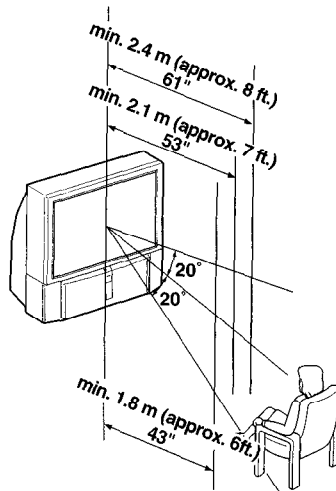

Connector Types

You may find it necessary to use some of the following connector types during set up.

Coaxial cable

Standard TV cable and antenna cable

Plug Type



Screw-on Type



S Video cable

High quality video cable for enhanced picture quality



Audio/Video cable



Video - Yellow

Audio (Left) - White

Audio (Right) - Red

Some DVD Players are equipped with the following three video connectors:

Y - Green

P_B (C_B, C_b or B-Y) - Blue

P_R (C_R, C_r or R-Y) - Red

CONTROL S cable

CONTROL S connections are exclusive to Sony products and allow greater control of all Sony equipment.



Projection TV Controls and Connectors

Front Panel Menu Controls

The front panel menu controls allow access to the on-screen menus without the use of a remote control. Pressing MENU brings up the on-screen menus. The arrow buttons move the on-screen cursor in the menus and the Select button (+) selects the menu item.

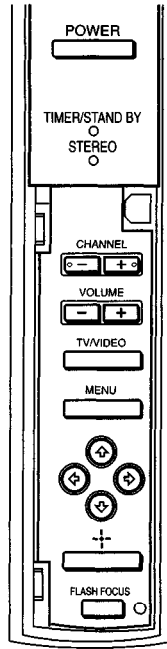

Projection TV Rear and Front/Side Panel Connectors

Rear of projection TV

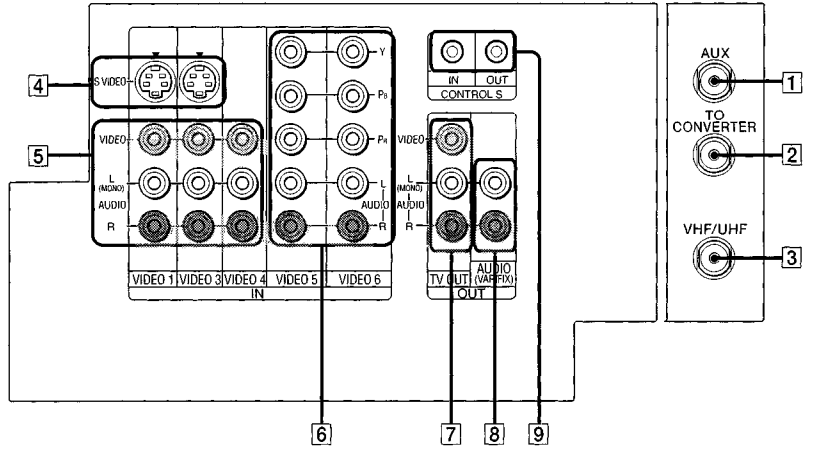

Front or side of projection TV

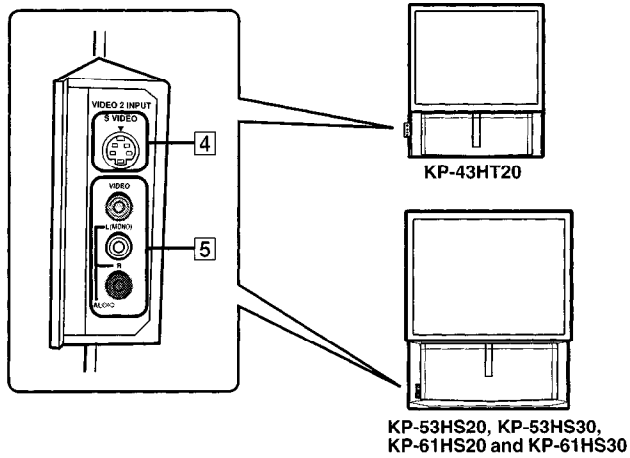

Connection	Description
1 AUX	Allows you to view local and cable channels if your cable provider does not feature local channels. You can switch between local and cable channels easily by pressing ANT on the remote control. Devices connected to the AUX input cannot be viewed in Twin View.
2 TO CONVERTER	This is a VHF/UHF OUT jack that lets you set up your projection TV to switch between scrambled channels (through a cable box) and normal cable channels (CATV). Use this jack instead of a splitter to get better picture quality when switching between scrambled and unscrambled cable channels.
3 VHF/UHF	Connects to your VHF/UHF antenna or cable.
4 S VIDEO (Rear and front/ side)	Connects to the S VIDEO OUT jack of your VCR or other S VIDEO-equipped video component. Provides better picture quality than the VHF/UHF jacks or the Video IN jack.
5 VIDEO (L/R)/AUDIO (Rear and front/ side)	Connects to the audio and video OUT jacks on your VCR or other video component. A fourth video input (VIDEO 2) is located on the side panel (for KP-43HT20) or the front panel (for KP-53HS20, KP-53HS30, KP-61HS20 and KP-61HS30) of the projection TV.
6 Y/PB/PR (L/R)/AUDIO	Connects to your DVD player's or Digital Set-top box's component video (Y, PB, PR) and audio (L/R) jacks.
7 TV OUT	Connects to an AV receiver for greater control of all audio and video equipment (see page 30). For detailed information about connection, refer to the operating manual supplied with the AV receiver.
8 AUDIO OUT (VAR/FIX) L (MONO)/R	Connects to the left and right audio inputs of your audio or video component.
9 CONTROL S IN/OUT	To control other Sony equipment with the projection TV's remote control, connect the CONTROL S IN jack of the equipment to the CONTROL S OUT jack on the projection TV with the CONTROL S cable. To control the projection TV with a remote control for another Sony product, connect the CONTROL S OUT jack of the equipment to the CONTROL S IN jack on the projection TV with the CONTROL S cable.

Basic Connections (Connecting Cable TV or Antenna)

Connecting Directly to Cable or an Antenna

The connection you choose depends on the cable found in your home. Newer homes are equipped with standard coaxial cable (see **A**); older homes probably have 300-ohm twin lead cable (see **B**); other homes may contain both (see **C**).

A VHF Only or VHF/UHF or Cable

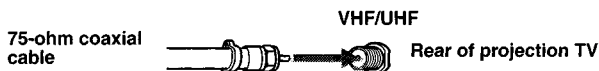

B VHF Only or UHF Only or VHF/UHF

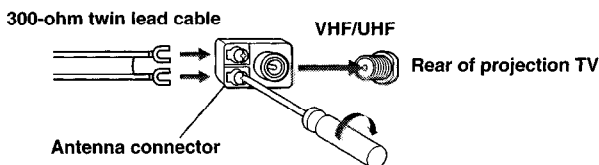

C VHF and UHF

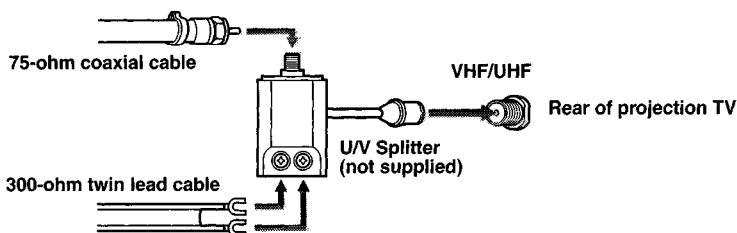

Cable and Antenna

If your cable provider does not feature local channels, you may find this set up convenient.

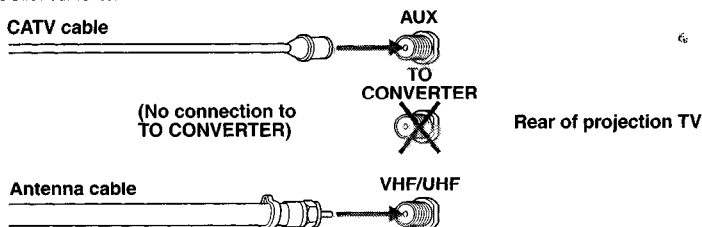

Select CABLE or antenna (ANT) mode by pressing ANT on the remote control.

To receive channels with an antenna, you need to turn your Cable to OFF (see page 52) and perform the Auto Program function (see page 53).

Cable Box Connections

Cable Box and Cable

This is the preferred basic cable TV hookup to use if:

- ❑ Your cable TV company scrambles some channels, but not all of them (pay channels vs. regular cable channels) and you need to use a cable box, and
- ❑ You want to enjoy the Twin View feature.

With this setup you can:

- ❑ Use the projection TV remote control to change channels using your cable box when the signal is scrambled.
- ❑ Use the projection TV remote control to change channels using your projection TV when the signal is not scrambled. (Your projection TV's tuner provides a better signal than the cable box.)
- ❑ Use the Twin View feature. (When all channels are routed through your cable box, only one channel is sent to the projection TV, so you can not use the Twin View or Channel Index features for your cable box.)

- 1** Connect the Cable TV cable to the projection TV's VHF/UHF jack.
- 2** Using a coaxial cable, connect the projection TV's TO CONVERTER jack to the cable box's IN jack. The projection TV's internal converter allows you to switch between unscrambled signals coming straight into the projection TV and scrambled signals coming in through the cable box, eliminating the need for an external splitter.
- 3** Using a coaxial cable, connect the cable box's OUT jack to the projection TV's AUX jack.

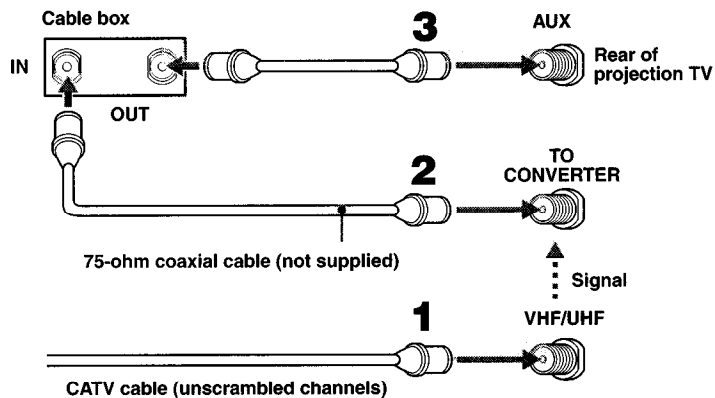

Pressing ANT on the remote control switches between the channels coming in through the cable box (scrambled) and those coming directly to the TV (unscrambled).

(Continued)

Cable Box Only

Use this hookup if:

- You subscribe to a cable TV system that uses scrambled or encoded signals requiring a cable box to view all channels, and
- You do not intend to hook up any other audio or video equipment to your projection TV.

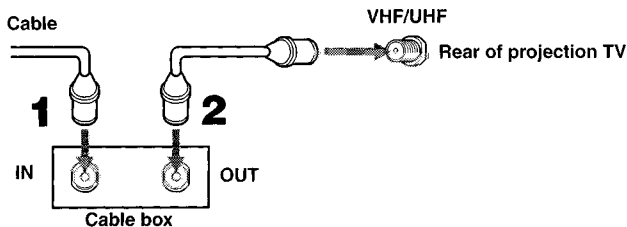

When all channels are routed through your cable box, only one unscrambled channel is sent to the projection TV, so you cannot use the Twin View feature. If some channels are scrambled, but others are not, consider using the hookup on page 17 instead.

- 1** Connect the coaxial connector from your cable service to the cable box's IN jack.
- 2** Using a coaxial cable, connect the cable box's OUT jack to the TV's VHF/UHF jack.



Also, set Cable to ON in the Channel menu. (see page 52)

 Setting the Channel Fix feature in the Channel menu (see "Using the Channel Menu" on page 52) ensures that you do not accidentally switch the channels using your projection TV.

-  If you will be controlling all channel selection through your cable box, consider using the Channel Fix feature to set your projection TV to channel 3 or 4 (see page 53).
-  Your Sony remote control can be programmed to operate your cable box (see "Programming the Remote Control" on page 65).
-  To change channels using the cable box, set your projection TV to channel 3 or 4 depending on the cable box channel output.

Connecting a VCR and Cable

Use this hookup if:

- You have cable TV that does not require a cable box.

Disconnect all power sources before making any connections.

- 1** Connect the cable TV cable to the VCR's IN jack.
- 2** Using a coaxial cable, connect the VCR's OUT jack to the projection TV's VHF/UHF jack.
- 3** Using AUDIO and S VIDEO cables, connect the VCR's Audio and S VIDEO OUT jacks to the projection TV's AUDIO and S VIDEO IN jacks.

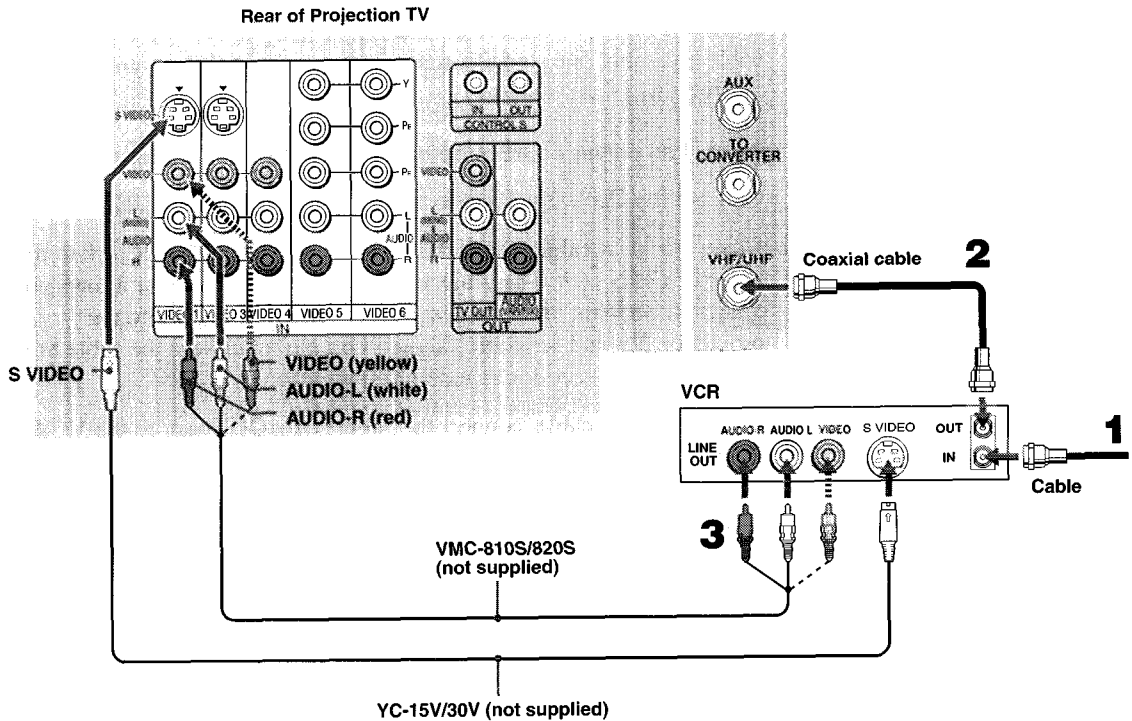

⚠ If your VCR is not equipped with S VIDEO, use a VIDEO cable (yellow) instead of the S VIDEO cable.

Connecting a VCR and Cable Box

Use this hookup if:

- Your cable TV company scrambles some channels, but not all of them (pay channels vs. regular cable channels) and you need to use a cable box, and
- You want to enjoy the Twin View feature.

With this setup you can:

- Use the projection TV remote control to change channels using your cable box when the signal is scrambled.
- Use the projection TV remote control to change channels using your projection TV when the signal is not scrambled. Your projection TV's tuner provides a better signal than the cable box.
- Use the Twin View feature. (When all channels are routed through your cable box, only one signal is sent to the projection TV, so you cannot use the Twin View feature.)

Disconnect all power sources before making any connections.

- 1** Connect the Cable TV cable to the projection TV's VHF/UHF jack.
- 2** Using a coaxial cable, connect the TV's TO CONVERTER jack to the cable box's IN jack. The projection TV's internal converter allows you to switch between unscrambled signals coming straight into the projection TV and scrambled signals coming in through the cable box, eliminating the need for an external splitter.
- 3** Using a coaxial cable, connect the cable box's OUT jack to the VCR's IN jack.
- 4** Using AUDIO and S VIDEO cables, connect the VCR's AUDIO and S VIDEO OUT jacks to the projection TV's AUDIO and S VIDEO IN jacks.
- 5** Using a coaxial cable, connect the VCR's OUT jack to the projection TV's AUX jack.

 To view scrambled channels, set your projection TV to AUX 3 or 4 (depending on your cable box output). Change channels using your cable box.

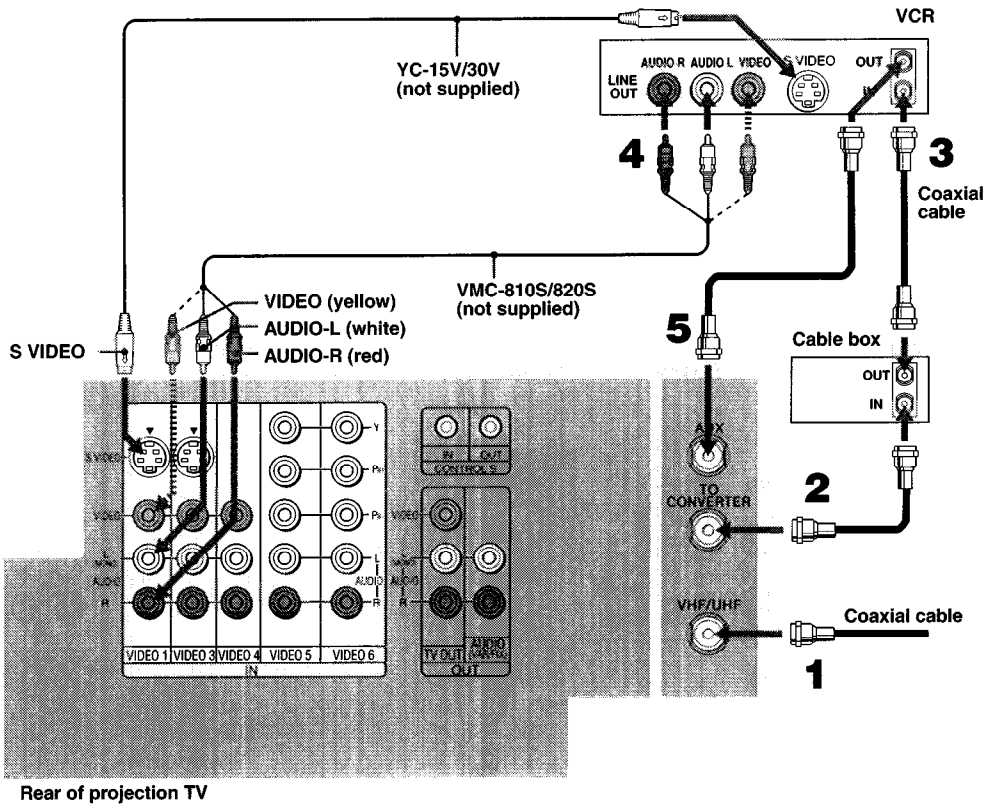

- ⚠ If your VCR is not equipped with S VIDEO, use a VIDEO cable (yellow) instead of the S VIDEO cable.
- ⚠ You will not be able to change channels on the VCR. Set your projection TV and VCR to channel 3 or 4, depending on your cable box channel output.
- ⚠ Pressing ANT on the remote control switches between the channels coming in through the cable box (scrambled) and those coming directly to the projection TV (unscrambled).

Connecting Two VCRs for Tape Editing

If you connect two VCRs, you can record from one VCR to the other while using your TV to monitor what is being recorded.

Disconnect all power sources before making any connections.

- 1** Using AUDIO and VIDEO cables, connect the playback VCR's Audio and Video OUT jacks to the recording VCR's Audio and Video IN jacks.
- 2** Using AUDIO and VIDEO cables, connect the recording VCR's AUDIO and Video OUT jacks to the projection TV's AUDIO and VIDEO IN jacks.

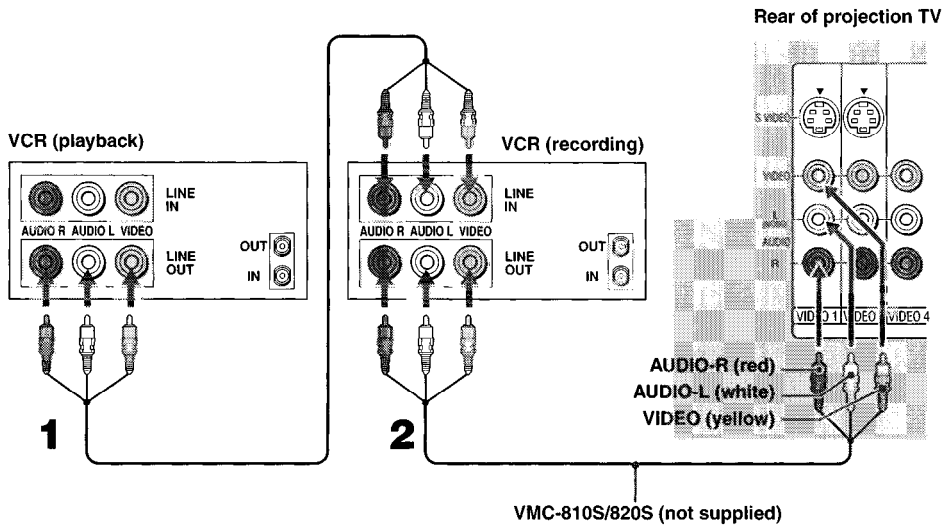

- To perform tape editing, set the projection TV to the video input intended for playback by pressing TV/VIDEO on the remote control.
- You may need to change the video input on your VCR. Consult your VCR's operating manual for instructions.
- If your VCRs have an S VIDEO jack. For best picture quality, use an S VIDEO connection instead of the yellow video cable on your combined A/V cable.
Using an S VIDEO cable, connect the playback VCR's S VIDEO OUT jack to the recording VCR's S VIDEO IN jack. S VIDEO does not provide audio, so audio cables must still be connected to provide sound.
- You cannot record signals from equipment connected to the Y, Pb, Pr input.

Connecting a Satellite Receiver

Disconnect all power sources before making any connections.

- 1** Connect the satellite antenna cable to the satellite receiver's SATELLITE IN jack.
- 2** Using AUDIO and S VIDEO cables, connect the satellite receiver's AUDIO and S VIDEO OUT jacks to the projection TV's AUDIO and S VIDEO IN jacks.
- 3** Connect a coaxial cable from your cable or antenna to the projection TV's VHF/UHF jack.

⚠ If your satellite receiver is not equipped with S VIDEO, use a VIDEO cable (yellow) instead of the S VIDEO cable.

Rear of projection TV

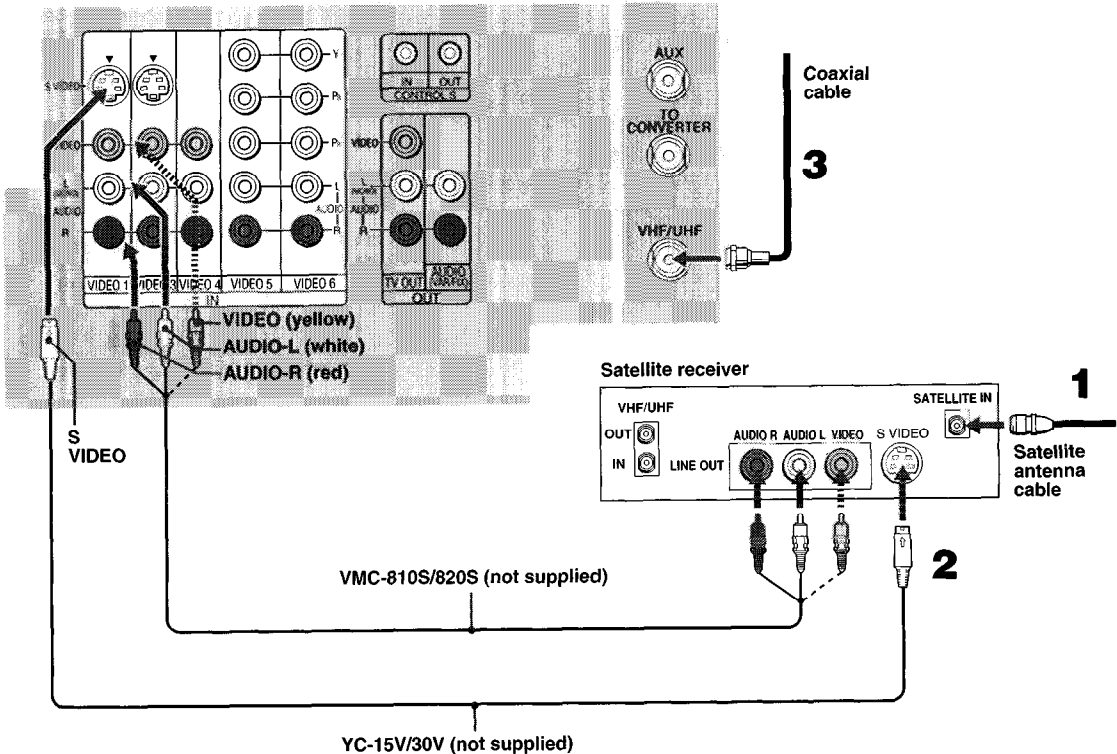

Connecting a Satellite Receiver with a VCR

Disconnect all power sources before making any connections.

- 1** Connect the satellite antenna cable to the satellite receiver's SATELLITE IN jack.
- 2** Connect the CATV cable to the VCR's VHF/UHF IN jack.
- 3** Using a coaxial cable, connect the VCR's OUT jack to the projection TV's VHF/UHF jack.
- 4** Using AUDIO and S VIDEO cables, connect the satellite receiver's AUDIO and S VIDEO OUT jacks to the VCR's AUDIO and S VIDEO IN jacks.
- 5** Using AUDIO and S VIDEO cables, connect the VCR's AUDIO and S VIDEO OUT jacks to the TV's AUDIO and S VIDEO IN jacks.

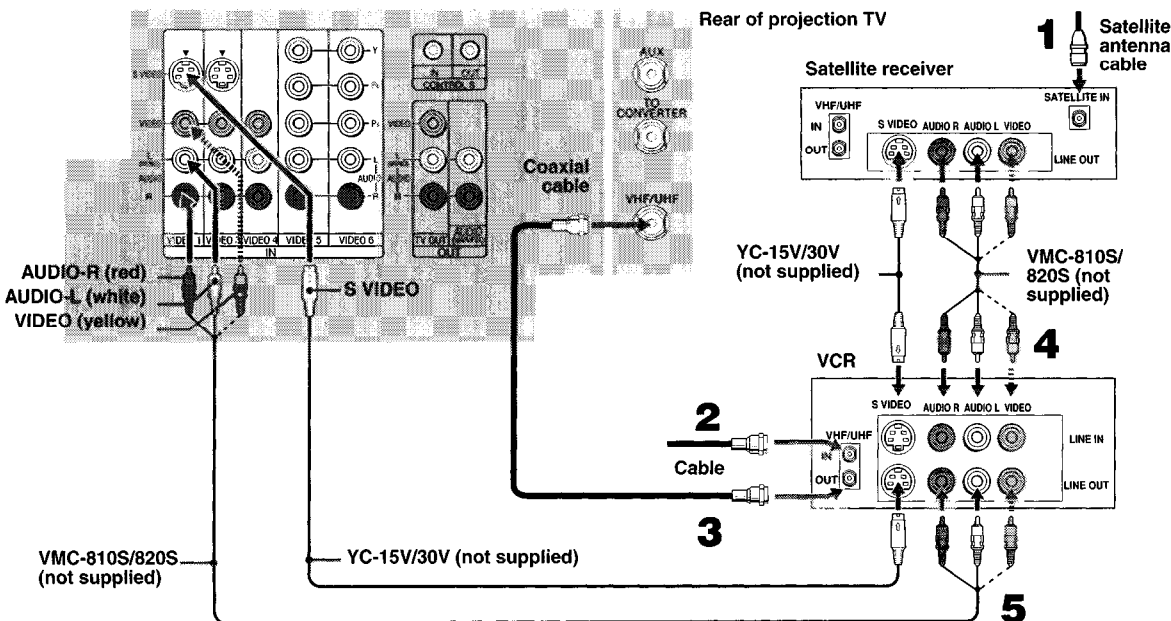

- ✔ Be sure your VCR's video input is set correctly. Consult your VCR's operating manual for instructions.
- ✔ Use TV/VIDEO to select:
 - VIDEO 1 to watch satellite TV or the VCR (Your VCR must be turned on).
 - VHF/UHF to watch cable TV.
- ✔ If your VCR or satellite receiver is not equipped with S VIDEO, use a VIDEO cable (yellow) instead of the S VIDEO cable.

Connecting an Audio Receiver

Disconnect all power sources before making any connections.

Using audio cables, connect the projection TV's AUDIO OUT (VAR/FIX) jacks to the audio receiver's audio LINE IN jacks.

Rear of projection TV

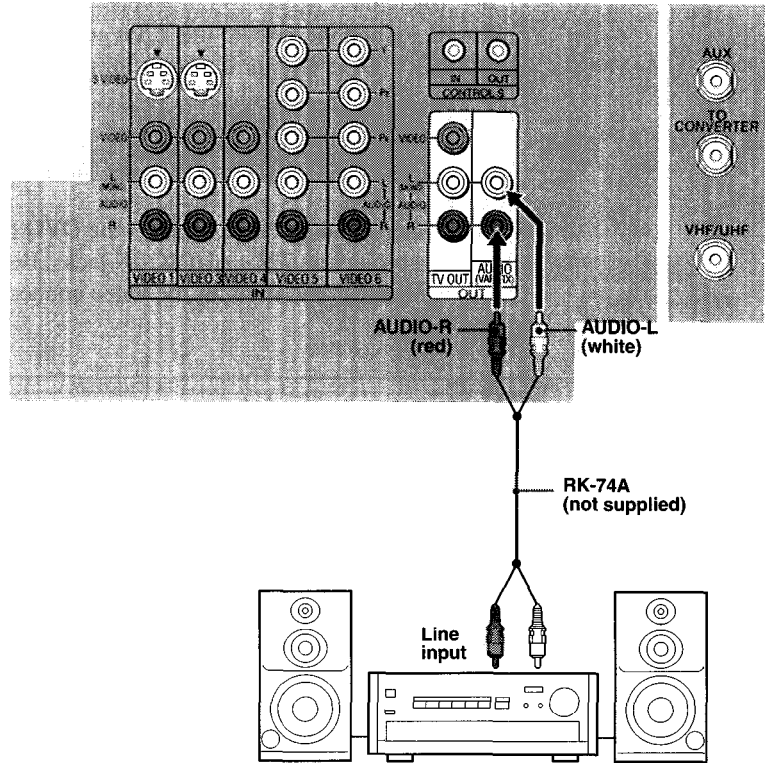

Connecting a DVD Player with Component Video Connectors

This is the preferred hookup to use if:

- Your DVD player has component (Y, PB, PR) jacks.

Disconnect all power sources before making any connections.

- 1** Using three separate component video cables, connect the DVD player's Y, PB and PR jacks to the Y, PB and PR jacks on the projection TV. Use the VIDEO IN 5 or 6 connections.

⚠ The Y, PB and PR jacks on your DVD player are sometimes labeled Y, Gb and Cr, or Y, B-Y and R-Y. If so, connect the cables to like colors.

- 2** Using an audio cable, connect the DVD player's Audio OUT jacks to the projection TV's AUDIO IN jacks. Be sure to use the same row of inputs that you used for the video connection (VIDEO IN 5 or 6).

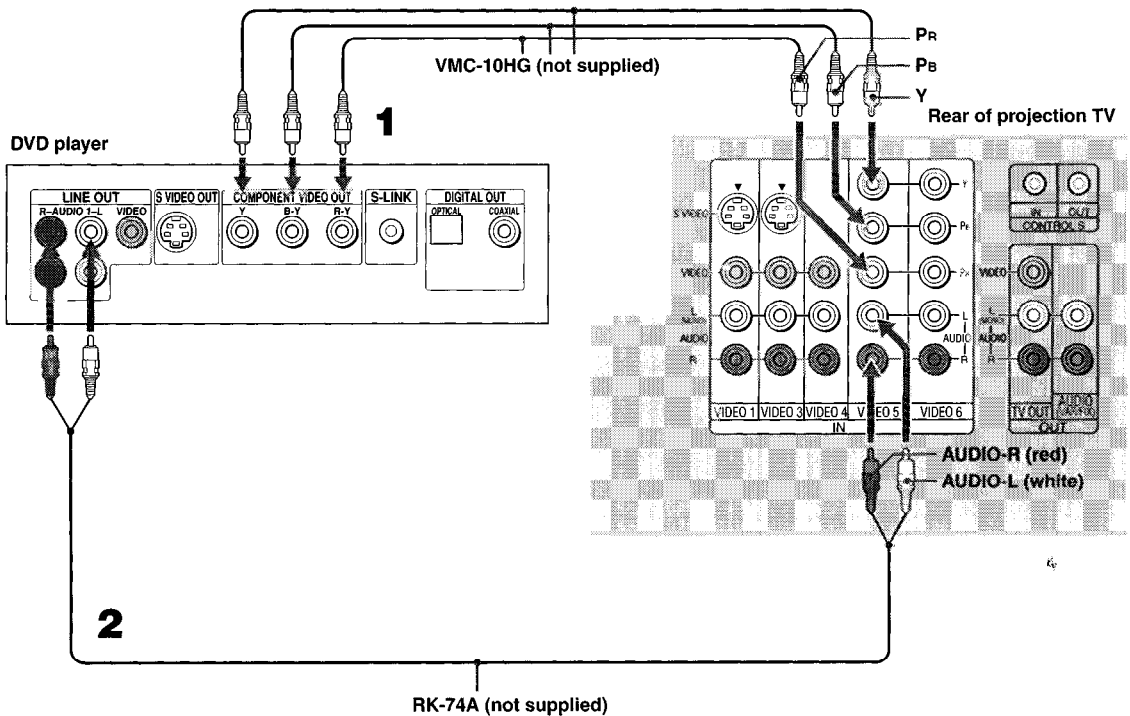

Connecting a DVD Player with A/V Connectors

Use this hookup if:

- Your DVD player does not have component (Y, PB, PR) jacks.

⚠ If your DVD player has video component output connectors: for best picture quality use the connection described on page 26.

Disconnect all power sources before making any connections.

- 1** Using audio cables, connect the DVD player's Audio OUT jacks to the projection TV's AUDIO IN jacks.
- 2** Using an S VIDEO cable, connect the DVD player's S VIDEO jack to the projection TV's S VIDEO jack.

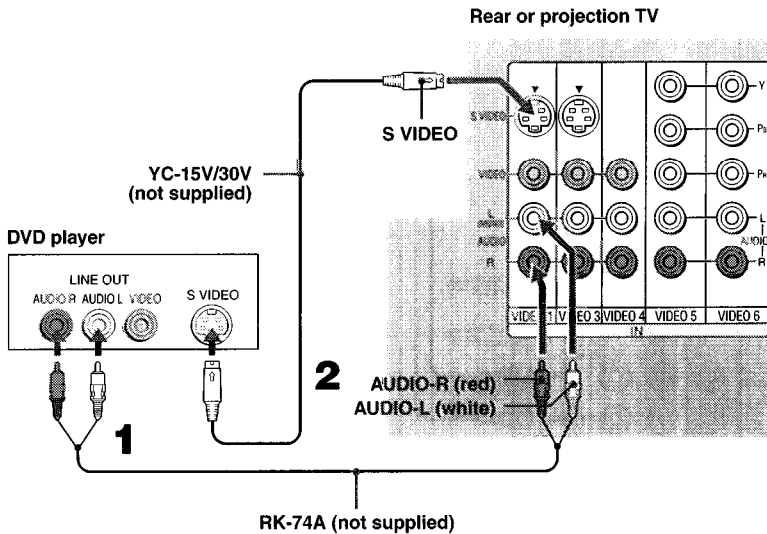

⚠ Use TV/VIDEO on the remote control to switch between the VCR, DVD player and cable TV inputs.

Connecting a Digital TV Receiver

 Be sure to read the Set-top box manual.

Disconnect all power sources before making any connections.

- Using three separate component video cables, connect the Digital TV Set-top box's Y, P_B and P_R jacks to the projection TV.

 The Y, P_B and P_R jacks do not provide audio, so audio cables must be connected to provide sound.

Component video connection is necessary to view 480p, 720p and 1080i formats. You may also use the S VIDEO or Composite Video connections, however component video (Y, P_B, P_R) will provide the best picture quality for all format types.

- Using an audio cable, connect the Digital TV Set-top box's Audio OUT jacks to the projection TV's AUDIO IN jacks.

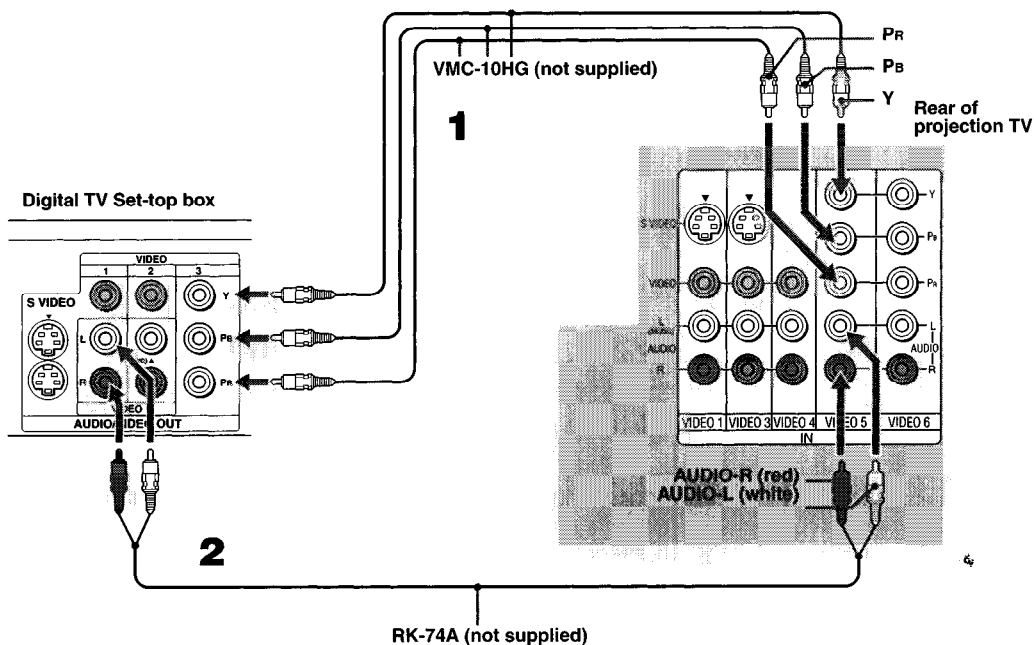

 You cannot record the signal from any equipment connected into the Y, P_B and P_R connectors.

 This projection TV is not compatible with digital TV receivers configured with RGB or VGA output connectors.

Connecting a Camcorder

For easy connection of the camcorder, the projection TV has front Audio and Video inputs (shown below). However, if you prefer, you can also connect the camcorder to the projection TV's rear Audio and Video IN jacks.

Using AUDIO and S VIDEO cables, connect the camcorder's Audio and S VIDEO OUT jacks to the projection TV's AUDIO and S VIDEO IN jacks.

⚠ If you have a mono camcorder, connect its left audio output to the projection TV's AUDIO L jack.

⚠ If your camcorder is not equipped with S VIDEO, use a VIDEO cable (yellow) instead of the S VIDEO cable.

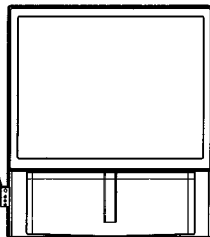
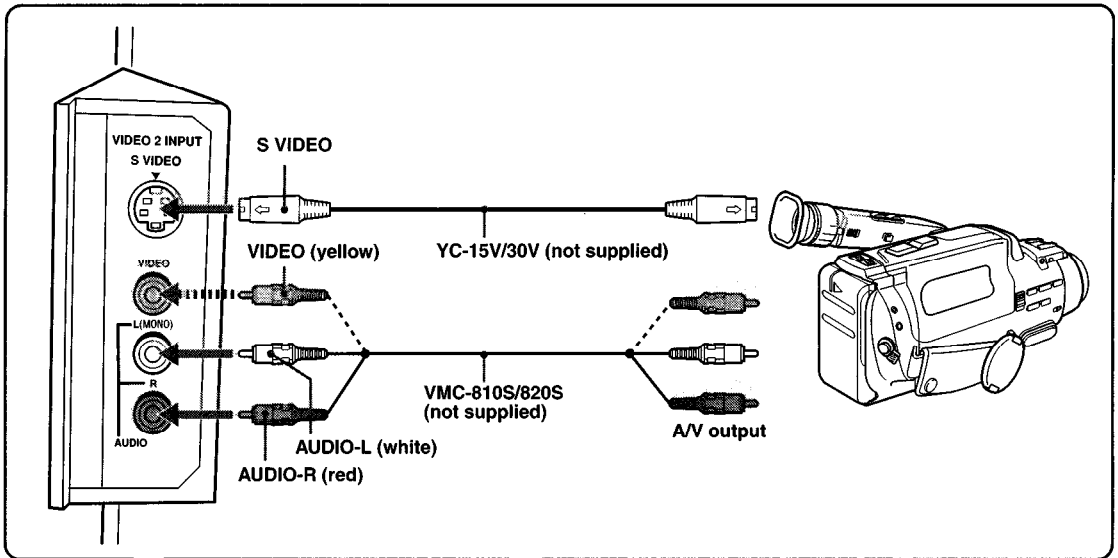

KP-43HT20

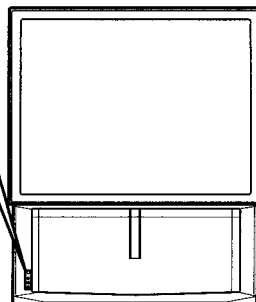

KP-53HS20, KP-53HS30,
KP-61HS20, and KP-61HS30

Connecting an AV Receiver

For greater control of all audio and video equipment, connect an AV receiver.

Change "Video Label" for the VIDEO 1 input to "Receiver" (see page 64).

Disconnect all power sources before making any connections.

- 1** Connect the coaxial cable from the incoming cable connection or antenna to IN on the VCR.
- 2** Using a coaxial cable, connect OUT on the VCR to VHF/UHF on the projection TV.
- 3** Using a VIDEO cable, connect VIDEO of VIDEO 1 IN on the projection TV to MONITOR OUT on the AV receiver.
- 4** Using an AUDIO/VIDEO cable, connect TV OUT on the projection TV to AUDIO/VIDEO 2 IN on the AV receiver.
- 5** Using an AUDIO/VIDEO cable, connect the video equipment to the AV receiver.
- 6** Select the Setup menu and set "Video Label" to "Receiver" to fix your TV's input to AV receiver (see "Video Label" on page 64).

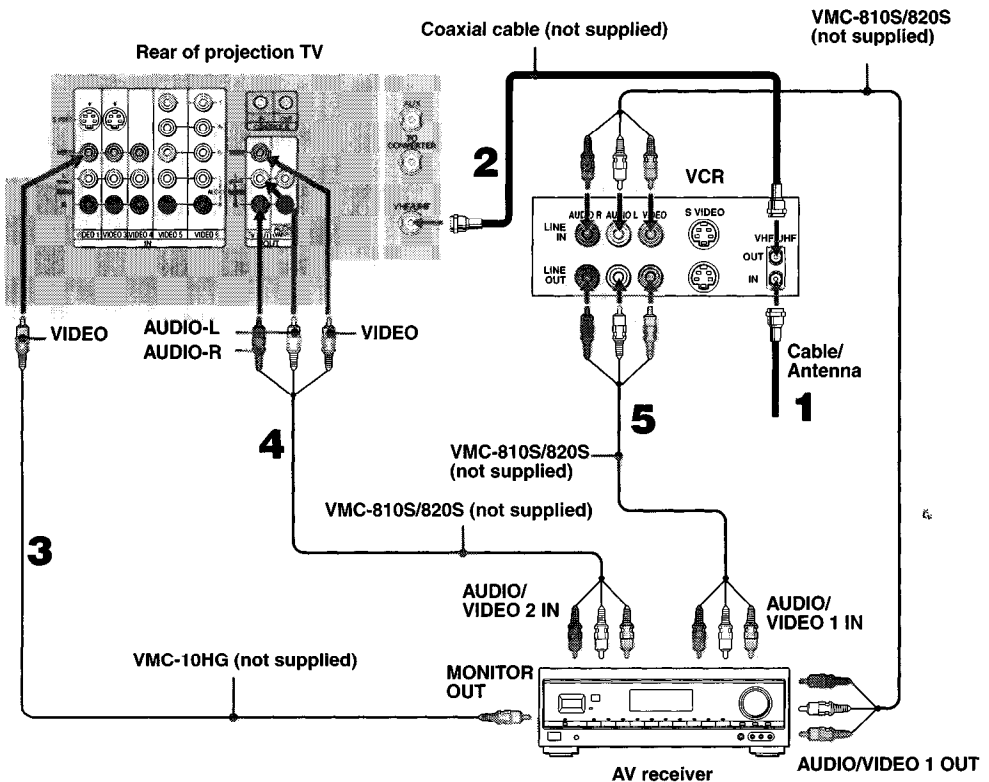

Using the CONTROL S Feature

CONTROL S allows you to control your projection TV system and other Sony equipment with one remote control. In addition to allowing you to control multiple devices with one remote control, the CONTROL S feature allows you to always point your remote control at your projection TV, instead of having to point it at the other equipment, which might be hidden or out of direct line of sight.

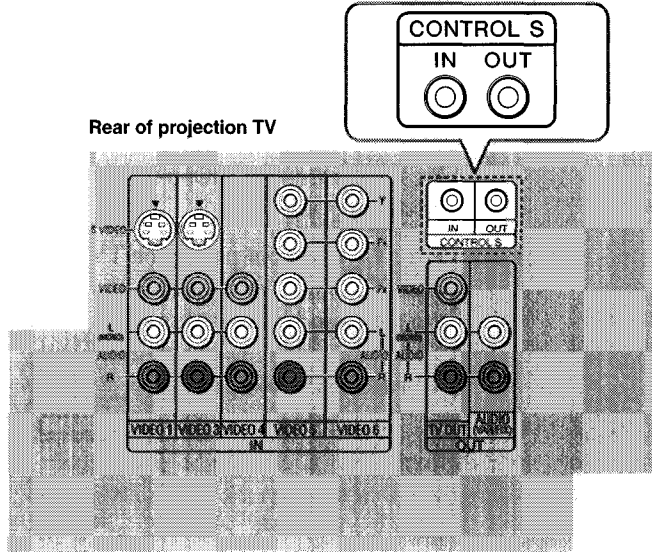

Setting Up the Projection TV Automatically

After you finish connecting your projection TV, you can run Auto Setup to set up your channels. The Auto Setup screen appears when you turn your projection TV on for the first time after installing it. If you do not want to set up the channels at this time, you can do it later by using the Auto Program feature in the Channel menu (see page 53).

⚠ The Auto Setup feature does not apply for installations that use a cable box for all channel selection.

Using Auto Setup

- 1** Press **POWER** on the front panel of your projection TV or on the remote control to turn on the projection TV.
- 2** Press the **TV (FUNCTION)** button on your remote control. Red light will briefly appear.
- 3** Press **CH+** on your projection TV to run Auto Setup, or press **CH-** to exit. If you use the channel buttons on your remote control, be sure to use the main set of buttons ()

Projection TV front panel

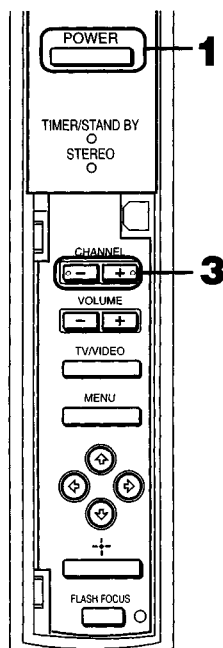

⚠ You can run Auto Program by selecting it in the Channel menu, as described on page 53.

Adjusting the Convergence Automatically – FLASH FOCUS™ –

The projection tube image appears on the screen in three colors (red, green and blue). If they do not converge, the color is poor and the picture blurs.

Before you use your projection TV, be sure to adjust the convergence.

The FLASH FOCUS feature allows you to adjust the convergence automatically.

It is recommended to perform FLASH FOCUS about 30 minutes after the projection TV is first turned on.

Projection TV front panel

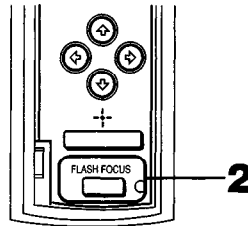

- 1 Receive a TV or cable TV program.
- 2 Press FLASH FOCUS.

The cross pattern shown below appears and FLASH FOCUS begins to work. The adjustment is completed when the cross pattern becomes white and you are returned to the program you were watching.

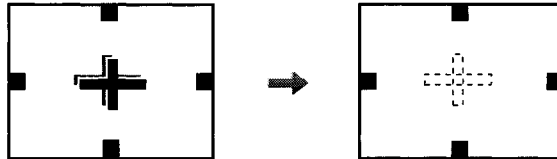

- It is recommended to perform FLASH FOCUS about 30 minutes after the projection TV is first turned on.
- You cannot perform any other functions until FLASH FOCUS has completed its cycle.
- If you perform any other operation while FLASH FOCUS is in progress, FLASH FOCUS operation is canceled.
- Unshielded speakers or other metallic objects can cause picture distortion if placed close to the projection TV.

Using the Features

Using the Remote Control

The following table describes the buttons on the remote control that are for more advanced functions.

Button Descriptions

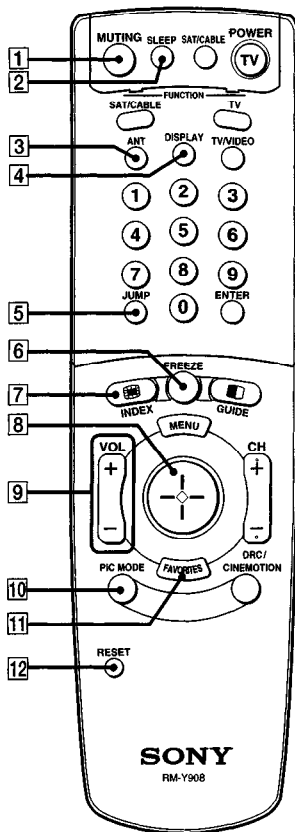

Outside Panel

Button	Description
1 MUTING	Press to mute the sound. Press again or press VOL + to restore the sound.
2 SLEEP	Press repeatedly until the projection TV displays the time in minutes (15, 30, 45, 60, or 90) that you want the projection TV to remain on before shutting off automatically. Cancel by pressing until SLEEP OFF appears. While the Sleep feature is set, press once to view the remaining time.
3 ANT	Changes between the VHF/UHF input and the AUX input.
4 DISPLAY	Press once to display the current time and channel label (if set) and channel number. Press again to turn Display off. See page 62 for details on setting the time.
5 JUMP	Press to jump back and forth between two channels. The projection TV alternates between the current channel and the last channel that was selected.
6 FREEZE	Freezes the window picture. Press again to restore the picture.
7 INDEX	Press to enter the Channel Index mode. You can view and select from twelve channels without leaving the current one.
8 	The joystick allows for movement of the on-screen cursor. Pressing down on the center of the joystick selects the item.
9 VOL +/-	Adjusts the volume.
10 PIC MODE	Press repeatedly to step through the available video picture modes: Vivid, Standard, Movie and Pro. Also available in the Video menu. For details, see "Selecting Video Options" on page 48.
11 FAVORITES	Displays the Favorite Channels list. For details, see "Using Favorite Channels" on page 40.
12 RESET	Press when in a menu to reset the settings to the factory defaults.

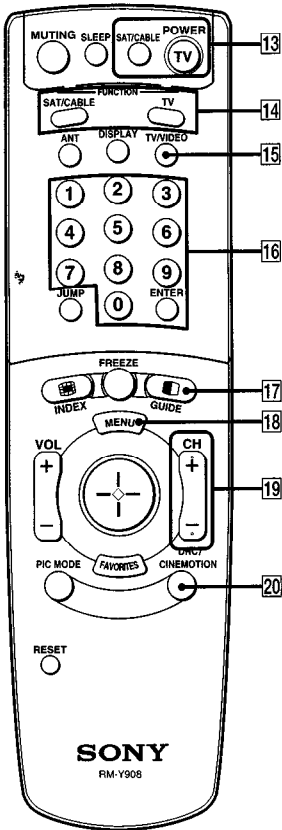
**Button****Description**

- | | |
|--|---|
| <p>13 POWER buttons (GREEN)</p> <p>14 FUNCTION buttons</p> <p>15 TV/VIDEO</p> <p>16 0 – 9 and ENTER</p> <p>17 </p> <p>18 GUIDE</p> <p>19 MENU</p> <p>19 CH +/-</p> <p>20 DRC/ CINEMOTION</p> | <p>Turn on and off the projection TV and other audio/video equipment you have programmed into the remote control. For instructions, see “Programming the Remote Control” on page 65.</p> <p>Select the equipment (TV, SAT/CABLE) that you want to operate. The indicator lights up momentarily when pushed to show which device the remote control is operating.</p> <p>Cycles through the video equipment connected to your projection TV’s video inputs: TV, VIDEO 1, VIDEO 2, VIDEO 3, VIDEO 4, VIDEO 5 and VIDEO 6.</p> <p>Press 0 - 9 to select a channel, the channel changes after 2 seconds. Press ENTER to select immediately.</p> <p>Turns on/off Twin View. For details, see “Using Twin View™” on page 41.</p> <p>Displays the program guide of your satellite.</p> <p>Press to display the projection TV on-screen menu. Press again to exit from the menu.</p> <p>Scan through channels.</p> <p>Press repeatedly to step through the available high-resolution picture modes: Interlaced, Progressive and CineMotion. For details, see “Using the Video Menu” on page 48.</p> |
|--|---|

 To scan rapidly through the channels, press and hold down CH+ or CH-.

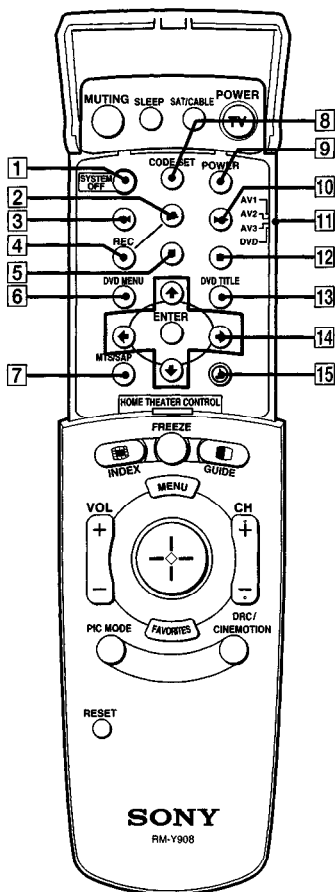

Inside Panel

Button	Description
1 SYSTEM OFF	Press to turn off the projection TV and all equipment connected with S-Link.
2 ▶	Play
3 ◀	Rewind
4 REC	Record
5 ■	Stop
6 DVD MENU	Displays the DVD menu.
7 MTS/SAP	Press to scroll through the Multi-channel TV Sound (MTS) options: Stereo, Auto SAP, and Mono.
8 CODE SET	Used for programming the remote control to operate non-Sony video equipment. For details, see "Programming the Remote Control" on page 65.
9 POWER	Press to turn on the DVD/VCR player you have programmed into the remote control. For instructions, see "Programming the Remote Control" on page 65.
10 ▶▶	Fast-forward
11 AV1 AV2 AV3 DVD	Use to switch control for connected video equipment. You can program one video source for each switch position. For details, see "Programming the Remote Control" on page 65.
12	Pause (Press again to resume normal playback)
13 DVD TITLE	Displays the DVD title.
14 ↑, ↓, ←, →, and ENTER	Use to operate the DVD menu.
15 🔊	Press to select an audio option: Steady Sound ON or OFF.

Watching the TV

Many TV features can be accessed directly through the remote control. The following will explain the function of some of the buttons found on your remote control.

Buttons for Projection TV Operations

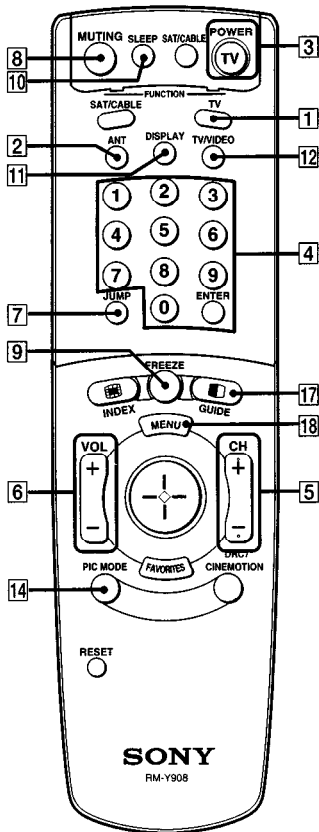

1 TV (FUNCTION)

Activates the remote control for use with the projection TV.

2 ANT— (AUX input)

Press to change between the VHF/UHF input and the AUX input (for detailed connection information, see “Cable and Antenna” on page 16 or “Cable Box Connections” on page 17).

3 TV (POWER)

Turns the projection TV on and off. If a video input indication (e.g., VIDEO 1, VIDEO 2) appears on the screen, press TV/VIDEO or CH +/- until a channel number appears.

4 0-9 and ENTER

Use for direct channel selection. Press 0-9 to select a channel (for example, to select channel 10, press 1 and 0). The channel will change after 2 seconds, or you can press ENTER for immediate selection.

5 CH +/-

Press to scan through the channels (+ up or – down).

6 VOL +/-

Press to adjust the volume (+ up or – down).

7 JUMP

Press to alternate or jump back and forth between two channels. The projection TV will jump between the current channel and the last channel selected.

8 MUTING

Press to mute the sound. “MUTING” will appear on the screen and will dim three seconds later. To restore the sound, press again or press VOL +.

9 FREEZE — (yellow labeled button)

This is useful when you need to copy down information that appears on the TV’s screen (see “Using the Freeze Function” on page 44).

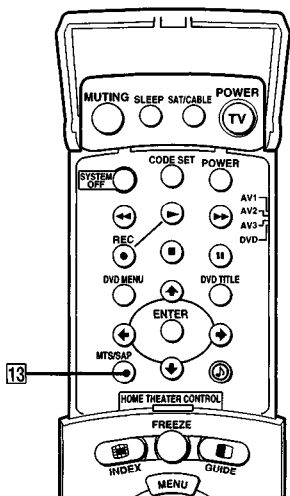

10 SLEEP

Press repeatedly until the projection TV displays the approximate time in minutes (15, 30, 45, 60, or 90) that you want the projection TV to remain on before shutting off automatically.

Cancel by pressing SLEEP until "SLEEP OFF" appears.

11 DISPLAY

Press to display the channel number, current time and channel label (if set).

To turn the display off, press DISPLAY again.

12 TV/VIDEO

Press repeatedly to scroll through available video inputs: TV, VIDEO 1, VIDEO 2, VIDEO 3, VIDEO 4, VIDEO 5 and VIDEO 6.

If you select Skip as a Video Label in the Setup menu, your projection TV will skip the video input you selected (see "Video Label" on page 64).

13 MTS/SAP

Press to scroll through the Multi-channel TV Sound (MTS) options (see "MTS" on page 50).

14 PIC MODE

Press PIC MODE repeatedly to directly choose one of five different video modes that best suits the program you are watching.

Vivid: Select for enhanced picture contrast and sharpness.

Standard: Select to display a standard picture for normal viewing environments.

Movie: Select to display a finely detailed picture for low light environments.

Pro (Professional): Select to display a picture with minimum enhancements.

When you select each mode, you can also adjust the picture quality (such as Brightness, Color, etc.) to suit your taste. For details, see "Mode" on page 48.

Watching the Digital TV

When you have connected the DTV receiver, you can enjoy digital TV programs. This projection TV is capable of receiving the 1080i, 720p, 480p and 480i digital TV formats.

 This projection TV is not capable of displaying a native 720p format signal. When a 720p format signal is received, it is converted into a 480p format signal.

To view a digital TV program

- 1** Connect the DTV receiver to VIDEO 5 or 6 IN on the projection TV. (for details, see page 28)
- 2** Press TV/VIDEO to select VIDEO 5 or 6.
- 3** Select a digital channel on the DTV receiver. For details, see the Operating Manual of the DTV receiver.
- 4** Adjust the volume of the projection TV as necessary.

Using Favorite Channels

The Favorite Channel feature lets you select programs from a list of favorite channels that you preset.

To display a list of your favorite channels:

➤ Your Favorite Channel options can be set automatically or manually. The factory setting for Favorite Channel is Auto. When Favorite Channel is set to Auto, the last eight channels selected with 0-9 buttons will be set as Favorite Channel options. If you want to input your own selections as Favorite Channel settings, see "Favorite Channel" on page 52.

1 Press FAVORITES.

The Favorite Channel options appear.



2 Move the joystick up or down to highlight the channel you want to watch. The program on that channel appears in the preview window. Press to select.

Using Twin View™

Twin View enables you to watch two programs at the same time. You can also change the size of both the left and right pictures.



Displaying Twin Pictures

To display twin pictures

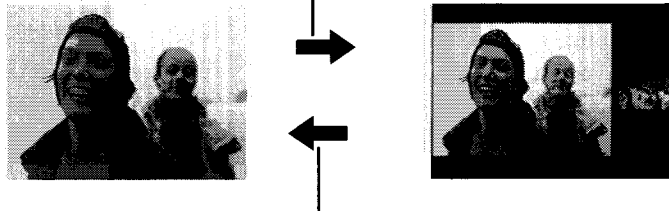
- 1** Make sure your projection TV is tuned to a working channel.
- 2** Press .



To cancel twin pictures

- Press  again (or press .

Activating the Picture

Although two pictures appear on the screen at the same time, only one picture is active. Change the picture size by using the joystick. For an active picture, you can:

- Change channels.
- Adjust the volume.
- Switch the input sources from VHF/UHF to cable by pressing ANT or TV/VIDEO to switch the video input.
- Change the picture size by pressing the joystick up or down.

To activate the right picture

- Move the joystick to the right.

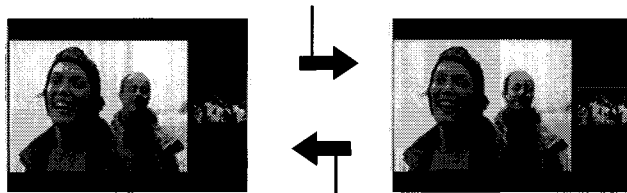

To activate the left picture

- Move the joystick to the left.

(Continued)

- ✔ When you adjust the twin screen sizes, the projection TV memorizes the change. The next time you use the Twin View feature, the memorized sizes appear.
- ✔ When viewing an enhanced 16:9 picture, the aspect ratio changes to 4:3 in Twin View. The picture will be reformatted to that aspect ratio.
- ✔ If viewing a 720p or 1080i format input source, the aspect ratio will maintain the original 16:9 aspect ratio.
- ✔ Hookups that affect your ability to use Twin View:
 - If you are viewing all channels through the cable box, the Twin View feature will not work. The cable box only unscrambles one signal at a time, so the right picture will be the same as the left picture.
 - You can watch a scrambled cable channel and another video source. Be sure your DVD player, VCR or satellite receiver are connected to one of the VIDEO IN 1-6 and AUX inputs on the rear of the projection TV. Pictures from equipment connected to VIDEO 5, 6 and AUX will only appear in the left picture, not in the right.
- ✔ The active picture is highlighted in cyan.

Changing the Picture Size

The zoom feature lets you change the size of the left and right pictures.

To enlarge the left picture (reduce the right)

- 1** Move the joystick left to activate the left picture (if not already activated).
- 2** Move the joystick up to enlarge the picture and move the joystick down to reduce the picture.

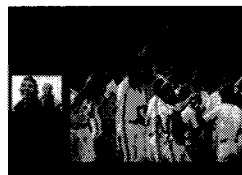

To enlarge the right picture (reduce the left)

- 1** Move the joystick right to activate the right picture (if not already activated).
- 2** Move the joystick up to enlarge the picture and move the joystick down to reduce the picture.

 When you adjust the twin screen sizes, the projection TV memorizes the change. The next time you use the Twin View function, the memorized sizes appear.

Using the Freeze Function

The FREEZE button allows you to temporarily capture a program's picture. You can use this feature to write down information such as phone numbers, recipes, etc.

To use the Freeze function

- 1** When the program information you want to capture is displayed, press FREEZE.
- 2** The projection TV switches to Twin View mode and displays the "frozen" picture on the right, while the current program continues on the left.



- 3** To cancel and return to normal viewing, press FREEZE.

Freeze feature is not available if you are already in Twin View™ mode.

Using Channel Index

Channel Index allows you to display multiple channels and select one directly.

The channels used for Channel Index will come directly from the projection TV's list of receivable channels (those set during "Auto Program" on page 53)

⚠ Channel Index will not function when Parental Lock is activated. (See "Using the Parent Menu" on page 54.)

To use the Channel Index function

1 Press .

The current channel will be reduced in size and displayed in the center of the screen in normal motion picture format. The first twelve receivable channels will appear one after another, clockwise, around the center picture. These small pictures are updated in intervals of one second. The channel number and channel caption (if set) on the second and later appearances will dim.

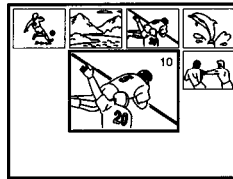

A cyan-colored frame will appear to indicate current channel selection.

2 Move the joystick in any direction to move the cyan frame to the channel that you wish to view, and press .

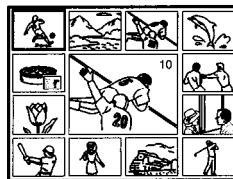

The selected channel will zoom in and move to the center, and the sound of that channel will be heard.

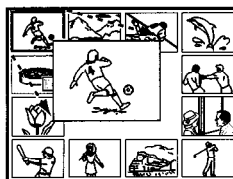

(Continued)

For the center picture you can:

- Change the channel by pressing 0-9 and ENTER.
- Switch the input sources from VHF/UHF to cable by pressing ANT or to the video input by pressing TV/VIDEO, without changing the surrounding channels.

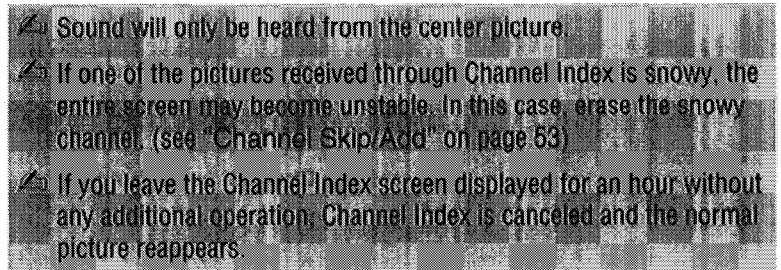

3 If you wish to view another channel, repeat step 2.

To view another twelve channels, press CH+.

To view the previous twelve, press CH-.

To view the normal picture of the selected channel, proceed to step 4.

4 Press .

The center picture will be enlarged for normal viewing.



To cancel Channel Index

- Press  again to resume normal viewing.

Using the Menus



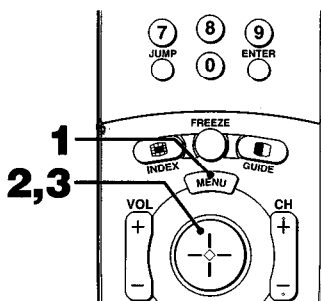



Overview





Opening and choosing a menu:

- 1 Press MENU to display the menu screen.
- 2 Move the joystick to the desired menu icon and press  to select it.
- 3 Use the joystick to scroll through the features.
- 4 See the specific menu page for instructions on moving through the menu.

The menu gives you access to the following features:

Menu Icon	Description	Page
	Allows you to make adjustments to your picture settings. It also allows you to customize the Picture Mode based on the type of program you are viewing.	48
	Offers enhanced audio options such as listening to second audio programming (SAP), or customizing the Effect of the sound on your projection TV.	50
	Allows you to set up a Favorite Channel list, run the Auto Program function, and more.	52
	Lets you control the viewing of programs based on their ratings.	54
	Lets you set the clock on your projection TV and allows you to program your projection TV for scheduled viewing using the Timers.	62
	Provides several options for setting up your channels, labeling your Video inputs, and selecting the language of the on-screen menus.	63





To end a menu session:
Press MENU again.

To end one menu session and move to another:
Press the joystick  to return to the menu icons. Move the joystick to choose the next menu icon and press  to select it.



Using the Video Menu

To select the Video Menu

- 1** Press MENU.
- 2** Move the joystick to the Video icon  and press .
- 3** Use the joystick to scroll through the features.
- 4** Press  to select a feature. That feature's adjustment appears.
- 5** Use the joystick to make the desired adjustments.
- 6** Press  to select/set.
- 7** Press MENU to exit the menu screen.

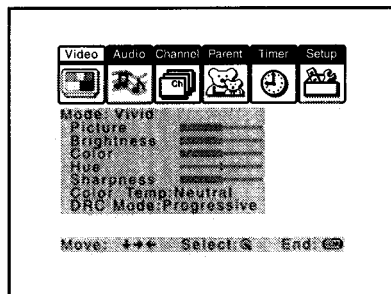

To restore the factory default settings for Picture, Brightness, Color, Hue, Sharpness and Color Temp

- Press RESET on the remote control when in the Video menu.

Selecting Video Options

 To quickly and easily change from one Video Mode to another, use the PIC MODE on the remote control.

The Video menu includes the following options.





Option	Description
Mode	Vivid Select for enhanced picture contrast and sharpness.
<i>Customized picture viewing</i>	Standard Recommended for Normal viewing conditions.
	Movie Select for soft, film like, picture.
	Pro Select for professional monitor like appearance.
 You can alter the Video menu settings (Picture, Brightness, Color, etc.) for each Mode.	
Picture	Adjust to increase picture contrast and deepen the color or decrease picture contrast and soften the color.
Brightness	Adjust to brighten or darken the picture.
Color	Adjust to increase or decrease color intensity.
Hue	Adjust to increase or decrease the green tones.
Sharpness	Adjust to sharpen or soften the picture.
Color Temp	Choose from three color temperatures:
<i>White intensity adjustment</i>	Cool Select to give the white colors a blue tint.
	Neutral Select to give the white colors a neutral tint.
	Warm Select to give the white colors a red tint (NTSC-Standard).

Option	Description
DRC Mode	Creates a high-resolution picture with 4x density, for high quality sources (i.e., DVD player, Satellite receiver).
Digital Reality Creation	Select from Interlaced, Progressive and CineMotion.
Interlaced	Recommended for moving pictures.
Progressive	Recommended for still images and text.
CineMotion	Recommended for 24 frame-per-second films.



Using the Audio Menu

To select the Audio Menu

- 1** Press MENU.
- 2** Move the joystick to the Audio icon  and press .
- 3** Use the joystick to scroll through the options.
- 4** Press  to select an option. That option's settings appear.
- 5** Use the joystick to scroll through the settings.
- 6** Press  to select the desired setting.
- 7** Press MENU to exit the menu screen.

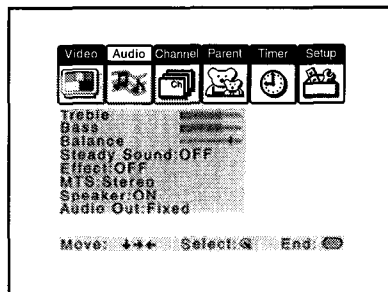

To restore the factory default settings for Treble, Bass and Balance

- Press RESET on the remote control when in the Audio menu.

Selecting Audio Options

The Audio menu includes the following options:





Option	Description
Treble	Adjust to increase or decrease higher-pitched sounds.
Bass	Adjust to increase or decrease lower-pitched sounds.
Balance	Adjust to emphasize left or right speaker balance.
Steady Sound	ON Select to stabilize the volume.
	OFF Select to turn off Steady Sound.
Effect	TruSurround Select for surround sound (for stereo programs only).
	Simulated Adds a surround-like effect to mono programs.
	OFF Normal stereo or mono reception.
MTS	Stereo Select for stereo reception when viewing a program broadcast in stereo.
<i>Enjoy stereo, bilingual and mono programs</i>	Auto-SAP Select to automatically switch the projection TV to second audio programs when a signal is received. (If no SAP signal is present, the projection TV remains in Stereo mode.)
	Mono Select for mono reception. (Use to reduce noise during weak stereo broadcasts.)

Option	Description	
Speaker	ON	Select to turn on the projection TV speakers.
	OFF	Select to turn off the projection TV speakers and listen to the projection TV's sound only through your external audio system speakers.
Audio Out <i>Easy control of volume adjustments</i>	Variable	The projection TV's speakers are turned off, but the volume output from your audio system can still be controlled by the projection TV's remote control.
	Fixed	The projection TV's speakers are turned off and the volume, bass and treble output of the projection TV is fixed. Use your audio receiver's volume control to adjust the volume through your audio system.



Using the Channel Menu

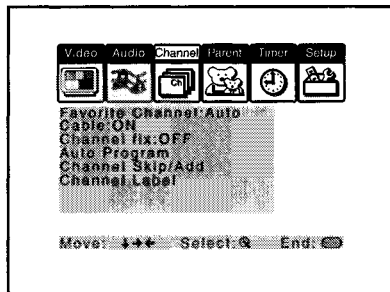

To select the Channel Menu

- 1** Press MENU.
- 2** Move the joystick to the Channel icon  and press .
- 3** Use the joystick to scroll through the features.
- 4** Press  to select a feature. That feature's options appear.
- 5** Use the joystick to scroll through the options.
- 6** Press  to select the desired option.
- 7** Press MENU to exit the menu screen.





Selecting Channel Options

The Channel menu includes the following options:

Option	Description	
Favorite Channel	Auto	Select if you want Favorite Channel options to be set automatically to the last eight channels selected with the 0-9 buttons.
	Manual	Select if you want to input your own selections as Favorite Channel options. <ol style="list-style-type: none"> 1 Press  to select a favorite channel number. 2 Use the joystick to scroll through the channels until you find the channel you want to add to your favorites. 3 Press  to select it.
Cable	ON	Select if you are receiving cable channels with a CATV cable.
	OFF	Select if you are using an antenna.

 You should run Auto Program after changing the Cable setting.

Option	Description
Channel Fix <i>Useful when you have a cable box or satellite receiver connected</i>	2-6 "Fix" your projection TV's channel setting to 3 or 4 and use the cable box, VCR or satellite receiver to change channels. Select one of these settings if you have connected the device to the VHF/UHF jack. AUX 2-6 Same as 2-6, except you select one of these settings if you have connected the device to the AUX jack. (see page 15) VIDEO 1 Use when connecting an AV receiver to control external video sources. TV output should be connected through the AV receiver.
Auto Program	Automatically programs the projection TV for all receivable channels.
Channel Skip/Add	Removes and adds viewable channels. 1 Use the joystick to scroll through the channels until you find the channel you want to skip/add. 2 Press  to select it. 3 Press the joystick up or down to toggle between "Add" and "Skip." 4 Press  to select.
Channel Label	Label up to 20 channels with their station call letters.



Using the Parent Menu

The Parent menu allows you to set up the TV to block programs according to their content and rating levels.



These ratings are assigned by a federal rating board. Not all programs are rated. Using the Parental Lock blocks programs with a specific rating, but it does not block an entire channel.

⚠ Channel Index will not function when Parental Lock is activated.

Using the Parent Menu

To select the rating

First, set a password, then select the country you reside in (U.S.A. or Canada) and your desired rating.

- 1 Press MENU.
- 2 Move the joystick to the Parent icon  and press .

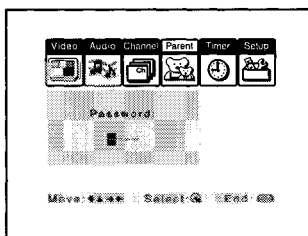



- 3 Use the 0-9 buttons on the remote control to enter your four-digit password.
- 4 Confirm your password by entering it again. Your password is stored and the Parent menu options appear.

⚠ You need the password entered here for any future access into the Parent menu. If you lose your password, see 'Lost password' on page 71.

⚠ If you want to change the password, see page 56.

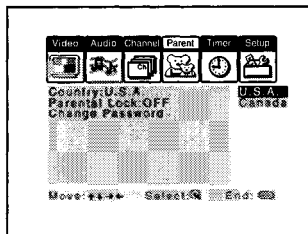
- 5 Make sure that "Country" is selected, and press .



- 6** Move the joystick up or down to select U.S.A. or Canada according to the country you reside in, and press .

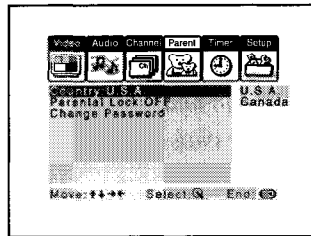

- 7** Move the joystick down to select “Parental Lock”, and press .

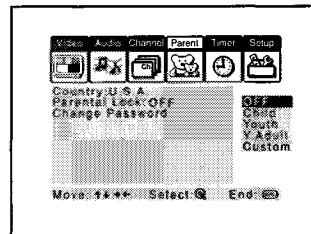

- 8** Move the joystick up or down to select a desired rating, and press .

If you select Child, Youth, Young Adult or Custom, the Parental Control is activated automatically.

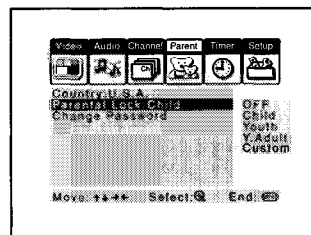

If you want to select the ratings from Custom, see “Using Custom Rating Options” on page 57.

- 9** Press MENU to exit the menu screen.

(Continued)

 If you are not familiar with the Parental Guideline rating system, you should select Child, Youth, or Young Adult to help simplify the rating selection. To set more restrictive ratings, select Custom.

 For descriptions of Child, Youth, and Young Adult ratings, see pages 60 and 61.

The Parent menu includes the following options.

Option	Description
Parental Lock	OFF
<i>Turn ratings on/off and select a rating system</i>	Parental lock is off. No programs are blocked from viewing.
	Child
	Maximum ratings permitted are: <input type="checkbox"/> US: TV-Y, TV-G, G <input type="checkbox"/> Canada: TV-Y, C, G
	Youth
	Maximum ratings permitted are: <input type="checkbox"/> US: TV-PG, PG <input type="checkbox"/> Canada: TV-PG, PG, 8 ans+
	Young Adult
	Maximum ratings permitted are: <input type="checkbox"/> US: TV-14, PG-13 <input type="checkbox"/> Canada: TV-14, 14+, 13 ans+
	Custom
	Select to set ratings manually. <input type="checkbox"/> US: See page 60 for details. <input type="checkbox"/> Canada: See page 61 for details.
Change Password	For changing your password. (see below)

To deactivate the Parental Control feature

- Set Parental Lock to OFF when in the Parent menu.

To change the password

- 1** Select Change Password option when in the Parent menu using the joystick, and press .
- 2** Enter a new four-digit password using the 0-9 buttons.
- 3** Confirm the new password by entering it again.
- 4** Press MENU to exit the menu screen.

Viewing Blocked Programs

You can view a blocked program by entering the password.

- 1** Press ENTER when tuned to a blocked program.
- 2** Enter your password using the 0-9 buttons.

Parental Control will be canceled temporarily until you turn your projection TV off.

Using Custom Rating Options

If you want to select the ratings to be blocked from Custom, follow the procedure below.

- 1 Perform the steps 1 to 7 in “To select the rating” on page 54 to display the Parental Lock options.
- 2 Move the joystick up or down to select “Custom,” and press .

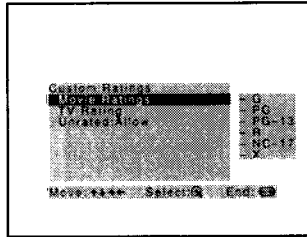

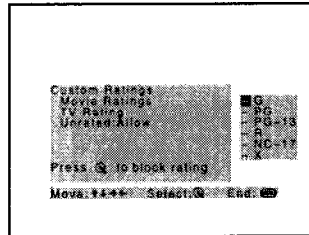

- 3 Make sure that “Movie Ratings” is selected, and press .

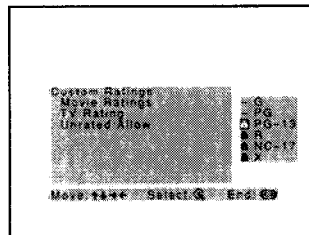

- 4 Move the joystick up or down to select the rating to be blocked, and press .

The  indicator automatically appears beside the selected rating and all “higher” ratings, indicating that the programs that match the ratings will be blocked.



To unblock a rating, select it by moving the joystick up or down, then press . The indicator  changes into “-” and all “lower” ratings are unblocked.

(Continued)

- 5** Move the joystick left, then down, to select “TV Rating” or “Program,” and press .

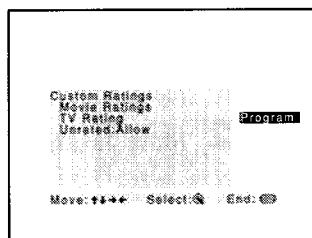

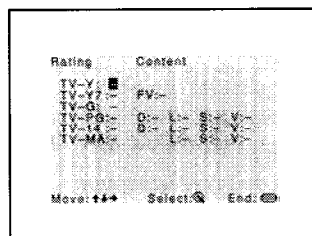

- 6** The “TV Rating” setting menu appears.

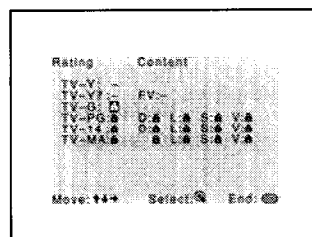

- 7** Move the joystick up or down to select the rating to be blocked, and press .

The  indicator automatically appears beside the selected rating and all “higher” ratings, indicating that the programs that match the ratings will be blocked.





To unblock a rating, select it by moving the joystick up or down, then press . The indicator  changes into “-” and all “lower” ratings are unblocked.

Some TV ratings have additional content ratings called “extenders.” The extenders are defined as follows: D (sexually suggestive Dialog), FV (Fantasy Violence), L (coarse Language), S (Sexual situations) and V (Violence). By setting the extenders, you can define additional viewing limits. All of the extenders included in the selected ratings will be blocked. If you wish to allow any of them to be viewed, go to step 8.

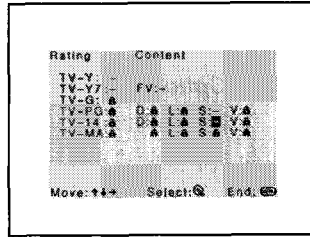
- 8** Move the joystick left or right to select the extender to be viewed, and press .



“-” appears beside the selected extender, indicating that the programs that match the extender can be viewed.

If you press  again,  is displayed to show that the programs that match the extender will be blocked again.

- 9** Repeat step 8 for other extenders.

All programs that match the ratings you select and higher, except for the extenders that were canceled, will be blocked.

- 10** Press MENU to exit the menu screen.

US custom rating options

If you selected U.S.A. as the country of residence on page 54, the Custom Rating Menu includes the following options. (If you selected Canada, see page 61.)

 To ensure maximum blocking capability, the age-based ratings should be blocked.

 If you choose to block unrated TV programs, please be aware that the following programs may be blocked: emergency broadcasts, political programs, sports, news, public service announcements, religious programs and weather.

Option	Description
Movie Rating	G All children and General Audience.
	PG Parental Guidance suggested.
	PG-13 Parental Guidance for children under 13.
	R Restricted viewing, parental guidance is suggested for children under 17.
	NC-17 and X No one 17 and under allowed.
	TV Rating Age-Based Options
<i>Block programs by their rating, content or both</i>	TV-Y All children.
	TV-Y7 Directed to older children.
	TV-G General Audience.
	TV-PG Parental Guidance suggested.
	TV-14 Parents Strongly cautioned.
	TV-MA Mature Audience only.
Unrated <i>Block programs or movies that are broadcast without a rating</i>	Content-Based Options
	FV Fantasy Violence.
	D Suggestive Dialogue.
	L Strong Language.
	S Sexual situations.
	V Violence.
Block Blocks all programs and movies that are broadcast without a rating.	
Allow Allows programs and movies that are broadcast without a rating.	

 The content ratings will increase depending on the level of the age-based rating. For example, a program with a TV-PG V (Violence) rating may contain moderate violence, while a TV-14 V (Violence) rating may contain more intense violence.

Canadian custom rating options



If you selected Canada as the country of residence on page 54, the Custom Rating Menu includes the following options. (If you selected U.S.A., see page 60.)

Option	Description	
English Rating	C	All children.
	C8+	Children 8 years and older.
	G	General programming.
	PG	Parental Guidance.
	14+	Viewers 14 and older.
French Rating	18+	Adult programming.
	G	General programming.
	8 ans+	Not recommended for young children.
	13 ans+	Not recommended for ages under 13.
USA Rating	16 ans+	Not recommended for ages under 16.
	18 ans+	Programming restricted to adults.
	See "TV Rating" on page 60 for details.	





Using the Timer Menu

To select the Timer menu

- 1 Press MENU.
- 2 Move the joystick to the Timer icon  and press .

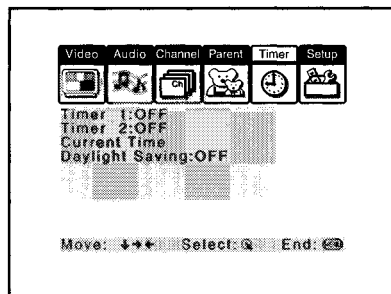

To set the Current Time

- 1 Use the joystick to select “Current Time”, then press .
- 2 If it is currently Daylight Saving Time, be sure to set the mode to “ON” first.
- 3 Use the joystick to enter the correct time, then press .
- 4 Press MENU to exit the menu screen.



To set the Timer

Before setting the timer, be sure to set your projection TV’s clock to the current time and Daylight Saving Mode.

- 1 Move the joystick to “Timer 1” or “Timer 2”, then press .
- 2 Use the joystick to enter your day, time and channel preferences, then press .
- 3 Press MENU to exit the menu screen.

To reset the Clock or Timers

- Press RESET on the remote control after selecting that option in the Timer menu.

Selecting Timer Options





The Timer menu includes the following options:

Option	Description
Timer 1	Program
Timer 2	Program
	Select to set the Timer by day, time, duration, and channel.
	OFF
	Select to turn off the Timer. (Your previous settings will be saved.)
Current Time	Set the current time.
Daylight Saving	ON
	Select in the Spring to adjust the time during Daylight Saving Time.
	OFF
	Select in the Fall to adjust the time at the end of Daylight Saving Time.



Using the Setup Menu

To select the Setup Menu

- 1** Press MENU.
- 2** Move the joystick to the Setup icon  and press .
- 3** Use the joystick to scroll through the features.
- 4** Press  to select a feature. That feature's options appear.
- 5** Use the joystick to scroll through the options.
- 6** Press  to select the desired option.
- 7** Press MENU to exit the menu screen.





Selecting Setup Options

The Setup menu includes the following options:

Option	Description
Caption Vision	Allows you to select from three closed caption modes (for programs that are broadcast with closed captioning).
OFF	Turns off Caption Vision.
CC1, CC2, CC3, CC4	Displays a printed version of the dialog or sound effects of a program. (Should be set to CC1 for most programs.)
TEXT1, TEXT2, TEXT3, TEXT4	Displays network/station information presented using either half or the whole screen (if available). For closed captioning, set to CC1.
XDS (Extended Data Service)	Displays a network name, program name, program length, and time of the show if the broadcaster offers this service.

(Continued)

Option	Description
Video Label	Allows you to label the audio/video components you connected to the projection TV so you can identify them when using TV/VIDEO. When in the Setup menu's Video Label feature, use the joystick to highlight an input to label, then press  to select it. Use the joystick to scroll through the labels. Press  to select the component you connected to each of the input jacks on the back of your projection TV. Select "Skip" if you do not have a component connected to a particular set of input jacks.
VIDEO 1/2/3/4	VHS, 8mm, Beta, LD, Game, SAT, DVD, Web, Receiver, DTV, Skip
VIDEO 5/6	DVD, DTV, HD, Skip
	If you select "Skip", your projection TV skips this connection when you press TV/VIDEO.

 When you select "Receiver" on Video Label, your projection TV's input is fixed.

Language	Select to display all on-screen menus in your language of choice: English, Español, Français.						
16:9 Enhanced	Provides enhanced picture resolution for widescreen sources, such as selected DVD titles (only available when the projection TV is in VIDEO mode). Press TV/VIDEO and select from one of the following options: <table border="1" data-bbox="548 856 1179 997"> <tbody> <tr> <td>AUTO</td> <td>To activate automatically when a 16:9 signal is received.</td> </tr> <tr> <td>ON</td> <td>To activate manually.</td> </tr> <tr> <td>OFF</td> <td>To deactivate manually.</td> </tr> </tbody> </table>	AUTO	To activate automatically when a 16:9 signal is received.	ON	To activate manually.	OFF	To deactivate manually.
AUTO	To activate automatically when a 16:9 signal is received.						
ON	To activate manually.						
OFF	To deactivate manually.						

 AUTO/ON will appear when the projection TV is in VIDEO mode 1-6.
 ON/OFF will appear when the projection TV is in VIDEO mode 5-6 and the 480p signal occurs.

 To use this feature with widescreen DVDs, set your DVD player to 16:9 aspect ratio.

Other Information

Programming the Remote Control

The remote control is preset to operate Sony brand video equipment.

Sony Equipment	Switch Position on Remote Control	Programmable Code Number
Beta, ED Beta VCRs	AV1	303
8 mm VCR	AV2	302
VHS VCR	AV3	301
DVD Player	DVD	751

If you have video equipment other than Sony brand that you want to control with the projection TV's remote control, use the following procedures to program the remote control.

✓ The equipment must have infrared (IR) remote capability in order to be used with the remote control.

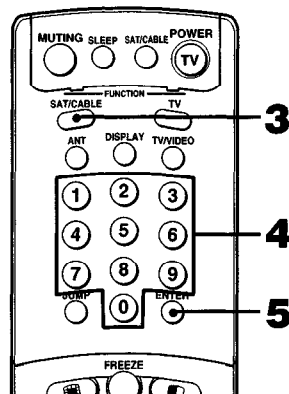
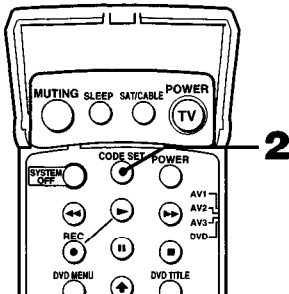

From the "Manufacturer's Codes" listed on page 67, select the three-digit code number for the manufacturer's code for your component. If more than one code number is listed, start with the number listed first. Use the code number to complete the following procedure.

To program a cable box or a satellite receiver

- 1 Open the panel of the remote control.
- 2 Press CODE SET inside the panel.
- 3 Close the panel and press SAT/CABLE (FUNCTION).
- 4 Enter the three-digit manufacturer's code number using the 0-9 buttons.
- 5 Press ENTER.
- 6 To check if the code number works, aim the projection TV's remote control at the component and press the green POWER button that corresponds with that component. If it responds, the programming is completed. If not, try using the other codes listed for that manufacturer.

(Continued)

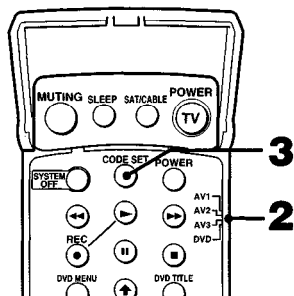

To program video equipment

- 1** Open the panel of the remote control.
- 2** Move the slide switch to the desired component type.
- 3** Press CODE SET inside the panel.

⚠ You must perform step 4 within 10 seconds of step 3, or you must start again from step 3.

- 4** Close the panel and enter the three-digit manufacturer's code number using the 0-9 buttons.
- 5** Press ENTER.

- 6** To check if the code number works, aim the projection TV's remote control at the component, open the panel, and press the green POWER button. If it responds, the programming is completed. If not, try using the other codes listed for that manufacturer.

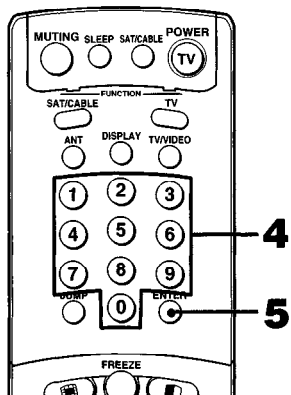

Tips

- If more than one code number is listed, try entering them one by one until you come to the correct code for your component.
- If you enter a new code number, the code number you previously entered at that setting is erased.
- In some rare cases, you may not be able to operate your component with the Sony remote control. In this case, use the component's own remote control unit.

Manufacturer's Codes**VCRs**

Manufacturer	Code
Sony	301
Admiral (M. Ward)	327
Aiwa	338, 344
Audio Dynamic	314, 337
Broksonic	319, 317
Canon	309, 308
Citizen	332
Craig	302, 332
Criterion	315
Curtis Mathes	304, 338, 309
Daewoo	341, 312, 309
DBX	314, 336, 337
Dimensia	304
Emerson	319, 320, 316, 317, 318, 341
Fisher	330, 335
Funai	338
General Electric	329, 304, 309
Go Video	322, 339, 340
Goldstar	332
Hitachi	306, 304, 305, 338
Instant Replay	309, 308
JC Penney	309, 305, 304, 330, 314, 336, 337
JVC	314, 336, 337, 345, 346, 347
Kenwood	314, 336, 332, 337
LXI (Sears)	332, 305, 330, 335, 338
Magnavox	308, 309, 310
Marantz	314, 336, 337
Marta	332
Memorex	309, 335

Manufacturer	Code
Minolta	305, 304
Mitsubishi/ MGA	323, 324, 325, 326
Multitech	325, 338, 321
NEC	314, 336, 337
Olympic	309, 308
Optimus	327
Panasonic	308, 309, 306, 307
Pentax	305, 304
Philco	308, 309
Philips	308, 309, 310
Pioneer	308
Quasar	308, 309, 306
RCA/ PROSCAN	304, 305, 308, 309, 311, 312, 313, 310, 329
Realistic	309, 330, 328, 335, 324, 338
Sansui	314
Samsung	322, 313, 321
Sanyo	330, 335
Scott	312, 313, 321, 335, 323, 324, 325, 326
Sharp	327, 328
Shintom	315
Signature 2000 (M. Ward)	338, 327
SV2000	338
Sylvania	308, 309, 338, 310
Symphonic	338
Tashiro	332
Tatung	314, 336, 337
Teac	314, 336, 338, 337
Technics	309, 308
Toshiba	312, 311

Manufacturer Code

Wards	327, 328, 335, 331, 332
Yamaha	314, 330, 336, 337
Zenith	331

DVD Players

Manufacturer	Code
Sony	751
Panasonic	753
Pioneer	752
RCA	755
Toshiba	754

Cable Boxes

Manufacturer	Code
Hamlin/Regal	222, 223, 224, 225, 226
Jerrold/G. I.	201, 202, 203, 204, 205, 206, 207, 208, 218
Oak	227, 228, 229
Panasonic	219, 220, 221
Pioneer	214, 215
Scientific	209, 210, 211
Atlanta	
Tocom	216, 217
Zenith	212, 213

Satellite Receivers

Manufacturer	Code
Sony	801
General	802
Electric	
Hitachi	805
Hughes	804
Panasonic	803
RCA/ PROSCAN	802, 808
Toshiba	806, 807

Operating Other Components with Your Projection TV Remote Control

Operating a VCR

Open the panel and move the slide switch to the AV input you coded for this device.

To Do This ...	Press
Turn on/off	green POWER button (inside the panel)
Change channels	CH +/-
Record	▶ and REC simultaneously
Play	▶
Stop	■
Fast forward	▶▶
Rewind the tape	◀◀
Pause	(press again to resume normal playback)
Search the picture forward or backward	▶▶ or ◀◀ during playback (release to resume normal playback)
Change input mode	Slide switch

Operating a DVD Player

Open the panel and move the slide switch to the DVD input you coded for this device.

To Do This ...	Press
Turn on/off	green POWER button (inside the panel)
Play	▶
Stop	■
Pause	(press again to resume normal playback)
Step through different tracks of an audio disc	▶▶ to step forward or ◀◀ to step backward
Step through different chapters of a video disc	CH+ to step forward or CH- to step backward
Display the DVD menu	DVD MENU
Select tracks directly	0-9 buttons
Display the menu (Setup)	MENU
Display the DVD title	DVD TITLE
Operate the DVD menu	↑, ↓, ←, →, ENTER

Operating a Cable Box

To Do This ...

Turn on/off
 Select Cable Box
 Select a channel
 Change channels
 Back to previous channel

Press

SAT/CABLE (POWER)
 SAT/CABLE (FUNCTION)
 0-9 buttons, ENTER
 CH +/-
 JUMP

Operating a Satellite Receiver

To Do This ...

Turn on/off
 Select Satellite Receiver
 Select a channel
 Change channels
 Back to previous channel
 Display channel number
 Display DBS guide
 Display DBS menu
 Move highlight (cursor)
 Select item

Press

SAT/CABLE (POWER)
 SAT/CABLE (FUNCTION)
 0-9 buttons, ENTER
 CH +/-
 JUMP
 DISPLAY
 GUIDE
 MENU
 Joystick or arrows



Troubleshooting

If, after reading these operating instructions, you have additional questions related to the use of your Sony television, please call our Customer Information Services Center at 1-800-222-SONY (7669) (U.S. residents only) or (416) 499-SONY (7669) (Canadian residents only).

Problem	Possible Remedies
No picture (screen not lit), no sound	<ul style="list-style-type: none"><input type="checkbox"/> Make sure the projection TV's power cord is connected securely to the wall outlet.<input type="checkbox"/> Push the power button on the front of the projection TV.<input type="checkbox"/> Check to see if the TV/VIDEO setting is correct: when watching TV, set to TV, and when watching connected equipment, set to VIDEO 1, 2, 3, 4, 5 or 6.<input type="checkbox"/> Try another channel. It could be station trouble.<input type="checkbox"/> The Parental Control feature is activated (see "Using the Parent Menu" on page 54).<input type="checkbox"/> If your projection TV does not turn on, and a red light keeps flashing, your projection TV may need service. Call your local Sony Service Center.
Remote control does not operate	<ul style="list-style-type: none"><input type="checkbox"/> Batteries could be weak. Replace the batteries.<input type="checkbox"/> Press TV (FUNCTION) when operating your projection TV.<input type="checkbox"/> Make sure the projection TV's power cord is connected securely to the wall outlet.<input type="checkbox"/> Locate the projection TV at least 3-4 feet away from fluorescent lights.<input type="checkbox"/> Check the orientation of the batteries.
Dark, poor or no picture (screen lit), good sound	<ul style="list-style-type: none"><input type="checkbox"/> Adjust the Picture setting in the Video menu (see page 48).<input type="checkbox"/> Adjust the Brightness setting in the Video menu (see page 48).<input type="checkbox"/> Check antenna/cable connections.<input type="checkbox"/> Adjust the convergence again using FLASH FOCUS (see "Adjusting the Convergence Automatically – FLASH FOCUS™ –" on page 33).
Good picture, no sound	<ul style="list-style-type: none"><input type="checkbox"/> Press MUTING so that "MUTING" disappears from the screen (see page 34).<input type="checkbox"/> Make sure Speaker is set to ON in the Audio menu (see page 51).<input type="checkbox"/> Check the MTS setting in the Audio menu (see "MTS" on page 50).
Cannot receive digital channels (when a DTV receiver is connected)	<ul style="list-style-type: none"><input type="checkbox"/> Check the connections between the DTV receiver and the projection TV (see page 28).<input type="checkbox"/> Check your local listings to find out if you can receive digital broadcasts in your area.
Cannot receive upper channels (UHF) when using an antenna	<ul style="list-style-type: none"><input type="checkbox"/> Change Cable to OFF (see page 52).<input type="checkbox"/> Use Auto Program in the Channel menu to add receivable channels that are not presently in TV memory (see page 53).
No color	<ul style="list-style-type: none"><input type="checkbox"/> Adjust the COLOR settings in the Video menu (see page 48).
Only snow and noise appear on the screen	<ul style="list-style-type: none"><input type="checkbox"/> Check the Cable setting in the Channel menu (see "Cable" on page 52).<input type="checkbox"/> Check the antenna/cable connections.<input type="checkbox"/> Make sure the channel is broadcasting programs.<input type="checkbox"/> Press ANT to change the input mode (see page 37).
Dotted lines or stripes	<ul style="list-style-type: none"><input type="checkbox"/> Adjust the antenna.<input type="checkbox"/> Move the projection TV away from noise sources such as cars, neon signs, or hair-dryers.

Problem**Possible Remedies**

- | | |
|---|--|
| Projection TV is fixed to one channel | <input type="checkbox"/> Use Auto Program in the Channel menu to add receivable channels that are not presently in TV memory (see page 53).
<input type="checkbox"/> Check your Channel Fix settings (see page 53). |
| Double images or ghosts | <input type="checkbox"/> Use a highly directional outdoor antenna or a cable (when the problem is caused by reflections from nearby mountains or tall buildings). |
| Cannot operate menu | <input type="checkbox"/> If the item you want to choose appears in gray, you cannot select it.
<input type="checkbox"/> Turn the projection TV's power off and on again. |
| Cannot receive any channels when using cable TV | <input type="checkbox"/> Use Auto Program in the Channel menu to add receivable channels that are not presently in TV memory (see page 53).
<input type="checkbox"/> Check your cable settings.
<input type="checkbox"/> Make sure Cable is set to ON in the Channel menu (see page 52). |
| Cannot gain enough volume when using a cable box | <input type="checkbox"/> Increase the volume of the cable box using the cable box's remote control. Then press TV (FUNCTION) and adjust the projection TV's volume. |
| Channel Index does not display all available channels | <input type="checkbox"/> Make sure Cable is set to ON in the Channel menu (see "Cable" on page 52).
<input type="checkbox"/> Use Auto Program in the Channel menu to add receivable TV channels that are not presently in TV memory (see page 53). |
| Cannot receive channels
Unable to select a channel | <input type="checkbox"/> Use Auto Program in the Channel menu to add receivable TV channels that are not presently in TV memory (see page 53). |
| Lost password | <input type="checkbox"/> In the password screen (see page 54), enter the following master password: 4357. The master password clears your previous password; it cannot be used to temporarily unblock channels. |
| Cannot change channels with the remote control | <input type="checkbox"/> Be sure you have not inadvertently switched your projection TV from channel 3 or 4 setting if you are using another device to change channels.
<input type="checkbox"/> If you are using another device to control channels, be sure the "function" button for that device has been pressed, or the slide switch is set correctly. For example, if you are using your cable to control channels, be sure to press SAT/CABLE . |
| Cannot cycle through the other video equipment connected to the projection TV | <input type="checkbox"/> Be sure the Video Label feature has not been set to Skip (see page 64). |
| There is a black box on the screen | <input type="checkbox"/> You have selected a text option in the Setup menu and no text is available (see page 63 to reset Setup selections). To turn this feature off, select OFF in the Caption Vision option. If you were trying to get closed captioning, select CC1 instead of Text 1-4 . |
| There is no twin picture or it is just static | <input type="checkbox"/> Be sure your twin picture is set to a video source/channel that has a program airing.
<input type="checkbox"/> You may be tuned to a video input with nothing connected to it. Try cycling through your video inputs using TV/VIDEO .
<input type="checkbox"/> Twin View is not set to receive a signal from the AUX input. If you have connected a VCR, DVD player or satellite receiver to the AUX input on the projection TV, it will not show in the second picture. |

(Continued)

Other Information

Problem	Possible Remedies
You get the same program in the window picture as in the main picture	<ul style="list-style-type: none">❑ Both may be set to the same channel. Try changing channels in either the main picture or the window picture.❑ You may be running all your channels through a cable box. The cable box will only unscramble one signal at a time, so you cannot use the Twin View feature. If possible, run a direct cable to your projection TV's VHF/UHF input (this will only work if your cable system provides an unscrambled signal).
You cannot get anything but TV channels in your second picture	<ul style="list-style-type: none">❑ Be sure the video label has not been set to skip your video inputs. See the Setup menu on page 63.
Favorite Channel does not display your choices	<ul style="list-style-type: none">❑ Verify that Favorite Channel is set to Manual in the Channel menu (see "Favorite Channel" on page 52).
Some video sources do not appear when you press TV/VIDEO	<ul style="list-style-type: none">❑ Ensure that Video Label is not set to SKIP (see "Video Label" on page 64).

Specifications

Projection System	3 picture tubes, 3 lenses, horizontal in-line system	
Picture Tube	7-inch high-brightness monochrome tubes (6.3 raster size), with optical coupling and liquid cooling system	
Projection Lenses	High performance, large diameter hybrid lens F1.1	
Antenna	75 ohm external terminal for VHF/UHF	
Television System	NTSC, American TV Standard	
Screen Size (measured diagonally)	43 inches (KP-43HT20) 53 inches (KP-53HS20, KP-53HS30) 61 inches (KP-61HS20, KP-61HS30)	
Channel Coverage		
VHF	2-13	
UHF	14-69	
CATV	1-125	
Power Requirements	120V, 60 Hz	
Number of Inputs/Outputs		
Video (IN)	4	1 Vp-p, 75 ohms unbalanced, sync negative
S Video (IN)	3	Y: 1 Vp-p, 75 ohms unbalanced, sync negative C: 0.286 Vp-p (Burst signal), 75 ohms 500 mVrms (100% modulation)
Audio (IN)	6	Impedance: 47 kilohms 500 mVrms (100 % modulation), Impedance: 470 ohms
AUDIO (VAR/FIX) OUT	1	1 Vp-p, 75 ohms unbalanced, sync negative
TV Out	1	Minijacks
CONTROL S (IN/OUT)	1	Y: 1.0 Vp-p, 75 ohms unbalanced, sync negative P _B : 0.7 Vp-p, 75 ohms P _R : 0.7 Vp-p, 75 ohms
Component Video Input	2 (Y, P _B , P _R)	
RF Inputs	2	
Converter	1	

(Continued)

Other Information

Supplied Accessories	
Remote Control	RM-Y908
AA (R6) Batteries	2 supplied for remote control
Optional Accessories	
AV Cable	VMC-810/820/830 HG
Audio Cable	RKC-515HG
Control S Cable	RK-G69HG
Component Video Cable	VMC-10/30 HG
AV Receiver	STR-V555ES
TV Stand	SU-43HT4/43HT5
Speaker Output	20 W × 2 (KP-43HT20, KP-53HS30, KP-61HS30) 18 W × 2 (KP-53HS20, KP-61HS20)
Dimensions (W × H × D)	38 × 42 1/8 × 22 2/3 inches (965 × 1,069 × 577 mm) (KP-43HT20) 46 1/2 × 55 7/8 × 25 inches (1,180 × 1,417 × 632 mm) (KP-53HS20, KP-53HS30) 54 × 61 1/2 × 26 1/4 inches (1,370 × 1,560 × 666 mm) (KP-61HS20, KP-61HS30)
Mass	119 lb 8 oz (54.2 kg) (KP-43HT20) 152 lb 9 oz (69.2 kg) (KP-53HS20) 157 lb (71.2 kg) (KP-53HS30) 203 lb 11 oz (92.4 kg) (KP-61HS20) 210 lb 5 oz (95.4 kg) (KP-61HS30)
Power Consumption	
In Use	230 W
In Standby	Under 1 W

Design and specifications are subject to change without notice.

Index

16:9 (widescreen) **8, 64**

A

Activating a Twin View screen **41**
Adding channels to the channel list **53**
Adjusting audio, Steady Sound **50**
ANT button **34**
Antenna, connecting **16**
Aspect ratio, 16:9 in Twin View **42**
Audio menu **47, 50**
Audio receiver, connecting **25**
Audio/Video cable **12**
Auto Program (channel setup) **32, 53**
Auto Setup **32, 53**
AV receiver, connecting to TV OUT **15**

B

Balance, adjusting **50**
Bass, adjusting **50**
Batteries, inserting into remote **10**
Bilingual audio **50**
Blocking programs. See Ratings.
Brightness, adjusting **48**

C

Cable
 setting ON/OFF **52**
 with VCR, connecting **19**
Cable box
 connecting with VCR **20**
 using with TV remote control **69**
Camcorder, connecting **29**
Caption Vision **63**
CATV. See cable.
Channel Index
 described **9**
 using **45**
Channel list, adding channels **53**
Channel menu **47, 52**
Channel Skip/Add **53**
Channels
 Auto Program **53**
 creating labels **53**
 setting up **32**

CineMotion, DRC **35, 49**
Closed caption modes **63**
CODE SET button **36**
Color temperature, adjusting **48**
Color, adjusting **48**
Connecting
 Audio receiver **25**
 AV receiver **30**
 Cable box **17, 18, 20**
 Cable or antenna **16**
 Camcorder **29**
 Digital TV Receiver **28**
 DVD player **26, 27**
 Satellite receiver **23, 24**
 VCR **20–22, 24**
Connector Types **12**
Contents of box **10**
CONTROL S **31**
Convergence, adjusting automatically **33**

D

Daylight saving **62**
Digital Reality Creation **49**
Digital TV
 connecting **28**
 watching **39**
Digital TV program **39**
Digital TV receiver, connecting **28**
DISPLAY button **34**
Display, turning off **34**
DRC (Digital Reality Creation) Mode, described **8**
DRC/CINEMOTION button **35**
DVD MENU button **36**
DVD player
 using with TV remote control **68**
 with A/V connectors, connecting **27**
 with component video connectors, connecting **26**
DVD TITLE button **36**

E

Effect
 OFF **50**
 Simulated **50**
 TruSurround **50**

(Continued)

Enhanced picture resolution, 16:9 **64**
Enlarging pictures, in Twin View **43**
Extended Data Service **63**

F

Favorite Channel
 auto **52**
 described **9**
 manual **52**
 setting up **52**
 using **40**

FAVORITES button **34**

Features **8**

Flash Focus
 described **9**
 performing **33**

FREEZE button **34**

Freeze, using **37, 44**

Front Panel Controls **13**

FUNCTION buttons (WHITE) **35**

H

Hookups **16**
Hue, adjusting **48**

I

Inputs, labeling **64**
Installation of the projection TV **16–31**

J

JUMP button **34**
Jump, using **37**

L

Label
 channels **53**
 video inputs **64**
Locking programs **54**

M

MENU button **35**
Menus
 Audio **47, 50**
 Channel **47, 52**
 Parent **47, 54**
 Setup **47, 63**
 Timer **47, 62**
 Video **47, 48**

MODE

Movie **38**
Pro **38**
Standard **38**
Vivid **38**

MTS/SAP button **36**

MTS/SAP, using **38**

Muting, using **37**

P

Parent menu **47, 54**
Parental control, described **8**
Password, changing **56**
PIC MODE button **34**
Picture contrast, adjusting **48**
Picture size, adjusting in Twin View **43**
POWER button **36**
POWER buttons (GREEN) **35**
Presetting channels **32**
Problems, troubleshooting **70**

R

Ratings
 setting **54–59**
 viewing blocked programs **56**
Rear panel controls and connections **14, 15**
Remote control
 buttons inside panel **36**
 Function of buttons **37**
 inserting batteries **10**
 programming **65–67**
Remote control, operating other components with
 Cable box **69**
 DVD player **68**
 Satellite receiver **69**
 VCR **68**
Removing channels from the channel list **53**
RESET button **34**
Resetting
 Audio options **50**
 Timer options **62**
 Video options **48**

S

S Video cable **12**
SAT/CABLE function button **35**
SAT/CABLE power button **35**
Satellite receiver
 connecting **23**
 using with TV remote control **69**

Setting up channels **32**
Setup menu **47, 63**
Sharpness, adjusting **48**
SLEEP button **34**
Sleep, using **38**
Specifications **73–74**
Steady Sound
 adjusting **50**
 described **8**
Surround sound **50**
SYSTEM OFF button **36**

T

Tape-to-tape editing **22**
Time
 set current **62**
 set daylight saving **62**
Timer menu **47, 62**
Timer setting **62**
Treble, adjusting **50**
Troubleshooting **70**
TV function button **35**
TV power button **35**
TV/VIDEO button **35**
Twin View™
 activating a picture **41**
 described **8**
 using **41**

V

VCR
 connecting two, for tape editing **22**
 using with TV remote control **68**
 with cable box, connecting **20**
 with cable, connecting **19**
 with satellite receiver, connecting **24**
Video inputs, labeling **64**
Video menu **47, 48**
Video Modes, selecting **48**
Viewing area, recommended **11**
VOL +/- button **34, 37**

W

Widescreen **64**
Widescreen, described **8**

Z

Zoom feature, with Twin View **43**

If, after reading this instruction manual, you have additional questions related to the use of your Sony projection TV, please call one of the following numbers (English only).

Customers in the continental United States contact the Direct Response

Center at:

1-800-222-SONY (7669)

Customers in Canada contact the Customer Relations Center at:

(416) 499-SONY (7669)

<http://www.world.sony.com/>

Printed in U.S.A.

Download from [Www.Somanuals.com](http://www.Somanuals.com). All Manuals Search And Download.

ENGLISH**CAUTION****How to reduce the risk of "Image Retention" on your Projection TV**

Bright, stationary images such as TV station logos displayed on your TV can cause permanent damage to your TV, resulting in retention of the image in the picture.

Please take the following steps to reduce the risk of causing image retention:

View a variety of program sources or programming material.

Image retention can occur when bright stationary images such as TV station logos are viewed. Changing the program material viewed reduces the possibility that a single image will become imprinted on the picture tubes in your TV.

When viewing programs with stationary images, adjust the picture setting to reduce the "Picture" and "Brightness" levels. Image retention is accelerated by higher "Brightness" and higher "Picture" settings.

Please refer to your instruction manual for instructions on adjusting picture settings.

This will help you reduce the risk of causing image retention.

IMAGE RETENTION IS NOT COVERED BY YOUR WARRANTY**FRANÇAIS****AVERTISSEMENT****Comment réduire le risque de "rémanence" sur votre téléviseur de projection ?**

Des images lumineuses fixes, comme les logos des chaînes de télévision, affichées sur votre téléviseur, peuvent causer une détérioration permanente de celui-ci, entraînant une rémanence à l'écran.

Veillez prendre les mesures suivantes afin de réduire le risque de rémanence :

Visualisez différentes sources de programmes ou supports de programmation.

Une rémanence peut se produire lorsque des images fixes lumineuses telles que des logos de chaînes de télévision sont visualisées. Lorsque vous changez le support de programme visualisé, vous réduisez le risque qu'une image isolée s'imprime sur les tubes image de votre téléviseur.

Lorsque vous visualisez des programmes comportant des images fixes, réglez le paramétrage de l'écran de manière à réduire les niveaux "Image" et "Luminosité". La rémanence est accélérée avec des paramètres "Luminosité" et "Image" élevés.

Veillez vous référer à votre mode d'emploi concernant le réglage des paramètres de l'écran.

Ceci vous aidera à réduire le risque de rémanence.

LA RÉMANENCE N'EST PAS COUVERTE PAR NOTRE GARANTIE.**ESPAÑOL****PRECAUCIÓN****Cómo reducir el riesgo de "Retención de imagen" en el TV de proyección**

Las imágenes brillantes e inmóviles, como los logotipos de las emisoras de TV, mostradas en el TV pueden causar daños permanentes en éste, provocando la retención de la imagen en la pantalla.

Realice los siguientes pasos para reducir el riesgo de retención de imagen:

Visualice diversas fuentes de programa o material de programación.

Puede producirse retención de imagen al visualizar imágenes brillantes e inmóviles, como los logotipos de emisoras de TV. El cambio del material de programa visualizado reduce la posibilidad de que una sola imagen quede impresa en los tubos de imagen del TV.

Al visualizar programas con imágenes inmóviles, ajuste los valores de la imagen para reducir los niveles de "Picture" y "Brightness". La retención de imagen se acelera con ajustes de "Brightness" y "Picture" altos.

Consulte el manual de instrucciones para obtener información sobre el ajuste de los valores de la imagen.

Esto ayudará a reducir el riesgo de producirse retención de imagen.

LA GARANTÍA NO CUBRE PROBLEMAS CAUSADOS POR RETENCIÓN DE IMAGEN

SONY®

HDTV Color TV XBR Projection TV
--

LIMITED WARRANTY

Sony Electronics Inc. ("Sony") warrants this Product (including any accessories) against defects in material or workmanship as follows:

- LABOR:** For a period of one (1) year from the date of purchase, if this Product is determined to be defective, Sony will repair or replace the Product, at its option, at no charge, or pay the labor charges to any Sony authorized service facility. After the Warranty Period, you must pay for all labor charges.
- PARTS:** In addition, Sony will supply, at no charge, new or rebuilt replacements in exchange for defective parts for a period of one (1) year (color picture tube - two (2) years). After the warranty period, you must pay for all parts costs.
- ACCESSORIES:** Parts and labor for all accessories are for one (1) year.

In-home diagnostic warranty service is provided during the initial one (1) year period for 19" (measured diagonally), or larger screen size through a Sony authorized service facility.

To obtain warranty service, you must take the Product, or deliver the Product freight prepaid, in either its original packaging or packaging affording an equal degree of protection, to any authorized Sony service facility.

This warranty does not cover customer instruction, installation, set up adjustments or signal reception problems.

This warranty does not cover cosmetic damage or damage due to acts of God, accident, misuse, abuse, negligence, commercial use, or modification of, or to any part of the Product, including the antenna. This warranty does not cover damage due to improper operation or maintenance, connection to improper voltage supply, or attempted repair by anyone other than a facility authorized by Sony to service the Product. This warranty does not cover Products sold AS IS or WITH ALL FAULTS, or consumables (such as fuses or batteries). This warranty is valid only in the United States.

Proof of purchase in the form of a bill of sale or receipted invoice which is evidence that the unit is within the Warranty period must be presented to obtain warranty service.

This warranty is invalid if the factory applied serial number has been altered or removed from the Product.

REPAIR OR REPLACEMENT AS PROVIDED UNDER THIS WARRANTY IS THE EXCLUSIVE REMEDY OF THE CONSUMER. SONY SHALL NOT BE LIABLE FOR ANY INCIDENTAL OR CONSEQUENTIAL DAMAGES FOR BREACH OF ANY EXPRESS OR IMPLIED WARRANTY ON THIS PRODUCT. EXCEPT TO THE EXTENT PROHIBITED BY APPLICABLE LAW, ANY IMPLIED WARRANTY OF MERCHANTABILITY OR FITNESS FOR A PARTICULAR PURPOSE ON THIS PRODUCT IS LIMITED IN DURATION TO THE DURATION OF THIS WARRANTY.

Some states do not allow the exclusion or limitation of incidental or consequential damages, or allow limitations on how long an implied warranty lasts, so the above limitations or exclusions may not apply to you. In addition, if you enter into a service contract with the Sony Partnership within 90 days of the date of sale, the limitation on how long an implied warranty lasts does not apply to you. This warranty gives you specific legal rights, and you may have other rights which vary from state to state.

For your convenience, Sony Electronics Inc. has established telephone numbers for frequently asked questions:

To locate the servicer or dealer nearest you, or for service assistance or resolution of a service problem, or for product information or operation, call:

Sony Direct Response Center

1-(800)-222-7669

or write to:

Sony Direct Response Center

12451 Gateway Blvd.

Fort Myers, FL 33913

For an accessory or part not available from your authorized dealer, call:

1-(800)-488-SONY (7669)

OWNER REGISTRATION DEPT

Please not not send products or correspondence to this address



**NO POSTAGE
NECESSARY
IF MAILED
IN THE
UNITED STATES**



BUSINESS REPLY MAIL
FIRST CLASS MAIL PERMIT NO. 138 PARK RIDGE NJ

POSTAGE WILL BE PAID BY ADDRESSEE

**SONY ELECTRONICS INC
TV / MARKET RESEARCH
1 SONY DRIVE
PARK RIDGE NJ 07656-9440**





SONY®



Product Registration Card

DEAR CUSTOMER,

THANK YOU FOR HAVING PURCHASED A SONY PRODUCT. AS A CUSTOMER YOUR OPINION AND COMMENTS ON OUR PRODUCTS ARE HIGHLY APPRECIATED. WE WOULD LIKE TO ASK YOUR HELP BY COMPLETING THE QUESTIONNAIRE INSIDE. ALL ANSWERS ARE CONFIDENTIAL AND WILL BE USED IN STATISTICAL COMBINATION WITH OTHERS TO IDENTIFY DECIDED FEATURES AND BUYING PURPOSES.

PLEASE FILL OUT EACH ITEM BY CHECKING YOUR ANSWER AND DROP THE COMPLETED QUESTIONS IN THE MAIL. YOUR COOPERATION WILL BE APPRECIATED.

Free Manuals Download Website

<http://myh66.com>

<http://usermanuals.us>

<http://www.somanuals.com>

<http://www.4manuals.cc>

<http://www.manual-lib.com>

<http://www.404manual.com>

<http://www.luxmanual.com>

<http://aubethermostatmanual.com>

Golf course search by state

<http://golfingnear.com>

Email search by domain

<http://emailbydomain.com>

Auto manuals search

<http://auto.somanuals.com>

TV manuals search

<http://tv.somanuals.com>