

## ***Stereo Transmitter***

---

Operating Instructions \_\_\_\_\_ **US**

Mode d'emploi \_\_\_\_\_ **FR**

Manual de instrucciones \_\_\_\_\_ **ES**



### ***TMR-BT8iP***

# WARNING

**To reduce the risk of fire or electric shock, do not expose this apparatus to rain or moisture.**

iPod is trademark of Apple Computer, Inc., registered in the U.S. and other countries

The Bluetooth word mark and logos are owned by the Bluetooth SIG, Inc. and any use of such marks by Sony Corporation is under license.

Other trademarks and trade names are those of their respective owners.

## INFORMATION:

This device complies with Part 15 of FCC Rules and RSS-Gen of IC Rules. Operation is subject to the following two conditions: (1) this device may not cause interference, and (2) this device must accept any interference, including interference that may cause undesired operation of this device.

You are cautioned that any changes or modifications not expressly approved in this manual could void your authority to operate this equipment.

This equipment must not be co-located or operated in conjunction with any other antenna or transmitter.

This equipment complies with FCC/IC radiation exposure limits set forth for uncontrolled equipment and meets the FCC radio frequency (RF) Exposure Guidelines in Supplement C to OET65 and RSS-102 of the IC radio frequency (RF) Exposure rules. This equipment has very low levels of RF energy that it is deemed to comply without testing of specific absorption ratio (SAR).

## Compatible iPod models

The compatible iPod models are as follows. Update your iPod to use the latest software before you use it.

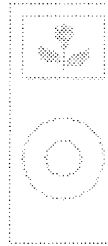

iPod nano 2nd generation (aluminium)

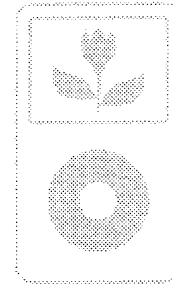

iPod 5th generation (video)

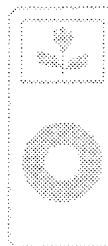

iPod nano 1st generation

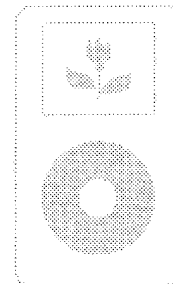

iPod 4th generation (color display)

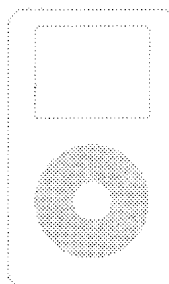

iPod 4th generation

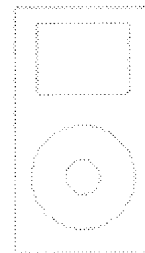

iPod mini 1st generation

## Notes

- This unit is designed for iPod only. You cannot connect any other portable audio players.
- Sony cannot accept responsibility in the event that data recorded to iPod is lost or damaged when using an iPod connected to this unit.

---

# Table of Contents

What is Bluetooth wireless technology? .....	4
Features .....	5
Basic operation of Bluetooth devices.....	6

## Getting Started

Location and Function of Parts .....	7
Connecting to an iPod.....	8
Pairing .....	10
What is pairing?.....	10
Pairing procedures.....	10
On Indicators .....	13

**US**

## Listening to music

Bluetooth Connecting / Playing back.....	14
Controlling by the Remote...	16

## Additional Information

Precautions .....	17
Troubleshooting.....	19
Initializing this unit.....	21
Specifications.....	22

---

# What is Bluetooth wireless technology?

Bluetooth™ wireless technology is a short-range wireless technology that enables wireless data communication between digital devices, such as a computer or digital camera. Bluetooth wireless technology operates within a range of about 10 meters (about 30 feet).

Connecting two devices as necessary is common, but some devices can be connected to multiple devices at the same time.

You do not need to use a cable for connection nor is it necessary for the devices to face one another, such is the case with infrared technology. For example, you can use such a device in a bag or pocket.

Bluetooth standard is an international standard supported by thousands of companies all over the world, and employed by various companies worldwide.

## Communication System and Compatible Bluetooth Profile of this unit

Profile is standardization of the function for each Bluetooth device specification. This unit supports the following Bluetooth version and profiles:

Communication System: Bluetooth Specification version 2.0 + EDR\*

Compatible Bluetooth Profile:

- A2DP (Advanced Audio Distribution Profile)
- AVRCP (Audio/Video Remote Control Profile)

\* Enhanced Data Rate

### Notes

- To be able to use the Bluetooth function, the Bluetooth device to be connected requires the same profile as the unit's.  
Note also that even if the same profile exists, devices may vary in function depending on their specifications.
- Due to the characteristic of Bluetooth wireless technology the sound transmitted from this unit is slightly delayed during listening to the music.

# Features

This unit is an audio transmitter using Bluetooth wireless technology.

You can enjoy music wirelessly by transmitting the audio signals to a Bluetooth receiving device (headset, car stereo, speaker, stereo component system, etc.), if you connect this unit to the iPod (see page 2 on compatible iPod models) with the iPod connector (30 pin).

This unit's features are as follows:

- Wireless transmitter for streaming of high-quality stereo music from iPod.
- Transmits music to other devices using Bluetooth wireless technology.\*<sup>1</sup>
- Basic remote control operation (play, pause, etc.) of iPod functions via Bluetooth connection.\*<sup>2</sup>
- Transmitter power supplied from iPod so no additional battery or charging is needed.
- Bluetooth Version 2.0 + EDR (Enhanced Data Rate) for higher quality audio with less interference.

\*<sup>1</sup> The connected Bluetooth device is required to support A2DP (Advanced Audio Distribution Profile).

\*<sup>2</sup> The connected Bluetooth device is required to support AVRCP (Audio/Video Remote Control Profile).

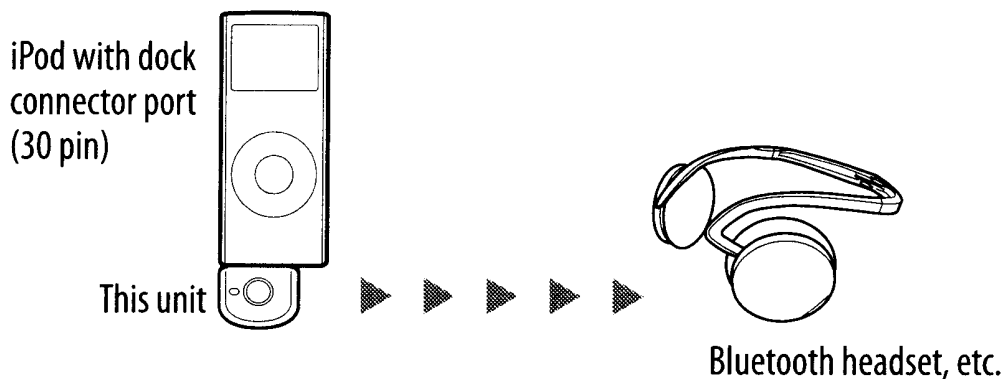

## Tip

For details on Bluetooth wireless technology, see page 4.

## Basic operation of Bluetooth devices

The following example describes how you can transmit music played on an iPod connected to this unit, and listen on a Bluetooth receiving device (headset).

### Pairing

Enables a Bluetooth receiving device and this unit to recognize one another. You do not need to recognize one another next time if you did once.

iPod with dock connector port (30 pin)

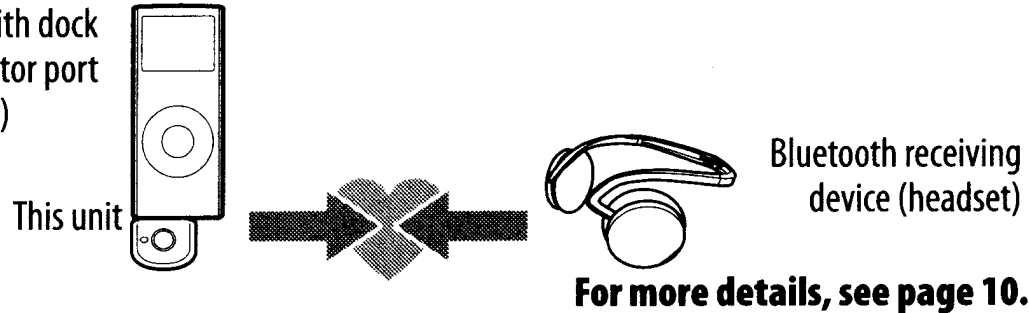

### Bluetooth connecting

Turn on the Bluetooth receiving device and play the iPod. Bluetooth connection is established automatically.

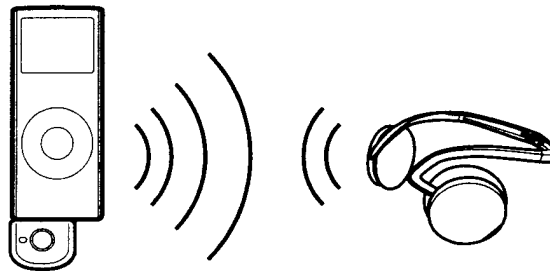

### Listening to music

You can enjoy listening to music played on your iPod connected to this unit through the Bluetooth receiving device.

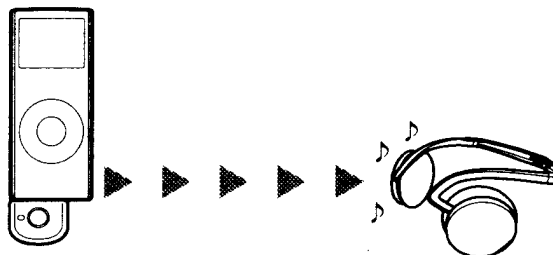

# Location and Function of Parts

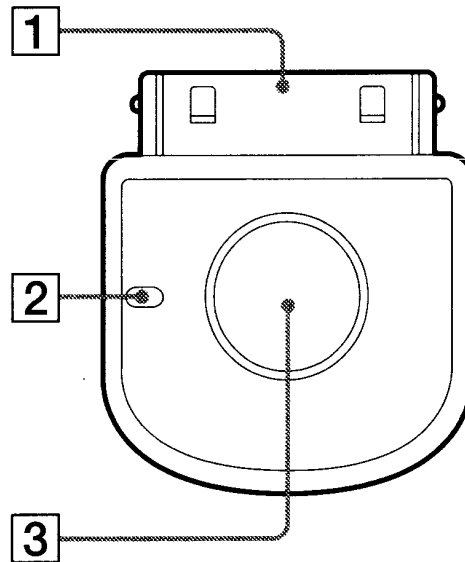

**1 iPod connector  
(30 pin)**

Connects to the dock connector of an iPod (page 8).

**2 Indicator**

Indicates this unit's status (page 13).

**3 Power button**

Performs the following:

- Turning on/off of this unit (page 8).
- Pairing (page 10).
- Initializing this unit (page 21).

---

# Connecting to an iPod

Connect this unit to the dock connector port of an iPod firmly.

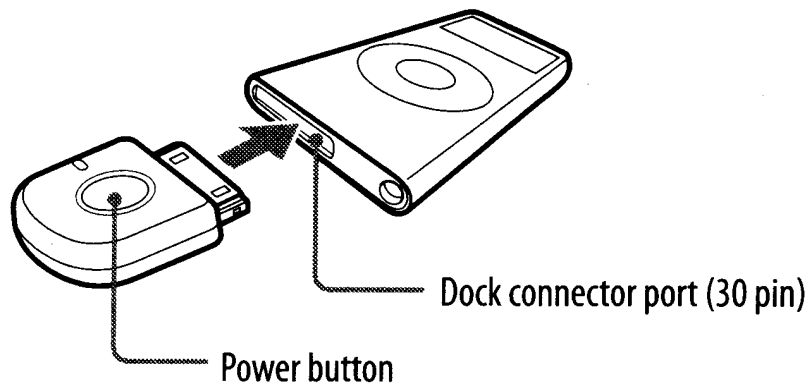

## To turn on this unit

- 1 Connect this unit to the iPod.**
- 2 Press the power button of this unit for about 1 second to turn it on, or start to play back on iPod.**

When this unit turns on, the indicator flashes twice.

## Note

If the unit cannot turn on, operate the iPod.

## To turn off this unit

To turn off this unit, press and hold this unit's power button for about 1 second. The indicator flashes once and this unit turns off.

## 💡 Tip

Maximum communication time or standby time may vary depending on your iPod.



## Notes

- To listen to music from the headphone jack of the iPod, disconnect this unit from the iPod.
- While this unit is turned on, it consumes power from the iPod. We recommend disconnect this unit from iPod when not using the Bluetooth function.
- If the headphone is connected to the iPod while the iPod is playing back, it consumes power from iPod.
- If you turn off this unit while the iPod is playing back, iPod will power off.
- It is not recommended to turn off iPod as the linkage will lost between this unit and the Bluetooth receiving device.
- There is no need to charge this unit as it will receive power from the connected iPod. It is recommended to check the iPod's remaining battery before using.

# Pairing

## What is pairing?

Bluetooth devices need to be “paired” with each other beforehand. Once Bluetooth devices are paired, there is no need for pairing again, except in the following cases:

- Pairing information is deleted after repair, etc.
- This unit is paired with 9 or more receiving devices.  
This unit can be paired with up to 8 Bluetooth receiving device. If a new device is paired after 8 devices have been paired, the device whose latest connection time is the oldest among the 8 paired devices is replaced by the new one.
- This unit is initialized.  
All pairing information is deleted (page 21).

## Pairing procedures

- 1 Turn on the power of iPod.**  
(Make sure the iPod is in pause mode)
- 2 Connect this unit to the iPod (page 8).**
- 3 Place this unit and the Bluetooth receiving device to be paired together within 1 m (3 ft).**
- 4 Set the Bluetooth receiving device to enter “Pairing in process.”**  
See the operating instructions supplied with the Bluetooth receiving device.

### Tip

For Sony Wireless Stereo Headset

Press and hold the POWER button of the bluetooth receiving device for 7 seconds or more to standby for pairing while the unit is turned off.

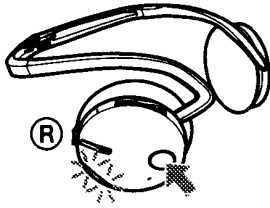

### Notes

- Passcode\* of this unit is fixed at “0000”, “1234” or “8888.” Depending on the Bluetooth receiving device, it may be necessary to input the passcode (in this case, “0000”, “1234” or “8888”). This unit cannot be paired with a Bluetooth receiving device whose passcode is not “0000”, “1234” or “8888.”
- If the Bluetooth receiving device requires a passcode, input “0000.”

\* Passcode may be called “Passkey,” “PIN code,” “PIN number,” or “Password.”

## 5 Press and hold the power button of this unit for 7 seconds or more to enter “Pairing in process.”

After about 1 second, the indicator will flash twice but keep pressing the power button.

### Notes

- When first power on this unit after initialize, this unit will enter the “Pairing in process” automatically.
- The pairing information is initialized if you press and hold the power button for 15 seconds. The indicator lights up for 5 seconds before the initialization starts. Release the button immediately when the indicator lights up.

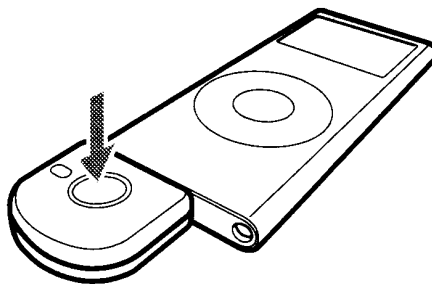

When the indicator of this unit flashes quickly, stop pressing it. This unit enters “Pairing in process.”

This unit’s indicator status will vary as follows, and pairing is established with the Bluetooth receiving device.

Continued 

Indicator flashes quickly: Pairing in process



Indicator flashes (at about 1-second interval) when responding to the Bluetooth receiving device: Connectable  
(Pairing successful)



Indicator flashes (at about 5-second intervals): Connected

### Notes

- “Pairing in process” of this unit is released after about 5 minutes. If pairing is not established within about 5 minutes, repeat the above procedure from step 4. iPod backlight may turn on in this 5 minutes.
- To enter “Pairing in process,” you need to turn off the power of this unit and turn on the power of iPod first.

### When not completed pairing

Repeat the procedure from step 2.

### To quit “Pairing in process”

Press and hold the power button of this unit for about 1 second to turn off this unit.





### Tip

When pairing this unit with a number of Bluetooth receiving devices, repeat steps 3 to 5 for each device individually.

### Note

For using the Bluetooth function, it is required that the Bluetooth device on the other side is corresponding with the same profile as this unit. However, even if it is corresponding with the same profile, functions may differ depending on the specification of the Bluetooth device.

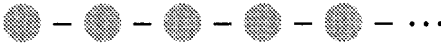
# On Indicators

Status	Indicator
Power on	Flashes twice 
Power off	Flashes once 
Pairing	Flashes quickly 
Connecting	Flashes (at about 1-second intervals) 
Connected	Listening <sup>*1</sup> (flashes twice at about 5-second intervals) 
	With no music <sup>*2</sup> (flashes once at about 5-second intervals) 

<sup>\*1</sup> When press  on the iPod, the music pause. The indicator flashes twice on this unit. This unit transmit the data of no sound.

<sup>\*2</sup> When press the pause button on the Bluetooth receiving device, the music pause. The indicator flashes once on this unit. This unit does not transmit the music.

# Bluetooth Connecting / Playing back

You can listen to music of the iPod connected to this unit on the Bluetooth receiving device (headset, etc.).

**Before starting operation, complete pairing this unit and the Bluetooth receiving device (page 10).**

- 1 The Bluetooth receiving device is on standby for connection.**
- 2 Connect this unit to the iPod then turn on the iPod and start playback on the iPod.**

This unit's indicator status will vary as follows, and the Bluetooth connection between this unit and the Bluetooth receiving device is established.

Indicator flashes twice: Power is on



Indicator flashes (at about 1-second intervals): Connecting in process



Indicator flashes twice slowly (at about 5-second intervals):  
Connected  
(Playback will start automatically)

If the Bluetooth connection is not established within 5 minutes\*, this unit automatically turns itself off. In this case, turn it on again by pressing and holding the power button for about 1 second.

\* iPod backlight may turn on in this 5 minutes.

## Notes

- If the Bluetooth connection cannot be established with the device paired already, try pairing again.
- If playback cannot start automatically, try start playback on iPod.
- If you press and hold the power button on this unit for about 1 second, this unit will connect to the iPod and start playback automatically.

## Tip

You can control the volume on the Bluetooth receiving device.  
(The volume of the iPod is not changed.)

## Notes

- Even if you control the volume on the iPod, sound from the Bluetooth receiving device will not change.
- If this unit and the Bluetooth receiving device become out of range and the Bluetooth connection terminates, repeat the procedure from step **1**.
- Playback through a Bluetooth connection may cause noise, sound break, or playback speed change depending on the location and the usage (page 17).

# Controlling by the Remote

## When connecting (Bluetooth connecting) to devices that support AVRCP (Audio/Video Remote Control Profile)

You can control the iPod using the control button of the Bluetooth receiving device. For details, see the operating instructions supplied with the Bluetooth devices.

**Before starting remote control operation, check that step 1 and 2 of "Bluetooth Connecting / Playing back" are completed (page 14).**

**Remote control for the iPod by the Bluetooth receiving device.**

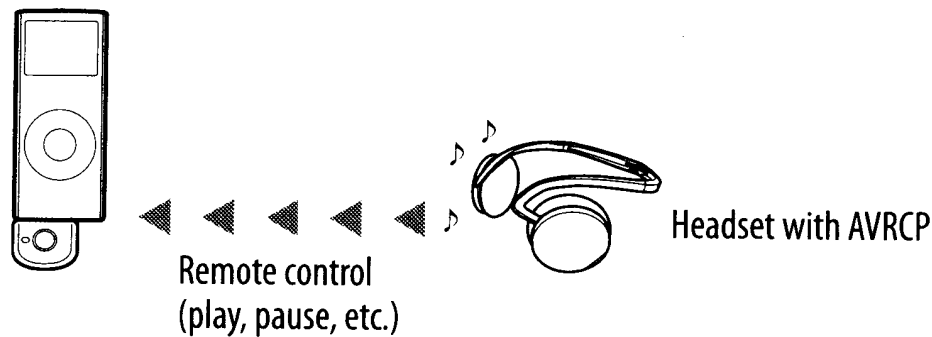

## Notes

- Even if you control the volume on the iPod, the volume of the Bluetooth receiving device, such as a headset, does not change.
- When operating the iPod by remote control, do not cover this unit with hands.
- You may need to press the play/pause button twice depending on the Bluetooth receiving device.
- You may need to press the play/pause button of the Bluetooth receiving device twice when you operate the button on the iPod.
- Operation of the iPod with this unit by the Bluetooth receiving device will vary depending on the Bluetooth receiving device's specification.

## 💡 Tip

When you press the pause button on the Bluetooth receiving device, the iPod goes to pause mode for 10 minutes and the iPod backlight is turns on and off at interval.

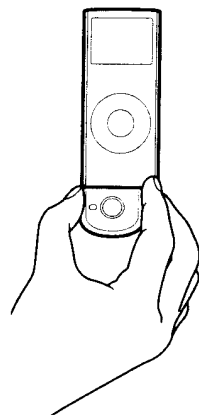

Do not cover this unit with hands.



# Precautions

## On Bluetooth communication

- Bluetooth wireless technology operates within a range of about 10 meters (about 30 feet). Maximum communication range may vary depending on obstacles (human body, metal, wall, etc.) or electromagnetic environment.

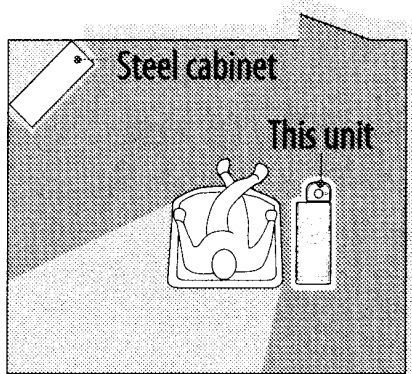

- Optimal performance
- Limited performance

- The aerial of this unit is shown as illustrated in the dotted line. The sensitivity of Bluetooth communication will improve by turning the direction of the built-in aerial to the connected Bluetooth device. The communication distance shortens when the obstacles are between the aerial of the connected device and this unit.

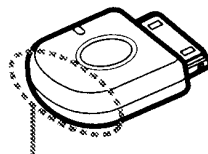

Location of built-in aerial

- The following conditions may cause noise, sound break or playback speed change.
  - When using inside the metal bag.
  - When using inside the backpack or shoulder bag.
  - A device using 2.4 GHz frequency, such as a wireless LAN device, cordless telephone, or microwave oven, is in use near this unit.
- Because Bluetooth devices and wireless LAN (IEEE802.11b/g) use the same frequency, microwave interference may occur and resulting in communication speed deterioration, noise, or invalid connection if this unit is used near a wireless LAN device. In such a case, perform the following.
  - Install this unit and Bluetooth device as near to each other as possible.
  - If this unit is used within about 10 meters (about 30 feet) of a wireless LAN device, turn off the wireless LAN device.
- Microwaves emitting from a Bluetooth device may affect the operation of electronic medical devices. Turn off this unit and other Bluetooth devices in the following locations, as it may cause an accident.
  - where inflammable gas is present, in a hospital, train, airplane, or a petrol station.
  - near automatic doors or a fire alarm.

Continued 

- This unit supports security capabilities that comply with the Bluetooth standard to provide a secure connection when the Bluetooth wireless technology is used, but security may not be enough depending on the setting. Be careful when communicating using Bluetooth wireless technology.
- We do not take any responsibility for leakage of information during Bluetooth communication.
- Connection with all Bluetooth devices cannot be guaranteed.
  - A device featuring Bluetooth function is required to conform to the Bluetooth standard specified by Bluetooth SIG, Inc. and be authenticated.
  - Even if the connected device conforms to the above mentioned Bluetooth standard, some devices may not be connected or work correctly, depending on the features or specifications of the device.
- Depending on the device to be connected, communication may take some time.

## On safety

- Do not drop, hit, or otherwise expose the unit to strong shock of any kind. This could damage the product.
- Do not disassemble or attempt to open any parts of the unit.

## On placement

- Do not place the unit in any of the following locations.
  - Direct sunlight, near a heater, or other extremely high-temperature location
  - Dusty location
  - An unsteady or inclined surface
  - Location exposed to large amounts of vibration
  - Bathroom or other high-humidity location
  - In a car subject to the direct rays of the sun

## Notes on using in a car

Do not attempt to connect this unit, or to operate this unit, an audio output device or a car radio while driving or waiting at a traffic signal.

## Cleaning

Clean the unit with a soft, dry cloth, or a soft cloth lightly moistened with a mild detergent solution. Do not use any type of solvent, such as alcohol or benzene, which may damage the finish.

## Others

If you have any questions or problems concerning this unit that are not covered in this manual, please consult your nearest Sony dealer.

# Troubleshooting

If you run into any problems using this unit, use the following checklist and read the product support information on our website. Should any problem persist, consult your nearest Sony dealer.

Symptom	Cause / Remedy
This unit is not turned on. (or turns off shortly after turning on.)	<ul style="list-style-type: none"><li>→ Press and hold this unit power button for about 1 second.</li><li>→ Check the remaining battery of the iPod. If the remaining battery is not enough, charge the iPod.</li><li>→ Reset your iPod.</li><li>→ If your iPod have no content, add some content to your iPod.</li></ul>
No sound	<ul style="list-style-type: none"><li>→ Check the connection between this unit and the iPod.</li><li>→ Check that both this unit and the Bluetooth receiving device are turned on.</li><li>→ Ensure that this unit is not too far from the Bluetooth receiving device, or this unit is not receiving interference from a wireless LAN, other 2.4 GHz wireless device, or microwave oven.</li><li>→ Pair this unit and the Bluetooth receiving device again.</li></ul>
Low sound level	<ul style="list-style-type: none"><li>→ Turn up the volume of the Bluetooth receiving device as high as possible to the extent that sound is not distorted. For details on volume adjustment, refer to the operating instructions supplied with the Bluetooth receiving device.</li></ul>
Cannot change the volume.	<ul style="list-style-type: none"><li>→ Change the volume on the Bluetooth receiving device.</li></ul>

Continued 

<b>Symptom</b>	<b>Cause / Remedy</b>
Distorted sound	<ul style="list-style-type: none"> <li>→ Turn down the volume of the Bluetooth receiving device to the point where the sound is no longer distorted. For details on volume adjustment, refer to the operating instructions supplied with the Bluetooth receiving device.</li> <li>→ Turn off the EQ of iPod.</li> <li>→ Ensure that this unit is not receiving interference from a wireless LAN, other 2.4 GHz wireless device, or microwave oven.</li> </ul>
Sound break, noise or playback speed change	<ul style="list-style-type: none"> <li>→ If a device that generates electromagnetic radiation, such as a wireless LAN, other Bluetooth device(s), or a microwave oven is nearby, move away from such sources.</li> <li>→ Remove any obstacle between this unit and other Bluetooth device or move away from the obstacle.</li> <li>→ Locate this unit and other Bluetooth device(s) as near as possible.</li> <li>→ Re-position or re-orient this unit.</li> <li>→ Re-position or re-orient other Bluetooth device.</li> </ul>
Pairing cannot be established.	<ul style="list-style-type: none"> <li>→ Locate this unit and other Bluetooth device(s) as near as possible.</li> <li>→ Check if you input correct passcode (page 11).</li> </ul>
Bluetooth connection cannot be established with a device that has been “paired” before.	<ul style="list-style-type: none"> <li>→ Locate this unit and other Bluetooth device(s) as near as possible.</li> <li>→ This unit tries to connect with either of the last two devices recognized before. If this unit cannot establish the Bluetooth connection with a paired device, operate the connecting procedures on the Bluetooth receiving device or pair the device again.</li> <li>→ Pairing information may be deleted. Pair the device again.</li> </ul>

---

# Initializing this unit

You can reset this unit to its default and delete all pairing information.

**1 Connect the unit to the iPod.**

**2 Press and hold the power button for more than about 15 seconds.**

During these 15 seconds, the indicator changes in sequence as follows:

- flash (at about 1 second intervals) for about 5 seconds
- flash quickly for about 5 seconds
- lights up for about 5 seconds
- flash 4 times

Then, the unit is reset to default setting and all pairing information is deleted.

## **Note**

Do not operate your iPod while initializing this unit.

# Specifications

## General

### Communication System

Bluetooth Specification Version 2.0 + EDR\*<sup>1</sup>

### Output

Bluetooth Specification Power Class 2

### Maximum communication range

Line of sight approx. 10 m (30 ft)\*<sup>2</sup>

### Frequency band

2.4 GHz band (2.4000 GHz – 2.4835 GHz)

### Modulation method

FHSS

### Transmission range (A2DP)

20 - 20,000 Hz (Sampling frequency 44.1 kHz)

### Compatible Bluetooth Profiles\*<sup>3</sup>

A2DP (Advanced Audio Distribution Profile)

AVRCP (Audio/Video Remote Control Profile)

### Supported Codec\*<sup>4</sup>

SBC\*<sup>5</sup>

### Terminal

iPod connector (30 pin)

### Operating temperature

0 °C to 35 °C (32 °F to 95 °F)

### Dimensions

Approx. 31 × 28 × 8 mm  
(1<sup>1</sup>/<sub>4</sub> × 1<sup>1</sup>/<sub>8</sub> × 1<sup>1</sup>/<sub>32</sub> in.) (w/h/d)  
(including protruding parts)

### Mass

Approx. 5 g (0.2 oz)

\*<sup>1</sup> Enhanced Data Rate

\*<sup>2</sup> The actual range will vary depending on factors such as obstacles between devices, magnetic fields around a microwave oven, static electricity, reception sensitivity, aerial's performance, operating system, software application, etc.

\*<sup>3</sup> Bluetooth standard profiles indicate the purpose of Bluetooth communication between devices.

\*<sup>4</sup> Codec: Audio signal compression and conversion format

\*<sup>5</sup> Subband Codec

## Supplied accessories

Operating instructions (this book) (1)

Design and specifications are subject to change without notice.

<http://www.sony.net/>

Printed in Malaysia



\* 3 2 7 9 3 6 0 3 1 \* (1)



## TMR-BT8iP

### English

#### Features

- Wireless transmitter for streaming of high-quality stereo music from iPod.
- Transmits music to other devices using Bluetooth wireless technology.\*1
- Basic remote control operation (play, pause, etc.) of iPod functions via Bluetooth connection.\*2
- Transmitter power supplied from iPod so no additional battery or charging is needed.

\*1 The connected Bluetooth device is required to support A2DP (Advanced Audio Distribution Profile).

\*2 The connected Bluetooth device is required to support AVRCP (Audio Video Remote Control Profile).

#### Specifications

Communication System: Bluetooth Specification version 2.0 + EDR  
 Output: Bluetooth Specification Power Class 2  
 Maximum communication range:  
 Line of sight approx. 10 m (30 ft)  
 Frequency band: 2.4 GHz band (2.4000 GHz– 2.4835 GHz)  
 Modulation method: FHSS  
 Compatible Bluetooth Profile: A2DP, AVRCP  
 Supported Codec: SBC  
 Supported Passcode: 0000, 1234, 8888  
 Terminal: iPod connector

Design and specifications are subject to change without notice.

### Español

#### Características

- Transmisor inalámbrico de flujo de música estéreo de alta calidad desde un iPod.
- Transmite música a otros dispositivos mediante la tecnología inalámbrica Bluetooth.\*1
- Operación de las funciones básicas del iPod por control remoto (reproducción, detención, etc.) a través de la conexión Bluetooth.\*2
- El transmisor se alimenta desde el iPod, por lo que no es necesario disponer de baterías adicionales ni cargar el dispositivo.

\*1 El dispositivo Bluetooth conectado es necesario para admitir el perfil A2DP (Advanced Audio Distribution Profile).

\*2 El dispositivo Bluetooth conectado es necesario para admitir el perfil AVRCP (Audio Video Remote Control Profile).

#### Especificaciones

Sistema de comunicación: Especificación Bluetooth versión 2.0 + EDR  
 Salida: Clase de potencia 2 de especificación Bluetooth  
 Rango de comunicación máximo: Línea de vista de aprox. 10 m  
 Banda de frecuencia: Banda de 2,4 GHz (2.4000 GHz– 2,4835 GHz)  
 Método de modulación: FHSS  
 Perfiles Bluetooth compatibles: A2DP, AVRCP  
 Códec admitidos: SBC  
 Contraseña admitido: 0000, 1234, 8888  
 Terminale: Conector para iPod

El diseño y las especificaciones están sujetos a cambios sin previo aviso.

### Compatible iPod models / Modelos de iPod compatibles

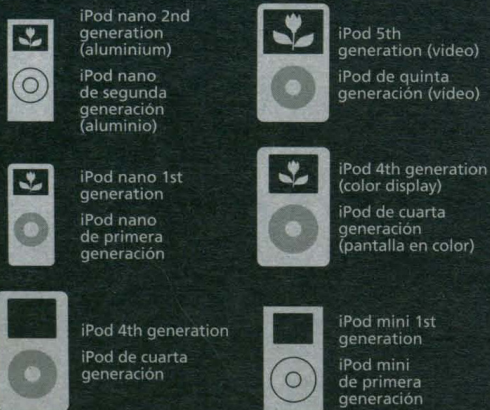

**Bluetooth®**

**Compatible products for wireless connection**  
**Productos compatibles con la conexión inalámbrica**

Car Audio System / Sistema de audio para automóvil  
 Headphones / Auriculares  
 Home Audio System / Sistema de audio doméstico  
 Active Speaker System / Sistema de altavoces activos

**!** For detailed information about product compatibility with Bluetooth connection, please visit the following URL.  
 Para obtener información detallada acerca de la compatibilidad de productos con la conexión Bluetooth, visite la URL siguiente.  
<http://sony.com/support>



© 2007 Sony Corporation

Transmitter :  
 Made in Malaysia  
 Transmisor :  
 Hecho en Malasia



**SONY**<sup>®</sup>Tape Cassette Player/Recorder/CD Player/Mini Disc  
DAT/Radio/Head Phone/Spaker/MIC/Personals

Portable Audio

# LIMITED WARRANTY (U.S. Only)

Sony Electronics Inc. ("Sony") warrants this product against defects in material or workmanship for the time periods and as set forth below. Pursuant to this Limited Warranty, Sony will, at its option, (i) repair the product using new or refurbished parts or (ii) replace the product with a new or refurbished product. For purposes of this Limited Warranty, "refurbished" means a product or part that has been returned to its original specifications. **In the event of a defect, these are your exclusive remedies.**

**Labor:** For a period of ninety (90) days from the original date of purchase of the product ("Labor Warranty"), Sony will, at its option, repair or replace with new or refurbished product, product determined to be defective. If Sony elects to replace the product after this Labor Warranty has expired but while the Parts Warranty below is still in effect, it will do so for the applicable labor charge.

**Parts:** For a period of one (1) year from the original date of purchase of product ("Parts Warranty"), Sony will supply new or refurbished replacement parts in exchange for parts determined to be defective.

This Limited Warranty covers only the hardware components packaged with the Product. It does not cover technical assistance for hardware or software usage and it does not cover any software products whether or not contained in the Product; any such software is provided "AS IS" unless expressly provided for in any enclosed software Limited Warranty. Please refer to the End User License Agreements included with the Product for your rights and obligations with respect to the software.

**Instructions:** To obtain warranty service, you must deliver the product, freight prepaid, in either its original packaging or packaging affording an equal degree of protection to the Sony authorized service facility specified. **It is your responsibility to backup any data, software or other materials you may have stored or preserved on your unit. It is likely that such data, software, or other materials will be lost or reformatted during service and Sony will not be responsible for any such damage or loss.** A dated purchase receipt is required. For specific instructions on how to obtain warranty service for your product,

Visit Sony's Web Site:  
[www.sony.com/service](http://www.sony.com/service)

Or call the **Sony Customer Information Service Center**  
**1-800-222-SONY (7669)**

For an accessory or part not available from your authorized dealer, call:

1-800-488-SONY (7669)

**Repair / Replacement Warranty:** This Limited Warranty shall apply to any repair, replacement part or replacement product for the remainder of the original Limited Warranty period or for ninety (90) days, whichever is longer. Any parts or product replaced under this Limited Warranty will become the property of Sony.

This Limited Warranty only covers product issues caused by defects in material or workmanship during ordinary consumer use; it does not cover product issues caused by any other reason, including but not limited to product issues due to commercial use, acts of God, misuse, limitations of technology, or modification of or to any part of the Sony product. This Limited Warranty does not cover Sony products sold AS IS or WITH ALL FAULTS or consumables (such as fuses or batteries). This Limited Warranty is invalid if the factory-applied serial number has been altered or removed from the product. This Limited Warranty is valid only in the United States.

**LIMITATION ON DAMAGES:** SONY SHALL NOT BE LIABLE FOR ANY INCIDENTAL OR CONSEQUENTIAL DAMAGES FOR BREACH OF ANY EXPRESS OR IMPLIED WARRANTY ON THIS PRODUCT.

**DURATION OF IMPLIED WARRANTIES:** EXCEPT TO THE EXTENT PROHIBITED BY APPLICABLE LAW, ANY IMPLIED WARRANTY OF MERCHANTABILITY OR FITNESS FOR A PARTICULAR PURPOSE ON THIS PRODUCT IS LIMITED IN DURATION TO THE DURATION OF THIS WARRANTY.

Some states do not allow the exclusion or limitation of incidental or consequential damages, or allow limitations on how long an implied warranty lasts, so the above limitations or exclusions may not apply to you. This Limited Warranty gives you specific legal rights and you may have other rights which vary from state to state.

## Free Manuals Download Website

<http://myh66.com>

<http://usermanuals.us>

<http://www.somanuals.com>

<http://www.4manuals.cc>

<http://www.manual-lib.com>

<http://www.404manual.com>

<http://www.luxmanual.com>

<http://aubethermostatmanual.com>

Golf course search by state

<http://golfingnear.com>

Email search by domain

<http://emailbydomain.com>

Auto manuals search

<http://auto.somanuals.com>

TV manuals search

<http://tv.somanuals.com>