

Micro Hi-Fi Component System

Operating Instructions



MDLP

CMT-CP505MD

WARNING

To prevent fire or shock hazard, do not expose the unit to rain or moisture.

To avoid electrical shock, do not open the cabinet. Refer servicing to qualified personnel only.

Do not install the appliance in a confined space, such as a bookcase or built-in cabinet.

US and foreign patents licensed from Dolby Laboratories.

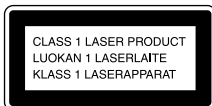

This appliance is classified as a CLASS 1 LASER product. This label is located on the rear exterior.

The following caution label is located inside the apparatus.



To prevent fire, do not cover the ventilation of the apparatus with news papers, table-cloths, curtains, etc. And don't place lighted candles on the apparatus.

To prevent fire or shock hazard, do not place objects filled with liquids, such as vases, on the apparatus.



Don't throw away the battery with general house waste, dispose of it correctly as chemical waste.

IN NO EVENT SHALL SELLER BE LIABLE FOR ANY DIRECT, INCIDENTAL OR CONSEQUENTIAL DAMAGES OF ANY NATURE, OR LOSSES OR EXPENSES RESULTING FROM ANY DEFECTIVE PRODUCT OR THE USE OF ANY PRODUCT.

Except for European model



ENERGY STAR® is a U.S. registered mark. As an ENERGY STAR® partner, Sony Corporation has determined that this product meets the ENERGY STAR® guidelines for energy efficiency.

Table of Contents

List of Button Locations and Reference Pages

Main unit	5
Remote Control	6

Getting Started

Hooking up the system	7
Inserting two R6 (size AA) batteries into the remote	8
Setting the clock	8

CD

Loading a CD	9
Playing a CD	
— Normal Play/Shuffle Play/Repeat Play	9
Programming CD tracks	
— Program Play	10
Labelling a CD	
— Disc Memo	11

MD – Play

Loading an MD	13
Playing an MD	
— Normal Play/Shuffle Play/Repeat Play	13
Programming MD tracks	
— Program Play	15
Playing only the tracks in the desired group	16

MD – Recording

Before you start recording	16
Recording tracks in groups	
— Group Function	18
Recording a CD on an MD	
— CD-MD Synchro Recording/High-Speed CD-MD Synchro Recording ..	20
Recording a tape on an MD	
— TAPE-MD Synchro Recording ...	21
Recording on an MD manually	
— Manual Recording	21
Starting recording with 6 seconds of prestored audio data	
— Time Machine Recording	22
Recording tips	23
Explanation of recording Settings	26

MD – Editing

Before you start editing	28
Labelling an MD	
— Name Function	28
Registering recorded tracks into a new group	
— Create Function	31
Releasing group registrations	
— Release Function	32
Erasing recordings	
— Erase Function	33
Moving recorded tracks	
— Move Function	35
Dividing recorded tracks	
— Divide Function	36
Combining recorded tracks	
— Combine Function	37
Undoing the last edit	
— Undo Function	38
Changing the recorded level after recording	
— S.F Edit Function	39

continued

Table of Contents (continued)

Tuner

Presetting radio stations	41
Listening to the radio	42
Labelling the preset stations — Station Name	43
Using the Radio Data System (RDS)*	44

Tape – Play

Loading a tape	44
Playing a tape	44

Tape – Recording

Recording your favorite CD tracks on a tape — CD-TAPE Synchro Recording	45
Recording your favorite MD tracks on a tape — MD-TAPE Synchro Recording ...	46
Recording on a tape manually — Manual Recording	47

Sound Adjustment

Adjusting the sound	47
---------------------------	----

Timer

Falling asleep to music — Sleep Timer	48
Waking up to music — Daily Timer	48
Timer recording radio programs	49

Display

Turning off the display — Power Saving Mode	50
Using the display	51

Optional Components

Hooking up optional components	53
Listening to audio from a connected component	54
Recording audio from a connected component	54

Troubleshooting

Problems and remedies	55
Self-diagnosis display	58

Additional Information

Precautions	61
System limitations of MDs	63
Specifications	64

* European model only.

How to use this page

Use this page to find the location of buttons and other parts of the system that are mentioned in the text.

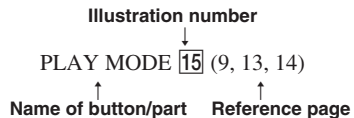

Main unit

ALPHABETICAL ORDER

A - G

- BASS **26** (47)
- CD **▶▶** **16** (9, 10, 22)
- DIRECTION **2** (21, 44, 45-47)
- Disc tray **24** (9)
- Display window **31**
- DSG **27** (47)
- ENTER/START **6** (20, 21, 45, 46)
- FM MODE **3** (43)
- FUNCTION **1** (9, 13, 16, 19, 21-23, 25, 44, 47, 54)
- GROUP ON/OFF **21** (15, 16, 18-20, 29-32)
- GROUP SKIP **20** (16, 19, 20, 29, 30, 32)

M - V

- MD slot **28** (13)
- MD **▶▶** **13** (13, 14, 16, 21)
- PHONES jack **23**
- PLAY MODE **2** (9-11, 13, 15, 28)
- REC MODE **4** (20-22, 26)
- Remote sensor **29**
- REPEAT **3** (10, 14)
- SYNCHRO **5** (20, 21, 45, 46)
- TAPE **◀▶** **7** (44-46)
- TREBLE **25** (47)
- TUNER BAND **11** (41-43)
- TUNING +/- **19** (41-43)
- TUNING MODE **2** (41-43)
- VOLUME **22**

BUTTON DESCRIPTIONS

I/O (power) **30**

◀▶▶▶ **19**

◀◀◀▶▶▶ **19**

TAPE

▶▶ **9**

■ **8**

● REC **10**

MD

▲ **12**

■ **14**

● REC **15**

CD

▲ **18**

■ **17**

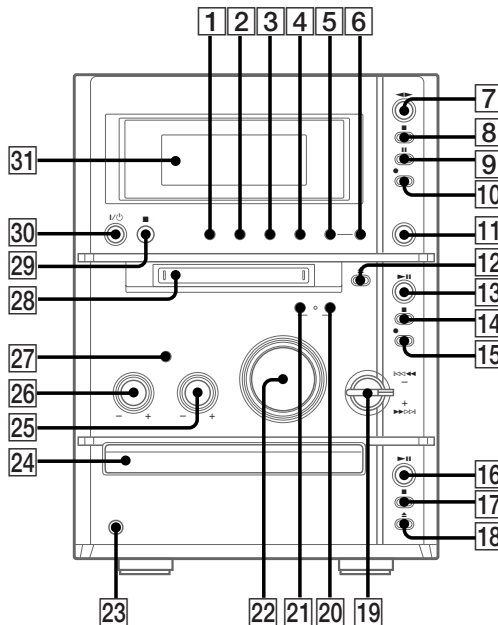

Remote Control

ALPHABETICAL ORDER

A - F

BASS/TRE **4** (47)
 CD **23** (10-13)
 CLEAR **7** (10, 15, 30, 43)
 CLOCK/TIMER SELECT **2**
 (49, 50)
 CLOCK/TIMER SET **3** (8, 48,
 49)
 CURSOR ←/→ **8** (8, 12, 29,
 30)
 DISPLAY **25** (11, 15, 22, 44, 50-
 52)
 DSG **13** (47)
 ENTER/YES **5** (8, 10, 12, 13,
 15, 22-26, 28-43, 48-50)
 FUNCTION **22** (9, 13, 16, 19,
 21-23, 25, 44, 47, 54)

M - V

MD **24** (15, 24, 25, 28, 29, 31-
 37, 39, 40)
 MENU/NO **15** (12, 13, 23-26,
 28, 30-41, 43)
 NAME EDIT/SELECT **26**
 (11, 29, 43)
 Numeric buttons **6** (10, 12, 14,
 29, 42)
 PLAY MODE **16** (9-11, 13, 15,
 28)
 REPEAT **18** (10, 14)
 SCROLL **19** (12, 30, 52)
 SLEEP **17** (48)
 TAPE **21**
 TUNER BAND **20** (41-43)
 VOLUME +/- **12**

BUTTON DESCRIPTIONS

I/⏻ (power) **1**
 ▶ **10**
 || **14**
 ■ **11**
 ◀◀/▶▶ **8**
 ◀◀/▶▶ **9**

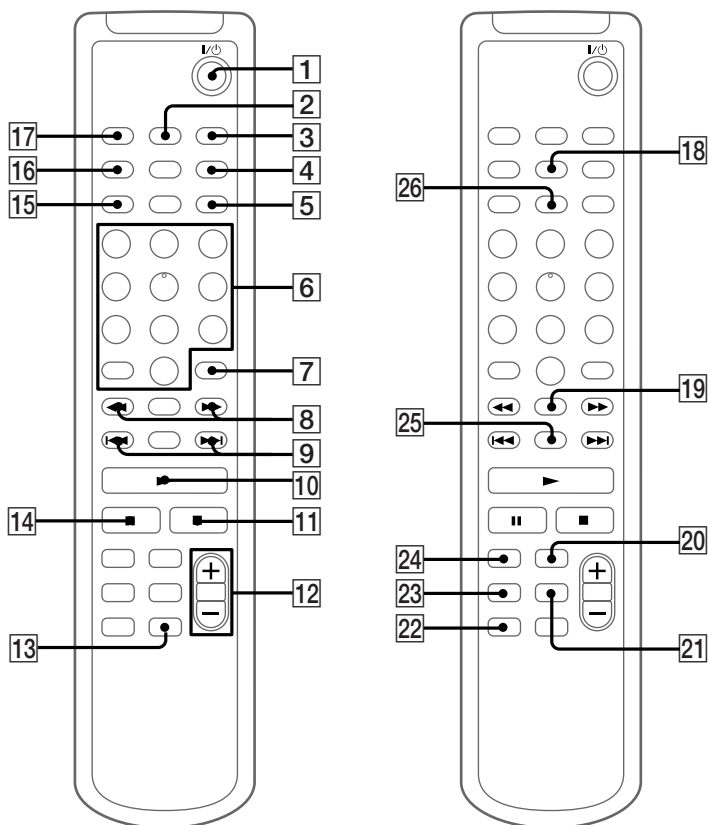

Hooking up the system

Perform the following procedure **1** to **4** to hook up your system using the supplied cords and accessories.

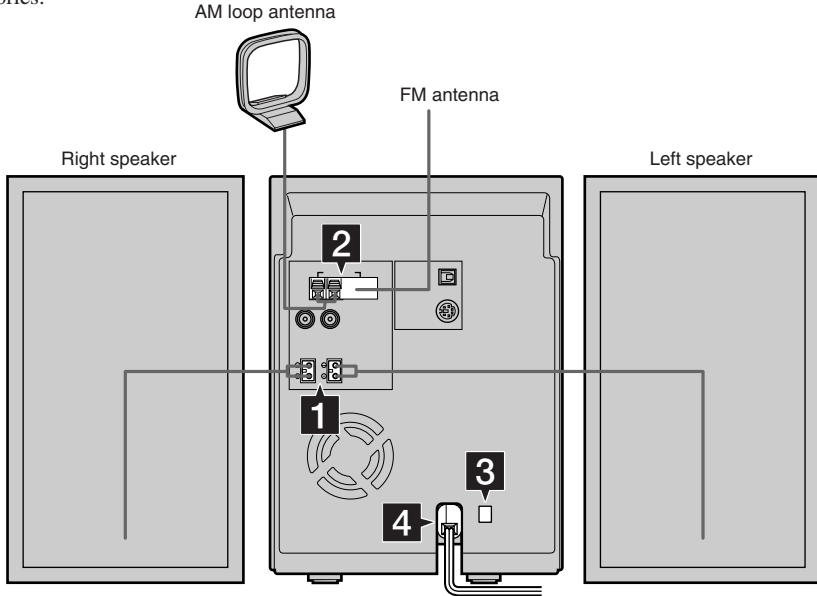

1 Connect the speakers.

Connect the right and left speaker cords to the SPEAKER terminals as shown below.

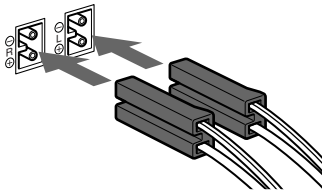

2 Connect the FM and AM antennas.

Set up the AM loop antenna, then connect it.

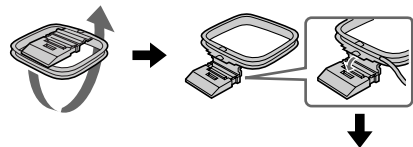

Jack type A Extend the FM wire antenna horizontally

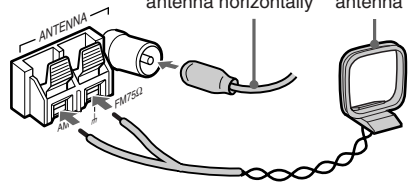

Jack type B Extend the FM wire antenna horizontally

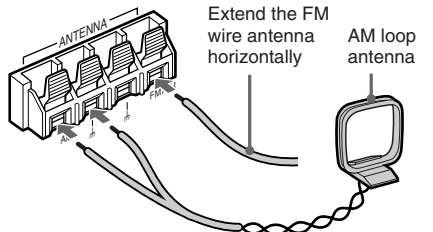

continued

Hooking up the system (continued)

- 3 For models with a voltage selector, set **VOLTAGE SELECTOR** to the local power line voltage.



- 4 Connect the power cord to a wall outlet.

If the plug does not fit the wall socket, detach the supplied plug adaptor (only for models equipped with an adaptor).

To turn on the system, press I/⏻.

Inserting two R6 (size AA) batteries into the remote

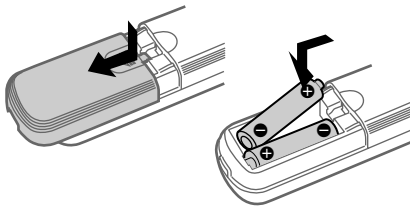

Tip

When the remote no longer operates the system, replace both batteries with new ones.

Note

If you do not use the remote for a long period of time, remove the batteries to avoid possible damage from battery leakage and corrosion.

Setting the clock

- 1 Press I/⏻ to turn on the system.
- 2 Press **CLOCK/TIMER SET** on the remote.
- 3 Press **⏪** or **⏩** on the remote repeatedly to set the hour.
- 4 Press **ENTER/YES** or **CURSOR→** on the remote.
- 5 Press **⏪** or **⏩** on the remote repeatedly to set the minute.
- 6 Press **ENTER/YES** on the remote.
The clock starts working.

If you make a mistake

Press **←CURSOR** or **CURSOR→** on the remote repeatedly until the incorrect item flashes, then set it again.

To adjust the clock

- 1 Press **CLOCK/TIMER SET** on the remote.
- 2 Press **⏪** or **⏩** on the remote to select “**CLOCK SET**”, then press **ENTER/YES** on the remote.
- 3 Do the same procedures as step 3 to 6 above.

Loading a CD

1 Press CD \blacktriangle .

The disc tray slides out.

2 Place a CD with the label side up on the disc tray.

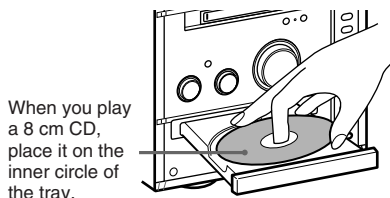

When you play a 8 cm CD, place it on the inner circle of the tray.

3 Press CD \blacktriangle again to close the disc tray.

Playing a CD

— Normal Play/Shuffle Play/Repeat Play

This system lets you play the CD in different play modes.

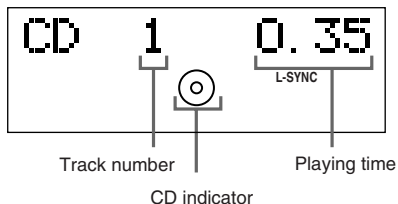

1 Press FUNCTION repeatedly to switch the function to CD.

2 Press PLAY MODE in stop mode repeatedly until the mode you want appears in the display.

Select	To play
No display (Normal Play)	The tracks on the disc in original order.
SHUF (Shuffle Play)	All tracks on the disc in random order.
PGM (Program Play)	The tracks on the disc in the order you want them to be played (see "Programming CD tracks" on page 10).

3 Press CD \blacktriangleright II (or \blacktriangleright on the remote).

Notes

- You cannot change the play mode during playback.
- If you press CD \blacktriangle to open/close the disc tray while listening to other function, the CD indicator lights up even when there is no CD on the disc tray. To turn off the CD indicator, press FUNCTION repeatedly to switch the function to CD.

continued

Playing a CD (continued)

Other operations

To	Do this
Stop play	Press CD ■ (or ■ on the remote).
Pause	Press CD ► (or on the remote). Press again to resume play.
Select a track	Turn ◀◀/▶▶ clockwise or counterclockwise (or press ◀◀ or ▶▶ on the remote repeatedly).
Find a point in a track	During play, turn and hold ◀◀/▶▶ clockwise or counterclockwise (or press and hold ◀◀ or ▶▶ on the remote). Release it when you find the desired point.
Play repeatedly (Repeat Play)	Press REPEAT repeatedly during playback until "REP" or "REP1" appears in the display. REP: For all the tracks on the CD up to 5 times. REP1: For only the currently playing track. To cancel playing repeatedly, press REPEAT repeatedly until "REP" and "REP1" disappear from the display.
Remove a disc	Press CD ▲.

To enter track number using the remote

You can also select the desired track using the remote during Normal Play.

Press the numeric buttons. The playback automatically starts.

To enter track number over 10

1 Press >10.

2 Press the numeric buttons for the same number of "--" flashing in the display.

To select 0, press 10/0.

Example:

To enter 20 while "--" flashes in the display, press 2, 10/0.

Programming CD tracks

— Program Play

You can make a program of up to 25 tracks.

- 1 Press CD on the remote.
- 2 Press PLAY MODE in stop mode repeatedly until "PGM" appears.
- 3 Press ◀◀ or ▶▶ on the remote repeatedly until the desired track number appears.

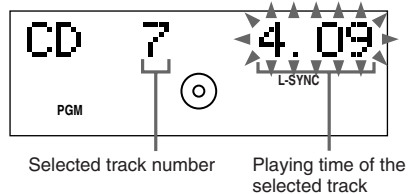

- 4 Press ENTER/YES on the remote.

The track is programmed.

The step number appears, followed by the total playing time of the program.

If you made a mistake, you can clear the last programmed track from the program by pressing CLEAR on the remote.

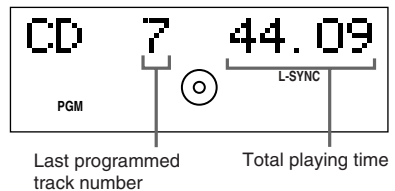

5 To program additional tracks, repeat steps 3 and 4.

6 Press ► on the remote.

Other operations

To	Do this
Cancel Program Play	Press PLAY MODE in stop mode repeatedly until both “SHUF” and “PGM” disappear.
Check the program order	Press ◀◀ or ▶▶ on the remote repeatedly during Program Play.
Check the total number of programmed tracks	Press DISPLAY on the remote in stop mode. The total number of programmed steps appears, followed by the total playing time of the program.
Add a track to the end of the program	Perform steps 3 and 4 in stop mode.

Tips

- The program you made remains after Program Play finishes. To play the same program again, press ► on the remote. However, the program is cleared when you open the disc tray.
- “--:--” appears when the total program time exceeds 100 minutes or when you select a CD track whose number is 21 or over.
- If you select “AL” in step 3, all the tracks on the disc are selected.

Labelling a CD

— Disc Memo

You can label up to 50 CDs with titles of up to 20 symbols and characters. Whenever you load a labelled CD, the title appears.

Notes

- You cannot label a CD for which “TEXT” appears in the display.
- **When labelling CDs for the first time, be sure to erase all disc titles stored in the system memory (see “Erasing a disc title” on page 13).**

1 Press CD on the remote.

If “SHUF” or “PGM” appears, press PLAY MODE repeatedly until both disappear.

2 Press NAME EDIT/SELECT on the remote in stop mode.

The cursor starts flashing.

3 Press NAME EDIT/SELECT on the remote repeatedly to select the desired type of character.

Character type	Select
Alphabet (upper cases)/ blank space/symbols	Selected AB
Alphabet (lower cases)/ blank space/symbols	Selected ab
Numbers	Selected 12

continued

Labelling a CD (continued)

4 Enter a character.

Character type	Do this
Alphabet	Press the corresponding letter button (or ◀◀◀/▶▶▶) on the remote repeatedly until the character to be entered flashes, then press CURSOR→ on the remote.
Numbers	Press the corresponding numeric buttons on the remote.
Blank space	Press 10/0 on the remote.
‘ - / , . () : ! ?	Press 1 on the remote repeatedly.
& + < > _ = “ ” ; # \$ % @ * `	Press 1 on the remote, then press ◀◀◀/▶▶▶ on the remote repeatedly.

5 Repeat steps 3 and 4 to enter the rest of the name.

6 Press ENTER/YES on the remote.

To change the character

In step 3 or 4, press ←CURSOR or CURSOR→ repeatedly until the character to be changed flashes, press CLEAR on the remote to erase the character, then repeat steps 3 and 4.

To cancel labelling

Press MENU/NO on the remote.

To add a character

After steps 1 and 2, press ←CURSOR or CURSOR→ until the cursor comes to the point you want to add a character, then proceed to step 3.

Checking the disc titles

1 Press CD on the remote.

2 Press MENU/NO on the remote in stop mode.

3 Press ◀◀◀ or ▶▶▶ on the remote repeatedly until “Name Check?” appears, then press ENTER/YES on the remote.

4 Press ◀◀◀ or ▶▶▶ on the remote repeatedly to select the disc titles stored in the system memory between 01 and 50.

To check the current disc title

Press SCROLL on the remote in stop mode.

Playing an MD (continued)

Other operations

To	Do this
Stop play	Press MD ■ (or ■ on the remote).
Pause	Press MD ► (or on the remote). Press again to resume play.
Select a track	Turn ◀◀/▶▶ clockwise or counterclockwise (or press ◀◀ or ▶▶ on the remote repeatedly).
Find a point in a track	During play, turn and hold ◀◀/▶▶ clockwise or counterclockwise (or press and hold ◀◀ or ▶▶ on the remote). Release it when you find the desired point.
Play repeatedly (Repeat Play)	Press REPEAT repeatedly during playback until "REP" or "REP1" appears in the display. REP: For all the tracks on the MD up to 5 times. REP1: For only the currently playing track. To cancel playing repeatedly, press REPEAT repeatedly until "REP" and "REP1" disappear from the display.
Remove the MD	Press MD ▲.

To enter track number using the remote

You can also select the desired track using the remote during Normal Play.

Press the numeric buttons. The playback automatically starts.

To enter track number over 10

1 Press >10.

2 Press the numeric buttons for the same number of "-" flashing in the display.

To select 0, press 10/0.

Examples:

- To enter 16 while "--" flashes in the display, press 1, 6.
- To enter 20 while "---" flashes in the display, press 10/0, 2, 10/0.

Programming MD tracks

— Program Play

You can make a program of up to 25 tracks.

- 1 Press MD on the remote.**
- 2 Press PLAY MODE in stop mode repeatedly until “PGM” appears.**
- 3 Press ◀◀ or ▶▶ on the remote repeatedly until the desired track number appears.**
- 4 Press ENTER/YES on the remote.**

The track is programmed.

The step number appears, followed by the total playing time of the program.

If you made a mistake, you can clear the last programmed track from the program by pressing CLEAR on the remote.

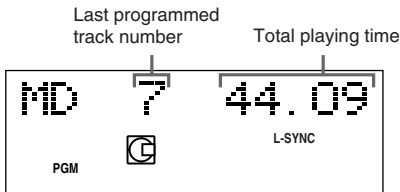

- 5 To program additional tracks, repeat steps 3 and 4.**
- 6 Press ▶ on the remote.**

Other operations

To	Do this
Cancel Program Play	Press PLAY MODE in stop mode repeatedly until both “PGM” and “SHUF” disappear.
Check the program order	Press ◀◀ or ▶▶ on the remote repeatedly during Program Play.
Check the total number of programmed tracks	Press DISPLAY on the remote in stop mode. The total number of programmed steps appears, followed by the total playing time of the program.
Add a track to the end of the program	Perform steps 3 and 4 in stop mode.

Tips

- The program you made remains after Program Play finishes. To play the same program again, press ▶ on the remote. However, the program is cleared after you remove the MD or press GROUP ON/OFF.
- “---” appears when the total program time exceeds 1,000 minutes.

Playing only the tracks in the desired group

This function allows you to listen only to your favorite tracks which you have registered into a group. For details of the Group Function, see page 18.

- 1** Press **FUNCTION** repeatedly to switch the function to **MD**.
- 2** Press **GROUP ON/OFF** in stop mode repeatedly until **GROUP** indicator lights up.
- 3** Press **GROUP SKIP** repeatedly until the desired group appears.
- 4** To start playing from a specific track in the group, turn **|◀◀/▶▶|** clockwise or counterclockwise (or press **◀◀** or **▶▶** on the remote repeatedly) until the desired track appears.

Proceed to step 5 when you start playing from the first track in the group.

- 5** Press **MD ▶▶||** (or **▶▶** on the remote).
Play starts.
When the playing of the last track in the group finishes, the MD deck stops automatically.

Tip

You can perform the operations on pages 13–15 only for the tracks in the group.

To select the desired play mode, select the play mode before step 3.

Note

If you select a group that does not have any tracks registered and press **MD ▶▶||** (or **▶▶** on the remote), playback starts from the first track of the first group on the MD.

Before you start recording

MDs (MiniDisc) let you digitally record and play music with high quality sound. Another feature of MDs is track marking. The track marking feature lets you quickly locate a specific point or easily edit the recorded tracks. However, depending on the source you record, the recording method and the way the track numbers are recorded differ.

When the source you record from is:

- **This system's CD player**
 - The MD deck performs digital recording.*1
 - Track numbers are automatically marked as on the original CD. However, track numbers are not marked depending on the track (page 63).
- **Other digital components connected to the DIGITAL OPTICAL IN jack**
 - The MD deck performs digital recording.*1
 - Track numbers are marked differently depending on the source you record.
- **This system's tuner or other analog components connected to the ANALOG IN jacks**
 - The MD deck performs analog recording.*2
 - A track number is marked at the beginning of a recording only, but when you turn on the Level Synchro Recording Function (page 24), track numbers are automatically marked in sync with the level of the input signal.

When you use a partially recorded MD

You cannot record while overwriting the recorded tracks.

Recording starts after the recorded tracks.

If you want to erase the recorded tracks, erase the tracks using Erase function (page 33).

Note on MD track numbers

On an MD, the track numbers (track sequence), track start and end point information, etc., are recorded in the TOC*³ area independent of the sound information. You can edit recorded tracks quickly by modifying the TOC information.

About recording errors

- With the following kinds of CDs, you may experience a reading failure or noise when recorded on an MD:
 - CDs with adhesive labels attached to them
 - Irregularly shaped CDs (for example, heart- or star- shaped)
 - CDs with printed text concentrated on one side only
 - Scratched CDs
 - Dirty CDs
 - Warped CDs
- If the following occurs during CD playback or recording, a reading error may occur or noise may be produced in the recorded results:
 - The disc tray or other part of the system is bumped.
 - The system is placed on an uneven or soft surface.
 - The system is located near a speaker, door, or other source of vibration.
- If the above reading errors occur, an extra soundless track may be created. You can erase these extra tracks using Erase Function (page 33).

*¹ For details on the limitations of digital recording, see “System limitations of MDs” on page 63.

*² Even if you connect a digital component, the MD deck performs analog recording.

*³ TOC: Table Of Contents

After recording

Press MD \blacktriangle to remove the MD or press I/⏻ (power) to turn off the system.

“TOC” or “STANDBY” starts flashing. The TOC is updated and recording is completed.

Before pulling out the power cord

MD recording is completed when the MD Table of Contents (TOC) is updated. The TOC is updated when you eject the MD or press I/⏻ to turn off the system. Do not pull out the mains lead before updating the TOC or while updating the TOC (while “TOC” lights up or flashes) to ensure a complete recording.

Protecting a recorded MD

To protect a recorded MD, slide the tab on the side of the MD to open the slot. In this position, the MD cannot be recorded. To record on the MD, slide the tab to close the slot.

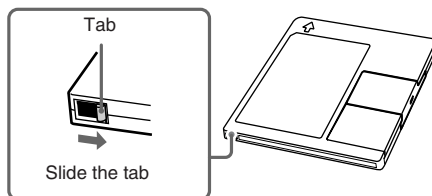

Recording tracks in groups

— Group Function

What is the Group Function?

The Group Function allows you to play, record and edit the tracks on an MD in groups. This is convenient for managing multiple CD albums recorded in MDLP mode onto a single MD. The Group Function is turned on and off by pressing GROUP ON/OFF.

Group Function: Off

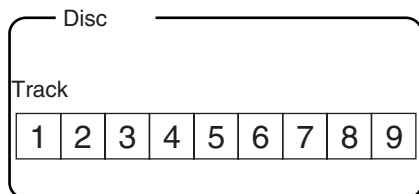

Group Function: On

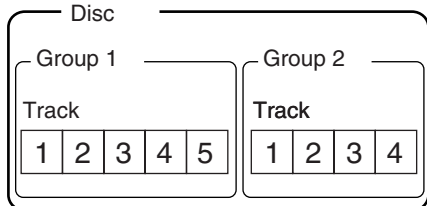

Operations using the Group Function

- Playing only the tracks in the desired group (page 16)
- Labelling a group (page 28)
- Registering recorded tracks into a new group (page 31)
- Releasing group registrations (page 32)

Note

MDs recorded using the Group Function of this system can be used with other system that supports the Group Function. However, note that the Group Function operations of other system may differ from the operations for this system.

How is group information recorded?

When recording using the Group Function, the group management information is automatically recorded on the MD as the disc title. Specifically, a character string such as the following is written in the disc title recording area.

Disc title recording area

0 ; Favorites // 1 – 5 ; Rock // 6 – 9 ; Pops // ...
① ② ③

- ① The disc title is “Favorites”.
- ② Tracks 1 to 5 are registered in the “Rock” group.
- ③ Tracks 6 to 9 are registered in the “Pops” group.

Therefore, when an MD recorded using the Group Function is loaded on a system that does not support the Group Function or on this system with the Group Function turned off, the above character string is displayed in its entirety as the disc title.

Note that if you rewrite this character string by mistake using the Name Function, you may be unable to use the Group Function of that MD.*

* GROUP indicator flashes. To use the Group Function again, first perform the procedure for “Releasing the registrations of all tracks on an MD” on page 32 and release the registrations of all tracks on the MD.

Notes

- The Group Function setting is stored even if you eject the MD or turn off the system.
- When the Group Function is on, tracks which are not registered to a group are not displayed and cannot be played.
- You cannot change the group order.
- If you load a disc with group management information written in other than the proper format, GROUP indicator flashes. In this case you cannot use the Group Function.

Recording into a new group

You can create new groups by CD album or artist, etc.

1 Load a recordable MD.

2 Press FUNCTION repeatedly to select the desired source to record.

- CD: To record from this system's CD player.
- TAPE: To record from this system's cassette deck.
- TUNER: To record from this system's tuner.
- OPTICAL IN: To record from the optional component connected to the DIGITAL OPTICAL IN jack.
- ANALOG IN: To record from the optional component connected to the ANALOG IN jacks.

3 Press GROUP ON/OFF repeatedly until GROUP indicator lights up.

4 Press MD ●REC.

"New Group" flashes and the MD deck stands by for recording.

5 Press MD ►II (or ► on the remote), then start playing the desired source to record.

To continue recording into another new group, switch the function to MD after recording, press MD ■ repeatedly until the disc title and total number of groups appears, then perform steps 2 to 5.

Recording into an existing group

After step 4, press GROUP SKIP repeatedly until the desired group appears, then proceed to step 5. New tracks are recorded after the last track in the group.

If "Group Full!" appears when you press MD ●REC in step 4

You cannot start recording because there is insufficient character space for group management.

Delete unnecessary characters (disc title or track titles) until group recording is possible (see page 30).

Tips

- You can adjust the recording level (page 25).
- You can check the remaining recordable time on the MD during recording by pressing DISPLAY on the remote.

Notes

- The new group is added after any existing groups with tracks registered.
- Up to 99 groups can be registered on a single MD.
- When you newly record a track into an existing group, the track numbers following the newly recorded track may change when the Group Function is turned off.
- If "Group Full!" appears during recording, track numbers are not marked.

Recording a CD on an MD

— CD-MD Synchro Recording/High-Speed CD-MD Synchro Recording

You can record a whole CD on an MD. In addition to normal-speed recording, you can also record at high speed (approximately four times the normal speed).

You can select the recording time by switching the recording mode.

- 1 Load a recordable MD.**
- 2 Load a CD you want to record.**
- 3 To record using the Group Function, press GROUP ON/OFF repeatedly until GROUP indicator lights up.**

To record not using the Group Function, turn off the GROUP indicator and proceed to step 4.

- 4 Press REC MODE repeatedly to select the recording mode.**

Select the desired recording time.

Recording time	Select (Recording mode)
Standard	no indication (stereo)
Double	LP2 (LP2 stereo)
Quadruple	LP4 (LP4 stereo)
Double (change the stereo signal to monaural)	MONO (monaural)

- 5 Press SYNCHRO repeatedly until “CD→MD SYNC” appears.**

To record at high speed (High-Speed CD-MD Synchro Recording), select “HISPEED SYNC”.
- 6 Press ENTER/START.**

“Press START” flashes.
The MD deck stands by for recording and the CD player pauses for playback.

- 7 To record using the Group Function, perform the following procedure depending on where you want to record:**

To record into a new group

Press GROUP SKIP repeatedly until “New Group” appears.

To record into an existing group

Press GROUP SKIP repeatedly until the desired group appears.

Proceed to step 8 to record not using the Group Function.

- 8 Press ENTER/START while “Press START” flashes.**

Recording starts.

When the recording is completed, the CD player and the MD deck stop automatically.

To stop recording

Press MD ■.

Recording a CD on an MD and a tape at the same time

Load a recordable tape, then select “DUAL SYNC” in step 5.

Even if the MD or the tape ends part-way through the recording, the other continues recording.

To record only your favorite CD tracks

You can record only your favorite CD tracks using the Program Play. Between steps 2 and 3, perform steps 1 to 5 of “Programming CD tracks” (page 10).

Tips

- For details about LP2/LP4 recording, see page 26.
- For details about High-Speed CD-MD Synchro Recording, see page 27.

Notes

- You cannot pause the recording.
- If the play mode is set to the Repeat Play or Shuffle Play, the play mode switches to Normal Play in step 6.

Recording a tape on an MD

— TAPE-MD Synchro Recording

You can make an analog recording of a tape on an MD. You can use TYPE I (normal) tape.

- 1 Load a recordable MD.
- 2 Load a tape you want to record.
- 3 Press **SYNCHRO** repeatedly until "TAPE→MD SYNC" appears.
- 4 Press **ENTER/START**.

"Press START" flashes.

The MD deck stands by for recording and the tape deck pauses for play.

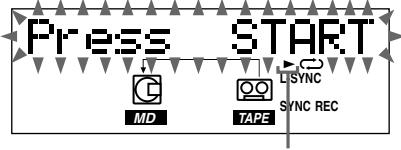

Tape playback side*

* ► appears for the top side, and ◄ for the bottom side. To play the side not indicated, press ■ and remove the cassette to reverse the tape side, then perform steps 3 and 4 again.

- 5 Press **DIRECTION** repeatedly until ⇄ appears to play one side or ⇄⇄ (or ⇄⇄⇄) to play both sides.
- 6 Press **ENTER/START** while "Press START" flashes.

Recording starts.

When the recording is completed, the tape deck and the MD deck stop automatically.

To stop recording

Press MD ■.

Recording on an MD manually

— Manual Recording

You can record just the portions you like from a CD, or other connected component.

- 1 Load a recordable MD.
- 2 Press **FUNCTION** repeatedly to select the desired source to record.
 - CD: To record from this system's CD player.
 - TAPE: To record from this system's cassette deck.
 - TUNER: To record from this system's tuner.
 - OPTICAL IN: To record from the optional component connected to the OPTICAL IN jack.
 - ANALOG IN: To record from the optional component connected to the ANALOG IN jacks.

- 3 Press **REC MODE** repeatedly to select the recording mode.

Select the desired recording time.

Recording time	Select (Recording mode)
Standard	no indication (stereo)
Double	LP2 (LP2 stereo)
Quadruple	LP4 (LP4 stereo)
Double (change the stereo signal to monaural)	MONO (monaural)

- 4 Press MD ●REC.

The MD deck stands by for recording.

- 5 Press MD ►|| (or ► on the remote), then start playing the desired source to record.

To stop recording

Press MD ■.

continued

Recording on an MD manually (continued)

Tips

- If you want to record manually in the middle of a track loaded in this system, press CD ►|| (or || on the remote) before step 4 to pause the playback, then press CD ►|| (or ► on the remote) in step 5 to start playback.
- You can check the remaining recordable time on the MD during recording by pressing DISPLAY on the remote.
- If cyclical static noise is heard while recording an AM radio program, move the AM loop antenna to reduce the noise or connect a ground wire to the \hbar terminal.
- For details about LP2/LP4 recording, see page 26.
- You can adjust the recording level (page 25).

Starting recording with 6 seconds of prestored audio data

— Time Machine Recording

When recording from an FM or satellite broadcast, the first few seconds of material are often lost due to the time it takes you to ascertain the contents and press the record button. To prevent the loss of this material, the Time Machine Recording feature constantly stores the most recent audio data in a buffer memory. This lets you record the sound from 6 seconds before starting recording, as shown in the illustration below:

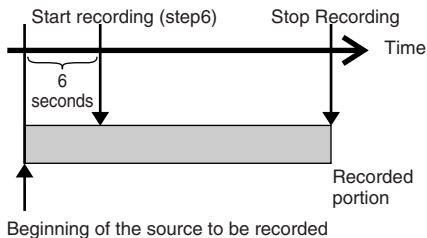

1 Load a recordable MD.

2 Press FUNCTION repeatedly to select the desired source to record.

3 Press REC MODE repeatedly to select the recording mode.

Select the desired recording time.

Recording time	Select (Recording mode)
Standard	no indication (stereo)
Double	LP2 (LP2 stereo)
Quadruple	LP4 (LP4 stereo)
Double (change the stereo signal to monaural)	MONO (monaural)

4 Press MD ●REC.

The MD deck stands by for recording.

5 Start playing the desired source to record.

6 Press ENTER/YES on the remote at the desired point to start recording.

To stop Time Machine Recording

Press MD ■.

Tip

For details about LP2/LP4 recording, see page 26.

Note

The MD deck starts storing audio data when the deck stands by for recording in step 4 and you start playing the source. If less than 6 seconds have passed when you press ENTER/YES on the remote, Time Machine Recording starts with less than 6 seconds of audio data.

Recording tips

Adding "LP:" to a track name during MDLP recording

You can add "LP:" at the beginning of the track title which appears when you try to play the track on a system that does not support MDLP mode. This convenient function lets you know at a glance that the track is recorded in MDLP mode and cannot be played back.

It does not appear when the system supports MDLP mode.

- 1 Press FUNCTION repeatedly to switch the function to MD.
- 2 Press MENU/NO on the remote.
- 3 Press ◀◀ or ▶▶ on the remote repeatedly until "Setup?" appears, then press ENTER/YES on the remote.
- 4 Press ◀◀ or ▶▶ on the remote repeatedly until "LP Stamp Off" (or "LP Stamp On") appears, then press ENTER/YES on the remote.
- 5 Press ◀◀ or ▶▶ on the remote repeatedly to select the setting, then press ENTER/YES on the remote.

To	Select
Add "LP:"	LP Stamp On (factory setting)
Cancel adding "LP:"	LP Stamp Off

- 6 Press MENU/NO on the remote.

Notes

When set to "On", "LP:" is recorded as the track title, so the number of characters that can be input to an MD is reduced. In addition, if you divide an "LP:" track using the Divide Function, "LP:" is also added to the latter track.

Marking track numbers

- **Automatically during recording (Level Synchro Recording)**

Track numbers are automatically marked as on the original source during recording from this system's CD player or components connected to DIGITAL OPTICAL IN jack. However, track numbers are not marked depending on the track (page 63).

Use the Level Synchro Recording Function to automatically mark track numbers during recording from this system's tuner or components connected to the ANALOG IN jacks. However, track numbers are not marked automatically if the source sound to be recorded is noisy (e.g., tapes or radio programs).

Note

When recording a CD, track numbers are marked where you paused recording. In addition, the tracks might be recorded as the same single track with a single track number when the same single track of the same CD is recorded repeatedly.

- **At any point during recording (Track Mark)**

You can mark track numbers during manual recording of any source.

- **After recording**

Use the Divide Function (page 36).

This function is convenient when the source is tape or radio programs and the track numbers are not marked automatically.

continued

Recording tips (continued)

Marking track numbers automatically during recording

— Level-Synchro Recording

The Level Synchro Recording Function is factory set to on, so the track numbers are automatically marked. If “L-SYNC” does not appear during recording, turn on the Level Synchro Recording as follows. Track numbers are automatically marked when the input signal is continuously below a certain level for more than two seconds and then exceeds that level.

- 1 Press MD on the remote.
- 2 Press MENU/NO on the remote.
- 3 Press ◀◀ or ▶▶ on the remote repeatedly until “Setup?” appears, then press ENTER/YES on the remote.
- 4 Press ◀◀ or ▶▶ on the remote repeatedly until “T.Mark Off” (or “T.Mark LSync”) appears, then press ENTER/YES on the remote.
- 5 Press ◀◀ or ▶▶ on the remote repeatedly to select the setting, then press ENTER/YES on the remote.

To	Select
Turn on the Level Synchro Recording Function	T.Mark LSync (factory setting)
Turn off the Level Synchro Recording Function	T.Mark Off

When you set the Level Synchro Recording Function on, “L-SYNC” lights up.

- 6 Press MENU/NO on the remote.
To continue recording, follow the procedures described for each type of recording.

To change the trigger level for Level Synchro Recording

When the Level Synchro recording is set to “On”, track numbers are automatically marked when the input signal is below the trigger level set in this section for more than two seconds and then exceeds that level. The factory setting is “-50 dB”.

When the recording source is tape or radio program and the track numbers are not marked properly because of noise, set this level higher so that track numbers are marked easily.

Perform the following procedure to change the signal level that triggers Level Synchro Recording.

- 1 Press MD on the remote.
- 2 Press MENU/NO on the remote.
- 3 Press ◀◀ or ▶▶ on the remote repeatedly until “Setup?” appears, then press ENTER/YES on the remote.
- 4 Press ◀◀ or ▶▶ on the remote repeatedly until “LS(T)” appears, then press ENTER/YES on the remote.
- 5 Press ◀◀ or ▶▶ on the remote repeatedly to select the level, then press ENTER/YES on the remote.

You can set the level at any value between -72 dB and 0 dB, in 2 dB steps.

- 6 Press MENU/NO on the remote.

Marking track numbers at a specific point during recording

— Track Mark

You can mark track numbers at any time during manual recording, regardless of the type of source sound.

Press MD ●REC during manual recording at the point you want to add a track mark.

The tracks following the added one are renumbered.

Marking track numbers after recording

Use the Divide Function (page 36).

Making a space between tracks 3 seconds long automatically

— Smart Space

The Smart Space function lets you make the blank spaces between tracks 3 seconds long automatically while making a digital recording from a CD. For other types of recording, if the Smart Space Function is on and there is no sound input for about 3 seconds or more (but less than 30 seconds) while recording, the MD deck replaces this silence with a blank of about 3 seconds and continues recording.

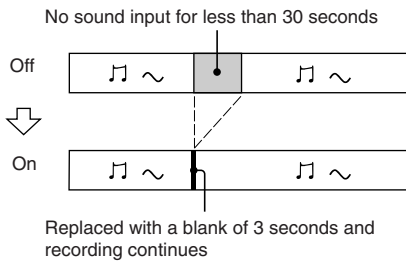

Auto Cut: When the Smart Space Function is on, if there is no sound input for 30 seconds or more, the MD deck replaces this silence with a blank of about 3 seconds and enters recording pause.

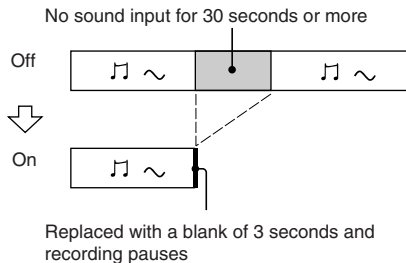

- 1** Press MD on the remote.
- 2** Press MENU/NO on the remote.
- 3** Press **◀◀** or **▶▶** on the remote repeatedly until “Setup?” appears, then press ENTER/YES on the remote.
- 4** Press **◀◀** or **▶▶** on the remote repeatedly until “S.Space Off” (or “S.Space On”) appears, then press ENTER/YES on the remote.
- 5** Press **◀◀** or **▶▶** on the remote repeatedly to select the setting, then press ENTER/YES on the remote.

To	Select
Turn on the Smart Space Function	S.Space On (factory setting)
Turn off the Smart Space Function	S.Space Off

- 6** Press MENU/NO on the remote.
To continue recording, follow the procedures described for each type of recording.

Adjusting the recording level

When recording on an MD, you can adjust the recording level to the desired volume. You can adjust the recording level not only when making an analog recording, but also when making a digital recording from a CD, etc.

- 1** Press FUNCTION repeatedly to select the desired source to record.
- 2** Press MD ●REC.
The MD deck stands by for recording.
- 3** Start playing the desired source to record.

continued

Recording tips (continued)

- 4** Press MENU/NO on the remote to display “Setup?”, then press ENTER/YES on the remote.
- 5** Press ◀◀ or ▶▶ on the remote repeatedly until “LevelAdjust?” appears, then press ENTER/YES on the remote.
- 6** Press ◀◀ or ▶▶ on the remote repeatedly to adjust the recording level.
Adjust to the optimum level while making sure that “OVER” does not appear in the display at the loudest portion.



Adjust the level so as not to light up “OVER”

- 7** Press ENTER/YES on the remote.
- 8** Press MENU/NO on the remote.
- 9** Press MD ■.
- 10** When a CD or other sound source is playing, stop playback.
To continue recording, follow the procedures described for each type of recording.

Tips

- You can also adjust the recording level during recording.
- Once adjusted, the recording level is maintained until you adjust it again.
- You cannot adjust the recording level during CD-MD Synchro Recording.

Explanation of recording Settings

Recording for long times

This system has two long time recording modes: LP2 and LP4 (MDLP recording). Press REC MODE to select the recording mode. Refer to each pages about recording (20–22).

MDs recorded in MDLP Stereo mode are played back only on the system with the following marks.

MDLP MDLP

MDs recorded in MDLP Stereo mode cannot be played back on the system that does not support MDLP mode. You can add “LP:” at the beginning of a track title when you try to play the track on the system that does not support MDLP mode (page 23).

Tips

- LP4 Stereo mode (4× long time recording mode) achieves a long stereo recording time by use of a special compression system. When placing emphasis on sound quality, Stereo recording or LP2 Stereo recording (2× long time recording mode) is recommended.
- You can mix the recording mode in an MD.
- The selected recording mode is kept even after recording has finished. To change the recording mode, press REC MODE repeatedly.

Notes

- You cannot change the recording mode while recording pause or recording.
- Even if the recording mode is set to “MONO”, the sound from the speakers are output as recorded in the source (in stereo when recording the stereo source).

High-Speed CD-MD Synchro Recording

When using CD-MD Synchro Recording or when recording a CD in the programmed order, you can record at high speed (approximately four times the normal speed). Select the setting when using High-Speed CD-MD Synchro Recording (page 20).

If you cannot use High-Speed CD-MD Synchro Recording

When “Retry” flashes

A reading failure has occurred, and the system is trying to read the data again.

- If the retry was successful, the system continues with High-Speed CD-MD Synchro Recording.
- If the condition of the inserted CD or the system is poor, and retry fails, High-Speed CD-MD Synchro Recording is disabled. In this case, “NORM” flashes in the display and the MD deck automatically starts recording in normal CD-MD Synchro Recording. Note that monitoring of the recorded signal is not possible when this occurs.

Notes

- You cannot listen to the sound while recording.
- The following items are either inoperative or cannot be used during High-Speed CD-MD Synchro Recording:
 - The Auto Cut Function
 - The recording level specified in the Setup menu (The recording level is set to 0.0 dB)

Before you start editing

You can edit an MD only when:

- The MD is recordable.
- The MD play mode is normal play.

Check the following, before editing.

1 Check the tab of the MD to be edited.

Slide the tab to close the slot.

If the MD is protected, you cannot edit the MD.

2 Press PLAY MODE repeatedly until both “SHUF” and “PGM” disappear.

You can edit the MD only in normal play mode. You cannot edit the MD in Shuffle or Program Play mode.

To quit while editing

Press MENU/NO on the remote.

After editing

Press MD  to remove the MD or press I/⏻ (power) to turn off the system.

“TOC” or “STANDBY” starts flashing. The TOC is updated and editing is completed.

Before pulling out the mains lead

MD editing is completed when the MD Table of Contents (TOC) is updated. The TOC is updated when you eject the MD or press I/⏻ to turn off the system. Do not pull out the mains lead before updating the TOC or while updating the TOC (while “TOC” lights up or flashes) to ensure a complete editing.

Labelling an MD

— Name Function







You can create titles for your recorded MDs, tracks, and groups as follows.

During recording

During the CD-MD Synchro Recording, CD-TEXT information is recorded automatically.

To cancel recording the CD-TEXT information automatically, change the setting as follows.

Use the remote for the operation.

After pressing MD to switch the function to MD, press MENU/NO, press  or  repeatedly until “Setup?” appears, then press ENTER/YES. Press  or  repeatedly until “Txt Save On” appears, then press ENTER/YES. Again, press  or  repeatedly until “Txt Save Off” appears, then press ENTER/YES, then press MENU/NO. The factory setting is “ON”.

Note

Even when “Txt Save Off” is selected, the CD-TEXT information is recorded automatically depending on the disc.

After recording

Use Name Function. You can input a total of approximately 1,700 characters for the disc title, track titles and group titles on a single MD.

When labelling an MD recorded using the Group Function, be sure to label the disc with the Group Function on so as not to rewrite the group management information by mistake.

For details on the group management information, see page 18.

1 Press MD on the remote.

2 Perform the following procedure depending on what you want to label:

To label a track

Press ◀◀ or ▶▶ on the remote repeatedly until the desired track number appears, then press NAME EDIT/SELECT on the remote.

To label an MD

Press NAME EDIT/SELECT on the remote while the total number of tracks (or groups when the Group Function is on) is displayed.

To label a group

Press GROUP ON/OFF repeatedly until GROUP indicator lights up, then press GROUP SKIP repeatedly until the desired group appears. Press NAME EDIT/SELECT on the remote while the total number of tracks within the desired group is displayed.

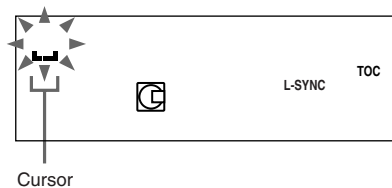

3 Press NAME EDIT/SELECT on the remote repeatedly to select the desired type of character.

Character type	Select
Alphabet (upper cases)/ blank space/symbols	Selected AB
Alphabet (lower cases)/ blank space/symbols	Selected ab
Numbers	Selected 12

4 Enter a character.

Character type	Do this
Alphabet	Press the corresponding letter button (or ◀◀/▶▶) on the remote repeatedly until the character to be entered flashes, then press CURSOR→ on the remote.
Numbers	Press the corresponding numeric buttons on the remote.
Blank space	Press 10/0 on the remote.
^ - / , . () : ! ?	Press 1 on the remote repeatedly.
& + < > _ = " ; # \$ % @ * `	Press 1 on the remote, then press ◀◀/▶▶ on the remote repeatedly.

5 Repeat steps 3 and 4 to enter the rest of the name.

6 Press ENTER/YES on the remote.

continued

Labelling an MD (continued)

To change the character

In step 3 or 4, press ←CURSOR or CURSOR→ repeatedly until the character to be changed flashes, press CLEAR on the remote to erase the character, then repeat steps 3 and 4.

To add a character

After steps 1 and 2, press ←CURSOR or CURSOR→ until the cursor comes to the point you want to add a character, then proceed to step 3.

Tip

You can label a track title during playback. The playback repeats until you finish labelling.

Note

If you enter the symbol “/” between the characters in disc titles such as “abc//def”, you may be unable to use the Group Function.

Checking the titles

To check the disc titles, press SCROLL on the remote in stop mode. To check the track title, press SCROLL on the remote during playback. The title appears scrolling in the display.

To check the group titles, press GROUP ON/OFF repeatedly in stop mode until GROUP indicator lights up, press GROUP SKIP repeatedly until the desired group appears, then press SCROLL on the remote.

To stop scrolling, press SCROLL on the remote. Press the button again to resume scrolling.

Erasing the titles

1 To erase group titles, press GROUP ON/OFF repeatedly in stop mode until GROUP indicator lights up.

2 Press MENU/NO on the remote in stop mode.

3 Press ◀◀ or ▶▶ on the remote repeatedly until “Nm Erase?” appears, then press ENTER/YES on the remote.

4 To erase disc titles

Press ◀◀ or ▶▶ on the remote repeatedly until “Nm Ers Disc” appears, then press ENTER/YES on the remote.

To erase track titles

Press ◀◀ or ▶▶ on the remote repeatedly until the desired track number appears, then press ENTER/YES on the remote.

To erase group titles

Press ◀◀ or ▶▶ on the remote repeatedly until the group number appears, press GROUP SKIP repeatedly until the desired group number appears, then press ENTER/YES on the remote. “Complete!” appears.

Note

You cannot erase the title of a group that does not have any tracks registered.

Registering recorded tracks into a new group

— Create Function

This function allows you to create a new group and register a track or consecutive tracks which are not yet registered into that group.

- 1** Press MD on the remote.
- 2** Press GROUP ON/OFF repeatedly until GROUP indicator lights up.
- 3** Press MENU/NO on the remote to display “Edit Menu”.
- 4** Press ◀◀ or ▶▶ on the remote repeatedly until “Gp Create?” appears, then press ENTER/YES on the remote.
- 5** Perform steps 3 to 6 of “Labelling an MD” on page 28.
- 6** Press ◀◀ or ▶▶ on the remote repeatedly until the first track number you want to register appears, then press ENTER/YES on the remote.
- 7** Press ◀◀ or ▶▶ on the remote repeatedly until the last track number you want to register appears, then press ENTER/YES on the remote. (When registering only one track, simply press ENTER/YES on the remote again without performing any other operations.)

To create a group without registering any tracks

In step 6, press ◀◀ or ▶▶ on the remote repeatedly until “None” appears, then press ENTER/YES on the remote.

Tip

You can also register tracks that were recorded on a system that does not support the Group Function.

Notes

- You cannot register the same track to multiple groups.
- When creating a group without registering any tracks, you must enter the group title.
- If you do not enter a group title in step 5, “Group ** (group number)” appears instead of the group title.

Releasing group registrations

— Release Function

These functions allow you to release group registrations simply by specifying the group for which you want to release the registrations. In addition, you can also release the group registrations of all tracks on an MD at once.

Releasing a single group

— Group Release Function

You can release the group registrations of all tracks within the specified group and erase that group. (However, note that the tracks are not erased.)

- 1** Press MD on the remote.
- 2** Press GROUP ON/OFF repeatedly until GROUP indicator lights up.
- 3** Press GROUP SKIP repeatedly until the desired group appears.
- 4** Press MENU/NO on the remote to display “Edit Menu”.
- 5** Press ◀◀ or ▶▶ on the remote repeatedly until “Gp Release?” appears, then press ENTER/YES on the remote.
“REL Gp** (selected group number)??” appears.
- 6** Press ENTER/YES on the remote.

Releasing the registrations of all tracks on an MD

— All Release Function

You can release the group registrations of all tracks on an MD at once.

- 1** Press GROUP ON/OFF repeatedly in stop mode until GROUP indicator lights up.
- 2** Press MENU/NO on the remote to display “Edit Menu”.
- 3** Press ◀◀ or ▶▶ on the remote repeatedly until “Gp All REL?” appears, then press ENTER/YES on the remote.
“All REL??” appears.
- 4** Press ENTER/YES on the remote.

Erasing recordings

— Erase Function

The MD deck lets you erase unwanted tracks quickly and easily.

You can restore the erased contents using the Undo function (page 38) immediately after the erasing. However, you cannot restore the erased contents after performing other editings. Before erasing, make sure if it is all right to erase the content.

The three options for erasing recordings are:

- Erasing a single track (Track Erase Function)
- Erasing all tracks (All Erase Function)
- Erasing a portion of a track (A-B Erase Function)

Erasing a single track

— Track Erase Function

When you erase a track, the total number of tracks on the MD decreases by one and all the tracks following the erased one are renumbered.

Example: Erasing track 2.

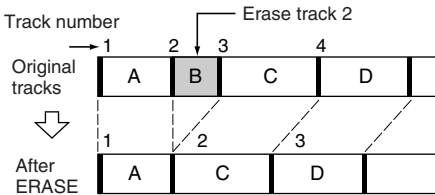

As the track numbers are renumbered as above, it is recommended to erase from the latter tracks when erasing several tracks, so as not to change the track numberings of unerased tracks.

- 1** Press MD on the remote.
- 2** Press MENU/NO on the remote to display "Edit Menu".
- 3** Press **◀◀** or **▶▶** on the remote repeatedly until "Tr Erase?" appears, then press ENTER/YES on the remote.
- 4** Press **◀◀** or **▶▶** on the remote repeatedly until the desired track number appears.
- 5** Press ENTER/YES on the remote.

Note

If you erase all the tracks within a group, the group itself is also erased.

continued

Erasing recordings (continued)

Erasing all tracks

— All Erase Function

You can erase all the contents recorded on an MD (the disc title, group titles, all recorded tracks and their titles) at once.

- 1** Press MD on the remote.
- 2** Press MENU/NO on the remote to display “Edit Menu”.
- 3** Press **◀** or **▶** on the remote repeatedly until “All Erase?” appears, then press ENTER/YES on the remote. “All Erase??” appears.
- 4** Press ENTER/YES on the remote again.

Note

If you perform the above operation when the Group Function is on, not only the tracks within the group, but all the tracks on the MD are erased.

Erasing a portion of a track

— A-B Erase Function

You can specify a portion within a track and erase the portion with ease. You can shift the desired portion by frame*, minute or second intervals.

This function is convenient to erase the unnecessary parts recorded from satellite broadcast or radio programs.

* 1 frame is 1/86 second.

Example: Erasing a portion of track 2.

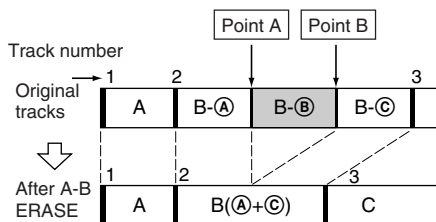

- 1** Press MD on the remote.
- 2** Press MENU/NO on the remote to display “Edit Menu”.
- 3** Press **◀** or **▶** on the remote repeatedly until “A-B Erase?” appears, then press ENTER/YES on the remote. Playback starts.
- 4** Press **◀** or **▶** on the remote repeatedly until the desired track number appears.
- 5** While monitoring the sound, press ENTER/YES on the remote at the starting point of the portion to be erased (point A).

“—Rehearsal—” and “Point A ok?” appear alternately while the deck repeats a few seconds of a portion before point A.

6 Press ENTER/YES on the remote if point A is correct.

“Point B set” appears and playback for setting the ending point of the portion to be erased (point B) starts.

If the point A is incorrect, press ◀◀ or ▶▶ on the remote repeatedly to find the starting point of the portion to be erased (point A) while monitoring the sound, then press ENTER/YES on the remote.

You can shift the point by 1/86 second (1 frame) intervals.*

* You can shift the point by 2-frame intervals (in Monaural mode and LP2 Stereo mode) or by 4-frame intervals (in LP4 Stereo mode).

7 Continue playback until the deck reaches point B, then press ENTER/YES on the remote.

“A-B Ers” and “Point B ok?” appear alternately and the deck repeats a portion of the few seconds before point A and after point B successively.

8 Press ENTER/YES on the remote if point B is correct.

If the point B is incorrect, press ◀◀ or ▶▶ on the remote repeatedly to find the ending point of the portion to be erased (point B) while monitoring the sound, then press ENTER/YES on the remote.

You can shift the point by 1/86 second (1 frame) intervals.*

* You can shift the point by 2-frame intervals (in Monaural mode and LP2 Stereo mode) or by 4-frame intervals (in LP4 Stereo mode).

Tip

To shift the point by minute or second intervals in steps 6 and 8, press ◀◀ or ▶▶ on the remote repeatedly to flash minute, second, or frame indication, then press ◀◀ or ▶▶ on the remote.

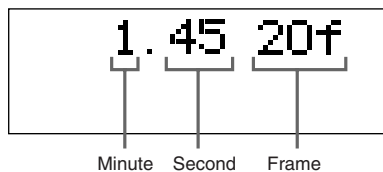

Moving recorded tracks

— Move Function

You can use this function to change the order of any track on the disc. When you move tracks, the tracks are automatically renumbered.

Example: Moving track 3 to position 2.

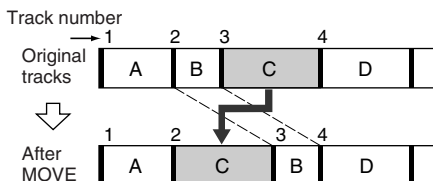

1 Press MD on the remote.

2 Press MENU/NO on the remote to display “Edit Menu”.

3 Press ◀◀ or ▶▶ on the remote repeatedly until “Move?” appears, then press ENTER/YES on the remote.

4 Press ◀◀ or ▶▶ on the remote repeatedly until the desired track number to move appears, then press ENTER/YES on the remote.

continued

Moving recorded tracks (continued)

- 5** Press **◀◀** or **▶▶** on the remote repeatedly until the new track position appears.

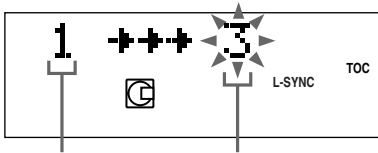

Original track number New track position

- 6** Press **ENTER/YES** on the remote.

Note

When you move a track to a track number that is registered into a group, the moved track is re-registered into the group. In addition, if you move a track that is registered into a group to a track number that is not registered into a group, the group registration of the moved track is released. However, when the Group Function is on, you can only move tracks within the selected group.

Dividing recorded tracks

— Divide Function

You can use this function to mark track numbers after recording. You can also use this function when recording from tapes or radio programs and track numbers are not marked automatically, and want to mark tracks. The total number of tracks increases by one and all the tracks following the divided ones are renumbered.

Example: Dividing track 2 into two tracks.

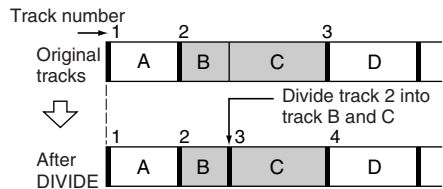

- 1** Press **MD** on the remote.
- 2** Press **MENU/NO** on the remote to display “Edit Menu”.
- 3** Press **◀◀** or **▶▶** on the remote repeatedly until “Divide?” appears, then press **ENTER/YES** on the remote. Playback starts.
- 4** Press **◀◀** or **▶▶** on the remote repeatedly until the desired track number to divide appears.
- 5** While monitoring the sound, press **ENTER/YES** on the remote at the point to be divided. “—Rehearsal—” appears and the portion to be divided is played repeatedly.

6 Press ENTER/YES on the remote again if the point to be divided is correct.

If the point to be divided is incorrect, press **◀◀** or **▶▶** on the remote to find the point to be divided, then press ENTER/YES on the remote.

You can shift the point by 1/86 second (1 frame) intervals.*

* You can shift the point by 2-frame intervals (in Monaural mode and LP2 Stereo mode) or by 4-frame intervals (in LP4 Stereo mode).

Tip

To shift the point by minute or second intervals in step 6, press **◀◀** or **▶▶** on the remote repeatedly to flash minute, second, or frame indication, then press **◀◀** or **▶▶** on the remote.

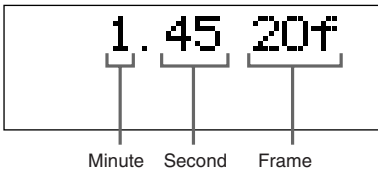

Note

If you divide a labelled track (page 28) into two tracks, only the first track retains the track title.

Example:

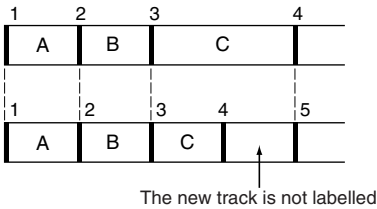

Combining recorded tracks

— Combine Function

You can use this function to combine 2 tracks into a single track. The total number of tracks decreases by one and all tracks following the combined ones are renumbered.

Example: Combining track 3 to track 1.

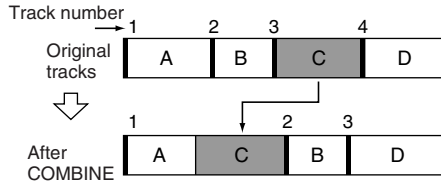

Example: Combining track 1 to track 4.

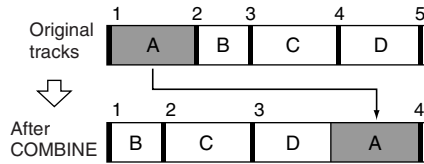

- 1** Press MD on the remote.
- 2** Press MENU/NO on the remote to display "Edit Menu".
- 3** Press **◀◀** or **▶▶** on the remote repeatedly until "Combine?" appears, then press ENTER/YES on the remote.

continued

Combining recorded tracks (continued)

- 4** Press **◀◀** or **▶▶** on the remote repeatedly until the first track number of the two to be combined appears, then press **ENTER/YES** on the remote.

For example, to combine track 1 to 4, select 4.



First track number

- 5** Press **◀◀** or **▶▶** on the remote repeatedly until the second track number of the two to be combined appears.

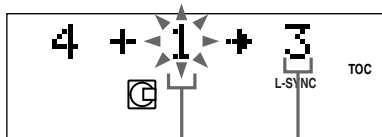

Second track number to be continued New track number

- 6** Press **ENTER/YES** on the remote.

Notes

- When you combine two tracks that are registered into different groups, the second track is re-registered into the group containing the first track. In addition, if you combine a track that is registered to a group with a track that is not registered to a group, the second track takes the same registration setting as the first track. However, when the Group Function is on, you can only combine tracks within the selected group.
- Tracks recorded in different recording modes (stereo, LP2, LP4 or MONO) cannot be combined.
- If both of the combined tracks have track titles, the title of the second track is erased.

Undoing the last edit

— Undo Function

You can use this function to cancel the last edit and restore the contents of the MD to the condition before the edit.

Note, however, that you cannot undo the edit if you do any of the following after the edit:

- Do another edit.
- Start recording.
- Update the TOC by turning off the system or ejecting the MD.
- Disconnect the power cord.

- 1** Press **MENU/NO** on the remote in stop mode to display “Edit Menu”.

- 2** Press **◀◀** or **▶▶** on the remote repeatedly until “Undo?” appears.

“Undo?” does not appear when there is no editing function that can be cancelled.

- 3** Press **ENTER/YES** on the remote.

Following message appears depending on the last edit.

Editing	Message
Labelling discs, tracks or groups	Name Undo?
Erasing the titles	
Creating a new group	
Releasing a group	Group Undo?
Releasing all groups	
Deleting all the tracks	
Deleting a track	Erase Undo?
Deleting a portion of a track	
Moving tracks	Move Undo?
Dividing a track	Divide Undo?
Combining tracks	Combine Undo?

- 4** Press **ENTER/YES** on the remote again.

Changing the recorded level after recording

— S.F Edit Function

You can change the volume of recorded tracks. The original track is recorded over at the new recording level. When changing the recording level, you can select Fade-in Recording to gradually increase the signal level at the start of recording, or Fade-out Recording to gradually decrease the signal level at the end of the recording.

Changing the overall recording level

- 1 Press MD on the remote.
- 2 Press MENU/NO on the remote to display “Edit Menu”.
- 3 Press ◀◀ or ▶▶ on the remote repeatedly until “S.F Edit?” appears, then press ENTER/YES on the remote.
- 4 Press ◀◀ or ▶▶ on the remote repeatedly until “Tr Level?” appears, then press ENTER/YES on the remote.
- 5 Press ◀◀ or ▶▶ on the remote repeatedly until the track number you want to change the recording level appears, then press ENTER/YES on the remote.
“Level 0dB” appears.

- 6 While monitoring the sound, press ◀◀ or ▶▶ on the remote repeatedly to change the recorded level.

The recording level can be changed from -12 dB to +12 dB, in 2 dB steps. Change to the optimum level while making sure that “OVER” does not appear in the display at the loudest portion.

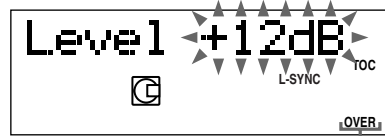

Adjust the level so as not to light up “OVER”

- 7 Press ENTER/YES on the remote.
“S.F Edit OK?” appears.
- 8 Press ENTER/YES on the remote again.
The deck starts recording over the existing track. “S.F Edit: ** %” appears while the track is being recorded. An amount of time that is roughly equal to or longer than the playback time of the track is required when recording over the track. When the recording finishes, “Complete!” appears.

continued

Changing the recorded level after recording (continued)

Fade-in and Fade-out Recording

- 1** Press MD on the remote.
- 2** Press MENU/NO on the remote to display “Edit Menu”.
- 3** Press ◀◀ or ▶▶ on the remote repeatedly until “S.F Edit?” appears, then press ENTER/YES on the remote.
- 4** Press ◀◀ or ▶▶ on the remote repeatedly until “Fade In?” or “Fade Out?” appears, then press ENTER/YES on the remote.
- 5** Press ◀◀ or ▶▶ on the remote repeatedly until the track number you want to change the recording level appears, then press ENTER/YES on the remote.
“Time 5.0s” appears.
- 6** While monitoring the sound, press ◀◀ or ▶▶ on the remote repeatedly to change the Fade-in or Fade-out recording time.
The system plays the portion that will be recorded over using Fade-in or Fade-out Recording. You can set the time at any value between 1.0 second and 15.0 seconds, in 0.1 second steps. You cannot set the time longer than the track.
- 7** Press ENTER/YES on the remote.
“S.F Edit OK?” appears.
- 8** Press ENTER/YES on the remote again.
The deck starts recording over the existing track. “S.F Edit: ** %” appears while the track is being recorded. When the recording finishes, “Complete!” appears.

Notes

- You cannot change the recording level of the tracks recorded in MDLP mode.
- Repeatedly changing the recording level results in poor sound quality.
- The recording level will not return to the exact original level once the recording level has been changed even if it returned to the original level.
- The recording level cannot be changed while the timer is activated.
- You cannot undo the S.F Edit Function even if you use the Undo Function.

Presetting radio stations

You can preset up to 20 FM stations and 10 AM stations. You can then tune in any of those stations simply by selecting the corresponding preset number.

There are two ways to store the station presets.

To	Method
Automatically tune in all of the stations that can be received in your area and then store them manually	Automatic Tuning Preset
Manually tune in and store the radio frequency of your favorite stations	Manual Tuning Preset

Setting presets through automatic tuning

- 1 Press **TUNER BAND** repeatedly to select “FM” or “AM”.
- 2 Press **TUNING MODE** repeatedly until “AUTO” appears in the display.
- 3 Turn **TUNING +/-** clockwise or counterclockwise.
The frequency changes as the system scans for a station. Scanning stops automatically when a station is tuned in. At that time, “TUNED” and “STEREO” (for stereo program only) appear.
If “TUNED” does not appear and the scanning does not stop
Set the frequency of the desired radio station as described in steps 2 and 3 of “Setting presets through manual tuning”.
- 4 Press **MENU/NO** on the remote.

- 5 Press **◀◀** or **▶▶** on the remote repeatedly until “Memory?” appears, then press **ENTER/YES**.

The preset number flashes.

- 6 Press **◀◀** or **▶▶** on the remote repeatedly to select the desired preset number.



Preset number

- 7 Press **ENTER/YES** on the remote.
- 8 Repeat steps 1 through 7 to preset other stations.

Tip

Press **TUNING MODE** when you want to stop scanning.

Setting presets through manual tuning

- 1 Press **TUNER BAND** repeatedly to select “FM” or “AM”.
- 2 Press **TUNING MODE** repeatedly until “AUTO” and “PRESET” disappear from the display.
- 3 Turn **TUNING +/-** clockwise or counterclockwise to tune in the desired station.
- 4 Press **MENU/NO** on the remote.
- 5 Press **◀◀** or **▶▶** on the remote repeatedly until “Memory?” appears, then press **ENTER/YES**.
The preset number flashes.
- 6 Press **◀◀** or **▶▶** on the remote repeatedly to select the desired preset number.



Preset number

continued

Presetting radio stations (continued)

7 Press ENTER/YES on the remote.

8 Repeat steps 1 through 7 to preset other stations.

Other Operations

To	Do this
Tune in a station with a weak signal	Follow the procedure described in "Setting presets through manual tuning".
Stop setting presets	Press MENU/NO on the remote.
Set another station to the existing preset number	Start over from step 1. After step 5, press ◀◀ or ▶▶ on the remote repeatedly to select the preset number you want to store the station.

To change the AM tuning interval (Except for European model)

The AM tuning interval is factory-preset to 9 kHz (or 10 kHz for some areas). To change the AM tuning interval, tune in any AM station first, then turn off the system. While holding REPEAT, press I/⏪. When you change the interval, all the AM preset stations are erased. To reset the interval, tune in any AM station first, then turn off the system. While holding REPEAT, press I/⏩.

Note

You cannot change the AM tuning interval in the Power Saving Mode.

Tips

- The preset stations are retained for about a day even if you disconnect the mains lead or if a power failure occurs.
- You can label the preset stations (page 43).
- To improve the reception, adjust the supplied antennas or connect a commercially available external antenna.

Listening to the radio

You can listen to a radio station either by selecting a preset station, or by manually tuning in the station.

Listening to a preset station

— Preset Tuning

Preset radio stations in the tuner's memory first (see "Presetting radio stations" on page 41).

- 1** Press TUNER BAND repeatedly to select "FM" or "AM".
- 2** Press TUNING MODE repeatedly until "PRESET" appears in the display.
- 3** Turn TUNING +/- clockwise or counterclockwise to select the desired preset station.

To select the desired preset number using the numeric buttons on the remote

Press numeric buttons instead of performing step 3.

To enter preset number 10 or higher, press >10 and the corresponding numeric buttons. To enter 0, press 10/0.

Example:

To enter preset number 20, press >10, then 2 and 10/0.

Listening to non-preset radio station

— Manual Tuning

- 1** Press TUNER BAND repeatedly to select “FM” or “AM”.
- 2** Press TUNING MODE repeatedly until “AUTO” and “PRESET” disappear from the display.
- 3** Turn TUNING +/- clockwise or counterclockwise to tune in the desired station.

Tips

- To improve broadcast reception, adjust the supplied antennas, or connect a commercially available external antenna.
- When an FM stereo program has static noise, press FM MODE repeatedly until “MONO” appears. There will be no stereo effect, but the reception will improve.
- Press TUNING MODE repeatedly until “AUTO” appears in step 2 above, then turn TUNING +/- . The frequency indication changes and scanning stops when the system tunes in a station (Automatic Tuning).
- To record the radio programs, use manual recording (pages 21 and 47).

Labelling the preset stations

— Station Name

You can label each preset station with up to 12 characters (Station Name).

- 1** Tune in the station you want to label (see “Listening to the radio” on page 42).
- 2** Press NAME EDIT/SELECT on the remote.

The cursor starts flashing.

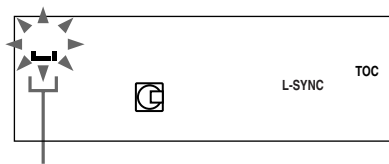

Cursor

- 3** Perform steps 3 to 6 of “Labelling a CD” (page 11).

To cancel

Press MENU/NO on the remote.

To erase the station name

- 1** Tune in the preset station you want to erase the station name.
- 2** Press NAME EDIT/SELECT on the remote.
- 3** Press CLEAR on the remote repeatedly to erase the name.
- 4** Press ENTER/YES on the remote.

Using the Radio Data System (RDS)

(European model only)

What is the Radio Data System?

Radio Data System (RDS) is a broadcasting service that allows radio stations to send additional information along with the regular program signal. RDS is available only on FM stations.*

Note

RDS may not work properly if the station you are tuned in is not transmitting the RDS signal properly or if the signal is weak.

* Not all FM stations provide RDS service, nor do they provide the same types of services. If you are not familiar with the RDS system, check with your local radio stations for details on RDS services in your area.

Receiving RDS broadcasts

Simply select a station from the FM band.

When you tune in a station that provides RDS services, the station name appears in the display.

To check the RDS information

Each time you press DISPLAY on the remote, the display changes cyclically as follows:

Station name* → Frequency → Clock display → BASS level → TREBLE level

* If the RDS broadcast is not properly received, the station name may not appear in the display.

Loading a tape

- 1 Press **▲** PUSH.
- 2 Load a recorded/recordable tape into the cassette holder.

With the side you want to play/record facing up

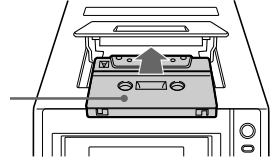

Playing a tape

You can use TYPE I (normal) tape.

- 1 Press **FUNCTION** repeatedly to switch the function to **TAPE**.
- 2 Press **DIRECTION** repeatedly to select “←” to play one side of a tape, “↔” to play both sides, or “↔”* to play both sides repeatedly.

* The tape deck stops automatically after repeating the sequence five times.

- 3 Press **TAPE** ◀▶.

Press **TAPE** ◀▶ again to play the bottom side.

Other operations

To	Do this
Stop play	Press TAPE ■ (or ■ on the remote).
Pause	Press II . Press again to resume play.
Fast-forward or rewind	Turn ◀▶ clockwise or counterclockwise (or press ◀◀ or ▶▶ on the remote).
Remove the tape	Press ▲ PUSH.

Recording your favorite CD tracks on a tape

— CD-TAPE Synchro Recording

You can record a whole CD on a tape.
You can use TYPE I (normal) tape.

- 1 Load a recordable tape.**
- 2 Load a CD you want to record.**
- 3 Press SYNCHRO repeatedly until “CD→TAPE SYNC” appears.**
- 4 Press ENTER/START.**

“Press START” flashes.
The tape deck stands by for recording and the CD player pauses for play.
“▶” lights up and the tape deck stands by for recording.
To start recording from the side facing away from you, press TAPE ◀▶ until “◀” lights up.
- 5 Press DIRECTION repeatedly until ⇄ appears to record on one side or ⇄ (or ⇄) to record on both sides.**

If you select both sides recording and the tape reaches the end of the front side part-way through a track, the entire track is recorded again from the beginning of the reverse side. If you start from the reverse side, recording stops at the end of the reverse side.
- 6 Press ENTER/START while “Press START” flashes.**

Recording starts.
When the recording is completed, the CD player, and the tape deck stop automatically.

To stop recording

Press TAPE ■.

Recording on an MD and a tape at the same time

Insert a recordable MD, then select “DUAL SYNC” in step 3.
Even if the MD or the tape ends part-way through the recording, the other continues recording.

To record only your favorite CD tracks

You can record only your favorite CD tracks using the Program Play. Between steps 2 and 3, perform steps 1 to 5 of “Programming CD tracks” (page 10).

Recording your favorite MD tracks on a tape

— MD-TAPE Synchro Recording

You can record a whole MD on a tape.

You can use TYPE I (normal) tape.

- 1 Load a recordable tape.**
- 2 Load a MD you want to record.**
- 3 Press SYNCHRO repeatedly until “MD→TAPE SYNC” appears.**
- 4 Press ENTER/START.**

“Press START” flashes.

The tape deck stands by for recording and the MD deck pauses for play.

“▶” lights up and the tape deck stands by for recording.

To start recording from the side facing away from you, press TAPE ◀▶ until “◀” lights up.
- 5 Press DIRECTION repeatedly until ⇄ appears to record on one side or ⇆ (or ⇄) to record on both sides.**

If you select both sides recording and the tape reaches the end of the front side part-way through a track, the entire track is recorded again from the beginning of the reverse side. If you start from the reverse side, recording stops at the end of the reverse side.
- 6 Press ENTER/START while “Press START” flashes.**

Recording starts.

When the recording is completed, the MD deck, and the tape deck stop automatically.

To stop recording

Press TAPE ■.

To record only your favorite MD tracks

You can record only your favorite MD tracks using the Program Play. Between steps 2 and 3, perform steps 1 to 5 of “Programming MD tracks” (page 15).

Note

When you use MD-TAPE Synchro Recording, cancel the Group Function.

Recording on a tape manually

— Manual Recording

You can record just the portions you like from a CD or an MD on a tape. You can also record a radio programme.

You can use TYPE I (normal) tape.

- 1 Load a recordable tape.**
- 2 Press FUNCTION repeatedly to select the desired source to record.**
 - CD: To record from this system's CD player.
 - MD: To record from this system's MD deck.
 - TUNER: To record from this system's tuner.
 - OPTICAL IN: To record from the optional component connected to the DIGITAL OPTICAL IN jack.
 - ANALOG IN: To record from the optional component connected to the ANALOG IN jacks.
- 3 Press TAPE ●REC.**

“▶” lights up and the tape deck stands by for recording.

To start recording from the side facing away from you, press TAPE ◀▶ until “◀” lights up.
- 4 Press DIRECTION repeatedly until ⇄ appears to record on one side or ⇄ (or ⇄) to record on both sides.**

If you start from the reverse side, recording stops at the end of the reverse side.
- 5 Press II, then start playing the desired source to record.**

To	Do this
Stop recording	Press TAPE ■.
Pause recording	Press II.

Adjusting the sound

Generating a more dynamic sound (Dynamic Sound Generator)

Press DSG.

To cancel the DSG, press DSG again.

Adjusting the bass

Turn BASS.

You can adjust the bass in 9 steps.

Adjusting the treble

Turn TREBLE.

You can adjust the treble in 9 steps.

Adjusting the bass and treble using the remote

- 1** Press BASS/TRE on the remote repeatedly to select “BASS” or “TREBLE”.
- 2** While “BASS” or “TREBLE” appears, press ◀◀ or ▶▶ on the remote repeatedly to adjust the level.

Falling asleep to music

— Sleep Timer

You can set the system to turn off after a certain time, so that you can fall asleep to music.

Press SLEEP on the remote.

Each time you press the button, the minute display (the turn-off time) changes cyclically as follows:

SLEEP OFF → AUTO* → 90min → 80min
→ ... → 10min

* The system automatically turns off in 100 minutes or after the current CD, MD or tape finishes playing.

To	Press
Check the remaining time**	SLEEP on the remote once.
Change the time to turn off	SLEEP on the remote to select the time you want.
Cancel the Sleep Timer Function	SLEEP on the remote repeatedly until "SLEEP OFF" appears.

** You cannot check the remaining time if you select "AUTO".

Note

Do not set to "AUTO" during Synchro Recording on an MD or a tape.

Waking up to music

— Daily Timer

You can wake up to music at a preset time. Make sure you have set the clock (see "Setting the clock" on page 8).

1 Prepare the sound source you want to play.

- CD: Load a CD. To start from a specific track, make a program (see "Programming CD tracks" on page 10).
- MD: Load an MD. To start from a specific track, make a program (see "Programming MD tracks" on page 15).
- Tape: Load a tape.
- Radio: Tune in the preset radio station (see "Listening to the radio" on page 42).

2 Press VOLUME + or – on the remote to adjust the volume.

3 Press CLOCK/TIMER SET on the remote to display "DAILY SET".

4 Press ENTER/YES on the remote. "ON" appears and the hour indication flashes.

5 Set the time to start playing.

Press ◀◀ or ▶▶ on the remote repeatedly to set the hour, then press ENTER/YES on the remote.

The minute indication flashes.

Press ◀◀ or ▶▶ on the remote repeatedly to set the minute, then press ENTER/YES on the remote.

"OFF" appears and the hour indication flashes again.

6 Set the time to stop playing following the same procedure as step 5.

7 Press ◀◀ or ▶▶ on the remote repeatedly until the desired sound source appears.

Each time you press the button, the indication changes cyclically as follows:

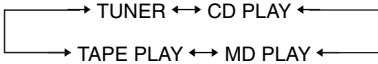

8 Press ENTER/YES on the remote.

The start time, the stop time, and the sound source appear in turn, before the original display returns.

9 Press I/⏻ to turn off the system.

Other operations

To	Do this
Check the settings/ activate the timer	<p>1 Press CLOCK/TIMER SELECT on the remote, then press ◀◀ or ▶▶ on the remote until “DAILY SELECT” appears.</p> <p>2 Press ENTER/YES on the remote.</p>
Change the setting	Start over from step 1. If you made a mistake, press ◀—CURSOR in step 5 to 7 to select the setting you want to change, then change the setting.
Cancel the timer	<p>1 Press CLOCK/TIMER SELECT on the remote, then press ◀◀ or ▶▶ on the remote until “TIMER OFF?” appears.</p> <p>2 Press ENTER/YES on the remote.</p>

Notes

- You cannot activate the Daily Timer and recording timer at the same time.
- If you use the Daily Timer and the Sleep timer at the same time, the Sleep Timer has priority.
- Do not operate the system from the time the system turns on until the play starts (about 30 seconds before the preset time).
- If the system is on about 30 seconds before the preset time, the Daily Timer will not be activated.
- You cannot use the optional component connected to ANALOG IN jacks or DIGITAL OPTICAL IN jack as the sound source for Daily Timer.

Timer recording radio programs

To timer record, you must first preset the radio station (see “Presetting radio stations” on page 41) and set the clock (see “Setting the clock” on page 8).

1 Tune in the preset radio station (see “Listening to the radio” on page 42).

2 Press CLOCK/TIMER SET on the remote.

3 Press ◀◀ or ▶▶ on the remote repeatedly to select “MD REC SET” or “TAPE REC SET”, then press ENTER/YES on the remote.

“ON” appears and the hour indication flashes.

4 Set the time to start recording.

Press ◀◀ or ▶▶ on the remote repeatedly to set the hour, then press ENTER/YES on the remote.

The minute indication flashes.

Press ◀◀ or ▶▶ on the remote repeatedly to set the minute, then press ENTER/YES on the remote.

“OFF” appears and the hour indication flashes again.

5 Set the time to stop recording following the same procedure as step 4.

6 When you record on an MD, press ◀◀ or ▶▶ on the remote repeatedly to select the recording mode (e.g., LP2), then press ENTER/YES on the remote.

The timer recording settings appear, then the original display returns.

7 Load a recordable MD or tape.

8 Press I/⏻ to turn off the system.

continued

**Timer recording radio programs
(continued)**

Other operations

To	Do this
Check the settings/ activate the timer	<p>1 Press CLOCK/TIMER SELECT on the remote, then press ◀◀ or ▶▶ on the remote until “MD REC?” or “TAPE REC?” appears.</p> <p>2 Press ENTER/YES on the remote.</p>
Change the setting	Start over from step 1.
Cancel the timer	<p>1 Press CLOCK/TIMER SELECT on the remote, then press ◀◀ or ▶▶ on the remote until “TIMER OFF?” appears.</p> <p>2 Press ENTER/YES on the remote.</p>

Tip

When you record from the radio, the station name (or the frequency when the station is not labelled. See page 43) is recorded on an MD together with the start time and the stop time.

Notes

- You cannot activate the Daily Timer and recording timer at the same time.
- If you use the recording timer and the Sleep Timer at the same time, the Sleep Timer has priority.
- Do not operate the system from the time the system turns on until the recording starts (about 30 seconds before the preset time).
- If the system is on about 30 seconds before the preset time, the timer-recording will not be activated.
- The volume is reduced to minimum during recording.
- When you record on an MD, if timer recording is set with the Group Function on but no group is specified, the material is recorded into a new group.

Turning off the display

— Power Saving Mode

Even if the system is off, the system consumes power to display the clock and to stay responsive to commands from the remote. Power saving mode reduces the amount of power consumed during standby.

In this mode, the clock is not displayed.

Press DISPLAY on the remote repeatedly while the system is off until the clock display disappears.

To cancel Power Saving Mode

Press DISPLAY while the system is off. Each time you press the button, the display switches as follows:

Clock display* ↔ No display (Power Saving Mode)

* When the clock is not set, “--:--” appears.

Tip

The timer continues to operate in Power Saving Mode.

Using the display

Checking the remaining time/titles (CD/MD)

When a CD TEXT disc is loaded, you can check the information stored on the disc, such as the titles. When the unit detects CD TEXT discs, the "TEXT" indication appears in the display.

Press DISPLAY on the remote during playback.

Each time you press the button, the display changes cyclically as follows:

■ When playing a CD

Current track number and the playing time →
Current track number and the remaining time →
Remaining time of the disc → Track title*¹
→ Clock display → BASS level → TREBLE level

■ When playing an MD

Current track number and the playing time →
Current track number and the remaining time →
Remaining time of the MD*² → Track title*³ → Clock display → BASS level → TREBLE level

*¹ With CD TEXT discs only (certain characters cannot be displayed). Depending on the disc, some CD TEXT information may not appear. When the CD contains more than 20 tracks, CD TEXT is not displayed from track 21 on.

*² When the Group Function is on, the remaining time of all tracks in the group is displayed.

*³ Only when the track is labelled.

Checking the total playing time/titles (CD/MD)

Press DISPLAY on the remote in stop mode.

Each time you press the button, the display changes cyclically as follows:

■ When a CD is in stop mode

Total number of tracks and the total playing time → Disc title*⁴ → Clock display → BASS level → TREBLE level

■ When an MD is in stop mode

Total number of tracks and the total playing time*⁵ → Remaining recordable time (recordable MD only) → Disc title*⁶ → Clock display → BASS level → TREBLE level

*⁴ Only with CD TEXT discs or when the CD is labelled (certain characters cannot be displayed). Depending on the disc, some CD TEXT information may not appear.

*⁵ When the Group Function is on, the total number of groups (when no group is selected) or the total number of tracks and the total playing time within the group (when a group is selected) are displayed. "----" appears when the total playing time of the MD exceeds 1,000 minutes.

*⁶ Only when the disc is labelled. When the Group Function is on, the group title is displayed.

continued

Using the display (continued)

Checking the station name (TUNER)

Press DISPLAY on the remote.

Each time you press the button, the display changes cyclically as follows:

Station name*⁷ → Preset number and frequency → Clock display → BASS level → TREBLE level

*⁷ Only when the preset station is labelled.

To scroll a long name

Press SCROLL on the remote.

Tips

- To label a CD, see “Labelling a CD” on page 11.
- To label a disc, tracks, and groups on an MD, see “Labelling an MD” on page 28.
- To label the preset stations, see “Labelling the preset stations” on page 43.

Hooking up optional components

To enhance your system, you can connect optional components. Refer to the operating instructions provided with each component.

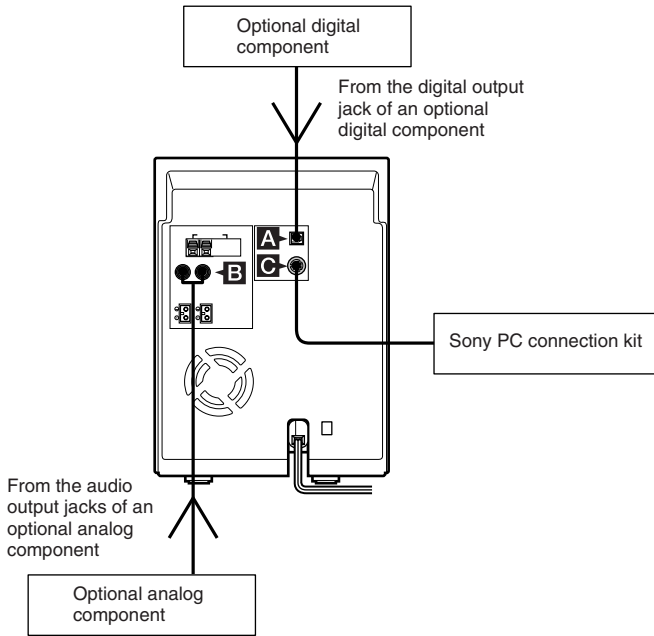

A DIGITAL OPTICAL IN jack

Use a digital optical cable (square, not supplied) to connect an optional digital component (digital satellite receiver, etc.) to this jack. You can then listen to the sound from the component.

B ANALOG IN jacks

Use audio cords (not supplied) to connect an optional analog component (cassette deck, etc.) to these jacks. You can then listen to the sound from the component.

C PC LINK jack

Use an Sony PC connection kit (not supplied) that supports this system to connect the personal computer.

Listening to audio from a connected component

Listening to a digital component such as a digital satellite receiver, etc.

1 Connect the digital optical cable.

See “Hooking up optional components” on page 53.

2 Press FUNCTION repeatedly until “OPTICAL IN” appears.

Start playing the connected component.

Listening to an analog component such as a cassette deck

1 Connect audio cords.

See “Hooking up optional components” on page 53.

2 Press FUNCTION repeatedly until “ANALOG IN” appears.

Start playing the connected component.

Recording audio from a connected component

Making a digital recording from a digital component

The Serial Copy Management system (page 64) may prevent you from making a digital recording of certain material. In this case, connect the component to ANALOG IN jacks and make an analog recording.

1 Connect the digital optical cable.

2 Start recording manually.

See “Recording on an MD manually” (page 21) or “Recording on a tape manually” (page 47).

Tips

- You can activate Time Machine Recording (page 22) and Smart Space/Auto Cut functions (page 25).
- You can adjust the recording level when recording on an MD (page 25).

Making an analog recording from an analog component

1 Connect the audio cords.

2 Start recording manually.

See “Recording on an MD manually” (page 21) or “Recording on a tape manually” (page 47).

Problems and remedies

Should you encounter a problem with your system, do the following:

- 1 Make sure the power cord and speaker cords are correctly and firmly connected.
- 2 Find your problem in the troubleshooting checklist below and take the indicated corrective action.

If the problem persists after doing all of the above, consult your nearest Sony dealer.

General

“--:--” appears in the display.

- A power interruption has occurred. Set the clock (see page 8) and timer settings (see pages 48 and 49) again.

There is no sound.

- Turn VOLUME clockwise (or press VOLUME + on the remote).
- Make sure the headphones are not connected.
- Check the speaker connections (see page 7).
- High-Speed CD-MD Synchro Recording is underway.

Sound comes from one channel, or unbalanced left and right volume.

- Place the speakers as symmetrically as possible.
- Connect the supplied speakers.

There is severe hum or noise.

- Move the system away from the source of noise.
- Connect the system to a different mains.
- Install a noise filter (commercially available) to the mains line.

The timer cannot be set.

- Set the clock again (see page 8).

The timer does not function.

- Press CLOCK/TIMER SELECT on the remote to set the timer and light up “⊖DAILY” or “⊖REC” in the display (see pages 49 and 50).
- Check the timer setting and set the correct time (see pages 48 and 49).
- Cancel the Sleep Timer Function (see page 48).

The remote does not function.

- Remove the obstacle.
- Move the remote closer to the system.
- Point the remote at the system’s sensor.
- Replace the batteries (R6/size AA).
- Locate the system away from the fluorescent light.

CD Player

The disc tray does not open and “LOCKED” appears on the front panel display.

- Contact your Sony dealer or local authorized Sony service facility.

The disc tray does not close.

- Place the disc correctly in the center of the tray.
- Always close the tray by pressing CD ▲. Trying to press the tray closed with your fingers may cause problems with the player.

The disc does not eject.

- You cannot eject the disc during CD Synchro Recording. Press CD ■ to cancel the CD Synchro Recording, then press CD ▲ to eject the disc.
- Consult your nearest Sony dealer.

Play does not start.

- Open the disc tray and check whether a disc is loaded.
- Wipe the disc clean (see page 62).
- Replace the disc.
- Place the disc correctly in the center of the tray.
- Place the disc in the tray with the label side up.
- Remove the disc and wipe away the moisture on the disc, then leave the system turned on for a few hours until the moisture evaporates.
- Press CD ►|| (or ► on the remote) to start play.

The sound skips.

- Wipe the disc clean (see page 62).
- Replace the disc.
- Try moving the system to a place without vibration (e.g., on top of a stable stand).
- Try moving the speakers away from the system, or placing them on separate stands. When you listen to a track with bass sounds at high volume, the speaker vibration may cause the sound to skip.

Play does not start from the first track.

- Press PLAY MODE repeatedly until both “PGM” and “SHUF” disappear to return to normal play.

continued

Problems and remedies (continued)

MD Deck

An MD cannot be inserted.

- Insert the MD with the label side up and the arrow pointing toward the deck.

The controls do not work.

- Replace the MD with a new one.
- Retry the operations after “TOC” or “STANDBY” turns off.

Play does not start.

- Replace the MD.
- Insert the MD and leave the system turned on for a few hours until the moisture evaporates.
- Press MD ►|| (or ► on the remote) to start play.
- Press GROUP ON/OFF until GROUP indicator turns off to cancel the Group Function.

The sound skips.

- Replace the MD.
- Try moving the system to a place without vibration (e.g., on top of a stable stand).
- Try moving the speakers away from the system, or placing them on separate stands.
When you listen to a track with bass sounds at high volume, the speaker vibration may cause the sound to skip.
- Insert the disc and wait for 10 to 20 minutes with the system turned on.

Play does not start from the first track.

- Press PLAY MODE repeatedly until both “PGM” and “SHUF” disappear to return to normal play.

“OVER” appears.

- You have reached the end of the MD during playing pause. Turn ◀◀/▶▶ counterclockwise (or press ◀◀ or ▶▶ on the remote) to return to the desired playing position.

“OVER” lights up during recording.

- Adjust the recording level lower (see page 25).

Recording or editing was done, but the TOC is not updated.

- MD recording and editing contents are recorded to the MD when the MD is removed, so make sure you remove the MD after recording or editing (see pages 17 and 28).
- Start recording again.

Recording is not possible.

- Remove the MD and slide the tab to close the slot (see page 17).
- Connect the optional component properly (see page 53).
- Replace with a recordable MD.
- Press FUNCTION repeatedly to select the recording source correctly.
- Replace the MD with a recordable MD, or use the Erase Function to erase unnecessary tracks (see page 33).
- Start recording again.

High-Speed CD-MD Synchro Recording is not possible and the MD deck automatically starts recording in normal CD-MD Synchro Recording.

- Replace the MD.
- Move the system to a stable place.

The sound from an MD you recorded is too low (or too high).

- Readjust the recording level (see page 25).

Crosstalk during LP4 Stereo recording.

- When recording the sound of a CD, tape or optional component whose sound is recorded on only one channel (left or right), the sound may leak to the other channel during LP4 Stereo recording. Record in stereo or LP2 Stereo.

Tape Deck

The tape does not record or play, or there is a decrease in sound level.

- The heads are dirty. Clean them.
- The record/playback heads are magnetised. Demagnetise them (see page 62).

The tape does not erase completely.

- The record/playback heads are magnetised. Demagnetise them (see page 62).

There is excessive wow or flutter, or the sound drops out.

- The capstans in the tape deck are dirty. Clean them using a cleaning cassette (see page 62).

Noise increases or the high frequencies are erased.

- The record/playback heads are magnetised. Demagnetise them (see page 62).

The tape does not record.

- No cassette is loaded. Load a cassette.
 - The tab has been removed from the cassette. Cover the broken tab with adhesive tape (see page 62).
 - The tape has wound to the end.
-

Optional components

There is no sound.

- Refer to General item “There is no sound.” on page 55 and check the condition of the system.
 - Connect the component properly (see page 53) while checking:
 - if the cords are connected properly.
 - if the cord plugs are firmly inserted all the way.
 - Turn on the connected component.
 - Refer to the operating instructions supplied with the connected component and start playing.
 - Press FUNCTION repeatedly to select “OPTICAL IN” or “ANALOG IN”.
-

The sound is distorted.

- Set the volume of the connected component lower.
-

Tuner

Severe hum or noise/stations cannot be received.

- Set the proper band and frequency (see page 41).
 - Connect the antenna properly (see page 7).
 - Find a place and an orientation that provide good reception, then set up the antenna again. If you cannot obtain good reception, we recommend you connect a commercially available external antenna.
 - The supplied FM lead antenna receives signals along its entire length, so make sure you extend it fully.
 - Locate the antennas as far away from the speaker cords as possible.
 - Consult your nearest Sony dealer if the supplied AM antenna has come off the plastic stand.
 - Try turning off surrounding electrical equipments.
-

A stereo FM program cannot be received in stereo.

- Press FM MODE until “STEREO” appears in the display.
-

Cyclical static noise is heard while recording on an MD.

- Adjust the antenna orientation and position until the noise stops.
-

If the system still does not operate properly after performing the above measures, reset the system as follows:

- 1 Disconnect the mains lead.
- 2 Reconnect the mains lead.
- 3 Press I/⏻ to turn on the system.
- 4 Press ■ (for TAPE), ENTER/START and I/⏻.

The system is reset to the factory settings. All the settings you made, such as the preset stations, clock, and timer are cleared and must be set again.

Self-diagnosis display

This system has a Self-diagnosis display function to let you know if there is a system malfunction. The display shows a code made up of three or five letters and a message alternately to show you the problem. To solve the problem refer to the following list. If any problem persists, consult your nearest Sony dealer.

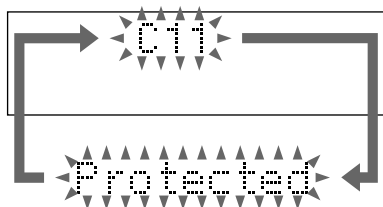

C11/Protected

The MD is protected against erasure.

→Remove the MD and slide the tab to close the slot (see page 17).

C12/Cannot Copy

You tried to record a CD with a format that the system does not support, such as a CD-ROM.

→Remove the disc and turn off the system once, then turn it on again.

C13/REC Error

Recording could not be performed properly.

→Move the system to a stable place, and start recording over from the beginning.

The MD is dirty or scratched, or the MD does not meet the standards.

→Replace the MD and start recording over from the beginning.

C13/Read Error

The MD deck cannot read the disc information properly.

→Remove the MD once, then insert it again.

C14/TOC Error

The MD deck cannot read the disc information properly.

→Replace the MD.

→Erase all the recorded contents of the MD using the All Erase Function (see page 34).

C41/Cannot Copy

The sound source is a copy of a commercially available music software or CD-R.

→The Serial Copy Management System prevents making a digital copy (see page 64). In addition, you cannot copy from a CD-R.

C71/Check OPT-IN

No component is connected to the DIGITAL OPTICAL IN jack, or you tried to record from the digital component which is not connected correctly.

→Connect the optional digital component correctly to the DIGITAL OPTICAL IN jack using the digital optical cable (not supplied) (see page 53).

The power of the connected component is not turned on.

→Check if the power of the connected digital component is on. Refer to the operating instructions supplied with the component.

The digital optical cable is disconnected, or the power of the connected component is turned off while recording the digital audio from the component connected to the DIGITAL OPTICAL IN jack.

→Connect the digital optical cable, or turn on the power of the connected component.

E0001/MEMORY NG

The component has internal problem.

→Consult your nearest Sony dealer.

E0101/LASER NG

There is a problem with the laser pickup.

→The laser pickup may be damaged. Consult your nearest Sony dealer.

E0201/LOADING NG

There is a problem with the loading.

→Consult your nearest Sony dealer.

Messages

One of the following messages may appear or flash in the display during operation.

MD

Assign None

All the tracks on an MD are registered into groups.

Auto Cut

The MD deck is pausing the recording because silence continued for 30 seconds or more during digital recording (see page 25).

Blank Disc

The inserted recordable MD is new, or all tracks on the MD have been erased.

Cannot Edit

- A pre-mastered MD is in the deck.
 - You tried to edit in Program or Shuffle Play mode.
 - The track is recorded in MDLP mode.
-

Cannot REC

- A pre-mastered MD is in the deck.
 - The function is switched to MD.
-

Cannot SYNC!

- There is no disc in the MD deck, or the MD is protected against erasure (see page 17).
 - There is no time remaining on the MD.
-

Complete!

The editing operation of the MD is completed.

Disc Full!

There is no time remaining on the MD.

Eject

The MD deck is ejecting the MD.

Group Full!

An attempt was made to create a new group in excess of the maximum number of groups, or there are insufficient characters for updating the group management information.

Impossible

- You tried to make an impossible editing operation.
- You cannot combine or erase the tracks due to the system limitations of MDs.

Incomplete!

Adjustment of the recording level after recording or Fade-in and Fade-out procedures have failed since the system was either subject to vibration or there is a damaged or dirty disc in the tray.

Initialize

The power was off for a long time, so the system is initializing itself.

Name Full

There is no more space to store track, disc or group titles.

No Change

While attempting to change the recording level after recording, you pressed ENTER/YES on the remote without actually changing the recording level, so no change was made.

No Disc

There is no disc in the MD deck.

OVER

You have reached the end of the MD while turning ◀◀/▶▶ clockwise (or pressing ▶▶ on the remote) during playback or playing pause.

Push STOP!

You pressed PLAY MODE during play.

—Rehearsal—

The MD is playing the specified point for confirmation during the A-B Erase Function and the Divide Function (pages 34 and 36).

Retry

A reading failure has occurred, and the system is trying to read the data again.

S.F Edit!

You attempted to perform another operation while in S.F Edit (changing the recording level after recording, Fade-in, Fade-out) mode.

S.F Edit NOW

You pressed I/⏻ while in S.F Edit (changing the recording level after recording, Fade-in, Fade-out) mode.

continued

Self-diagnosis display (continued)

Smart Space

The signal was input again after silence continued for 3 or more but less than 30 seconds during digital recording, and the silence was cut to 3 seconds.

Step Full!

You tried to program 26 or more tracks (steps).

TOC Reading

The MD deck is reading the TOC information of the MD.

TOC Writing

The MD deck is writing the information of recorded or edited contents.

Track End

You have reached the end of the track while adjusting the dividing point during the Divide Function.

Tr Protected

You attempted to erase a protected track.

CD

No Disc

There is no CD in the player.

OVER

You have reached the end of the CD while turning ◀◀/▶▶ clockwise (or pressing ▶▶ on the remote) during play or pause.

Push STOP!

You pressed PLAY MODE during play.

Step Full!

You tried to program 26 or more tracks (steps).

TAPE

Cannot SYNC!

There is no tape in the tape deck, or the tab has been removed from the cassette.

No Tab

You cannot record the tape because the tab has been removed from the cassette.

No Tape

There is no tape in the tape deck.

Precautions

On operating voltage

Before operating the system, check that the operating voltage of your system is identical with the voltage of your local power supply.

On safety

- The unit is not disconnected from the AC power source (mains) as long as it is connected to the wall outlet, even if the unit itself has been turned off.
- Unplug the system from the wall outlet (mains) if it is not to be used for an extended period of time. To disconnect the power cord (mains lead), pull it out by the plug. Never pull the cord itself.
- Should any solid object or liquid fall into the system, unplug the system and have it checked by qualified personnel before operating it any further.
- AC power cord must be changed only at the qualified service shop.
- When you connect the mains lead to the mains, even if the power is off, the system begins charging for remote and timer functions. Therefore the surface of this unit become warm, this is normal.

On placement

- If you raise the volume during use, the system fan turns on automatically to prevent heat build-up in the system. To ensure efficient heat radiation, leave sufficient space to the rear, and do not place anything on the top of the system.
- Place the system in a location with adequate ventilation to prevent heat build up.
- Do not place the system in an inclined position.
- Do not place the system in locations where it is;
 - Extremely hot or cold
 - Dusty or dirty
 - Very humid
 - Subject to vibrations
 - Subject to direct sunlight.
- Use caution when placing the unit or speakers on surfaces that have been specially treated (with wax, oil, polish, etc.) as staining or discoloration of the surface may result.

On heat buildup

- Although the system heats up during operation, this is not a malfunction.
- Place the system in a location with adequate ventilation to prevent heat build-up in the system.

If you continuously use this system at a large volume, the cabinet temperature of the top, side and bottom rises considerably. To avoid burning yourself, do not touch the cabinet.

To prevent a malfunction, do not cover the ventilation hole for the cooling fan.

On operation

- If the system is brought directly from a cold to a warm location, or is placed in a very damp room, moisture may condense on the lens inside the CD player. Should this occur, the system will not operate properly. Remove the disc and leave the system turned on for about an hour until the moisture evaporates.
- When you move the system, take out any disc.

If you have any questions or problems concerning your system, please consult your nearest Sony dealer.

On the speaker system

This speaker system is not magnetically shielded and the picture on TV sets may become magnetically distorted. In such a case, turn off the power of the TV set, and after 15 to 30 minutes turn it on again.

If there seems to be no improvement, locate the speaker system further away from the TV set. Also, be sure not to place objects in which magnets are attached or used near the speaker system, such as audio racks, TV stands, and toys. These may cause magnetic distortion to the picture due to their interaction with the system.

Notes on MDs

- Do not open the shutter to expose the MD. Close the shutter immediately if the shutter opens.
- Affix the label supplied with the disc only to the specified label indentation. Do not affix the label around the shutter or in other locations. Note that the shape of the indentation depends on the disc.

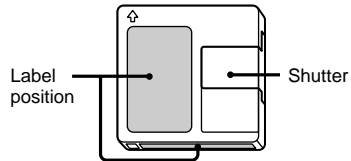

- Wipe the disc cartridge with a dry cloth to remove dirt.
- Do not expose the MD to direct sunlight or heat sources such as hot air ducts, nor leave it in a car parked in direct sunlight.

continued

Precautions (continued)

Notes on CDs

- Before playing, clean the CD with a cleaning cloth. Wipe the CD from the center out.
- Do not use solvents such as benzene, thinner, commercially available cleaners or anti-static spray intended for vinyl LPs.
- Do not expose the CD to direct sunlight or heat sources such as hot air ducts, nor leave it in a car parked in direct sunlight.
- Do not use a CD encircled with a protection ring. This may cause a malfunction to the system.
- When using a CD that have glue or similar tacky substance on the label side of the CD or that used a special ink when the label was printed, there is a chance that the CD or label may become attached to parts inside this unit. When this occurs, it may not be possible to remove the CD, and may also cause this unit to malfunction. Be sure to check that the label side of the CD is not sticky before using.
The following types of disc should not be used:
 - Rental or used CD with attached seals where the glue extends beyond the seal. The perimeter of the seal on the CD is tacky.
 - CDs that have labels printed using a special ink that feels tacky when touched.
- CDs with non-standard shapes (e.g., heart, square, star) cannot be played on this unit. Attempting to do so may damage the unit. Do not use such CDs.

Note on CD-R/CD-RW playback

Discs recorded on CD-R/CD-RW drives may not be played back because of scratches, dirt, recording condition or the drive's characteristics. Besides, the discs, which are not yet finalized at the end of recording, cannot be played back.

Cleaning the cabinet

Clean the cabinet, panel and controls with a soft cloth slightly moistened with mild detergent solution. Do not use any type of abrasive pad, scouring powder or solvent such as thinner, benzene or alcohol.

To save a tape permanently

To prevent a tape from being accidentally recorded over, break off the cassette tab from side A or B as illustrated.

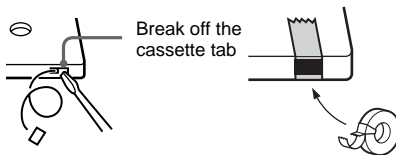

If you later want to reuse the tape for recording, cover the broken tab with adhesive tape.

Before placing a cassette in the tape deck

Take up any slack in the tape. Otherwise, the tape may get entangled in the parts of the tape deck and become damaged.

When using a tape longer than 90 minutes

The tape is very elastic. Do not change the tape operations such as play, stop, and fast-winding frequently. The tape may get entangled in the tape deck.

Cleaning the tape heads

Clean the tape heads after every 10 hours of use. Be sure to clean the tape heads before you start an important recording or after playing an old tape. Use a separately sold dry-type or wet-type cleaning cassette. For details, refer to the instructions of the cleaning cassette.

Demagnetising the tape heads

Demagnetise the tape heads and the metal parts that have contact with the tape after every 20 to 30 hours of use with a separately sold demagnetising cassette. For details, refer to the instructions of the demagnetising cassette.

System limitations of MDs

The recording system in your MD deck has the limitations described below.

Note, however, that these limitations are due to the inherent nature of the MD recording system itself, not to mechanical causes.

“Disc Full!” appears before the MD has reached the maximum recording time

When 255 tracks have been recorded on the MD, “Disc Full!” appears regardless of the total recorded time. More than 255 tracks cannot be recorded on the MD. To continue recording, erase unnecessary tracks or use another recordable MD.

“Disc Full!” appears before the maximum number of tracks (255) is reached

Fluctuations in emphasis within tracks are sometimes interpreted as track intervals, increasing the track count and causing “Disc Full!” to appear.

“Group Full!” appears in the display

- When the Group Function is on, “Group Full!” may be displayed if editing is performed. This means there are insufficient characters for group management. Delete any unnecessary disc titles, group titles or other characters.
- Even when the Group Function is off, the group management information is updated automatically when Move, Divide and other editing operations are performed, so “Group Full!” may be displayed.

The remaining recording time does not increase even after erasing numerous short tracks

Tracks shorter than 12 seconds* are not counted, so erasing them may not increase the recording time.

* During Stereo recording.

- In Monaural or LP2 Stereo mode: about 24 seconds
- In LP4 Stereo mode: about 48 seconds

“Impossible” appears when you use A-B Erase Function or Combine Function

This happens when you have edited the same track many times. This is due to a technical limitation of the MD system and is not a mechanical error.

The total recorded time and the remaining time on the MD do not add up to the maximum recording time

Recording is done in minimum units of 2 seconds* each, no matter how short the material. The recorded contents may be shorter than the maximum recording capacity. Disc space may also be reduced by scratches.

* During Stereo recording.

- In Monaural or LP2 Stereo mode: about 4 seconds
- In LP4 Stereo mode: about 8 seconds

The sound may drop-out while searching the edited tracks

Tracks created through editing may exhibit sound dropout during searching because high-speed playback requires time to search for the position on the disc when the tracks are not in order.

Track numbers cannot be marked

Even in the Level Synchro Recording, the track numbers may not be marked at the beginning of the track:

- if the input signal is below a certain fixed level for less than 2 seconds between tracks.
- if the input signal is below a certain fixed level for more than 2 seconds in the middle of the track.
- if you record a track that is 4 seconds or less*.

* During Stereo, Monaural or LP2 Stereo recording mode (In LP4 Stereo recording mode: 8 seconds or less).

Extra tracks are created

When there is a long silence between CD tracks, an extra track may be created.

The number of tracks on the CD and the recorded MD is different

When there are short tracks on the CD, the number of tracks recorded on the MD may differ from that of the CD.

continued

System limitations of MDs (continued)

Guide to the Serial Copy Management System

Digital audio components, such as CDs, MDs, and DATs let you copy music easily with high quality by processing music as a digital signal.

To protect the copyrighted music programs, this system uses the Serial Copy Management System that allows you to make only a single copy of a digitally recorded source through digital-to-digital connections.

You can make only a first generation copy* through a digital-to-digital connection.

For example:

1 You can make a copy of a commercially available digital sound programme (for example, a CD or MD), but you cannot make a second copy from the first-generation copy.

2 You can make a copy of a digital signal from a digitally recorded analogue sound programme (for example, an analogue record or a music cassette tape) or from a digital satellite broadcast programme, but you cannot make a second copy.

* A first-generation copy means a digital recording of a digital signal made on digital audio equipment. For example, if you record from this system's CD player to the MD deck, you make a first-generation copy.

Specifications

Main Unit (HCD-CP505)

Amplifier section

European model:

DIN power output (rated): 30 + 30 W
(6 ohms at 1 kHz, DIN)

Continuous RMS power output (reference):
35 + 35 W
(6 ohms at 1 kHz, 10%
THD)

Music power output (reference):
70 + 70 W

Other models:

The following measured at 230 V AC, 60 Hz
DIN power output (rated): 25 + 25 W
(6 ohms at 1 kHz, DIN)

Continuous RMS power output (reference):
30 + 30 W
(6 ohms at 1 kHz, 10%
THD)

The following measured at 220 V AC, 60 Hz
DIN power output (rated): 22 + 22 W
(6 ohms at 1 kHz, DIN)

Continuous RMS power output (reference):
28 + 28 W
(6 ohms at 1 kHz, 10%
THD)

Inputs

ANALOG IN: Sensitivity 250 mV,
(phono jacks) impedance 47 kilohms
DIGITAL OPTICAL IN (supported sampling
frequencies: 32 kHz, 44.1 kHz and 48 kHz)

Outputs

PHONES: Accepts headphones with
an impedance of 8 ohms
or more
SPEAKER: accepts impedance of 6 to
16 ohms.

CD player section

System Compact disc and digital
audio system
Laser Semiconductor laser
($\lambda=780$ nm)
Emission duration:
continuous
Frequency response 2 Hz – 20 kHz

MD deck section

System	Minidisc digital audio system
Laser	Semiconductor laser ($\lambda=780$ nm) Emission duration: continuous
Sampling frequency	44.1 kHz
Frequency response	5 Hz – 20 kHz

Tape deck section

Recording system	4-track 2-channel stereo
Frequency response	50 – 13,000 Hz (± 3 dB), using Sony TYPE I cassettes
Wow and flutter	$\pm 0.15\%$ W. Peak (IEC) 0.1% W. RMS (NAB) $\pm 0.2\%$ W. Peak (DIN)

Tuner section

FM stereo, FM/AM superheterodyne tuner	
FM tuner section	
Tuning range	87.5 - 108.0 MHz (50-kHz step)
Antenna	FM wire antenna
Antenna terminals	75 ohms unbalanced
Intermediate frequency	10.7 MHz
AM tuner section	
Tuning range	
European model:	531 - 1,602 kHz (with the tuning interval set at 9 kHz)
Other models:	530 - 1,710 kHz (with the tuning interval set at 10 kHz) 531 - 1,602 kHz (with the tuning interval set at 9 kHz)
Antenna	AM loop antenna, external antenna terminal
Intermediate frequency	450 kHz

Speaker (SS-CCP505)

Speaker system	2-way, bass-reflex type
Speaker units	
Woofer:	12 cm dia., cone type
Tweeter:	2.5 cm dia., balanced drive type
Nominal impedance	6 ohms

General

Power requirements	
European model:	230 V AC, 50/60 Hz
Other models:	110 – 120 V or 220 – 240 V AC, 50/60 Hz
	Adjustable with voltage selector
Power consumption	
European model:	See the name plate 0.3 watts (at the Power Saving mode)
Other models:	See the name plate
Dimensions (w/h/d) incl. projecting parts and controls	
Amplifier/Tuner/Tape/MD/CD section:	Approx. 175 × 240 × 341.5 mm
Speaker:	Approx. 152 × 240 × 258.5 mm
Mass	
Amplifier/Tuner/Tape/MD/CD section:	Approx. 6.1 kg
Speakers:	Approx. 2.6 kg net per speaker
Supplied accessories	Remote (1) R6 (size AA) batteries (2) AM loop antenna (1) FM lead antenna (1)
Optional accessories	Sony PC connection kit (See the catalogue and other promotional materials for the release date.) The optional accessories for this system are subject to change without notice. For details, consult your nearest Sony dealer.
Design and specifications are subject to change without notice.	

Free Manuals Download Website

<http://myh66.com>

<http://usermanuals.us>

<http://www.somanuals.com>

<http://www.4manuals.cc>

<http://www.manual-lib.com>

<http://www.404manual.com>

<http://www.luxmanual.com>

<http://aubethermostatmanual.com>

Golf course search by state

<http://golfingnear.com>

Email search by domain

<http://emailbydomain.com>

Auto manuals search

<http://auto.somanuals.com>

TV manuals search

<http://tv.somanuals.com>