

SONY[®]

4-240-074-12(1)

Compact AV System

Operating Instructions



DAV-S400

© 2002 Sony Corporation

DAV-S400 4-240-074-12(1)

WARNING

To prevent fire or shock hazard, do not expose the unit to rain or moisture.

Do not install the appliance in a confined space, such as a bookcase or built-in cabinet.

To prevent fire, do not cover the ventilation of the apparatus with newspapers, table-cloths, curtains, etc. And don't place lighted candles on the apparatus.

To prevent fire or shock hazard, do not place objects filled with liquids, such as vases, on the apparatus.

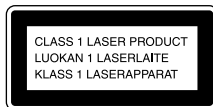

This appliance is classified as a CLASS 1 LASER product. The CLASS 1 LASER PRODUCT MARKING is located on the rear exterior.



This label is located on the Laser protective housing inside the enclosure.



Don't throw away the battery with general house waste, dispose of it correctly as chemical waste.

Precautions

Safety

- If anything falls into the cabinet, unplug the unit and have it checked by qualified personnel before operating it any further.
- The unit is not disconnected from the mains as long as it is connected to the mains outlet, even if the unit itself has been turned off.
- Unplug the unit from the wall outlet if you do not intend to use it for an extended period of time. To disconnect the cord, pull it out by the plug, never by the cord.

Installing

- Do not install the appliance in a confined space, such as a bookcase or built-in cabinet.
- Allow adequate air circulation to prevent internal heat buildup.
- Do not place the unit on surfaces (rugs, blankets, etc.) or near materials (curtains, draperies) that may block the ventilation slots.
- Do not install the unit near heat sources such as radiators, or air ducts, or in a place subject to direct sunlight, excessive dust, mechanical vibration, or shock.
- Do not install the unit in an inclined position. It is designed to be operated in a horizontal position only.
- Keep the unit and discs away from equipment with strong magnets, such as microwave ovens, or large loudspeakers.
- Do not place heavy objects on the unit.
- If the unit is brought directly from a cold to a warm location, moisture may condense inside the Compact AV System and cause damage to the lenses. When you first install the unit, or when you move it from a cold to a warm location, wait for about 30 minutes before operating the unit.

Welcome!

Thank you for purchasing this Sony Compact AV System. Before operating this system, please read this manual thoroughly and retain it for future reference.

Precautions

On safety

- Caution – The use of optical instruments with this product will increase eye hazard.
- Should any solid object or liquid fall into the cabinet, unplug the system and have it checked by qualified personnel before operating it any further.

On power sources

- The unit is not disconnected from the AC power source (mains) as long as it is connected to the wall outlet, even if the unit itself has been turned off.
- AC power cord must be changed only at the qualified service shop.

On placement

- Place the system in a location with adequate ventilation to prevent heat build-up in the system.
- At high volume, over long periods of time, the cabinet becomes hot to the touch. This is not a malfunction. However, touching the cabinet should be avoided. Do not place the unit in a confined space where ventilation is poor as this may cause overheating.
- Do not block the ventilation slots by putting anything on the system. The system is equipped with a high power amplifier. If the ventilation slots on the top surface are blocked, the unit can overheat and malfunction.
- Do not place the system on a soft surface such as a rug that might block the ventilation holes on the bottom.
- Do not place the system in a location near heat sources, or in a place subject to direct sunlight, excessive dust, or mechanical shock.

On operation

- If the system is brought directly from a cold to a warm location, or is placed in a very damp room, moisture may condense on the lenses inside the system. Should this occur, the system may not operate properly. In this case, remove the disc and leave the system turned on for about half an hour until the moisture evaporates.
- When you move the system, take out any discs. If you don't, the disc may be damaged.

- For power saving purposes, the system can be completely turned off by the POWER button on the main unit. Though the LED remains lit for a while, the system is completely off.

On adjusting volume

Do not turn up the volume while listening to a section with very low level inputs or no audio signals. If you do, the speakers may be damaged when a peak level section is played.

On cleaning

Clean the cabinet, panel, and controls with a soft cloth slightly moistened with a mild detergent solution. Do not use any type of abrasive pad, scouring powder or solvent such as alcohol or benzine.

If you have any questions or problems concerning your system, please consult your nearest Sony dealer.

On cleaning discs

Do not use a commercially available CD/DVD cleaning disc. It may cause a malfunction.

On your TV's colour

If the speakers should cause the TV screen to have colour irregularity, turn off the TV at once then turn it on after 15 to 30 minutes. If colour irregularity should persist, place the speakers further away from the set.

IMPORTANT NOTICE

Caution: This system is capable of holding a still video image or on-screen display image on your television screen indefinitely. If you leave the still video image or on-screen display image displayed on your TV for an extended period of time you risk permanent damage to your television screen. Projection televisions are especially susceptible to this.





Table of Contents

WARNING	2
Welcome!	2
Precautions	3
About this Manual	6
This system Can Play the Following Discs	6
Notes about the Discs	8
Index to Parts and Controls	9
Guide to the Control Menu Display (Magic Pad)	13
<hr/>	
Getting Started	15
Quick Overview	15
Unpacking	15
Inserting Batteries into the Remote	16
Step 1: Speaker System Hookup	16
Step 2: Antenna Hookups	19
Step 3: TV and Audio/Video Component Hookups	21
Speaker Setup	23
Presetting Radio Stations	28
<hr/>	
Playing Discs	30
Playing Discs	30
Resuming Playback from the Point Where You Stopped the Disc (Resume Play)	31
Using the DVD's Menu	32
Playing VIDEO CDs with PBC Functions (PBC Playback)	33
Creating Your Own Programme (Programme Play)	34
Playing in random order (Shuffle Play)	36
Playing repeatedly (Repeat Play)	37
<hr/>	
Searching for a Scene	38
Searching for a Particular Point on a Disc (Scan, Slow-motion Play)	38
Searching for a Title/Chapter/Track/Index/Scene	39
<hr/>	
Viewing Information About the Disc	41
Viewing the Playing Time and Remaining Time on the Front Panel Display ...	41
Checking the Playing Time and Remaining Time	42

Sound Adjustments	44
Changing the Sound	44
Selecting a Sound Field	46
Adjusting the level parameters	48
Enjoying Movies	49
Changing the Angles	49
Displaying the Subtitles	50
Checking the Play Information (ADVANCED)	51
Using Various Additional Functions	52
Locking Discs (CUSTOM PARENTAL CONTROL, PARENTAL CONTROL) ...	52
Other Operations	57
Controlling the TV with the Supplied Remote	57
Listening to other audio units	58
Listening to the Radio	58
Using the Radio Data System (RDS)	59
Naming Preset Stations	60
Settings and Adjustments	61
Using the Setup Display	61
Setting the Display or Sound Track Language (LANGUAGE SETUP)	62
Settings for the Display (SCREEN SETUP)	63
Custom Settings (CUSTOM SETUP)	64
Settings for the Speakers (SPEAKER SETUP)	65
Additional Information	69
Troubleshooting	69
Self-diagnosis Function (When letters/numbers appear in the display)	72
Glossary	72
Specifications	75
Language Code List	77
DVD Setup Menu List	78
Index	79
Quick reference for Remote Commander	Back page

About this Manual

- The instructions in this manual describe the controls on the remote. You can also use the controls on the system if they have the same or similar names as those on the remote.
- The icons used in this manual are explained below:

Icon	Meaning	Icon	Meaning
	Functions available in DVD video mode		Functions available in Super Audio CD and Audio CD mode
	Functions available in VIDEO CD mode		Functions available in CD mode
			More convenient features

This system Can Play the Following Discs

Format of discs	
DVD VIDEO	
Super Audio CD	
VIDEO CD	
Music CD	

The "DVD VIDEO" logo is a trademark.

6GB

Terms for discs

• Title

The longest section of a picture or music feature on a DVD, movie, etc., in video software or the entire album in audio software. Each title is assigned a title number enabling you to locate the title you want.

• Chapter

Sections of a picture or a music piece that are smaller than titles. A title is composed of several chapters. Each chapter is assigned a chapter number enabling you to locate the chapter you want. Depending on the disc, no chapters may be recorded.

• Track

Sections of a picture or a music piece on a VIDEO CD, Super Audio CD, or CD. Each track is assigned a track number enabling you to locate the track you want.

• Index (Super Audio CD, CD) / Video Index (VIDEO CD)

A number that divides a track into sections to easily locate the point you want on a VIDEO CD, Super Audio CD, or CD. Depending on the disc, no indexes may be recorded.

• Scene

On a VIDEO CD with PBC functions (page 33), the menu screens, moving pictures and still pictures are divided into sections called "scenes." Each scene is assigned a scene number enabling you to locate the scene you want.

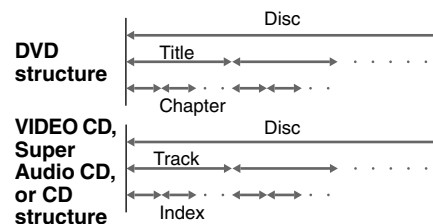

DAV-S400 4-240-074-12(1)

Note on PBC (Playback Control) (VIDEO CDs)

This system conforms to Ver. 1.1 and Ver. 2.0 of VIDEO CD standards. You can enjoy two kinds of playback depending on the disc type.

Disc type	You can
VIDEO CDs without PBC functions (Ver. 1.1 discs)	Enjoy video playback (moving pictures) as well as music.
VIDEO CDs with PBC functions (Ver. 2.0 discs)	Play interactive software using menu screens displayed on the TV screen (PBC Playback), in addition to the video playback functions of Ver. 1.1 discs. Moreover, you can play high-resolution still pictures, if they are included on the disc.

Region code

Your system has a region code printed on the back of the unit and will only play DVDs labelled with the same region code.

DVDs labelled  will also play on this system.

If you try to play any other DVD, the message "Playback prohibited by area limitations." will appear on the TV screen. Depending on the DVD, no region code indication may be labelled even though playing the DVD is prohibited by area restrictions.

Examples of discs that the system cannot play

The system cannot play the following discs:

- CD-ROMs (PHOTO CDs included)
- All CD-Rs other than music and VCD formatted CD-Rs
- Data part of CD-Extras
- DVD-ROMs
- DVD Audio discs
- A DVD with a different region code (page 7, 73).
- A disc that has a non-standard shape (e.g., card, heart)
- A disc with paper or stickers on it.
- A disc that has the adhesive, cellophane tape, or a sticker still left on it.

Note

Some CD-Rs or CD-RWs cannot be played on this system depending upon the recording quality or physical condition of the disc, or the characteristics of the recording device.

Furthermore, the disc will not play if it has not been correctly finalized. For more information, see the operating instructions for the recording device.

Note on playback operations of DVDs and VIDEO CDs

Some playback operations of DVDs and VIDEO CDs may be intentionally set by software producers. Since this system plays DVDs and VIDEO CDs according to the disc contents the software producers designed, some playback features may not be available. Also, refer to the instructions supplied with the DVDs or VIDEO CDs.

continued **7**GB

DAV-S400 4-240-074-12(1)

Copyrights

This product incorporates copyright protection technology that is protected by method claims of certain U.S. patents, other intellectual property rights owned by Macrovision Corporation, and other rights owners. Use of this copyright protection technology must be authorized by Macrovision Corporation, and is intended for home and other limited viewing uses only unless otherwise authorized by Macrovision Corporation. Reverse engineering or disassembly is prohibited.

This system incorporates Dolby* Digital, Pro Logic Surround, and the DTS** Digital Surround System.

- * Manufactured under license from Dolby Laboratories.
“Dolby”, “Pro Logic”, and the double-D symbol are trademarks of Dolby Laboratories.
Confidential unpublished works. © 1992-1997 Dolby Laboratories. All rights reserved.
- ** Manufactured under license from Digital Theater Systems, Inc. US Pat. No. 5,451,942 and other worldwide patents issued and pending. “DTS” and “DTS Digital Surround” are trademarks of Digital Theater Systems, Inc. © 1996 Digital Theater Systems, Inc. All rights reserved.

Notes about the Discs

On handling discs

- To keep the disc clean, handle the disc by its edge. Do not touch the surface.
- Do not stick paper or tape on the disc.



- Do not expose the disc to direct sunlight or heat sources such as hot air ducts, or leave it in a car parked in direct sunlight as the temperature may rise considerably inside the car.
- After playing, store the disc in its case.

On cleaning

- Before playing, clean the disc with a cleaning cloth.
Wipe the disc from the centre out.



- Do not use solvents such as benzine, thinner, commercially available cleaners, or anti-static spray intended for vinyl LPs.

Index to Parts and Controls

For more information, refer to the pages indicated in parentheses.

Front Panel

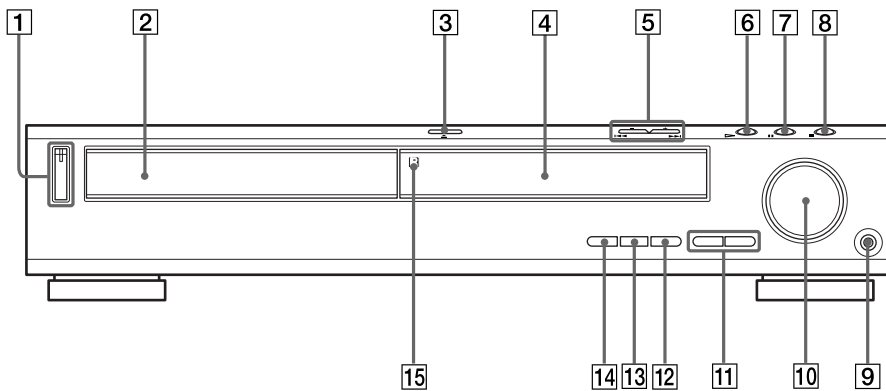

- | | |
|--|----------------------------------|
| 1 POWER switch/indicator (30) | 8 ■ (stop) (30) |
| 2 Disc tray (30) | 9 PHONES jack (30) |
| 3 ⏏ OPEN/CLOSE (30) | 10 VOLUME control (30) |
| 4 Front panel display (10) | 11 SOUND FIELD +/- (46) |
| 5 ⏮/▶, PREV/NEXT, PRESET +/- (28, 31) | 12 DISPLAY (46, 59) |
| 6 ▶ (play) (30) | 13 BAND (28) |
| 7 ⏸ (pause) (31) | 14 FUNCTION (58) |
| | 15 📶 (remote sensor) (16) |

continued **9**^{GB}

DAV-S400 4-240-074-12(1)

Front Panel Display

When playing back a DVD

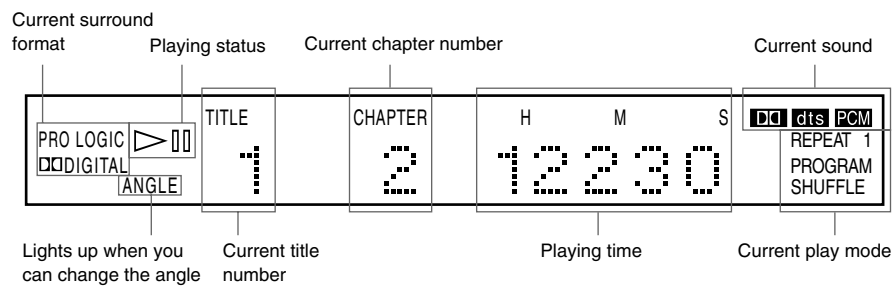

When playing back a Super Audio CD, CD, or VIDEO CD

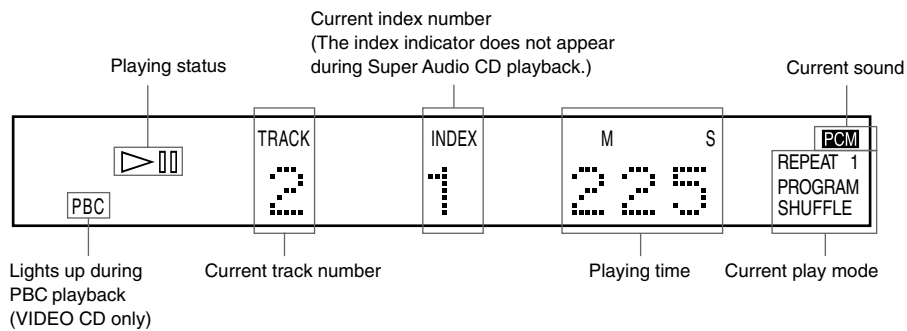

When listening to the radio

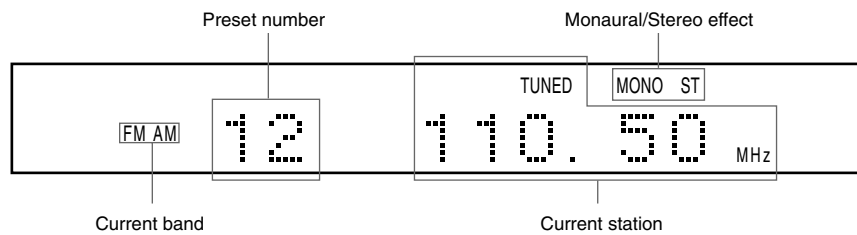

Rear Panel

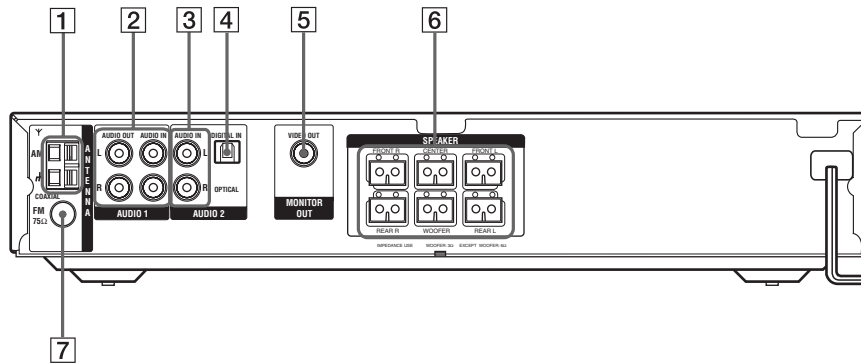

- | | |
|---|---|
| 1 AM antenna (19) | 5 MONITOR OUT jack (21) |
| 2 AUDIO 1 jacks (21) | 6 SPEAKER jacks (17) |
| 3 AUDIO 2 jacks (21) | 7 FM 75Ω COAXIAL antenna jack (20) |
| 4 DIGITAL IN (OPTICAL) jack (22) | |

Remote

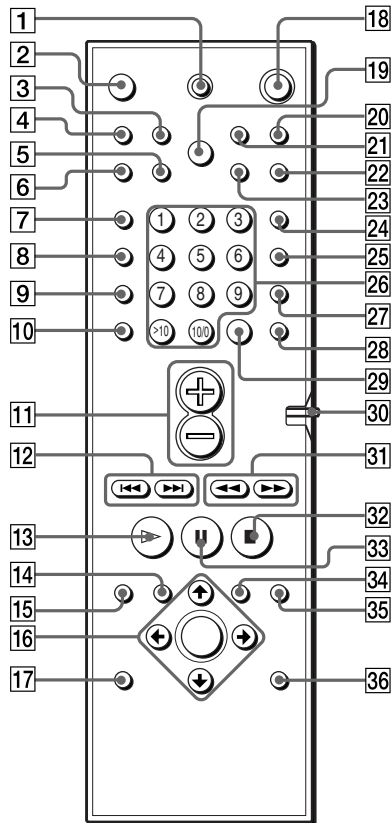

- 1 TV I/⏻ (on/standby) (57)
- 2 ▲ OPEN/CLOSE (30)
- 3 NAME (60)
- 4 STEREO/MONO (59)
- 5 MEMORY (28)
- 6 CLEAR (35)
- 7 PLAY MODE (34)
- 8 AUDIO (44)
- 9 ANGLE (49)
- 10 SUBTITLE (50)
- 11 VOL +/- (58)
- 12 ◀◀/▶▶, PREV/NEXT, TV CH +/-, PRESET +/- (28, 31)
- 13 ▷ PLAY/SELECT (30)
- 14 DVD TOP MENU (32)
- 15 DVD DISPLAY (37)
- 16 ◀/▶/⏮/⏭/ENTER (24)
- 17 DVD SETUP (54)
- 18 ⏻ (standby) (30)
- 19 DIMMER (27)
- 20 TV/VIDEO (57)
- 21 REPEAT (37)
- 22 MUTING (31)
- 23 TIME (41)
- 24 FUNCTION (58)
- 25 BAND (28)
- 26 Number buttons (32)
- 27 SOUND FIELD (46)
- 28 DISPLAY (46, 59)
- 29 ENTER (57)
- 30 COMMAND MODE DVD/TV switch (57)
- 31 ◀◀/▶▶, ◀/▶ SLOW, TUNING +/- (28, 38)
- 32 ■ STOP (30)
- 33 || PAUSE (31)
- 34 DVD MENU (33)
- 35 ↶ RETURN (34)
- 36 AMP MENU (24)



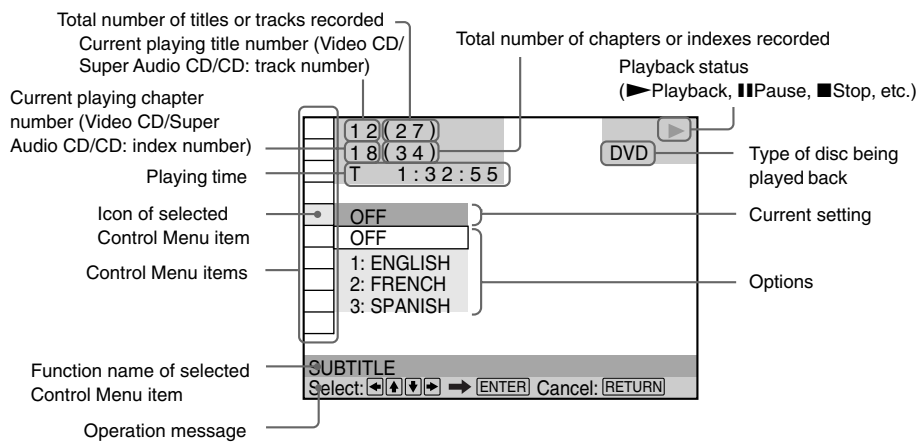

Guide to the Control Menu Display (Magic Pad)

Use the Control Menu to select a function that you'd like to use. The Control Menu display appears when the DVD DISPLAY button is pressed. For details, refer to the page in parentheses.

Control Menu











List of Control Menu Items

 TITLE (DVD only) (page 39)/ SCENE (only VIDEO CD in PBC playback) (page 39)/TRACK (VIDEO CD only) (page 39)	Selects the title (DVD), the scene (VIDEO CD in PBC playback), or the track (VIDEO CD) to be played.
 CHAPTER (DVD only) (page 39)/INDEX (VIDEO CD only) (page 39)	Selects the chapter (DVD) or the index (VIDEO CD) to be played.
 TRACK (Super Audio CD/CD only) (page 39)	Selects the track (Super Audio CD/CD) to be played.
 INDEX (Super Audio CD/CD only) (page 39)	Selects the index (Super Audio CD/CD) to be played.
 TIME/TEXT (page 39)	Checks the elapsed time and the remaining playback time. Inputs the time code for picture and music searching. Displays the DVD or the Super Audio CD/CD text.

continued

13^{GB}

	AUDIO (page 44)	Changes the audio setting.
	SUBTITLE (DVD only) (page 50)	Displays the subtitles. Changes the subtitle language.
	ANGLE (DVD only) (page 49)	Changes the angle.
	REPEAT (page 37)	Plays the entire disc (all titles/all tracks) repeatedly, or one title/chapter/track repeatedly.
	ADVANCED (DVD only) (page 51)	Checks the information (bit rate or layer) on the disc while playing a DVD.
	CUSTOM PARENTAL CONTROL (page 52)	Sets the disc to prohibit playing.
	SETUP (page 61)	CUSTOM Setup By using the Setup Display, you can make various adjustments to items such as picture and sound. You can also set a language for the subtitles and the Setup Display, among other things. RESET Returns the settings in "SETUP" to the default setting.

 Each time you press DVD DISPLAY, the Control Menu display changes as follows:

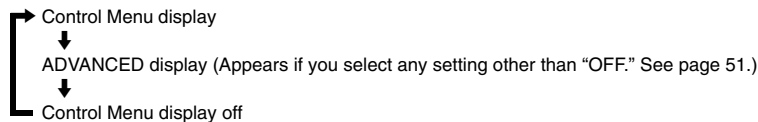

The Control Menu items are different depending on the disc.

 The Control Menu icon indicator lights up in green  →  when you select "REPEAT" unless you set the REPEAT PLAY setting to "OFF." The "ANGLE" indicator lights up in green only when the angles can be changed.

Quick Overview

This chapter presents a quick overview so you can begin enjoying your new system right away. For selecting a language used in the on-screen display, refer to page 62. For selecting the aspect ratio of the TV to be connected, refer to page 63.

Unpacking

Check that you have the following items:

- Speakers (5)
- Subwoofer (1)
- AM loop antenna (1)
- FM wire antenna (1)
- Speaker cords (5m × 4, 15m × 2)
- Video cord (1)
- Remote commander (remote) RM-SS400 (1)
- R6 (size AA) batteries (2)
- Foot pads (24)
- Speakers-Connection and Installation (card) (1)

Inserting Batteries into the Remote

You can control the system using the supplied remote. Insert two R6 (size AA) batteries by matching the ⊕ and ⊖ ends on the batteries to the markings inside the compartment. When using the remote, point it at the remote sensor  on the system.

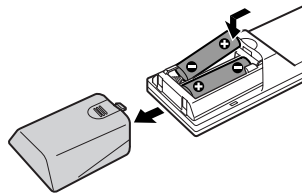

Notes

- Do not leave the remote in an extremely hot or humid place.
- Do not use a new battery with an old one.
- Do not drop any foreign object into the remote casing, particularly when replacing the batteries.
- Do not expose the remote sensor to direct light from the sun or lighting apparatus. Doing so may cause a malfunction.
- If you do not use the remote for an extended period of time, remove the batteries to avoid possible damage from battery leakage and corrosion.

Step 1: Speaker System Hookup

Connect the supplied speaker system using the supplied speaker cords by matching the colours of the terminals to those of the cords. Do not connect any speakers other than those supplied with this system.

To obtain the best possible surround sound, specify the speaker parameters (distance, level, etc.) on page 23.

Required cords

Speaker cords

The connector and the colour tube of the speaker cords are the same colour as the label of the terminals to be connected.

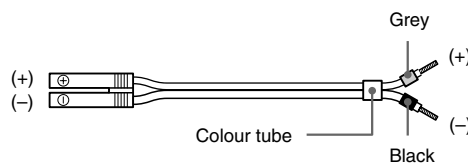

Terminals for connecting the speakers

Connect the	To the
Front speakers	SPEAKER FRONT L (white) and R (red) terminals
Rear speakers	SPEAKER REAR L (blue) and R (grey) terminals
Centre speaker	SPEAKER CENTER (green) terminal
Subwoofer	SPEAKER WOOFER (purple) terminal

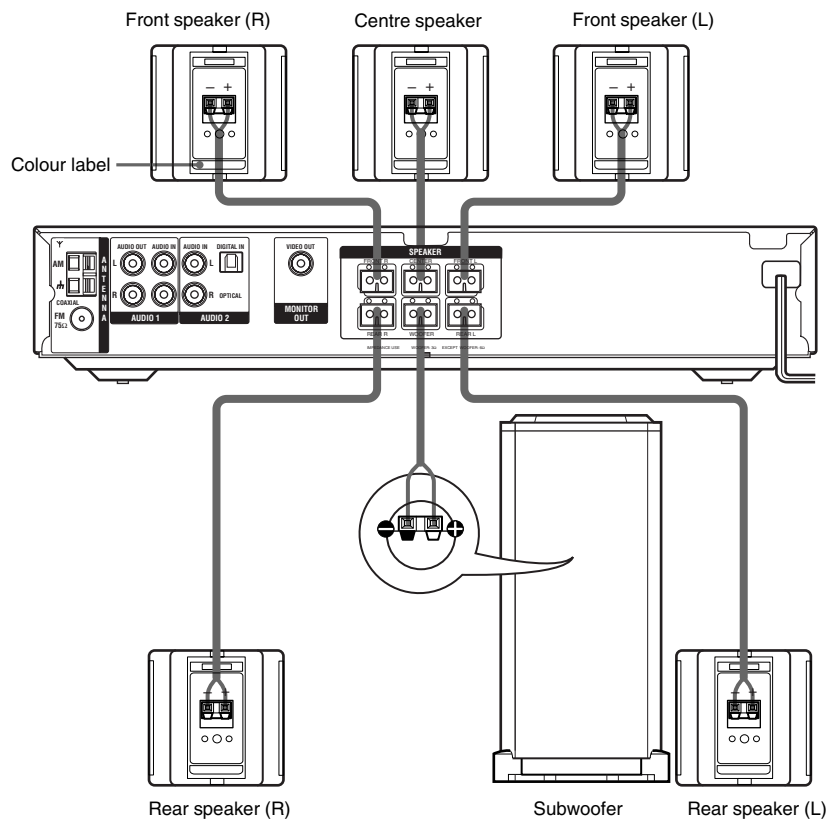

continued

17^{GB}

To avoid short-circuiting the speakers

Short-circuiting of the speakers may damage the system. To prevent this, be sure to follow these precautions when connecting the speakers. Make sure the bare wire of each speaker cord does not touch another speaker terminal or the bare wire of another speaker cord.

Examples of poor conditions of the speaker cord

Stripped speaker cord is touching another speaker terminal.

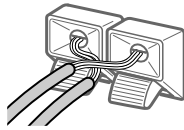

Stripped cords are touching each other due to excessive removal of insulation.

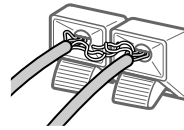

After connecting all the components, speakers, and AC power cord (mains lead), output a test tone to check that all the speakers are connected correctly. For details on outputting a test tone, see page 26.

If no sound is heard from a speaker while outputting a test tone, or a test tone is output from a speaker other than the one currently displayed on the front panel display, the speaker may be short-circuited. If this happens, check the speaker connection again.

Notes

- Be sure to match the speaker cord to the appropriate terminal on the components: \oplus to \oplus , and \ominus to \ominus . If the cords are reversed, the sound will be distorted and will lack bass.
- If you use front speakers with low maximum input rating, adjust the volume carefully to avoid excessive output on the speakers.

Step 2: Antenna Hookups

Connect the supplied AM/FM antennas to listen to the radio.

Terminals for connecting the antennas

Connect the	To the
AM loop antenna	AM terminals
FM wire antenna	FM 75Ω COAXIAL terminal

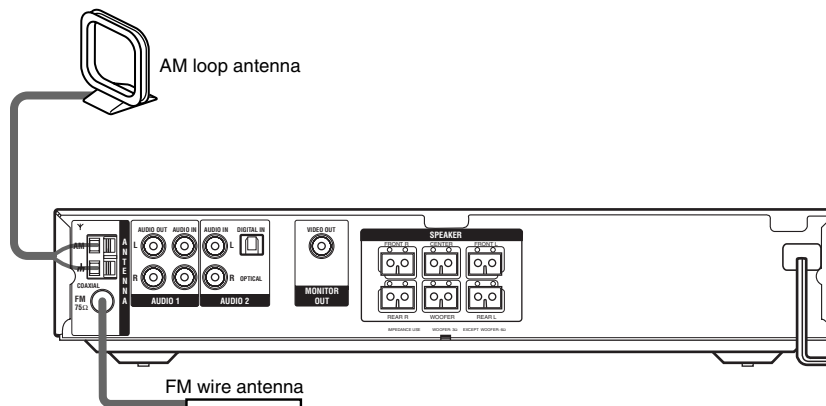

Notes

- To prevent noise pickup, keep the AM loop antenna away from the system and other components.
- Be sure to fully extend the FM wire antenna.
- After connecting the FM wire antenna, keep it as horizontal as possible.

continued

19^{GB}

💡 If you have poor FM reception

Use a 75-ohm coaxial cable (not supplied) to connect the system to an outdoor FM antenna as shown below.

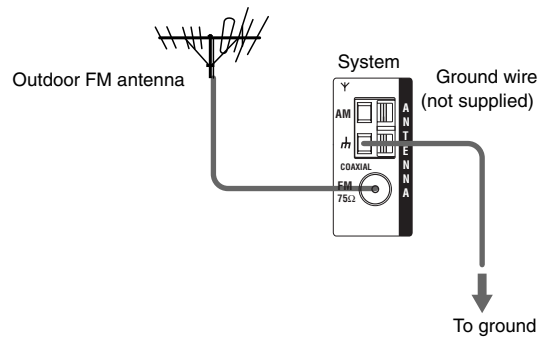

Note

If you connect the system to an outdoor antenna, ground it to protect against lightning. To prevent a gas explosion, do not connect the ground wire to a gas pipe.

Step 3: TV and Audio/Video Component Hookups

Required cords

Video cord for connecting a TV monitor



Audio cord (not supplied)

When connecting a cord, be sure to match the colour-coded pins to the appropriate jacks on the components.

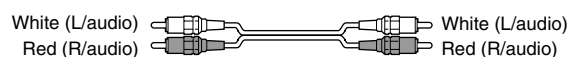

Jacks for connecting video components

Connect a	To the
TV monitor	MONITOR OUT jack
VCR	AUDIO 1 jacks
MD deck	AUDIO 2 jacks

Notes

- When you select AUDIO 1 using the FUNCTION button, the signal is output from the front L/R speakers, but not from the AUDIO 1 AUDIO OUT L/R jacks.
- When you use the AUDIO 1 line outputs, please set the system to 2CH STEREO mode. If the system is not in 2CH STEREO mode, the line outputs may not function properly.

continued

21^{GB}

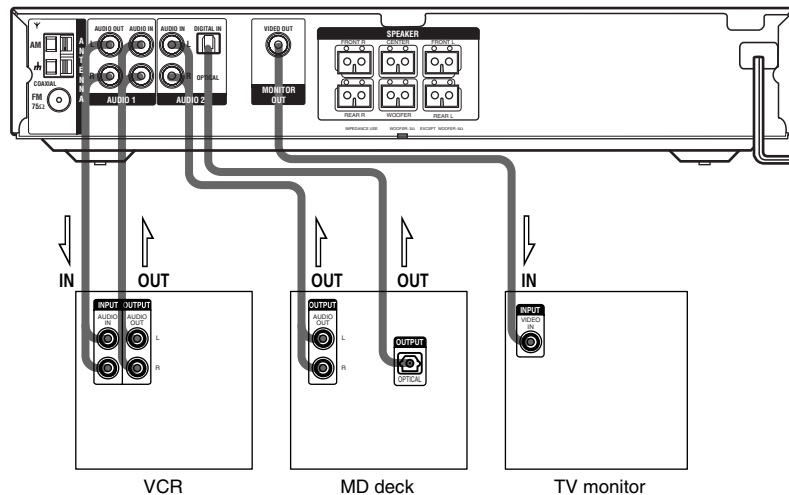

If you connect an MD deck with the OPTICAL jack

The MD deck can be connected to the OPTICAL jack instead of the AUDIO IN L/R jacks of the system.

The system can accept both the digital and analog signals. Digital signals have priority over analog signals. If the digital signal ceases, the analog signal will be processed after 2 seconds.

If you connect an MD deck without the OPTICAL jack

Connect the MD deck to the AUDIO IN L/R jacks of the system.

Connecting the AC Power Cord (mains lead)

Before connecting the AC power cord (mains lead) of this system to a wall outlet (mains), connect the speakers to the system (see page 16).

Connect the AC power cord (mains lead) of your TV/video components to a wall outlet (mains).

Speaker Setup

For the best possible surround sound, all the speakers other than the subwoofer should be the same distance from the listening position (A).

However, this system allows you to place the centre speaker up to 1.6 meters closer (B) and the rear speakers up to 4.6 meters closer (C) to the listening position.

The front speakers can be placed from 1.0 to 15.0 meters (A) from the listening position.

You can place the subwoofer in any position.

You can place the rear speakers either behind you or to the side, depending on the shape of your room, etc.

When the rear speakers are placed to the side

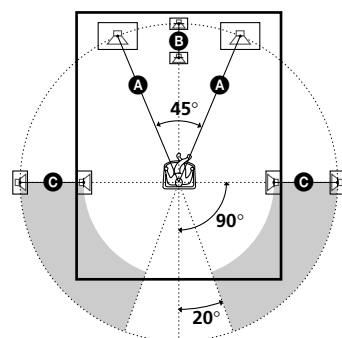

When the rear speakers are placed behind you

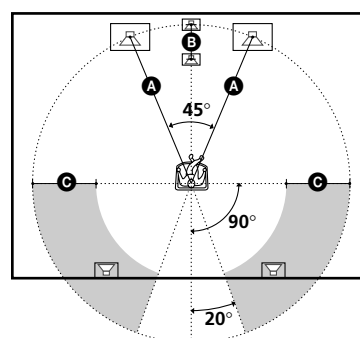

Note

Do not place the centre and rear speakers farther away from the listening position than the front speakers.

About magnetically shielded speakers

The subwoofer in this system is magnetically shielded to prevent magnetic leakage. However, some leakage may occur, as a high-strength magnet is employed. If the subwoofer is used with CRT-based TV or projector, install the subwoofer at least 0.3 meters from the TV set, etc. If it is installed too close, color irregularity may occur on the screen.

If color irregularity occurs

Turn off the TV set once, then turn it on after 15 to 30 minutes.

If color irregularity occurs again

Place the subwoofer farther away from the TV set.

If color irregularity still occurs after performing the above

Make sure that no magnetic object is nearby the subwoofer. Color irregularity may occur as a result of interaction between the subwoofer and the magnetic object.

Examples of possible sources of magnetic interference include: magnetic latches on a TV stand, etc., healthcare devices, toys, etc.

continued

23^{GB}

Specifying the speaker parameters

To obtain the best possible surround sound, first specify the distance of the speakers from your listening position, then set the balance and level. Use the test tone to adjust the speaker volumes to the same level.

You may adjust the speaker parameters using SPEAKER SETUP in the setup display (page 65).

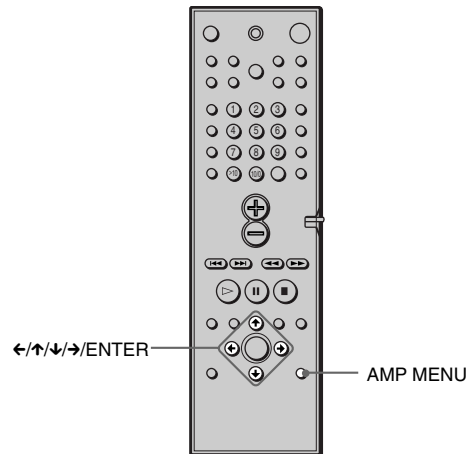

To specify the size, distance, position and height of the speakers

- 1 Press AMP MENU repeatedly to display **♪ SP. SETUP** on the front panel display.
- 2 Sit in your listening position and select the item to be set using **↑/↓**.
 - Items set in **♪ SP. SETUP**
 - Size of the rear and centre speakers
 - Distance of the front, rear, and centre speakers
 - Position and height of the rear speakers
- 3 Set the parameter using **←/→**.
The selected parameter will appear on the front panel display.
- 4 Repeat Steps 2 and 3 to set other parameters in **♪ SP. SETUP**.
If you do not operate the remote for a few seconds, the parameter turns off and is stored in the system.

■SIZE

When you do not connect centre or rear speakers, or move the rear speakers, set the parameters for CENTER and REAR. Since the front speaker and subwoofer settings are fixed, you cannot change them. The default settings are underlined.

- CENTER (centre speaker)
 - YES: Normally select this.
 - NO: Select this if no centre speaker is used.
- REAR (rear speakers)
 - YES: Normally select this. Specify the position and height to implement the Digital Cinema Surround modes in the “Virtual” sound field (page 46) properly.
 - NO: Select this if no rear speakers are used.

■ DISTANCE

You can vary the distance of each speaker as follows. The default settings are underlined.

- F. D. 5 m (front speakers distance)
Front speaker distance can be set in 0.2 meters steps from 1.0 to 15.0 meters.
- C. D. 5 m (centre speaker distance)
Centre speaker distance can be set in 0.2 meters steps from the front speaker distance to 1.6 meters closer to your listening position.
- R. D. 3.4 m (rear speakers distance)
Rear speaker distance can be set in 0.2 meters steps from a distance equal to the front speaker distance to a distance 4.6 meters closer to your listening position.

Note

If each of the front or rear speakers are not placed an equal distance from your listening position, set the distance of the closest speaker.

Specifying the rear speaker position and height

If you select anything other than “NONE” in “REAR,” specify the position and height of the rear speakers. The default settings are underlined.

Position diagram

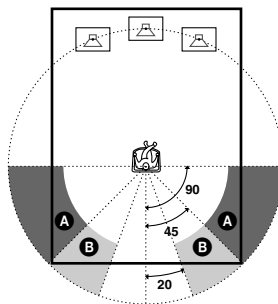

- R. P. BEHIND
Select this if the rear speakers are located in the section **B**.
- R. P. SIDE
Select this if the rear speakers are located in the section **A**.

continued

25^{GB}

Height diagram

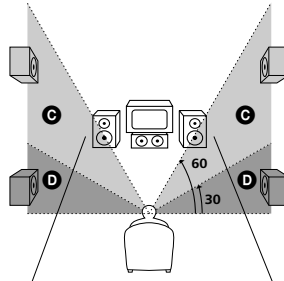

- **R. H. LOW**
Select this if the rear speakers are located in section **D**.
- **R. H. HIGH**
Select this if the rear speakers are located in section **C**.

These parameters are not available when “REAR“ is set to “NONE”.

To specify the balance and level of the speakers

- 1 Press AMP MENU repeatedly to display \mathbb{J} LEVEL on the front panel display.
- 2 Use \uparrow/\downarrow to select T.TONE and use \leftarrow/\rightarrow to set T.TONE to “ON”.
You will hear the test tone from each speaker in sequence.
- 3 Sit in your listening position and select the item to be adjusted using \uparrow/\downarrow .
 - Items adjusted in \mathbb{J} LEVEL
 - Balance of the front and rear speakers
 - Volume level of the centre and rear speakers and subwoofer
- 4 Adjust the volume level so that the volume of the test tone from each speaker sounds the same using \leftarrow/\rightarrow .
The adjusted value will appear on the front panel display.
- 5 Repeat Steps 3 and 4 to adjust other parameters in \mathbb{J} LEVEL.
If you do not operate the remote for a few seconds, the value disappears from the display and is stored in the system.
- 6 Use \uparrow/\downarrow to select T.TONE and use \leftarrow/\rightarrow to set T.TONE to “OFF”.

■ BALANCE

- You can vary the balance of each speaker as follows. The default settings are underlined.
- FI..... centre (front speakers)
Adjust the balance between the front left and right speakers (You can adjust from centre, 6 steps left or right).
 - RI..... centre (rear speakers)
Adjust the balance between the rear left and right speakers (You can adjust from centre, 6 steps left or right).

■ LEVEL

You can vary the level of each speaker as follows. The default settings are underlined.

- C. LEVEL 0 dB (centre speaker level)
Adjust the level of the centre speaker (You can adjust from –6 dB to +6 dB in 1 dB steps).
- R. LEVEL 0 dB (rear speakers level)
Adjust the level of the rear speakers (You can adjust from –6 dB to +6 dB in 1 dB steps).
- S. W. LEV. 0 dB (subwoofer level)
Adjust the level of the subwoofer (You can adjust from –6 dB to +6 dB in 1 dB steps).

■ Notes

- When you select an item, the sound cuts off for a moment.
- Depending on the settings of other speakers, the subwoofer may output excessive sound.

To adjust the volume of all the speakers at one time

Use the VOLUME control on the system or press VOL +/-.

Other AMP MENU settings

You can control the brightness of the front panel display, clear the preset stations and the station names, and set the speaker parameters back to the default setting. Press AMP MENU repeatedly to display \downarrow CUSTOMIZE. Use \uparrow/\downarrow to select the following items and \leftarrow/\rightarrow to adjust the settings.

■ DIMMER

You can change the brightness of the front panel display by two ways. Use \leftarrow/\rightarrow to adjust the settings or press DIMMER.

■ MEMO. CLR.

- N (No): Skip back to previous menu.
- Y (Yes): If you select Y by pressing ENTER, “Really? N” and “Really? Y” appears.
If you select “Really? Y” by pressing ENTER, “ALL CLEAR!” is displayed and all settings such as preset stations and station names will be cleared, and speaker parameters will be reset to their default settings.

Presetting Radio Stations

You can preset 20 stations for FM and 10 stations for AM.
Before tuning, make sure to turn down the volume to minimum.

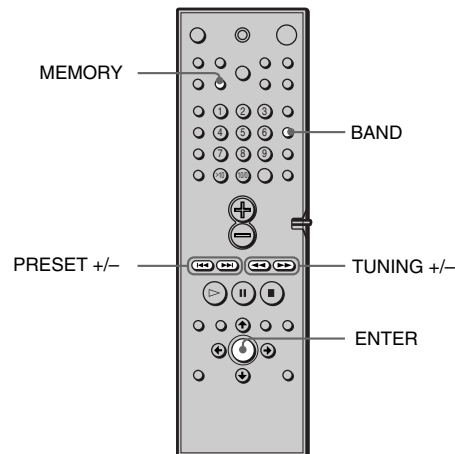

- 1 Press BAND repeatedly until the band you want appears on the front panel display.**

Every time you press BAND, the band changes to AM or FM alternately.

- 2 Press and hold TUNING + or – until the frequency indication starts to change, then release.**

Scanning stops when the system tunes in a station. "TUNED" and "ST" (for stereo programme) appear on the front panel display.

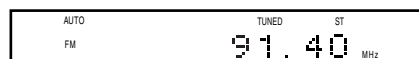

- 3 Press MEMORY.**

A preset number appears on the front panel display.



- 4 Press PRESET + or – to select the preset number you want.**

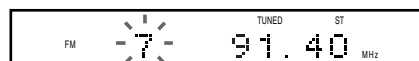

- 5** Press **ENTER**.
The station is stored.

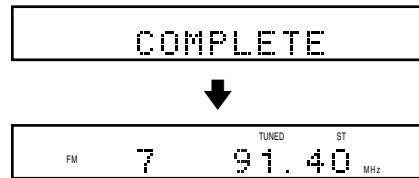

- 6** Repeat **1** to **5** to store other stations.

To tune in a station with a weak signal

Press TUNING + or – repeatedly in **2** to tune in the station manually.

To change the preset number

Start over from **1**.

Playing Discs

Playing Discs



Depending on the DVD or VIDEO CD, some operations may be different or restricted.

Refer to the operating instructions supplied with your disc.

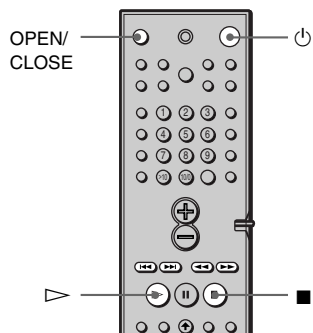
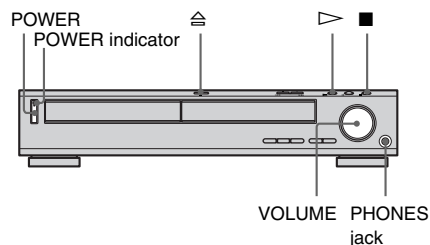

- 1 Turn on your TV.**
- 2 Switch the input selector on the TV to this system.**
- 3 Press POWER on the system.**
The system enters standby mode and the power indicator lights up in red.

- 4 Press on the system or OPEN/CLOSE on the remote, and place a disc on the disc tray.**

The system automatically turns on and the power indicator turns off.

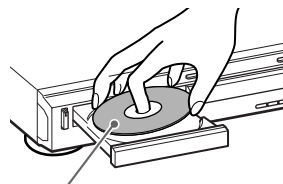

With the playback side facing down

- 5 Press .**
The disc tray closes, and the system starts playback (continuous play). Adjust the volume on the system.

After following Step 5

Depending on the disc, a menu may appear on the TV screen. You can play the disc interactively by following the instructions on the menu. (DVD (page 32), VIDEO CD (page 33)).

To turn on the system

Press POWER on the system. The system enters standby mode and the power indicator lights up in red. Press on the remote. The system turns on and the power indicator turns off. In standby mode, you can also turn on the system by pressing on the system or by pressing .

To turn off the system

Press on the remote. The system enters standby mode and the power indicator lights up in red. To turn off the system completely, press POWER on the system. While playing a disc, do not turn off the system by pressing POWER. Doing so may cancel the menu settings. When you turn off the system, first press to stop playback and then press on the remote.

Additional operations

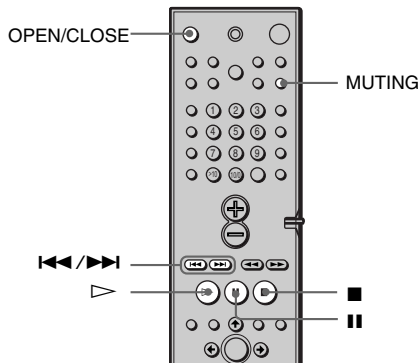

To	Operation
Stop	Press ■.
Pause	Press ■■.
Resume play after pause	Press ■■ or ▷.
Go to the next chapter, track, or scene in continuous play mode	Press ►►.
Go back to the preceding chapter, track, or scene in continuous play mode	Press ◀◀.
Stop play and remove the disc	Press OPEN/CLOSE.
Mute the sound	Press MUTING. To cancel muting, press it again or turn up the volume.

Note

Do not push the disc tray when closing it. Press OPEN/CLOSE to close the disc tray.

Resuming Playback from the Point Where You Stopped the Disc (Resume Play)



When you stop the disc, the system remembers the point where you pressed ■ and "RESUME" appears on the front panel display. As long as you do not open the disc tray, Resume Play will work even if the system enters standby mode by pressing ⏻.

Playing Discs

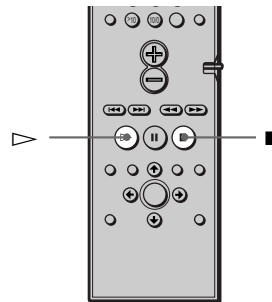

1 While playing a disc, press ■ to stop playback.

"RESUME" appears on the front panel display, so you can restart the disc from the point where you stopped the disc.

If "RESUME" does not appear, Resume Play is not available.

2 Press ▷.

The system starts playback from the point where you stopped the disc in Step 1.

💡 To play from the beginning of the disc, press ■ twice, then press ▷.

continued

31 GB

Notes

- Depending on where you stopped the disc, the system may not resume playback from exactly the same point.
- The point where you stopped playing is cleared when:
 - you turn the power off by pressing POWER on the system.
 - you change the play mode.

Using the DVD's Menu

DVD

Some discs have a “title menu” or a “DVD menu.” On some DVDs, this may simply be called a “menu” or “title.”

Using the title menu

A DVD is divided into long sections of a picture or a music feature called “titles.” When you play a DVD which contains several titles, you can select the title you want using the title menu.

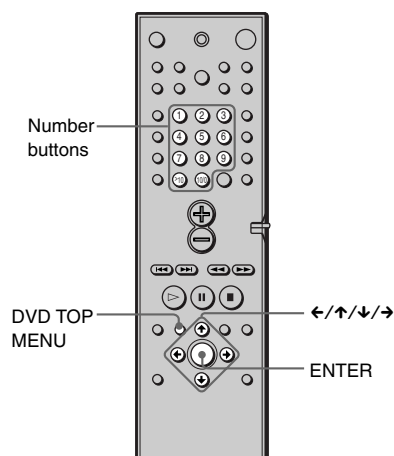

1 Press DVD TOP MENU.

The title menu appears on the TV screen.

The contents of the menu vary from disc to disc.

2 Press ←/↑/↓/→ or the number buttons to select the title you want to play.

3 Press ENTER.

The system starts playing the selected title.

Using the DVD menu

Some DVDs allow you to select the disc contents using a menu. When you play these DVDs, you can select items such as the language for the subtitles and the language for the sound using the DVD menu.

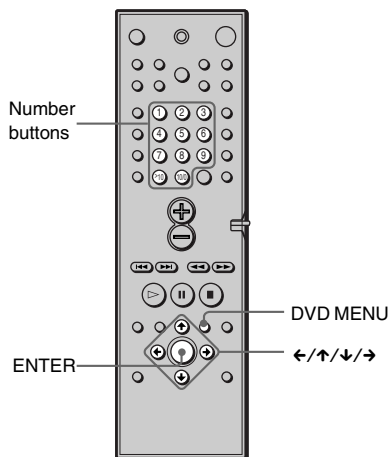

- 1 Press DVD MENU.**
The DVD menu appears on the TV screen. The contents of the menu vary from disc to disc.
- 2 Press ←/↑/↓/→ or the number buttons to select the item you want to change.**
- 3 To change other items, repeat Step 2.**
- 4 Press ENTER.**

Playing VIDEO CDs with PBC Functions (PBC Playback)



With PBC (Playback Control) functions, you can enjoy simple interactive operations, search functions, and other such operations. PBC playback allows you to play VIDEO CDs interactively by following the menu on the TV screen.

Playing Discs

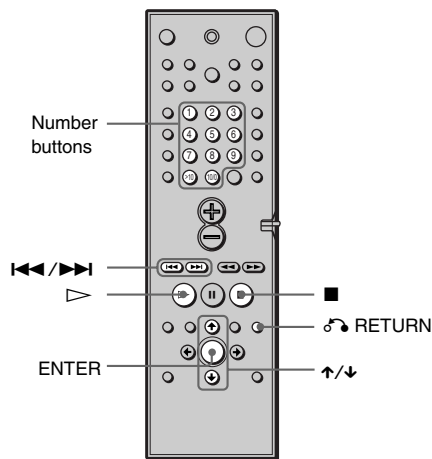

- 1 Start playing a VIDEO CD with PBC functions.**
The menu for your selection appears.
- 2 Select the item number you want by pressing ↑/↓ or the number buttons.**
- 3 Press ENTER.**

continued **33**^{GB}

DAV-S400 4-240-074-12(1)

- 4 Follow the instructions in the menu for interactive operations.**
Refer to the instructions supplied with the disc, as the operating procedure may differ according to the VIDEO CD.

To go back to the menu

Press RETURN.

To play without using PBC, press or the number buttons while the system is stopped to select a track, then press or ENTER.
“Play without PBC” appears on the TV screen and the system starts continuous play. You cannot play still pictures such as a menu. To return to PBC playback, press twice, then press .

Note

Depending on the VIDEO CD, “Press ENTER” in Step 3 may appear as “Press SELECT” in the instructions supplied with the disc. In this case, press .

Creating Your Own Programme (Programme Play)



You can play the contents of a disc in the order you want by arranging the order of the titles, chapters or tracks on the disc to create your own programme. You can programme up to 25 titles, chapters, and tracks.

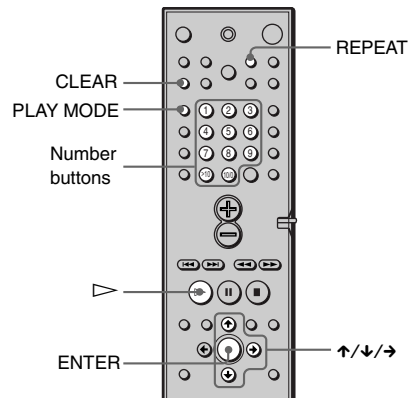

- 1 In stop mode, press PLAY MODE repeatedly until “PROGRAM” appears on the front panel display.**

The programming display appears on the TV screen.

“TRACK” is displayed when you play a VIDEO CD, Super Audio CD, or CD.

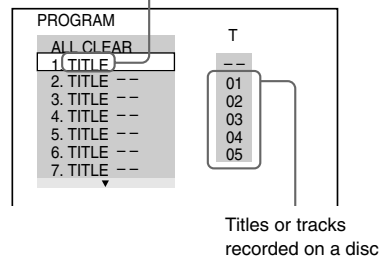

2 Press →.

The cursor moves to the title or track (in this case, "01").

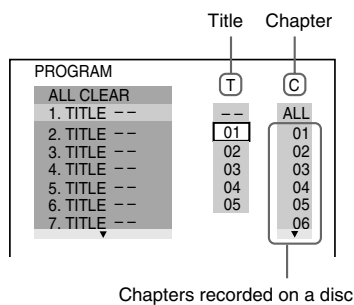

3 Select the title, chapter, or track you want to programme.

■ When playing a DVD

For example, select chapter "03" of title "02."

Press ↑/↓ or the number buttons to select "02" under "T," then press ENTER.

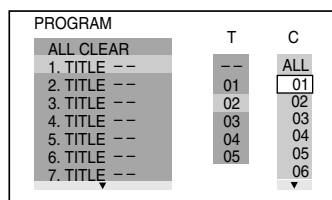

Next, press ↑/↓ or the number buttons to select "03" under "C," then press ENTER.

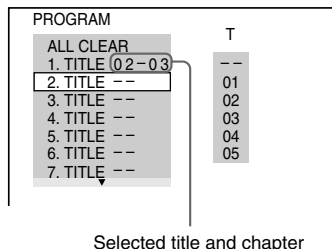

■ When playing a VIDEO CD, Super Audio CD, or CD

For example, select track "02."

Press ↑/↓ or the number buttons to select "02" under "T," then press ENTER.

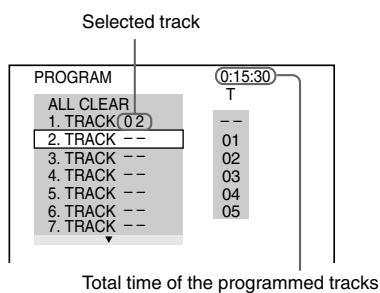

Playing Discs

4 To programme other titles, chapters, or tracks, repeat Steps 2 to 3.

The programmed titles, chapters, and tracks are displayed in the selected order.

5 Press ▷ to start Programme Play.

Programme Play begins.

When the programme ends, you can restart the same programme again by pressing ▷.

To return to normal play

Press CLEAR during playback.

To turn off the programme menu

In stop mode, press PLAY MODE to turn off the programme menu.

continued

35^{GB}

To change the programme

1 In Step 2, select the programme number of the title, chapter, or track you want to change using \uparrow/\downarrow or the number buttons, and press \rightarrow .

2 Follow Step 3 for new programming.

To cancel the programmed order

To cancel all the titles, chapters, or tracks in the programmed order, press \uparrow , and select "ALL CLEAR" in Step 2. To cancel the selected programme, select the programme using \uparrow/\downarrow in Step 2, then press CLEAR, or select "--" in Step 3, then press ENTER.

 You can do Repeat Play of the programmed titles, chapters, or tracks. Press REPEAT, or set "REPEAT" to "ON" in the Control Menu display during Programme Play.

Note

The number of titles, chapters, or tracks displayed are the same number of titles, chapters, or tracks recorded on a disc.

Playing in random order

(Shuffle Play)   

You can have the system "shuffle" titles, chapters, or tracks and play them in random order. Subsequent "shuffling" may produce a different playing order.

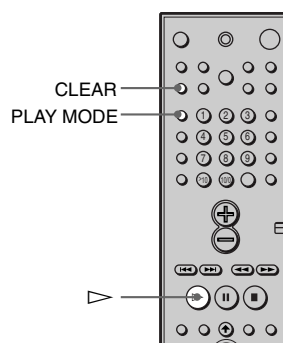

1 In stop mode, press PLAY MODE repeatedly until "SHUFFLE" appears on the front panel display.

2 Press \triangleright .

To return to normal play

In stop mode, press PLAY MODE twice, or during playback, press CLEAR to return to normal play.

Notes

- Shuffle Play is cancelled when:
 - you open or close the disc tray
 - you turn the power off
 - you change the function
- You may not be able to do Shuffle Play depending on the DVD.

Playing repeatedly (Repeat Play)

You can play all the titles/tracks or a single title/chapter/track on a disc. In Shuffle or Programme Play mode, the system repeats the titles or tracks in the shuffled or programmed order. You cannot perform Repeat Play during PBC playback of VIDEO CDs (page 33). You may not be able to perform Repeat Play depending on the DVD.

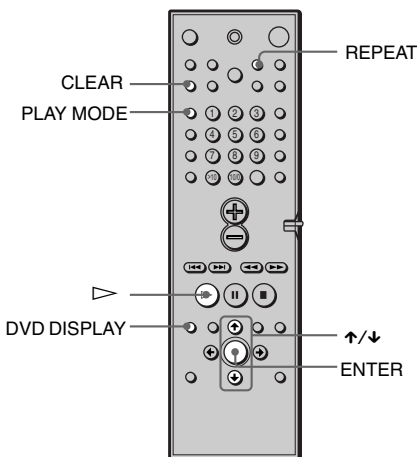

1 Press DVD DISPLAY.
The Control Menu appears.

2 Press \uparrow/\downarrow to select  (REPEAT), then press ENTER.
If you do not select "OFF," the indicator of "REPEAT" lights up in green.

3 Select the Repeat Play setting.

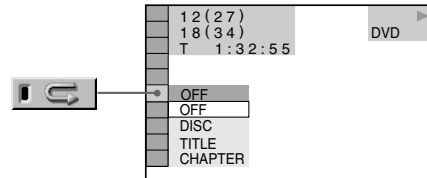

When playing a DVD and when Programme Play is set to OFF

- **OFF:** does not play repeatedly.
- **DISC:** repeats all the titles.
- **TITLE:** repeats the current title on a disc.
- **CHAPTER:** repeats the current chapter.

When playing a VIDEO CD/Super Audio CD/CD and when Programme Play is set to OFF

- **OFF:** does not play repeatedly.
- **DISC:** repeats all the tracks on a disc.
- **TRACK:** repeats the current track

When Programme Play is set to ON

- **OFF:** does not play repeatedly.
- **ON:** repeats Programme Play.

To cancel Repeat Play

Press CLEAR.

You can set Repeat Play during stop mode

After selecting the "REPEAT" item, press \triangleright . The system starts Repeat Play.

You can quickly display the "REPEAT" status

Press REPEAT on the remote.

Note

Repeat play is cancelled when:

- you turn the power off.
- you change the function.
- you open and close the disc tray.

Searching for a Scene

Searching for a Particular Point on a Disc (Scan, Slow-motion Play)



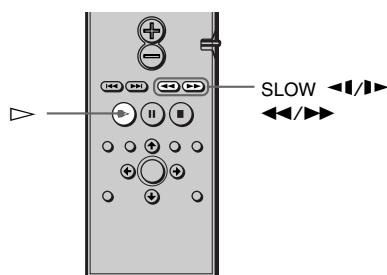

You can locate a particular point on a disc quickly by monitoring the picture or playing back slowly.





Note

Depending on the DVD/VIDEO CD, you may not be able to do some of the operations described.



Locating a point quickly by playing a disc in fast forward or fast reverse (Scan)







Press  or  while playing a disc. When you find the point you want, press  to return to normal speed. Each time you press  or  during scan, the playback speed changes. Three speeds are available. With each press, the indication changes as follows:

Playback direction



 (DVD/Super Audio CD → FF1  → FF2 
↑
/CD only



Opposite direction

 (DVD only) → FR1  → FR2 



The / playback speed is about twice the normal speed. The FF2 /FR2  playback speed is faster than FF1 /FR1 .

Watching frame by frame (Slow-motion play)



You can use this function only for DVDs or VIDEO CDs. Press  or  when the system is in the pause mode. To return to normal speed, press .

Each time you press  or  during Slow-motion play, the playback speed changes. Two speeds are available. With each press, the indication changes as follows:

Playback direction

SLOW 2  ↔ SLOW 1 

Opposite direction (DVD only)

SLOW 2  ↔ SLOW 1 

The SLOW 2 /SLOW 2  playback speed is slower than SLOW 1 /SLOW 1 .

Searching for a Title/ Chapter/Track/Index/ Scene



You can search a DVD disc by title or chapter, and you can search a VIDEO CD or CD by track, index, or scene. As titles and tracks are assigned unique numbers on the disc, you can select the desired one by entering its number. Or, you can search for a scene using the time code. (TIME SEARCH)

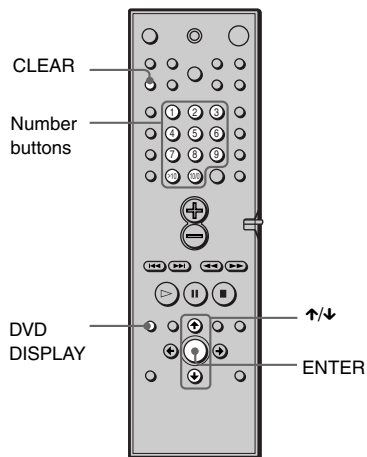

1 Press DVD DISPLAY.
The Control Menu appears.

2 Press \uparrow/\downarrow to select the search method.

■ When playing a DVD

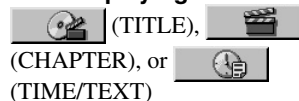

Select TIME/TEXT for TIME SEARCH.

■ When playing a VIDEO CD

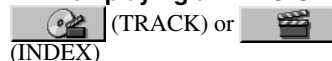

■ When playing a VIDEO CD with PBC Playback



■ When playing a Super Audio CD/CD



Example: when you select (CHAPTER)

“** (**)” is selected (** refers to a number).

The number in parentheses indicates the total number of titles, chapters, tracks, indexes, or scenes.

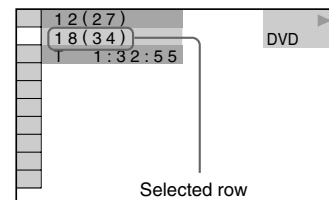

3 Press ENTER.
“** (**)” changes to “— (**)”.

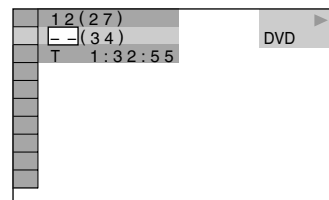

4 Press \uparrow/\downarrow or the number buttons to select the title, chapter, track, index, or scene number you want to search.

If you make a mistake

Cancel the number by pressing CLEAR, then select another number.

Searching for a Scene

5 Press ENTER.

The system starts playback from the selected number.

To turn off the Control Menu

Press DVD DISPLAY repeatedly until the Control Menu is turned off.

To search for a scene using the time code (TIME SEARCH) (DVD only)

- 1 In Step 2, select  (TIME/TEXT).
“T **:***:***” (playing time of the current title) is selected.
- 2 Press ENTER.
“T **:***:***” changes to “T --:--:--.”
- 3 Input the time code using the number buttons, then press ENTER.
For example, to find the scene at 2 hours, 10 minutes, and 20 seconds after the beginning, just enter “2:10:20.”

Note

The title, chapter or track number displayed is the same number recorded on the disc.

Viewing Information About the Disc

Viewing the Playing Time and Remaining Time on the Front Panel Display



You can check information about the disc, such as the remaining time, total number of titles of a DVD, or tracks of a Super Audio CD, CD, or VIDEO CD, using the front panel display (page 10).

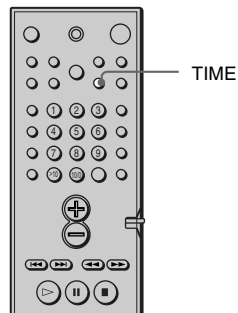

Press TIME.

Each time you press TIME while playing the disc, the display changes as shown in the following charts.

When playing a DVD

Playing time and number of the current title

TITLE	CHAPTER	H	M	S
1	2	1	0	324

Remaining time of the current title

TITLE	CHAPTER	H	M	S
1	2	-	1	1536

Playing time and number of the current chapter

CHAPTER	H	M	S
2	0	2	230

Remaining time of the current chapter

CHAPTER	H	M	S
2	-	0	1320

Text

SONY HITS/

When playing a VIDEO CD (without PBC functions), Super Audio CD, or CD

Playing time and current track number

TRACK	INDEX	M	S
2	1	2	25

Remaining time of the current track

TRACK	INDEX	M	S
2	1	-	150

Playing time of the disc

M	S
3	212

Remaining time of the disc

M	S
-	2018

Text

SONY HITS/

💡 When playing VIDEO CDs with PBC functions, the scene number and the playing time are displayed.

Viewing Information About the Disc

continued **41** GB

 The playing time and remaining time of the current chapter, title, track, scene, or disc will also appear on your TV screen. See the following section “Checking the Playing Time and Remaining Time” for instructions on how to read this information.

Notes

- While playing Super Audio CD, the index indicator does not appear on the front panel display.
- Depending on the type of disc being played and the playing mode, the disc information may not be displayed.

Checking the Playing Time and Remaining Time



You can check the playing time and remaining time of the current title, chapter, or track, and the total playing time or remaining time of the disc. You can also check the DVD/CD/Super Audio CD text recorded on the disc.

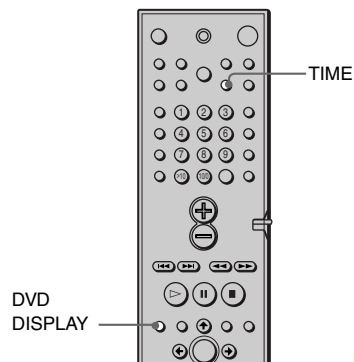

1 Press DVD DISPLAY during playback.

The Control Menu appears.

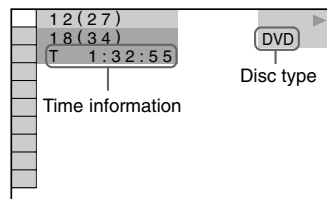

2 Press TIME repeatedly to change the time information.

The display and the kinds of time that you can change depend on the disc you are playing.

■ When playing a DVD

- T **:**:**
Playing time of the current title
- T-**:**:**
Remaining time of the current title
- C **:**:**
Playing time of the current chapter
- C-**:**:**
Remaining time of the current chapter

■ When playing a VIDEO CD (with PBC functions)

- **:**:**
Playing time of the current scene

■ When playing a VIDEO CD (without PBC functions), Super Audio CD, or CD

- T **:**:**
Playing time of the current track
- T-**:**:**
Remaining time of the current track
- D **:**:**
Playing time of the current disc
- D-**:**:**
Remaining time of the current disc

💡 If the DVD/CD/Super Audio CD text does not fit in a single line, you can see the entire text scrolls across the front display.

💡 You can select the time and text by pressing TIME.

Notes

- Only letters of the alphabet can be displayed.
- This system can only display the first level of DVD/CD/Super Audio CD text, such as the disc name or title.
- In Super Audio CD playback, the system can only display a limited number of characters. Also, depending on the disc, not all text characters are displayed.

To turn off the Control Menu

Press DVD DISPLAY repeatedly until the Control Menu is turned off.

Checking the DVD/CD/Super Audio CD text

Press TIME repeatedly in Step 2 to display the text recorded on the DVD/CD/Super Audio CD. The DVD/CD/Super Audio CD text appears only when the text is recorded on the disc. You cannot change the text.

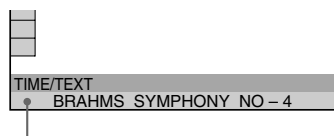

DVD/CD/Super Audio CD text

Sound Adjustments

Changing the Sound



If a DVD is recorded with multilingual tracks, you can select the language you want while playing the DVD.

If the DVD is recorded in multiple audio formats (PCM, Dolby Digital, MPEG audio, or DTS), you can select the audio format you want while playing the DVD.

With stereo CDs or VIDEO CDs, you can select the sound from the right or left channel and listen to the sound of the selected channel through both the right and left speakers. (In this case, the sound loses its stereo effect.) For example, when playing a disc containing a song with the vocals on the right channel and the instruments on the left channel, you can select the left channel and hear only the instruments from both speakers.

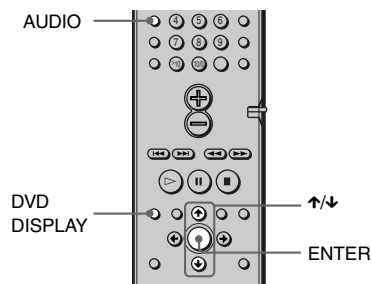

1 Press DVD DISPLAY during playback.

The Control Menu is displayed.

2 Press \uparrow/\downarrow to select (AUDIO), then press ENTER.

The options for AUDIO appear.

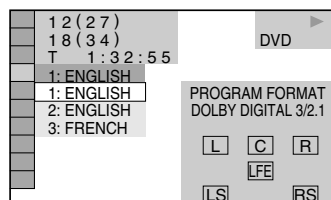

44GB

3 Press \uparrow/\downarrow to select the desired audio signal.

■ When playing a DVD

Depending on the DVD, the choice of language varies.

When 4 digits are displayed, they represent the language code. Refer to the language code list on page 77 to see which language the code represents. When the same language is displayed two or more times, the DVD is recorded in multiple audio formats.

■ When playing a VIDEO CD, or CD

The default setting is underlined.

- STEREO: The standard stereo sound
- 1/L: The sound of the left channel (monaural)
- 2/R: The sound of the right channel (monaural)

■ When playing a Super Audio CD

In stop mode, depending on the Super Audio CD, the choice of settings varies.

- MULTI: The disc has multi-channel playback area
- 2CH: The disc has the 2 channel playback area.
- CD: When you want to play the disc as a conventional CD.

Note

Not all discs give you the three choices above when in Super Audio CD playback. It all depends on the layer configuration of the Super Audio CD to be played.

4 Press ENTER.

To turn off the Control Menu

Press DVD DISPLAY repeatedly until the Control Menu is turned off.

You can select AUDIO directly by pressing AUDIO. Each time you press the button, the item changes.

Notes

- For discs not in multiple audio format, you cannot change the sound.
- During DVD playback, the sound may change automatically.

Displaying the audio information of the disc

When you select "AUDIO," the channels being played are displayed on the screen. For example, in Dolby Digital format, multiple signals ranging from monaural to 5.1 channel signals can be recorded on a DVD. Depending on the DVD, the number of recorded channels may differ.

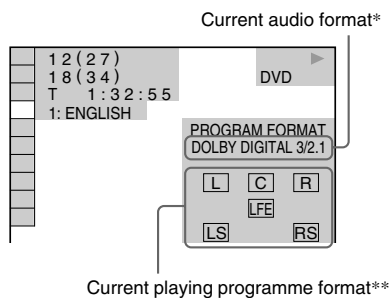

* "PCM," "MPEG," "DTS," or "DOLBY DIGITAL" is displayed. For "DOLBY DIGITAL," the channels in the playing track are displayed numerically as follows:

For Dolby Digital 5.1 ch:

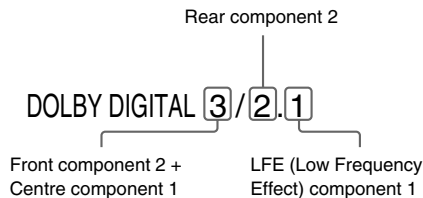

**The letters in the programme format display mean the following sound component:

- L: Front (left)
- R: Front (right)
- C: Centre
- LS: Rear (left)
- RS: Rear (right)
- S: Rear (monaural): The rear component of the Dolby Surround processed signal and the Dolby Digital signal.
- LFE: LFE (Low Frequency Effect)

The display examples are as follows:

- PCM (stereo)



- Dolby Surround

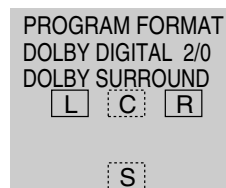

- Dolby Digital 5.1ch

When an LFE signal component is output, "LFE" is enclosed in a solid line. When an LFE signal component is not output, "LFE" is enclosed in a broken line.

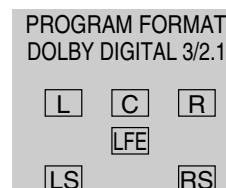

- DTS

"LFE" is always enclosed in a solid line regardless of the LFE signal component being output.

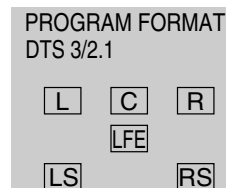

Notes

- When the signal contains rear signal components such as LS, RS, or S, the surround effect is enhanced (page 46).
- If you play MPEG AUDIO sound tracks, the system outputs PCM (stereo) signals.

Selecting a Sound Field



You can enjoy surround sound simply by selecting one of the pre-programmed sound fields according to the programme you want to listen to. Surround sound can be applied to DVD, VIDEO CD, and CD playback.

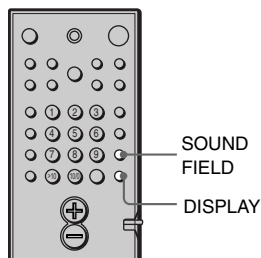

Press SOUND FIELD repeatedly until the sound field you want appears on the front panel display.

You can also use SOUND FIELD +/- on the system to select the pre-programmed sound fields.



To check the current sound field

Press DISPLAY repeatedly.
Each time you press DISPLAY, the front panel display switches as follows:
remaining or playing time → sound field
→ remaining or playing time

The system memorises the last sound field selected for each function mode (Sound Field Link)

Whenever you select a function such as DVD or TUNER, the sound field that was last applied to the function is automatically applied again. For example, if you listen to DVD with LARGE HALL as the sound field, then change to another function, and then return to DVD, LARGE HALL will be applied again. With the tuner, sound fields are memorised separately for all preset stations.

You can identify the encoding format of programme software by looking at its packaging

- Dolby Digital discs are labelled with the  logo.
- Dolby Surround encoded programmes are labelled with the  logo.
- DTS Digital Surround discs are marked with DTS.

Note

When you play sound tracks with 96 kHz sampling frequency, the output signals will be converted to 48 kHz (sampling frequency).

C.S.EX A (CINEMA STUDIO EX A)*

Reproduces the sound characteristics of the Sony Pictures Entertainment's classic editing studio using the 3D sound imaging of V. MULTI DIMENSION (page 47) to create 5 sets of virtual speakers surrounding the listener from a single pair of actual rear speakers.

This is a standard mode, great for watching most movies.

C.S.EX B (CINEMA STUDIO EX B)*

Reproduces the sound characteristics of the Sony Pictures Entertainment's mixing studio using the 3D sound imaging of V. MULTI DIMENSION (page 47) to create 5 sets of virtual speakers surrounding the listener from a single pair of actual rear speakers. This mode is ideal for watching science-fiction or action movies with lots of sound effects.

C.S.EX C (CINEMA STUDIO EX C)*

Reproduces the sound characteristics of the Sony Pictures Entertainment's BGM recording studio using the 3D sound imaging of V. MULTI DIMENSION (page 47) to create 5 sets of virtual speakers surrounding the listener from a single pair of actual rear speakers.

This mode is ideal for watching musicals or classic films where music is featured in the soundtrack.

* "VIRTUAL" sound field: Sound field with virtual speakers.

**V.MULTI D.
(VIRTUAL MULTI DIMENSION)**

Uses 3D sound imaging to create an array of virtual rear speakers positioned higher than the listener from a single pair of actual rear speakers. This mode creates 5 sets of virtual speakers surrounding the listener at approximately a 30° angle of elevation.

SIDE

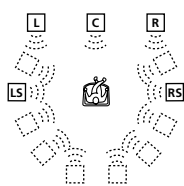

BEHIND

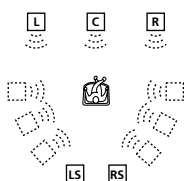

**V.S.M.D.
(VIRTUAL SEMI MULTI DIMENSION)**

Uses 3D sound imaging to create virtual rear speakers from the sound of the front speakers without using actual rear speakers. This mode creates 5 sets of virtual speakers surrounding the listener at a 30° angle of elevation.

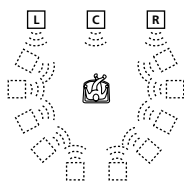

SMALL HALL

Reproduces the acoustics of a small rectangular concert hall. Ideal for soft acoustic sounds.

LARGE HALL

Reproduces the acoustics of a large rectangular concert hall. Ideal for soft acoustic sounds.

JAZZ CLUB

Reproduces the acoustics of a jazz club.

LIVE HOUSE

Reproduces the acoustics of a 300-seat live house. Great for rock or pop music.

GAME

Obtains maximum audio impact from video game software.

Be sure to set the game machine to stereo mode when using game software with stereo sound capabilities.

A.F.D. (AUTO FORMAT DECODING)

Automatically detects the type of audio signal being input (Dolby Digital, DTS, Dolby Pro Logic, or standard 2 channel stereo) and performs the proper decoding if necessary. This mode presents the sound as it was recorded/encoded, without adding any effects.

You can use this mode as a reference.

**N.SURROUND
(NORMAL SURROUND)**

Software with multichannel surround audio signals is played according to the way it was recorded.

Software with 2 channel audio signals, is decoded with Dolby Pro Logic to create surround effects.

2CH STEREO

Outputs the sound from the front left and right speakers and subwoofer. Standard two channel (stereo) sources completely bypass the sound field processing. Multi channel surround formats are downmixed to two channels.

This allows you to play any source using only the front left and right speakers and subwoofer.

HEADPHONE THEATER*

When you connect your headphone to the PHONES jack of the system, the HEADPHONE THEATER mode allows you to experience a theatre like environment while listening through a pair of headphones. This mode is very effective with 5.1 ch discreet signal sources such as Dolby Digital and DTS. Selecting any Sound Field selections (except AUTO FORMAT DECODING or 2CH STEREO) enables the mode.

*“VIRTUAL” sound field: Sound field with virtual speakers.

Notes

- The effects provided by the virtual speakers may cause increased noise in the playback signal.
- When listening to sound fields that employ the virtual speakers, you will not be able to hear any sound coming directly from the rear speakers.
- If you select AUTO FORMAT DECODING or 2CH STEREO when the headphones are connected, 2 channel stereo is output. If any other sound field is selected, it is automatically changed to the HEADPHONE THEATER mode.

Adjusting the level parameters



The level menu contains parameters that let you adjust the balance and speaker volumes of each speaker (page 26).

- 1 Start playing a programme source encoded with multichannel surround sound.**
- 2 Press AMP MENU repeatedly on the remote.**
♪ LEVEL appears on the front panel display.
- 3 Sit in your listening position and select the item to be adjusted using ↑/↓.**
- 4 Adjust the volume level using ←/→.**
The adjusted value will appear on the front panel display. If you do not operate the remote for a few seconds, the value turns off and is stored in the system.

Adjustable parameters for each sound field

	FRONT BAL.	REAR BAL.	REAR LEVEL	CENTER LEVEL	SUBWOOFER LEVEL
CINEMA STUDIO EX A	●	●	●	●	●
CINEMA STUDIO EX B	●	●	●	●	●
CINEMA STUDIO EX C	●	●	●	●	●
VIRTUAL MULTI DIMENSION	●	●	●	●	●
VIRTUAL SEMI MULTI DIMENSION	●			●	●
SMALL HALL	●	●	●	●	●
LARGE HALL	●	●	●	●	●
JAZZ CLUB	●	●	●	●	●
LIVE HOUSE	●	●	●	●	●
GAME	●	●	●	●	●
AUTO FORMAT DECODING	●	●	●	●	●
NORMAL SURROUND	●	●	●	●	●
2CH STEREO	●				●
HEADPHONE THEATER	●				

48^{GB}

DAV-S400 4-240-074-12(1)

Changing the Angles

If various angles (multi-angles) for a scene are recorded on the DVD, "ANGLE" appears in the front panel display. This means that you can change the viewing angle.

For example, while playing a scene of a train in motion, you can display the view from either the front of the train, the left window of the train, or from the right window without having the train's movement interrupted.

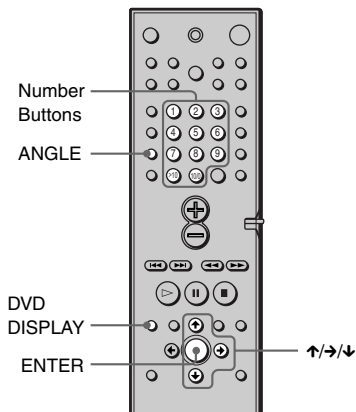

1 Press DVD DISPLAY during playback.

The Control Menu appears.

2 Press ↑/↓ to select (ANGLE).

The angle number appears. The number in parentheses indicates the total number of angles.

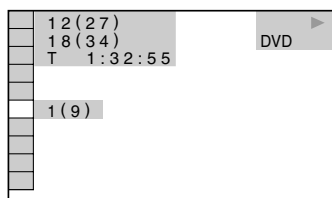

3 Press → or ENTER.

The angle number changes to "-."

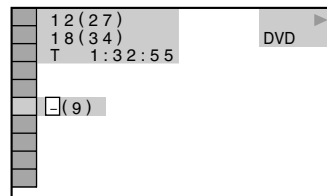

4 Select the angle number using the number buttons or ↑/↓, then press ENTER.

The angle is changed to the selected angle.

To turn off the Control Menu

Press DVD DISPLAY repeatedly until the Control Menu is turned off.

 You can select the angle directly by pressing ANGLE. Each time you press the button, the angle changes.

Note

Depending on the DVD, you may not be able to change the angles, even if multi-angles are recorded on the DVD.

Displaying the Subtitles

DVD

If subtitles are recorded on the discs, you can turn the subtitles on and off while playing. If multilingual subtitles are recorded on the disc, you can change the subtitle language while playing, or turn the subtitles on or off whenever you want. For example, you can select the language you want to practice and turn the subtitles on for better understanding.

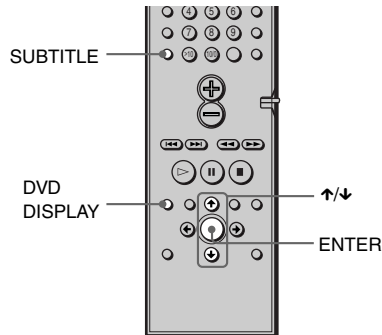

1 Press DVD DISPLAY during playback.

The Control Menu appears.

2 Press \uparrow/\downarrow to select (SUBTITLE), then press ENTER.

The options for SUBTITLE appear.

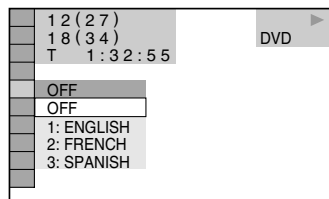

3 Press \uparrow/\downarrow to select the language.

Depending on the DVD, the choice of language varies.

When 4 digits are displayed, they indicate the language code. Refer to the language code list on page 77 to see which language the code represents.

4 Press ENTER.

To cancel the SUBTITLE setting

Select "OFF" in Step 3.

To turn off the Control Menu

Press DVD DISPLAY repeatedly until the Control Menu is turned off.

 You can select SUBTITLE directly by pressing SUBTITLE. Each time you press the button, the item changes.

Note

Depending on the DVD, you may not be able to change the subtitles even if multilingual subtitles are recorded on it.

Checking the Play Information (ADVANCED)

You can check information such as the bit rate or the disc layer that is being played. While playing a disc, an approximate bit rate of the playback picture is always displayed as Mbps (Mega bit per second) and the audio as kbps (kilo bit per second).

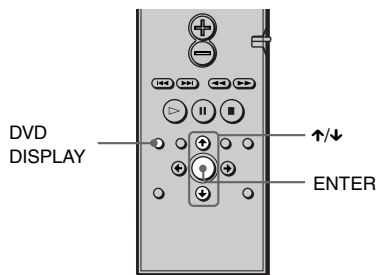

1 Press DVD DISPLAY during playback.

The Control Menu is displayed.

2 Press \uparrow/\downarrow to select (ADVANCED), then press ENTER.

The options for ADVANCED appear.

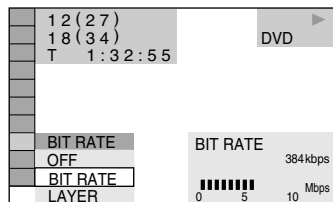

3 Press \uparrow/\downarrow to select the items.

For each item, please refer to “Displays of each item.”

- BIT RATE: displays the bit rate.
- LAYER: displays the layer and the pick-up point.

4 Press ENTER.

To close the ADVANCED window

Select “OFF” in Step 3.

To turn off the Control Menu

Press DVD DISPLAY repeatedly until the Control Menu is turned off.

Displays of each item

By pressing DVD DISPLAY repeatedly, you can display either “BIT RATE” or “LAYER,” whichever was selected in “ADVANCED.”

BIT RATE

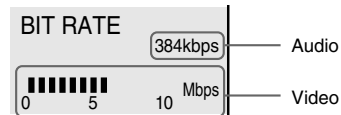

When playing MPEG audio sound tracks

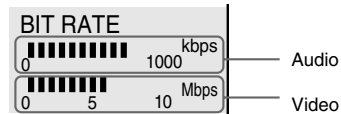

Bit rate refers to the amount of video/audio data per second in a disc. When the bit rate level is high, there is a large amount of data. However, this does not always mean that you can get higher quality pictures or sounds.

LAYER

Appears when the DVD has dual layers



Indicates the approximate point where the disc is playing.

If it is a dual-layer DVD, the system indicates which layer is being read (“Layer 0” or “Layer 1”).

For details on the layers, see page 73 (DVD).

Using Various Additional Functions

Locking Discs (CUSTOM PARENTAL CONTROL, PARENTAL CONTROL)

You can set two kinds of playback restrictions for a disc.

- Custom Parental Control
You can set the playback restrictions so that the system will not play inappropriate discs.
- Parental Control

Playback of some DVDs can be limited according to a predetermined level such as the age of the users.

The same password is used for both Parental Control and Custom Parental Control.

Custom Parental Control



You can set the same Custom Parental Control password for up to 50 discs. When you set the fifty-first-disc, the playback restriction for the first disc is cancelled.

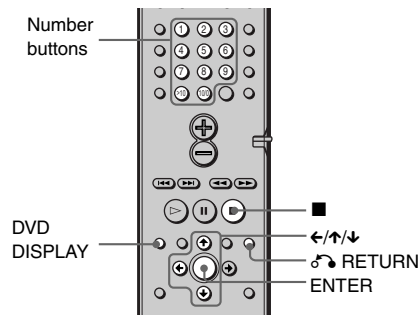

- 1 Insert the disc you want to lock.**
If the disc is playing, press ■ to stop playback.
- 2 In stop mode, press DVD DISPLAY.**
The Control Menu appears.

- 3 Press ↑/↓ to select (CUSTOM PARENTAL CONTROL), then press ENTER.**

“CUSTOM PARENTAL CONTROL” is selected.

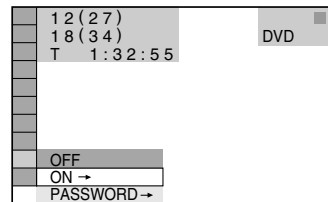

- 4 Press ↑/↓ to select “ON →,” then press ENTER.**

■When you have not entered a password

The display for registering a new password appears.

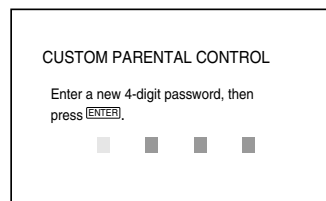

Enter a 4-digit password by using the number buttons, then press ENTER. The display for confirming the password appears.

■When you have already registered a password

The display for entering the password appears.

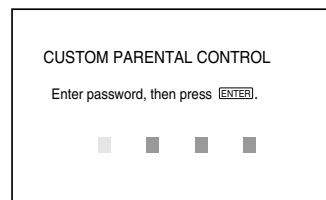

5 Enter or re-enter your 4-digit password by using the number buttons, then press ENTER.

“Custom parental control is set.” appears and the screen returns to the Control Menu display.

If you make a mistake entering your password

Press **←** before you press ENTER and input the correct number.

If you make a mistake

Press **↶** RETURN, then start from Step 3 again.

To turn off the Control Menu

Press **↶** RETURN, then press DVD DISPLAY repeatedly until the Control Menu is turned off.

To turn off the Custom Parental Control function

- 1 In Step 4, select “OFF →,” then press ENTER.
- 2 Enter your 4-digit password using the number buttons, then press ENTER.

To change the password

- 1 In Step 4, press **↑/↓** to select “PASSWORD →,” then press ENTER. The display for entering the password appears.
- 2 Enter your 4-digit password using the number buttons, then press ENTER.
- 3 Enter a new 4-digit password using the number buttons, then press ENTER.
- 4 To confirm your password, re-enter it using the number buttons, then press ENTER.

Playing the disc for which Custom Parental Control is set

1 Insert the disc for which Custom Parental Control is set.

The CUSTOM PARENTAL CONTROL display appears.

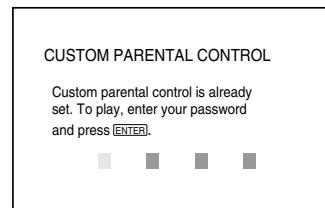

2 Enter your 4-digit password using the number buttons, then press ENTER.

The system is ready for playback.

💡 If you forget your password, enter the 6-digit number “199703” using the number buttons when the CUSTOM PARENTAL CONTROL display asks you for your password, then press ENTER. The display will ask you to enter a new 4-digit password.

Limiting playback for children (Parental Control) DVD

Playback of some DVDs can be limited according to a predetermined level such as the age of the users. The “Parental Control” function allows you to set a playback limitation level. A scene that is limited is not played, or it is replaced by a different scene.

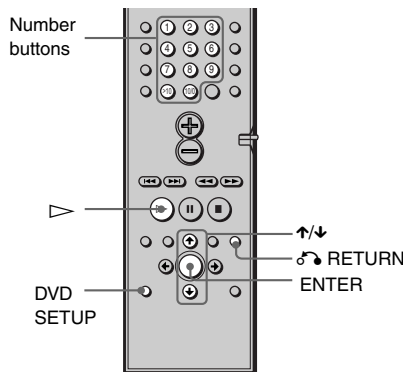

- 1 In stop mode, press DVD SETUP.**
The Setup Display appears.

- 2 Press \uparrow/\downarrow to select "CUSTOM SETUP," then press ENTER.**
"CUSTOM SETUP" is displayed.

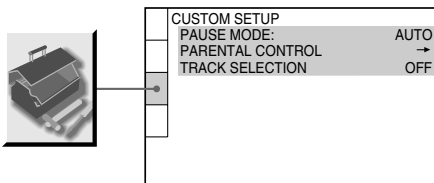

- 4 Enter or re-enter your password using the number buttons, then press ENTER.**
The display for setting the playback limitation level and changing the password appears.

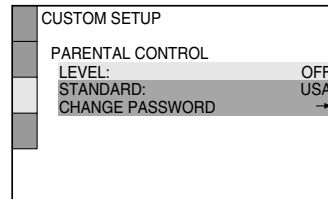

- 3 Press \uparrow/\downarrow to select "PARENTAL CONTROL →," then press ENTER.**

■ If you have not entered a password

The display for registering a new password appears.

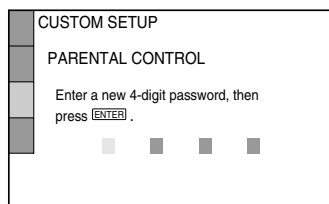

Enter a 4-digit password using the number buttons, then press ENTER. The display for confirming the password appears.

■ When you have already registered a password

The display for entering the password appears.

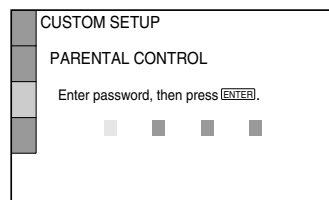

- 5 Press \uparrow/\downarrow to select "STANDARD," then press ENTER.**

The selection items for "STANDARD" are displayed.

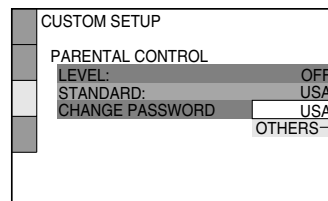

- 6 Press \uparrow/\downarrow to select a geographic area as the playback limitation level, then press ENTER.**

The area is selected.

If you select "OTHERS →," select and enter the standard code in the table on page 56 using the number buttons.

7 Press ENTER.

The selection items for "LEVEL" are displayed.

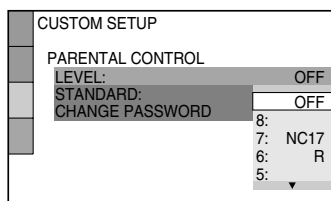

8 Select the level you want using ↑/↓, then press ENTER.

Parental Control setting is complete.

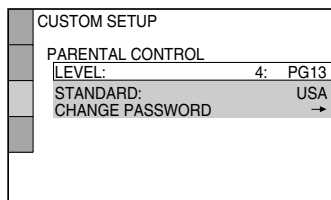

The lower the value, the more strict the limitation.

If you make a mistake

Press **↶** RETURN to go back to the previous screen.

To turn off the Setup Display

Press DVD SETUP repeatedly until the Setup Display is turned off.

To turn off the Parental Control function and play the DVD after entering your password

Set "LEVEL" to "OFF" in Step 8.

To change the password

1 In Step 5, select "CHANGE PASSWORD →" using ↓, then press ENTER.

The display for entering the password appears.

2 Follow Step 3 to enter a new password.

Playing the disc for which Parental Control is set

1 Insert the disc and press ▷.

The PARENTAL CONTROL display appears.

2 Enter your 4-digit password using the number buttons, then press ENTER.

The system starts playback.

💡 If you forget your password, remove the disc and repeat Step 1 to 5 of "Limiting playback for children." When you are asked to enter your password, enter "199703" using the number buttons, then press ENTER. The display will ask you to enter a new 4-digit password. After you enter a new 4-digit password in Step 3, replace the disc in the system and press ▷. When the PARENTAL CONTROL display appears, enter your new password.

Notes

- When you play DVDs which do not have the Parental Control function, playback cannot be limited on this system.
- Depending on the DVD, you may be asked to change the parental control level while playing the disc. In this case, enter your password, then change the level. If the Resume Play mode is cancelled, the level returns to the original level.

Area Code

Standard	Code number	Standard	Code number
Argentina	2044	Korea	2304
Australia	2047	Malaysia	2363
Austria	2046	Mexico	2362
Belgium	2057	Netherlands	2376
Brazil	2070	New Zealand	2390
Canada	2079	Norway	2379
Chile	2090	Pakistan	2427
China	2092	Philippines	2424
Denmark	2115	Portugal	2436
Finland	2165	Russia	2489
France	2174	Singapore	2501
Germany	2109	Spain	2149
Hong Kong	2219	Sweden	2499
India	2248	Switzerland	2086
Indonesia	2238	Taiwan	2543
Italy	2254	Thailand	2528
Japan	2276	United Kingdom	2184

Other Operations

Controlling the TV with the Supplied Remote

You can control your Sony TV with the supplied remote.

Controlling the TV with the remote

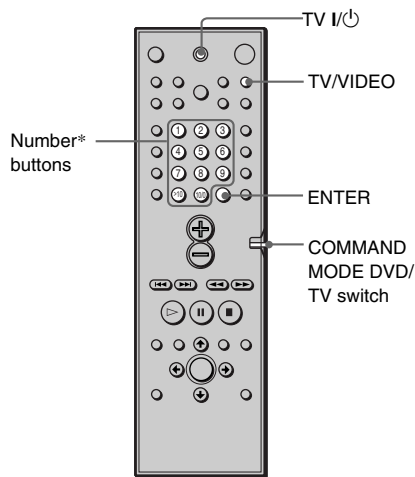

You can control your Sony TV using the buttons below.

By pressing	You can
TV I/O	Turn the TV on or off.
TV/VIDEO	Switch the TV's input source between the TV and other input sources.

Switching between TV and DVD

Using the COMMAND MODE DVD/TV switch, you can switch the remote signal between control of the TV and control of the DVD unit. When you watch the DVD, ensure that you have the COMMAND MODE DVD/TV switch set to DVD.

The table below shows the buttons that are affected by the COMMAND MODE DVD/TV switch.

Button	DVD	TV
1~9, >10, 10/0	Standard number button function for DVD.	Select channel numbers.
ENTER	Standard enter function for DVD.	Press after selecting a channel number.
◀◀	Standard preceding title, chapter skip function for DVD.	CH -
▶▶	Standard forward title, chapter skip for DVD.	CH +
⊕	VOL +	VOL +
⊖	VOL -	VOL -

Note

Depending on the TV, you may not be able to control your TV or to use some of the buttons above.

When you enter a double digit number Depending on the TV set, you can also enter the number as follows: Press >10, then the number. (For example, press >10, then 2 and 5 for entering 25.)

Listening to other audio units

You can use MD decks or other units connected to the AUDIO 1 or AUDIO 2 jacks. Refer to the operation manual supplied with the unit for further information on the operation.

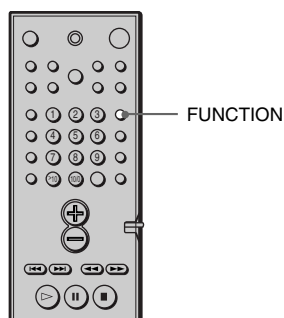

Press FUNCTION repeatedly until AUDIO 1 or AUDIO 2 that you connected the unit to appears on the front panel display.

Each time you press FUNCTION, the mode of the system changes in the following sequence.

DVD → AUDIO 1 → AUDIO 2 →
TUNER → DVD...

Listening to the Radio

Preset radio stations in the system's memory first (see "Presetting Radio Stations" on page 28).

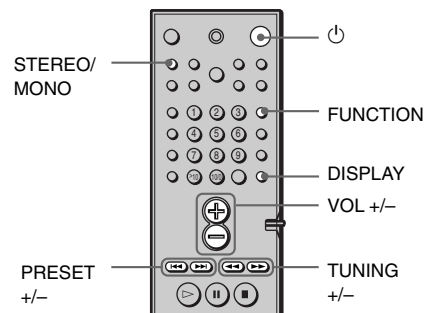

1 Press FUNCTION repeatedly until TUNER appears on the front panel display.

The last received station is tuned in.

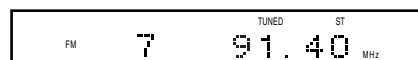

2 Press PRESET + or PRESET - repeatedly to select the preset station you want.

Each time you press the button, the system tunes in one preset station.

3 Adjust the volume by pressing VOL +/-.

To turn off the radio

Press .

To listen to non-preset radio stations

Use manual or automatic tuning in Step 2.
For manual tuning, press ◀◀ or ▶▶ (TUNING + or -) on the remote repeatedly.
For automatic tuning, press and hold ◀◀ or ▶▶ (TUNING + or -) on the remote.

💡 If an FM programme is noisy

Press STEREO/MONO on the remote so that "MONO" appears on the front panel display. There will be no stereo effect, but the reception will improve. Press the button again to restore the stereo effect.

💡 To improve reception

Reorient the supplied antennas.

To check the frequency or sound field

Press DISPLAY repeatedly.
Each time you press DISPLAY, the front panel display changes as follows:
index name of the station → frequency → sound field → index name of the station

Using the Radio Data System (RDS)

What is the Radio Data System?

Radio Data System (RDS) is a broadcasting service that allows radio stations to send additional information along with the regular programme signal. This tuner offers convenient RDS features such as station name display. RDS is available only for FM stations.*

Note

RDS may not work properly if the station you are tuned to is not transmitting the RDS signal properly, or if the signal strength is weak.

* Not all FM stations provide RDS service, nor do they provide the same type of services. If you are not familiar with the RDS system, check with your local radio stations for details on RDS services in your area.

Receiving RDS broadcasts

Simply select a station from the FM band. When you tune in a station that provides RDS services, the station name appears in the display.

To check the RDS information

Each time you press DISPLAY, the display changes as follows:

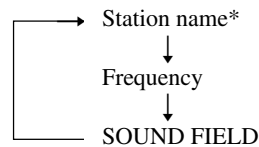

* If the RDS broadcast is not received, the station name may not appear in the display.

Naming Preset Stations

You can enter a name of up to 8 characters for preset stations. These names (for example, "XYZ") appear in the system's front panel display when a station is selected.

Note that no more than one name can be entered for each preset station.

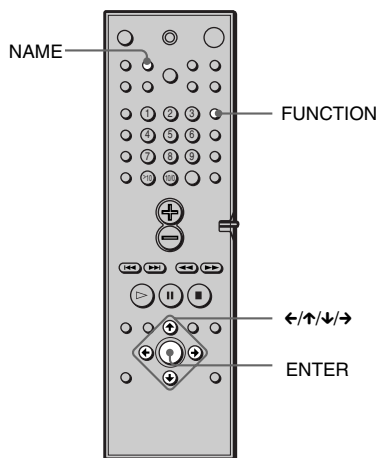

1 Press FUNCTION repeatedly until TUNER appears on the front panel display.

The last station you received is tuned in.

Each time you press FUNCTION, the mode of the system changes in the following sequence:

DVD → AUDIO 1 → AUDIO 2 →
TUNER → DVD...

2 Tune in the preset station you want to create an index name for.

If you are not familiar with how to tune in preset stations, see "Listening to the Radio" on page 58.

3 Press NAME.

4 Create an index name by using the cursor buttons:

Press ↓/↑ to select a character, then press → to move the cursor to the next position.

If you make a mistake

Press ← or → repeatedly until the character to be changed flashes, then press ↓/↑ to select the right character.

5 Press ENTER.

To assign index names to other stations

Repeat Steps 2 to 5.

Using the Setup Display



By using the Setup Display, you can make various adjustments to items such as picture and sound. You can also set a language for the subtitles and the Setup Display, among other things. For details on each Setup Display item, see page 62-68. For an overall list of Setup Display items, see page 78.

How to use the Setup Display

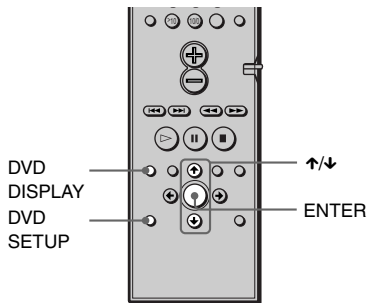

- 1 In stop mode, press DVD DISPLAY.**
The Control Menu appears.
If you press DVD SETUP, you can go to Step 3 directly.
- 2 Press \uparrow/\downarrow to select  (SETUP), then press ENTER.**
The options for SETUP appear.

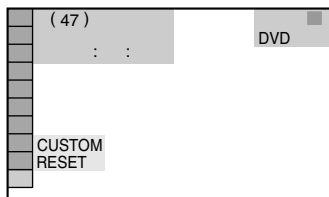

- 3 Press \uparrow/\downarrow to select "CUSTOM," then press ENTER.**
The Setup Display appears.

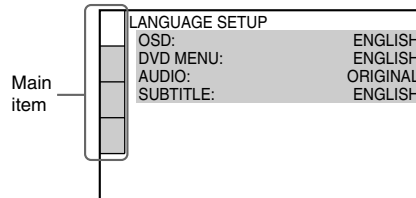

- 4 Press \uparrow/\downarrow to select the setup item from the displayed list: "LANGUAGE SETUP," "SCREEN SETUP," "CUSTOM SETUP," and "SPEAKER SETUP." Then press ENTER.**
The selected Setup item appears.
Example: "SCREEN SETUP"

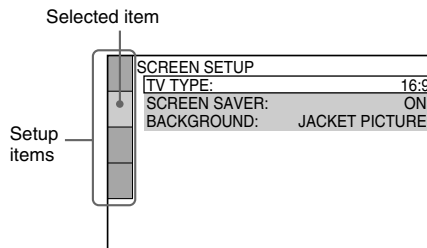

5 Select an item using \uparrow/\downarrow , then press **ENTER**.

The options for the selected item appear.
Example: "TV TYPE"

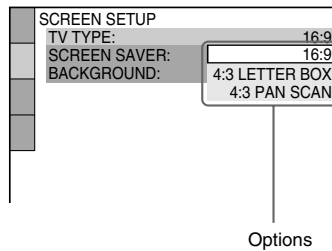

6 Select a setting using \uparrow/\downarrow , then press **ENTER**.

The setting is selected and setup is complete.
Example: "4:3 PAN SCAN"

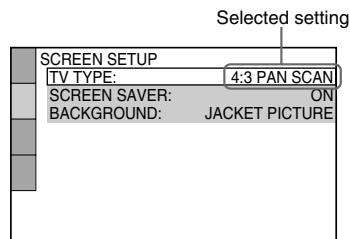

To turn off the Setup Display

Press **DVD SETUP** or **DVD DISPLAY** repeatedly until the Setup Display is turned off.

If you select "RESET" in Step 2, you can reset all of the "SETUP" settings on page 78 (except for PARENTAL CONTROL) to the default settings. After you select "RESET" and press **ENTER**, select "YES" to reset the settings (it takes a few seconds to complete), or select "NO" and press **ENTER** to return to the Control Menu. Do not press **POWER** on the system or when resetting the system.

Setting the Display or Sound Track Language

(LANGUAGE SETUP)



"LANGUAGE SETUP" allows you to set various languages for the on-screen display or sound track.

Select "LANGUAGE SETUP" in the Setup Display. For details on using the display, see "Using the Setup Display" (page 61).

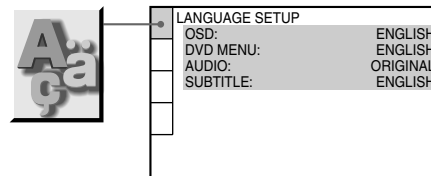

■ **OSD (On-Screen Display)**

Switches the display language on the screen. Selects the language from the displayed list.

■ **DVD MENU (DVD only)**

Selects the desired language for the DVD menu.

■ **AUDIO (DVD only)**

Switches the language of the sound track. Selects the language from the displayed list. When you select "ORIGINAL," the language given priority in the disc is selected.

■ **SUBTITLE (DVD only)**

Switches the language of the subtitle. Selects the language from the displayed list. When you select "AUDIO FOLLOW," the language for the subtitles changes according to the language you selected for the sound track.

 If you select "OTHERS →" in "DVD MENU," "SUBTITLE," or "AUDIO," select and enter the language code from the list using the number buttons (page 77). After you have made a selection, the language code (4 digits) is displayed the next time you select "OTHERS →."

Note

If you select a language that is not recorded on the DVD, one of the recorded languages will be automatically selected (except for the "OSD").

Settings for the Display

(SCREEN SETUP)   

Choose settings according to the TV to be connected.

Select "SCREEN SETUP" in the Setup Display. For details on using the display, see "Using the Setup Display" (page 61). The default settings are underlined>.

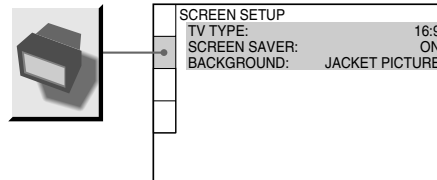

■ TV TYPE (DVD only)

Selects the aspect ratio of the connected TV (4:3 standard or wide).

The default settings vary, depending on the country model.

16:9	Select this when you connect a wide-screen TV or a TV with a wide mode function.
4:3 LETTER BOX	Select this when you connect a 4:3 screen TV. Displays a wide picture with bands on the upper and lower portions of the screen.
4:3 PAN SCAN	Select this when you connect a 4:3 screen TV. Automatically displays the wide picture on the entire screen and cuts off the portions that do not fit.

16:9



4:3 LETTER BOX



4:3 PAN SCAN



Note

Depending on the DVD, “4:3 LETTER BOX” may be selected automatically instead of “4:3 PAN SCAN” or vice versa.

SCREEN SAVER

Turns the screen saver on and off so that the screen saver image appears when you leave the system in pause or stop mode for 15 minutes, or when you playback a CD for more than 15 minutes. The screen saver will help prevent your display device from becoming damaged (ghosting). Press \blacktriangleright to turn off the screen saver.

<u>ON</u>	Turns on the screen saver.
OFF	Turns off the screen saver.

BACKGROUND

Selects the background colour or picture on the TV screen in stop mode or while playing a CD.

<u>JACKET PICTURE</u>	The jacket picture (still picture) appears in the background, but only when the jacket picture is already recorded on the disc (CD-EXTRA, etc.). If the disc does not contain a jacket picture, the “GRAPHICS” picture appears.
GRAPHICS	A preset picture stored in the system appears in the background.
BLUE	The background colour is blue.
BLACK	The background colour is black.

Custom Settings (CUSTOM

SETUP) **DVD** **VIDEO CD** **SA-CD CD**

Allows setting up Parental Control and other settings.

Select “CUSTOM SETUP” in the Setup Display. For details on using the display, see “Using the Setup Display” (page 61). The default settings are underlined.

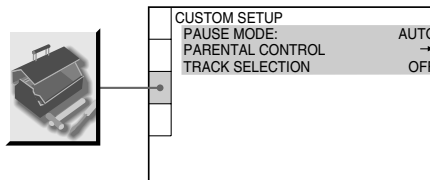

PAUSE MODE (DVD only)

Selects the picture in pause mode.

<u>AUTO</u>	The picture, including subjects that move dynamically, is output with no jitter. Normally select this position.
FRAME	The picture, including subjects that do not move dynamically, is output in high resolution.

PARENTAL CONTROL → (DVD only)

Sets a password and playback limitation level for DVDs with playback limitation for children. For details, see “Limiting playback for children (Parental Control)” (page 53).

■ TRACK SELECTION (DVD only)

Gives the sound track having the highest number of channels priority when you play a DVD on which multiple audio formats (PCM, MPEG audio, DTS, or Dolby Digital format) are recorded.

OFF	No priority given.
AUTO	Priority given.

Notes

- When you set the item to "AUTO," the language may change. The "TRACK SELECTION" setting has higher priority than the "AUDIO" settings in "LANGUAGE SETUP" (page 62).
- If PCM, DTS, MPEG audio, and Dolby Digital sound tracks have the same number of channels, the system selects PCM, DTS, Dolby Digital, and MPEG audio sound tracks in this order.
- Depending on the DVD, the audio channel with priority may be predetermined. In this case, you cannot give priority to the DTS, Dolby Digital, or MPEG audio format by selecting "AUTO."

Settings for the Speakers (SPEAKER SETUP)

To obtain the best possible surround sound, set the size of the speakers you have connected and their distance from your listening position. Then use the test tone to adjust the volume and the balance of the speakers to the same level.

Select "SPEAKER SETUP" in the setup display. For details, see "Using the Setup Display" (page 61).

The default settings are underlined.

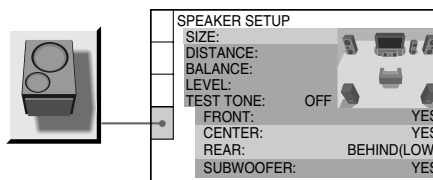

To return to the default setting

Select the item, then press CLEAR.

■ SIZE

When you do not connect centre or rear speakers, or move the rear speakers, set the parameters for CENTER and REAR. Since the front speakers and subwoofer settings are fixed, you cannot change them. The default settings are underlined.

- FRONT
 - YES
- CENTER
 - YES: Normally select this.
 - NONE: Select this if no centre speaker is used.

- REAR
 - BEHIND (LOW), BEHIND (HIGH), SIDE (LOW), SIDE (HIGH): Specify the position and height to implement the Digital Cinema Surround modes in the “Virtual Multi Dimension” sound field (page 47) properly.
 - NONE: Select this if no rear speaker is used.
- SUBWOOFER
 - YES

Notes

- When you select an item, the sound cuts off for a moment.
- Depending on the settings of other speakers, the subwoofer may output excessive sound.

Specifying the rear speaker position and height

If you select anything other than “NONE” in “REAR,” specify the position and height of the rear speakers. The default setting is underlined.

<u>BEHIND (LOW)</u>	Select this if the rear speakers are located in section B and D .
<u>BEHIND (HIGH)</u>	Select this if the rear speakers are located in section B and C .
<u>SIDE (LOW)</u>	Select this if the rear speakers are located in section A and D .
<u>SIDE (HIGH)</u>	Select this if the rear speakers are located in section A and C .

These parameters are not available when “REAR” is set to “NONE.”

Position diagram

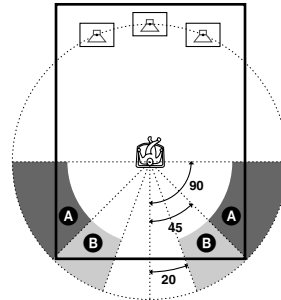

Height diagram

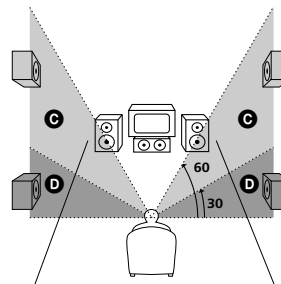

■ DISTANCE

The default distance setting for the speakers in relation to the listening position is shown below.

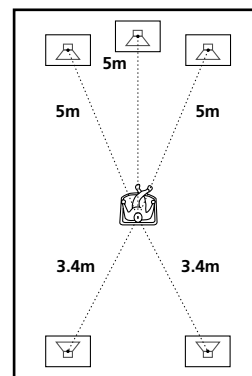

Be sure to change the value in the Setup Display when you move the speakers. The default settings are underlined.

FRONT <u>5m</u>	Front speaker distance from the listening position can be set in 0.2 meter increments from 1 to 15 meters.
CENTER <u>5m</u>	Centre speaker distance can be moved up to 1.6 meters forward closer to the listening position, in 0.2 meter increments.
REAR <u>3.4m</u>	Rear speaker distance can be moved up to 4.6 meters closer to your listening position from the front speaker position, in 0.2 meter increments.

Notes

- When you set the distance, the sound cuts off for a moment.
- If each of the front or rear speakers are not placed at an equal distance from your listening position, set the distance according to the closest speaker.
- Do not place the rear speakers farther away from your listening position than the front speakers.

BALANCE

You can vary the balance of the left and right speakers as follows. Be sure to set “TEST TONE” to “ON” for easy adjustment. The default settings are underlined.

FRONT <u>CENTRE</u>	Adjust the balance between the front left and right speakers (You can adjust from centre 6 steps left or right).
REAR <u>CENTRE</u>	Adjust the balance between the rear left and right speakers (You can adjust from centre 6 steps left or right).

LEVEL

You can vary the level of each speaker as follows. Be sure to set “TEST TONE” to “ON” for easy adjustment. The default settings are underlined.

CENTER <u>0dB</u>	Adjusts the level of the centre speaker (You can adjust from -6 dB to +6 dB in 1dB steps).
REAR <u>0dB</u>	Adjusts the level of the rear speakers (You can adjust from -6 dB to +6 dB in 1dB steps).
SUBWOOFER <u>0dB</u>	Adjusts the level of the subwoofer (You can adjust from -6 dB to +6 dB in 1dB steps).

To adjust the volume of all the speakers at one time

Use the VOLUME control on the system or press VOL +/-.

TEST TONE

The speakers will emit a test tone to adjust “BALANCE” and “LEVEL.” The default settings are underlined.

<u>OFF</u>	The test tone is not emitted from the speakers.
<u>ON</u>	The test tone is emitted from each speaker in sequence while adjusting balance or level. When you select one of the “SPEAKER SETUP” items, the test tone is emitted from both left and right speakers simultaneously.

Adjusting the speaker volume and level

- 1** After you stop playback, select "SPEAKER SETUP" after pressing DVD SETUP in the Setup Display.
- 2** Select "TEST TONE" and set "TEST TONE" to "ON."
You will hear the test tone from each speaker in sequence.
- 3** From your listening position, select "BALANCE" or "LEVEL" and adjust the value of "BALANCE" and "LEVEL" using \uparrow/\downarrow .
The test tone is emitted from both left and right speakers simultaneously.
- 4** Select "TEST TONE" and set "TEST TONE" to "OFF" to turn off the test tone.

Note

When you adjust the speaker settings, the sound cuts off for a moment.

Troubleshooting

If you experience any of the following difficulties while using the system, use this troubleshooting guide to help remedy the problem before requesting repairs. Should any problem persist, consult your nearest Sony dealer.

Power

The power is not turned on.

- ➔ Check that the AC power cord (mains lead) is connected securely.

Picture

There is no picture.

- ➔ The connecting cords are not connected securely.
- ➔ The connecting cords are damaged.
- ➔ The system is not connected to the correct TV input jack (page 21).
- ➔ The video input on the TV is not set so that you can view pictures from the system.

Picture noise appears.

- ➔ The disc is dirty or flawed.
- ➔ If the picture output from your system goes through your VCR to get to your TV, the copy-protection signal applied to some DVD programmes could affect picture quality.

Even though you set the aspect ratio in "TV TYPE" or "SCREEN SETUP," the picture does not fill the screen.

- ➔ The aspect ratio of the disc is fixed on your DVD.

The picture is black and white.

- ➔ Depending on the TV, the picture on the screen becomes black and white when you play a disc recorded in the NTSC colour system.

Sound

There is no sound.

- ➔ The connecting cord is not connected securely.
- ➔ The connecting cord is damaged.
- ➔ Press MUTING on the remote if "MUTING ON" is displayed on the front panel display.
- ➔ The protective device on the system has been activated because of a short circuit. Turn off the system, eliminate the short-circuit problem and turn on the power again.
- ➔ The audio connecting cord is damaged. Replace it with a new one.
- ➔ The system is in pause mode or in Slow-motion Play mode. Press ▷ to return to normal play mode.
- ➔ Fast forward or fast reverse is performed. Press ▷ to return to normal play mode.
- ➔ Check the speaker settings (pages 23, 65).

The left and right sounds are unbalanced or reversed.

- ➔ Check that the speakers and components are connected correctly and securely.
- ➔ Adjust the front balance parameter in the LEVEL menu (pages 26, 67).

Severe hum or noise is heard.

- ➔ Check that the speakers and components are connected securely.
- ➔ Check that the connecting cords are away from a transformer or motor, and at least 3 meters away from a TV set or fluorescent light.
- ➔ Move your TV away from the audio components.
- ➔ The plugs and jacks are dirty. Wipe them with a cloth slightly moistened with alcohol.
- ➔ Clean the disc.

The sound loses stereo effect when you play a VIDEO CD, or a CD.

- ➔ Set "AUDIO" to "STEREO" in the Control Menu display (page 44).
- ➔ Make sure you connect the system appropriately.

The surround effect is difficult to hear when you are playing a Dolby Digital sound track.

- ➔ Make sure the sound field function is on (page 46).
- ➔ Check the speaker connections and settings (pages 23, 65).
- ➔ Depending on the DVD, the output signal may not be the entire 5.1 channels. It may be monaural or stereo even if the sound track is recorded in Dolby Digital format.

The surround effect is difficult to hear when you are playing a Dolby Digital or MPEG audio sound track.

- ➔ Check the speaker connections and setting (pages 23, 65).
- ➔ Depending on the DVD, the output signal may not be the entire 5.1 channels. It may be monaural or stereo even if the sound track is recorded in Dolby Digital or MPEG audio format.

The sound comes from the centre speaker only.

- ➔ Depending on the disc, the sound may come from the centre speaker only.

No sound is heard from the centre speaker.

- ➔ Make sure the sound field function is on (page 46).
- ➔ Select a sound field containing the word "cinema" or "virtual" (page 46).

No sound or only a very low-level sound is heard from the rear speakers.

- ➔ Make sure the sound field function is on (page 46).
- ➔ Select a sound field containing the word "cinema" or "virtual" (page 46).

Operation

Radio stations cannot be tuned in.

- ➔ Check that the antennas are connected securely. Adjust the antennas and connect an external antenna if necessary.
- ➔ The signal strength of the stations is too weak (when tuning in with automatic tuning). Use direct tuning.
- ➔ No stations have been preset or the preset stations have been cleared (when tuning by scanning preset stations). Preset the stations (page 28).
- ➔ Press DISPLAY so that the frequency appears in the display.

The remote does not function.

- ➔ There are obstacles between the remote and the system.
- ➔ The distance between the remote and the system is too far.
- ➔ The remote is not pointed at the remote sensor on the system.
- ➔ The batteries in the remote are weak.

The disc does not play.

- ➔ There is no disc inside.
- ➔ The disc is turned over.
Insert the disc with the playback side facing down on the disc tray.
- ➔ The disc is skewed.
- ➔ The system cannot play CD-ROMs, etc. (page 7).
- ➔ The region code on the DVD does not match the system.
- ➔ Moisture has condensed inside the system.
Remove the disc and leave the system turned on for about half an hour (page 3).

The disc does not start playing from the beginning.

- ➔ Programme Play, Shuffle Play, or Repeat Play has been selected (pages 34, 36, 37). Press CLEAR to cancel these functions before playing a disc.
- ➔ Resume Play has been selected. During stop, press ■ on the system or the remote and then start DVD playback (page 31).
- ➔ The title, DVD or PBC menu automatically appears on the TV screen.

The system starts playing the disc automatically.

- ➔ The DVD features an auto playback function.

Playback stops automatically.

- ➔ Some discs may contain an auto pause signal. While playing such a disc, the system stops playback at the auto pause signal.

You cannot perform some functions such as Stop, Search, Slow-motion Play, Repeat Play, Shuffle Play, or Programme Play.

- ➔ Depending on the disc, you may not be able to do some of the operations above. See the operating manual that comes with the disc.

Messages do not appear on the screen in the language you want.

- ➔ In the Setup Display, select the desired language for the on-screen display in "OSD" under "LANGUAGE SETUP" (page 62).

The language for the sound track cannot be changed.

- ➔ Multilingual tracks are not recorded on the DVD being played.
- ➔ The DVD prohibits changing the language for the sound track.

The subtitle language cannot be changed.

- ➔ Multilingual subtitles are not recorded on the DVD being played.
- ➔ The DVD prohibits changing the subtitles.

The subtitle cannot be turned off.

- ➔ The DVD prohibits turning off subtitles.

The angles cannot be changed.

- ➔ Multi-angles are not recorded on the DVD being played. The angle can be changed only when the "ANGLE" indicator lights up on the front panel display.
- ➔ The DVD prohibits changing the angles.

The system does not operate properly.

- ➔ If static electricity, etc., causes the system to operate abnormally, press POWER on the system to turn the system off and then on again.

Nothing is displayed on the front panel display.

- ➔ Press DIMMER on the remote.

A 5-character service number is displayed on the screen and on the front panel display.

- ➔ The self-diagnosis function was activated. (See the table on page 72.)

The disc tray does not open and "LOCKED" appears on the front panel display.

- ➔ Contact your Sony dealer or local authorized Sony service facility.

"PROTECT" appears on the front panel display.

- ➔ The speaker protection circuit is in function. Check the speaker connections.

Self-diagnosis Function

(When letters/numbers appear in the display)

The self-diagnosis function is activated to prevent the system from malfunctioning. In this case, a five-character service number (e.g., C 13 00) with a combination of a letter and digits appears on the screen and the front panel display. Refer to the following table.

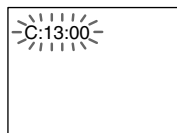

First three characters of the service number	Cause and/or Corrective Action
C 13	The disc is dirty. ➔ Clean the disc with a soft cloth (page 8).
C 31	The disc is not inserted correctly. ➔ Re-insert the disc correctly.
E XX (xx is a number)	To prevent a malfunction, the system has performed the self-diagnosis function. ➔ Contact your nearest Sony dealer or local authorized Sony service facility and give the 5-character service number. Example: E 61 10

Glossary

Bit rate

Value indicating the amount of video data compressed in a DVD per second. The unit is Mbps (Mega bit per second). 1 Mbps indicates that the data per second is 1,000,000 bits. The higher the bit rate is, the larger the amount of data. However, this does not always mean that you can get higher quality pictures.

Chapter

Sections of a picture or a music piece on a DVD that are smaller than titles. A title is composed of several chapters. Each chapter is assigned a chapter number enabling you to locate the chapter you want.

Digital Cinema Sound (DCS)

This is the generic name of the surround sound produced by digital signal processing technology developed by Sony. Unlike previous surround sound fields mainly directed at the reproduction of music, Digital Cinema Sound is designed specifically for the enjoyment of movies.

Dolby Digital

This sound format for movie theaters is more advanced than Dolby Pro Logic Surround. In this format, the rear speakers output stereo sound with an expanded frequency range and a subwoofer channel for deep bass is independently provided. This format is also called "5.1" because the subwoofer channel is counted as 0.1 channel (since it functions only when a deep bass effect is needed). All six channels in this format are recorded separately to realize superior channel separation. Furthermore, since all the signals are processed digitally, less signal degradation occurs.

Dolby Pro Logic Surround

As one method of decoding Dolby Surround, Dolby Pro Logic Surround produces four channels from two-channel sound. Compared with the former Dolby Surround system, Dolby Pro Logic Surround reproduces left-to-right panning more naturally and localizes sounds more precisely. To take full advantage of Dolby Pro Logic Surround, you should have one pair of rear speakers and a centre speaker. The rear speakers output monaural sound.

DTS

Digital audio compression technology that the Digital Theater Systems, Inc. developed. This technology conforms to 5.1-channel surround. The rear channel is stereo and there is discrete subwoofer channel in this format. DTS provides the same 5.1 discrete channels of high quality digital audio. The good channel separation is realized because all the channel data is recorded discrete and processed in digital.

DVD

A disc that contains up to 8 hours of moving pictures even though its diameter is the same as a CD.

The data capacity of a single-layer and single-sided DVD, at 4.7 GB (Giga Byte), is 7 times that of a CD. Furthermore, the data capacity of a dual-layer and single-sided DVD is 8.5 GB, a single-layer and double-sided DVD 9.4 GB, and a dual-layer and double-sided DVD 17 GB.

The picture data uses the MPEG 2 format, one of the worldwide standards of digital compression technology. The picture data is compressed to about 1/40 of its original size. The DVD also uses the variable rate coding technology that changes the data to be allocated according to the status of the picture.

The audio data is recorded in Dolby Digital as well as in PCM, allowing you to enjoy more real audio presence.

Furthermore, various advanced functions such as the multi-angle, multilingual, and Parental Control functions are provided with the DVD.

Multi-angle function

Various angles, or viewpoints of the video camera for a scene are recorded on some DVDs.

Multilingual function

Several languages for the sound or subtitles in a picture are recorded on some DVDs.

Parental Control

A function of the DVD to limit playback of the disc by the age of the users according to the limitation level in each country. The limitation varies from disc to disc; when it is activated, playback is completely prohibited, violent scenes are skipped or replaced with other scenes and so on.

Playback Control (PBC)

Signals encoded on VIDEO CDs (Version 2.0) to control playback.

By using menu screens recorded on VIDEO CDs with PBC functions, you can enjoy playing simple interactive programmes, programmes with search functions, and so on.

Region Code

This system is used to protect copyrights. A region number is allocated on each DVD system or DVD disc according to the sales region. Each region code is shown on the system as well as on the disc packaging. The system can play the discs that match its region code. The system can also play discs with the “” mark. Even when the region code is not shown on the DVD, the region limit may still be activated.

Title

The longest section of a picture or music feature on a DVD, movie feature on a DVD, movie, etc., in video software or the entire album in audio software. Each title is assigned a title number enabling you to locate the title you want.

Track

Sections of a picture or a music piece on a CD or VIDEO CD. Each track is assigned a track number enabling you to locate the track you want.

VIDEO CD

A compact disc that contains moving pictures.

The picture data uses the MPEG 1 format, one of the worldwide standards of digital compression technology. The picture data is compressed to about 1/140 of its original size. Consequently, a 12 cm VIDEO CD can contain up to 74 minutes of moving pictures. VIDEO CDs also contain compact audio data. Sounds outside the range of human hearing are compressed while the sounds we can hear are not compressed. VIDEO CDs can hold 6 times the audio information of conventional audio CDs.

There are 2 versions of VIDEO CDs.

- Version 1.1: You can play only moving pictures and sounds.
- Version 2.0: You can play high-resolution still pictures and enjoy PBC functions.

This system conforms to both versions.

Super Audio CD

This audio format is based upon the current audio CD standards but includes a greater amount of information which provides higher quality sound. There are three types of discs: single layer, double layer and hybrid discs. The hybrid disc contains both standard audio CD and Super Audio CD information.

Specifications

Amplifier section

Stereo mode	40 W + 40 W (6 ohms at 1 kHz, THD 10 %)
Surround mode	Front: 40 W + 40 W Center*: 40 W Rear*: 40 W + 40 W (6 ohms at 1 kHz, THD 10 %) Subwoofer*: 100 W (3 ohms at 100 Hz, THD 10 %)

* Depending on the sound field settings and the source, there may be no sound output.

Inputs (Analog)	AUDIO 1, 2: Sensitivity: 150 mV Impedance: 50 kilohms
Inputs (Digital)	AUDIO 2 (optical): Sensitivity: –
Outputs (Analog)	AUDIO 1 (AUDIO OUT): Voltage: 2 V Impedance: 1 kilohms PHONES: Accepts low- and high-impedance headphones

Super Audio CD/DVD system

Laser	Semiconductor laser (Super Audio CD/DVD: $\lambda = 650$ nm) (CD: $\lambda = 780$ nm) Emission duration: continuous
Frequency response (at 2CH STEREO mode)	DVD (PCM): 2 Hz to 22 kHz (± 1.0 dB) CD: 2 Hz to 20 kHz (± 1.0 dB)
Signal-to-noise ratio	More than 80 dB (AUDIO 1 (AUDIO) connectors only)
Harmonic distortion	Less than 0.03 %

FM tuner section

System	PLL quartz-locked digital synthesizer system
Tuning range	87.5 – 108.0 MHz (50 kHz step)
Antenna	FM wire antenna
Antenna terminals	75 ohms, unbalanced
Intermediate frequency	10.7 MHz

AM tuner section

System	PLL quartz-locked digital synthesizer system
Tuning range	531 – 1,602 kHz (with the interval set at 9 kHz)
Antenna	Loop antenna
Intermediate frequency	450 kHz

Additional Information

continued

75^{GB}

DAV-S400 4-240-074-12(1)

Video Section

Outputs Video: 1 Vp – p, 75 ohms

Speakers**Front/Centre/Rear (SS–TS501)**

Speaker system	Bass reflex
Speaker unit	80 mm dia. cone type
Rated impedance	6 ohms
Dimensions (approx.)	97 × 102 × 105 mm (w/h/d)
Mass (approx.)	0.5 kg

Subwoofer (SS–WS501)

Speaker system	Bass reflex
Speaker unit	200 mm dia. cone type
Rated impedance	3 ohms
Dimensions (approx.)	160 × 355 × 355 mm (w/h/d)
Mass (approx.)	5.5 kg

General

Power requirements	220 – 240 V AC, 50/60 Hz
Power consumption	98 W 2 W (in the standby mode)
Dimensions (approx.)	355 × 70 × 378 mm (w/h/d) incl. projecting parts
Mass (approx.)	4.0 kg
Operating temperature	5°C to 35°C
Operating humidity	5 % to 90 %
Supplied accessories	See page 15.

Design and specifications are subject to change without notice.

Language Code List

For details, see pages 44, 50, 62.

The language spellings conform to the ISO 639: 1988 (E/F) standard.

Code Language	Code Language	Code Language	Code Language
1027 Afar	1183 Irish	1347 Maori	1507 Samoan
1028 Abkhazian	1186 Scots Gaelic	1349 Macedonian	1508 Shona
1032 Afrikaans	1194 Galician	1350 Malayalam	1509 Somali
1039 Amharic	1196 Guarani	1352 Mongolian	1511 Albanian
1044 Arabic	1203 Gujarati	1353 Moldavian	1512 Serbian
1045 Assamese	1209 Hausa	1356 Marathi	1513 Siswati
1051 Aymara	1217 Hindi	1357 Malay	1514 Sesotho
1052 Azerbaijani	1226 Croatian	1358 Maltese	1515 Sundanese
1053 Bashkir	1229 Hungarian	1363 Burmese	1516 Swedish
1057 Byelorussian	1233 Armenian	1365 Nauru	1517 Swahili
1059 Bulgarian	1235 Interlingua	1369 Nepali	1521 Tamil
1060 Bihari	1239 Interlingue	1376 Dutch	1525 Telugu
1061 Bislama	1245 Inupiak	1379 Norwegian	1527 Tajik
1066 Bengali; Bangla	1248 Indonesian	1393 Occitan	1528 Thai
1067 Tibetan	1253 Icelandic	1403 (Afan)Oromo	1529 Tigrinya
1070 Breton	1254 Italian	1408 Oriya	1531 Turkmen
1079 Catalan	1257 Hebrew	1417 Punjabi	1532 Tagalog
1093 Corsican	1261 Japanese	1428 Polish	1534 Setswana
1097 Czech	1269 Yiddish	1435 Pashto; Pushto	1535 Tonga
1103 Welsh	1283 Javanese	1436 Portuguese	1538 Turkish
1105 Danish	1287 Georgian	1463 Quechua	1539 Tsonga
1109 German	1297 Kazakh	1481 Rhaeto- Romance	1540 Tatar
1130 Bhutani	1298 Greenlandic	1482 Kirundi	1543 Twi
1142 Greek	1299 Cambodian	1483 Romanian	1557 Ukrainian
1144 English	1300 Kannada	1489 Russian	1564 Urdu
1145 Esperanto	1301 Korean	1491 Kinyarwanda	1572 Uzbek
1149 Spanish	1305 Kashmiri	1495 Sanskrit	1581 Vietnamese
1150 Estonian	1307 Kurdish	1498 Sindhi	1587 Volapük
1151 Basque	1311 Kirghiz	1501 Sangho	1613 Wolof
1157 Persian	1313 Latin	1502 Serbo-Croatian	1632 Xhosa
1165 Finnish	1326 Lingala	1503 Singhalese	1665 Yoruba
1166 Fiji	1327 Laothian	1505 Slovak	1684 Chinese
1171 Faroese	1332 Lithuanian	1506 Slovenian	1697 Zulu
1174 French	1334 Latvian; Lettish		
1181 Frisian	1345 Malagasy		
			1703 Not specified

Additional Information

DVD Setup Menu List

You can set the following items with the DVD setup menu.
The order of the displayed items may be different from the actual display.

LANGUAGE SETUP

- OSD — (Select the language you want to use from the displayed language list.)
- DVD MENU — (Select the language you want to use from the displayed language list.)
- AUDIO — (Select the language you want to use from the displayed language list. When you select ORIGINAL, you can enjoy the language given priority on the disc.)
- SUBTITLE — (Select the language you want to use from the displayed language list. When you select AUDIO FOLLOW, the setting is automatically switched to the language selected in AUDIO.)

CUSTOM SETUP

- PAUSE MODE — AUTO
- FRAME — FRAME
- PARENTAL CONTROL — LEVEL — OFF
 - 8.
 - 7. NC17
 - 6. R
 - 5.
 - 4. PG13
 - 3. PG
 - 2.
 - 1. G
- STANDARD — USA
- OTHERS
- CHANGE PASSWORD
- TRACK SELECTION — OFF
- AUTO

SCREEN SETUP

- TV TYPE — 16:9
- 4:3 LETTER BOX
- 4:3 PAN SCAN
- SCREEN SAVER — ON
- OFF
- BACKGROUND — JACKET
- PICTURE
- GRAPHICS
- BLUE
- BLACK

SPEAKER SETUP

- SIZE — FRONT — YES
- CENTER — YES
- NONE
- REAR — BEHIND — LOW
- HIGH
- SIDE — LOW
- HIGH
- NONE
- SUBWOOFER — YES
- DISTANCE — FRONT — 1m ~ 15m
- CENTER — 0m ~ 15m
- REAR — 0m ~ 15m
- BALANCE — FRONT — 6 steps left or right
- REAR — 6 steps left or right
- LEVEL — CENTER — -6 dB ~ +6 dB
- REAR — -6 dB ~ +6 dB
- SUBWOOFER — -6 dB ~ +6 dB
- TEST TONE — OFF
- ON

Index

Numerics

16:9 63
4:3 LETTER BOX 63
4:3 PAN SCAN 63

A

ADVANCED 51
AMP MENU 24
ANGLE 49
Antenna Hookups 19
AUDIO 44, 62

B

BACKGROUND 64
BALANCE 26, 67
BAND 28
Batteries 16
Bit rate 51, 72

C

CD 30
CHAPTER 39
Chapter 6, 72
Continuous play
 CD, VIDEO CD, Super Audio
 CD, DVD 30
Control Menu 13
CUSTOM PARENTAL
 CONTROL 52
CUSTOM SETUP 64

D

DIMMER 27
DISTANCE 66
Dolby Digital 72
Dolby Pro Logic Surround 73
DTS 73
DVD 32, 73
DVD MENU 33, 62
DVD TOP MENU 32, 39

F

Fast forward 38
Fast reverse 38
Front Panel 9
Front panel display 10

H

Handling discs 8

I

INDEX 39
Index 6

L

LANGUAGE SETUP 62
LEVEL 27, 68
Locating
 a specific Point
 by watching the TV screen 38

M

MEMORY 28
Multi-angle function 49
Multilingual function 44
MUTING 31

N

NAME 60

O

On-screen display
 Control Menu display 13
 Setup Display 61
OSD 62

P

PARENTAL CONTROL 53, 64,
 73
PAUSE MODE 64
PBC Playback 33, 73
PLAY MODE 34
Preset Station 28, 58
Programme Play 34

Q

Quick Overview 15

R

Radio 58
RDS 59
Rear Panel 11
Region code 7, 73
Remote 12, 57
REPEAT 37
RESET 62
Resume Play 31

S

Scan 38
SCENE 39
Scene 6
SCREEN SAVER 64
SCREEN SETUP 63
SHUFFLE 36
Shuffle Play 36
SIZE 65
Slow-motion Play 38
Sound Field 46
SPEAKER SETUP 65
Speaker System Hookup 16
SUBTITLE 50, 62
Super Audio CD 74

T

TEST TONE 68
TIME SEARCH 40
TIME 41
TIME/TEXT 39
Title 6, 74
Title menu 32
TRACK 39
Track 6, 74
TRACK SELECTION 65
Troubleshooting 69
TV and Audio/Video
 Component Hookups 21
 TV TYPE 63

U

Usable discs 6

V

VIDEO CD 33, 74

Quick reference for Remote Commander

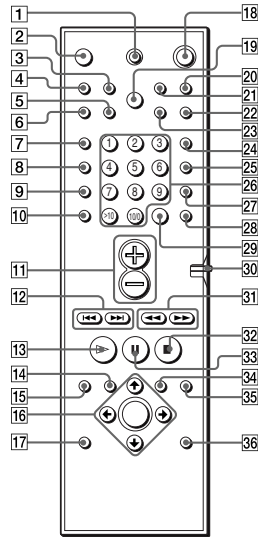

Shaded parts buttons are affected by the COMMAND MODE DVD/TV switch. Shaded descriptions refer to TV setting on the switch.

Note

The remote control of the unit employs command signals in common with other Sony DVD products. Thus, depending on the button, other Sony DVD products may respond.

- | | |
|---|---|
| <p>1 TV I/⏻ (on/standby)
Turns the TV on and off.</p> <p>2 ▲ OPEN/CLOSE
Opens or closes the disc tray.</p> <p>3 NAME
Activates the name function.</p> <p>4 STEREO/MONO
Switches monaural or stereo of FM stereo reception.</p> <p>5 MEMORY
Press to store a preset station.</p> <p>6 CLEAR
Press to return to the Continuous play, etc.</p> <p>7 PLAY MODE
Selects program or shuffle play mode.</p> <p>8 AUDIO
Changes the sound while playing a DVD or VIDEO CD.</p> <p>9 ANGLE
Changes the angles when playing a DVD.</p> <p>10 SUBTITLE
Displays the "SUBTITLE" menu in the Control Menu display.</p> <p>11 VOL +/-
Adjust the SYSTEM volume. TV : Adjust the TV volume.</p> | <p>12 ◀◀/▶▶, PREV/NEXT, TV CH +/-, PRESET +/-
◀◀/▶▶, PREV/NEXT : Press to go to the next chapter or track or to go back to the previous chapter or track.
PRESET +/- : Scan all preset stations.
TV CH +/- : Select preset TV channels.</p> <p>13 ▷ PLAY/SELECT
Plays a disc.</p> <p>14 DVD TOP MENU
Displays the title menu on the TV screen.</p> <p>15 DVD DISPLAY
Displays the Control Menu display on the TV screen to set or adjust the items.</p> <p>16 ◀/▶/⏪/⏩/ENTER
Selects and executes the items or settings.</p> <p>17 DVD SETUP
Displays the setup display on the TV screen to set or adjust the items.</p> <p>18 ⏻ (standby)
Turns on and off the power of the system.</p> <p>19 DIMMER
Changes the brightness of the front panel display by two steps.</p> <p>20 TV/VIDEO
Changes the input mode of the TV.</p> <p>21 REPEAT
Displays the "REPEAT" display on the TV screen.</p> <p>22 MUTING
Mutes the sound.</p> <p>23 TIME
Displays the playing time of the disc, etc., on the front panel display.</p> <p>24 FUNCTION
Selects the component you want to use.</p> <p>25 BAND
Selects AM or FM band.</p> <p>26 Number buttons*
Selects the items of settings.
TV : Selects channel numbers.</p> <p>27 SOUND FIELD
Selects the sound field.</p> <p>28 DISPLAY
Switches the item displayed on the front panel display.</p> <p>29 ENTER
Executes the items or settings. TV :
Press after selecting a channel number.</p> <p>30 COMMAND MODE DVD/TV switch
Switches the TV's input source between the TV and DVD.</p> <p>31 ◀◀/▶▶, ◀/▶ SLOW, TUNING +/-
◀◀/▶▶ (SCAN) : Locate a point while monitoring the picture while playing disc.
◀/▶ (SLOW) : Play a disc in slow motion in the pause mode.
TUNING +/- : Scan all available radio stations.</p> <p>32 ■ STOP
Stops playing a disc.</p> <p>33 PAUSE
Pauses playing a disc.</p> <p>34 DVD MENU
Displays the DVD menu on the TV screen.</p> <p>35 ⏪ RETURN
Press to return to the previously selected screen, etc.</p> <p>36 AMP MENU
Displays the speaker set up parameters on the front panel display.</p> |
|---|---|

* Depending on the TV set, you can also enter the number as follows: Press >10, then the number.
(For example, press >10, then 2 and 5 for entering 25.)

Sony Corporation Printed in Hungary

<http://www.sony.net/>

DAV-S400 4-240-074-12(1)

Free Manuals Download Website

<http://myh66.com>

<http://usermanuals.us>

<http://www.somanuals.com>

<http://www.4manuals.cc>

<http://www.manual-lib.com>

<http://www.404manual.com>

<http://www.luxmanual.com>

<http://aubethermostatmanual.com>

Golf course search by state

<http://golfingnear.com>

Email search by domain

<http://emailbydomain.com>

Auto manuals search

<http://auto.somanuals.com>

TV manuals search

<http://tv.somanuals.com>