

MiniDisc Deck

Operating Instructions



MDS-JE480

WARNING

To prevent fire or shock hazard, do not expose the unit to rain or moisture.

To prevent fire, do not cover the ventilation of the apparatus with newspapers, table-cloths, curtains, etc. And don't place lighted candles on the apparatus.

To prevent fire or shock hazard, do not place objects filled with liquids, such as vases, on the apparatus.

Do not install the appliance in a confined space, such as bookcase or built in cabinet.

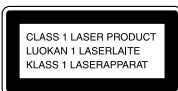

This appliance is classified as a **CLASS 1 LASER** product.

This label is located on the rear exterior.

The following caution label is located inside the apparatus.



Don't throw away the battery with general house waste, dispose of it correctly as chemical waste.

IN NO EVENT SHALL SELLER BE LIABLE FOR ANY DIRECT, INCIDENTAL OR CONSEQUENTIAL DAMAGES OF ANY NATURE, OR LOSSES OR EXPENSES RESULTING FROM ANY DEFECTIVE PRODUCT OR THE USE OF ANY PRODUCT.

About this manual

Controls in these instructions are those on the deck. However, these may be substituted by controls on the supplied remote that are similarly named, or, when different, appear in the instructions within parentheses.

Table of Contents

List of Button Locations and Reference Pages

Main unit	4
Remote control	5

Getting Started

Hooking up the audio components	6
---------------------------------------	---

Recording to MDs

Recording to an MD	8
Notes on recording	8
Recording tips	
— Recording for long times/Marking track numbers/Smart Space/Adjusting the recording level/Checking the remaining recordable time/Input monitor	9
Starting recording with 6 seconds of prestored audio data	
— Time Machine Recording	13
Synchro-recording with the audio component of your choice	
— Music Synchro-recording	13
Synchro-recording with a Sony CD player	
— CD Synchro-recording	13

Playing MDs

Loading an MD	15
Playing an MD	
— Normal Play/Shuffle Play/Repeat Play	15
Creating your own programme	
— Programme Play	16

Editing Recorded MDs

Erasing recordings	
— Erase Function	18
Dividing recorded tracks	
— Divide Function	19
Combining recorded tracks	
— Combine Function	20
Moving recorded tracks	
— Move Function	21
Naming a track or an MD	
— Name Function	21
Changing the recorded level after recording	
— S.F EDIT	23
Undoing the last edit	
— UNDO	24

Other Functions

Fading in and fading out	25
Falling asleep to music	
— Sleep Timer	25

Additional Information

Precautions	26
Note on MDs	26
System limitations	26
Troubleshooting	28
Self-diagnosis function	28
Display messages	29
Setup menu table	30
Specifications	30

How to use this page

Use this page to find the location and buttons and other parts of the system that are mentioned in the text.

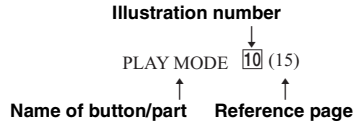

Main unit

ALPHABETICAL ORDER

A - M

AMS 19 (10) (16) (18) (21) (23) (25)
 CLEAR 18 (17) (22)
 Display window 13
 EJECT 4 (8) (16) (17)
 INPUT 14 (8)
 LEVEL/DISPLAY/CHAR 12 (8) (16) (21)
 MD (insertion slot) 2
 MDLP (indicator) 3 (9) (16)
 MENU/NO 8 (9) (10) (11) (21)

P - Z

PLAY MODE 10 (15)
 PUSH ENTER 19 (10)
 REC MODE 16 (9) (16)
 REC 17 (8)
 REPEAT 11 (15)
 STANDBY (indicator) 1 (8) (15)
 YES 9 (16)

BUTTON DESCRIPTIONS

I/⏻ 1 (8) (15) (17)
 ▷ 5 (8) (15)
 || 6 (8) (16)
 ■ 7 (8) (16) (17)
 ◀▶ 15 (16) (18)

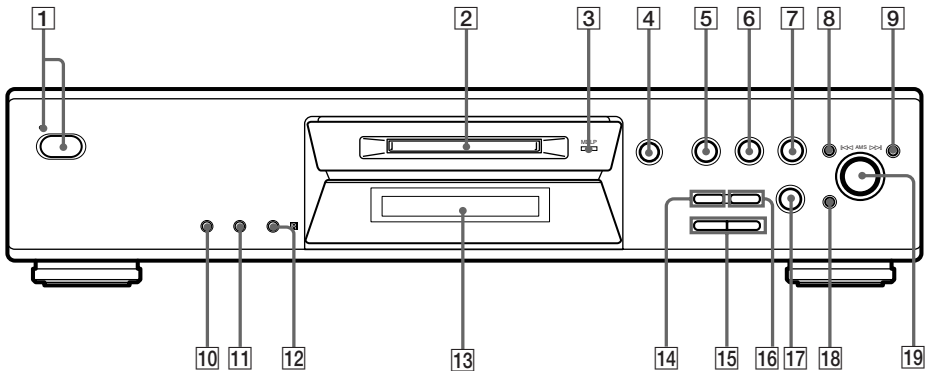

Remote control

A - L

- A↔B **12** (15)
- CD-SYNCHRO STANDBY **7** (14)
- CD-SYNCHRO START **7** (14)
- CD-SYNCHRO STOP **7** (14)
- CLEAR **6** (17) (22)
- DISPLAY **22** (8) (12)
- FADER **3** (25)
- GROUP ON/OFF 1) **19**
- GROUP SKIP 1) **19**
- INPUT **23** (8)
- Letter/number buttons **5** (22)
- LEVEL +/- **11** (12)

M - Z

- MENU/NO **20** (10) (17) (18)
- MUSIC SYNC **8** (13) (24)
- NAME EDIT/SELECT **21** (22)
- PLAY MODE **2** (15)
- REC MODE **23** (9) (16)
- REPEAT **13** (15)
- SCROLL **22** (16)
- T.REC **17** (13)
- YES **4** (10) (16) (18)

BUTTON DESCRIPTIONS

- I/⏻ **1** (8) (15) (17)
- ⏮ **9** (8) (16)
- **10** (8) (16) (17)
- ⏪/⏩ **14** (16) (19)
- ⏮/⏩ **15** (9) (12) (18)
- **16** (8)
- ▷ **18** (8) (15)
- ⏮ **24** (8) (16) (17)

1) These features is not available for this model.

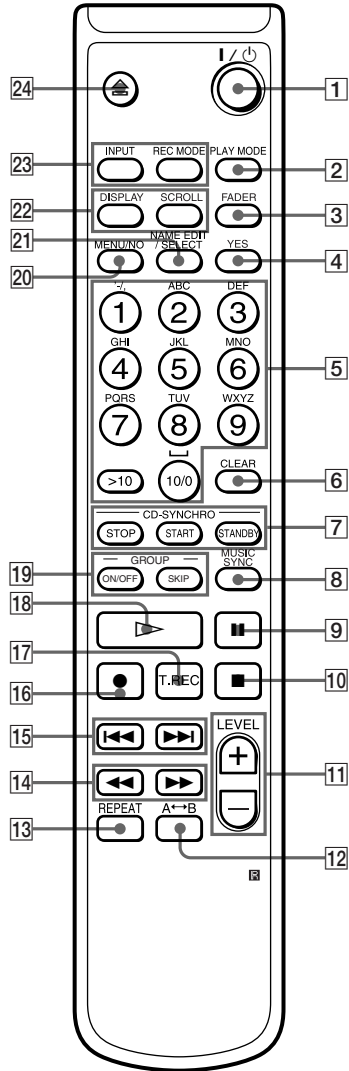

Hooking up the audio components

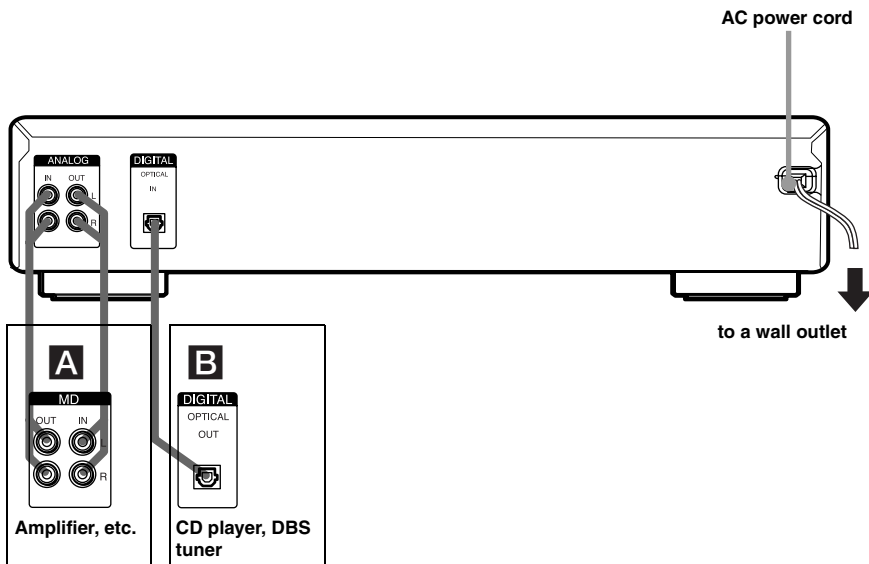

Required cords

A Audio connecting cords (2) (supplied)

When connecting an audio connecting cord, be sure to match the color-coded pins to the appropriate jacks: white (left) to white and red (right) to red.

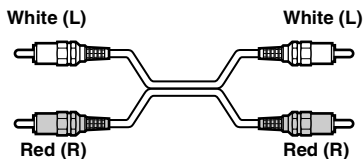

B Optical cables (only one supplied)

- When connecting an optical cable, take the caps off the connectors and insert the cable plugs straight in until they click into place.
- Do not bend or tie the optical cables.

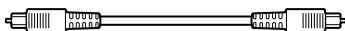

Hookup considerations

- Turn off the power of all components before making any connections.
- Do not connect any AC power cord until all the connections are completed.
- Be sure the connections are firm to prevent hum and noise.

Jacks (connectors) for connecting audio components

Connect	To the
Amplifiers	ANALOG IN/OUT jacks
CD players or DBS tuners	DIGITAL OPTICAL IN connector

Other connections

To connect the AC power cord

Connect the AC power cord of the deck to a wall outlet.

Note

If you use a timer, connect the AC power cord to the outlet of the timer.

Inserting batteries into the remote

Insert two R6 (size-AA) batteries into the battery compartment with the + and – properly oriented to the markings. When using the remote, point it at the remote sensor  on the deck.

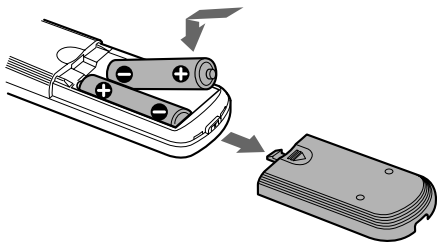

Tip

When the remote no longer operates the deck, replace both batteries with new ones.

Notes

- Do not leave the remote in an extremely hot or humid place.
- Do not drop any foreign object into the remote casing, particularly when replacing the batteries.
- Do not use a new battery with an old one.
- Do not expose the remote sensor to direct sunlight or lighting apparatus. Doing so may cause a malfunction.
- If you don't use the remote for an extended period of time, remove the batteries to avoid possible damage from battery leakage and corrosion.

Recording to an MD

If the MD has been partially recorded, recording starts after the recorded tracks.

- 1 Turn on the amplifier and program source, and select the source on the amplifier.**
- 2 Press I/⏻ to turn on the deck.**
The STANDBY indicator turns off.
- 3 Load a recordable MD into the slot (page 15).**
- 4 Press INPUT repeatedly to select the input jacks (connector) connected to the program source.**

When the source is connected to the	Set INPUT to
DIGITAL OPTICAL IN connector	D-IN
ANALOG IN jacks	A-IN

- 5 Press REC ●.**
The deck changes to recording pause.
- 6 Adjust the recording level if necessary.**
For details, see “Adjusting the recording level” on page 12.
- 7 Press ▷ or II.**
Recording starts.
- 8 Start playing the program source.**

Operations you may want to do during recording

To	Press
Stop recording	■
Pause recording	II
Resume recording after pausing ¹⁾	▷ or II
Eject the MD	EJECT ≡ after stopping recording

- 1) The track number increases by one.

To change the display while recording

Press LEVEL/DISPLAY/CHAR (or DISPLAY) repeatedly to change the display.

Each time you press the button, the display changes cyclically as follows:

Track number and recorded time of the current track → Remaining recordable time²⁾ on the MD → Level of the input signal → Track name³⁾

- 2) Time shown in the display differs depending on the setting of REC MODE.
- 3) “No Name” appears when the track has no name.

Notes on recording

After recording

Press EJECT ≡ to remove the MD or press I/⏻ to turn off the deck.

“TOC” or “TOC Writing” starts flashing. The TOC is updated and recording is completed.

Before disconnecting the AC power cord

MD recording is completed when the MD Table of Contents (TOC) is updated. The TOC is updated when you eject the MD or press I/⏻ to turn off the deck. Do not disconnect the AC power cord before updating the TOC (while “TOC” is lit) or while updating the TOC (while “TOC Writing” is flashing) to ensure a complete recording.

Automatic conversion of digital sampling rates

A built-in sampling rate converter automatically converts the sampling frequency of various digital sources to the 44.1 kHz sampling rate of the MD deck. This allows you to monitor and record sources such as 32 or 48 kHz DAT tape or satellite broadcasts, as well as the CDs and MDs.

To prevent accidental erasure of the recorded material

To protect an MD recording, slide the record-protect tab in the direction of the arrow (see illustration below) to open the slot. To enable re-recording, close the slot.

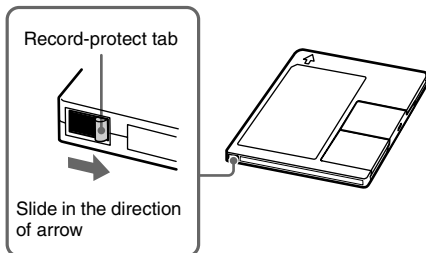

Recording tips

— *Recording for long times/Marking track numbers/Smart Space/Adjusting the recording level/Checking the remaining recordable time/Input monitor*

Recording for long times

This deck has two long time recording modes: LP2 and LP4 (MDLP recording). When recording in LP2 Stereo mode, you can record 2 times the normal recordable time, and in LP4 Stereo mode, you can record 4 times the normal recordable time. In addition, the recordable time for monaural recording is approximately double the stereo recording time.

LP4 Stereo mode (4× long time recording mode) achieves a long stereo recording time by using a special compression system. When placing emphasis on sound quality, Stereo recording or LP2 Stereo recording (2× long time recording mode) is recommended.

1 Do steps 1 to 4 of “Recording to an MD” on page 8.

2 Press REC MODE repeatedly to select the recording mode.

To record in	Set REC MODE to
Stereo	Blank (No indicator)
LP2 Stereo	LP2
LP4 Stereo	LP4
Monaural	MONO

3 Do steps 5 to 8 of “Recording to an MD” on page 8.

Tips

- The MDLP indicator lights up when you select LP2 or LP4 in step 2 above.
- The deck is factory set to add “LP:” at the beginning of a track name automatically. This indication is displayed when the track is played on a deck that does not support long-time recording.

To turn off this function, do the following procedure.

- 1 While the deck is stopped, playing, or paused, press MENU/NO.
- 2 Turn AMS (or press ◀◀/▶▶ repeatedly) until “Setup?” appears, then press PUSH ENTER or YES.
- 3 Turn AMS (or press ◀◀/▶▶ repeatedly) until “LPstamp On” (factory setting) appears, then press PUSH ENTER or YES.
- 4 Turn AMS (or press ◀◀/▶▶ repeatedly) to select “LPstamp Off”, and then press PUSH ENTER or YES.

5 Press MENU/NO.

To add “LP:” automatically again, select “LPstamp On” in step 4 above.

Notes

- The recorded “LP:” is a stamp which appears to indicate that the track cannot be played back when you try to play the track on a system that does not support MDLP mode. It does not appear for systems that support MDLP mode.
- When set to “On”, “LP:” is recorded as the track name, so the number of characters that can be input to an MD is reduced. If you divide an “LP:” track using the Divide function, “LP:” is also added to the latter track.
- The selected recording mode is kept even after recording is completed, so be sure to check the recording mode before recording.
- Tracks recorded in MDLP (LP2 or LP4) Stereo mode cannot be played back on a system that does not support MDLP mode.
- Even if you press REC MODE during recording, you cannot change the recording mode.
- Even if you press REC MODE repeatedly to select MONO, the monitor signal during recording does not become monaural.
- You cannot use S.F Edit and some MD edit functions for tracks recorded in MDLP mode.

continued

Recording tips (continued)

Marking track numbers while recording

— Manual/Automatic Track Marking

You can mark track numbers either manually or automatically while recording. By marking track numbers at specific points, you can easily locate the points later or edit the MD.

Marking track numbers manually (Manual Track Marking)

While recording, press **REC** ● at the point where you want to add a track number.

Marking track numbers automatically (Automatic Track Marking)

When recording from a CD player or MD deck connected to a DIGITAL IN connector, the deck marks track numbers in the same sequence as the source. When recording from other sources connected to the DIGITAL IN connector or a source connected to the ANALOG IN jacks, do the procedure below to mark track numbers automatically. However, you cannot mark track numbers automatically if the sound of the source to be recorded is noisy (e.g., tapes or radio programs).

1 While the deck is stopped, press **MENU/NO**.

2 Turn **AMS** (or press **◀◀/▶▶** repeatedly) until “Setup?” appears, then press **PUSH ENTER** or **YES**.

3 Turn **AMS** (or press **◀◀/▶▶** repeatedly) until “T.Mark LSyn” appears, then press **PUSH ENTER** or **YES**.

4 Turn **AMS** (or press **◀◀/▶▶** repeatedly) to select the setting, then press **PUSH ENTER** or **YES**.

To	Select
Turn on Automatic Track Marking	T.Mark LSyn (factory setting)
Turn off Automatic Track Marking	T.Mark Off

5 Press MENU/NO.

When you set Automatic Track Marking to on, “L.SYNC” lights up.

The deck marks a track number whenever the input signal level drops to -50 dB¹⁾ (the trigger level for Automatic Track Marking) or below for at least 1.5 seconds.

1) Factory setting.

To change the trigger level for Automatic Track Marking

Do the procedure below to change the signal level that triggers Automatic Track Marking.

1 While the deck is stopped, press **MENU/NO**.

2 Turn **AMS** (or press **◀◀/▶▶** repeatedly) until “Setup?” appears, then press **PUSH ENTER** or **YES**.

3 Turn **AMS** (or press **◀◀/▶▶** repeatedly) until “LS(T)” appears, then press **PUSH ENTER** or **YES**.

4 Turn **AMS** (or press **◀◀/▶▶** repeatedly) to select the level, then press **PUSH ENTER** or **YES**.

You can set the level at any value between -72 dB and 0 dB, in 2 dB increments (-50 dB is the factory setting).

5 Press MENU/NO.

Tips for automatic track marking

- When recording from a CD player or an MD deck connected to the DIGITAL IN connector, the entire material might be recorded as a single track in the following cases:
 - When you consecutively record the same track two or more times using single-track repeat play.
 - When you consecutively record two or more tracks with the same track number but from different CDs or MDs.
 - When you record tracks from certain CD or multi-disc players.

- A track number might not be marked for tracks less than 4 seconds long (in Stereo mode, Monaural mode, and LP2 Stereo mode) or 8 seconds long (in LP4 Stereo mode) during recording.
- When recording from a component connected to the ANALOG IN jacks with "T.Mark Off" selected or when recording from a DAT deck or DBS tuner connected to the DIGITAL IN connector, the entire material may be recorded as a single track.
- When recording from a DAT deck or DBS tuner connected to the DIGITAL IN connector, the deck will mark a track number whenever the sampling frequency of the input signal changes, regardless of the track marking parameter setting ("T.Mark LSyn" or "T.Mark Off").

Tip

You can mark track numbers even after recording has finished. See "Dividing recorded tracks" on page 19.

Erasing blank portions automatically (Smart Space/ Auto Cut)

The Smart Space function lets you make the blank spaces between tracks 3 seconds long automatically. If the Smart Space function is on and there is no sound input for about 3 seconds or more (but less than 30 seconds) while recording, the deck replaces this silence with a blank space of about 3 seconds and continues recording.

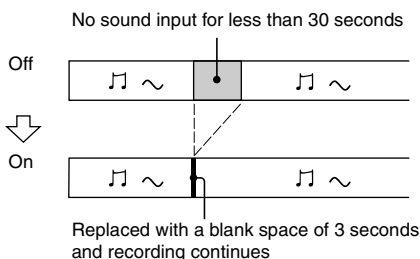

Auto Cut: When the Smart Space function is on, if there is no sound input for 30 seconds or more, the deck replaces this silence with a blank space of about 3 seconds and enters recording pause.

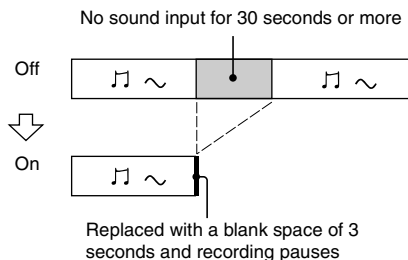

- 1** While the deck is stopped, press MENU/NO.
- 2** Turn AMS (or press ◀▶) repeatedly until "Setup?" appears, then press PUSH ENTER or YES.
- 3** Turn AMS (or press ◀▶) repeatedly until "S.Space On" appears, then press PUSH ENTER or YES.
- 4** Turn AMS (or press ◀▶) repeatedly to select the setting, then press PUSH ENTER or YES.

To	Select
Turn on Smart Space and Auto Cut	S.Space On (factory setting)
Turn off Smart Space and Auto Cut	S.Space Off

5 Press MENU/NO.

Notes

- Smart Space does not affect the order of the track numbers being recorded, even if the blank space occurs in the middle of a track.
- Auto Cut is automatically turned on or off in tandem with Smart Space.
- If the deck continues recording pause for about 10 minutes after the Auto Cut is activated, recording stops automatically.

continued

Recording tips (continued)

Adjusting the recording level

You can adjust the recording level for both analog and digital recordings.

- 1** Do steps 1 to 5 of “Recording to an MD” on page 8.
- 2** Play the portion of the program source with the strongest output.
- 3** Press LEVEL/DISPLAY/CHAR (or DISPLAY) repeatedly until the level of the input signal appears.
- 4** While monitoring the sound, turn AMS (or press LEVEL +/- repeatedly) to raise the recording level to its highest level without turning on the “OVER” indicators on the peak level meters.



Avoid turning on these indicators

- 5** Stop playing the program source.
- 6** To start recording, continue from step 7 of “Recording to an MD” on page 8.

Tips

- You can adjust the recording level by pressing LEVEL +/- on the remote repeatedly during recording or recording pause.
- Peak hold function freezes the peak level meters at the highest level reached by the input signal.
 - 1** While the deck is stopped, press MENU/NO.
 - 2** Turn AMS (or press ◀▶ repeatedly) until “Setup?” appears, then press PUSH ENTER or YES.
 - 3** Turn AMS (or press ◀▶ repeatedly) until “P.Hold Off” (factory setting) appears, then press PUSH ENTER or YES.
 - 4** Turn AMS (or press ◀▶ repeatedly) to select “P.Hold On”, then press PUSH ENTER or YES.
 - 5** Press MENU/NO.
To turn off the Peak Hold Function, select “P.Hold Off” in step 4 above.

Note

The recording level can only be increased up to +12.0 dB (for analog recording) or +18.0 dB (for digital recording) (0.0 dB is the factory setting). Therefore, if the output level of the connected component is low, it may not be possible to set the recording level to maximum.

Checking the remaining recordable time on the MD

Press DISPLAY on the remote repeatedly. For the information in stop mode, see page 16. For the information during recording, see page 8.

Monitoring the input signal (Input Monitor)

You can monitor the selected input signal even when you are not recording it.

- 1** Press EJECT ⏏ to eject the MD.
- 2** Press INPUT repeatedly to select the jacks (connector) where the signal you want to monitor is being input.
- 3** Press REC ●.

When an analog input is selected

The analog signal input from the ANALOG IN jacks is output to the ANALOG OUT jacks after D/A conversion. “AD – DA” appears in the display during this time.

When a digital input is selected

The digital signal input from the DIGITAL IN connector is output to the ANALOG OUT jacks after D/A conversion. “– DA” appears in the display during this time.

To stop Input Monitor

Press ■.

Starting recording with 6 seconds of prestored audio data

— Time Machine Recording

When recording from an FM or satellite broadcast, the first few seconds of material are often lost due to the time it takes you to ascertain the contents and press the record button. To prevent the loss of this material, the Time Machine Recording feature constantly stores the most recent audio data in a buffer memory. This lets you record the sound 6 seconds before starting recording, as shown in the illustration below:

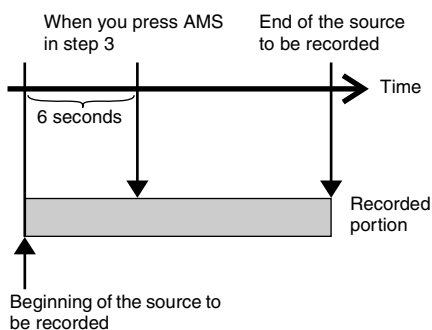

- 1 Do steps 1 to 5 of “Recording to an MD”.**
The deck changes to recording pause.
- 2 Start playing the program source.**
- 3 Press PUSH ENTER (or T.REC) at the point where you want to start recording.**
Recording starts with the six seconds of prestored data in the buffer memory, then continues recording via the buffer memory thereafter.

Synchro-recording with the audio component of your choice

— Music Synchro-recording

The Music Synchro-recording allows you to automatically synchronize recording to the MD deck with the playing of the selected program source. The Track Marking Function, however, will differ according to the program source. For details, see “Marking track numbers while recording” on page 10.

- 1 Do steps 1 to 4 of “Recording to an MD”.**
- 2 Press MUSIC SYNC on the remote.**
The deck changes to recording pause.
- 3 Start playing the program source.**
Recording starts automatically.

Note

During Music Synchro-recording, Smart Space and Auto Cut will operate regardless of their setting (“S.Space On” or “S.Space Off”).

Synchro-recording with a Sony CD player

— CD Synchro-recording

When the MD deck is connected to a Sony CD player or Hi-Fi component system, you can easily copy the contents of the CDs to the MD using the MD’s remote. The MD remote operates both the MD deck and the CD player or CD player section of the components system. Therefore, place the MD deck and the CD player as close together as possible.

- 1 Turn on the amplifier and the CD player, and select CD on the amplifier.**
- 2 Do steps 2 to 4 of “Recording to an MD”.**
- 3 Insert a CD into the CD player and select the playing mode (Shuffle Play, Program Play, etc.) on the CD player.**

continued

Synchro-recording with a Sony CD player (continued)

4 Press CD-SYNCHRO STANDBY on the remote.

The CD player changes to play standby and the MD deck changes to recording standby.

5 Press CD-SYNCHRO START on the remote.

The deck starts recording and the CD player starts to play.

The track number and elapsed recording time of the track appear in the display.

If the CD player does not start playing

Some CD players may not respond when you press CD-SYNCHRO START on the remote.

Press **II** on the CD player's remote instead to start play on the CD player.

Operations you may want to do during CD Synchro-recording

To	Press
Stop recording	CD-SYNCHRO STOP on the remote
Pause recording	CD-SYNCHRO STANDBY on the remote
Resume recording after pausing	CD-SYNCHRO START on the remote
Check the remaining recordable time on the MD	DISPLAY on the remote (page 12)

Tips

- You can use the remote of the CD player during CD Synchro-recording

Press	To change the deck to	And change the CD player to
▷	Recording	Play
■	Recording pause	Stop
II	Recording pause	Pause

- During CD Synchro-recording, track numbers are marked in the following ways:
 - When the CD player is connected to the DIGITAL IN connector, track numbers are automatically marked as they appear on the CD.
 - When the CD player is connected to the ANALOG IN jacks, track numbers are automatically marked when “T.Mark LSyn” has been selected (page 10).
 - When you resume recording after recording pause, a new track number is automatically marked, regardless of the track marking parameter setting (“T.Mark LSyn” or “T.Mark Off”).
- By reprogramming the MD's remote, you can use the procedure above to perform synchro-recording with a Sony video CD player. Press 2 while holding down I/⏻ on the remote. Now you can operate both the MD deck and the video CD player. To select the remote original function, press 1 while holding down I/⏻ on the remote.

Notes

- When performing CD Synchro-recording with a CD player with a mode selector, be sure to set the selector to CDI.
- When you record tracks from certain CD or multi-disc players, the entire material may be recorded as a single track.

Loading an MD

Load an MD as illustrated below.

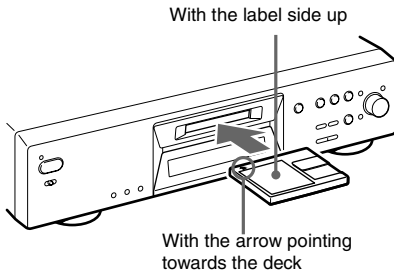

Playing an MD

— Normal Play/Shuffle Play/Repeat Play

1 Turn on the amplifier and select MD on the amplifier.

2 Press I/⏻ to turn on the deck.
The STANDBY indicator turns off.

3 Load an MD.

4 Press PLAY MODE repeatedly until the mode you want appears in the display.

To play	Select
The MD in the original order	Blank (no PLAY MODE indication)
The tracks in random order	SHUF
The tracks in the order you want ("Creating your own programme" on page 16)	PGM

5 Press ▷.
The deck starts to play.

6 Adjust the volume on the amplifier.

Repeat Play Operations

To	Do this
Repeat only one track	Press REPEAT repeatedly until "REPI" lights up in the display.
Repeat all tracks	Press REPEAT repeatedly until "REP" lights up in the display.
Cancel Repeat Play	Press REPEAT repeatedly until "REPI" or "REP" disappears.
Repeat a specific portion within a track (Repeat A-B Play)	<p>1 While the deck is playing, press A↔B on the remote at the starting point (point A) of the portion to be played repeatedly. "REP A-" lights up and "B" flashes in the display.</p> <p>2 Continue playing the track or press ►► to locate the ending point (point B), then press A↔B on the remote. "REP A-B" lights up and Repeat A-B Play starts.</p>
Cancel Repeat A-B Play	Press REPEAT or CLEAR.

continued

Playing an MD (continued)

Other Operations

To	Do this
Stop play	Press ■.
Pause play	Press ■■.
Resume play after pausing	Press ▷ or ■■.
Go to the next or a succeeding track during play	Turn AMS ¹⁾ clockwise (or press ►► repeatedly).
Go to a preceding track during play	Turn AMS counterclockwise (or press ◀◀ repeatedly).
Go to the beginning of the current track during play	Turn AMS counterclockwise (or press ◀◀ once).
Go to a specific track while the deck is stopped	Turn AMS (or press ◀◀/►► repeatedly) until the track number you want to go to flashes in the display, then press PUSH ENTER or ▷.
Find a point in a track	Press down ◀◀/►► during play ²⁾ or play pause ³⁾ . Release it when you reach the desired point.
Eject the MD	Press EJECT ≡ after stopping play.

- 1) Automatic Music Sensor
- 2) When you locate a point while monitoring the sound.
- 3) When you locate by observing the time indication.

Tips

- The MDLP indicator lights up when you select a track recorded in LP2 or LP4 Stereo mode.
- When “– Over –” appears in the display, the MD has reached the end while you’re pressing ►►. Turn AMS counterclockwise (or press ◀◀) or press ◀◀ to go back.

Playing a track by entering the track number

Press the number button(s) on the remote to enter the track number of the track you want to play.

To enter a track number over 10

- 1 Press >10.
“–” equal to the number of digits for the number of tracks recorded on the MD flashes.
- 2 Enter the corresponding digits.
To enter 0, press 10/0 instead.

Examples:

- To select track number 30 on an MD recorded with 50 tracks, press >10, then 3 and 10/0.
- To select track number 30 on an MD recorded with 200 tracks, press >10, then 10/0, 3 and 10/0.

Using the MD display

Press LEVEL/DISPLAY/CHAR (or DISPLAY) repeatedly.

The display changes cyclically as follows:

During playing

Track number and elapsed time of the current track → Track number and remaining time of the current track → Remaining time of all recorded tracks → Track name¹⁾

Tip

To check the track name during playing (only when the track name is recorded), press SCROLL on the remote.

The track name appears and scrolls. While the track name is scrolling, press the button again to pause scrolling, and again to continue scrolling.

In stop mode

Total number of tracks and total recorded time → Remaining recordable time²⁾ on the MD (recordable MDs only) → Disc name¹⁾

- 1) “No Name” appears when the disc or track has no name.
- 2) Time shown in the display differs depending on the setting of REC MODE.

Creating your own programme

— Programme Play

You can pick out the tracks that you like and specify the playing order in a programme containing up to 25 tracks.

1 While the deck is stopped, press PLAY MODE repeatedly until “PGM” lights up in the display.

2 Turn AMS (or press ◀◀/►► repeatedly) until the track number you want to add to the programme appears (or use the number button(s) on the remote to enter the track directly), then press YES or PUSH ENTER.

“Step X (X: number of the entered tracks)” appears, followed by total playing time of the programme.

To clear the last entered track

Press CLEAR to erase the track number.

To enter a track number over 10

Use >10. See this page for details.

3 Repeat step 2 to enter other tracks.**4 Press ►.**

Programme Play starts.

To stop Programme Play

Press ■.

To check the total of programme tracks

While the deck is stopped and the “PGM” lights up, press LEVEL/DISPLAY/CHAR repeatedly.

To check the contents of the programme during Programme Play

Turn AMS (press ◀◀/▶▶) repeatedly).

To add a track to the end of the programme

Do steps 2 above while the deck is stopped.

To erase all tracks in the programme

Press CLEAR repeatedly until all the track numbers disappear.

To resume normal play

Press PLAY MODE repeatedly until “PGM” turns off.

The programme remains even after Programme Play ends or is stopped

Press ► to play the programme again.

Notes

- If you eject the MD, the programme will be lost.
- The display shows “- - - m - - s” when the total playing time of the programme exceeds 1,000 minutes.
- “Step Full!” appears when you try to programme the 26th track.

Before editing

You can edit an MD only when:

- The MD is recordable.
- The MD play mode is normal play.

To cancel the last edit

Use Undo Function to cancel the last edit and restore the contents of the MD to the condition before the edit.



To quit while editing

Press MENU/NO or ■.

When “Tr Protected” appears in the display

You cannot perform editing operations on protected tracks (tracks checked out from a USB connected computer using the Net MD function, etc.) other than “Moving recorded tracks” (page 21) and “Naming a track or an MD” (page 21) using the deck.

After editing

Press EJECT  to remove the MD or press I/ to turn off the deck.

“TOC” or “TOC Writing” starts flashing. The TOC is updated and recording is completed.

Before disconnecting the AC power cord

MD editing is completed when the MD Table of Contents (TOC) is updated. The TOC is updated when you eject the MD or press I/ to turn off the deck. Do not disconnect the AC power cord before updating the TOC (while “TOC” is lit) or while updating the TOC (while “TOC Writing” is flashing) to ensure a complete editing.

Erasing recordings

— Erase Function

The MD deck lets you erase unwanted tracks quickly and easily.

The three options for erasing recordings are:

- Erasing a single track (Track Erase Function)
- Erasing all tracks (All Erase Function)
- Erasing a portion of a track (A-B Erase Function)

Erasing a single track

— Track Erase Function

You can erase a track simply by selecting its track number. When you erase a track, the total number of tracks on the MD decreases by one and all the tracks following the erased one are renumbered.

Example: Erasing track 2.

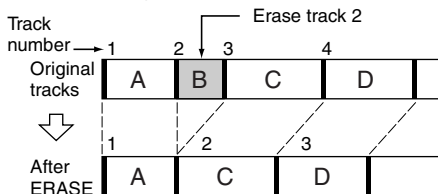

1 While the deck is stopped, playing, or paused, press MENU/NO.

“Edit Menu” appears in the display.

2 Turn AMS (or press \lll / \ggg repeatedly) until “Tr Erase?” appears, then press PUSH ENTER or YES.

The deck starts to play the track indicated by the number in the display.

3 Turn AMS (or press \lll / \ggg repeatedly) until the track number you want to erase appears.

4 Press PUSH ENTER or YES.

“Complete!” appears. The track following the erased track starts to play. If the erased track is the last one on the MD, the track preceding the erased track starts to play.

Erasing all the tracks

— All Erase Function

Do the procedure below to erase all the tracks, track names, and disc name at once.

1 While the deck is stopped, playing, or paused, press MENU/NO.

“Edit Menu” appears in the display.

2 Turn AMS (or press \lll / \ggg repeatedly) until “All Erase?” appears, then press PUSH ENTER or YES.

“All Erase??” appears in the display.

3 Press PUSH ENTER or YES.

“Complete!” appears.

Erasing a portion of a track

— A-B Erase Function

You can specify a portion within a track and erase the portion with ease. You can shift the desired portion by frame¹⁾, minute or second intervals.

1) 1 frame is 1/86 second.

Example: Erasing a portion of track 2.

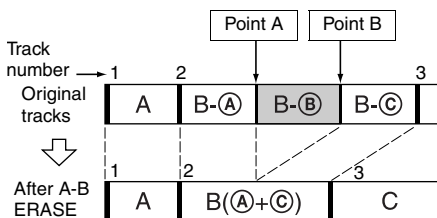

1 While the deck is stopped, playing, or paused, press MENU/NO.

“Edit Menu” appears in the display.

2 Turn AMS (or press \lll / \ggg repeatedly) until “A-B Erase?” appears, then press PUSH ENTER or YES.

Play starts.

3 Turn AMS (or press \lll / \ggg repeatedly) until the number of the track containing the portion to be erased appears.

4 While monitoring the sound, press **PUSH ENTER** or **YES** at the starting point of the portion to be erased (point A).

“-Rehearsal-” and “Point A ok?” alternate in the display and the deck repeatedly plays a few seconds of the track before the point A.

5 Press **PUSH ENTER** or **YES** again if point A is correct.

“Point B set” appears in the display and playback for setting the ending point of the portion to be erased (point B) starts.

If point A is not correct, adjust point A by turning AMS (or by pressing **◀◀/▶▶** repeatedly) while monitoring the sound, and then press **PUSH ENTER** or **YES** when you locate the desired starting point. You can shift the point by 1-frame² intervals (1 frame = 1/86 second).

6 Continue playing the track or press **▶▶** to locate the ending point of the portion to be erased (point B), then press **PUSH ENTER** or **YES**.

“A-B Ers” and “Point B ok?” alternate in the display and a few seconds of the track before point A and after point B play back repeatedly.

7 Press **PUSH ENTER** or **YES** again if point B is correct.

“Complete!” appears in the display for a few seconds and then the portion between point A and point B is erased.

If point B is not correct, adjust point B by turning AMS (or by pressing **◀◀/▶▶** repeatedly) while monitoring the sound, and then press **PUSH ENTER** or **YES** when you locate the desired ending point. You can shift the point by 1-frame² intervals (1 frame = 1/86 second).

2) You can shift the point by 2-frame intervals on the track recorded in Monaural mode or LP2 Stereo mode, and by 4-frame intervals on the track recorded in LP4 Stereo mode.

Tip

In step 5 and 7, if you want to shift point A or point B by a certain number of seconds or minutes, press **◀◀/▶▶** repeatedly. You can change the unit by which the counter advances when you turn AMS (or press **◀◀/▶▶** repeatedly).

Note

If “Impossible” appears in the display, you cannot erase a portion of a track. This happens when you have edited the same track many times.

This is due to a technical limitation of the MD system and is not a mechanical error.

Dividing recorded tracks

— Divide Function

You can use this function to mark track numbers after recording. The total number of tracks increases by one and all the tracks following the divided ones are renumbered.

Example: Dividing track 2 into two tracks.

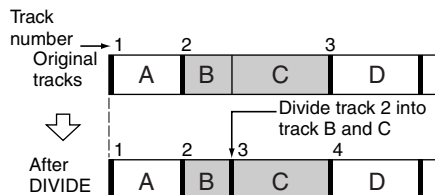

Dividing a track after selecting the track

1 While the deck is stopped, playing, or paused, press **MENU/NO**.

“Edit Menu” appears in the display.

2 Turn AMS (or press **◀◀/▶▶** repeatedly) until “Divide?” appears, then press **PUSH ENTER** or **YES**.

Play starts.

3 Turn AMS (or press **◀◀/▶▶** repeatedly) until the number of the track you want to divide appears

4 While monitoring the sound, press **PUSH ENTER** or **YES** at the dividing point.

“-Rehearsal-” appears in the display and the deck repeatedly plays a few seconds of the track before the dividing point.

continued

Dividing recorded tracks (continued)

5 Press PUSH ENTER or YES again if the dividing point is correct.

“Complete!” appears and the deck starts to play the newly created track. Note that new track has no name. If the dividing point is not correct, adjust the point by turning AMS (or press **◀◀/▶▶** repeatedly) while monitoring the sound, and then press PUSH ENTER or YES when you locate the desired dividing point. You can shift the point by 1-frame¹⁾ intervals (1 frame = 1/86 second).

- 1) You can shift the point by 2-frame intervals on the track recorded in Monaural mode or LP2 Stereo mode, and by 4-frame intervals on the track recorded in LP4 Stereo mode.

Tip

In step 5, if you want to shift the dividing point by a certain number of seconds or minutes, press **◀◀/▶▶** repeatedly. You can change the unit by which the counter advances when you turn AMS (or press **◀◀/▶▶** repeatedly).

Combining recorded tracks

— Combine Function

You can use this function to combine 2 tracks into a single track. The total number of tracks decreases by one and all tracks following the combined ones are renumbered.

You can also use this function to erase unnecessary track numbers.

Example: Combining track 3 to track 1.

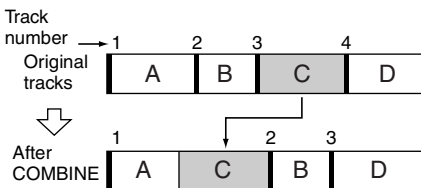

Example: Combining track 1 to track 4.

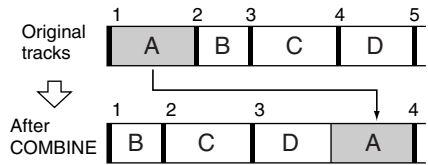

1 While the deck is stopped, playing, or paused, press MENU/NO.

“Edit Menu” appears in the display.

2 Turn AMS (or press **◀◀/▶▶** repeatedly) until “Combine?” appears, then press PUSH ENTER or YES.

3 Turn AMS (or press **◀◀/▶▶** repeatedly) until the number of the first track of the two tracks to be combined appears, then press PUSH ENTER or YES.

The display for selecting a second track appears and the deck plays the portion where joining will occur (the end of the first track and the beginning of the second track following it) repeatedly.

4 Turn AMS (or press **◀◀/▶▶** repeatedly) until the number of the second track of the two tracks to be combined appears, then press PUSH ENTER or YES.

“Complete!” appears and the deck starts to play the combined track.

Notes

- Tracks recorded in different modes (stereo, MONO, LP2 or LP4) cannot be combined.
- If both of the combined tracks have a track name, the name of the second track is erased.
- If “Impossible” appears in the display, the tracks cannot be combined because repeated editing has been done to the track(s). This is a technical limitation of the MD system and is not a mechanical error.

Moving recorded tracks

— Move Function

You can use this function to change the order of any track on the disc. When you move tracks, the tracks are automatically renumbered.

Example: Moving track 3 to position 2.

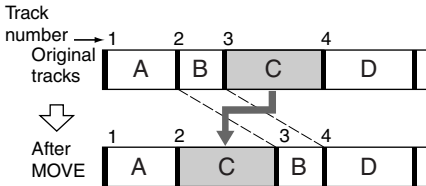

- 1** While the deck is stopped, playing, or paused, press **MENU/NO**.
“Edit Menu” appears in the display.
- 2** Turn **AMS** (or press **◀◀/▶▶** repeatedly) until “Move?” appears, then press **PUSH ENTER** or **YES**.
- 3** Turn **AMS** (or press **◀◀/▶▶** repeatedly) until the number of the track to be moved appears, then press **PUSH ENTER** or **YES**.
- 4** Turn **AMS** (or press **◀◀/▶▶** repeatedly) until the new track position appears, then press **PUSH ENTER** or **YES**.
“Complete!” appears and the deck starts to play the moved track.

Naming a track or an MD

— Name Function

You can enter a name for a recorded MD as well as for individual tracks. Names can consist of uppercase and lowercase letters, numbers, and symbols. A total number of about 1,700 characters can be stored for all the names on the MD.

Naming a track or an MD using the controls on the deck

- 1** While the deck is stopped, playing, recording, or paused, press **MENU/NO**.
“Edit Menu” appears in the display.
- 2** Turn **AMS** until “Nm In?” appears, then press **PUSH ENTER** or **YES**.
While the deck is recording, a flashing cursor appears in the display and you can enter a name for the track being recorded. In this case, go to step 4.
- 3** Turn **AMS** until the track number (when naming a track) or “Disc” (when naming the MD) flashes, then press **PUSH ENTER** or **YES**.

A flashing cursor appears.

The deck starts playing and you can name a track while monitoring the sound.

- 4** Press **LEVEL/DISPLAY/CHAR** repeatedly to select the character type.
Each time you press the button, the display changes cyclically as follows:
■■■■ (Blank space) → A (Upper cases) → a (Lower cases) → 0 (Numbers) → ' (Symbols)

To enter a space

Press **▶▶** while the cursor is flashing. You cannot enter a space as the first character.

- 5** Turn **AMS** to select the character.
The selected character flashes.

To enter a symbol

You can use the following symbols in titles:
' - / , . () : ! ? & + < > _ = " ; # \$ % @ * `

To change a selected character

Repeat steps 4 and 5.

- 6** Press **PUSH ENTER**.

The selected character is entered and lights continuously. The cursor shifts to the right, flashes, and waits for the input of the next character.

continued

Naming a track or an MD (continued)

7 Repeat steps 4 to 6 to enter the rest of the name.

To change a character

Press ◀◀/▶▶ repeatedly until the character to be changed flashes, then repeat steps 4 to 6.

To erase a character

Press ◀◀/▶▶ repeatedly until the character to be erased flashes, then press CLEAR.

8 Press YES.

The whole name appears in the display, followed by "Complete!".

Naming a track or an MD using the remote

1 Press NAME EDIT/SELECT depending on what you want to name:

To name	Press while
A track	The track number is displayed
The MD	The deck is stopped with the total number of tracks displayed

A flashing cursor appears in the display.

2 Press NAME EDIT/SELECT repeatedly to select the character type.

Each time you press the button, the display changes cyclically as follows:

"Selected AB" (Upper cases or symbols¹⁾)
→ "Selected ab" (Lower cases or symbols¹⁾) → "Selected 12" (Numbers)

1) Only ' - / , . () : ! ? can be selected.

3 Enter a character using letter/number buttons.

If you have selected upper cases or lower cases

1 Press the corresponding letter/number button repeatedly until the character to be entered flashes.

Or, press the button once and press ◀◀/▶▶ repeatedly.

To select symbols, press ◀◀ repeatedly while "A" is flashing.

2 Press ▶▶.

The flashing character is entered and lights continuously and the cursor shifts to the right.

If you have selected numbers

Press the corresponding number button.

The number is entered and the cursor shifts to the right.

4 Repeat steps 2 and 3 to enter the rest of the name.

To change a character

Press ◀◀/▶▶ repeatedly until the character to be changed flashes, press CLEAR to erase the character, then repeat steps 2 and 3.

5 Press YES.

The whole name appears in the display, followed by "Complete!".

Renaming a track or an MD

1 Press NAME EDIT/SELECT on the remote depending on what you want to rename:

To rename	Press while
A track	The track number is displayed
The MD	The deck is stopped with the total number of tracks displayed

A track or disc name appears in the display.

2 Press CLEAR until the selected name is erased completely.

3 Do steps 4 to 7 of "Naming a track or an MD using the controls on the deck" on page 21 or steps 2 to 4 of "Naming a track or an MD using the remote" on this page.

4 Press YES.

The whole name appears in the display, followed by "Complete!".

Erasing a track or disc name

Use this function to erase the name of a track or disc.

1 While the deck is stopped, playing, recording, or paused, press MENU/NO. "Edit Menu" appears in the display.

2 Turn AMS (or press ◀◀/▶▶ repeatedly) until "Nm Erase?" appears, then press PUSH ENTER or YES.

- 3** Turn AMS (or press **◀◀/▶▶** repeatedly) until the number of the track (when erasing the track name) or “Disc” (when erasing the disc name) flashes, then press **PUSH ENTER** or **YES**.

“Complete!” appears.

Changing the recorded level after recording

— S.F EDIT

You can change the volume of recorded tracks using S.F (Scale Factor) Edit. The original track is recorded over at the new recording level. When changing the recording level, you can select Fade-in Recording to gradually increase the signal level at the start of recording, or Fade-out Recording to gradually decrease the signal level at the end of recording.

Changing the overall recording level

- 1** While the deck is stopped, playing, or paused, press **MENU/NO**.
“Edit Menu” appears in the display.
- 2** Turn AMS (or press **◀◀/▶▶** repeatedly) until “S.F Edit?” appears, then press **PUSH ENTER** or **YES**.
- 3** Turn AMS (or press **◀◀/▶▶** repeatedly) until “Tr Level?” appears, then press **PUSH ENTER** or **YES**.
- 4** Turn AMS (or press **◀◀/▶▶** repeatedly) until the track number you want to change the recording level appears, then press **PUSH ENTER** or **YES**.
- 5** While monitoring the sound, turn AMS (or press **◀◀/▶▶** repeatedly) to change the recorded level without turning on the “OVER” indicators on the peak level meters.

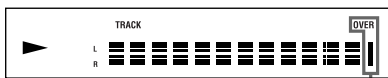

Avoid turning on these indicators

- 7** Press **PUSH ENTER** or **YES** again.

The deck starts recording over the existing track. “S.F Edit(:) ** %” appears while the track is being recorded. When recording over the track, the amount of time required is roughly equal to or longer than the playback time of the track. When the recording finishes, “Complete!” appears.

Fade-in and Fade-out Recording

- 1** While the deck is stopped, playing, or paused, press **MENU/NO**.
“Edit Menu” appears in the display.
- 2** Turn AMS (or press **◀◀/▶▶** repeatedly) until “S.F Edit?” appears, then press **PUSH ENTER** or **YES**.
- 3** Turn AMS (or press **◀◀/▶▶** repeatedly) until “Fade In?” or “Fade Out?” appears, then press **PUSH ENTER** or **YES**.
- 4** Turn AMS (or press **◀◀/▶▶** repeatedly) until the track number you want to change the recording level appears, then press **PUSH ENTER** or **YES**.
“Time 5.0s” appears in the display.
- 5** While monitoring the sound, turn AMS (or press **◀◀/▶▶** repeatedly) to change the Fade-in or Fade-out Recording time.
The deck plays the portion that will be recorded over using Fade-in or Fade-out Recording.
You can set the time at any value between 1 second and 15 seconds, in 0.1 second increments. You cannot set the time longer than the track.
- 6** Press **PUSH ENTER** or **YES**.
“(S.F) Edit OK?” appears in the display.
- 7** Press **PUSH ENTER** or **YES** again.
The deck starts recording over the existing track. “S.F Edit(:) ** %” appears while the track is being recorded. When the recording finishes, “Complete!” appears.

continued

- 6** Press **PUSH ENTER** or **YES**.
“(S.F) Edit OK?” appears in the display.

Changing the recorded level after recording (continued)

To cancel the operation

Press MENU/NO or ■ in steps 1 to 6. If you press PUSH ENTER or YES in step 7 and recording starts, you cannot interrupt the operation.

Notes

- Do not disconnect the AC power cord or move the deck while recording is in progress. This may damage the recording data preventing recording from being performed properly.
- You cannot change the recorded level of a track recorded in LP2 or LP4 Stereo mode.
- Do not use an MD that is damaged or dirty. This may prevent recording data from being recorded properly.
- Changing the recording level repeatedly results in poor sound quality.
- The recording level will not return to the exact original level once the recording level has been changed even if it returned to the original level.
- The recording level cannot be changed while the timer is activated.
- You cannot undo any S.F edit operation with the Undo Function.

Undoing the last edit

— UNDO

You can undo the last edit operation and restore the contents of the MD to the condition that existed before the operation. Note, however, you cannot undo an edit operation if you perform any of the following operations after the edit:

- Start recording.
- Press MUSIC SYNC on the remote.
- Change the recorded level after recording (S.F Edit).
- Turn off the deck or eject the MD.
- Disconnect the AC power cord.

1 While the deck is stopped, playing, or paused, press MENU/NO.

“Edit Menu” appears in the display.

2 Turn AMS (or press ◀◀/▶▶) repeatedly until “Undo?” appears.

“Undo?” does not appear if no editing has been done.

3 Press PUSH ENTER or YES.

One of the messages appears depending on the last edit operation.

4 Press PUSH ENTER or YES.

“Complete!” appears.

Fading in and fading out

Fade-in Recording gradually increases the signal level at the start of recording. Fade-out Recording gradually decreases the signal level at the end of recording.

Fade-in Recording

During recording pause, press **FADER** on the remote.

“◀” flashes in the display and the deck performs Fade-in Recording for five seconds (factory setting) until the counter reaches “0.0s.”

Fade-out Recording

During recording, press **FADER** on the remote.

“▶” flashes in the display and the deck performs Fade-out Recording for five seconds (factory setting) until the counter reaches “0.0s,” then pauses.

Tip

Do the following procedure to specify the fade-in or fade-out duration for recording.

- 1 While the deck is stopped or playing, or paused, press **MENU/NO**.
- 2 Turn **AMS** (or press **◀◀/▶▶** repeatedly) until “Setup?” appears, then press **PUSH ENTER** or **YES**.
- 3 Turn **AMS** (or press **◀◀/▶▶** repeatedly) to select the setting, then press **PUSH ENTER** or **YES**.

To change the duration of	Select
Fade-in Recording	F.in
Fade-out Recording	F.out

- 4 Turn **AMS** (or press **◀◀/▶▶** repeatedly) to select the duration, then press **PUSH ENTER** or **YES**.

Both the Fade-in and Fade-out durations can be set in 0.1 second steps.

- 5 Press **MENU/NO**.

Falling asleep to music

— Sleep Timer

You can set the deck so that it turns off automatically after a specified duration.

- 1 While the deck is stopped or playing, press **MENU/NO**.
- 2 Turn **AMS** (or press **◀◀/▶▶** repeatedly) until “Setup?” appears, then press **PUSH ENTER** or **YES**.
- 3 Turn **AMS** (or press **◀◀/▶▶** repeatedly) until “Sleep Off” appears in the display, then press **PUSH ENTER** or **YES**.
- 4 Turn **AMS** (or press **◀◀/▶▶** repeatedly) to select the setting, then press **PUSH ENTER** or **YES**.

To	Select
Turn on Sleep Timer	Sleep On ¹⁾
Turn off Sleep Timer	Sleep Off (factory setting)

- 1) The deck turns off automatically after 60 minutes.

5 Press **MENU/NO**.

Tip

You can check the remaining time. Once you turn on Sleep Timer, the remaining time is displayed when you select “Sleep” in Setup Menu.

Precautions

On safety

- Should any solid object or liquid fall into the cabinet, unplug the deck and have it checked by qualified personnel before operating it any further.
- Caution – The use of optical instruments with this product will increase eye hazard.

On power sources

- Before operating the deck, check that the operating voltage of the deck is identical with your local power supply. The operating voltage is indicated on the nameplate at the rear of the deck.
- The unit is not disconnected from the AC power source (mains) as long as it is connected to the wall outlet, even if the unit itself has been turned off.
- If you are not going to use the deck for a long time, be sure to disconnect the deck from the wall outlet. To disconnect the AC power cord, grasp the plug itself, never pull the cord.
- AC power cord must be changed only at the qualified service shop.

On condensation in the deck

If the deck is brought directly from a cold to a warm location, or is placed in a very damp room, moisture may condense on the lenses inside the deck. Should this occur, the deck may not operate properly. In this case, remove the MD and leave the deck turned on for several hours until the moisture evaporates.

On cleaning

Clean the cabinet, panel and controls with a soft cloth slightly moistened with a mild detergent solution. Do not use any type of abrasive pad, scouring powder or solvent such as alcohol or benzene.

If you have any questions or problems concerning your deck, please consult your nearest Sony dealer.

Note on MDs

- Do not touch the internal disc directly. Forcing the shutter open may damage the internal disc.
- Be sure to stick the labels supplied with the MD to the appropriate positions. The shape of the labels may vary depending on the MD brand.

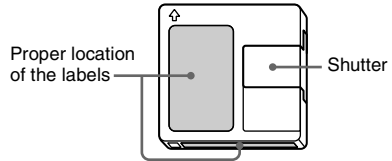

Where to keep the MDs

Do not place the cartridge where it may be exposed to direct sunlight or extremely high heat and humidity.

Regular maintenance

Wipe dust and debris from the surface of the cartridge with a dry cloth.

System limitations

The recording system in your deck is radically different from those used in cassette and DAT decks and is characterized by the limitations described below. Note, however, that these limitations are due to the inherent nature of the MD recording system itself and not to mechanical causes.

“Disc Full” appears in the display even before the MD has reached the maximum recording time

When 255 tracks have been recorded to the MD, “Disc Full” appears regardless of the total recorded time. More than 255 tracks cannot be recorded to the MD. To continue recording, erase unnecessary tracks or use another recordable MD.

“Disc Full” appears before the maximum number of tracks is reached

Fluctuations in emphasis within tracks are sometimes interpreted as track intervals, incrementing the track count and causing “Disc Full” to appear.

The remaining recording time does not increase even after erasing numerous short tracks

Tracks under 12 seconds¹⁾ in length are not counted and so erasing them may not lead to an increase in the recording time.

- 1) During stereo recording.
In MONO or LP2 mode: about 24 seconds
In LP4 mode: about 48 seconds

Some tracks cannot be combined with others

Tracks may not be combined if they have been edited.

The total recorded time and the remaining recordable time on the MD may not total the maximum recording time

Recording is done in minimum units of 2 seconds¹⁾ each, no matter how short the material is. The contents recorded may thus be shorter than the maximum recording capacity. Disc space may also be further reduced by scratches.

- 1) During stereo recording.
In MONO or LP2 mode: about 4 seconds
In LP4 mode: about 8 seconds

Tracks created through editing may exhibit sound dropout as you are searching for a point while monitoring the sound.

Track numbers are not marked correctly

Incorrect assignment or marking of track numbers may result when CD tracks are divided into several smaller tracks during digital recording. Also, when the Automatic Track Marking is activated during recording, track numbers may not be marked as in the original, depending on the program source.

The correct recorded/playing time may not be displayed during play of MDs recorded in monaural mode.

Guide to the Serial Copy Management System

Digital audio components, such as CDs, MDs, and DATs, make it easy to produce high-quality copies of music by processing music as a digital signal.

To protect copyrighted music sources, this deck uses the Serial Copy Management System, which allows you to make only a single copy of a digitally recorded source through digital-to-digital connections.

You can make only a first-generation copy¹⁾ through a digital-to-digital connection.

Examples are as follows:

- You can make a copy of a commercially available digital sound program (for example, a CD or MD), but you cannot make a second copy from the first-generation copy.
 - You can make a copy of a digital signal from a digitally recorded analog sound program (for example, an analog record or a music cassette tape) or from a digital satellite broadcast program, but you cannot make a second copy from the first-generation copy.
- 1) A first-generation copy means the first recording of a digital audio source through the deck's digital input connector. For example, if you record from a CD player connected to the DIGITAL IN connector, that copy is a first-generation copy.

Note

The restrictions of the Serial Copy Management System do not apply when you make a recording through the analog-to-analog connections.

Troubleshooting

If you experience any of the following difficulties while using the deck, use this troubleshooting guide to help you remedy the problem. Should any problem persist, consult your nearest Sony dealer.

The deck does not operate or operates poorly.

The MD may be dirty or damaged. Replace the MD.

The deck does not play.

- Moisture has formed inside the deck. Take the MD out and leave the deck in a warm place for several hours until the moisture evaporates.
- The deck is not turn on. Press I/⏻ to turn on the deck.
- The deck may not be connected to the amplifier correctly. Check the connection (page 6).
- The MD is inserted in the wrong direction. Slide the MD into the disc slot with the label side up and the arrow pointing toward the slot (page 15).
- The MD may not be recorded. Replace the disc with one that has been recorded.

The sound has a lot of static.

Strong magnetism from a television or a similar device is interfering with operations. Move the deck away from the source of strong magnetism.

The deck does not record.

- The deck is not connected properly to the program source. Check the connection (page 6).
- Select the correct program source using INPUT.
- The recording level is not adjusted properly. Adjust the recording level (page 12).
- A premastered MD is inserted. Replace it with a recordable MD.
- There is not enough time left on the MD. Replace it with another recordable MD with fewer recorded tracks, or erase unnecessary tracks (page 18).
- There has been a power failure or the AC power cord has been disconnected during recording. Data recorded to that point may be lost. Repeat the recording procedure.

The deck does not perform Synchro-recording with a CD player or video CD player.

The remote supplied with the MD deck is not set correctly. Reset the remote.

A message and a three- or five-digit alphanumeric code alternate in the display.

The Self-diagnosis function is on this page.

Note

If the deck does not operate properly even after you have attempted the prescribed remedies, turn off the deck, then re-insert the plug into the power outlet.

Self-diagnosis function

The deck's self-diagnosis function automatically checks the condition of the MD deck when an error occurs, then issues a three- or five-digit code and an error message on the display. If the code and message alternate, find them in the following table and perform the indicated countermeasure. Should the problem persist, consult your nearest Sony dealer.

C11/Protected

- ➔ Take out the MD and close the record-protect slot (page 9).

C12/Cannot Copy

- You tried to record a CD with a format that the external device connected to the deck does not support, such as CD-ROM or video CD.
 - ➔ Remove the disc and insert an audio CD.

C13/REC Error

- ➔ Set the deck in a stable surface, and repeat the recording procedure.
- The inserted MD is dirty (with smudges, fingerprints, etc.), scratched, or substandard in quality.
 - ➔ Replace the disc and repeat the recording procedure.

C13/Read Error

- ➔ Take out the MD and insert it again.

C14/TOC Error

- ➔ Insert another disc.
- ➔ If possible, erase all the tracks on the MD (page 18).

C41/Cannot Copy

- The sound source is a copy of commercially available music software, or you tried to record a CD-R (Recordable CD).
 - ➔ The Serial Copy Management System prevents making a digital copy (page 27). You cannot record a CD-R.
-

C71/Din Unlock

- The sporadic appearance of this message is caused by the digital signal being recorded. This will not affect the recording.
- While recording from a digital component connected through the DIGITAL IN connector, the digital connecting cable was unplugged or the digital component turned off.
 - ➔ Connect the cable or turn the digital component back on.

E0001/MEMORY NG

- There is an error in the internal data that the deck needs in order to operate.
 - ➔ Consult your nearest Sony dealer.

E0101/LASER NG

- There is a problem with the optical pickup.
 - ➔ The optical pickup may have failed. Consult your nearest Sony dealer.

E0201/LOADING NG

- There is a problem with the loading.
 - ➔ The loading may have failed. Consult your nearest Sony dealer.

Display messages

The following table explains the various messages that appear in the display. Messages are also displayed by the deck's Self-diagnosis function (see page 28).

Auto Cut

The Auto Cut Function is on (page 11).

Blank Disc

A new (blank) or erased MD has been inserted.

Cannot Copy

An attempt was made to make a second copy from a digitally dubbed MD (page 27).

Cannot Edit

An attempt was made to edit the MD during Program or Shuffle Play or to change the recording level of an MD recorded in LP2 or LP4 Stereo mode.

Disc Full

The MD is full (page 26).

Impossible

The deck cannot do the recording or editing operation (pages 9 and 20).

Incomplete!

The S.F Edit (changing the recording level after recording, Fade-in, Fade-out) operation was not performed properly because the deck was moved while recording was in progress or the MD is damaged or dirty.

Initialize (flashing)

The Setup Menu settings have been lost. Or the contents recorded by the timer have disappeared over time and are not be available for saving to disc, or Program Play could not be activated since the program has disappeared over time.
(The message flashes for about four seconds when you turn on the deck by pressing I/⏻.)

Name Full!

The naming capacity of the MD has reached its limit (about 1,700 characters).

No Change

While attempting to change the recording level after recording, you pressed PUSH ENTER or YES without actually changing the recording level, so no change was made.

No Disc

There is no MD in the deck.

No Name

The track or disc has no name.

Premastered

An attempt was made to record or edit to a premastered MD.

StepFull!

The program contains the maximum number of tracks. You cannot add any more tracks.

S.F Edit!

You attempted to perform another operation while in S.F Edit (changing the recording level after recording, Fade-in, Fade-out) mode. You cannot perform any other operations while in S.F Edit mode.

Tr Protected

You attempt to erase a protected track.

continued

Display messages (continued)

(S.F) Edit NOW

You pressed I/⏏ while in S.F Edit (changing the recording level after recording, Fade-in, Fade-out) mode.

If you turn off the deck while in S.F Edit mode, any changes that you have made will not be made properly. Finish the changes and leave S.F Edit mode before turning off the deck. If you accidentally turn off the deck while changes are being made, press I/⏏ while the message is displayed.

Smart Space

The Smart Space Function is on (page 11).

TOC Reading

The deck is checking the TOC (Table Of Contents) on the MD.

Setup menu table

Menu item	Reference page
T.Mark	10
LS(T)	10
S.Space	11
P.Hold	12
F.in	25
F.out	25
Sleep	25
LPstamp	9

Specifications

System	MiniDisc digital audio system
Disc	MiniDisc
Laser	Semiconductor laser ($\lambda = 780 \text{ nm}$) Emission duration: continuous
Laser output	MAX 44.6 μW^1
1)	This output is the value measured at a distance of 200 mm from the objective lens surface on the Optical Pick-up Block with 7 mm aperture.
Laser diode	Material: GaAlAs
Revolutions (CLV)	400 rpm to 900 rpm
Error correction	ACIRC (Advanced Cross Interleave Reed Solomon Code)
Sampling frequency	44.1 kHz

Coding	ATrac (Adaptive TTransform Acoustic Coding)/ATrac 3
Modulation system	EFM (Eight-to-Fourteen Modulation)
Number of channels	2 stereo channels
Frequency response	5 to 20,000 Hz $\pm 0.5 \text{ dB}$ during play
Signal-to-noise ratio	Over 96 dB during play
Wow and flutter	Below measurable limit

Inputs

ANALOG IN	Jack type: phono Impedance: 47 kilohms Rated input: 500 mVrms Minimum input: 125 mVrms
DIGITAL OPTICAL IN	Connector type: square optical Impedance: 660 nm (optical wave length)

Outputs

ANALOG OUT	Jack type: phono Rated output: 2 Vrms (at 50 kilohms) Load impedance: over 10 kilohms
------------	---

General

Power requirements

European model:	230 V AC, 50/60Hz
Power consumption	14 W (0.5 W in standby mode)

Dimensions (approx.)	430 \times 95 \times 285 mm (w/h/d) incl. projecting parts and controls
----------------------	---

Mass (approx.)	3.0 kg
----------------	--------

Supplied accessories

Audio connecting cords (2)
Optical cable (1)
Remote commander (remote) (1)
R6 (size-AA) batteries (2)

US and foreign patents licensed from Dolby Laboratories.
Design and specifications are subject to change without notice.

Free Manuals Download Website

<http://myh66.com>

<http://usermanuals.us>

<http://www.somanuals.com>

<http://www.4manuals.cc>

<http://www.manual-lib.com>

<http://www.404manual.com>

<http://www.luxmanual.com>

<http://aubethermostatmanual.com>

Golf course search by state

<http://golfingnear.com>

Email search by domain

<http://emailbydomain.com>

Auto manuals search

<http://auto.somanuals.com>

TV manuals search

<http://tv.somanuals.com>