

Micro Hi-Fi Component System

Operating Instructions

Owner's Record

The model and serial numbers are located on the rear of the unit. Record the serial number in the space provided below. Refer to them whenever you call upon your Sony dealer regarding this product.

Model No. _____

Serial No. _____



CMT-CPX1

WARNING

To prevent fire or shock hazard, do not expose the unit to rain or moisture.

To prevent fire, do not cover the ventilation of the apparatus with news papers, table-cloths, curtains, etc. And don't place lighted candles on the apparatus.

To prevent fire or shock hazard, do not place objects filled with liquids, such as vases, on the apparatus.

Do not install the appliance in a confined space, such as a bookcase or built-in cabinet.

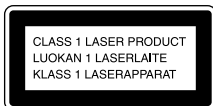

This appliance is classified as a CLASS 1 LASER product. This label is located on the rear exterior.



Don't throw away the battery with general house waste, dispose of it correctly as chemical waste.

NOTICE FOR THE CUSTOMERS IN THE U.S.A.

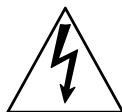

This symbol is intended to alert the user to the presence of uninsulated "dangerous voltage" within the product's enclosure that may be of sufficient magnitude to constitute a risk of electric shock to persons.



This symbol is intended to alert the user to the presence of important operating and maintenance (servicing) instructions in the literature accompanying the appliance.

CAUTION

The use of optical instruments with this product will increase eye hazard.

As the laser beam used in this CD player is harmful to eyes, do not attempt to disassemble the cabinet. Refer servicing to qualified personnel only.

Note to CATV system installer:

This reminder is provided to call the CATV system installer's attention to Article 820-40 of the NEC that provides guidelines for proper grounding and, in particular, specifies that the cable ground shall be connected to the grounding system of the building, as close to the point of cable entry as practical.

CAUTION

You are cautioned that any changes or modifications not expressly approved in this manual could void your authority to operate this equipment.

NOTICE FOR THE CUSTOMER IN CANADA

CAUTION

TO PREVENT ELECTRIC SHOCK, DO NOT USE THIS POLARIZED AC PLUG WITH AN EXTENSION CORD, RECEPTACLE OR OTHER OUTLET UNLESS THE BLADES CAN BE FULLY INSERTED TO PREVENT BLADE EXPOSURE.

Except for European model



ENERGY STAR® is a U.S. registered mark. As an ENERGY STAR® partner, Sony Corporation has determined that this product meets the ENERGY STAR® guidelines for energy efficiency.

How to use this manual

This manual mainly explains operations using the remote, but the same operations can also be performed using the buttons on the system having the same or similar names.

Table of Contents

How to use this manual.....	2		
Getting Started		Display	
Hooking up the system.....	4	Turning off the display	16
Setting the clock.....	5	— Power Saving Mode	
CD – Play		Viewing information about the disc in the display	16
Loading a disc	6	Optional Components	
Playing a disc	6	Hooking up optional components.....	17
— Normal Play/Shuffle Play		Listening to audio from a connected component	18
Playing repeatedly.....	7	Recording on a connected component..	18
— Repeat Play		Troubleshooting	
Creating your own program.....	7	Problems and remedies.....	19
— Program Play		Messages.....	21
Tuner		Additional Information	
Presetting radio stations	8	Precautions.....	22
Listening to the radio	10	Specifications.....	23
— Preset Tuning		List of button locations and reference pages.....	25
— Manual Tuning		Tape – Play	
Using the Radio Data System (RDS)....	10	Loading a tape.....	11
(European model only)		Playing a tape.....	11
Tape – Play		Tape – Recording	
Loading a tape.....	11	Recording your favorite CD tracks on a tape.....	12
Playing a tape.....	11	— CD-TAPE Synchro Recording	
Tape – Recording		Recording on a tape manually.....	12
Recording your favorite CD tracks on a tape.....	12	— Manual Recording	
— CD-TAPE Synchro Recording		Sound Adjustment	
Recording on a tape manually.....	12	Adjusting the sound	13
— Manual Recording		Timer	
Sound Adjustment		Falling asleep to music.....	13
Adjusting the sound	13	— Sleep Timer	
Timer		Waking up to music	14
Falling asleep to music.....	13	— Daily Timer	
— Sleep Timer		Timer recording radio programs	15
Waking up to music	14		
— Daily Timer			
Timer recording radio programs	15		

Hooking up the system

Perform the following procedures **1** to **3** to hook up your system using the supplied cords and accessories.

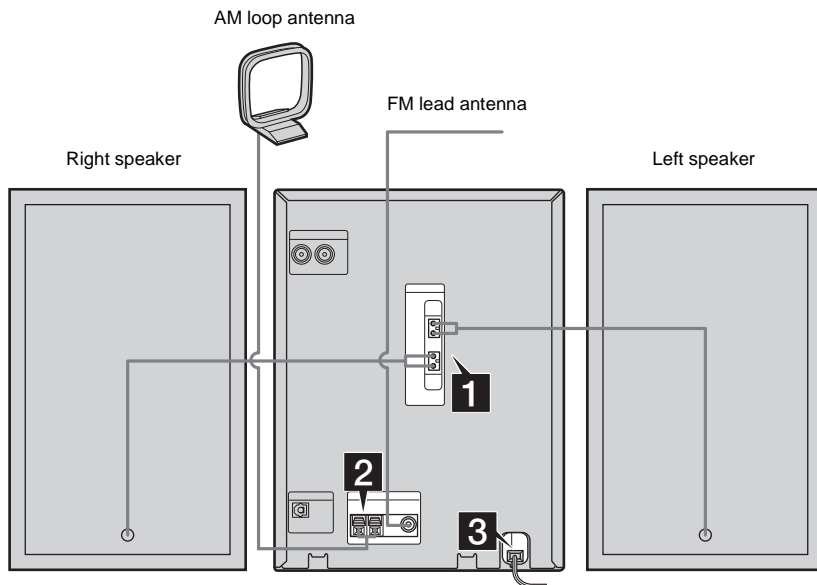

1 Connect the speakers.

Connect the right and left speaker cords to the SPEAKER terminals as shown below.

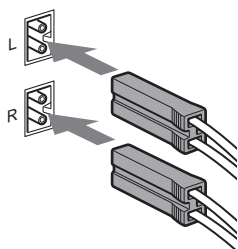

2 Connect the FM and AM antennas.

Set up the AM loop antenna, then connect it.

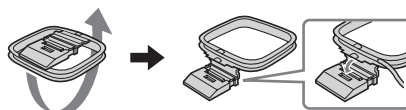

FM antenna (Type A)

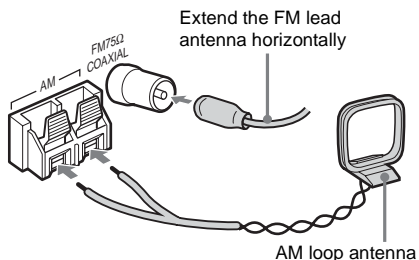

FM antenna (Type ②)

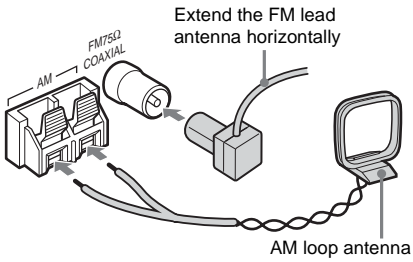

Note

To prevent noise pickup, keep the antennas away from the system and other components.

3 Connect the mains lead to mains.

If the plug does not fit the wall socket, detach the supplied plug adaptor (only for models equipped with an adaptor).

To turn on the system, press I/⏻.

To attach the speaker pads

Attach the supplied speaker pads to the bottom of the speakers to stabilize the speakers and prevent them from slipping.

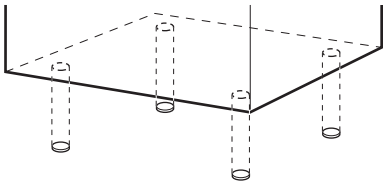

Inserting two R6 (size AA) batteries into the remote

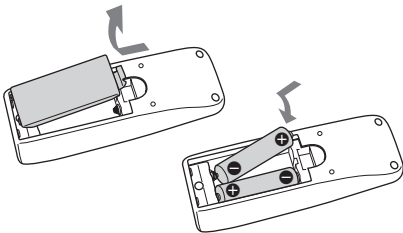

Note

If you do not use the remote for a long period of time, remove the batteries to avoid possible damage from battery leakage and corrosion.

Tip

When the remote no longer operates the system, replace both batteries with new ones.

Setting the clock

- 1 Press I/⏻ to turn on the system.
- 2 Press CLOCK/TIMER SET.
- 3 Press I◀◀ or ▶▶I repeatedly to set the hour.
- 4 Press ENTER.
- 5 Press I◀◀ or ▶▶I repeatedly to set the minute.
- 6 Press ENTER.

The clock starts working.

To adjust the clock

- 1 Press CLOCK/TIMER SET.
- 2 Press I◀◀ or ▶▶I until "CLOCK" appears, then press ENTER.
- 3 Do the same procedures as step 3 to 6 above.

Note

The clock is not displayed in Power Saving Mode.

CD – Play

Loading a disc

- 1 Press **CD**  on the unit.
- 2 Place a disc with the label side up on the disc tray.

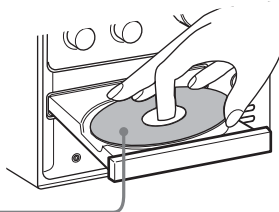

When you play a 8 cm disc, place it on the inner circle of the tray.

- 3 Press **CD**  again to close the disc tray.

Notes

- Do not use a disc with tape, seals or paste on it as this may cause malfunction.
- Do not forcibly press the disc tray closed with your finger, as this may cause malfunction.

Playing a disc

— Normal Play/Shuffle Play

This system lets you play CD in different play modes.

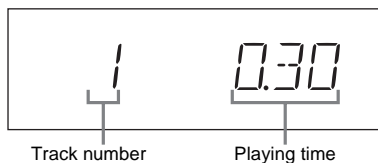



- 1 Press **CD** (or **FUNCTION** repeatedly) to switch the function to CD.
- 2 Press **PLAY MODE** in stop mode repeatedly until the mode you want appears.

Select	To play
No display (Normal Play)	The tracks on the disc in original order.
SHUFFLE (Shuffle Play)	All tracks on the disc in random order.
PROGRAM (Program Play)	The tracks on the disc in the order you want them to be played (see “Creating your own program” on page 7).

- 3 Press **CD** .

Other operations

To	Do this
Stop play	Press CD  .
Pause	Press CD  . Press again to resume play.
Select a track	Press ◀◀ or ▶▶ repeatedly.
Find a point in a track	Keep pressing ◀◀ or ▶▶ during playback and release it at the desired point.
Remove a disc	Press CD  on the unit.

Playing repeatedly

— Repeat Play

You can play all the tracks or a single track on a disc repeatedly.

Press **REPEAT** repeatedly during playback until “REPEAT” or “REPEAT 1” appears.

REPEAT: For all the tracks on the disc up to five times.

REPEAT 1: For a single track only.

To cancel Repeat Play

Press **REPEAT** repeatedly until both “REPEAT” and “REPEAT 1” disappear.

Creating your own program

— Program Play

You can make a program of up to 25 steps.

You can synchro record the programmed tracks onto a cassette tape (page 12).

- 1** Press **CD** (or **FUNCTION** repeatedly) to switch the function to **CD**.
- 2** Press **PLAY MODE** in stop mode repeatedly until “PROGRAM” appears.
- 3** Press **◀◀** or **▶▶** repeatedly until the desired track number appears.

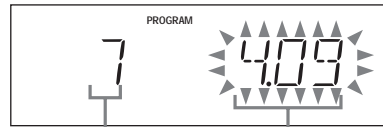

Selected track number Total playing time

- 4** Press **ENTER** (or **PLAY MODE**).

The track is programmed.

The step number appears, followed by the last programmed track number.

- 5** To program additional tracks, repeat steps 3 and 4.

- 6** Press **CD ▶||**.

Program Play starts.

Other operations

To	Do this
Cancel Program Play	Press PLAY MODE in stop mode repeatedly until both “PROGRAM” and “SHUFFLE” disappear.
Erase the program	Press CLEAR in step 4. Each time you press the button, a track is cleared from the end of the program.
Add a track to the end of the program	Perform steps 3 and 4 in stop mode.

continued

Tips

- The program you made remains after Program Play finishes. To play the same program again, press CD ►||. However, the program is cleared when you open the disc tray.
- “--:--” appears when the total program time exceeds 100 minutes.

Tuner

Presetting radio stations

You can preset up to 20 FM stations and 10 AM stations. You can then tune in any of those stations simply by selecting the corresponding preset number.

Automatic tuning preset

You can automatically tune in all of the stations that can be received in your area and then store the radio frequency of the desired stations.

- 1 Press TUNER/BAND repeatedly to select “FM” or “AM”.**
- 2 Press TUNING MODE repeatedly until “AUTO” appears in the display.**
- 3 Press TUNING +/-.**

The frequency changes as the system scans for a station. Scanning stops automatically when a station is tuned in. At that time, “TUNED” and “STEREO” (for stereo program only) appear.

If “TUNED” does not appear and the scanning does not stop

Set the frequency of the desired radio station as described in steps 2 and 3 of “Manual tuning preset” (page 9).

- 4 Press TUNER MEMORY.**

The preset number flashes. Perform steps 5 and 6 while the preset number flashes.

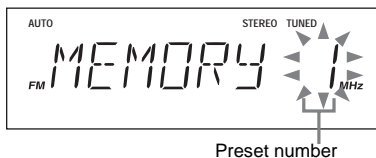

- 5 Press TUNING +/- repeatedly to select the desired preset number.**
- 6 Press ENTER.**
- 7 Repeat steps 3 through 6 to preset other stations.**

Tip

Press TUNING MODE to stop scanning.

Manual tuning preset

You can manually tune in and store the radio frequency of the desired stations.

- 1 Press TUNER/BAND repeatedly to select “FM” or “AM”.**
- 2 Press TUNING MODE repeatedly until “AUTO” and “PRESET” disappear from the display.**
- 3 Press TUNING +/- repeatedly to tune in the desired station.**
- 4 Press TUNER MEMORY.**
- 5 Press TUNING +/- repeatedly to select the desired preset number.**
- 6 Press ENTER.**
- 7 Repeat steps 3 through 6 to preset other stations.**

Other Operations

To	Do this
Tune in a station with a weak signal	Follow the procedure described in “Manual tuning preset” (page 9).
Set another station to the existing preset number	After step 4, press TUNING +/- repeatedly to select the preset number you want to store the station.

To change the AM tuning interval (except for European models)

The AM tuning interval is factory-preset to 9 kHz (or 10 kHz for some areas). To change the AM tuning interval, tune in any AM station first, then turn off the system. While holding TUNING -, press I/⏻ on the unit. When you change the interval, all the AM preset stations are erased. To reset the interval, repeat the same procedure.

Note

You cannot change the AM tuning interval in the Power Saving Mode.

Tips

- The preset stations are retained for about half a day even if you disconnect the mains lead or if a power failure occurs.
- To improve the reception, adjust the supplied antennas or connect an external antenna.

Listening to the radio

You can listen to a radio station either by selecting a preset station, or by manually tuning in the station.

Listening to a preset station

— *Preset Tuning*

Preset radio stations in the tuner's memory first (see "Presetting radio stations" on page 8).

- 1 Press TUNER/BAND repeatedly to select "FM" or "AM".**
- 2 Press TUNING MODE repeatedly until "PRESET" appears in the display.**
- 3 Press TUNING +/- repeatedly to select the desired preset station.**

Listening to non-preset radio station

— *Manual Tuning*

- 1 Press TUNER/BAND repeatedly to select "FM" or "AM".**
- 2 Press TUNING MODE repeatedly until "AUTO" and "PRESET" disappear from the display.**
- 3 Press TUNING +/- repeatedly to tune in the desired station.**

Tips

- To improve broadcast reception, adjust the supplied antennas, or connect a commercially available external antenna.
- When an FM stereo program has static noise, press FM MODE on the unit repeatedly until "MONO" appears. There will be no stereo effect, but the reception will improve.
- Press TUNING MODE repeatedly until "AUTO" appears in step 2 above, then press TUNING +/- . The frequency indication changes and scanning stops when the system tunes in a station (Automatic Tuning).
- To record the radio programs, use manual recording (pages 12 and 15).

Using the Radio Data System (RDS)

(European model only)

What is the Radio Data System?

Radio Data System (RDS) is a broadcasting service that allows radio stations to send additional information along with the regular program signal. RDS is available only on FM stations.*

Note

RDS may not work properly if the station you are tuned in is not transmitting the RDS signal properly or if the signal is weak.

* Not all FM stations provide RDS service, nor do they provide the same types of services. If you are not familiar with the RDS system, check with your local radio stations for details on RDS services in your area.

Receiving RDS broadcasts

Simply select a station from the FM band.

When you tune in a station that provides RDS services, the station name appears in the display.

To check the RDS information

Each time you press DISPLAY, the display changes cyclically as follows:

Station name* → Frequency → Clock display → Bass level → Treble level

* If the RDS broadcast is not properly received, the station name may not appear in the display.

Loading a tape

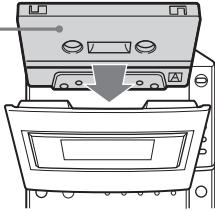

- 1 Press **TAPE**  on the unit.
- 2 Load a tape into the cassette holder.

With the side you want to play/record facing towards you.







Playing a tape





You can use TYPE I (normal) tape.

- 1 Press **TAPE** (or **FUNCTION** repeatedly) to switch the function to **TAPE**.
- 2 Press **DIRECTION** on the unit repeatedly to select “” to play one side of a tape, “” to play both sides, or “” to play both sides repeatedly.

* The tape deck stops automatically after repeating the sequence five times.

- 3 Press **TAPE**  .
- Press **TAPE**   again to play the reverse side.

Other operations

To	Do this
Stop play	Press TAPE  .
Pause	Press TAPE  on the unit. Press again to resume play.
Fast-forward or rewind	Press  or  .
Remove a tape	Press TAPE  on the unit in stop mode.

Recording your favorite CD tracks on a tape

— CD-TAPE Synchro Recording

You can record a whole CD on a tape.

You can use TYPE I (normal) tape.

Use buttons on the unit for the operation.

- 1 Load a recordable tape.**
- 2 Load a CD you want to record.**
- 3 Press CD SYNCHRO.**
“SYNC” appears. “REC” and “▶” (or “◀”) light up. The tape deck stands by for recording and the CD player pauses for play.
- 4 Press DIRECTION repeatedly until ⇄ appears to record on one side or ⇅ (or ⇄⇅) to record on both sides.**
- 5 Press TAPE ◀▶ repeatedly to select recording side.**
If you select both sides recording or front side recording, press TAPE ◀▶ to light up the ▶ indicator. If you record on the reverse side, press TAPE ◀▶ again to light up the ◀ indicator.
- 6 Press TAPE II.**
Recording starts.
When the recording is completed, the CD player and the tape deck stop automatically.

To stop recording

Press TAPE ■.

To record a disc by specifying track order

You can record only your favorite CD tracks using Program Play. Between steps 2 and 3, perform steps 1 to 5 of “Creating your own program” (page 7).

Tip

If you select both sides recording and the tape reaches the end of the front side part-way through a track, the entire track is recorded again from the beginning of the reverse side.

Recording on a tape manually

— Manual Recording

You can record just the portions you like from a CD on a tape. You can also record a radio program.

Use buttons on the unit for the operation.

- 1 Load a recordable tape.**
- 2 Press FUNCTION repeatedly to select the desired source to record.**
 - TUNER: To record from this system’s tuner.
 - CD: To record from this system’s CD player.
 - MD or VIDEO: To record from the optional component connected to the MD (VIDEO) IN jacks.
- 3 Press TAPE ● REC.**
“▶” lights up and the tape deck stands by for recording.
- 4 Press DIRECTION repeatedly until ⇄ appears to record on one side or ⇅ (or ⇄⇅) to record on both sides.**
- 5 Press TAPE ◀▶ repeatedly to select recording side.**
If you select both sides recording or front side recording, press TAPE ◀▶ to light up the ▶ indicator. If you record on the reverse side, press TAPE ◀▶ again to light up the ◀ indicator.
- 6 Press TAPE II, then start playing the desired source to record.**
Recording starts.

Other operations

To	Do this
Stop recording	Press TAPE ■.
Pause recording	Press TAPE II on the unit.

Sound Adjustment

Adjusting the sound

You can adjust the bass and treble to enjoy more powerful sound.

Generating a more dynamic sound (Dynamic Sound Generator)

Press DSG on the unit.

To cancel the DSG, press DSG again.

Adjusting the bass and treble

You can adjust the bass and treble.

1 Press EQ repeatedly to select "BASS" or "TRE".

Each time you press the button, the display changes as follows:

BASS ↔ TRE

2 Press EQ + or – repeatedly to adjust the level while "BASS" or "TRE" appears.

To adjust the bass on the unit

Turn **BASS**.

To adjust the treble on the unit

Turn **TREBLE**.

To exit the bass and treble settings

Press any button other than EQ or EQ +/-.

Also, if you do not perform any operations for a few seconds, the display automatically returns to the original display.

Timer

Falling asleep to music

— Sleep Timer

You can set the system to turn off after a certain time, so that you can fall asleep to music.

Press SLEEP.

Each time you press the button, the minute display (the turn-off time) changes cyclically as follows:

AUTO* → 90MIN → 80MIN → ... → 10MIN → OFF

* The system automatically turns off in 240 minutes or after the current CD or tape finishes playing.

Other operations

To	Press
Check the remaining time**	SLEEP once.
Change the time to turn off	SLEEP repeatedly to select the time you want.
Cancel the Sleep Timer Function	SLEEP repeatedly until "OFF" appears.

**You cannot check the remaining time if you select "AUTO".

Tip

You can use the Sleep Timer, even if you have not set the clock.

Waking up to music

— Daily Timer

You can wake up to music at a preset time. Make sure you have set the clock (see “Setting the clock” on page 5).

1 Prepare the sound source you want to play.

- CD: Load a disc. To start from a specific track, make a program (see “Creating your own program” on page 7).
- TAPE: Load a tape (see “Playing a tape” on page 11).
- TUNER: Tune in the preset radio station (see “Listening to the radio” on page 10).

2 Press VOL + or – to adjust the volume.

3 Press CLOCK/TIMER SET.

4 Press ◀◀ or ▶▶ repeatedly until “DAILY” appears, then press ENTER.

“ON TIME” appears and the hour indication flashes.

5 Set the time to start playing.

Press ◀◀ or ▶▶ repeatedly to set the hour, then press ENTER.

The minute indication flashes.

Press ◀◀ or ▶▶ repeatedly to set the minute, then press ENTER.

6 Set the time to stop playing following the same procedure as step 5.

7 Press ◀◀ or ▶▶ repeatedly until the desired sound source appears.

Each time you press the button, the display changes cyclically as follows:

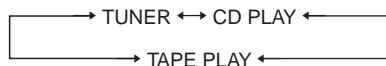

8 Press ENTER.

The start time, the stop time, the sound source and VOLUME appear in turn, then the original display returns.

9 Press I/⏻ to turn off the system.

Other operations

To	Do this
Cancel the timer/ activate the timer/ check the settings	1 Press CLOCK/TIMER SELECT. 2 Press ◀◀ or ▶▶ repeatedly until “SELECT” appears, then press ENTER. 3 Press ◀◀ or ▶▶ repeatedly until “DAILY”, “ON” or “OFF” appears, then press ENTER.
Change the setting	Start over from step 1.
Cancel both Daily Timer and Timer Recording	1 Press CLOCK/TIMER SELECT. 2 Press ◀◀ or ▶▶ repeatedly until “OFF” appears, then press ENTER.

Notes

- The Daily Timer setting or the Timer Recording setting overlaps with part or all of another timer setting.
- If you use the Daily Timer and the Sleep Timer at the same time, the Sleep Timer has priority.
- Do not operate the system from the time the system turns on until the play starts (about 15 seconds before the preset time).
- If the system is on about 15 seconds before the preset time, the Daily Timer will not be activated.
- You cannot use the optional component connected to MD (VIDEO) IN jacks as the sound source for Daily Timer.
- When the Daily Timer is set to “OFF”, “SELECT” does not appear. However, “SELECT” does appear when the Timer Recording is set to “ON”.

Timer recording radio programs

To timer record, you must first preset the radio station (see “Presetting radio stations” on page 8) and set the clock (see “Setting the clock” on page 5).

- 1 Tune in the preset radio station (see “Listening to a preset station” on page 10).**
- 2 Press CLOCK/TIMER SET.**
- 3 Press ◀◀ or ▶▶ repeatedly until “REC” appears, then press ENTER.**
“ON TIME” appears and the hour indication flashes.
- 4 Set the time to start recording.**
Press ◀◀ or ▶▶ repeatedly to set the hour, then press ENTER.
The minute indication flashes.
Press ◀◀ or ▶▶ repeatedly to set the minute, then press ENTER.
- 5 Set the time to stop recording following the same procedure as step 4.**
Timer Recording settings and the desired station appear, then the original display returns.
- 6 Load a recordable tape.**
- 7 Press DIRECTION repeatedly until ⇌ appears to record on one side or ⇔ (or ⇔⇔) to record on both sides.**
- 8 Press TAPE ◀▶ repeatedly to select recording side.**
If you select both sides recording or front side recording, press TAPE ◀▶ to light up the ▶ indicator. If you record on the reverse side, press TAPE ◀▶ again to light up the ◀ indicator.
- 9 Press I/⏻ to turn off the system.**

Other operations

To	Do this
Cancel the timer/ activate the timer/ check the settings	1 Press CLOCK/TIMER SELECT. 2 Press ◀◀ or ▶▶ repeatedly until “SELECT” appears, then press ENTER. 3 Press ◀◀ or ▶▶ repeatedly until “REC”, “ON” or “OFF” appears, then press ENTER.
Change the setting	Start over from step 1.
Cancel both Daily Timer and Timer Recording	1 Press CLOCK/TIMER SELECT. 2 Press ◀◀ or ▶▶ repeatedly until “OFF” appears, then press ENTER.

Notes

- The Daily Timer setting or the Timer Recording setting overlaps with part or all of another timer setting.
- If you use the Timer Recording and the Sleep Timer at the same time, the Sleep Timer has priority.
- Do not operate the system from the time the system turns on until the recording starts (about 15 seconds before the preset time).
- If the system is on about 15 seconds before the preset time, the Timer Recording will not be activated.
- The volume is reduced to minimum during recording.
- Note that if the Timer Recording is set at the same time as the Daily Timer sound source is set to tape, the Timer Recording sound may be recorded onto the tape.
- When the Timer Recording is set to “OFF”, “SELECT” does not appear. However, “SELECT” does appear when the Daily Timer is set to “ON”.

Display

Turning off the display

— Power Saving Mode

The clock display can be turned off to minimize the amount of power consumed during standby (Power Saving Mode).

Press DISPLAY repeatedly while the system is off until the clock display disappears.

To cancel Power Saving Mode

Press DISPLAY while the system is off. Each time you press the button, the display switches cyclically as follows:

Clock display* ↔ No display (Power Saving Mode)

* The clock is displayed only if you set the clock.

Tips

- I/⏻ indicator lights up even in the Power Saving Mode.
- The timer continues to operate in Power Saving Mode.

Note

You cannot perform the following operations in Power Saving Mode.

- setting the clock
- changing the AM tuning interval (except for European models)
- turning on the system by pressing the function buttons
- switching the MD (VIDEO) function

Viewing information about the disc in the display

You can check the playing time and remaining time of the current track or that of the disc.

Checking the remaining time (CD)

Press DISPLAY during Normal Play.

Each time you press the button, the display changes cyclically as follows:

Current track number and elapsed playing time
→ Current track number and remaining time →
Remaining time of the current disc → Clock display → Bass level → Treble level

Checking the total playing time (CD)

Press DISPLAY in stop mode.

Each time you press the button, the display changes cyclically as follows:

Total playing time → Clock display → Bass level → Treble level

Hooking up optional components

To enhance your system, you can connect optional components. Refer to the operating instructions provided with each component.

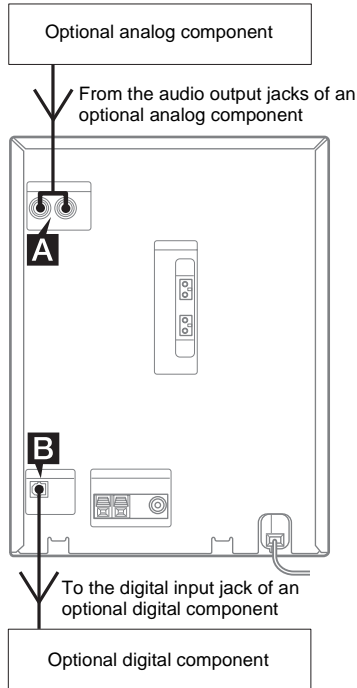

A MD (VIDEO) IN jacks

Use audio cords (not supplied) to connect an optional analog component (MD deck or VCR, etc.) to these jacks. You can then listen to the sound from the component.

B CD DIGITAL OUT jack

Use a digital optical cord (square, not supplied) to connect an amplifier, MD deck, or DAT deck with a digital optical input jack. Sound is then output when the system function is set to CD. If the jack is covered with a cap, remove it before use.

Listening to audio from a connected component

- 1 Connect audio cords.**
See “Hooking up optional components” on page 17.
- 2 Press FUNCTION repeatedly until “MD” or “VIDEO” appears.**
Start playing the connected component.

Tip

If you cannot select “VIDEO” by pressing FUNCTION repeatedly, turn off the system and then press I/⏻ while holding down FUNCTION on the unit. The function will change from “MD” to “VIDEO”, and “VIDEO” will appear in the display. To change back to “MD”, repeat the same procedure. However, you cannot switch the MD (VIDEO) function in Power Saving Mode.

Recording on a connected component

Making a digital recording

- 1 Connect the digital optical cord.**
- 2 Start recording.**
Refer to the operating instructions provided with connected component.

Note

You can digitally record from the discs only. However, you cannot record from copy prohibited discs.

Problems and remedies

Should you encounter a problem with your system, do the following:

- 1 Make sure the power cord and speaker cords are correctly and firmly connected.
- 2 Find your problem in the troubleshooting checklist below and take the indicated corrective action.

If the problem persists after doing all of the above, consult your nearest Sony dealer.

General

“- -: -” appears in the display.

- A power interruption has occurred. Set the clock (page 5) and timer settings (pages 14 and 15) again.

There is no sound.

- Press VOL +.
- Make sure the headphones are not connected.
- Check the speaker connections (page 4).

Sound comes from one channel, or unbalanced left and right volume.

- Place the speakers as symmetrically as possible.
- Connect the supplied speakers.

There is severe hum or noise.

- Move the system away from the source of noise.
- Connect the system to a different wall outlet.
- Install a noise filter (commercially available) to the mains line.

The timer cannot be set.

- Set the clock again (page 5).

The timer does not function.

- Press CLOCK/TIMER SELECT to set the timer and light up “⊙DAILY” or “⊙REC” in the display (pages 14 and 15).
- Check the timer setting and set the correct time (pages 14 and 15).
- Cancel the Sleep Timer Function (page 13).
- Make sure the clock is correctly set.

The color on the TV screen is irregular.

- Move the speakers farther away from the TV set.

The remote does not function.

- Remove the obstacle.
- Move the remote closer to the system.
- Point the remote at the system’s sensor.
- Replace the batteries (R6/size AA).
- Locate the system away from the fluorescent light.

“PROTECT”, “PUSH” and “POWER” appear alternately.

- A strong signal was input. Press I/⏻ to turn off the system, leave the system turned off for a while, then press I/⏻ again to turn on the system. If “PROTECT”, “PUSH” and “POWER” still appear alternately, turn off the system and check the speaker cords.

Speakers

Sound comes from only one channel, or the left and right volumes are unbalanced.

- Check the speaker connections and placement.

CD

The disc tray does not open and “LOCKED” appears.

- Contact your Sony dealer or local authorized Sony service facility.

The disc tray does not close.

- Place the disc correctly in the center of the tray.
- Always close the tray by pressing CD ▲ on the unit. Trying to press the tray closed with your fingers may cause problems with the player.

The disc does not eject.

- You cannot eject the disc during CD Synchro Recording. Press ■ to cancel the CD Synchro Recording, then press CD ▲ on the unit to eject the disc.
- Consult your nearest Sony dealer.

Play does not start.

- Open the disc tray and check whether a disc is loaded.
- Wipe the disc clean (page 22).
- Replace the disc.
- Place the disc that this system can play.
- Place the disc correctly in the center of the tray.
- Place the disc in the tray with the label side up.
- Remove the disc and wipe away the moisture on the disc, then leave the system turned on for a few hours until the moisture evaporates.
- Press CD ▶|| to start play.

continued

The sound skips.

- Wipe the disc clean (page 22).
- Replace the disc.
- Try moving the system to a place without vibration (e.g., on top of a stable stand).
- Try moving the speakers away from the system, or placing them on separate stands. When you listen to a track with bass sounds at high volume, the speaker vibration may cause the sound to skip.

Play does not start from the first track.

- Press PLAY MODE repeatedly until both “PROGRAM” and “SHUFFLE” disappear to return to Normal Play.

Tuner

Severe hum or noise/stations cannot be received.

- Set the proper band and frequency (page 8).
- Connect the antenna properly (page 4).
- Find a place and an orientation that provide good reception, then set up the antenna again. If you cannot obtain good reception, we recommend you connect a commercially available external antenna.
- The supplied FM lead antenna receives signals along its entire length, so make sure you extend it fully.
- Keep the antennas away from the system and other components.
- Consult your nearest Sony dealer if the supplied AM antenna has come off the plastic stand.
- Try turning off surrounding electrical equipment.

A stereo FM program cannot be received in stereo.

- Press FM MODE on the unit until “STEREO” appears in the display.

Tape deck

The tape does not record or play, or there is a decrease in sound level.

- The heads are dirty. Clean them (page 23).
- The record/playback heads are magnetised. Demagnetise them (page 23).

The tape does not erase completely.

- The record/playback heads are magnetised. Demagnetise them (page 23).

There is excessive wow or flutter, or the sound drops out.

- The capstans in the tape deck are dirty. Clean them using a cleaning cassette.

Noise increases or the high frequencies are erased.

- The record/playback heads are magnetised. Demagnetise them (page 23).

The tape does not record.

- No cassette is loaded. Load a cassette.
- The tab has been removed from the cassette. Cover the broken tab with adhesive tape (page 23).
- The tape has wound to the end.

Optional components

There is no sound.

- Refer to General item “There is no sound.” (page 19) and check the condition of the system.
- Connect the component properly (page 17) while checking:
 - if the cords are connected properly.
 - if the cord plugs are firmly inserted all the way.
- Turn on the connected component.
- Refer to the operating instructions supplied with the connected component and start playing.
- Press FUNCTION repeatedly to select “MD” or “VIDEO” (page 18).

The sound is distorted.

- Set the volume of the connected component lower.

If the system still does not operate properly after performing the above measures, reset the system as follows:

- 1 Disconnect the mains lead.
- 2 Reconnect the mains lead.
- 3 Press I/⏻ to turn on the system.
- 4 Press TAPE ■, CD ■ and I/⏻ on the unit.

The system is reset to the factory settings. You should set the settings you made, such as the preset stations, clock, and timer.

Messages

One of the following messages may appear or flash in the display during operation.

CD

NO DISC

There is no disc in the player.

NO STEP

All of the programmed tracks have been erased.

OVER

You have reached the end of the disc while pressing **▶▶** during playback or pause.

PUSHSTOP

You pressed PLAY MODE during playback.

PGM FULL

You tried to program 25 or more tracks (steps).

TUNER

COMPLETE

The preset operation ended normally.

TAPE

NO TAB

You cannot record the tape because the tab has been removed from the cassette.

NO TAPE

There is no tape in the tape deck.

Timer

TIME NG

The Daily Timer or Timer Recording start and end times are set to the same time.

OVERLAP

The Daily Timer setting or the Timer Recording setting overlaps with part or all of another timer setting.

SET NG

You cannot select the timer function when the Daily Timer or Timer Recording are not set.

Precautions

On operating voltage

Before operating the system, check that the operating voltage of your system is identical with the voltage of your local power supply.

On safety

- The unit is not disconnected from the AC power source (mains) as long as it is connected to the wall outlet, even if the unit itself has been turned off.
- Unplug the system from the wall outlet (mains) if it is not to be used for an extended period of time. To disconnect the power cord (mains lead), pull it out by the plug. Never pull the cord itself.
- Should any solid object or liquid fall into the system, unplug the system and have it checked by qualified personnel before operating it any further.
- AC power cord must be changed only at the qualified service shop.

On placement

- Do not place the system in an inclined position.
- Do not place the system in locations where it is:
 - Extremely hot or cold
 - Dusty or dirty
 - Very humid
 - Subject to vibrations
 - Subject to direct sunlight.
- Use caution when placing the unit or speakers on surfaces that have been specially treated (with wax, oil, polish, etc.) as staining or discoloration of the surface may result.

On heat buildup

- Although the system heats up during operation, this is not a malfunction.
- Place the system in a location with adequate ventilation to prevent heat build-up in the system.
- If you continuously use this system at a high volume, the cabinet temperature of the top, side and bottom rises considerably. To avoid burning yourself, do not touch the cabinet.
- To prevent a malfunction, do not cover the ventilation hole.

On operation

- If the system is brought directly from a cold to a warm location, or is placed in a very damp room, moisture may condense on the lens inside the CD player. Should this occur, the system will not operate properly. Remove the disc and leave the system turned on for about an hour until the moisture evaporates.
- When you move the system, take out any disc.

If you have any questions or problems concerning your system, please consult your nearest Sony dealer.

Notes on discs

- Before playing, clean the disc with a cleaning cloth. Wipe the disc from the center out.
- Do not use solvents such as benzene, thinner, commercially available cleaners or anti-static spray intended for vinyl LPs.
- Do not expose the disc to direct sunlight or heat sources such as hot air ducts, nor leave it in a car parked in direct sunlight.
- Do not use discs encircled with a protection ring. This may cause a malfunction to the system.
- When using discs that have glue or similar tacky substance on the label side of the disc or that used a special ink when the label was printed, there is a chance that the disc or label may become attached to parts inside this unit. When this occurs, it may not be possible to remove the disc, and may also cause this unit to malfunction. Be sure to check that the label side of the disc is not sticky before using.
The following types of disc should not be used:
 - Rental or used discs with attached seals where the glue extends beyond the seal. The perimeter of the seal on the disc is tacky.
 - Discs that have labels printed using a special ink that feels tacky when touched.
- Discs with non-standard shapes (e.g., heart, square, star) cannot be played on this unit. Attempting to do so may damage the unit. Do not use such discs.

Notes on CD-R and CD-RW

- This system can play CD-R/CD-RW discs edited by the user. However, note that playback of some discs may not be possible depending on the recording device used for recording or the disc condition.
- CD-R and CD-RW discs that have not been finalized (processing to allow play by a normal CD player) cannot be played.
- CD-R and CD-RW discs recorded in multi-session mode are not supported.

Music discs encoded with copyright protection technologies

This product is designed to playback discs that conform to the Compact Disc (CD) standard. Recently, various music discs encoded with copyright protection technologies are marketed by some record companies. Please be aware that among those discs, there are some that do not conform to the CD standard and may not be playable by this product.

Cleaning the cabinet

Clean the cabinet, panel and controls with a soft cloth slightly moistened with mild detergent solution. Do not use any type of abrasive pad, scouring powder or solvent such as thinner, benzene or alcohol.

To save a tape permanently

To prevent a tape from being accidentally recorded over, break off the cassette tab from side A or B as illustrated.

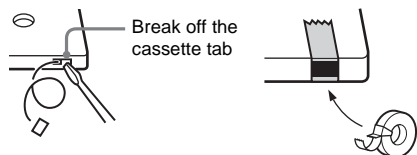

If you later want to reuse the tape for recording, cover the broken tab with adhesive tape.

Before placing a cassette in the tape deck

Take up any slack in the tape. Otherwise, the tape may get entangled in the parts of the tape deck and become damaged.

When using a tape longer than 90 minutes

The tape is very elastic. Do not change the tape operations such as play, stop, and fast-winding frequently. The tape may get entangled in the tape deck.

Cleaning the tape heads

Clean the tape heads after every 10 hours of use. Be sure to clean the tape heads before you start an important recording or after playing an old tape.

Use a separately sold dry-type or wet-type cleaning cassette. For details, refer to the instructions of the cleaning cassette.

Demagnetising the tape heads

Demagnetise the tape heads and the metal parts that have contact with the tape after every 20 to 30 hours of use with a separately sold demagnetising cassette. For details, refer to the instructions of the demagnetising cassette.

Specifications

Main Unit (HCD-CPX1)

Amplifier section

For the U.S. model

AUDIO POWER SPECIFICATIONS

POWER OUTPUT AND TOTAL HARMONIC DISTORTION:

With 4-ohm loads, both channels driven, from 100 – 10,000 Hz: rated 70 watts per channel minimum RMS power, with no more than 10% total harmonic distortion from 250 milliwatts to rated output.

North American model:

Continuous RMS power output (reference):

70 + 70 W
(4 ohms at 1 kHz, 10% THD)

Total harmonic distortion less than 0.9% (4 ohms at 1 kHz, 35 W)

European model:

DIN power output (rated): 55 + 55 W
(4 ohms at 1 kHz, DIN)

Continuous RMS power output (reference):
70 + 70 W
(4 ohms at 1 kHz, 10% THD)

Other models:

The following measured at 220 – 240 V AC, 50/60 Hz

DIN power output (rated): 55 + 55 W
(4 ohms at 1 kHz, DIN)

Continuous RMS power output (reference):
70 + 70 W
(4 ohms at 1 kHz, 10% THD)

Inputs

MD (VIDEO) IN (phono jacks):

Sensitivity 450/250 mV,
impedance 47 kilohms

Outputs

CD DIGITAL OUT:

Optical Wavelength:
660 nm

PHONES:

accepts headphones with
an impedance of 8 ohms or
more

SPEAKER:

accepts impedance of
4 ohms

CD player section

Laser	Semiconductor laser (CD: $\lambda=780$ nm) Emission duration: continuous
Frequency response	CD: 2 Hz – 20 kHz
Wavelength	780 – 790 nm

Tape deck section

Recording system	4-track 2-channel stereo
Frequency response	50 – 13,000 Hz (± 3 dB), using Sony TYPE I cassettes
Wow and flutter	$\pm 0.15\%$ W. Peak (IEC) 0.1% W. RMS (NAB) $\pm 0.2\%$ W. Peak (DIN)

Tuner section

FM stereo, FM/AM superheterodyne tuner

FM tuner section

Tuning range	
North American model:	87.5 – 108.0 MHz (100 kHz step)
Other models:	87.5 – 108.0 MHz (50 kHz step)
Antenna	FM wire antenna
Antenna terminals	75 ohms unbalanced
Intermediate frequency	10.7 MHz

AM tuner section

Tuning range	
Pan-American model:	530 – 1,710 kHz (with the tuning interval set at 10 kHz)
European model:	531 – 1,602 kHz (with the tuning interval set at 9 kHz)
Other models:	530 – 1,710 kHz (with the tuning interval set at 10 kHz) 531 – 1,602 kHz (with the tuning interval set at 9 kHz)
Antenna	AM loop antenna, external antenna terminal
Intermediate frequency	450 kHz

Speaker (SS-CPX1)

Speaker system	2-way, bass-reflex type
Speaker units	
Woofer:	13 cm dia., cone type
Tweeter:	2.5 cm dia., Balanced- Dome-type
Nominal impedance	4 ohms

General

Power requirements	
North American model:	120 V AC, 60 Hz
European model:	230 V AC, 50/60 Hz
Australian model:	230 – 240 V AC, 50/60 Hz
Other models:	220 – 240 V AC, 50/60 Hz
Power consumption	
European model:	50 W 0.3 W (in Power Saving mode)
Other models:	50 W
Dimensions (w/h/d) incl. projecting parts and controls	
Amplifier/Tuner/Tape/CD section:	Approx. 174 × 240.5 × 291 mm
Speakers:	Approx. 160 × 240 × 240 mm

Mass

Amplifier/Tuner/Tape/CD section:

	Approx. 4.3 kg
Speakers:	Approx. 3.1 kg net per speaker
Supplied accessories	Remote (1) R6 (size AA) batteries (2) AM loop antenna (1) FM lead antenna (1) Speaker pads (8)

Design and specifications are subject to change
without notice.

Remote control

ALPHABETICAL ORDER

A - E

- CD **22** (6)
- CLEAR **20** (7)
- CLOCK/TIMER SELECT **2** (14)
- CLOCK/TIMER SET **3** (5, 14)
- DISPLAY **6** (10, 16)
- ENTER **13** (5, 8, 14)
- EQ **16** (13)
- EQ + **15** (13)
- EQ - **19** (13)

F - Z

- FUNCTION **25** (6, 11, 12, 18)
- PLAY MODE **21** (6)
- REPEAT **12** (7)
- SLEEP **1** (13)
- TAPE **24** (11)
- TUNER/BAND **23** (8)
- TUNER MEMORY **5** (8)
- TUNING MODE **21** (8)
- TUNING +/- **9** (8)
- VOL +/- **18** (14)

BUTTON DESCRIPTIONS

- I/⏻ (power) **4** (5, 14)
- TAPE ◀▶ (play) **7** (11, 12)
- TAPE ■ (stop) **8** (11, 12)
- CD ▶|| (play pause) **10** (6)
- CD ■ (stop) **11** (6)
- ◀◀/▶▶ (go back/go forward) **14** (5, 6, 14)
- ◀◀/▶▶ (rewind/fast forward) **17** (6, 11)

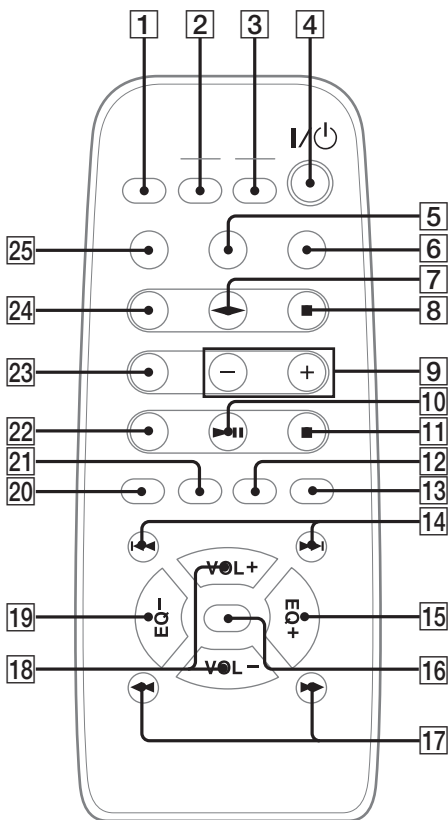

Free Manuals Download Website

<http://myh66.com>

<http://usermanuals.us>

<http://www.somanuals.com>

<http://www.4manuals.cc>

<http://www.manual-lib.com>

<http://www.404manual.com>

<http://www.luxmanual.com>

<http://aubethermostatmanual.com>

Golf course search by state

<http://golfingnear.com>

Email search by domain

<http://emailbydomain.com>

Auto manuals search

<http://auto.somanuals.com>

TV manuals search

<http://tv.somanuals.com>