

PERSONAL AUDIO SYSTEM

Operating Instructions

Getting Started

Basic Operations

Bluetooth

Tuner

Sound Adjustment

Other Operations

Additional Information

WARNING

To reduce the risk of fire or electric shock, do not expose this apparatus to rain or moisture.

To reduce the risk of fire, do not cover the ventilation opening of the appliance with newspapers, tablecloths, curtains, etc.

Do not expose the appliance to naked flame sources (for example, lighted candles).

To reduce the risk of fire or electric shock, do not expose this appliance to dripping or splashing, and do not place objects filled with liquids, such as vases, on the appliance.

As the main plug is used to disconnect the unit from the mains, connect the unit to an easily accessible AC outlet. Should you notice an abnormality in the unit, disconnect the main plug from the AC outlet immediately.

Do not install the appliance in a confined space, such as a bookcase or built-in cabinet.

Do not expose batteries or appliances with battery-installed to excessive heat, such as sunshine and fire.

The unit is not disconnected from the mains as long as it is connected to the AC outlet, even if the unit itself has been turned off.

This equipment has been tested and found to comply with the limits set out in the EMC Directive using a connection cable shorter than 3 meters.

For customer in the United States

Owner's Record

The model and serial numbers are located on the rear of the unit. Record these numbers in the space provided below. Refer to them whenever you call upon your Sony dealer regarding this product.

Model No. _____

Serial No. _____



This symbol is intended to alert the user to the presence of uninsulated "dangerous voltage" within the product's enclosure that may be of sufficient magnitude to constitute a risk of electric shock to persons.



This symbol is intended to alert the user to the presence of important operating and maintenance (servicing) instructions in the literature accompanying the appliance.

Important Safety Instructions

- 1) Read these instructions.
- 2) Keep these instructions.
- 3) Heed all warnings.
- 4) Follow all instructions.
- 5) Do not use this apparatus near water.
- 6) Clean only with dry cloth.
- 7) Do not block any ventilation openings. Install in accordance with the manufacturer's instructions.
- 8) Do not install near any heat sources such as radiators, heat registers, stoves, or other apparatus (including amplifiers) that produce heat.

- 9) Do not defeat the safety purpose of the polarized or grounding-type plug. A polarized plug has two blades with one wider than the other. A grounding type plug has two blades and a third grounding prong. The wide blade or the third prong are provided for your safety. If the provided plug does not fit into your outlet, consult an electrician for replacement of the obsolete outlet.
- 10) Protect the power cord from being walked on or pinched particularly at plugs, convenience receptacles, and the point where they exit from the apparatus.
- 11) Only use attachments/accessories specified by the manufacturer.
- 12) Use only with the cart, stand, tripod, bracket, or table specified by the manufacturer, or sold with the apparatus. When a cart is used, use caution when moving the cart/apparatus combination to avoid injury from tip-over.



- 13) Unplug this apparatus during lightning storms or when unused for long periods of time.
- 14) Refer all servicing to qualified service personnel. Servicing is required when the apparatus has been damaged in any way, such as power-supply cord or plug is damaged, liquid has been spilled or objects have fallen into the apparatus, the apparatus has been exposed to rain or moisture, does not operate normally, or has been dropped.

The following FCC statement applies only to the version of this model manufactured for sale in the U.S.A. Other versions may not comply with FCC technical regulations.

NOTE:

This equipment has been tested and found to comply with the limits for a Class B digital device, pursuant to Part 15 of the FCC Rules. These limits are designed to provide reasonable protection against harmful interference in a residential installation. This equipment generates, uses and can radiate radio frequency energy and, if not installed and used in accordance with the instructions, may cause harmful interference to radio communications. However, there is no guarantee that interference will not occur in a particular installation. If this equipment does cause harmful interference to radio or television reception, which can be determined by turning the equipment off and on, the user is encouraged to try to correct the interference by one or more of the following measures:

- Reorient or relocate the receiving antenna.
- Increase the separation between the equipment and receiver.
- Connect the equipment into an outlet on a circuit different from that to which the receiver is connected.
- Consult the dealer or an experienced radio/TV technician for help.

CAUTION

You are cautioned that any changes or modifications not expressly approved in this manual could void your authority to operate this equipment.

Properly shielded and grounded cables and connectors must be used for connection to host computers and/or peripherals in order to meet FCC emission limits.

Personal Audio System (FST-GTK37iP/FST-GTK17iP/ RDH-GTK37iP/RDH-GTK17iP)

This equipment must not be co-located or operated in conjunction with any other antenna or transmitter.

This equipment complies with FCC radiation exposure limits set forth for an uncontrolled environment and meets the FCC radio frequency (RF) Exposure Guidelines in Supplement C to OET65. This equipment has very low levels of RF energy that it deemed to comply without maximum permissive exposure evaluation (MPE). But it is desirable that it should be installed and operated keeping the radiator at least 20 cm or more away from person's body (excluding extremities: hands, wrists, feet and ankles).

For customers in Europe



Disposal of Old Electrical & Electronic Equipment (Applicable in the European Union and other European countries with separate collection systems)

This symbol on the product or on its packaging indicates that this product shall not be treated as household waste. Instead it shall be handed over to the applicable collection point for the recycling of electrical and electronic equipment. By ensuring this product is disposed of correctly, you will help prevent potential negative consequences for the environment and human health, which could otherwise be caused by inappropriate waste handling of this product. The recycling of materials will help to conserve natural resources. For more detailed information about recycling of this product, please contact your local Civic Office, your household waste disposal service or the shop where you purchased the product.



Disposal of waste batteries (applicable in the European Union and other European countries with separate collection systems)

This symbol on the battery or on the packaging indicates that the battery provided with this product shall not be treated as household waste.

On certain batteries this symbol might be used in combination with a chemical symbol. The chemical symbols for mercury (Hg) or lead (Pb) are added if the battery contains more than 0.0005% mercury or 0.004% lead.

By ensuring these batteries are disposed of correctly, you will help prevent potentially negative consequences for the environment and human health which could otherwise be caused by inappropriate waste handling of the battery. The recycling of the materials will help to conserve natural resources.

In case of products that for safety, performance or data integrity reasons require a permanent connection with an incorporated battery, this battery should be replaced by qualified service staff only.

To ensure that the battery will be treated properly, hand over the product at end-of-life to the applicable collection point for the recycling of electrical and electronic equipment.

For all other batteries, please view the section on how to remove the battery from the product safely. Hand the battery over to the applicable collection point for the recycling of waste batteries.

For more detailed information about recycling of this product or battery, please contact your local Civic Office, your household waste disposal service or the shop where you purchased the product.

Notice for customers: The following information is only applicable to equipment sold in countries applying EU Directives.

This product has been manufactured by or on behalf of Sony Corporation, 1-7-1 Konan Minato-ku Tokyo, 108-0075 Japan. Inquiries related to product compliance based on European Union legislation shall be addressed to the authorized representative, Sony Deutschland GmbH, Hedelfinger Strasse 61, 70327 Stuttgart, Germany. For any service or guarantee matters, please refer to the addresses provided in the separate service or guarantee documents.

Hereby, Sony Corp., declares that this equipment is in compliance with the essential requirements and other relevant provisions of Directive 1999/5/EC. For details, please access the following URL:

<http://www.compliance.sony.de/>



For customers in Australia



Disposal of Old Electrical & Electronic Equipment (Applicable in the European Union and other European countries with separate collection systems)

License and Trademark Notice

- iPhone, iPod, iPod classic, iPod nano, and iPod touch are trademarks of Apple Inc., registered in the U.S. and other countries. Lightning is a trademark of Apple Inc.
- “Made for iPod” and “Made for iPhone” mean that an electronic accessory has been designed to connect specifically to iPod or iPhone, respectively, and has been certified by the developer to meet Apple performance standards. Apple is not responsible for the operation of this device or its compliance with safety and regulatory standards. Please note that the use of this accessory with iPod or iPhone may affect wireless performance.
- The *Bluetooth*® word mark and logos are registered trademarks owned by Bluetooth SIG, Inc. and any use of such marks by Sony Corporation is under license. Other trademarks and trade names are those of their respective owners.
- The N Mark is a trademark or registered trademark of NFC Forum, Inc. in the United States and in other countries.
- Android is a trademark of Google Inc.
- MPEG Layer-3 audio coding technology and patents licensed from Fraunhofer IIS and Thomson.
- Windows Media is either a registered trademark or trademark of Microsoft Corporation in the United States and/or other countries.
- This product is protected by certain intellectual property rights of Microsoft Corporation. Use or distribution of such technology outside of this product is prohibited without a license from Microsoft or an authorized Microsoft subsidiary.

- All other trademarks and registered trademarks are of their respective holders. In this manual, ™ and ® marks are not specified.

Table of Contents

Guide to parts and controls	8
-----------------------------------	---

Getting Started

Hooking up the system securely	11
Using the iPod/iPhone	12
Setting the clock	13

Basic Operations

Playing the iPod/iPhone.....	14
Playing a USB device	15

Bluetooth

About the <i>Bluetooth</i> wireless technology	16
Listening to music wirelessly on a <i>Bluetooth</i> device	16
Setting the <i>Bluetooth</i> audio codecs	19
Setting/Canceling <i>Bluetooth</i> standby mode	19

Tuner

Listening to the radio	20
------------------------------	----

Sound Adjustment

Adjusting the sound	21
Creating a party atmosphere (DJ EFFECT).....	21
Selecting the vertical sound effect	22

Other Operations

Setting the light illumination	22
Using the timers	22
Changing the display	23
Using optional equipment.....	24
Deactivating the buttons on the unit (Child Lock)	24
Setting/Canceling the automatic standby function.....	24

Additional Information

Websites for compatible devices	25
Troubleshooting	25
Messages	29
Precautions.....	29
Specifications.....	31

Guide to parts and controls

This manual mainly explains operations using the remote control, but the same operations can also be performed using the buttons on the unit having the same or similar names.

Unit

– Top view

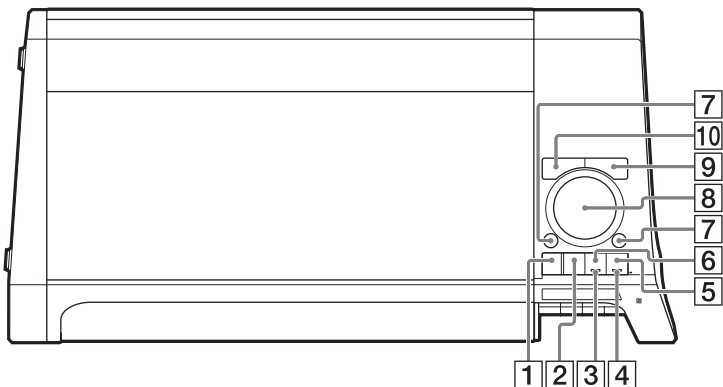

– Front view

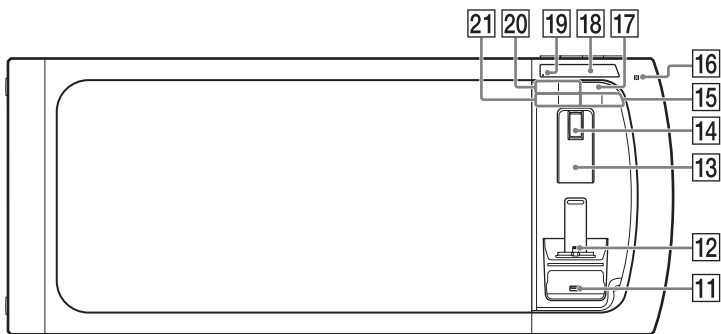

Remote control RM-AMU166

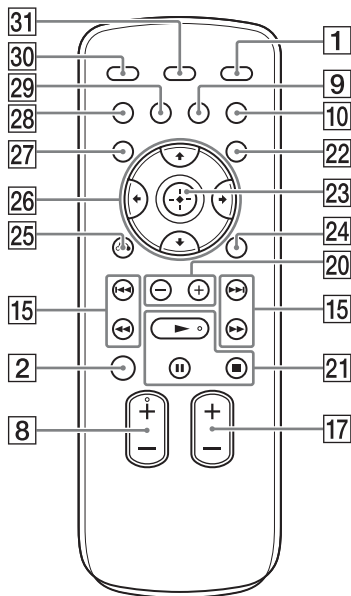

1 I/⏻ (on/standby)

Turn on the system, or set it to standby mode.

2 LED SPEAKER (page 22)

Change the light illumination.

3 VERTICAL SOUND indicator

Lights up when vertical sound effect is turned on.

4 BLUETOOTH indicator (page 16)

Show the *Bluetooth* status of the system.

5 BLUETOOTH (page 16, 18)

Press to select *Bluetooth* function. Hold down to activate *Bluetooth* pairing during *Bluetooth* function.

6 VERTICAL SOUND (page 22)

Select the vertical sound effect.

7 FLANGER, ISOLATOR (page 21)

Select the DJ EFFECT type.

8 Unit: VOLUME/ DJ CONTROL +/-

Adjust the volume.

Adjust the DJ EFFECT level (page 21).

You cannot use this knob to adjust the volume when the DJ EFFECT is activated.

Remote control: VOLUME +/-

Adjust the volume.

9 BASS BAZUCA (page 21)

Select the BASS BAZUCA effect.

10 EQ (page 21)

Select the preset sound effect.

11 ⚡ (USB) port (page 13, 14, 15)

Connect an optional iPod/iPhone or USB device.

12 Terminal for Apple Device (page 12, 14)

13 Holding arm (page 12)

14 PUSH button (page 12)

15 ⏮/⏭ (rewind/fast forward)

Hold down to find a point in a track or file during playback.

Unit: ⏮/⏭ (go back/go forward)





Remote control: ⏮/⏭ (go back/go forward)

Select a track or file.

Unit: TUNING +/-

Remote control: +/- (tuning)

Tune to the station you want.

- 16**  **(N-Mark) (page 18)**
Near Field Communication (NFC) touchpoint indication.
- 17** **Unit: FUNCTION**
Remote control: FUNCTION +/-
Select a function.
- 18** **Display panel**
- 19** **Remote control sensor**
- 20**  **+/- (select folder)**
Select a folder on a USB device.
- 21** **Unit: ►|| (play/pause)**
**Remote control: ►* (play),
|| (pause)**
Start or pause playback.
To resume playback of the USB device, press ►|| or ►.
- (stop)**
Stop playback.
Press twice to cancel resume playback of the USB device.
- 22** **TIMER MENU (page 13, 23)**
Set the clock and the timers.
- 23**  **(+)**
Enter the settings.
- 24** **OPTIONS**
Enter or exit options menu.
- 25** **RETURN** 
Return to previous selection.
- 26** 
Select the options menu or timer menu items.
- 27** **TUNER MEMORY (page 21)**
Preset the radio station.
- 28** **PLAY MODE/TUNING MODE**
Select the play mode of a USB device (page 15).
Select the tuning mode (page 20).

- 29** **REPEAT/FM MODE**
Listen to a USB device, a single track or file repeatedly (page 15).
Select the FM reception mode (monaural or stereo) (page 20).
- 30** **SLEEP (page 22)**
Set the Sleep Timer.
- 31** **DISPLAY**
Change the information on the display panel.

* The VOLUME + and ► buttons have a tactile dot. Use the tactile dot as a reference when operating the system.

Hooking up the system securely

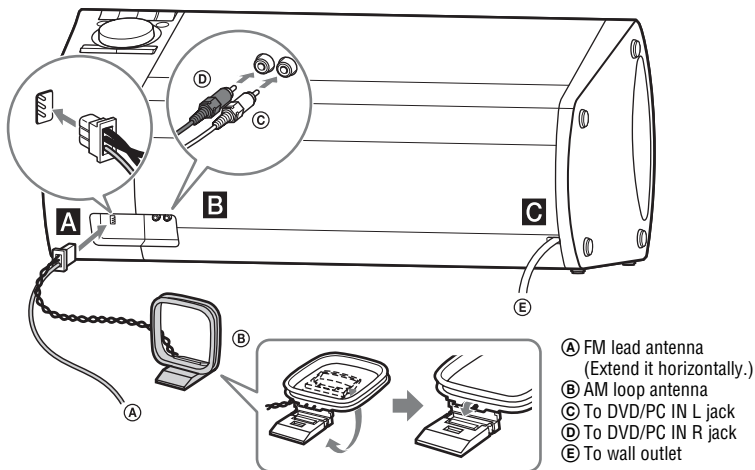

A Antennas

Find a location and an orientation that provide good reception when you set up the antennas.

Keep the antennas away from the power cord and the USB cable to avoid picking up noise.

B DVD/PC IN L/R jacks

Use an audio cord (not supplied) to connect to the audio output jacks of an audio/video equipment. The sound is output through this system.

C Power

Plug the power cord into a wall socket. The demonstration appears in the display panel. Press  to turn on the system and the demonstration automatically ends. If the supplied adaptor on the plug does not fit your wall outlet, detach it from the plug (only for models equipped with an adaptor).

Inserting batteries

Insert the two supplied R6 (size AA) batteries, matching the polarities shown below.

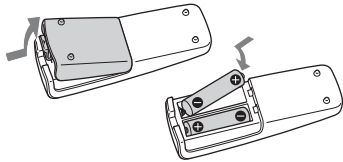

Notes

- Do not mix an old battery with a new one or mix different types of batteries.
- If you do not use the remote control for a long period of time, remove the batteries to avoid damage from battery leakage and corrosion.

Installing the system

The system can be installed either vertically or horizontally. Select the installation style based on your preferences.

Notes

- Install the system horizontally when connecting iPod nano model to the Terminal for Apple Device.
- Be sure to select the vertical sound effect when the system is installed vertically (page 22).

– Vertical installation

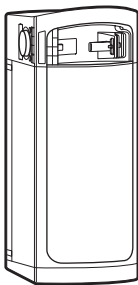

– Horizontal installation

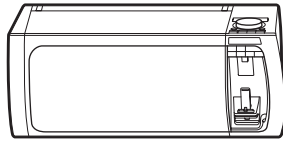

Using the iPod/iPhone

When connecting to the Terminal for Apple Device

You can connect the models as follows to the Terminal for Apple Device.

- iPod touch 5th generation
- iPod nano 7th generation
- iPhone 5

To prevent the iPod/iPhone from falling, always secure the iPod/iPhone with the holding arm when connecting to the Terminal for Apple Device. When removing the iPod/iPhone, lift up the holding arm until it clicks and snaps into position, and then disconnect the iPod/iPhone from the Terminal for Apple Device.

- 1 Place the iPod/iPhone onto the Terminal for Apple Device.**
- 2 Press the PUSH button until the holding arm is released.**

The holding arm flips out to secure the iPod/iPhone.

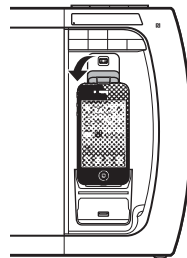

Note for iPod nano model users

Do not install the system vertically when using iPod nano models with this system. iPod nano models cannot be secured with the holding arm because of their height. Install the system horizontally.

Note on carrying the system

Do not carry the system with the iPod/iPhone connected. Otherwise, the iPod/iPhone may fall and be damaged. Sony cannot accept responsibility for any damage caused by inappropriate usage.

Notes





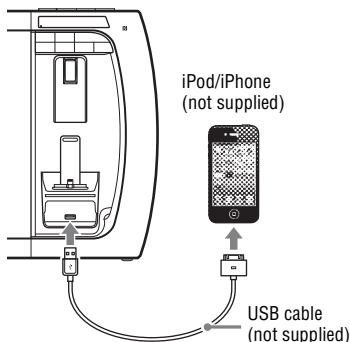

- When using commercially available iPod/iPhone cases, the connected iPod/iPhone may not be recognized by the system. If this happens, remove the case from the iPod/iPhone and reconnect it to the Terminal for Apple Device.
- When using a vertically installed system, make sure that the connected iPod/iPhone remains upright, not tilted.

When connecting to the  port

Connect the iPod/iPhone to the  port using USB cable supplied with your iPod/iPhone.

**Setting the clock**

You cannot set the clock in Power Saving Mode.

- 1 Press I/⏻ to turn on the system.**
- 2 Press TIMER MENU.**
If "PLAY SET" appears in the display panel, press  repeatedly to select "CLOCK", then press .
- 3 Press  repeatedly to set the hour, then press .**
- 4 Press  repeatedly to set the minutes, then press .**

Basic Operations

Playing the iPod/iPhone

■ When connecting to the Terminal for Apple Device

- 1 Press FUNCTION +/- repeatedly to select the iPod function.
- 2 Place the iPod/iPhone onto the Terminal for Apple Device.
- 3 Press the PUSH button and secure the iPod/iPhone.
- 4 Press ►.

■ When connecting to the ⚡ port

- 1 Press FUNCTION +/- repeatedly to select USB function.
- 2 Connect an iPod/iPhone to the ⚡ port.
- 3 Press ►.

To control the iPod/iPhone

To	Do this
Pause playback	Press II/■.
Select a track or chapter of audiobook/podcast	Press ◀◀/▶▶. To fast-forward or fast-rewind, hold down the button.
Find a point in a track or chapter of audiobook/podcast	Hold down ◀◀/▶▶ during playback, and release it at the point you want.

To use the system as a battery charger

You can use the system as a battery charger for an iPod/iPhone whether the system is on or off.

The charging begins when the iPod/iPhone is placed on the Terminal for Apple Device or connected to the ⚡ port. The charging status appears on the iPod/iPhone display.

For details, refer to the operating instructions of your iPod/iPhone.

To stop charging an iPod/iPhone

Remove the iPod/iPhone.

Notes on charging an iPod/iPhone

- The iPod/iPhone cannot be charged when it is connected while the system is off.
- When the iPod/iPhone is connected to Terminal for Apple Device, press FUNCTION +/- to select iPod, TUNER or DVD/PC function.
- When the iPod/iPhone is connected to ⚡ port, press FUNCTION +/- to select USB or BT AUDIO function.

Notes

- Do not touch the Terminal for Apple Device.
- The performance of the system may vary, depending on the specifications of your iPod/iPhone.
- When placing or removing the iPod/iPhone – handle the iPod/iPhone in the same angle as that of the Terminal for Apple Device on the unit and do not twist or sway the iPod/iPhone to prevent terminal damage.
 - brace the unit with one hand and take care not to press the controls of the iPod/iPhone by mistake.
- Before disconnecting the iPod/iPhone, pause playback.
- Hold down ◀◀/▶▶ to fast-rewind (or fast-forward) while playing video if ◀◀/▶▶ does not function.
- To change the volume level, use VOLUME +/- . The volume level does not change if you adjust it on the iPod/iPhone.
- This system is designed for iPod/iPhone with 8-pin Lightning connector only. You cannot connect any other devices to the Terminal for Apple Device.
- To use an iPod/iPhone, refer to the operating instructions of your iPod/iPhone.

- Sony cannot accept responsibility in the event that data recorded to iPod/iPhone is lost or damaged when using an iPod/iPhone with this system.

Playing a USB device

The audio formats that can be played back by this system are as follows:

- MP3: file extension “.mp3”
- WMA: file extension “.wma”
- AAC: file extension “.m4a”, “.mp4” or “.3gp”
- WAV: file extension “.wav”

If the audio files have the above file extension but are not the respective formats, the system may produce noise or may malfunction.

Check the websites for the information about compatible USB devices (page 25).

1 Press **FUNCTION +/-** to select **USB function**.

2 Connect a USB device to the **↔** port.

3 Press **▶**.

To change the play mode

Press **PLAY MODE** repeatedly.

- Normal Play (blank): playback in sequence of all audio files on the USB device
- Folder Play (“FLDR”¹⁾): playback all audio files in the specified folder on the USB device
- Shuffle Play (“SHUF”²⁾³⁾): playback in random order of all audio file on the USB device

¹⁾ You cannot select Folder Play and “**↔ 1**” at the same time.

²⁾ You cannot select Shuffle Play and Repeat Play at the same time.

³⁾ When you turn off the system, the selected Shuffle Play is cleared and the play mode returns to Normal Play.

To select Repeat Play

Press **REPEAT** repeatedly.

- **↔**: repeat all audio files on a USB device or in the folder
- **↔ 1**: repeat an audio file

Notes on the USB device

- The playback order for the system may differ from the playback order of the connected digital music player.
- Be sure to turn off the system before removing the USB device. Removing the USB device while the system is turned on may corrupt the data on the USB device.
- Compatibility with all encoding/writing software cannot be guaranteed. If audio files on the USB device were originally encoded with incompatible software, those files may produce noise or interrupted sound, or may not be played back at all.
- This system can recognize up to
 - 256 audio files in a folder.
 - 65,536 audio files in a USB device.
 - 256 folders in a USB device.

To use the system as a battery charger

You can use the system as a battery charger for USB devices that have a rechargeable function when the system is on.

Press **FUNCTION +/-** repeatedly to select the USB function.

The charging begins when the USB device is connected to the **↔** port. The charge status appears on the display panel of the USB device. For details, refer to the operating instructions of your USB device.

About the *Bluetooth* wireless technology

Bluetooth wireless technology is a short-range wireless technology that enables wireless data communication between digital devices. *Bluetooth* wireless technology operates within a range of about 10 meters (33 feet).

Supported *Bluetooth* version, profiles and codecs

Supported *Bluetooth* version:

- *Bluetooth* Standard version 3.0 + EDR (Enhanced Data Rate)

Supported *Bluetooth* profiles:

- A2DP (Advanced Audio Distribution Profile)
- AVRCP 1.3 (Audio Video Remote Control Profile)

Supported *Bluetooth* codecs:

- SBC (Sub Band Codec)
- AAC (Advanced Audio Coding)

Listening to music wirelessly on a *Bluetooth* device

You can listen to music from your *Bluetooth* device over a wireless connection.

Check the websites for the information about compatible *Bluetooth* devices (page 25).

About the BLUETOOTH indicator

The BLUETOOTH indicator lights up or flashes in blue to show the *Bluetooth* status.

System status	Indicator status
<i>Bluetooth</i> standby	Flashes slowly
<i>Bluetooth</i> pairing	Flashes quickly
<i>Bluetooth</i> connecting	Flashes
<i>Bluetooth</i> connection is established	Lights up

Pairing this system with a *Bluetooth* device

Pairing is an operation where *Bluetooth* devices register with each other beforehand. Once a pairing operation is performed, it does not need to be performed again. If your device is an NFC-compatible smartphone, the manual pairing procedure is not necessary.

1 Place the *Bluetooth* device within 1 meter (3 feet) from the system.

2 Press BLUETOOTH on the unit to select *Bluetooth* function.

“BT AUDIO” appears in the display panel.

Note

If the system is connected to a *Bluetooth* device, press BLUETOOTH to disconnect the *Bluetooth* device.

3 Hold down BLUETOOTH on the unit for 2 seconds or more.

“PAIRING” flashes in the display panel.

4 Perform the pairing procedure on the *Bluetooth* device.

For details, refer to the operating instructions of your *Bluetooth* device.

5 Select the model number of the unit on the display of the *Bluetooth* device.

For example, select “SONY FST-GTK37iP” (or FST-GTK17iP/RDH-GTK37iP/RDH-GTK17iP).

If passkey is required on the *Bluetooth* device, enter “0000”.

6 Perform the *Bluetooth* connection on the *Bluetooth* device.

When pairing is completed and the *Bluetooth* connection is established, *Bluetooth* device name appears in the display panel.

Depending on the *Bluetooth* device, connection may start automatically after pairing is completed.

You can check the *Bluetooth* device address by pressing DISPLAY repeatedly.

Notes

- You can pair up to 9 *Bluetooth* devices. If the 10th *Bluetooth* device is paired, the least recently connected device will be replaced by the new one.
- “Passkey” may be called “Passcode”, “PIN code”, “PIN number” or “Password”, etc., depending on the device.
- The pairing standby status of the system is canceled after about 5 minutes. If pairing is not successful, repeat from step 1.
- While connected to a *Bluetooth* device, this system cannot be detected and connection cannot be established from another *Bluetooth* device which is never paired before.
- If you want to pair with another *Bluetooth* device, repeat steps 1 to 6.

To cancel pairing operation

Hold down BLUETOOTH on the unit for 2 seconds or more until “BT AUDIO” appears in the display panel.

Connecting with a smartphone by one touch (NFC)

By touching the system with an NFC-compatible smartphone, the system is turned on in *Bluetooth* function automatically, and then proceeds to complete pairing and the *Bluetooth* connection automatically.

What is “NFC”?

NFC (Near Field Communication) is a technology enabling short-range wireless communication between various devices, such as mobile phones and IC tags. Thanks to the NFC function, data communication can be achieved easily just by touching the designated touchpoint on the NFC-compatible devices.

1 Download and install the app “NFC Easy Connect”.

Download the free Android app from Google Play by searching for “NFC Easy Connect” or access it by using the two-dimensional code below. Data communication fees may be charged.

Two-dimensional code* for direct access

* Use a two-dimensional code reader app.



Notes

- The app may not be available in some countries/regions.
- Depending on your smartphone, you can use the NFC function without installing the app. In this case, the operations and specifications may be different. For details, refer to the operating instructions of your smartphone.

Compatible smartphones

Smartphones with a built-in NFC function (OS: Android 2.3.3 or later, excluding Android 3.x)

2 Start the app “NFC Easy Connect” on the smartphone.

Make sure that the application screen is displayed.

3 Touch the smartphone to the N-Mark on the system until the smartphone vibrates.

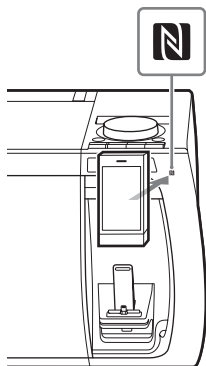

Complete the connection by following the instructions displayed on the smartphone.

When the *Bluetooth* connection is established, the BLUETOOTH indicator stops flashing and remains light up. *Bluetooth* device name appears in the display panel.

You can switch the sound source from the smartphone to another NFC-compatible *Bluetooth* device.

For details, refer to the operating instructions of your *Bluetooth* device.

Tip

If pairing and the *Bluetooth* connection fail, do the following.

- Relaunch “NFC Easy Connect” and move the smartphone slowly over the N-Mark.

- Remove the case from the smartphone if using a commercially available smartphone case.

Playing music from a *Bluetooth* device

You can operate a *Bluetooth* device by connecting the system and a *Bluetooth* device using AVRCP.

Check the following before playing music:

- The *Bluetooth* function of the *Bluetooth* device is turned on.
- Pairing has been completed.

■ For a *Bluetooth* device

1 Press BLUETOOTH on the unit to select *Bluetooth* function.

“BT AUDIO” appears in the display panel.

2 Establish connection with the *Bluetooth* device.

The last connected *Bluetooth* device will be connected automatically.

Perform the *Bluetooth* connection from the *Bluetooth* device if the device is not connected.

Once the connection is established, the *Bluetooth* device name appears in the display panel.

3 Press ►.

Depending on the *Bluetooth* device,

- you may need to press ► twice.
- you may need to start playback of an audio source on the *Bluetooth* device.

Notes

- When the system is not connected to any *Bluetooth* device, the system will connect and playback from the last connected *Bluetooth* device automatically when you press ►.
- If you try to connect another *Bluetooth* device to the system, the current connected *Bluetooth* device will be disconnected.

■ For an NFC-compatible smartphone

Touch the smartphone to the N-Mark on the system to establish the *Bluetooth* connection.

Start playback of an audio source on the smartphone. For details on playback, refer to the operating instructions of your smartphone.

To disconnect the *Bluetooth* device

■ For a *Bluetooth* device

Press BLUETOOTH on the unit. "BT AUDIO" appears in the display panel.

Depending on the *Bluetooth* device, the *Bluetooth* connection may be canceled automatically when you stop playback.

■ For an NFC-compatible smartphone

Touch the smartphone to the N-Mark on the system again.

Erasing all the pairing registration information

Use the buttons on the unit to perform this operation.

1 Press BLUETOOTH to select *Bluetooth* function.

"BT AUDIO" appears in the display panel.

If the system is connected to a *Bluetooth* device, the *Bluetooth* device name appears in the display panel.

Press BLUETOOTH to disconnect the *Bluetooth* device.

2 When holding down ■, press I/⏻ for about 3 seconds.

"BT HIST" and "CLEAR" appear in the display panel and all the pairing information is erased.

Setting the *Bluetooth* audio codecs

You can select the *Bluetooth* audio codecs when the connected *Bluetooth* device supports Advanced Audio Coding (AAC).

1 Press OPTIONS.

2 Press ↑/↓ repeatedly to select "BT AAC", then press ⊕.

3 Press ↑/↓ repeatedly to select "ON" or "OFF".

- ON: Advanced Audio Coding (AAC) is selected if the *Bluetooth* device supports AAC.
- OFF: Sub Band Codec (SBC) is selected.

Notes

- You can enjoy high quality sound if the AAC is selected. In case you cannot listen to AAC sound from your device, select "OFF".
- If you change this setting while the system is connected to a *Bluetooth* device, the *Bluetooth* device will be disconnected. To connect to the *Bluetooth* device, perform the *Bluetooth* connection again.

Setting/Canceling *Bluetooth* standby mode

The system goes into *Bluetooth* standby mode and waits for a *Bluetooth* connection, even when the system is turned off.

1 Press OPTIONS.

2 Press ↑/↓ repeatedly to select "BT STBY", then press ⊕.

3 Press \uparrow/\downarrow repeatedly to select “ON” or “OFF”.

4 Press I/power to turn off the system.

When *Bluetooth* standby mode is set to on, the system will turn on automatically when you establish the *Bluetooth* connection from the *Bluetooth* device.

Note

The system will not enter *Bluetooth* standby mode if you erase the pairing information.

Tuner

Listening to the radio

1 Press FUNCTION +/- repeatedly to select FM or AM band.

2 For automatic scanning:

Press TUNING MODE repeatedly until “AUTO” lights up in the display panel. Then, press +/-.

Scanning stops automatically when a station is tuned in. Then “TUNED” and “ST” (for FM stereo programs only) light up in the display panel.



If “TUNED” does not light up and scanning does not stop, press \blacksquare to stop scanning. Then, perform manual tuning (below).

When you tune to an FM station that provides RDS services, information such as the service name or station name is provided by broadcasts. You can check the RDS information by pressing DISPLAY repeatedly.

For manual tuning:

Press TUNING MODE repeatedly until “AUTO” and “PRESET” disappear from the display panel.

Then, press +/- repeatedly to tune to the station you want.

Tip

To reduce static noise on a weak FM stereo station, press FM MODE repeatedly until “MONO” lights up in the display panel.

To change the AM tuning interval (except for European, Russian and Saudi Arabian models)

The default setting for AM tuning interval is 9 kHz (or 10 kHz for some areas).

Use the buttons on the unit to perform this operation.

- 1 Press **FUNCTION** repeatedly to select AM band.
- 2 Press **I/⏻** to turn off the system.
- 3 While holding down **TUNING +**, press **I/⏻**.
“9K STEP” or “10K STEP” appears in the display panel.
When you change the interval, all the AM preset stations are erased.

Presetting radio stations

You can store up to 20 FM and 10 AM stations as your favorite stations.

- 1 Tune to the station you want.
- 2 Press **TUNER MEMORY**.

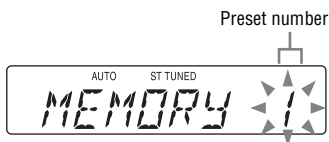

- 3 Press **+/-** repeatedly to select the preset number you want, then press **⊕**.
“COMPLETE” appears in the display panel. The station is stored.

To tune to a preset station

Press **TUNING MODE** repeatedly until “PRESET” lights up in the display panel. Then, press **+/-** repeatedly to select the preset number you want.

Sound Adjustment

Adjusting the sound

To	Do this
Reinforce the bass and create a more powerful sound	Press BASS BAZUCA .
Select a preset sound effect	Press EQ repeatedly. To cancel preset sound effect, press EQ repeatedly to select “FLAT”.

Creating a party atmosphere (DJ EFFECT)

Use the buttons on the unit to perform this operation.

- 1 Press **FLANGER** or **ISOLATOR**.

The selected button lights up and the effect is activated.

- **FLANGER**: Create a deep flanging effect that is similar to the roar of a jet plane.
- **ISOLATOR**: Isolate a specific frequency band by adjusting the other frequency bands. For example, when you want to focus on vocal and etc.

- 2 Turn **DJ CONTROL +/-** to adjust the effect level.

To turn off the effect

Press the selected effect button again.

Notes

- The DJ EFFECT is automatically turned off when you turn off the system or change the function or tuner band.
- You cannot use VOLUME/DJ CONTROL +/- to adjust the volume when the DJ EFFECT is activated. Press VOLUME +/- on the remote control to adjust the volume.

Selecting the vertical sound effect

You can select the sound effect according to the installation style of the system. Turn on the vertical sound effect when the system is installed vertically.

Press VERTICAL SOUND on the unit repeatedly.

Other Operations

Setting the light illumination

You can set a light illumination from a variety of illumination patterns. The light illumination will create lighting effects based on the music source.

Press LED SPEAKER repeatedly.

Each time you press the button, the pattern changes.

To turn off the light illumination

Press LED SPEAKER repeatedly to select "LED OFF".

Using the timers

The system offers 2 timer functions. If you use both timers, the Sleep Timer has priority.

Sleep Timer

You can fall asleep when listening to music. The system turns off after the preset time.

Press SLEEP repeatedly.

To cancel Sleep Timer, press SLEEP repeatedly to select "OFF".

Tip

To check the remaining time before the system turns off, press SLEEP.

Play Timer

You can wake up to tuner, iPod/iPhone or USB device at a preset time. Make sure you have set the clock.

- 1** Prepare the sound source, then press **VOLUME +/-** to adjust the volume.
- 2** Press **TIMER MENU**.
- 3** Press **▲/▼** repeatedly to select “**PLAY SET**”, then press **⊕**.
- 4** Set the time to start playback.
Press **▲/▼** repeatedly to set the hour/minute, then press **⊕**.
- 5** Use the same procedure as in step 4 to set the time to stop playback.
- 6** Press **▲/▼** repeatedly to select the sound source you want, then press **⊕**.
- 7** Press **I/⏻** to turn off the system.

To check the timer setting or activate the timer again

- 1** Press **TIMER MENU**.
“**TIMERSEL**” flashes in the display panel.
- 2** Press **⊕**.
- 3** Press **▲/▼** repeatedly to select “**PLAY SEL**”, then press **⊕**.

To cancel the timer

Repeat the same procedure as above and select “**OFF**” in step 3, and then press **⊕**.

Notes

- The system turns on before the preset time. If the system is turned on at the preset time or if “**STANDBY**” flashes in the display panel, the Play Timer will not play.
- Do not operate the system from the time the system turns on until the playback starts.

Notes for the iPod/iPhone user

- Make sure the iPod/iPhone is not playing when using the Play Timer.
- The Play Timer may not be activated depending on the status of the connected iPod/iPhone.

Changing the display

Changing the display mode

Press **DISPLAY** repeatedly while the system is turned off.

Demonstration

The display changes and the indicator flashes even when the system is turned off.

No display (Power Saving Mode)

The display is turned off to conserve power. The timer and clock continue to operate.

Or,

iPod/iPhone Charging Mode

“**CHARGING**” appears and the system continues to charge the iPod/iPhone.

Clock

The clock display automatically turns to Power Saving Mode after 8 seconds.

Viewing information in the display panel

Press **DISPLAY** repeatedly during **USB** function when the system is turned on.

You can view the information as follows:

- The elapsed playing time, file name and folder name.
- The title, artist and album information.

Notes

- Total playing time for a USB device is not displayed.
- The following are not displayed correctly:
 - elapsed playing time of an MP3 file encoded using VBR (variable bit rate).
 - folder and file names that do not follow either the ISO9660 Level 1, Level 2 or Joliet in the expansion format.
- ID3 tag information for MP3 files is displayed when ID3 version 1 and version 2 tags are used (ID3 version 2 tag information display has priority when both ID3 version 1 and version 2 tags are used for a single MP3 file).

Using optional equipment

- 1** Press **VOLUME** – repeatedly until “VOL MIN” appears in the display panel.
- 2** Connect an optional equipment (page 11).
- 3** Press **FUNCTION +/-** repeatedly to select the DVD/PC function.
- 4** Start playing the connected equipment.
- 5** Press **VOLUME +** repeatedly to adjust the volume.

Note

The system may enter standby mode automatically if the volume level of the connected equipment is too low. Adjust the volume level of the equipment. To turn off automatic standby function, see “Setting/Canceling the automatic standby function” (page 24).

Deactivating the buttons on the unit

(Child Lock)

You can deactivate the buttons on the unit (except **I/⏻**) for preventing misoperation, such as child mischief.

Hold down **■** on the unit for more than 5 seconds.

“CHILD” and “LOCK ON” appear in the display panel.

You can only operate the system using the buttons on the remote control.

To cancel, hold down **■** on the unit for more than 5 seconds until “CHILD” and “LOCK OFF” appear in the display panel.

Note

Child Lock function will be canceled when you disconnect the power cord.

Setting/Canceling the automatic standby function

This system is equipped with an automatic standby function. With this function, the system enters standby mode automatically in about 30 minutes when there is no operation or audio signal output.

By default, the automatic standby function is turned on.

- 1** Press **OPTIONS**.
- 2** Press **↑/↓** repeatedly to select “AutoSTBY”, then press **⊕**.
- 3** Press **↑/↓** repeatedly to select “ON” or “OFF”.

Notes

- The message “AutoSTBY” flashes in the display about 2 minutes before entering standby mode.
- The automatic standby function does not work during tuner function.
- The system may not enter standby mode automatically in the following cases:
 - when an audio signal is detected.
 - during playback of audio files.
 - while the preset Play Timer or Sleep Timer is in process.

Additional Information

Websites for compatible devices

Check the websites below for the latest information about compatible USB and *Bluetooth* devices.

For customers in Latin America:

<<http://esupport.sony.com/LA>>

For customers in the United States:

<<http://www.esupport.sony.com/>>

For customers in Europe and Russia:

<<http://support.sony-europe.com/>>

For customers in other countries/regions:

<<http://www.sony-asia.com/support>>

Troubleshooting

Should you encounter a problem with your system, find your problem in the troubleshooting checklist below and take the corrective action.

If the problem persists, consult your nearest Sony dealer.

Note that if the service personnel changes some parts during repair, these parts may be retained.

If “PROTECT” and “EXX” (X is a number) appear in the display panel

Immediately unplug the power cord.

- Check if anything is blocking the ventilation holes of the unit.
- Remove the connected USB device and iPod/iPhone. Make sure there is no problem with the USB device and the iPod/iPhone.

After checking the above items and fixing any problems, plug in the power cord again and turn on the system. If the issue persists, consult your nearest Sony dealer.

General

The system has entered standby mode.

- This is not a malfunction. The system enters standby mode automatically in about 30 minutes when there is no operation or audio signal output (page 24).

The clock or timer setting is canceled.

- The power cord is disconnected or a power failure occurred. Set the clock (page 13) and timer (page 22) again.

There is no sound.

- Adjust the volume.
- Check the connection of the optional equipment, if any (page 11).
- Turn on the connected equipment.

There is severe hum or noise.

- Move the system away from sources of noise.
- Connect the system to a different wall outlet.
- Install a noise filter (commercially available) to the power cord.
- Turn off surrounding electrical equipment.

The timer does not function.

- Check the timer setting and set the correct time (page 22).
- Cancel the Sleep Timer function (page 22).

The remote control does not function.

- Remove the obstacles between the remote control and the unit.
- Move the remote control closer to the unit.
- Point the remote control at the unit's sensor.
- Replace the batteries (R6/size AA).
- Move the unit away from the fluorescent light.

“CHILD” and “LOCK” appear when you press any button on the unit.

- Set the Child Lock function to off (page 24).

iPod/iPhone

There is no sound.

- Make sure the iPod/iPhone is connected securely.
- Make sure the iPod/iPhone is playing music.
- Make sure the iPod/iPhone is updated with the latest software.
- Adjust the volume.

The sound is distorted.

- Make sure the iPod/iPhone is connected securely.
- Turn down the volume.
- Set the “EQ” setting of the iPod/iPhone to “Off” or “Flat”.

Unexpected track changes occur during playback.

- Turn off the “Shake to Shuffle” function (changing tracks by shaking the iPod/iPhone) on the iPod/iPhone when listening to music on the iPod/iPhone at high volumes. If this function is enabled, unexpected track changes may occur due to the vibrations caused by sound pressure from the system.

The iPod/iPhone does not function.

- If the battery of the iPod/iPhone is empty, it may not work with this system. In this case, recharge it with a computer, etc. then connect it to the system.
- Quit all running applications on your iPod or iPhone before using it with the system. For details, refer to the operating instructions of your iPod/iPhone.
- Make sure the iPod/iPhone is connected securely.
- Make sure the iPod/iPhone is updated with the latest software.

- You may not be able to operate the iPod/iPhone using buttons on the remote control or unit due to the operation of the system and iPod/iPhone are different. In this case, use the control buttons on the iPod/iPhone.

The iPod/iPhone cannot be charged.

- If the battery of the iPod/iPhone is empty, the system may not be able to charge it even if you connect it to the system. In this case, recharge it with a computer, etc. then connect it to the system.
- Make sure the iPod/iPhone is connected securely.
- Make sure the system is turned on when you connect an iPod/iPhone to the system.

The ring volume of the iPhone does not change.

- Adjust the ring volume on the iPhone.

USB device

There is no sound.

- The USB device is not connected correctly. Turn off the system and reconnect the USB device.

There is noise, skipping, or distorted sound.

- You are using an unsupported USB device. Check the information on the websites about compatible USB devices (page 25).
- Turn off the system and reconnect the USB device.
- The music data itself contains noise, or the sound is distorted. Noise may have been entered when creating music data due to the conditions of the computer. Create the music data again.
- The bit rate used when encoding audio files was low. Send audio files with higher bit rate to the USB device.

“READING” is displayed for an extended time, or it takes a long time before playback starts.

- The reading process can take a long time in the following cases.
 - There are many folders or files on the USB device.
 - The file structure is extremely complex.
 - The memory capacity is excessive.
 - The internal memory is fragmented.

“OVER CURRENT” appears.

- A problem has been detected with the level of electrical current from the  port. Turn off the system and remove the USB device from the port. Make sure there is no problem with the USB device. If this display pattern persists, contact your nearest Sony dealer.

Erroneous display.

- The data stored in the USB device may have been corrupted, send the music data to the USB device again.
- The character codes that can be displayed by this system are numbers and alphabets only. Other characters that cannot be displayed appear as “_”.

The USB device is not recognized.

- Turn off the system and reconnect the USB device, then turn on the system.
- Check the information on the websites about compatible USB devices (page 25).
- The USB device does not work properly. Refer to the operating instructions of your USB device on how to deal with this problem.

Playback does not start.

- Turn off the system and reconnect the USB device, then turn on the system.
- Check the information on the websites about compatible USB devices (page 25).

Playback does not start from the first file.

- Set the play mode to Normal Play (page 15).

Audio file cannot be played back.

- MP3 files in MP3 PRO format cannot be played back.
- Some AAC files may not be played back correctly.
- An AAC file which has video stream cannot be played back.
- WMA files in Windows Media Audio Lossless and Professional format cannot be played back.
- USB device formatted with file systems other than FAT16 or FAT32 are unsupported.*
- If you use a partitioned USB device, only files on the first partition can be played.
- The system can play back to a depth of 8 folders only.
- Files that are encrypted or protected by passwords and etc. cannot be played back.
- Files with DRM (Digital Rights Management) copyright protection cannot be played back by this system.

* This system supports FAT16 and FAT32, but some USB device may not support all of these FAT. For details, refer to the operating instructions of each USB device or contact the manufacturer.

Bluetooth device

Pairing cannot be done.

- Move the *Bluetooth* device closer to the system.
- Pairing may not be possible if other *Bluetooth* devices are present around the system. In this case, turn off the other *Bluetooth* devices.
- Make sure the correct passkey was entered at the *Bluetooth* device.

Connection is not possible.

- The *Bluetooth* device you attempted to connect does not support the A2DP profile, and cannot be connected with the system.
- Enable the *Bluetooth* function of the *Bluetooth* device.
- Establish a connection from the *Bluetooth* device.
- The pairing registration information has been erased. Perform the pairing operation again.
- While connected to a *Bluetooth* device, this system cannot be detected and a connection cannot be established from another *Bluetooth* device which is never paired before.
- Erase the pairing registration information of a *Bluetooth* device and perform the pairing operation again.

The sound skips or fluctuates, or the connection is lost.

- The system and the *Bluetooth* device are too far apart.
- If there are obstacles between the system and your *Bluetooth* device, remove or avoid the obstacles.
- If there is equipment that generates electromagnetic radiation, such as a wireless LAN, other *Bluetooth* device, or a microwave oven nearby, move them away.

The sound of your *Bluetooth* device cannot be heard on this system.

- Increase the volume on your *Bluetooth* device first, and then adjust the volume using VOLUME +/-.

There is severe hum, noise or distorted sound.

- If there are obstacles between the system and your *Bluetooth* device, remove or avoid the obstacles.
- If there is equipment that generates electromagnetic radiation, such as a wireless LAN, other *Bluetooth* device, or a microwave oven nearby, move them away.

- Turn down the volume of the connected *Bluetooth* device.

Tuner

Severe hum or noise, or stations cannot be received. (“TUNED” or “ST” flashes in the display panel.)

- Connect the antenna properly.
- Change antenna location and its orientation to obtain good reception.
- Connect a commercially available external antenna.
- Consult your nearest Sony dealer if the supplied AM antenna has come off from the plastic stand.
- Turn off surrounding electrical equipment.

To reset the system

If the system still does not operate properly, reset the system to factory default settings.

Use the buttons on the unit to perform this operation.

- 1** Unplug and plug the power cord back in.
- 2** Press **I/⏻** to turn on the system.
- 3** While holding down **FUNCTION**, press **I/⏻** for about 3 seconds. “RESET” appears in the display panel. All user-configured settings, such as preset radio stations, timer, and the clock are reset to factory default setting.

Messages

CHARGING: The iPod/iPhone is being charged when the system is off (standby mode).

CHILD LOCK: The child lock function has been enabled.

CONNECT: The iPod/iPhone is connected during iPod function or the system is connecting to the last connected device during *Bluetooth* function.

ERROR: The USB device could not be recognized or an unknown device is connected.

NoDEVICE: No USB device is connected.

NO TRACK: No playable file is loaded in the system.

NOT SUPPORT: An unsupported USB device is connected, the USB device is connected through a USB hub, or the iPod/iPhone whose battery is empty is connected.

PAIRING: The system is in pairing mode.

PUSH STOP: You tried to perform an operation that can be performed only when the playback is stopped.

READING: The system is reading information of the USB device. Some buttons are not available.

TIME NG: The start and stop times for Play Timer are the same.

Precautions

On safety

- Completely disconnect the power cord (mains lead) from the wall outlet (mains) if it is not going to be used for an extended period of time. When unplugging the unit, always grip the plug. Never pull the cord itself.
- Should any solid object or liquid get into the system, unplug the system, and have it checked by qualified personnel before operating it again.
- (For customers in United States only) One blade of the plug is wider than other for the purpose of safety and will fit to the wall outlet only one way. If you are unable to insert the plug fully into the outlet, contact your dealer.

- AC power cord must be changed only at the qualified service shop.

On placement

- Do not place the system in an inclined position or in locations that are extremely hot, cold, dusty, dirty, or humid or lacking adequate ventilation, or subject to vibration, direct sunlight or a bright light.
- Be careful when placing the system on surfaces that have been specially treated (for example, wax, oil, polish) as staining or discoloration of the surface may result.
- If the system is brought directly from a cold to a warm location or is placed in a very damp room, moisture may condense on the lens inside the unit, and cause the system to malfunction. In this situation, leave the system turned off until the moisture evaporates.

On heat buildup

- Heat buildup on the unit during operation is normal and is not a cause for alarm.
- Do not touch the cabinet if it has been used continuously at a high volume because the cabinet may have become hot.
- Do not obstruct the ventilation holes.

On the speaker system

The built-in speaker system is not magnetically shielded, and the picture on nearby TV sets may become magnetically distorted. In this situation, turn off the TV, wait 15 to 30 minutes, and turn it back on. If there is no improvement, move the system far away from the TV.

Cleaning the cabinet

Clean this system with a soft cloth slightly moistened with a mild detergent solution. Do not use any type of abrasive pad, scouring powder, or solvent, such as thinner, benzine, or alcohol.

On Bluetooth communication

- *Bluetooth* devices should be used within approximately 10 meters (33 feet) (unobstructed distance) of each other. The effective communication range may become shorter under the following conditions.
 - When a person, metal object, wall or other obstruction is between the devices with a *Bluetooth* connection
 - Locations where a wireless LAN is installed
 - Around microwave ovens that are in use
 - Locations where other electromagnetic waves occur

- *Bluetooth* devices and wireless LAN (IEEE 802.11b/g) use the same frequency band (2.4 GHz). When using your *Bluetooth* device near a device with wireless LAN capability, electromagnetic interference may occur. This could result in lower data transfer rates, noise, or inability to connect. If this happens, try the following remedies:

- Try connecting this system and *Bluetooth* device when you are at least 10 meters (33 feet) away from the wireless LAN equipment.
- Turn off the power to the wireless LAN equipment when using your *Bluetooth* device within 10 meters (33 feet).
- The radio waves broadcast by this system may interfere with the operation of some medical devices. Since this interference may result in malfunction, always turn off the power on this system and *Bluetooth* device in the following locations:
 - In hospitals, on trains, in airplanes, at gas stations, and any place where flammable gasses may be present
 - Near automatic doors or fire alarms
- This system supports security functions that comply with the *Bluetooth* specification as a means of ensuring security during communication using *Bluetooth* technology. However, this security may be insufficient depending on the setting contents and other factors, so always be careful when performing communication using *Bluetooth* technology.
- Sony cannot be held liable in any way for damages or other loss resulting from information leaks during communication using *Bluetooth* technology.
- *Bluetooth* communication is not necessarily guaranteed with all *Bluetooth* devices that have the same profile as this system.
- *Bluetooth* devices connected with this system must comply with the *Bluetooth* specification prescribed by the Bluetooth SIG, Inc., and must be certified to comply. However, even when a device complies with the *Bluetooth* specification, there may be cases where the characteristics or specifications of the *Bluetooth* device make it impossible to connect, or may result in different control methods, display or operation.
- Noise may occur or the audio may cut off depending on the *Bluetooth* device connected with this system, the communications environment, or surrounding conditions.

Specifications

AUDIO POWER SPECIFICATIONS

POWER OUTPUT AND TOTAL HARMONIC DISTORTION: (USA model only)

With 3.5 ohm loads, both channels driven, from 120 – 10,000 Hz; rated 50 watts per channel minimum RMS power, with no more than 0.7% total harmonic distortion from 250 milliwatts to rated output.

Amplifier section

The following are measured at

USA model:

AC 120 V, 60 Hz

Mexican model:

AC 120 V – 240 V, 60 Hz

Other models:

AC 120 V – 240 V, 50/60 Hz

FST-GTK37iP/RDH-GTK37iP

Power output (rated):

100 W + 100 W (at 3.5 ohms, 1 kHz, 1% THD)

RMS output power (reference):

210 W + 210 W (per channel at 3.5 ohms, 1 kHz)

FST-GTK17iP/RDH-GTK17iP

Power output (rated):

55 W + 55 W (at 3 ohms, 1 kHz, 1% THD)

RMS output power (reference):

115 W + 115 W (per channel at 3 ohms, 1 kHz)

Speaker section

Speaker system

2 way speaker system, Bass reflex

Speaker units

FST-GTK37iP/RDH-GTK37iP:

Woofer: 200 mm (7 7/8 in), cone type

Tweeter: 66 mm (2 5/8 in), cone type

FST-GTK17iP/RDH-GTK17iP:

Woofer: 160 mm (6 3/8 in), cone type

Tweeter: 40 mm (1 5/8 in), cone type

Rated impedance

FST-GTK37iP/RDH-GTK37iP:

3.5 ohms

FST-GTK17iP/RDH-GTK17iP:

3 ohms

Input

DVD/PC IN (audio in L/R):

FST-GTK37iP/RDH-GTK37iP:

Sensitivity 1 V, impedance 47 kilohms

FST-GTK17iP/RDH-GTK17iP:

Sensitivity 1.5 V, impedance

47 kilohms

iPod/iPhone section

Terminal for Apple Device

Output voltage: DC 5 V

Maximum output current: 1 A

Compatible iPod/iPhone models:

– iPod touch 5th generation

– iPod nano 7th generation

– iPhone 5

⚡ (USB) port

Maximum output current: 1 A

Compatible iPod/iPhone models:

– iPod touch 5th generation

– iPod touch 4th generation

– iPod touch 3rd generation

– iPod touch 2nd generation

– iPod nano 7th generation

– iPod nano 6th generation

– iPod nano 5th generation (video camera)

– iPod nano 4th generation (video)

– iPod nano 3rd generation (video)

– iPod classic

– iPhone 5

– iPhone 4S

– iPhone 4

– iPhone 3GS

– iPhone 3G

USB section

Supported format

MP3 (MPEG 1 Audio Layer-3):

32 kbps – 320 kbps, VBR

WMA: 48 kbps – 192 kbps

AAC: 48 kbps – 320 kbps

WAV: 16 bit PCM

Sampling frequencies

MP3 (MPEG 1 Audio Layer-3):

32 kHz/44.1 kHz/48 kHz

WMA: 32 kHz/44.1 kHz/48 kHz

AAC: 32 kHz/44.1 kHz/48 kHz

WAV: 8 kHz – 48 kHz

Supported USB device

Mass Storage Class

↔ (USB) port: Type A

Bluetooth section

Communication system

Bluetooth Standard version 3.0 + EDR

(Enhanced Data Rate)

Output

Bluetooth Standard Power Class 2

Maximum communication range

Line of sight approx. 10 m¹⁾

Frequency band

2.4 GHz band (2.400 GHz –

2.4835 GHz)

Modulation method

FHSS (Freq Hopping Spread
Spectrum)

Compatible Bluetooth profiles²⁾

A2DP (Advanced Audio Distribution
Profile)

AVRCP 1.3 (Audio Video Remote
Control Profile)

Supported codecs

SBC (Sub Band Codec)

AAC (Advanced Audio Coding)

¹⁾ The actual range will vary depending on factors such as obstacles between devices, magnetic fields around a microwave oven, static electricity, reception sensitivity, antenna's performance, operating system, software application, etc.

²⁾ Bluetooth standard profiles indicate the purpose of Bluetooth communication between devices.

Tuner section

FM stereo, FM/AM superheterodyne tuner

Antenna:

FM lead antenna

AM loop antenna

FM tuner section

Tuning range

USA and Brazilian models:

87.5 MHz – 108.0 MHz (100 kHz
step)

Other models:

87.5 MHz – 108.0 MHz (50 kHz step)

AM tuner section

Tuning range

European, Russian and Saudi Arabian
models:

531 kHz – 1,602 kHz (9 kHz step)

USA, Latin American and Australian
models:

530 kHz – 1,710 kHz (10 kHz step)

531 kHz – 1,710 kHz (9 kHz step)

Other models:

530 kHz – 1,610 kHz (10 kHz step)

531 kHz – 1,602 kHz (9 kHz step)

General

Power requirements

USA model:

AC 120 V, 60 Hz

Mexican model:

AC 120 V – 240 V, 60 Hz

Other models:

AC 120 V – 240 V, 50/60 Hz

Power consumption

FST-GTK37iP/RDH-GTK37iP: 85 W

(0.5 W at the Power Saving mode)

FST-GTK17iP/RDH-GTK17iP: 60 W

(0.5 W at the Power Saving mode)

Dimensions (w/h/d) (Approx.)

FST-GTK37iP/RDH-GTK37iP:

768.5 mm × 323 mm × 385 mm

(30 3/8 in × 12 3/4 in × 15 1/4 in)

FST-GTK17iP/RDH-GTK17iP:

678.5 mm × 323 mm × 385 mm

(26 3/4 in × 12 3/4 in × 15 1/4 in)

Mass (Approx.)

FST-GTK37iP/RDH-GTK37iP:

14.0 kg (30 lb 14 oz)

FST-GTK17iP/RDH-GTK17iP:

12.0 kg (26 lb 8 oz)

Supplied accessories

Remote control (1)

R6 (Size AA) batteries (2)

FM lead/AM loop antenna (1)

Design and specifications are subject to change without notice.

<http://www.sony.net/>



©2013 Sony Corporation Printed in China



* 4 4 4 9 1 9 8 1 4 * (1)

Free Manuals Download Website

<http://myh66.com>

<http://usermanuals.us>

<http://www.somanuals.com>

<http://www.4manuals.cc>

<http://www.manual-lib.com>

<http://www.404manual.com>

<http://www.luxmanual.com>

<http://aubethermostatmanual.com>

Golf course search by state

<http://golfingnear.com>

Email search by domain

<http://emailbydomain.com>

Auto manuals search

<http://auto.somanuals.com>

TV manuals search

<http://tv.somanuals.com>