

# DVD Home Theater Active Speaker System

---

Operating Instructions

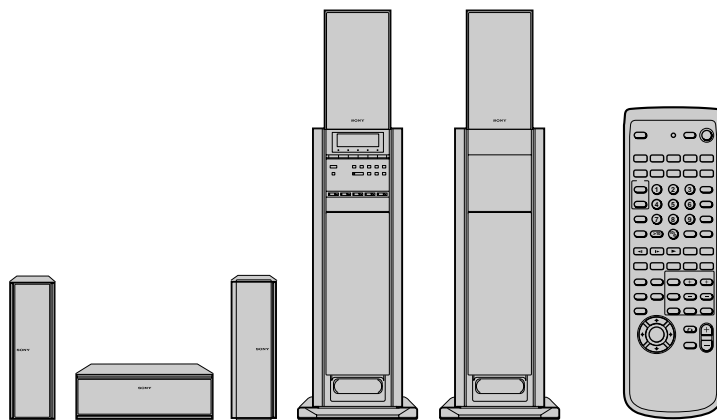

**SAVA-D900**

ENERGY STAR® is a U.S. registered mark. As an ENERGY STAR Partner, Sony Corporation has determined that this product meets the ENERGY STAR guidelines for energy efficiency.

# WARNING

**To prevent fire or shock hazard, do not expose the unit to rain or moisture. To avoid electrical shock, do not open the cabinet. Refer servicing to qualified personnel only.**

## CAUTION

The use of optical instruments with this product will increase eye hazard. As the laser beam used in this CD/DVD Player is harmful to eyes, do not attempt to disassemble the cabinet. Refer servicing to qualified personnel only.



This label is located on the Laser protective housing inside the enclosure.

The following caution label is located inside of the unit.

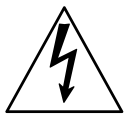
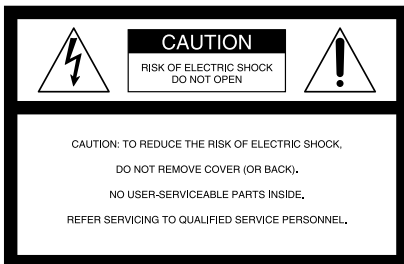
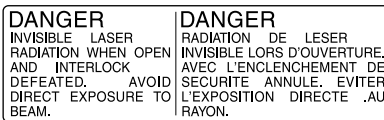

This symbol is intended to alert the user to the presence of uninsulated "dangerous voltage" within the product's enclosure that may be of sufficient magnitude to constitute a risk of electric shock to persons.



This symbol is intended to alert the user to the presence of important operating and maintenance (servicing) instructions in the literature accompanying the appliance.

## Owner's Record

The model and serial numbers are located at the rear of the main unit (left). Record the serial number in the space provided below. Refer to them whenever you call upon your Sony dealer regarding this product.

Model No. SAVA-D900  
Serial No. \_\_\_\_\_

## CAUTION

You are cautioned that any changes or modifications not expressly approved in this manual could void your authority to operate this equipment.

## NOTE:

This equipment has been tested and found to comply with the limits for a Class B digital device, pursuant to Part 15 of the FCC Rules. These limits are designed to provide reasonable protection against harmful interference in a residential installation. This equipment generates, uses, and can radiate radio frequency energy and, if not installed and used in accordance with the instructions, may cause harmful interference to radio communications. However, there is no guarantee that interference will not occur in a particular installation. If this equipment does cause harmful interference to radio or television reception, which can be determined by turning the equipment off and on, the user is encouraged to try to correct the interference by one or more of the following measures:

- Reorient or relocate the receiving antenna.
- Increase the separation between the equipment and receiver.
- Connect the equipment into an outlet on a circuit different from that to which the receiver is connected.
- Consult the dealer or an experienced radio/TV technician for help.

## Note on CATV system installer:

This reminder is provided to call the CATV system installer's attention to Article 820-40 of the NEC that provides guidelines for proper grounding and, in particular, specifies that the cable ground shall be connected to the grounding system of the building, as close to the point of cable entry as practical.

# Welcome!

Thank you for purchasing the Sony speaker system.

The SAVA-D900 is a DVD home theater active speaker system incorporating a DVD 5-disc changer, a Dolby Digital and DTS decoder, and a subwoofer.

This system is easy to setup and allows you to enjoy ten different types of surround sound, accommodating a variety of program sources.

Before operating the unit, please read this manual thoroughly and retain it for future reference.

---

## TABLE OF CONTENTS

About This Manual .....	4
This System Can Play the Following Discs .....	4
Precautions .....	6
Notes on Discs .....	7
Note on DVD 5-disc changer with EXCHANGE mechanism .....	7

---

### Getting Started ..... 8

Unpacking .....	8
Assembling Main Units .....	9
Speaker System Hookup .....	10
Turning the Speaker System On and Off .....	14
Selecting the Language for On-Screen Display .....	15
Speaker Setup .....	16
Presetting Radio Stations .....	19

---

### Playing Discs ..... 20

Playing Discs .....	20
Selecting a Sound Field .....	22
Understanding the Multi-Channel Surround Displays ..	24
Customizing Sound Fields .....	25
Resuming Playback from the Point Where You Stopped the Disc (Resume Play) .....	29
Using the Menu for Each DVD .....	29
Playing VIDEO CDs with PBC Functions (PBC Playback) .....	30
Creating Your Own Program (Program Play) .....	31
Playing in Random Order (Shuffle Play) .....	33
Using the Front Panel Display .....	33

---

### Using Various Functions with the Control Menu ..... 36

Using the Control Menu Display .....	36
Control Menu Item List .....	38
Searching for the Title/Chapter/Track/Index/Scene ..	39
Checking the Playing Time and Remaining Time ..	40
Selecting a Start Point Using the Time Code .....	40
Checking the Information of the Disc .....	41
Changing the Sounds .....	41
Displaying the Subtitles .....	43
Changing the Angles .....	43
Selecting the Disc Mode (1 Disc or All Discs) .....	44
Playing Repeatedly (Repeat Play) .....	45
Repeating a Specific Portion (A↔B Repeat) .....	45
Checking the Play Information .....	46
Displaying Different Angles Simultaneously .....	47
Dividing a Track into 9 Sections (Strobe Play) .....	48
Scanning the Title, Chapter and Track .....	48

---

### Settings and Adjustments ..... 49

Using the Setup Display .....	49
Setup Display Item List .....	51
Setting the Language for Display and Sound (LANGUAGE SETUP) .....	52
Settings for Display (SCREEN SETUP) .....	53
Custom Settings (CUSTOM SETUP) .....	54
Settings for Sound (AUDIO SETUP) .....	57
Settings for Speakers (SPEAKER SETUP) .....	57

---

### Other Operations ..... 59

Operating Sony Components .....	59
Operating Non-Sony Components .....	60
The Numeric Codes Corresponding to the Component and the Make of the Component ..	61
Table of Buttons that You Can Use to Control Each Component .....	63
Listening to the Radio .....	63
Naming Preset Stations .....	64
Using the Sleep Timer .....	65

---





### Additional Information ..... 66

Troubleshooting .....	66
Self-diagnosis Function .....	69
Specifications .....	70
Glossary .....	71
Language Code List .....	73
Index to Parts and Controls .....	74
Index .....	Back cover

# About This Manual

## Conventions

- Instructions in this manual describe the controls on the system. You can also use the controls on the remote if they have the same or similar names as those on the system.
- The icons on the right are used in this manual:

Icon	Meaning
	Indicates that you can use only the remote to do the task.
	Indicates tips and hints for making the task easier.
	Indicates the functions for DVD VIDEOS.
	Indicates the functions for VIDEO CDs.
	Indicates the functions for Audio CDs.

## This System Can Play the Following Discs

	DVD VIDEOS		VIDEO CDs		Audio CDs	
Disc logo						
Contents	Audio + Video		Audio + Video		Audio	
Disc size	12 cm	8 cm	12 cm	8 cm	12 cm	8 cm (CD single)
Play time	About 4 h (for single-sided DVD)/ about 8 h (for double-sided DVD)	About 80 min. (for single-sided DVD)/ about 160 min. (for double-sided DVD)	74 min.	20 min.	74 min.	20 min.

“DVD VIDEO” logo is a trademark.

This system conforms to the NTSC color system. You cannot play discs recorded in other color systems such as PAL or SECAM.

### Region code of DVDs you can play on this unit

**Your system has a region code printed on the back of the unit and will only play DVDs that are labeled with identical region codes.**

DVDs labeled  will be also played on this unit.

If you try to play any other DVD, the message “Playing this disc prohibited by area limits.” will appear on the TV screen.

Depending on the DVD, no region code indication may be labeled even though playing the DVD is prohibited by the area limits.

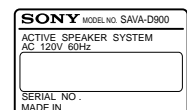

Region code 

### Note on playback operations of DVDs and VIDEO CDs

Some playback operations of DVDs and VIDEO CDs may be intentionally fixed by software producers. Since this system plays DVDs and VIDEO CDs according to the disc contents the software producers designed, some playback features may not be available. Also refer to the instructions supplied with the DVDs or VIDEO CDs.

## Terms for discs

- **Title**

The longest sections of a picture or a music piece on a DVD; a movie, etc., for a picture piece on a video software; or an album, etc., for a music piece on an audio software. Each title is assigned a title number enabling you to locate the title you want.

- **Chapter**

Sections of a picture or a music piece that are smaller than titles. A title is composed of several chapters. Each chapter is assigned a chapter number enabling you to locate the chapter you want. Depending on the disc, no chapters may be recorded.

- **Track**

Sections of a picture or a music piece on a VIDEO CD or a CD. Each track is assigned a track number enabling you to locate the track you want.

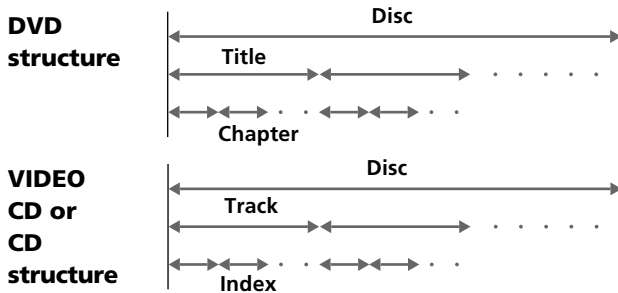

- **Index (CD) / Video Index (VIDEO CD)**

A number that divides a track into sections to easily locate the point you want on a VIDEO CD or a CD. Depending on the disc, no indexes may be recorded.

- **Scene**

On a VIDEO CD with PBC functions, the menu screens, moving pictures and still pictures are divided into sections called "scenes." Each scene is assigned a scene number enabling you to locate the scene you want.

### Note on PBC (Playback Control) (VIDEO CDs)

This system conforms to Ver. 1.1 and Ver. 2.0 of VIDEO CD standards. You can enjoy two kinds of playback according to the disc type.

Disc type	You can
VIDEO CDs without PBC functions (Ver. 1.1 discs)	Enjoy video playback (moving pictures) as well as music.
VIDEO CDs with PBC functions (Ver. 2.0 discs)	Play interactive software using menu screens displayed on the TV screen (PBC Playback), in addition to the video playback functions of Ver 1.1 discs. Moreover, you can play high-resolution still pictures, if they are included on the disc.

## Discs that the system cannot play

The system cannot play discs other than the ones listed in the table on page 4. CD-R, CD-ROMs including PHOTO CDs, data sections in CD-EXTRAS, DVD-ROMs etc., cannot be played.

This system incorporates Dolby\* Digital and Pro Logic Surround and the DTS\*\* Digital Surround System.

\* Manufactured under license from Dolby Laboratories. "Dolby," "Pro Logic" and the double-D symbol  are trademarks of Dolby Laboratories. Confidential unpublished Works. © 1992-1997 Dolby Laboratories, Inc. All rights reserved.

\*\*Manufactured under license from Digital Theater Systems, Inc. US Pat. No. 5,451,942 and other worldwide patents issued and pending. "DTS" and "DTS Digital Surround" are trademarks of Digital Theater Systems, Inc. © 1996 Digital Theater Systems, Inc. All rights reserved.

This product incorporates copyright protection technology that is protected by method claims of certain U.S. patents and other intellectual property rights owned by Macrovision Corporation and other rights owners. Use of this copyright protection technology must be authorized by Macrovision Corporation, and is intended for home and other limited viewing uses only unless otherwise authorized by Macrovision Corporation. Reverse engineering or disassembly is prohibited.

# Precautions

## On safety

- Caution – The use of optical instruments with this product will increase eye hazard.
- Should any solid object or liquid fall into the cabinet, unplug the system and have it checked by qualified personnel before operating it any further.

## On power sources

- The system is not disconnected from the AC power source (mains) as long as it is connected to the wall outlet, even if the system itself has been turned off.
- If you are not going to use the system for a long time, be sure to disconnect the system from the wall outlet. To disconnect the AC power cord (mains lead), grasp the plug itself; never pull the cord.
- Should the AC power cord (mains lead) need to be changed, have it done at a qualified service shop only.

## On placement

- Place the system in a location with adequate ventilation to prevent heat build-up in the system.
- Do not place the system on a soft surface such as a rug that might block the ventilation holes on the bottom.
- Do not place the system in a location near heat sources, or in a place subject to direct sunlight, excessive dust or mechanical shock.
- Do not place anything on top of the cabinet that might block the ventilation holes and cause malfunctions.
- Place the system on a horizontal surface.

## On operation

- If the system is brought directly from a cold to a warm location, or is placed in a very damp room, moisture may condense on the lenses inside the system. Should this occur, the system may not operate properly. In this case, remove the disc and leave the system turned on for about half an hour until the moisture evaporates.

## On adjusting volume

- Do not turn up the volume while listening to a portion with very low level inputs or no audio signals. If you do, the speakers may be damaged when a peak level portion is played.

## On cleaning

- Clean the cabinet, panel and controls with a soft cloth slightly moistened with a mild detergent solution. Do not use any type of abrasive pad, scouring powder or solvent such as alcohol or benzene.
- Clean the disc tray if it becomes dusty.

## On your TV's color

- If the speakers should cause the TV screen to have color irregularity, turn off the TV at once then turn it on after 15 to 30 minutes. If color irregularity should persist, place the speakers further away from the set.

## On transporting the system

- Follow the instructions below before transporting the system to prevent any damage to the DVD player if dropped accidentally:
  - 1** Remove all discs from the disc trays.  
If you leave any discs inside the disc trays, you may not be able to remove them later.
  - 2** Press  $\triangle$  of DISC 1 and place the dummy disc on the disc tray. **Do not press  $\triangle$  of DISC 1 again to close the disc tray.**
  - 3** Press I/⏻.  
The disc tray closes automatically, and the system turns off.
  - 4** After the front panel display turns off, unplug the AC power cord.
  - 5** Remove both of the front speakers from the main units.

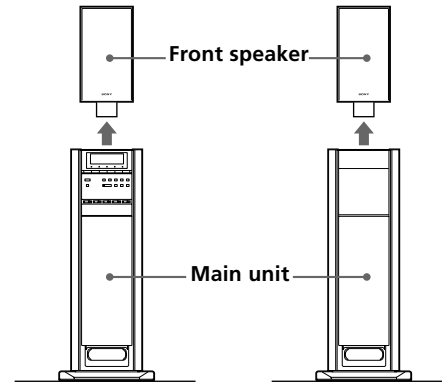

- Check that the power of all the components is off and all operations are completed before transporting the system.

If you have any questions or problems concerning your system, please consult your nearest Sony dealer.

### IMPORTANT NOTICE

Caution: The enclosed system is capable of holding a still video image or On screen display image on your television screen indefinitely. If you leave the still video image or On screen display image displayed on your TV for an extended period of time you risk permanent damage to your television screen. Projection televisions are very susceptible.

## Notes on Discs

### On handling discs

- To keep the disc clean, handle the disc by its edge. Do not touch the surface.
- Do not stick paper or tape on the disc. If there is glue (or a similar substance) on the disc, remove the glue completely before using the disc.

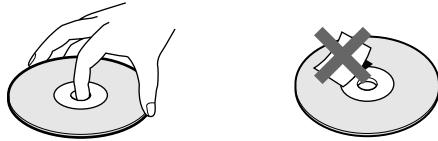

- Do not expose the disc to direct sunlight or heat sources such as hot air ducts, or leave it in a car parked in direct sunlight as there can be considerable rise in temperature inside the car.
- After playing, store the disc in its case.
- Do not use discs fitted with a protection ring. This may cause the system to malfunction.

### On cleaning

- Before playing, clean the disc with a cleaning cloth. Wipe the disc from the center out.

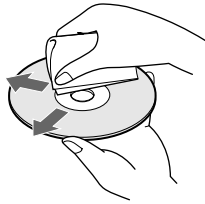

- Do not use solvents such as benzine, thinner, commercially available cleaners or anti-static spray intended for vinyl LPs.

## Note on DVD 5-disc changer with EXCHANGE mechanism

You can change other discs while playing a disc (EXCHANGE mechanism).

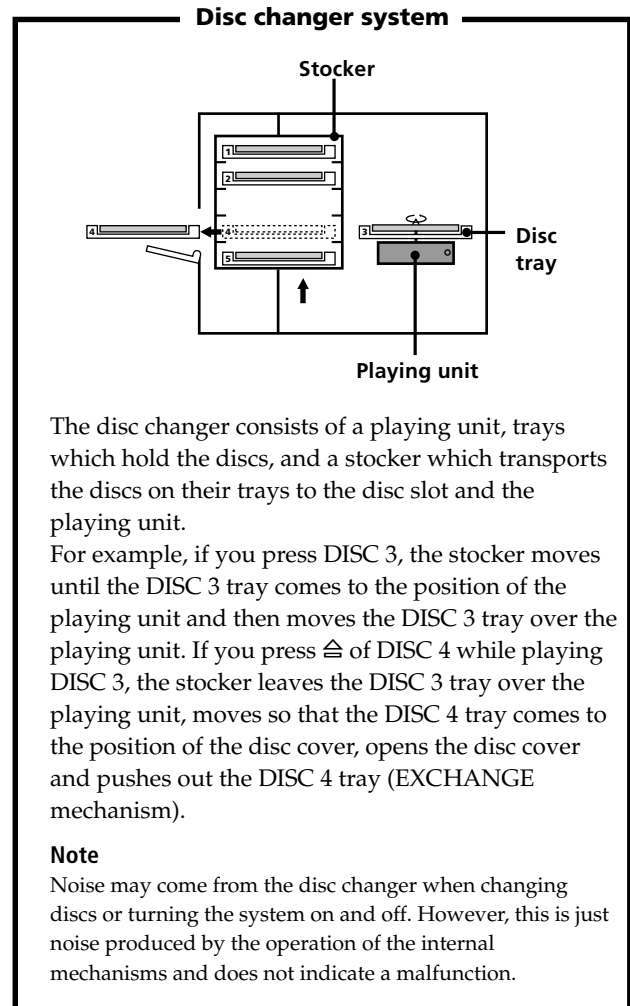

# Getting Started

This section describes how to hook up the system to the speakers, a TV monitor with audio/video input jacks and other video component. You cannot connect this system to a TV monitor which does not have a video input connector. Be sure to turn off the power of each component before making the connections.

## Unpacking

Check that you have the following items:

- Front speakers (2)
- Main unit (left) (1)
- Main unit (right) (1)
- Satellite speakers SS-T900 (3; one for the center speaker, and two for the rear speakers)
- Remote commander (remote) RM-PP900 (1)

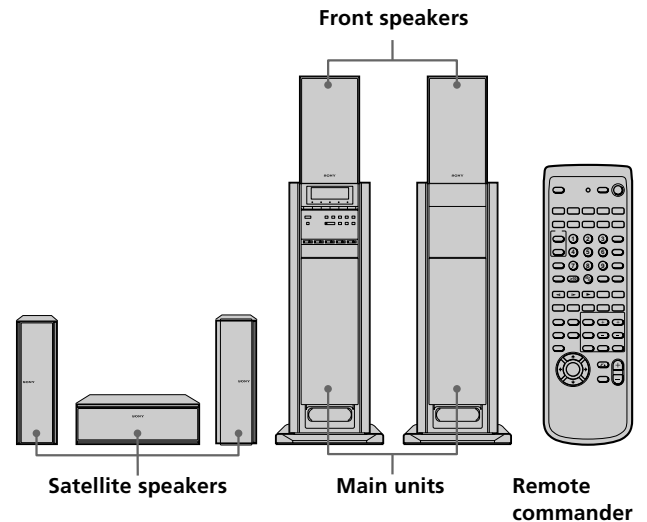

- AM loop antenna (1)
- FM wire antenna (1)
- Main unit L/R connecting cord, 12 ft. (3.5 m) (1)
- Center speaker connecting cord, 8 ft. 2 1/2 in. (2.5 m) (1)
- Rear speaker connecting cords, 32 ft. 9 3/4 in. (10 m) (2)
- Audio connecting cord, 5 ft. (1.5 m) (1)
- Video connecting cord, 5 ft. (1.5 m) (1)
- Black wood screws (for the mounting brackets) (4)
- Foot pads (12)
- Size AA (R6) batteries (2)
- Mounting brackets (2)



## Assembling Main Units

### Inserting batteries into the remote

You can control the system using the supplied remote. Insert two size AA (R6) batteries by matching the + and – on the batteries. When using the remote, point it at the remote sensor  on the system.

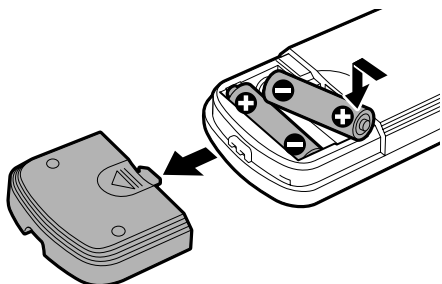

 You can control TVs, VCRs, LD players, digital satellite receivers, and MD decks using the supplied remote

See page 59.

#### Notes

- Do not leave the remote in an extremely hot or humid place.
- Do not use a new battery with an old one.
- Do not drop any foreign object into the remote casing, particularly when replacing the batteries.
- Do not expose the remote sensor to direct sunlight or lighting apparatuses. Doing so may cause a malfunction.
- If you will not use the remote for an extended period of time, remove the batteries to avoid possible damage from battery leakage and corrosion.

Insert the front speakers into the main units as shown below. Make sure the front speakers are correctly inserted.

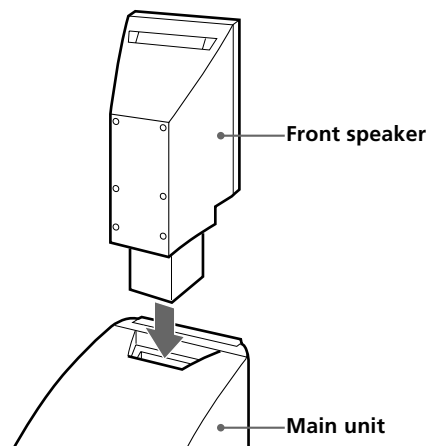

# Speaker System Hookup

Connect the supplied speaker system using the supplied speaker cords .

To obtain the best possible surround sound, specify the speaker parameters (distance, level, etc.) on page 16.

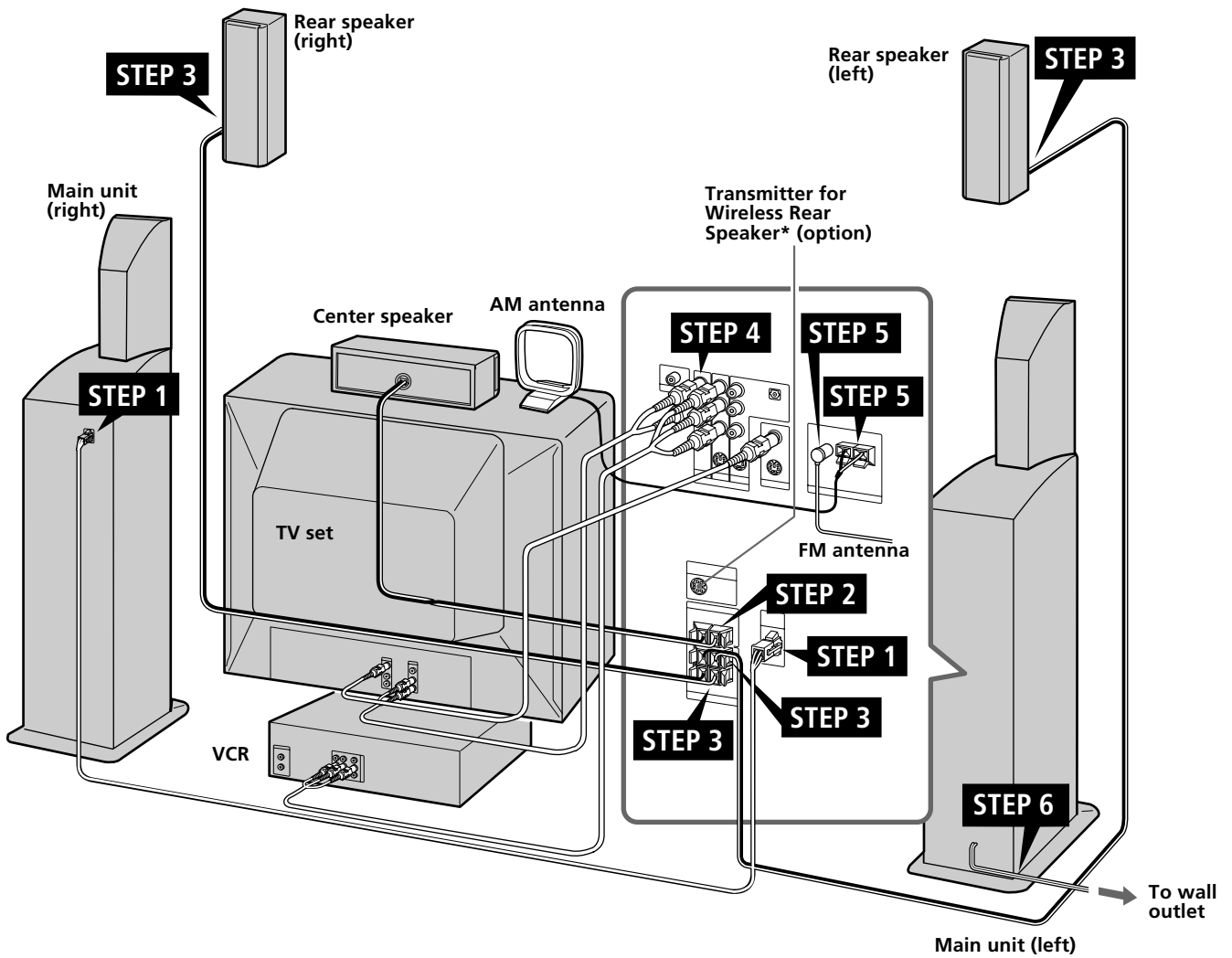

\* If you use an SA-IF70 Wireless Speaker System (not supplied) for the rear speakers, connect the transmitter supplied with the SA-IF70 system to this connector. For details, refer to the Operating Instructions provided with the SA-IF70 system.

The arrow  $\Rightarrow$  indicates signal flow.

### STEP 1 Connecting the main units

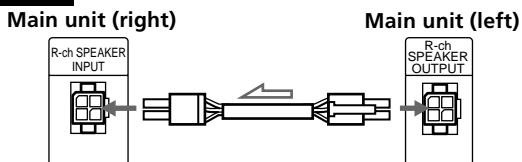

To disconnect a cord, hold down the release tab and pull out the connector. Never pull the cord itself.

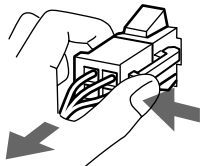

### STEP 2 Connecting the center speaker

Use the supplied 8-feet-2  $\frac{1}{2}$  inches (2.5 m) speaker cord to connect the center speaker.

Insert the stripped wires into the speaker terminals.

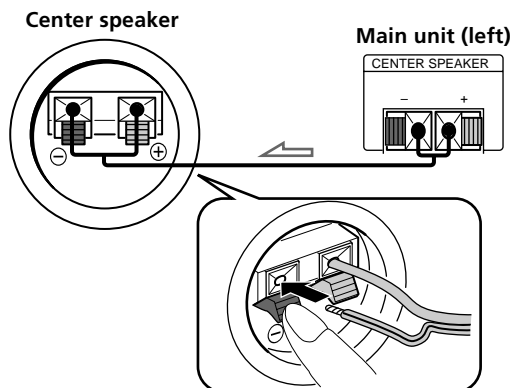

Be sure to connect matching speaker terminals (e.g., use the gray wire to connect + to +, and use the striped wire to connect - to -). If the connections are reversed (+ to -), the sound will lack bass.

### STEP 3 Connecting the rear speakers

Use the supplied 32-feet-9  $\frac{3}{4}$  inches (10 m) speaker cords to connect the left and right rear speakers.

Insert the stripped wires into the speaker terminals.

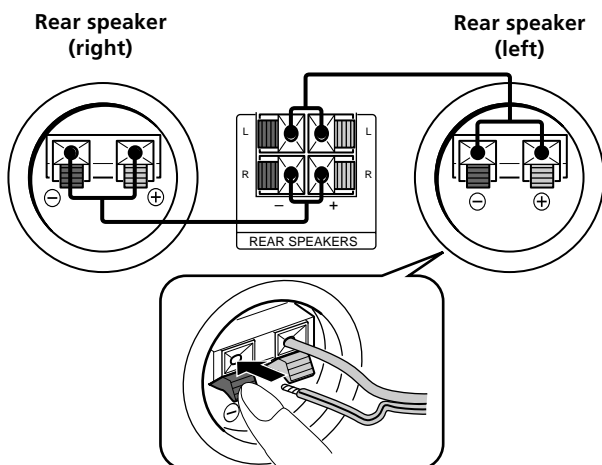

### STEP 4 Connecting your TV

Use the supplied audio connecting cord to connect the TV AUDIO INPUT jacks on the left main unit to the AUDIO OUTPUT jacks on your TV.

#### Important

If your TV set has an on/off switch for its internal speaker, set this to off, and enjoy the sound of this speaker system. If your TV set does not, set the volume on your TV set to minimum.

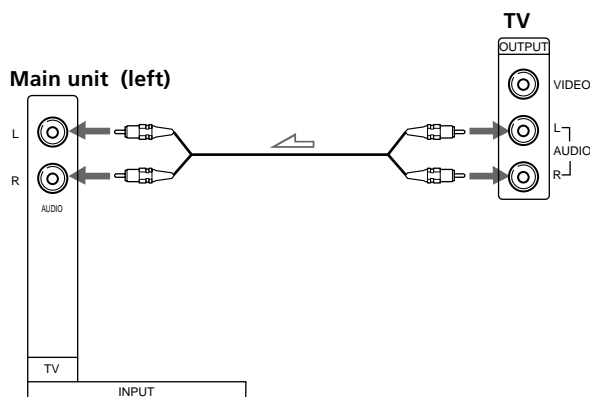

Use the supplied video connecting cord to connect the MONITOR OUT jack on the left main unit to the VIDEO INPUT jack on your TV.

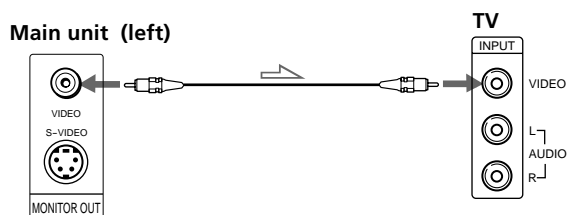

#### If you use AUDIO OUT jacks marked VARIABLE

After making the connection as shown above, turn up the volume on the TV set. Use this speaker system's volume control for regular volume adjustment. Turning down the volume on the TV set reduces the AUDIO OUT signal level and may cause a loss in sound quality.

#### If you have a Sony XBR<sup>2</sup> series TV or Sony Projection TV equipped with a speaker switch

If your Sony XBR<sup>2</sup> series TV set or Projection TV is compatible with SAVA series speakers, you can use the TV set's menu and remote control functions to operate this speaker system.

For details, see the Operating Instructions supplied with your TV set.

Be sure to connect the TV AUDIO INPUT jacks on the left main unit to the TV set's FIXED AUDIO OUTPUT jacks if you make this connection.

Continued to the next page

## Speaker System Hookup

- 1 Use an optional CONTROL S cord to connect the CONTROL S IN jack on the left main unit to the CONTROL S OUT jack on the back of the TV.

XBR<sup>2</sup> series TV set or  
Projection TV

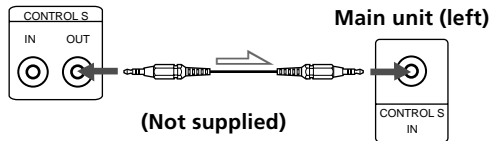

- 2 Follow the Operating Instructions supplied with your TV set to set it to operate this speaker system.

**💡 If you use the S-video connector instead of the video jack**  
Your TV must also be connected via an S-video connector. S-video signals are on a separate bus from the video signals and will not be output through the video jack.

### STEP 5 Connecting the FM/AM antennas

Set up the AM loop antenna, then connect it.

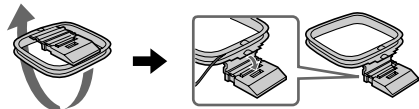
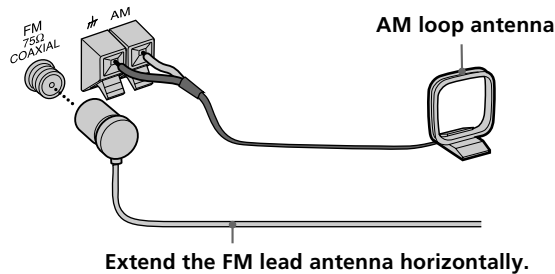

#### Notes

- To prevent noise pickup, keep the AM loop antenna away from the system and other components.
- Be sure to fully extend the FM wire antenna.
- After connecting the FM wire antenna, keep it as horizontal as possible.
- When you connect the supplied AM antenna, connect the black cord (A) to the  $\pi$  terminal, and the white cord (B) to the other terminal.

### STEP 6 Connecting the AC power cord

Connect the AC power cord from the left main unit to a wall outlet.

### Connecting other components

With its built-in amplifier, this speaker system can be used to output audio and video signals directly from such components as LD players, MD decks, digital satellite receivers, and VCRs.

#### If you connect a VCR

Connect the VCR to the AUDIO L/R and VIDEO jacks of VIDEO INPUT of the system.

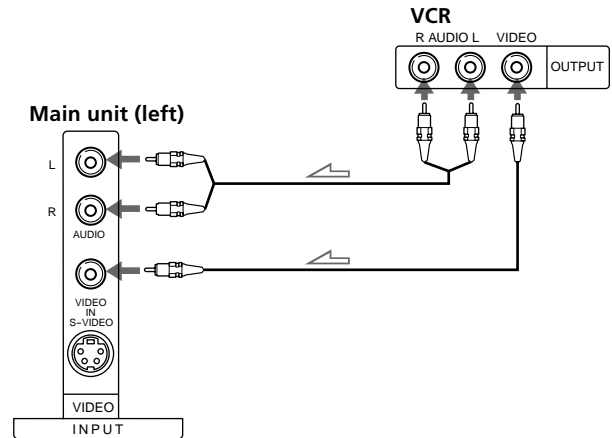

#### If you connect an LD player, another VCR, or other video components

Connect the component to the AUDIO L/R and VIDEO jacks of AUX of the system.

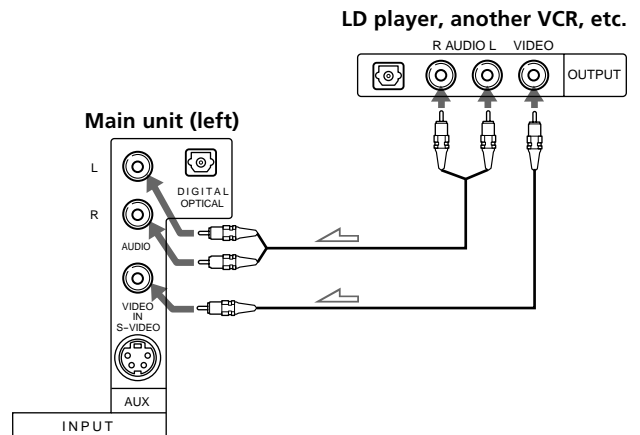

### If you connect an MD deck

Connect the MD deck to the DIGITAL OPTICAL jack besides the AUDIO L/R jacks of AUX of the system.

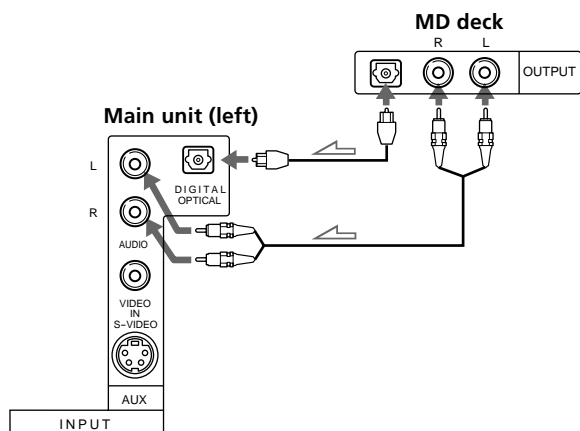

### If you connect a digital satellite receiver with the DIGITAL OPTICAL jack

Connect the digital satellite receiver to the DIGITAL OPTICAL jack besides the AUDIO L/R jacks of AUX and VIDEO of the system.

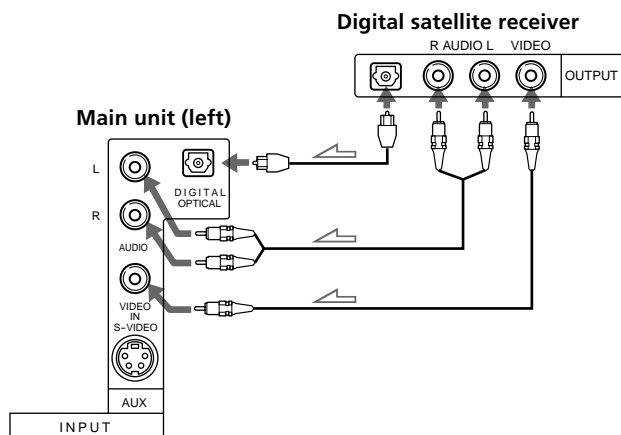

### 💡 If you use the S-video connector instead of the video jack

Your TV must also be connected via an S-video connector. S-video signals are on a separate bus from the video signals and will not be output through the video jack.

#### Note

Do not connect an amplified audio source. The combined amplification from the component and the speaker's built-in amplifier may damage the speakers.

### Attaching the supplied foot pads to the center speaker

Attach the supplied foot pads to the bottom of the speaker, one in each of the four corners to place the center speaker on your TV set. Make sure the speaker is solidly placed on the top of the TV set.

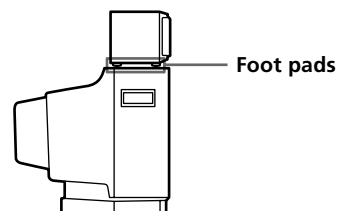

#### Note

Do not place the speaker on top of a TV set which is smaller than the speaker.

### Installing the rear speakers with the supplied accessories

Use the supplied accessories to properly install the rear speakers in their selected locations (see page 8).

#### Foot pads

If you install the rear speakers on a shelf or speaker stand, attach the supplied foot pads to the bottom of the speakers, one in each of the four corners, and make sure that the speakers are solidly placed.

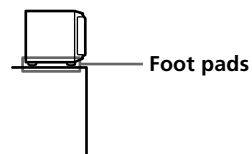

#### Note

Do not place any speaker on shelves or stands which are smaller than the speaker.

Continued to the next page

## Speaker System Hookup

### Mounting brackets

If you wish to hang the rear speakers on a wall with hooks (not supplied), use the supplied black wood screws to attach the supplied mounting brackets to the upper part of the back panel of each rear speaker.

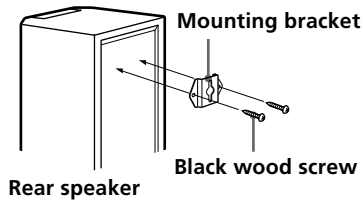

### Notes

- You are responsible for the proper selection and use of mounting hardware that you purchase at hardware stores, and for the proper and safe mounting of the speakers.
- Each satellite speaker has a corresponding position for optimum sound effect. Before attaching the mounting brackets, see "Positioning the center and rear speakers for better surround sound effect" on page 16.

## Turning the Speaker System On and Off

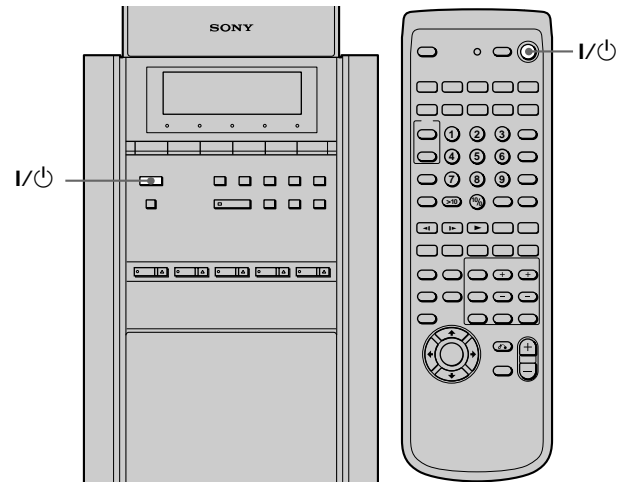

### Turning on/ off the speaker system



Press I/⏻.

**After connecting all the components, speakers, and AC power cord, output a test tone to check that all the speakers are connected correctly. For details on outputting a test tone, see page 18.**

If no sound is heard from a speaker while outputting a test tone or a test tone is output from a speaker other than the one whose name is currently displayed on the front panel display, check the speaker connection again.

### About the dummy disc

A dummy disc is placed in the DISC 1 tray at shipment to prevent damage to the system during transportation. Before using the system for the first time, remove the dummy disc following the steps below.

- 1 Press I/⏻ to turn on the system.
- 2 Press  of DISC 1 and remove the dummy disc from the disc tray.
- 3 Press  to close the disc tray.

#### Notes on the dummy disc

- You must use the dummy disc for protection when transporting the system. Be sure to keep the dummy disc in a secure place. (page 6)
- There are no signals recorded on the dummy disc.

## Selecting the Language for On-Screen Display

You can select the language for the setup display, the Control Menu display or the messages displayed on the screen. The default setting is "ENGLISH."

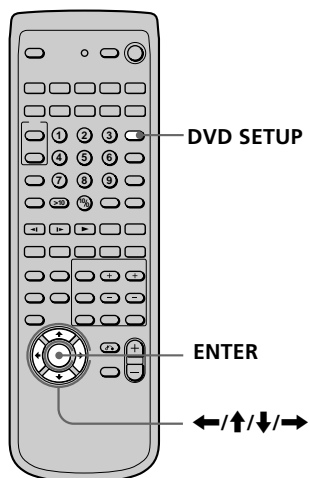

- 1 While in stop mode, press DVD SETUP on the remote and select "LANGUAGE SETUP" using the ↑/↓ buttons, and then press ENTER.

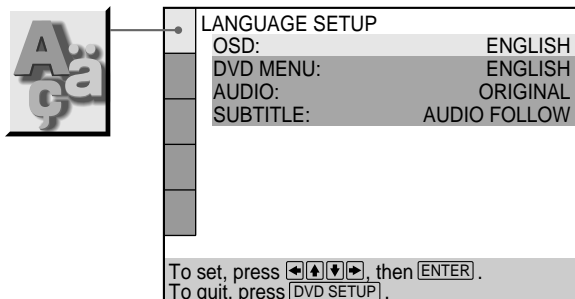

- 2 Select "OSD" using the ↑/↓ buttons, then press → or ENTER.

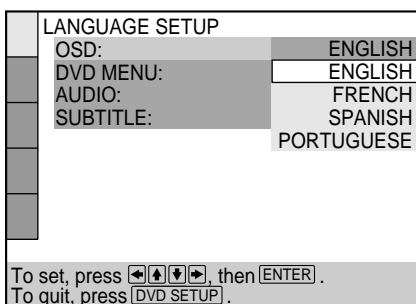

- 3 Select your language (e.g., "FRENCH") using the ↑/↓ buttons, then press ENTER.



- 4 Press DVD SETUP to exit menu.

### To cancel using the setup display

Press DVD SETUP on the remote again.

### Note

The languages you can select are the ones displayed in Step 2. For details, see page 52.

# Speaker Setup

For the best possible surround sound all the speakers other than the subwoofer should be the same distance from the listening position (A).

However, this system lets you place the center speaker up to 5 feet closer (B) and the rear speakers up to 15 feet closer (C) to the listening position.

The front speakers can be placed from 3 to 15 feet (A) from the listening position.

You can place the rear speakers either behind you or to the side, depending on the shape of your room, etc.

## When the rear speakers are placed to the side

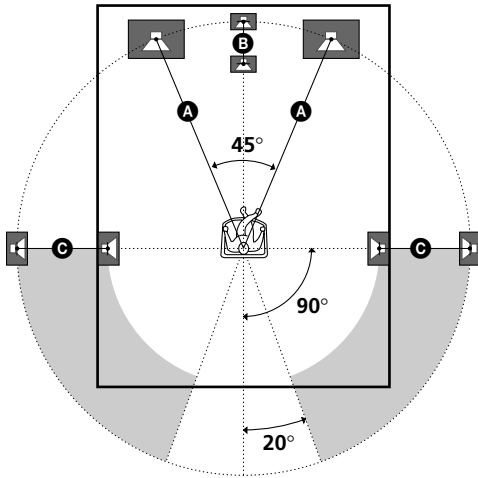

## When the rear speakers are placed behind you

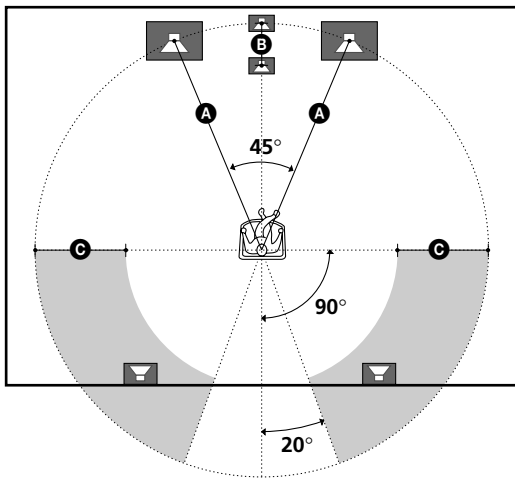

### Note

Do not place the center and rear speakers farther away from the listening position than the front speakers.

### 💡 Positioning the center and rear speakers for better surround sound effect

For better surround sound quality, position each speaker as shown below. Each rear speaker should be placed as its tweeter is on the inner side.

The grille can be detached to visually verify the orientation. The "SONY" logo on each satellite speakers can be rotated to match the speaker's orientation.

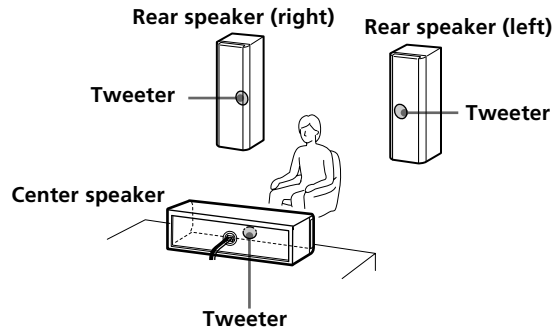

### Note

Before disconnecting the left main unit's AC power cord, turn the system off first.



## Specifying the speaker parameters

To obtain the best possible surround sound, first specify the distance of the speakers from your listening position, then set the balance and level. Use the test tone to adjust the speaker volumes to the same level.

Details of each item will follow the description of the operation.

You may adjust the speaker parameters using **SPEAKER SETUP** in the setup display (page 57).

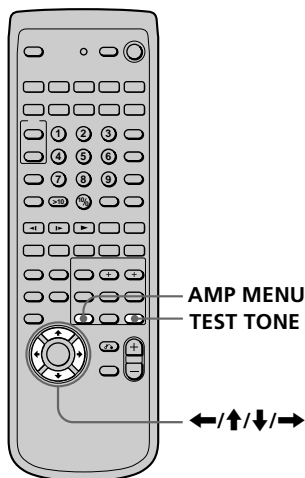

### To specify the distance, position and height of the speakers

- 1** Press **AMP MENU** repeatedly on the remote to display **<< SP. SETUP >>** on the front panel display.
- 2** Sit at your listening position and select the item to be set using the **↑/↓** buttons.
  - Items set in **<< SP. SETUP >>**
    - Distance of the front, rear and center speakers
    - Position and height of the rear speakers
- 3** Set the parameter using the **←/→** buttons. The selected parameter will appear on the front panel display.
- 4** Repeat Steps 2 and 3 to set other parameters within **<< SP. SETUP >>**.  
If you do not operate the remote for a few seconds, the parameter turns off and is stored in the system.

### ■DISTANCE

You can vary the distance of each speaker as follows. The default adjustments are in the parentheses.

- **FRONT** (8 ft) (front speakers distance)  
Front speaker distance can be set in 1 foot steps from 3 to 15 feet.
- **CENTER** (8 ft) (center speaker distance)  
Center speaker distance can be set in 1 foot steps from a distance equal to the front speaker distance to a distance 5 feet closer to your listening position.
- **REAR** (5 ft) (rear speakers distance)  
Rear speaker distance can be set in 1 foot steps from a distance equal to the front speaker distance to a distance 15 feet closer to your listening position.

### Note

If each of the front or rear speakers are not placed an equal distance from your listening position, set the distance of the closest speaker.

### ■POSITION/ HEIGHT

You can specify the position and height of the rear speakers. The default settings are underlined.

### Position diagram

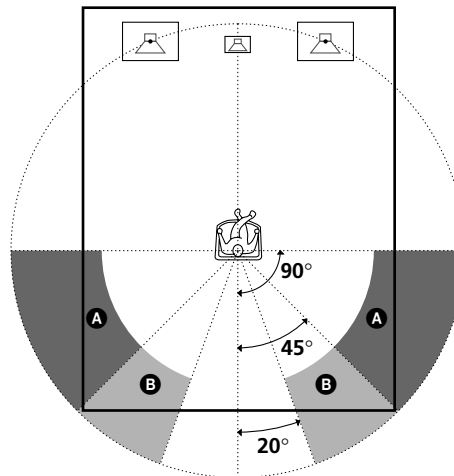

Press **←/→** to change between **R.PLACE BEHIND** and **R.PLACE SIDE**.

- R.PLACE BEHIND  
Select this if the rear speakers are located in the section **B**.
- **R.PLACE SIDE**  
Select this if the rear speakers are located in the section **A**.

Continued to the next page

## Speaker Setup

### Height diagram

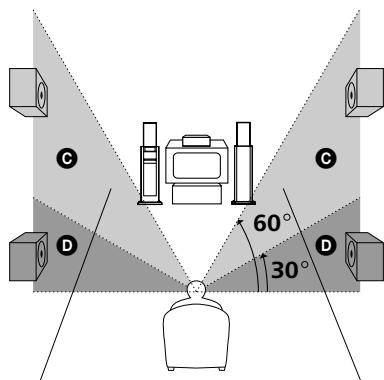

Press  $\leftarrow/\rightarrow$  to change between R.HEIGHT LOW and R.HEIGHT HIGH.

- **R.HEIGHT LOW**  
Select this if the rear speakers are located in the section **D**.
- **R.HEIGHT HIGH**  
Select this if the rear speakers are located in the section **C**.

### To specify the balance and level of the speakers

#### 1 Press TEST TONE on the remote.

You will hear the test tone from each speaker in sequence.

#### 2 Press LEVEL.

#### 3 Sit at your listening position and select the item to be adjusted using the $\uparrow/\downarrow$ buttons.

- Items adjusted in << LEVEL >>
  - Balance of the front and rear speakers
  - Volume level of the center and rear speakers and subwoofer

You will also find other <<LEVEL>> items (dts LFE, and D.COMP.), that you do not have to adjust here yet. They are to be used when you customize sound fields. See page 25.

#### 4 Adjust the volume level so that the volume of the test tone from each speaker sounds the same using the $\leftarrow/\rightarrow$ buttons.

The adjusted value will appear on the front panel display.

#### 5 Repeat Steps 3 and 4 to adjust other parameters within <<LEVEL>>.

If you do not operate the remote for a few seconds, the value turns off and is stored in the system.

#### 6 Press TEST TONE again to turn off the test tone.

### ■BALANCE

You can vary the balance of each speaker as follows. The default adjustments are in the parentheses.

- FRNT. L \_\_ | \_\_ R (center) (front speakers)  
Adjust the balance between the front left and right speakers (6 dB (L) to 6 dB (R), 1 dB steps).
- REAR L \_\_ | \_\_ R (center) (rear speakers)  
Adjust the balance between the rear left and right speakers (6 dB (L) to 6 dB (R), 1 dB steps).

### ■LEVEL

You can vary the level of each speaker as follows. The default adjustments are in the parentheses.

- C. LEVEL (0 dB) (center speaker level)  
Adjust the level of the center speaker (-6 dB to +6 dB, 1 dB steps).
- R. LEVEL (0 dB) (rear speakers level)  
Adjust the level of the rear speakers (-6 dB to +6 dB, 1 dB steps).
- S. W. LEVEL (0 dB) (subwoofer level)  
Adjust the level of the subwoofer (-6 dB to +6 dB, 1 dB steps).

### Note

When you select an item, the sound cuts off for a moment.

### To adjust the volume of all the speakers at one time

Use the MASTER VOLUME +/- buttons.

# Presetting Radio Stations

You can preset 20 stations for FM and 10 stations for AM. Before tuning, make sure that you have turned down the volume to the minimum.

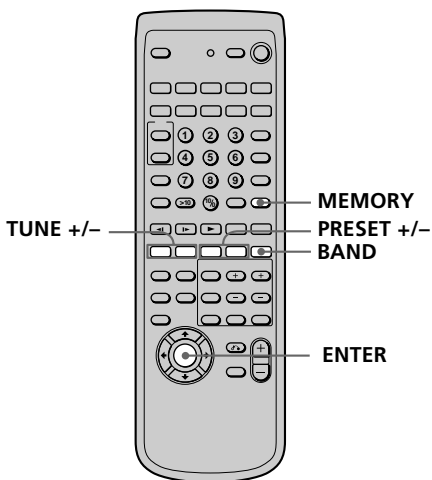

- 1 Press BAND repeatedly on the remote until the band you want appears on the front panel display.** Every time you press BAND, FM and AM changes alternately.

- 2 Press and hold TUNE + or – until the frequency indication starts to change, then release.** Scanning stops when the system tunes in a station. "TUNED" and "ST" (for stereo program) appear on the front panel display.

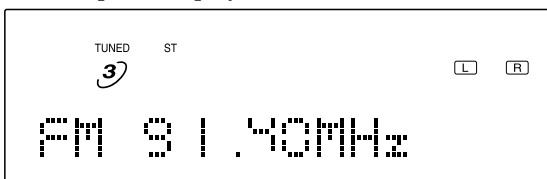

- 3 Press MEMORY.** A preset number appears on the front panel display.

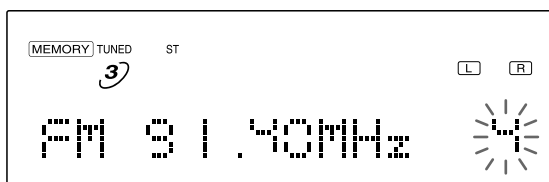

- 4 Press PRESET + or – to select the preset number you want.**



- 5 Press ENTER.** The station is stored.

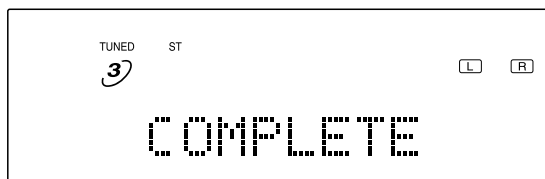

- 6 Repeat Steps 1 to 5 to store other stations.**

### To tune in a station with a weak signal

Press TUNE + or – repeatedly in Step 2 to tune in the station manually.

### To change the preset number

Start over from Step 1.

### To change the AM tuning interval

The AM tuning interval is factory set to 10 kHz. To change the AM tuning interval, tune in any AM station first, then turn off the power. While holding down the SUBWOOFER MODE button, turn the power back on. When you change the interval, AM preset stations will be erased. To reset the interval, repeat the same procedure.

# Playing Discs

This chapter describes how to play a DVD/CD/VIDEO CD.

You can playback all the discs (up to 5 discs) placed on the disc tray.

Press I/⏻ (power switch) to turn the system on.

## Playing Discs



Depending on the DVD or VIDEO CD, some operations may be different or restricted. Refer to the instructions supplied with your disc.

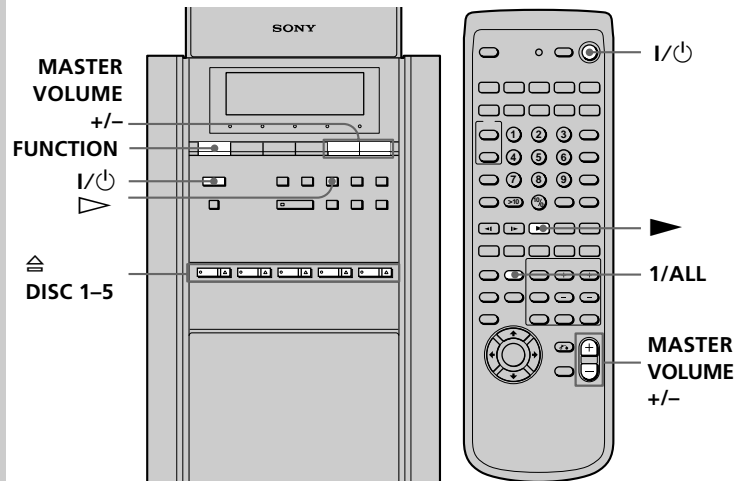

- 1** Press FUNCTION repeatedly until "DVD" appears on the front panel display or press DVD on the remote.
- 2** Press 1/ALL repeatedly on the remote to choose from "ALL DISCS" or "1DISC" on the front panel display.
- 3** Press one of ≡ of DISC 1-DISC 5, and place the disc on the disc tray.

With the playback side facing down

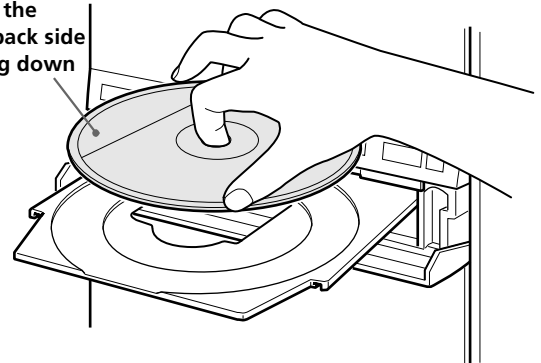

Press ≡ of the same disc tray number to close the disc tray. Press other ≡ of DISC 1-DISC 5 to place other discs.

#### 4 Press ▷.

The system starts playback (continuous play) of the disc whose disc tray indicator is green.

To start playback of another disc, press DISC 1–DISC 5 of the disc tray you want to playback.

#### After following Step 4

##### ■ When playing a DVD

A DVD menu or title menu may appear on the TV screen (see page 29).

##### ■ When playing a VIDEO CD

The menu screen may appear on the TV screen depending on the VIDEO CD. You can play the disc interactively, following the instructions on the menu screen. (PBC Playback, see page 30.)

#### 💡 On Auto-Function

If a disc is already placed on any disc tray, you can play it back simply by pressing the ▷ button or its corresponding DISC 1–DISC 5 button, even if the previous music source was not a DVD. The function changes to DVD and playback starts (Auto-Function). However, if Program Play is on, you can only start playback by pressing the ▷ button.

#### 💡 On the disc tray indicators

The disc tray indicators change their colors as follows:

- green: the disc tray is chosen, or the disc is being play backed.
- off: there is no disc.
- orange: a disc is placed on the disc tray, however, the disc tray is not chosen.

#### Notes

- If you leave the system in pause or stop mode for 15 minutes, the screen saver image appears automatically. To make the screen saver image go away, press ▷. (If you want to set the screen saver function to off, see page 53.)
- Do not push the disc tray when closing it. Press ⏏ to close the disc tray.
- If there is no disc in any disc tray, "NO DISC" appears on the front panel display.

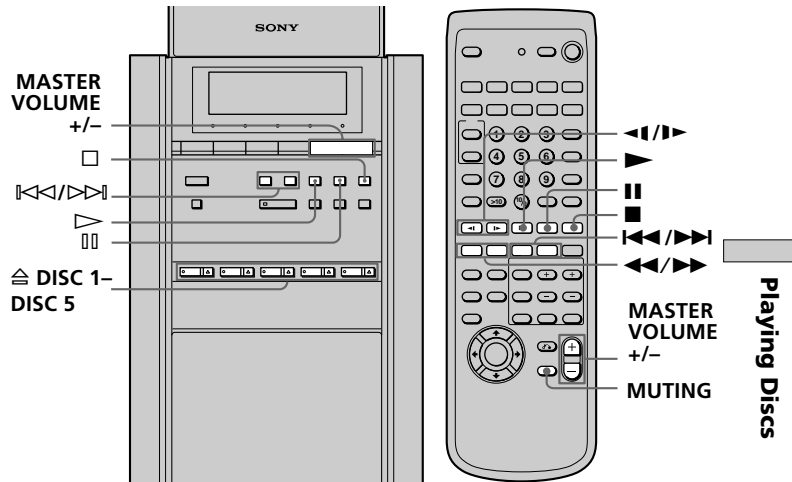

To	Operation
Adjust the volume	Press MASTER VOLUME +/-.
Stop	Press □.
Pause	Press ⏏.
Resume play after pause	Press ⏏ or ▷.
Locate a point quickly	Press ◀ or ▶ on the remote while playing a disc*. When you find the point you want, press ▶ to return to the normal speed.
Play in slow motion	Press ◀ or ▶ on the remote**. When you find the point you want, press ▶ to return to the normal speed.
Go to the next chapter, track or scene in continuous play mode	Press ▶▶.
Go back to the preceding chapter, track or scene in continuous play mode	Press ◀◀.
Mute the sound	Press MUTING on the remote. To cancel muting, press it again or turn up the volume.
Stop play and remove the disc	Press ⏏ of the disc you want to remove.
Change a disc while playing another disc	Press ⏏ of the disc you want to change. Change the disc, then press the same ⏏ to close the disc tray. The disc tray indicator flashes in orange during the change.

\* There is no sound while playing a VIDEO CD or a DVD.

\*\*Not available while playing a CD.

# Selecting a Sound Field

You can enjoy surround sound simply by selecting one of the pre-programmed sound fields according to the program you want to listen to.

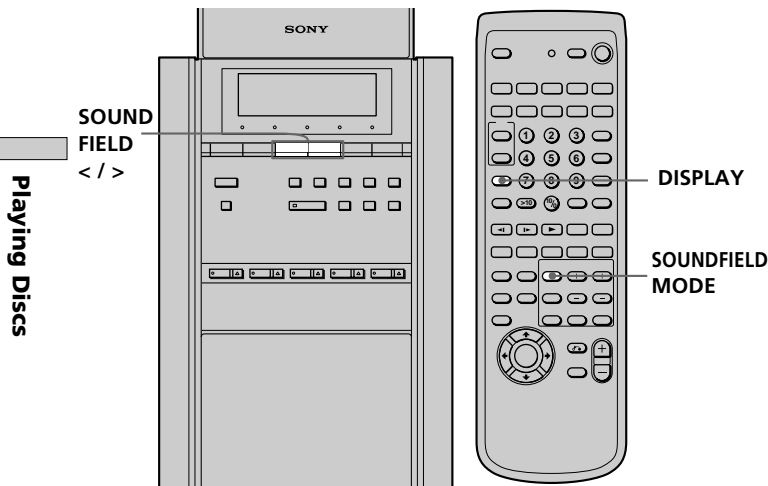

Press **SOUND FIELD </>** or **SOUNDFIELD MODE** on the remote to display the sound field you want.

See the table below for information on each sound field.

## To check the current sound field

Press **DISPLAY** repeatedly on the remote.

Each time you press **DISPLAY**, the front panel display switches:

remaining or playing time → DVD or CD TEXT\* → sound field → remaining or playing time

\* Available only when DVD TEXT or CD TEXT is provided on the DVD or CD.

## 💡 The system memorizes the last sound field selected for each program source (Sound Field Link)

Whenever you select a program source, the sound field that was last applied is automatically applied again. For example, if you listen to DVD with HALL as the sound field, change to a different program source, then return to DVD, HALL will be applied again. With the tuner, sound fields are memorized separately for all preset stations.

## 💡 You can identify the encoding format of program software by looking at its packaging

- Dolby Digital discs are labeled with the logo.
- Dolby Surround encoded programs are labeled with the logo.
- DTS Digital Surround discs are marked with DTS.

## Note

When you play sound tracks with 96 kHz sampling frequency, the output signals will be converted to 48 kHz (sampling frequency).

Sound field	Effect	Notes
A. F. D. (AUTO FORMAT DECODE)	Automatically detects the type of audio signal being input (Dolby Digital, DTS, Dolby Pro Logic, or standard 2 channel stereo) and performs the proper decoding if necessary. This mode presents the sound as it was recorded/encoded, without adding any effects.	You can use this mode as a reference.
NORM. SURROUND (NORMAL SURROUND)	Software with multi-channel surround audio signals is played according to the way it was recorded. Software with 2 channel audio signals, is decoded with Dolby Pro Logic to create surround effects.	
C. STUDIO A (CINEMA STUDIO A)	Reproduces the sound characteristics of the Sony Pictures Entertainment "Cary Grant Theater" cinema production studio.	This is a standard mode, great for watching most any type of movie.
C. STUDIO B (CINEMA STUDIO B)	Reproduces the sound characteristics of the Sony Pictures Entertainment "Kim Novak Theater" cinema production studio.	This mode is ideal for watching science-fiction or action movies with lots of sound effects.
C. STUDIO C (CINEMA STUDIO C)	Reproduces the sound characteristics of the Sony Pictures Entertainment scoring stage.	This mode is ideal for watching musicals or classic films where music is featured in the soundtrack.

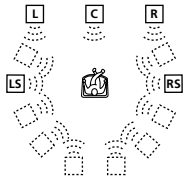
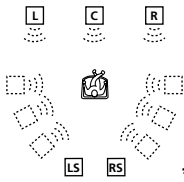
Sound field	Effect	Notes
V. MULTI. D. (VIRTUAL MULTI DIMENSION*)	Uses 3D sound imaging to create an array of virtual rear speakers positioned higher than the listener from a single pair of actual rear speakers. This mode creates 5 sets of virtual speakers surrounding the listener at approximately a 30° angle of elevation.	<div style="display: flex; align-items: center;"> <div style="margin-right: 20px;"><b>SIDE*</b></div>  </div> <div style="display: flex; align-items: center;"> <div style="margin-right: 20px;"><b>BEHIND*</b></div>  </div> <div style="text-align: right; margin-top: 10px;">* See page 16.</div>
HALL	Reproduces the acoustics of a rectangular concert hall.	Ideal for soft acoustic sounds.
JAZZ CLUB	Reproduces the acoustics of a jazz club.	
LIVE HOUSE	Reproduces the acoustics of a 300-seat live house.	Great for rock or pop music.
GAME	Obtains maximum audio impact from video game software.	Be sure to set the game machine to stereo mode when using game software with stereo sound capabilities.

\* "VIRTUAL" sound field: Sound field with virtual speakers.

**Note**









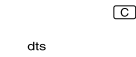

The effects provided by the virtual speakers may cause increased noise in the playback signal.

# Understanding the Multi-Channel Surround Displays

## Source sound displays

The letters (L, C, R, etc.) indicate the source sound. The boxes around the letters vary to show how the system downmixes the source sound (based on the speaker settings). When using music sound modes like HALL, the system adds reverberation based on the source sound.

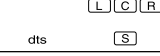
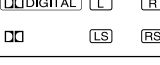
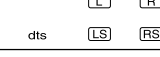
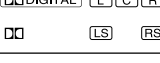
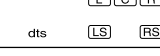
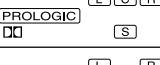
Although the table below shows almost all of the configurations available from multi-channel surround signals, the ones marked "☆" are the most common.

Recording Format (Front/ Rear)	Input Channel	Source Sound and Output Channel Display
1/0	DOLBY DIGITAL [1/0]	
	DTS [1/0]	
2/0*	DOLBY DIGITAL [2/0]	
	DTS [2/0]	
3/0	DOLBY DIGITAL [3/0]	
	DTS [3/0]	
2/1	DOLBY DIGITAL [2/1]	
	DTS [2/1]	
3/1	DOLBY DIGITAL [3/1]	
	DTS [3/1]	
2/2	DOLBY DIGITAL [2/2]	
	DTS [2/2]	
3/2	☆ DOLBY DIGITAL [3/2]	
	☆ DTS [3/2]	
2/0**	☆ DOLBY DIGITAL [2/0]	
PCM	☆ PCM XX kHz	

\* Signals with Dolby surround encoded flag OFF

\*\* Signals with Dolby surround encoded flag ON

## Notes

- The system performs Pro Logic decoding and the display conforms to 2/0\*\* when using the following movie sound modes with 2/0\*\* or STEREO PCM format signals. (C. STUDIO A, B, C, V. MULTI. D.)
- When using music sound modes like HALL with standard audio formats, like PCM, the system creates rear signals from the front L and R signals. However, a center speaker signal is not created. In this case, sound is output from the rear speakers, but output channel indicators for the rear speakers do not light.



# Customizing Sound Fields

By adjusting the surround parameters of the front, rear and center speakers, you can customize the sound fields to suit your particular listening situations.

Once you customize a sound field, the changes are stored in memory indefinitely (unless the system is unplugged for about a day). You can change a customized sound field any time by making new adjustments to the parameters.

See the table on page 28 for the parameters available in each sound field.

## To get the most from multi-channel surround sound

Position your speakers and do the procedures described in "Speaker Setup" starting on page 16 before you customize a sound field.

## Adjusting the level parameters

The level parameters let you adjust the balance and speaker volumes of each speaker. The settings available here are applied to all sound fields.

However, the parameters you have already adjusted in "Speaker Setup" on page 18 need not to be adjusted again to customize the sound fields.

- 1 Start playing a program source encoded with multi-channel surround sound.**
- 2 Press LEVEL.**
- 3 Sit at your listening position and select the item to be adjusted using the  $\uparrow/\downarrow$  buttons.**
- 4 Adjust the volume level using the  $\leftarrow/\rightarrow$  buttons.**  
The adjusted value will appear on the front panel display. If you do not operate the remote for a few seconds, the value turns off and is stored in the system.

### ■ BALANCE

You do not have to adjust here. See page 18.

### ■ LEVEL

You do not have to adjust here. See page 18.

### ■ LFE MIX (Low Frequency Effect mix level)

Initial setting: -4 dB

This parameter lets you attenuate the level of the LFE (Low Frequency Effect) channel output from the subwoofer without effecting the level of the bass frequencies sent to the subwoofer from the front, center, or rear channels via the Dolby Digital (AC-3) bass redirection circuitry.

- The level can be adjusted in 1 dB step from -20 dB to 0 dB (line level). 0 dB outputs the full LFE signal at the mix level determined by the recording engineer.
- Selecting MUTING mutes the sound of the LFE channel from the subwoofer. However, the low frequency sounds of the front, center, or rear speakers are output from the subwoofer.

Continued to the next page

### ■ dts LFE MIX

#### (dts Low Frequency Effect mix level)

Initial setting: 0 dB

This parameter lets you attenuate the level of the LFE (Low Frequency Effect) channel output from the subwoofer without effecting the level of the bass frequencies sent to the subwoofer from the front, center, or rear channels via the “dts” bass redirection circuitry.

- The level can be adjusted in 1 dB step from -20 dB to +10 dB (line level).
- Selecting MUTING mutes the sound of the LFE channel from the subwoofer. However, the low frequency sounds of the front, center, or rear speakers are output from the subwoofer.



#### About the level differences in the LFE MIX settings

The “dts LFE” level is set to +10 dB and “LFE MIX” (Dolby Digital) is set to 0 dB. This is because there is an initial difference of 10 dB in the overall mix between the Dolby Digital and dts LFE channel levels. Essentially, with the “dts LFE” level set to +10 dB and the “LFE MIX (Dolby Digital)” level set to 0 dB, approximately the same amounts of LFE channel signal are distributed to the other audio channels in the overall mix.

### ■ D.COMP. (Dynamic range compressor)

Initial setting: OFF

This parameter lets you compress the dynamic range of the sound track.

This may be useful when you want to watch movies at low volumes late at night.

- OFF reproduces the sound track with no compression.
- 0.1~ 0.9 allow you to compress the dynamic range in small steps to achieve the sound you desire.
- STD reproduces the sound track with the dynamic range intended by the recording engineer.
- MAX provides a dramatic compression of the dynamic range.

#### Note

Dynamic range compression is only possible with Dolby Digital sources.



#### About the Dynamic Range Compressor

This parameter allows you to compress the dynamic range of the soundtrack based on the dynamic range information included in the Dolby Digital signal. “STD” is standard compression, but because many sources have only light compression, you may not notice much difference when using 0.1~ 0.9.

Therefore, we recommend using the “MAX” setting. This greatly compresses the dynamic range and allows you to view movies late at night at low volumes. Unlike analog limiters, the levels are predetermined and provide a very natural compression.

## Adjusting the surround parameters

The surround parameters let you customize various aspects of the current sound field. The settings available here are stored individually for each sound field.

- 1 Start playing a program source encoded with multi-channel surround sound.
- 2 Press AMP MENU repeatedly on the remote to display <<SURROUND>> on the front panel display.
- 3 Sit at your listening position and select the item to be adjusted using the ↑/↓ buttons.
- 4 Adjust the volume level using the ←/→ buttons. The adjusted value will appear on the front panel display. If you do not operate the remote for a few seconds, the value turns off and is stored in the system.

### ■ EFFECT (Effect level)

Initial setting: (depends on sound mode)

This parameter lets you adjust the “presence” of the current surround effect.

### ■ WALL (Wall type)

Initial setting: center

When sound is reflected off soft materials, such as a curtain, the high frequency elements are reduced. A hard wall is highly reflective and does not significantly effect the frequency response of the reflected sound. This parameter lets you control the level of the high frequencies to alter the sonic character of your listening environment by simulating a softer (S) or harder (H) wall. The center position designates a neutral wall (made of wood).

### ■ REVB. (Reverberation)

Initial setting: center

Before sound reaches our ears, it is reflected (reverberated) many times between the left and right walls, ceiling, and floor. In a large room, sound takes more time to bounce from one surface to another than in a smaller room. This parameter lets you control the spacing of the early reflections to simulate a sonically longer (L) or shorter (S) room.

- The reverberation can be adjusted  $\pm 6$  from S (short, -6) to L (long, +6) in 13 steps.
- The center position (0) designates a standard room with no adjustment.

## Adjusting the equalizing parameters

You can adjust the bass and treble levels and select the subwoofer mode. The settings available here are stored individually for each sound field.

### To adjust the bass and treble levels

Press BASS +/- or TREBLE +/- repeatedly on the remote. The levels change between -5 and +5.

### To adjust the subwoofer mode

Press S.WOOFER MODE repeatedly on the remote to display the desired mode on the front panel display.

- SUB WOOFER 1: produces a powerful bass sound that is ideal for movies.
- SUB WOOFER 2: provides more subtle effects suitable for music.
- OFF: mutes the sound from the subwoofer.

### Note

The subwoofer mode enhances the bass sound. However, you may not notice much difference depending on the program source.

## Resetting the customized settings

You can reset all the customized settings to the factory preset settings except for the settings made in the control menu display (page 36) or setup display (page 49).

- 1** Press AMP MENU repeatedly on the remote to display <<CUSTOMIZE>> on the front panel display.
- 2** Select "MEMORY CLEAR N" (N:No) using the ↑/↓ buttons.
- 3** Select "MEMORY CLEAR Y" (Y:Yes) using the ←/→ buttons, then press ENTER.  
"Are you sure?N" appears on the front panel display.
- 4** Select "Are you sure?Y" using the ←/→ buttons, then press ENTER.  
"ALL CLEAR!" appears on the front panel display and all the customized settings for the sound fields are reset to the default ones.



You can change the dimmer level of the front panel display in the <<CUSTOMIZE>> menu. See page 33.

### Note

This operation resets the preset radio stations, too.

Continued to the next page

# Customizing Sound Fields

## Adjustable parameters for each sound field

	<<LEVEL>>*							<<SURROUND>>			BASS	TREBLE	S.W. MODE
	FRONT BAL.	REAR BAL.	REAR LEVEL	CENTER LEVEL	WOOFER LEVEL	(dts) LFE** MIX	D. COMP.	EFFECT LEVEL	WALL TYPE	REVERB TIME			
AUTO FORMAT DECODE	●	●	●	●	●	●	●				●	●	●
NORMAL SURROUND	●	●	●	●	●	●	●				●	●	●
CINEMA STUDIO A	●	●	●	●	●	●	●	●			●	●	●
CINEMA STUDIO B	●	●	●	●	●	●	●	●			●	●	●
CINEMA STUDIO C	●	●	●	●	●	●	●	●			●	●	●
VIRTUAL MULTI DIMENSION	●	●	●	●	●	●	●				●	●	●
HALL	●	●	●	●	●	●	●	●	●	●	●	●	●
JAZZ CLUB	●	●	●	●	●	●	●	●	●	●	●	●	●
LIVE HOUSE	●	●	●	●	●	●	●	●	●	●	●	●	●
GAME	●	●	●	●	●	●	●	●	●	●	●	●	●



\* If you change an item in <<LEVEL>>, the changes apply to all sound fields.

\*\*The sound field of which you can change the "dts LFE" setting depends on the source.

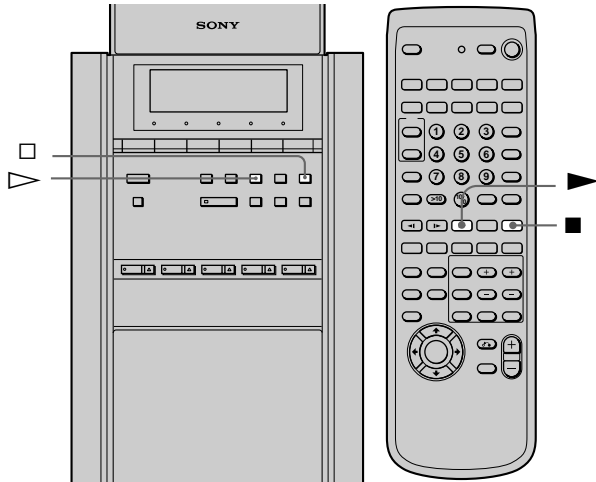

## Resuming Playback from the Point Where You Stopped the Disc (Resume Play)

The system stores the point where you stopped the disc, and when "RESUME" appears on the front panel display, you can resume playback from that point. As long as you do not open the disc tray, Resume Play is available even if you turn the power off.



- 1 While playing a disc, press  to stop playback.**  
"RESUME" appears in the front panel display and "When playing next time, disc restarts from point you stopped. To start from beginning, press  again" appears on the TV screen. If "RESUME" does not appear, Resume Play is not available.
- 2 Press .**  
The system starts playback from the point where you stopped the disc in Step 1.

### To play from the beginning of the disc

When the playing time appears on the front panel display before you start playing, press  again to reset the playing time, then press .

#### Notes





- Resume Play may not be available depending on the DVD.
- Resume Play is not available in Shuffle or Program Play mode.
- Depending on where you stopped the disc, the system may resume playback from a different point.
- The point where you stopped playing is cleared when:
  - you open or close the disc tray
  - you disconnect the AC power cord
  - you change the play mode
  - you start playback after selecting a title, chapter or track
  - you change the settings of "TV TYPE" in "SCREEN SETUP" in the setup display
  - you change the settings of "PARENTAL CONTROL" in "CUSTOM SETUP" in the setup display

## Using the Menu for Each DVD

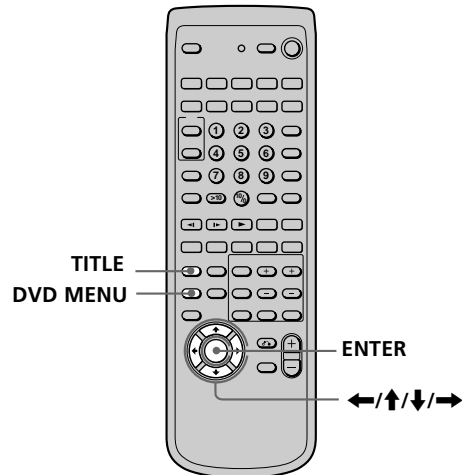
### Using the title menu

A DVD is divided into long sections of a picture or a music piece called "titles." When you play a DVD which contains several titles, you can select the title you want using the title menu.



- 1 Press TITLE on the remote.**  
The title menu appears on the TV screen. The contents of the menu vary from disc to disc.
- 2 Press , , , or  to select the title you want to play.**  
Depending on the disc, you can use the number buttons to select the title.
- 3 Press ENTER.**  
The system starts playing the selected title.

#### Notes

- Depending on the DVD, you may not be able to select the title.
- Depending on the DVD, a "title menu" may simply be called a "menu" or "title" in the instructions supplied with the disc. "Press ENTER." may also be expressed as "Press SELECT."

Continued to the next page

## Using the Menu for Each DVD

### Using the DVD menu

Some DVDs allow you to select the disc contents using the menu. When you play these DVDs, you can select the language for the subtitles, the language for the sound, etc., using the DVD menu.

- 1 Press DVD MENU on the remote.**  
The DVD menu appears on the TV screen. The contents of the menu vary from disc to disc.
- 2 Press ←/↑/↓/→ to select the item you want to change.**  
Depending on the disc, you can use the number buttons to select the item.
- 3 To change other items, repeat Step 2.**
- 4 Press ENTER.**



**If you want to select the language for the DVD menu**  
Change the setting using "LANGUAGE SETUP" in the setup display. For details, see page 52.

#### Note

Depending on the DVD, a "DVD menu" may simply be called a "menu" in the instructions supplied with the disc.

## Playing VIDEO CDs with PBC Functions (PBC Playback)

When playing VIDEO CDs with PBC functions (Ver. 2.0 discs), you can enjoy simple interactive operations, operations with search functions, etc.

PBC Playback allows you to play VIDEO CDs interactively, following the menu screen on the TV screen. You can use the number buttons, ENTER, ⏪/⏩, ⏮/⏭, and ↻RETURN buttons during PBC Playback.

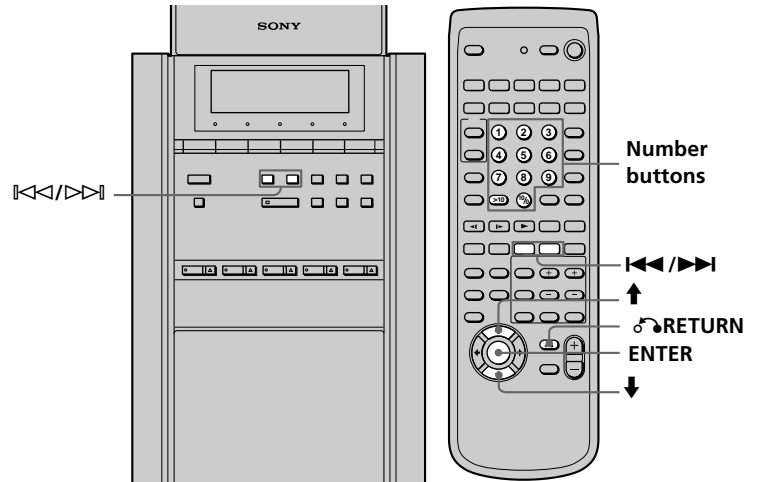

- 1 Start playing a VIDEO CD with PBC functions, following Steps 1 to 4 in "Playing Discs" on page 20.**
- 2 Press the number button or ↑/↓ on the remote of the item you want.**
- 3 Press ENTER.**
- 4 Follow the instructions on the menu screen for interactive operations.**  
Refer to the instructions supplied with the disc, as the operating procedure may differ according to the VIDEO CD.

### Going back to the menu screen

Press RETURN on the remote.

### 💡 When playing VIDEO CDs with PBC functions

PBC playback starts automatically.

### 💡 To cancel PBC playback of a VIDEO CD with PBC functions and play the disc in Continuous Play mode

There are two ways.

- Before you start playing, select the track you want using the or buttons, then press ENTER or .
- Before you start playing, select the track number using the number buttons on the remote, then press ENTER or . "Play without PBC" appears on the TV screen and the system starts Continuous Play. You cannot play still pictures such as a menu screen. To return to PBC playback, press twice then press .

### Note

Depending on the VIDEO CD, "Press ENTER." in Step 3 may be expressed as "Press SELECT." in the instructions supplied with the disc.

## Creating Your Own Program (Program Play)



You can play the contents of the disc in the order you want by arranging the order of the titles, chapters or tracks on the disc and create your own program. One program can be restored in the system and contain up to 25 steps of titles, chapters and tracks.

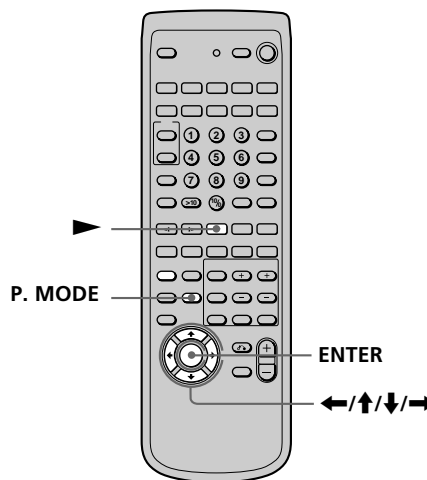

- 1 While in stop mode, press P. MODE on the remote repeatedly until "PGM" appears on the front panel display.**

The programming display appears on the TV screen.

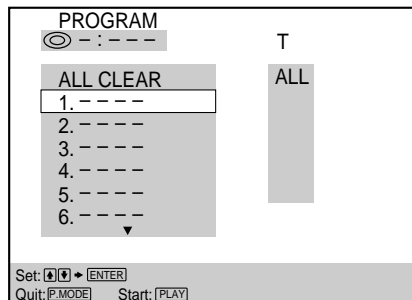

- 2 Press ENTER.**

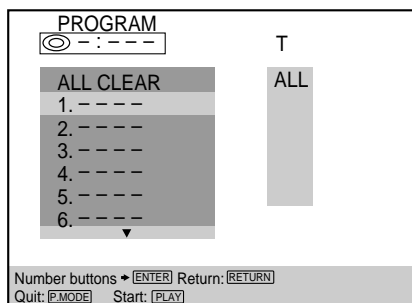

Continued to the next page

## Creating Your Own Program (Program Play)

- 3** Press the number buttons or  $\uparrow/\downarrow$  buttons to select the disc, then press ENTER.

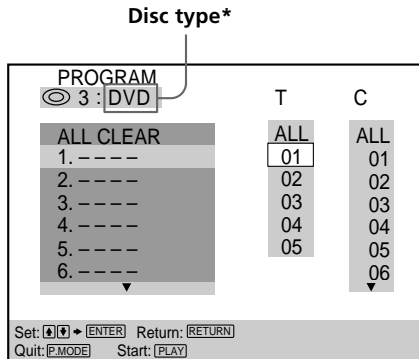

\* "?" appears when the player has not loaded the disc information in the memory.

- 4** Select the title, chapter or track you want to program using the  $\uparrow/\downarrow$  buttons, then press ENTER.

For example, select title 1, chapter 2 in disc 3. (You can also use the number buttons and ENTER button to select. In this case, the selected number is displayed on the screen.)

### When playing a DVD

When both titles and chapters are recorded on the disc, select the title, then the chapter.

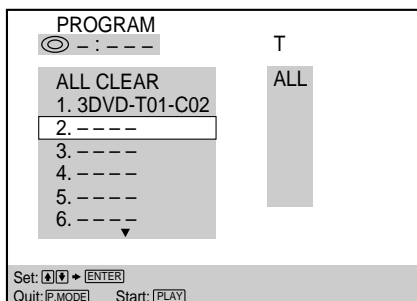
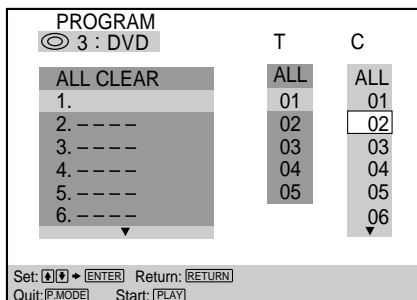

### When playing a VIDEO CD or CD

Select the track you want to program.

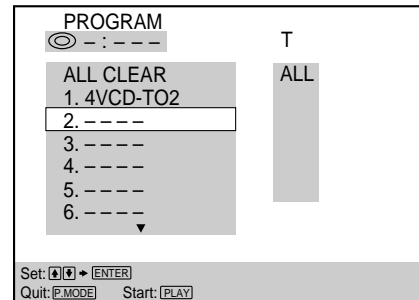

- 5** To program other discs, titles, chapters or tracks, repeat Steps 3 and 4.

The programmed discs, titles, chapters or tracks are displayed from 2 in order.

- 6** Press  $\blacktriangleright$  to start Program Play.

### To return to the previous item

If you are selecting a disc, title, track or chapter, press  $\curvearrowright$  RETURN to return to the previous item.

### To cancel Program Play

Press CLEAR on the remote.

### To cancel programming

Press P.MODE.

### To change programming

To change the disc, select the program number you want to change using the  $\uparrow/\downarrow$  buttons after Step 1 or 4, then press ENTER. Then do Steps 3 and 4.

To change the title, chapter and track, select the desired one in Step 4.

### To cancel the programmed order

To cancel all the titles, chapters or tracks in the programmed order, select "ALL CLEAR" after Steps 1 or 4, then press ENTER.

To cancel the selected program, select the program using the  $\uparrow/\downarrow$  buttons after Step 1 or 4, then press CLEAR.

### The program remains even after the Program Play ends

When you press  $\blacktriangleright$  on the remote, you can play the same program again.

### You can do Repeat Play of the programmed titles, chapters or tracks

During Program Play, set "REPEAT" to "ON" in the Control Menu display.

### Notes

- The number of titles, chapters or tracks recorded on a disc is displayed.
- The contents of the program are canceled when:
  - you turn the power off
  - you change the function
- You may not be able to do Program Play depending on the DVD.



## Playing in Random Order (Shuffle Play)



The system "shuffles" titles or tracks and plays them in a random order. The playing order may differ from the previous "shuffling."

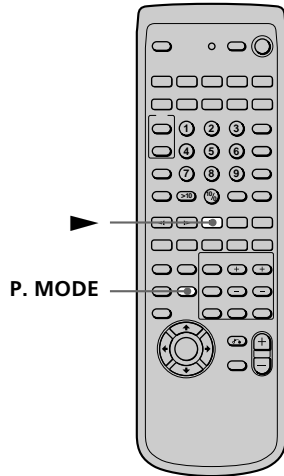

**1** While in stop mode, press **P. MODE** on the remote repeatedly until "SHUF" appears on the front panel display.

**2** Press **▶**.

To cancel Shuffle Play, press **CLEAR** on the remote.

### Note

You may not be able to do Shuffle Play depending on the DVD.

## Using the Front Panel Display



You can check information about the disc, such as the total number of the titles or the tracks or remaining time, using the front panel display.

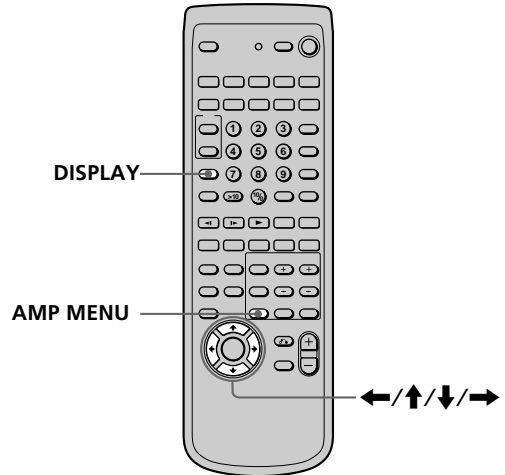

### To change the dimmer level of the front panel display

- 1 Press **AMP MENU** repeatedly on the remote to display <<CUSTOMIZE>> on the front panel display.
- 2 Select "DISPLAY DIMMER" using the **↑/↓** buttons.
- 3 Press **←/→** repeatedly to adjust the dimmer level. The brightness of the message "DISPLAY DIMMER" changes as follows:  
High → Low → Off ("DISPLAY OFF" appears)

## When playing back a DVD

### Display information while playing the disc

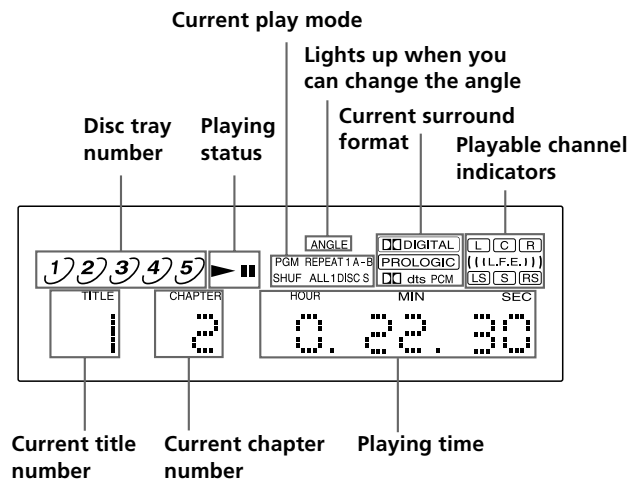

Continued to the next page

## Using the Front Panel Display

### Checking the remaining time

Press DISPLAY.

Each time you press the DISPLAY button while playing the disc, the display changes as shown in the following chart.

#### Playing time and number of the current chapter

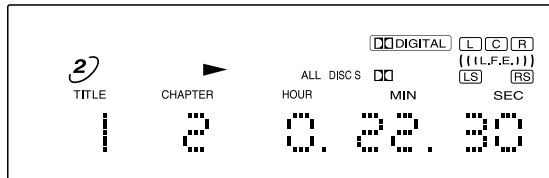

Press DISPLAY.

#### Remaining time of the current chapter

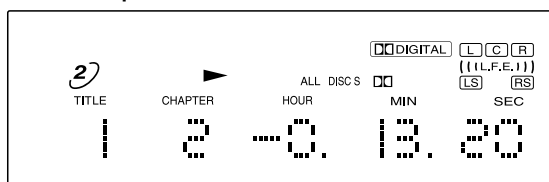

Press DISPLAY.

#### Playing time and number of the current title

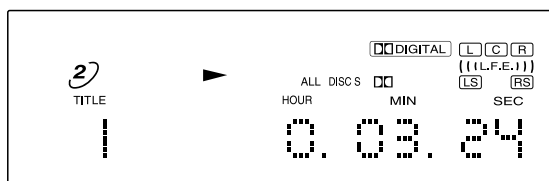

Press DISPLAY.

#### Remaining time of the current title

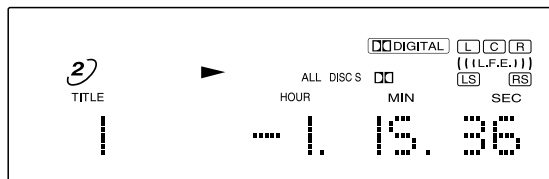

Press DISPLAY.

DVD TEXT\*

#### Sound field

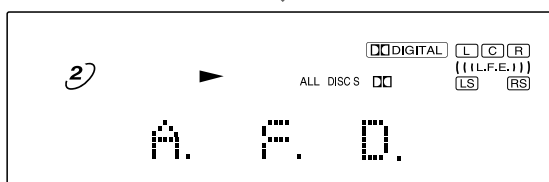

Press DISPLAY.

\* Only when DVD TEXT is available on the DVD. If there is no DVD TEXT, "NO TEXT" is displayed.

### Notes

- Depending on the DVD, the chapter number or time may not appear or you may not be able to change the front panel display.
- While you are doing Shuffle Play or Program Play, the playing time of the title and the remaining time of the title are not displayed.

### When playing back a CD/VIDEO CD



#### Display information while playing a disc

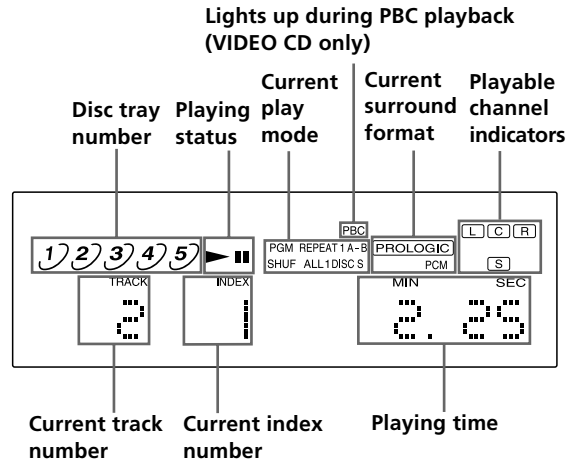

#### When playing VIDEO CDs with PBC functions

The track number, index number and playing time may not appear. In this case, the remaining time and playing time of the disc are not displayed.

### Checking the remaining time

Press DISPLAY on the remote.

Each time you press the DISPLAY button while playing a disc, the display changes as shown in the following chart.

#### Playing time and number of the current track

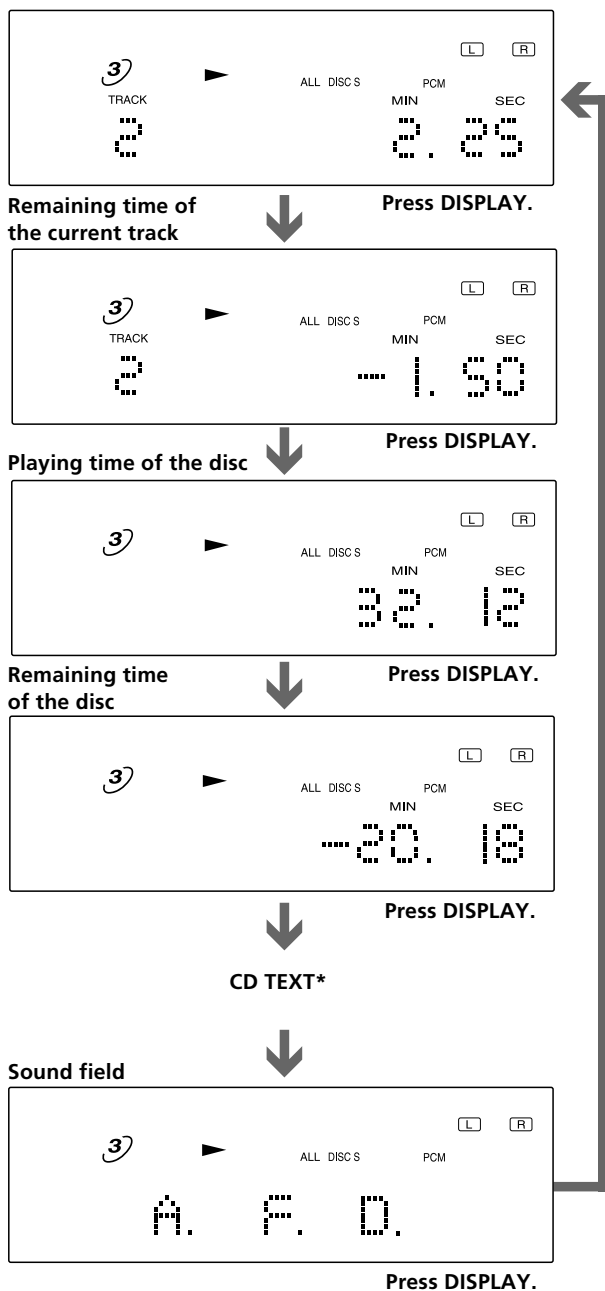

\* Only when CD TEXT is available on the CD. If there is no CD TEXT, "NO TEXT" is displayed.

#### Notes

While you are doing Shuffle Play, Program Play, or PBC playback, the playing time of the disc and the remaining time of the disc are not displayed.



- 2** Select the item you want using the **↑/↓** buttons, then press **⇒** or **ENTER**.

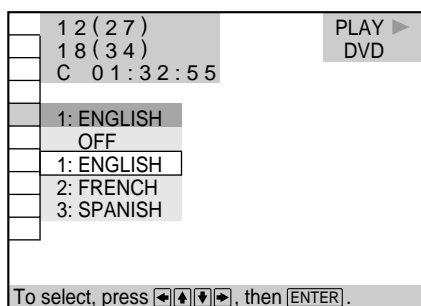
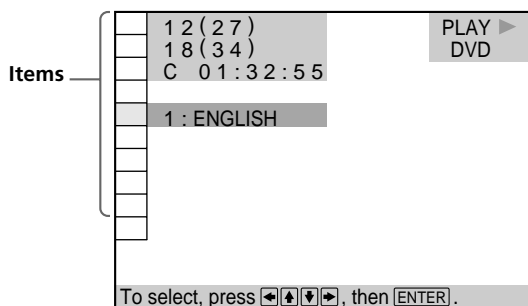

- 3** Select the item you want using the **↑/↓** buttons, then press **ENTER**.

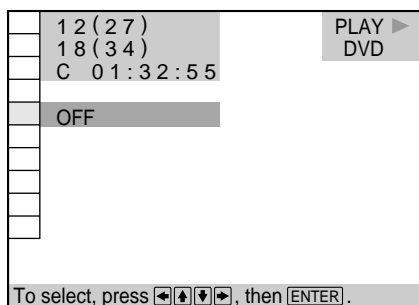
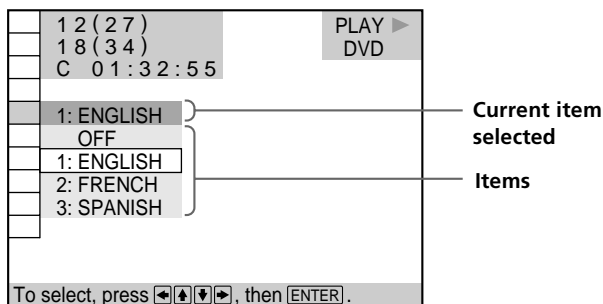

#### Note

Some Control Menu display items require operations other than selecting the setting. For details on these items, see the relevant pages.

#### To cancel using the Control Menu display

Press **⇐RETURN** on the remote.

#### To display other items

Each time you press **DVD DISPLAY** on the remote, the Control Menu display changes as follows:

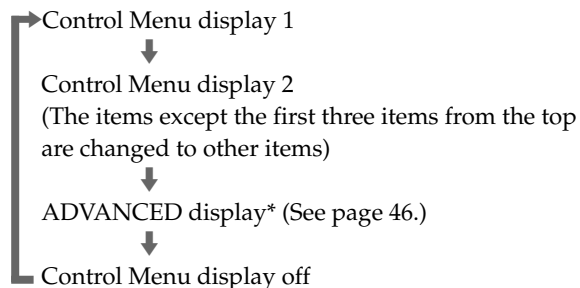

\* Only while playing a DVD.

#### 💡 You can display some items using the remote

Some items can be displayed by pressing the button of the remote. In this case, only the item you selected is displayed. For the item and operations using the remote, see the pages of each item.

# Control Menu Item List

**TITLE (DVD only) (page 39)**

**CHAPTER (DVD only) (page 39)**

**TRACK (VIDEO CD/CD only) (page 39)**

**SCENE (VIDEO CD during PBC playback only) (page 39)**

**INDEX (VIDEO CD/CD only) (page 39)**  
You can search by selecting the title/chapter/track/index/scene.

**TIME/TEXT (page 40)**  
You can check the playing time and remaining time of the current title/chapter/track and the total remaining time of the disc.

You can search by inputting the time code.  
You can check the DVD TEXT or CD TEXT of the disc on the TV screen and the front panel display.

**AUDIO (page 41)**  
With DVDs recorded with multilingual sounds, you can select the language you want while playing the DVD.  
With multiplex CDs or VIDEO CDs, you can select the sound from the right or left channel and listen to the sound of the selected channel through both the right and left speakers.

**SUBTITLE (DVD only) (page 43)**  
With DVDs on which multilingual subtitles are recorded, you can change the subtitle language whenever you want while playing the DVD, and turn it on or off whenever you want.

**ANGLE (DVD only) (page 43)**  
With DVDs on which various angles (multi-angles) are recorded, you can change the angles on the scene for which multi-angles are recorded.

**1/ALL DISCS (page 44)**  
Select the 1 DISC play mode or ALL DISCS play mode to set Shuffle Play and Repeat Play.

**REPEAT (page 45)**  
You can play all the titles/tracks on a disc or a single title/chapter/track repeatedly.

**A-B REPEAT (page 45)**  
You can play a specific portion of a title, chapter, or track repeatedly.

**ADVANCED (DVD only) (page 46)**

You can check the play information about the bit rate, bit rate history or the position where the disc is played (layer).

**ANGLE VIEWER (DVD only) (page 47)**

With DVDs on which various angles (multi-angles) for a scene are recorded, you can display all the angles recorded on the disc on the same screen, and start playback in continuous mode at the chosen angle directly.

**STROBE PLAYBACK (DVD/ VIDEO CD only) (page 48)**

You can display 9 consecutive sections of the disc on the TV screen. In this case, the sections show still images.

**TITLE VIEWER (DVD only) (page 48)**

**CHAPTER VIEWER (DVD only) (page 48)**

**TRACK VIEWER (VIDEO CD only) (page 48)**  
You can check the titles, chapters and tracks of the disc on the TV screen divided in 9 sections, and start playback from the chosen title, chapter or track.

# Searching for the Title/Chapter/Track/Index/Scene



You can search by selecting the title/chapter/track/index/scene.

Select "TITLE," "CHAPTER," "TRACK," "INDEX" or "SCENE" after pressing the DVD DISPLAY button on the remote.

When you play back a DVD, "TITLE" and "CHAPTER" are displayed.

When you play back a VIDEO CD/CD, "TRACK" and "INDEX" are displayed. When you play back a VIDEO CD with PBC functions, "SCENE" is displayed.

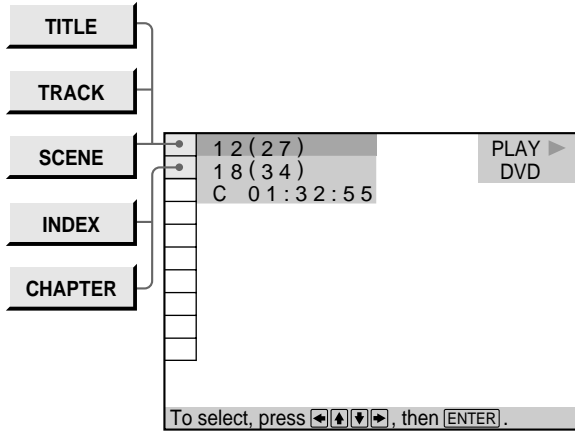

## 1 Select "TITLE," "CHAPTER," "TRACK," "INDEX" or "SCENE" using the ↑/↓ buttons.

"\*\* (\*\*)" is highlighted. (\*\* means optional number in this manual.) The number in parentheses indicates the total number of titles, chapters, tracks, indexes or scenes.

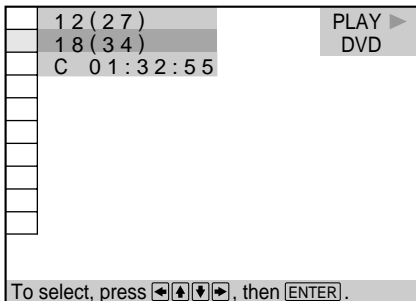

## 2 Press → or ENTER on the remote.

"\*\* (\*\*)" is changed to "-- (\*\*)."

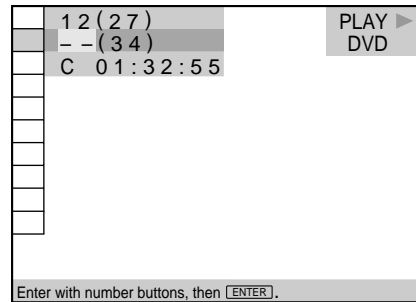

## 3 Select the number of the title, chapter, track, index or scene you want to search for using the number buttons, then press ENTER.

The system starts searching. To cancel the number, press CLEAR before pressing the ENTER button.

### To cancel selecting

Press ↵ RETURN on the remote.

### Notes

- The number of titles, chapters or tracks recorded on a disc is displayed.
- The index numbers are not displayed during PBC playback of VIDEO CDs.

## Checking the Playing Time and Remaining Time



You can check the playing time and remaining time of the current title/chapter/track and the total remaining time of the disc.

Select "TIME/TEXT" after pressing the DVD DISPLAY button on the remote to change the time information.

You can also check the DVD TEXT and CD TEXT (see page 41).

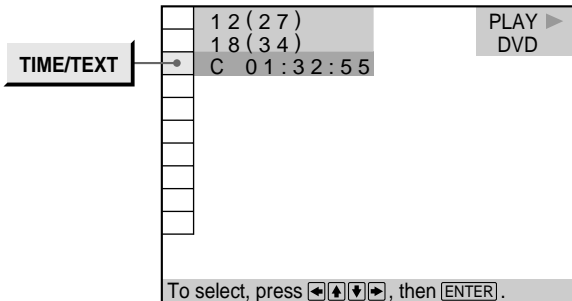

### When playing a DVD

#### ■ TIME

- C \* \* \* \* \* : Playing time of the current chapter
- C - \* \* \* \* \* : Remaining time of the current chapter
- T \* \* \* \* \* : Playing time of the current title
- T - \* \* \* \* \* : Remaining time of the current title

### When playing a VIDEO CD (during PBC playback)

#### ■ TIME

- \* \* \* \* \* : Playing time of the current scene

### When playing a VIDEO CD (in Continuous play) or CD

#### ■ TIME

- T \* \* \* \* \* : Playing time of the current track
- T - \* \* \* \* \* : Remaining time of the current track
- D \* \* \* \* \* : Playing time of the current disc
- D - \* \* \* \* \* : Remaining time of the current disc

#### 💡 You can display the "TIME/TEXT" display quickly

Press DISPLAY on the remote. Each time you press the button, the time information changes.

## Selecting a Start Point Using the Time Code



You can search by inputting the time code.

Select "TIME/TEXT" after pressing the DVD DISPLAY button on the remote.

The time code corresponds to the approximate actual playing time. For example, to search for a scene 2 hours 30 minutes 20 seconds past the beginning, input 2:30:20.

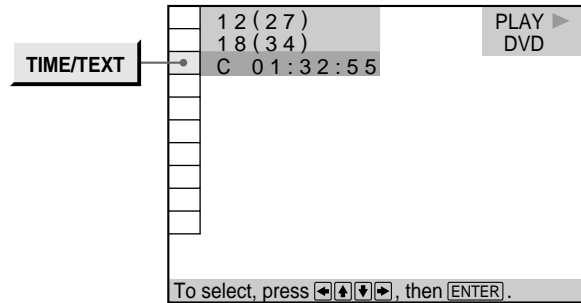

- 1 Select "C \* \* \* \* \* : \* \* \*" (playing time of the current chapter).

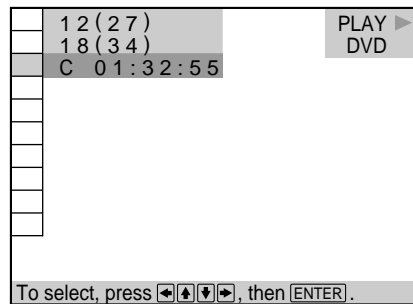

- 2 Press → or ENTER on the remote.

Time code changes to "T -- : -- : --".

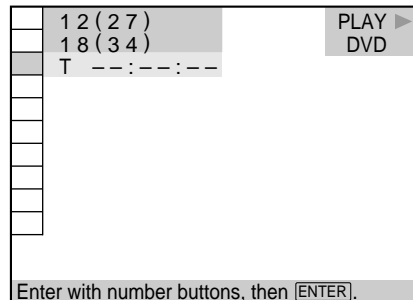

- 3 Input the time code using the number buttons, then press ENTER.

The system starts searching. To cancel the number, press CLEAR before pressing the ENTER button.

### To cancel inputting

Press ↵ RETURN on the remote.

### Note

When you input the time code, input the playing time of the title.



## Checking the Information of the Disc



You can check the DVD TEXT or CD TEXT of the disc on the TV screen and the front panel display. DVD TEXT and CD TEXT are information recorded on the disc which you cannot change. Press DISPLAY repeatedly on the remote to display the DVD/CD TEXT. The information is displayed at the bottom of the display.

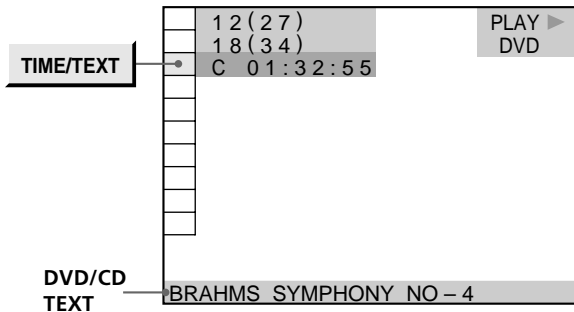

You can display "TIME/TEXT" display using the remote. Press DISPLAY until the DVD/CD TEXT is displayed.

### Note

The DVD/CD TEXT is displayed only in English.

## Changing the Sounds



With DVDs recorded with multilingual sounds, you can select the language you want while playing the DVD. With multiplex CDs or VIDEO CDs, you can select the sound from the right or left channel and listen to the sound of the selected channel through both the right and left speakers. In this case, the sound loses the stereo effect. For example, with a disc containing a song, the right channel may output the vocals and the left channel may output the instrumental. If you only want to hear the instrumental, you can select the left channel and hear it from both speakers. Select "AUDIO" after pressing the DVD DISPLAY button on the remote.

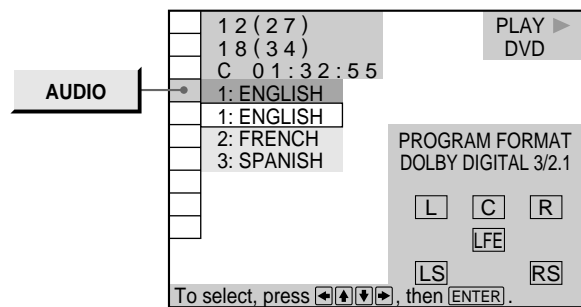

### AUDIO

#### When playing a DVD

Select the language. The languages you can select are different depending on the DVD. When 4 digits are displayed, they represent the language code. Select the language code from the list on page 73.

#### When playing a VIDEO CD or a CD

- STEREO : The standard stereo sound
- 1/L : The sound of the left channel (monaural)
- 2/R : The sound of the right channel (monaural)

You can display the "AUDIO" display quickly

Press AUDIO on the remote.

### Notes

- Depending on the DVD, you may not be able to change the languages even if multilingual sounds are recorded on the DVD.
- While playing the CD/VIDEO CD, the standard stereo playback will be resumed when:
  - you open or close the disc tray
  - you turn the power off
- While playing the DVD, the sound may be changed when:
  - you open or close the disc tray
  - you change the title
- If the language is displayed as a 4 digit number, refer to the language code list on page 73.

Continued to the next page

## Changing the Sounds

### Displaying the audio information of the disc **DVD**

When you select "AUDIO," the playing channels are displayed on the screen.

In Dolby Digital format, the signals from monaural to 5.1 channels can be recorded on a DVD. Depending on the DVD the number of the recorded channels may be different.

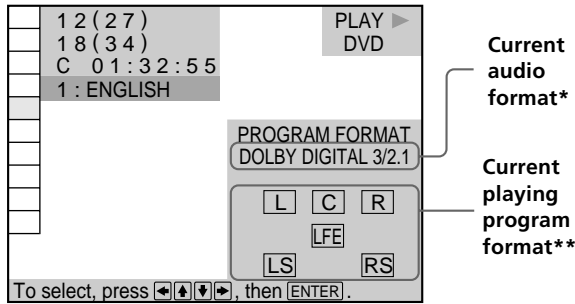

Current audio format\*

Current playing program format\*\*

\* "PCM," "DTS" or "DOLBY DIGITAL" is displayed. In "DOLBY DIGITAL" case, the channels in the playing track are displayed by number as follows:

The case of Dolby Digital (AC-3) 5.1 ch:

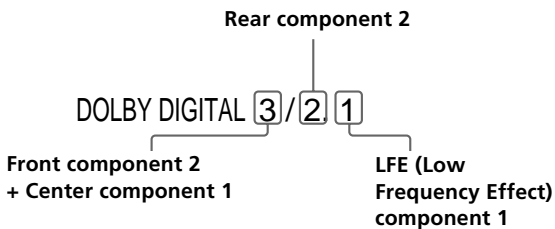

\*\* The letters in the program format display mean the following:

- L: Front (L)
- R: Front (R)
- C: Center (monaural)
- LS: Rear (L)
- S: Rear (monaural) – the rear component of the Dolby Surround processed stereo signal and the Dolby Digital signal
- RS: Rear (R)
- LFE: LFE (Low Frequency Effect)

The display examples are as follows:

•PCM (stereo)

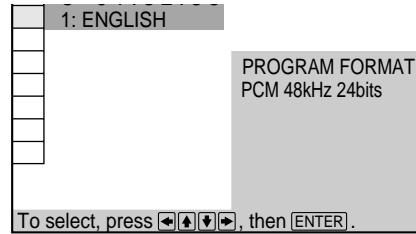

•Dolby Surround

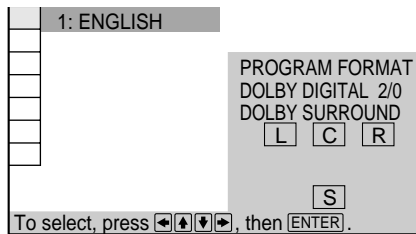

•Dolby Digital 5.1 ch

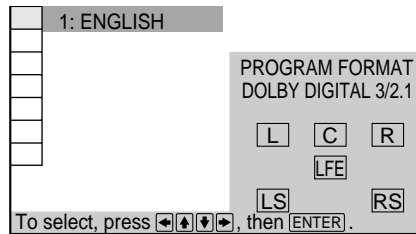

•DTS

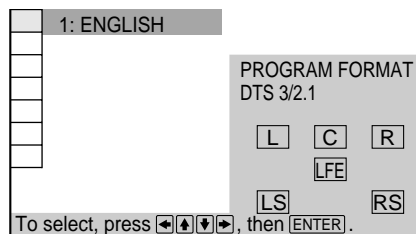

**💡 You can find Dolby Surround-encoded software by looking at the packaging**

Use discs with the  logo. In order to enjoy Dolby Digital playback you must use discs bearing this logo.

## Displaying the Subtitles



With DVDs on which subtitles are recorded, you can turn the subtitles on and off whenever you want while playing the DVD.

With DVDs on which multilingual subtitles are recorded, you can change the subtitle language whenever you want while playing the DVD, and turn it on or off whenever you want. For example, you can select the language you want to master and turn the subtitles on for better understanding.

Select "SUBTITLE" after pressing the DVD DISPLAY button on the remote.

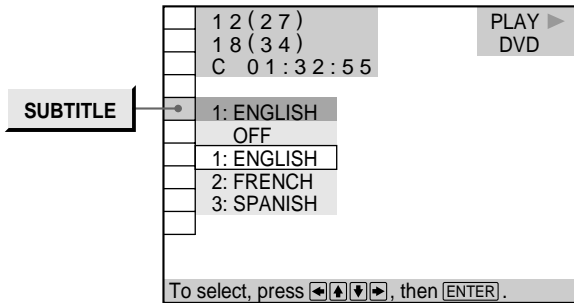

### ■ SUBTITLE

Select the language. The languages you can select are different depending on the DVD. When 4 digits are displayed, they indicate the language code. Select the language code from the list on page 73.

#### 💡 You can display the "SUBTITLE" display quickly

Press SUBTITLE on the remote. Each time you press the button, the item changes.

### Notes

- When playing a DVD on which no subtitles are recorded, no subtitles appear.
- Depending on the DVD, you may not be able to turn the subtitles on even if they are recorded on it.
- Depending on the DVD, you may not be able to turn the subtitles off.
- If the language is displayed as a 4-digit number, refer to the language code list on page 73.
- The type and number of languages for subtitles vary from disc to disc.
- Depending on the DVD, you may not be able to change the subtitles even if multilingual subtitles are recorded on it.
- While playing the DVD, the subtitle may change when:
  - you open or close the disc tray
  - you change the title

## Changing the Angles



With DVDs on which various angles (multi-angles) for a scene are recorded, you can change the angles. For example, while playing a scene of a train in motion, you can display the view from either the front of the train, the left window of the train or from the right window without having the train's movement interrupted.

Select "ANGLE" after pressing the DVD DISPLAY button on the remote. When the angles can be changed, the indicator of the "ANGLE" lights in green.

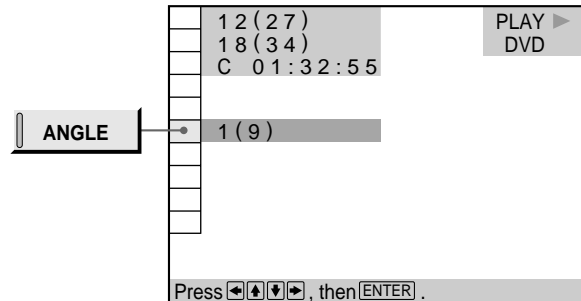

### 1 Select "ANGLE."

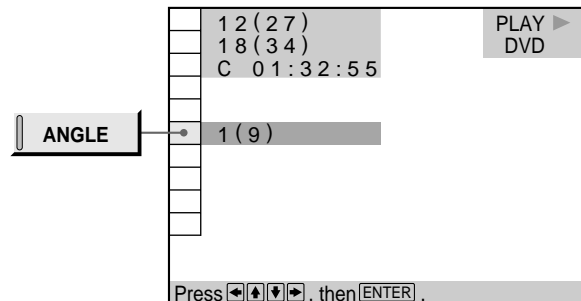

### 2 Press → on the remote.

The number of the angle changes to "–." The number in parentheses indicates the total number of angles.

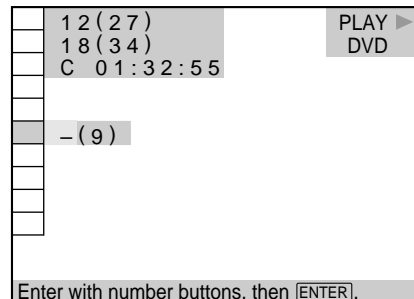

Continued to the next page

## Changing the Angles

- 3** Select the number of the angles using the number buttons or the **↑/↓** buttons, then press **ENTER**.

The angle is changed to the selected angle.

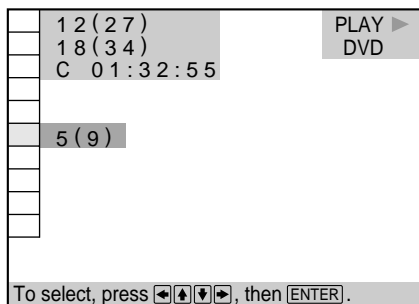

### Notes

- The number of angles varies from disc to disc or from scene to scene. The number of angles that can be changed on a scene is that of angles recorded for that scene.
- Depending on the DVD, you may not be able to change the angles even if multi-angles are recorded on the DVD.

#### You can specify the angle beforehand

Specify the angle when "ANGLE" is not displayed on the front panel display. When a scene on which multi-angles are recorded comes, the angle is automatically selected.

#### You can select the angle directly

Press ANGLE on the remote. Each time you press the button, the angle changes.

## Selecting the Disc Mode (1 Disc or All Discs)



Before setting Program Play, Shuffle Play, or Repeat Play, you need select whether to set those play modes on one disc or all discs.

Select "1/ALL DISCS" after pressing the DVD DISPLAY button on the remote.

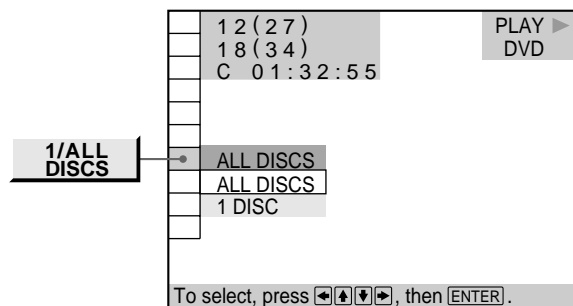

### ■ 1/ALL DISCS

- ALL DISCS: allows you to set Program Play, Shuffle Play or Repeat Play for all the discs.
- 1 DISC: allows you to set Shuffle Play or Repeat Play for 1 disc only.

#### You can select the mode using the button on the remote

Press 1/ALL DISCS. Each time you press the button, 1 DISC or ALL DISCS mode is selected.

## Playing Repeatedly (Repeat Play)



You can play all the titles/tracks on a disc or a single title/ chapter/track.

In Shuffle or Program Play mode, the system repeats the titles or tracks in the shuffled or programmed order. You cannot do Repeat Play during PBC playback of VIDEO CDs (page 30).

You may not be able to do Repeat Play depending on the DVD. Select "REPEAT" after pressing the DVD DISPLAY button on the remote. When you do not select "OFF," the indicator of the "REPEAT" lights in green.

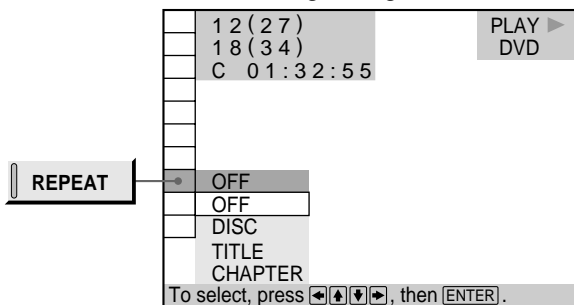

### REPEAT

Selects the setting of Repeat Play.

### When playing a disc and when Program Play and Shuffle Play are set to OFF

- OFF: does not play repeatedly.
- DISC: repeats all the titles/ tracks.
- TITLE: repeats the current title. (DVD only)
- CHAPTER: repeats the current chapter. (DVD only)
- TRACK: repeats the current track. (VIDEO CD/CD only)

### When Program Play is set to ON

- OFF: does not play repeatedly.
- ON: repeats Program Play.

### When Shuffle Play is set to ON

- OFF: does not play repeatedly.
- DISC: repeats all the titles/ tracks. (except ALL DISCS mode)
- TITLE: repeats the current title. (DVD only)
- TRACK: repeats the current track. (VIDEO CD/CD only)

### To cancel Repeat Play

Press CLEAR.

### You can set Repeat Play during stop

After selecting the item of "REPEAT," press  $\blacktriangleright$ . The system starts Repeat Play.

### Note

When you select "DISC" or Program Play, you can do Repeat Play only five times consecutively.

## Repeating a Specific Portion (A↔B Repeat)



You can play a specific portion of a title, chapter, track repeatedly. This is useful when you want to memorize lyrics.

During PBC Playback of VIDEO CDs (page 30), this function is available only while playing moving pictures. You may not be able to do A↔B Repeat Play depending on the DVD.

Select "A-B REPEAT" after pressing the DVD DISPLAY button on the remote. During A↔B Repeat Play, the indicator of the "A-B REPEAT" lights in green.

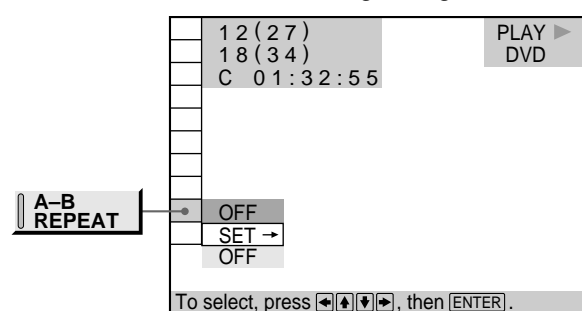

### A-B REPEAT

- SET  $\rightarrow$ : sets the A and B points.
- OFF: does not play a specific portion of a title/ chapter/ track repeatedly.

## Setting a portion for A↔B repeat

### 1 Select "SET $\rightarrow$ " in "A-B REPEAT."

The A-B REPEAT setting display appears.

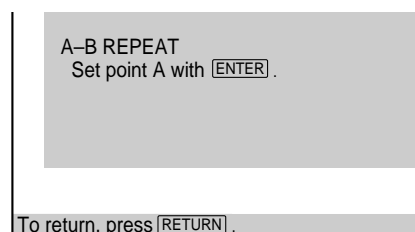
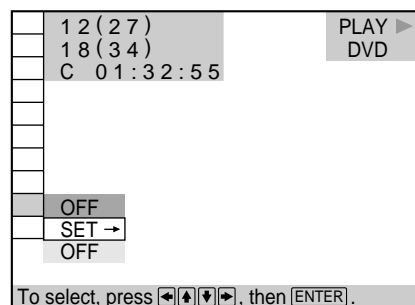

Continued to the next page 45

## Repeating a Specific Portion (A↔B Repeat)

- 2** During playback, when you find the starting point (point A) of the portion to be played repeatedly, press ENTER on the remote.

The starting point (point A) is set.

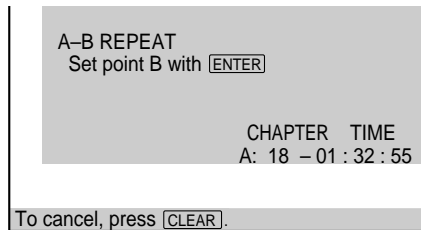

- 3** When you reach the ending point (point B), press ENTER again.

The setting points are displayed and the system starts repeating this specific portion.

"A-B" appears on the front panel display during A↔B repeat play.

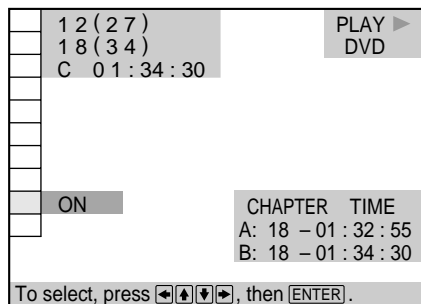

### To cancel A↔B Repeat Play

Press CLEAR on the remote.

### Notes

- You can set A↔B Repeat on only one specific portion.
- A↔B Repeat is canceled when:
  - you open or close the disc tray
  - you turn the power off
  - you change the function
- When you set A↔B Repeat, the settings for Shuffle Play and Program Play are canceled.
- You may not be able to set A↔B Repeat, depending on the scene of the DVD or the VIDEO CD.

## Checking the Play Information



You can check the play information on the bit rate, bit rate history or the portion where the disc is played (layer).

While playing a disc, the approximate bit rate of the playback picture is always displayed by Mbps (Mega bit per second) and the audio by kbps (Kilo bit per second). Select "ADVANCED" after pressing the DVD DISPLAY button on the remote.

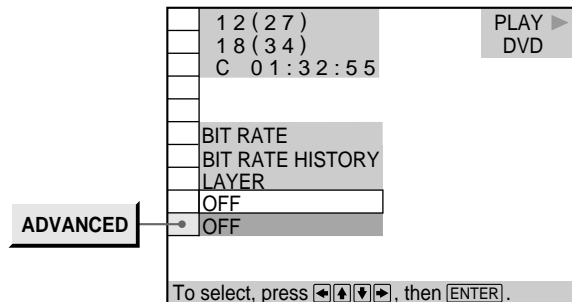

### ■ ADVANCED

#### When playing a DVD

- BIT RATE: displays bit rate.
- BIT RATE HISTORY: displays bit rate and bit rate history.
- LAYER: displays layer and the point picked up.
- OFF: turns off the ADVANCED display.

### Displays of each item

#### BIT RATE

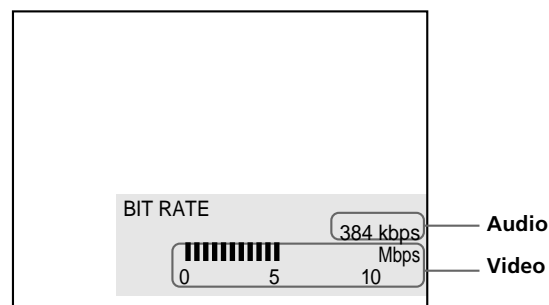

Bit rate refers to the amount of video/audio data per second in a disc. The higher the bit rate is, the larger the amount of data. When the bit rate level is high, there is a large amount of data. However, this does not always mean that you can get higher quality pictures or sounds.

## BIT RATE HISTORY

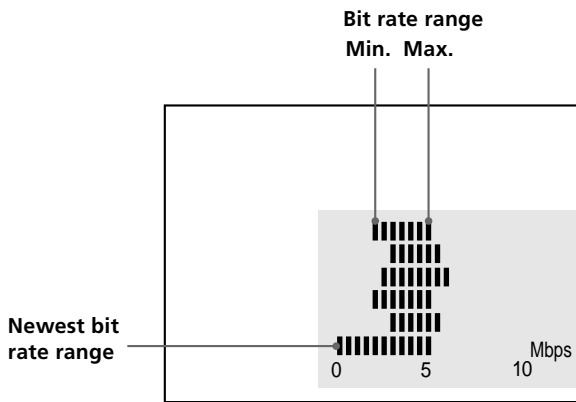

Indicates the transition of bit rate of the playback picture for a period up to the present.

## LAYER

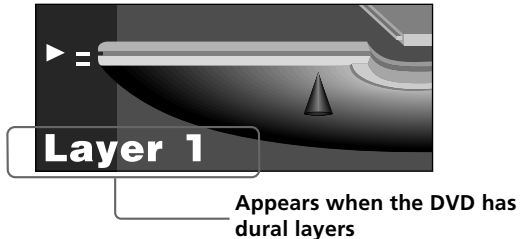

Indicates the approximate point where the disc is playing. If it is a dual-layer DVD, the system indicates which layer is being read.

For details on the layers, see page 72 (DVD).

## Displaying Different Angles Simultaneously



With DVDs on which various angles (multi-angles) for a scene are recorded, you can display all the angles recorded on the disc on the same screen, and start playback in continuous mode at the chosen angle directly. The angles are displayed on a screen divided in 9 sections. Select "ANGLE VIEWER" after pressing the DVD DISPLAY button on the remote. When you can select "ANGLE VIEWER", the indicator of the "ANGLE VIEWER" lights in green.

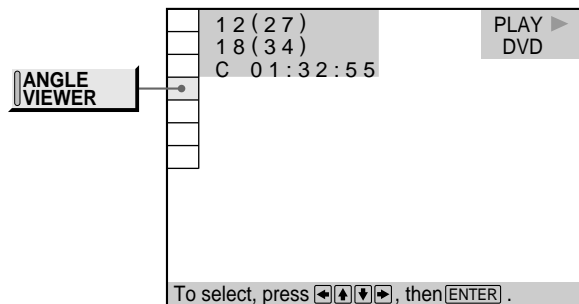

### To select the one angle

Select the angle using the ←/↑/↓/→ buttons, then press ENTER. The selected angle only is displayed.

### To cancel displaying multi-angles

Press ⏪RETURN.

### Notes

- Depending on the DVD, you may not be able to change the angles even if multi-angles are recorded on the DVD.
- When a scene for which various angles (multi-angles) are not recorded comes while displaying different angles simultaneously, the player returns to the normal play.

## Dividing a Track into 9 Sections (Strobe Play)



DVD

VIDEO CD

You can display 9 consecutive sections of the disc on the screen. In this case, the sections show still images. Select "STROBE PLAYBACK" after pressing the DVD DISPLAY button on the remote.

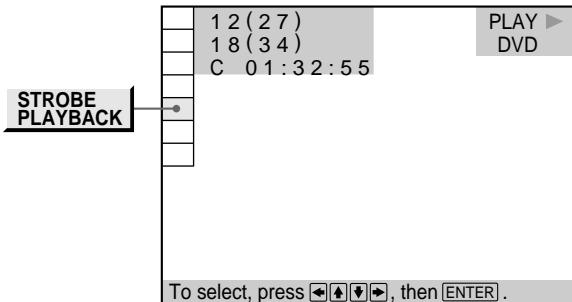

### To cancel watching the strobe play

Press RETURN.



During pause mode, 9 still images around the pause position are displayed

It is convenient to see the still images around the specific portion.

### Note

Depending on the disc, there are some scenes you may not be able to watch with the strobe play.

## Scanning the Title, Chapter and Track



DVD

VIDEO CD

You can check the top picture of titles, chapters and tracks of the disc on a screen divided in 9 sections, and start playback from the chosen title, chapter or track. Select "TITLE VIEWER"(DVD only), "CHAPTER VIEWER"(DVD only) or "TRACK VIEWER"(VIDEO CD only) after pressing the DVD DISPLAY button on the remote.

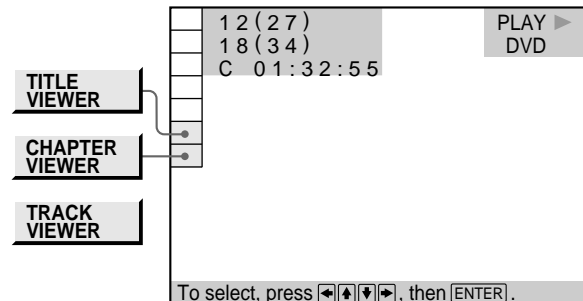

### To start playback from the selected picture

Select the picture using the / / / buttons, then press ENTER. The playback starts from the selected picture.



### When there are over 9 titles or chapters

▼ appears at the right bottom of the screen. Select the right bottom scene (the position of 9) and use to display next titles, tracks or chapters. To return to the previous scene, select the left top scene (the position of 1) and press .

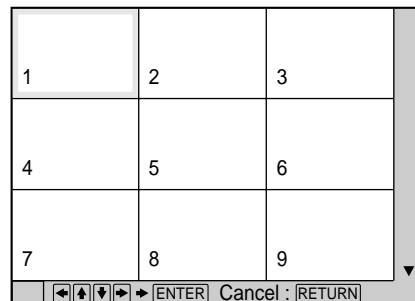

### To cancel scanning the title, chapter and track

Press RETURN.

### Notes

- Depending on the disc, you may not be able to scan the title, chapter and track.
- You cannot scan the track on a VIDEO CD during PBC playback.



# Settings and Adjustments

This chapter describes how to set and how to adjust using the on-screen SETUP menu. Most settings and adjustments are required to be set when you first use the system.

## Using the Setup Display



Using the setup display, you can do the initial setup, adjusting the picture, etc. You can also set a language for the subtitles and the setup display, limit playback by children, etc.

For details on each setup display item, see pages 52 to 58.

### Note

You can display the setup display only when the system is in stop mode.

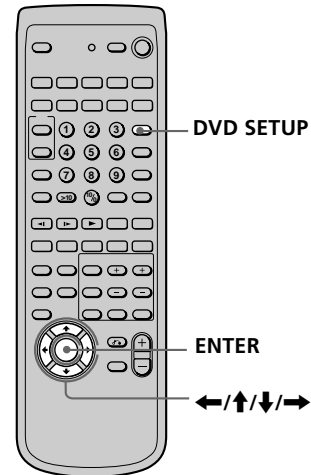

- 1 Press **DVD SETUP** on the remote to display the setup display on the TV screen.

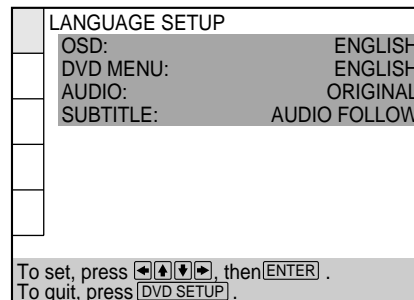

Continued to the next page

## Using the Setup Display

- 2** Select the main item you want using the **↑/↓** buttons, and then press **ENTER** on the remote. The selected main item is highlighted.

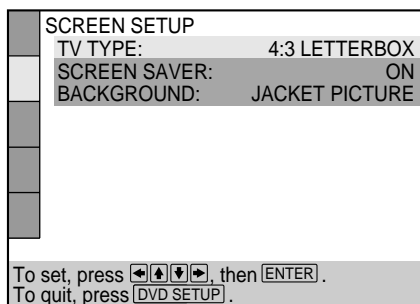
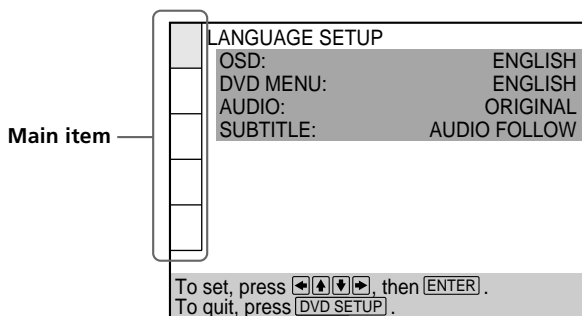

- 3** Select the item you want using the **↑/↓** buttons, then press **→** or **ENTER**.

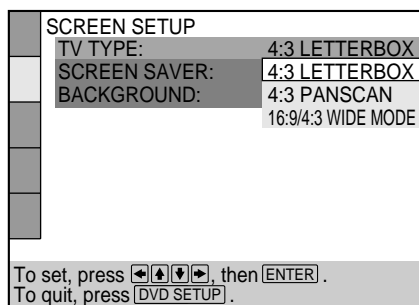
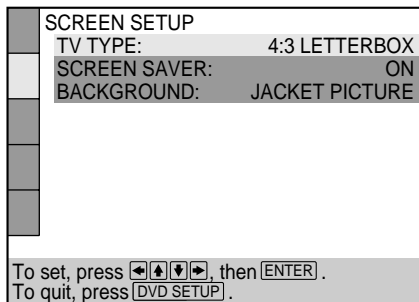

- 4** Select the setting you want using the **←/↑/↓/→** buttons, then press **ENTER**.

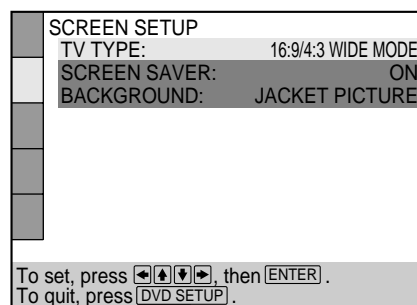
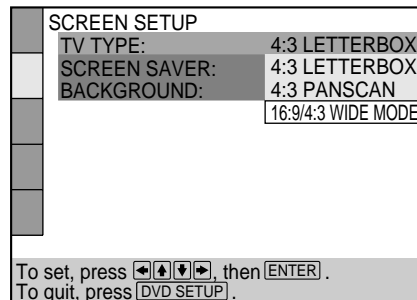

- 5** Press **DVD SETUP** to exit menu.

### To cancel using the setup display

Press **DVD SETUP** on the remote.

### Note

Some setup display items require operations other than selecting the setting. For details on these items, see the relevant pages.

# Setup Display Item List

The default settings are underlined.

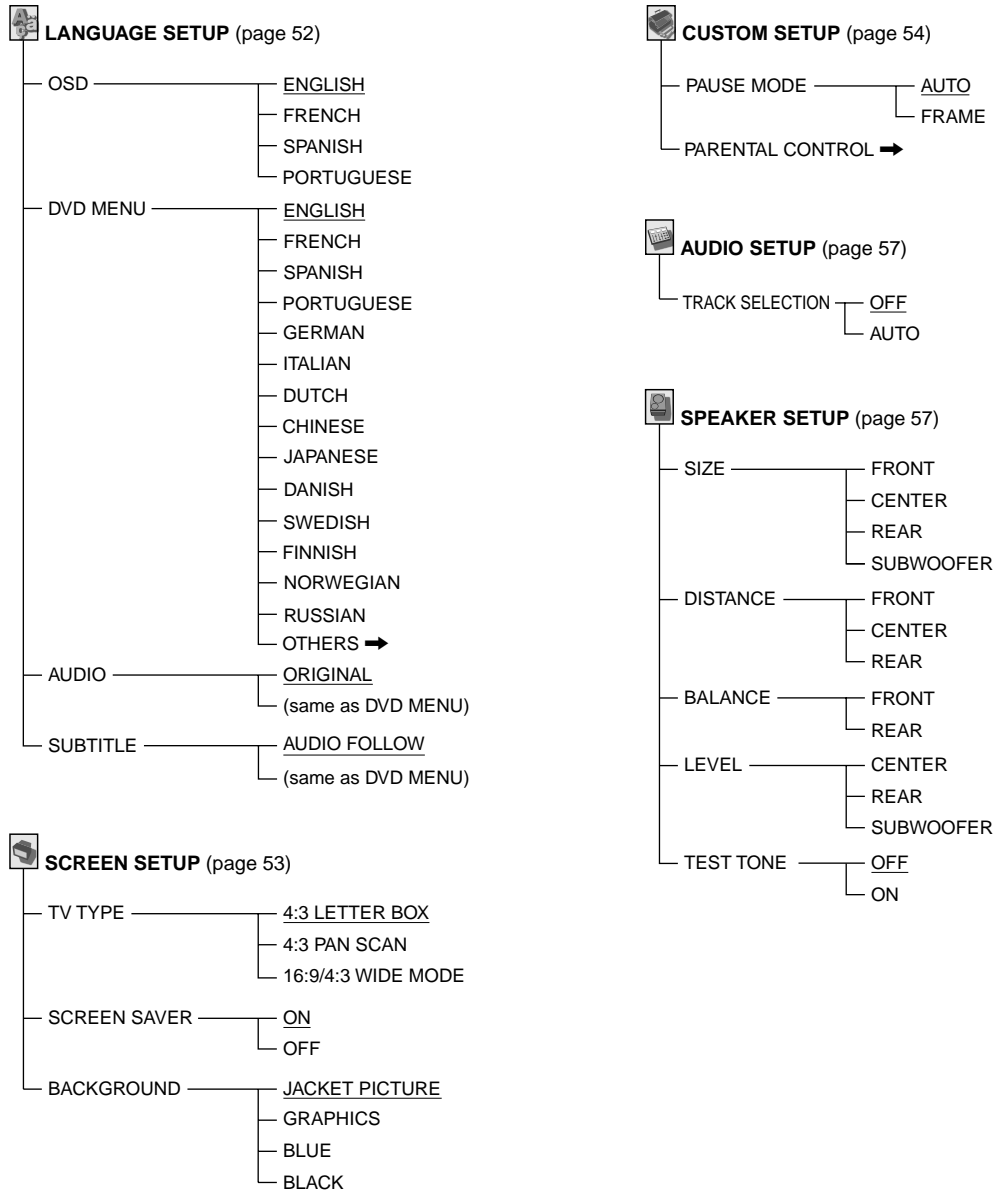

# Setting the Language for Display and Sound (LANGUAGE SETUP)



Select "LANGUAGE SETUP" after pressing the DVD SETUP button on the remote.

"LANGUAGE SETUP" allows you to set various languages for on-screen display or sound. The default settings are underlined.

## Note

When you select a language that is not recorded on the DVD, one of the recorded languages is automatically selected except for the "OSD."

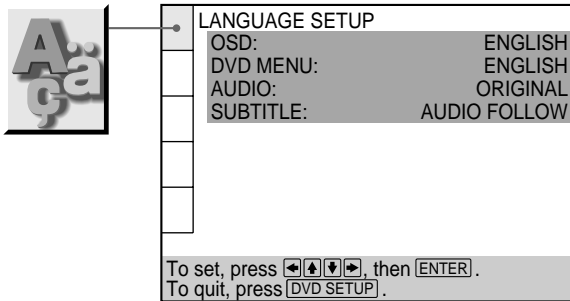

## ■ OSD (On-Screen Display)

Switches the language for the on-screen display.

- ENGLISH
- FRENCH
- SPANISH
- PORTUGUESE

## ■ DVD MENU

Switches the language for the DVD menu.

- ENGLISH
- FRENCH
- SPANISH
- PORTUGUESE
- GERMAN
- ITALIAN
- DUTCH
- CHINESE
- JAPANESE
- DANISH
- SWEDISH
- FINNISH
- NORWEGIAN
- RUSSIAN
- OTHERS →

When you select "OTHERS →," select and enter the language code from the list using the number buttons (page 73). After you have once selected, the language code (4 digits) is displayed.

## ■ AUDIO

Switches the language for the sounds.

- ORIGINAL: the language given priority in the disc
- ENGLISH
- FRENCH
- SPANISH
- PORTUGUESE
- GERMAN
- ITALIAN
- DUTCH
- CHINESE
- JAPANESE
- DANISH
- SWEDISH
- FINNISH
- NORWEGIAN
- RUSSIAN
- OTHERS →

When you select "OTHERS →," select and enter the language code from the list using the number buttons (page 73). After you have once selected, the language code (4 digits) is displayed.

## ■ SUBTITLE

Switches the language for the subtitles.

- AUDIO FOLLOW\*
- ENGLISH
- FRENCH
- SPANISH
- PORTUGUESE
- GERMAN
- ITALIAN
- DUTCH
- CHINESE
- JAPANESE
- DANISH
- SWEDISH
- FINNISH
- NORWEGIAN
- RUSSIAN
- OTHERS →

When you select "OTHERS →," select and enter the language code from the list using the number buttons (page 73). After you have once selected, the language code (4 digits) is displayed.

\* When you select "AUDIO FOLLOW," the language for the subtitles changes according to the language for the setting you selected in "AUDIO."

# Settings for Display (SCREEN SETUP)



DVD

VIDEO  
CD

CD

Select "SCREEN SETUP" after pressing the DVD SETUP button on the remote. "SCREEN SETUP" allows you to set the display according to the playback conditions. The default settings are underlined.

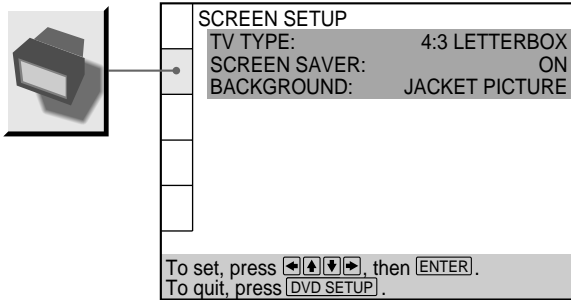

## ■ TV TYPE

Selects the aspect ratio of the TV to be connected.

- 4:3 LETTER BOX: when you connect a normal TV to the system. Displays a wide picture with bands displayed on the upper and lower portions of the screen.
- 4:3 PAN SCAN: when you connect a normal TV to the system. Displays the wide picture on the whole screen with a portion automatically cut off.
- 16:9/4:3 WIDE MODE: when you connect a wide-screen TV to the system or when you connect a TV with WIDE MODE function to the system (displays a wide picture with bands displayed on the upper and lower portions of the screen).

### 4:3 LETTER BOX



### 4:3 PAN SCAN

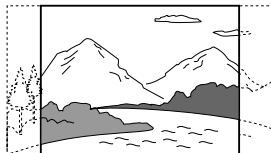

### 16:9

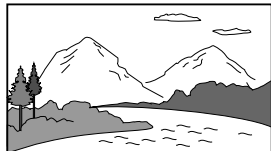

### 4:3 WIDE MODE



## Note

Depending on the DVD, "4:3 LETTER BOX" may be selected automatically instead of "4:3 PAN SCAN" and vice versa.

## ■ SCREEN SAVER

Turns on and off the screen saver. If you turn on the screen saver, the screen saver image appears when you leave the system or the remote in pause or stop mode for 15 minutes or when you play back a CD for more than 15 minutes. The screen saver is useful to prevent your display from becoming damaged.

- ON: turns on the screen saver.
- OFF: turns off the screen saver.

## ■ BACKGROUND

Selects the background color or picture of the TV screen in stop mode or while playing a CD.

- JACKET PICTURE: The jacket picture appears in the background, but only when the jacket picture is already recorded on the disc.
- GRAPHICS: The graphic picture stored in memory in the system beforehand appears in the background.
- BLUE: The background color is blue.
- BLACK: The background color is black.

## Note

If a disc which does not contain the jacket picture is played while "BACKGROUND" is set to "JACKET PICTURE," the graphic picture stored in the system will automatically appear in the background.

# Custom Settings (CUSTOM SETUP)



Select "CUSTOM SETUP" after pressing the DVD SETUP button on the remote.

"CUSTOM SETUP" allows you to set the playback conditions.

The default settings are underlined.

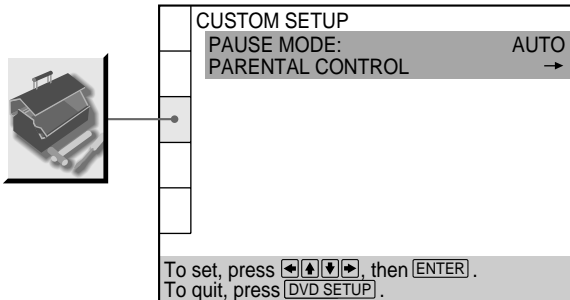

## ■ PAUSE MODE

Selects the picture in pause mode.

- AUTO: A picture including subjects that move dynamically is output with no jitter. Normally select this position.
- FRAME: A picture including subjects that do not move dynamically is output with high resolution.

## ■ PARENTAL CONTROL →

Sets a password and playback limitation level when you play DVDs with playback limitation for children. For details, see "Limiting Playback by Children (Parental Control) ."

## Limiting Playback by Children (Parental Control)

Select "CUSTOM SETUP" after pressing the DVD SETUP button on the remote.

Playing some DVDs can be limited depending on the age of users. The "Parental Control" function allows you to set a playback limitation level.

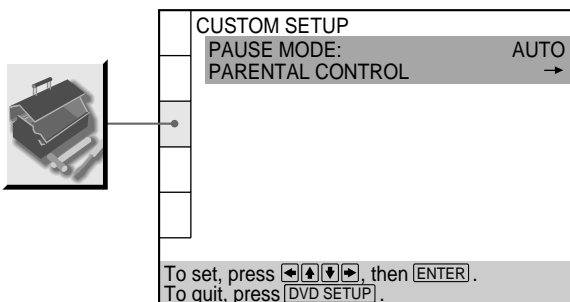

- 1 Select "PARENTAL CONTROL" using the ↑/↓ buttons, then press ENTER on the remote.

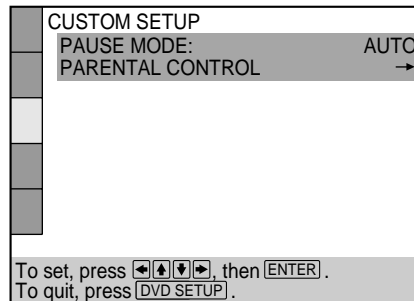

## ■ When you have not entered a password yet

The display for entering a password appears.

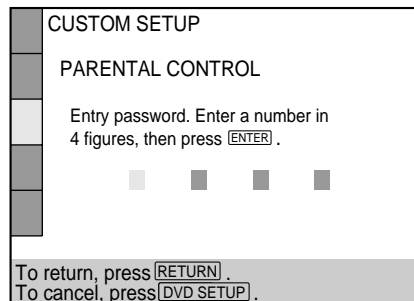

## ■ When you have already entered a password

The display for confirming the password appears. Skip Step 2.

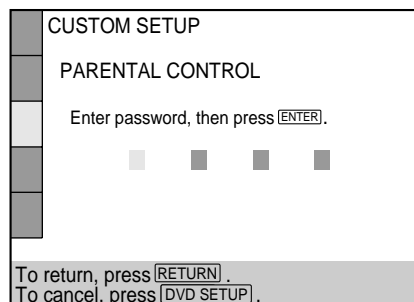

**2 Enter a password in 4 digits using the number buttons, then press ENTER.**

The digits change to asterisks (\*), and the display for confirming the password appears.

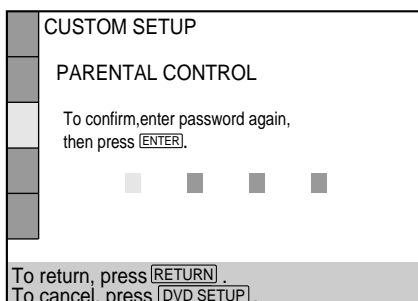

**3 To confirm your password, enter it using the number buttons, then press ENTER.**

The display for setting the playback limitation level and changing the password appears.

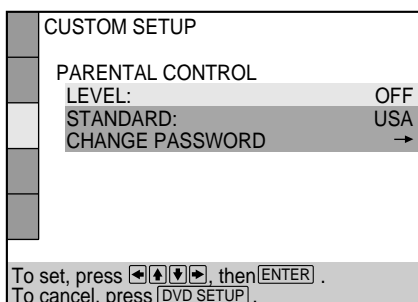

**4 Select "STANDARD" using the ↑/↓ buttons, then press →.**

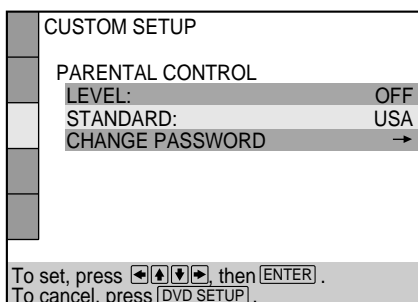

**5 Select an area as the standard for playback limitation level using the ↑/↓ buttons then press →.**

When you select "OTHERS →", select and enter the standard code in the table below using the number buttons.

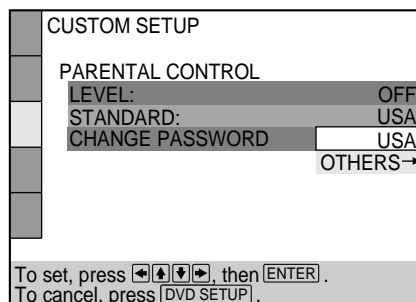

**6 Select "LEVEL" using the ↑/↓ buttons, then press →.**

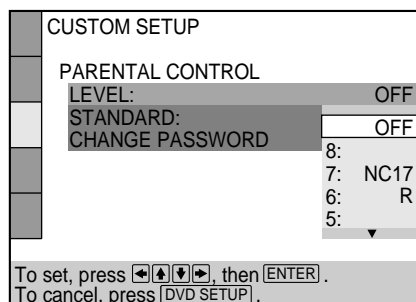

**7 Select the level you want using the ↑/↓ buttons, then press ENTER.**

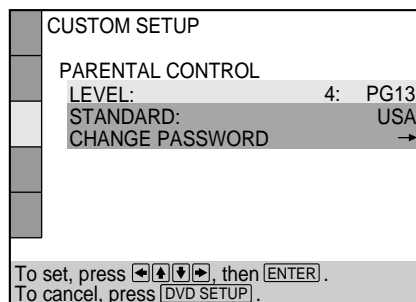

The lower the value is, the more strict the limitation.

Continued to the next page

## Custom Settings (CUSTOM SETUP)

### To return to the normal screen

Press DVD SETUP on the remote.

### To turn off the Parental Control function and play the DVD after entering your password

Set "LEVEL" to "OFF" in Step 7, then press ► on the remote.

### To change the password

**1** After Step 3, select "CHANGE PASSWORD" using the ↑/↓ buttons, then press → or ENTER on the remote.

The display for changing the password appears.

**2** Follow Steps 2 and 3 to enter a new password.

### You can turn off the Parental Control function just after inserting the DVD (Parental Control Temporarily Canceled)

When you set a playback limitation level and insert the DVD, the PARENTAL CONTROL display appears. Enter the password to turn off the Parental Control function.

When you stop playing the DVD, the level returns to the original level.

### If you have forgot your password

Enter the 6 digits number "199703" in Step 2 to clear the current password. To enter a new password, follow the procedure from Step 2 again.

### Notes

- When you play DVDs which do not have the Parental Control function, playback cannot be limited on this system.
- When you do not set a password, you cannot change the settings for playback limitation.
- Depending on the DVD, you may be asked to change the parental control level while playing the disc. In this case, enter the password, then change the level.

When you stop playing the DVD, the level returns to the original level.

Standard	Code number
Austria	2046
Belgium	2057
Canada	2079
China	2092
Denmark	2115
Finland	2165
France	2174
Germany	2109
Hong Kong	2219
Indonesia	2238
Italy	2254
Japan	2276
Malaysia	2363
Netherlands	2376
Norway	2379
Philippines	2424
Russian	2489
Singapore	2501
Spain	2149
Sweden	2499
Switzerland	2086
Taiwan	2543
Thailand	2528
United Kingdom	2184



## Settings for Sound (AUDIO SETUP)

Select "AUDIO SETUP" after pressing the DVD SETUP button on the remote.

"AUDIO SETUP" allows you to select the sound track. The default settings are underlined.

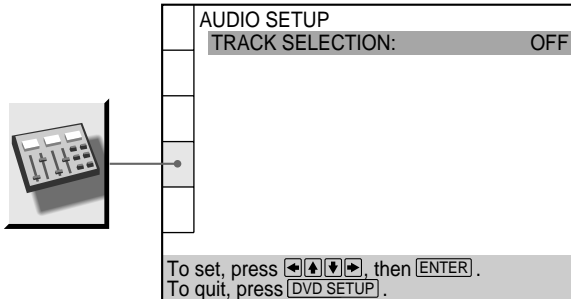

### ■ TRACK SELECTION

Gives the sound track which contains the highest number of the channels priority when you play a DVD on which multiple audio formats are recorded. If multiple audio channels are recorded in PCM, DTS or Dolby Digital format, the higher-numbered channel audio recorded in PCM, DTS or Dolby Digital format is played.

- OFF : No priority given.
- AUTO : Priority given.

### Notes

- When you set this item to "AUTO," the language may change depending on the "AUDIO" settings in "LANGUAGE SETUP." The "TRACK SELECTION" setting has higher priority than that of "AUDIO" settings in "LANGUAGE SETUP" (page 52).
- If PCM, DTS and Dolby Digital sound tracks have the same number of the highest channels, the system selects PCM, DTS and Dolby Digital sound tracks, in this order.
- Depending on the DVD, the audio with priority may be predetermined. In this case, you cannot give priority to the DTS or Dolby Digital format by selecting "AUTO."

## Settings for Speakers (SPEAKER SETUP)

Select "SPEAKER SETUP" after pressing the DVD SETUP button on the remote.

To obtain the best possible surround sound, first specify the distance of the speakers from your listening position, then set the balance and level. Then use the test tone to adjust the speaker volumes to the same level.

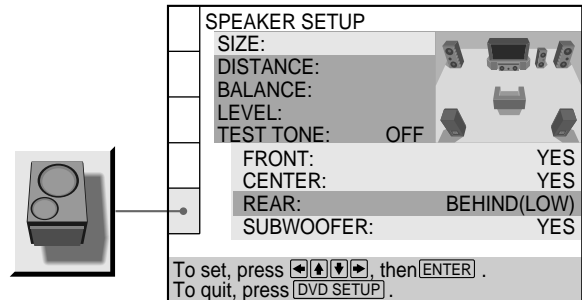

### ■ SIZE

Since the front speaker, center speaker and subwoofer settings are fixed, you cannot change them. The default settings are underlined.

- FRONT  
— YES: You cannot select otherwise.
- CENTER  
— YES: You cannot select otherwise.
- REAR  
— BEHIND (LOW), BEHIND (HIGH), SIDE (LOW), SIDE (HIGH): Specify the position and height to implement the Digital Cinema Surround modes in the "Virtual Multi Dimension" sound field (page 17) properly.
- SUBWOOFER  
— YES: You cannot select otherwise.

### Notes

- When you select an item, the sound cuts off for a moment.
- Depending on the settings of other speakers, the subwoofer may output excessive sound.

Continued to the next page

## Settings for Speakers (SPEAKER SETUP)

### Specifying the rear speaker position and height

Specify the position and height of the rear speakers, referring to the diagram on page 17. The default setting is underlined.

- BEHIND (LOW)  
Select this if the rear speakers are located in the section **B** and **D**.
- BEHIND (HIGH)  
Select this if the rear speakers are located in the section **B** and **C**.
- SIDE (LOW)  
Select this if the rear speakers are located in the section **A** and **D**.
- SIDE (HIGH)  
Select this if the rear speakers are located in the section **A** and **C**.

### ■ DISTANCE

See page 17.

### ■ BALANCE

See page 18.

### ■ LEVEL

See page 18.

### ■ TEST TONE

You can hear the test tone from each speaker in sequence. The default setting is underlined.

- OFF: The test tone is not emitted from speakers.
- ON: During adjustment of "BALANCE" or "LEVEL," the test tone is emitted from both speakers simultaneously.

### To adjust the volume of all the speakers at one time

Use the MASTER VOLUME +/- buttons.

### To return to the default setting

Select the item, then press CLEAR on the remote.

## Adjusting the speaker volume

- 1** When nothing is played, select "SPEAKER SETUP" after pressing DVD SETUP on the remote.
- 2** Select "TEST TONE" and set "TEST TONE" to "ON." You will hear the test tone from each speaker in sequence.
- 3** From your listening position, select "BALANCE" or "LEVEL" and adjust the value of "BALANCE" and "LEVEL" using the  $\uparrow/\downarrow$  buttons. During this adjustment, the test tone is emitted from both speakers simultaneously.
- 4** Select "TEST TONE" and set "TEST TONE" to "OFF" to turn off the test tone.

# Other Operations

This chapter describes how to set the remote for controlling the components connected to the system, listen to the radio, etc.

## Operating Sony Components

You can change the factory settings of the function buttons to suit the Sony components in your system. For example, if you connect a Sony LD player to the AUX jacks on the left main unit, you can set the AUX function button on this remote to control the LD player. Note, however, that the settings of the DVD and TUNER function buttons cannot be changed.

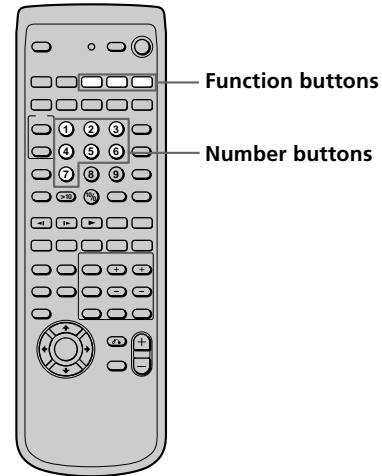

- 1 Hold down the button corresponding to the component you want to assign to a function button (e.g., button 6 for the LD player).

Each button and its corresponding components are shown below.

Button	Sony component	Function button to which you can assign the component		
		TV	VIDEO	AUX
1	VCR mode 1** (Betamax)		●	●
2	VCR mode 2**(8mm)		●	●
3	VCR mode 3** (VHS)		●*	●
4	Digital satellite receiver			●
5	MD deck			●
6	LD player			●
7	TV	●*		

\* Factory setting.

\*\*VCR mode 1/2/3 stand for Sony's Betamax/ 8mm video cassette deck/ VHS correspondingly. If, however, your Sony's VCR has the selector, the original setting, e.g., VCR mode 3 for the VHS, can be changed to e.g., VCR mode 1 or VCR mode 2 setting.

Continued to the next page

## Operating Sony Components

- 2 While holding down the button corresponding to the component, press down the function button whose setting is to be changed (the AUX function button, for example).

The AUX function button is now set to control the Sony LD player.

### To reset a button to its factory setting

Repeat the procedure above.

### To reset all function buttons to their factory settings

Press down I/⏻, AV I/⏻ and MASTER VOLUME – simultaneously, or uninstall the batteries once and press any key, then install them again.

## Operating Non-Sony Components

You can program the remote to control non-Sony components. Once the control signals have been memorized, you can use those components as part of your system.

Note, however, that the settings of the DVD and TUNER function buttons cannot be changed.

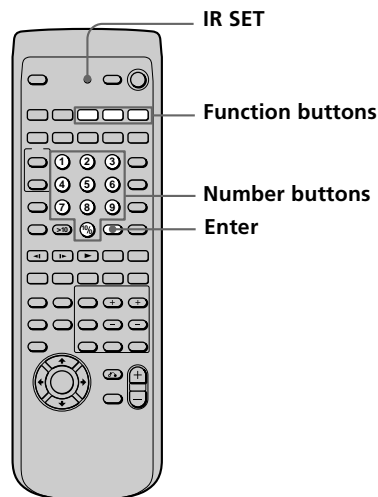

- 1 Press IR SET.
- 2 Press the function button for the component you want to control.  
For example, if you are going to control an LD player, press AUX.  
The function button lights up.
- 3 Press the number buttons to enter the numeric code (or one of the codes if more than one code exist) corresponding to the component and the make of the component you want to control.  
See the tables on pages 61 and 62 for information on the numeric code(s) corresponding to the component and the make of the component.
- 4 Press ENTER.
- 5 Repeat Steps 1 to 4 to control other components.



- If the function button flashes three times consecutively, the programming has failed. Check that the numeric codes corresponding to the component and the make of the component are correct. Start again from Step 1.
- If you do not do Step 2 within twenty seconds after pressing the IR SET button in Step 1, the remote automatically exits learning mode. Start again from Step 1.

#### Note

If the function button does not light up, the batteries are weak. Replace both batteries.

#### To reset all function buttons to their factory settings

Press down I/⏻, AV I/⏻ and MASTER VOLUME – simultaneously, or uninstall the batteries once and press any key, then install them again.

## The Numeric Codes Corresponding to the Component and the Make of the Component

Use the numeric codes in the tables below to control non-Sony components. Since the remote signal that a component accepts differs depending on the model and year of the component, more than one numeric code may be assigned to a component. If you fail to program your remote using one of the codes, try using other codes. The function button to which you can assign a button is in parentheses on top of each table.

#### Notes

- The numeric codes are based on the latest information available for each brand. There is a chance, however, that your component will not respond to some or all of the codes.
- All of the functions on this remote may not be available when used with your particular component.

#### To control a TV (the TV function button only)

Make	Code(s)
DAEWOO	000, 001, 002, 003, 004, 005
FISHER	010, 011
LG (GOLDSTAR)	012, 013, 014, 015, 016, 017
GRUNDIG	020, 021
HITACHI	012, 025, 026, 027
ITT/ NOKIA	028, 029
JVC	030, 031, 032
MAGNAVOX	012, 013, 036, 037
mitsubishi/ MGA	012, 013, 040, 041
NEC	012, 013, 042
PANASONIC	045, 046, 047, 048
PHILIPS	016, 036
PIONEER	047, 050, 051, 052
RCA/ PROSCAN	012, 013, 045, 053, 054, 055, 056
SAMSUNG	012, 013, 016, 017, 037, 060
SANYO	010, 011
SHARP	037, 065, 066
TELEFUNKEN	071, 072, 073, 074
THOMSON	073, 080
TOSHIBA	050, 065, 081
ZENITH	085, 086

Continued to the next page

## The Numeric Codes Corresponding to the Component and the Make of the Component

### To control a VCR (the VIDEO and AUX function buttons only)

Make	Code(s)
AIWA	100, 101
AKAI	102, 103, 104
BLAUPUNKT	105, 106
EMERSON	107, 108, 109, 110, 111, 112
FISHER	113, 114, 115, 116, 117
GENERAL ELECTRIC	118, 119, 120
LG (GOLDSTAR)	121
GRUNDIG	122, 123
HITACHI	118, 124, 125, 126
ITT/ NOKIA	113
JVC	130, 131, 132, 133, 134, 135
MAGNAVOX	119, 122, 125
mitsubishi/ MGA	136, 137, 138, 139, 140
NEC	130, 131
PANASONIC	119, 125, 141, 142
PHILIPS	119, 122, 125, 145, 146, 147
PIONEER	125
RCA/ PROSCAN	118, 119, 122, 124, 125, 148, 149, 150
SAMSUNG	150, 151, 152, 153, 154, 155
SANYO	113, 116, 156
SHARP	160, 161
TELEFUNKEN	170, 171
TOSHIBA	148, 149
ZENITH	175

### To control a digital satellite receiver (the AUX function button only)

Make	Code(s)
JERROLD	200, 201, 202, 203, 204, 205, 206, 207, 208
PANASONIC	210, 211, 212
PIONEER	220, 221
RCA	225
TOCOM	235
ZENITH	240, 241

### To control an LD player (the AUX function button only)

Make	Code(s)
PANASONIC	300
PIONEER	301, 302, 303

### To control an MD deck (the AUX function button only)

Make	Code(s)
KENWOOD	400

## Table of Buttons that You Can Use to Control Each Component

Pressing the following buttons on the remote turns on the system and changes the function to the one in the parentheses.

- DISC1–DISC5 (DVD function)
- BAND (TUNER function)
- Function buttons (corresponding function)

On the other hand, the buttons in the table below will be designated to work on the component you have selected.

Component \ Buttons	TV	LD player	VCR	MD deck	Digital satellite receiver
MUTING, I/⏻, MASTER VOLUME +/-	●*				
←/↑/↓/→, ENTER	●*/**				
AV I/⏻	●	●	●	●	●
▶, ⏸, ■, ⏪/▶▶, ⏩/▶▶▶		●	●	●	
◀/▶▶		●	●		
CH +/-	●				●
TV/ VIDEO	●***				
Number buttons	●	●	●	●	●

- \* These buttons work on;  
 – the TV when you press TV CONTROL.  
 – the system when you select any function using anything but the TV CONTROL button.

\*\* Only for Sony TVs.

\*\*\* This button changes the input source of the TV regardless of the selected function.

## Listening to the Radio

Preset radio stations in the system's memory first (see "Presetting Radio Stations" on page 19).

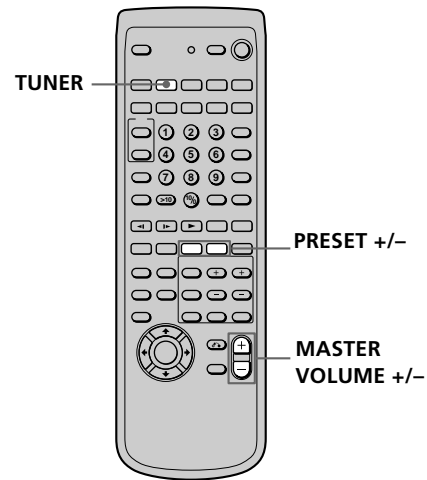

### 1 Press TUNER on the remote.

The last received station is tuned in.



### 2 Press PRESET +/- repeatedly to select the preset station you want.

Each time you press the button, the system tunes in one preset station at a time.

### 3 Adjust the volume by pressing the MASTER VOLUME +/- buttons.

#### To turn off the radio

Press I/⏻.

#### To listen to non-preset radio stations

Use manual or automatic tuning in Step 2.

For manual tuning, press ◀◀ or ▶▶ (TUNE + or -) repeatedly on the remote.

For automatic tuning, press and hold ◀◀ or ▶▶ (TUNE + or -).

#### 💡 If an FM program is noisy

Press ST/ MONO repeatedly on the remote so that "MONO" appears on the front panel display. There will be no stereo effect, but the reception will improve. Press the button again to restore the stereo effect.

#### 💡 To improve reception

Reorient the supplied antennas.

Continued to the next page

## Listening to the Radio

### To check the frequency or sound field

Press DISPLAY repeatedly on the remote.

Each time you press the DISPLAY button, the front panel display changes:

index name of the station\* → frequency → sound field  
→ index name of the station\*

\* Only when the name of the station has been assigned.

## Naming Preset Stations



You can enter a name of up to 10 characters for preset stations. These names (for example, "XYZ") appear in the system's front panel display when a station is selected. Note that no more than one name can be entered for each preset station.

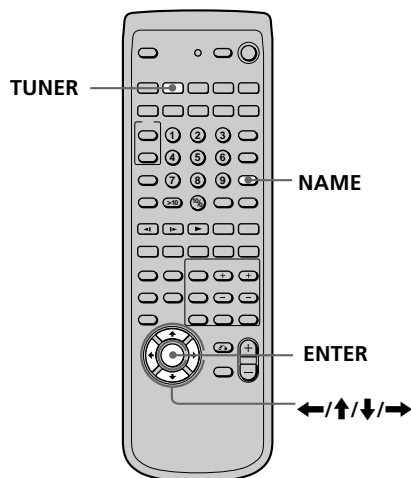

- 1 Press TUNER on the remote.**  
The last station you received is tuned in.
- 2 Tune in the preset station you want to create an index name for.**  
If you are not familiar with how to tune in preset stations, see "Listening to the Radio" on page 63.
- 3 Press NAME.**
- 4 Create an index name by using the cursor buttons:**  
Press ↓/↑ to select a character, then press → to move the cursor to the next position.  
  
**If you've made a mistake**  
Press ← or → repeatedly until the character to be changed flashes, then press ↓/↑ to select the right character.
- 5 Press ENTER.**  
"COMPLETE" appears on the front panel display, followed by the assigned name.

### To assign index names to other stations

Repeat Steps 2 to 5.



# Using the Sleep Timer



You can set the system to turn off automatically at a specified time.

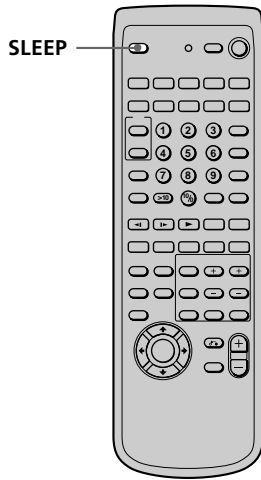

**Press SLEEP on the remote while the power is on.**

Each time you press the SLEEP button, the time changes as shown below.

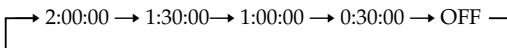
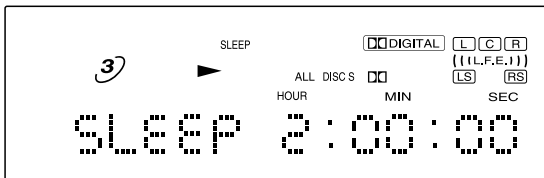

The display dims after you have specified the time.

**💡 You can check the time remaining before the system turns off**

Press SLEEP on the remote. The remaining time appears on the front panel display.

**💡 You can extend the sleep timer up to 9 hours**

Press **↑** on the remote while the time indication is flashing. Each time you press **↑**, the time is extended by 30 minutes up to 9 hours.

When you press **↓**, it is shortened by 30 minutes.

# Additional Information

## Troubleshooting

If you experience any of the following difficulties while using the system, use this troubleshooting guide to help you remedy the problem. Should any problem persist, consult your nearest Sony dealer.

### Power

#### **The power is not turned on.**

- ➔ Check that the AC power cord is connected securely.

### Picture

#### **There is no picture.**

- ➔ Check that the system is connected securely.
- ➔ The video connecting cord is damaged. Replace it with a new one.
- ➔ Make sure you connect the system to the video input connector on the TV (page 10).
- ➔ Make sure you turn on the TV.
- ➔ Make sure you select the video input on the TV so that you can view the pictures from the system.

#### **The picture noise appears.**

- ➔ Clean the disc.
- ➔ If video from your system has to go through your VCR to get to your TV, the copy-protection applied to some DVD programs could affect picture quality. If you still experience problems after checking your connections, please try connecting the system directly to your TV's S video-input, if your TV is equipped with this input (page 12).

#### **The aspect ratio of the screen cannot be changed even though you set "TV TYPE" in "SCREEN SETUP" in the setup display when you play a wide picture.**

- ➔ The aspect ratio is fixed on your DVD.
- ➔ If you connect the system with the S video cable, connect directly to the TV. Otherwise, you may not change the aspect ratio.
- ➔ Depending on the TV, you may not change the aspect ratio.

### Sound

#### **There's no sound or only a very low-level sound is heard.**

- ➔ Check that the speakers and components are connected securely.
- ➔ Make sure that you have selected the correct component on the system.
- ➔ Press MUTING on the remote if the "MUTING ON" is displayed.

- ➔ The protective device on the system has been activated because of a short circuit. Turn off the system, eliminate the short-circuit problem and turn on the power again.
- ➔ The audio connecting cord is damaged. Replace it with a new one.
- ➔ The system is in pause mode or in Slow-motion Play mode. Press ▷ or ► on the remote to return to normal play mode.
- ➔ Fast forward or fast reverse is performed. Press ▷ or ► to return to normal play mode.
- ➔ Check the speaker settings (page 16).

#### **The left and right sounds are unbalanced or reversed.**

- ➔ Check that the speakers and components are connected correctly and securely.
- ➔ Adjust front balance parameter in the LEVEL menu (page 18).

#### **Severe hum or noise is heard.**

- ➔ Check that the speakers and components are connected securely.
- ➔ Check that the connecting cords are away from a transformer or motor, and at least 10 feet (3 meters) away from a TV set or fluorescent light.
- ➔ Move your TV away from the audio components.
- ➔ The plugs and jacks are dirty. Wipe them with a cloth slightly moistened with alcohol.
- ➔ Clean the disc.

#### **The sound loses stereo effect when you play a VIDEO CD or a CD.**

- ➔ Set "AUDIO" to "STEREO" in the Control Menu display (page 41).
- ➔ Make sure you connect the system appropriately.

#### **The surround effect is difficult to hear when you are playing a Dolby Digital sound track.**

- ➔ Make sure the sound field function is on (page 22).
- ➔ Check the speaker connections and settings (page 10).
- ➔ Depending on the DVD, the output signal may not be the entire 5.1 channel but monaural or stereo even if the sound track is recorded in Dolby Digital format.

#### **The sound comes from the center speaker only.**

- ➔ Depending on the disc, the sound may come from the center speaker only.

#### **No sound is heard from the center speaker.**

- ➔ Make sure the sound field function is on (page 22).
- ➔ Select a sound field containing the word "cinema" or "virtual" (page 22).
- ➔ Adjust the speaker volume (page 17).

#### **No sound or only a very low-level sound is heard from the rear speakers.**

- ➔ Make sure the sound field function is on (page 22).
- ➔ Select a sound field containing the word "cinema" or "virtual" (page 22).
- ➔ Adjust the speaker volume (page 17).

### **Operation**

#### **There is noise inside the system.**

- ➔ It is not an error. You may hear noise of the DVD changer when replacing discs or turning on/ off the system.

#### **The disc tray indicator is on when there is no disc inside.**

- ➔ If this is the first time you are using the system, the disc tray indicators turn on. Press FUNCTION until "DVD" appears on the front panel, then wait a while. The indicators will turn off eventually.
- ➔ If you pressed the I/⏻ switch to turn off the system without closing the disc tray, the disc tray indicator turns on. Wait a while for it to turn off. If the indicator is still on, press ⏻ of DISC 1-DISC 5 to close the disc tray.

#### **Radio stations cannot be tuned in.**

- ➔ Check that the antennas are connected securely. Adjust the antennas and connect an external antenna if necessary.
- ➔ The signal strength of the stations is too weak (when tuning in with automatic tuning). Use direct tuning.
- ➔ No stations have been preset or the preset stations have been cleared (when tuning by scanning preset stations). Preset the stations (page 19).
- ➔ Press DISPLAY until the frequency appears in the display.

Continued to the next page

## Troubleshooting



### The remote does not function.

- ➔ Make sure you select the correct function on the remote.
- ➔ Pressing the TV CONTROL button sets the remote to operate the TV only. The I/⏻ switch does not turn on/ off the system. If this mode is on, press a function button on the remote before operating the system or another component.
- ➔ Remove any obstacles between the remote and the system.
- ➔ Use the remote near the system.
- ➔ Point the remote at the remote sensor  on the system.
- ➔ Replace all the batteries in the remote with new ones if they are weak.

### The disc does not play.

- ➔ There is no disc inside ("Insert disc." appears on the TV screen).  
Insert a disc.
- ➔ Insert the disc correctly with the playback side facing down on the disc tray.
- ➔ Clean the disc.
- ➔ The system cannot play CD-ROMs, etc. (page 5).  
Insert a DVD, a VIDEO CD, or a CD.
- ➔ Check the region code of the DVD (page 4).
- ➔ Moisture has condensed inside the system.  
Remove the disc and leave the system turned on for about half an hour (page 6).

### The system does not play from the beginning when playing a disc.

- ➔ Repeat Play, Shuffle Play or Program Play has been selected. Press CLEAR on the remote.
- ➔ Resume Play has been selected.  
Press  on the front panel or  on the remote before you start playing (page 29).
- ➔ A title menu or a DVD menu automatically appears on the TV screen when you play your DVD, or a setup display automatically appears on the TV screen when you play your VIDEO CD with PBC functions.

### The system starts playing the DVD automatically.

- ➔ The DVD features the auto playback function.

### Playback stops automatically.

- ➔ Depending on the disc, the auto pause signal is recorded. While playing such a disc, the system stops playback at the signal.

### Cannot stop playback, Search, Slow-motion Play, Repeat Play, Shuffle Play or Program Play, etc.

- ➔ Depending on the disc, you may not do some of the operations above.

### Messages do not appear on the TV screen in the language you want.

- ➔ In the setup display, select the language for the on-screen display in "OSD" under "LANGUAGE SETUP" (page 52).

### The language for the sound cannot be changed when you play a DVD.

- ➔ Multilingual sound is not recorded on the DVD.
- ➔ Changing the language for the sound is prohibited on the DVD.

### The language for the subtitles cannot be changed when you play a DVD.

- ➔ Multilingual subtitles are not recorded on the DVD.
- ➔ Changing the language for the subtitles is prohibited on the DVD.

### The subtitles cannot be turned off when you play a DVD.

- ➔ Depending on the DVD, you may not be able to turn the subtitles off.



### The angles cannot be changed when you play a DVD.

- ➔ Multi-angles are not recorded on the DVD.
- ➔ Change the angles when "ANGLE" appears on the front panel display (page 43).
- ➔ Changing the angles is prohibited on the DVD.

### The system does not operate properly.

- ➔ Static electricity, etc., may affect the system's operation.  
Disconnect the AC power cord once, then connect it again.

### Nothing is displayed on the front panel display.

- ➔ Press AMP MENU repeatedly on the remote to display <<CUSTOMIZE>> on the front panel display. Select "DISPLAY DIMMER," then press  /  repeatedly to select anything but "DISPLAY OFF."

### The numbers or letters of 5 characters are displayed on the front panel display.

- ➔ Self-diagnosis function was activated. See the table in page 69 and treat the system appropriately.

# Self-diagnosis Function

When the self-diagnosis function works to prevent the system from malfunctioning, a five-character service number (combination of a letter and digits) flashes on the screen or the front panel display depending on the cause. In this case, check the following table.

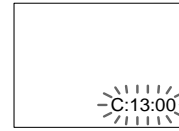

First three characters	Cause and/or Corrective Action
C 13	<ul style="list-style-type: none"><li>• The disc is dirty. ➔ Clean the disc with a cleaning cloth (page 6).</li></ul>
C 31	<ul style="list-style-type: none"><li>• The disc is not inserted correctly. ➔ Open the disc tray and insert the disc correctly.</li></ul>
E xx (xx is any number)	<ul style="list-style-type: none"><li>• To prevent the system from malfunctioning, the self-diagnosis function has worked. ➔ When you contact your Sony dealer or local authorized Sony service facility, give the 5-character service number. (example: E 61 10)</li></ul>

# Specifications

## AUDIO POWER SPECIFICATIONS

### POWER OUTPUT AND TOTAL HARMONIC DISTORTION:

With 8 ohm loads, both channels driven, from 200 – 20 kHz; rated 23 watts per channel minimum RMS power, with no more than 0.8% total harmonic distortion from 250 milliwatts to rated output.

## Amplifier section

<b>Stereo channel</b>	20 Hz - 20 kHz, 0.8% THD 25 W × 2 (Front L/R, 8 ohms) + 75 W (Subwoofer, 8 ohms)
<b>Surround channel</b>	20 Hz - 20 kHz, 0.8% THD 25 W (Center, 8 ohms) 25 W × 2 (Rear, 8 ohms)
<b>TOTAL</b>	200 W

### Input sensitivity/ Impedance

<b>TV/ VIDEO/ AUX</b>	450 mV, 45 kohms
<b>CONTROL S</b>	Only for Sony XBR <sup>2</sup> series and Sony Projection TV

### Output

<b>Center speaker</b>	Accepts only supplied SS-T900
<b>Rear speaker</b>	Accepts only supplied SS-T900
<b>Wireless rear speaker</b>	Accepts only Sony model, SA-IF70
<b>R-ch speaker</b>	Accepts only the supplied main unit (right) with supplied exclusive speaker cord
<b>Tone control</b>	Bass: ±8 dB at 100 Hz Treble: ±8 dB at 10 kHz

## CD/DVD system

<b>Laser</b>	Semiconductor laser ( $\lambda=780\text{nm}$ ) Emission duration: continuous
<b>Laser output</b>	MAX 44.6 $\mu$ W * This output is the value measured at a distance of 200 mm from the objective lens surface on the Optical Pick-up Block with 7 mm aperture.
<b>Signal format system</b>	NTSC
<b>Frequency response</b>	DVD (PCM): 2 Hz to 22 kHz ( $\pm 1.0$ dB) CD: 2 Hz to 20 kHz ( $\pm 1.0$ dB)
<b>Signal-to-noise ratio</b>	More than 80 dB (TV, VIDEO (AUDIO), AUX (AUDIO) connectors only)
<b>Harmonic distortion</b>	Less than 0.03 %

## FM tuner section

<b>System</b>	PLL quartz-locked digital synthesizer system
<b>Tuning range</b>	87.5 - 108.0 MHz (100 kHz step)
<b>Antenna</b>	FM wire antenna
<b>Antenna terminals</b>	75 ohms, unbalanced
<b>Intermediate frequency</b>	10.7 MHz

## AM tuner section

<b>System</b>	Tuner section: PLL quartz-locked digital synthesizer system
<b>Tuning range</b>	530 - 1710 kHz (10 kHz interval) 531 - 1710 kHz (9 kHz interval)
<b>Antenna</b>	Loop antenna

## Video section

<b>Inputs</b>	Video: 1 V <sub>p-p</sub> 75 ohms
<b>Outputs</b>	Video: 1 V <sub>p-p</sub> 75 ohms S-video: Y: 1 V <sub>p-p</sub> 75 ohms C: 0.286 V <sub>p-p</sub> 75 ohms

## Speakers

### Type

<b>Front speaker</b>	<b>Front:</b> Bass reflex type, magnetically shielded <b>Subwoofer:</b> Advanced SAW type, magnetically shielded
<b>Satellite speaker (SS-T900)</b>	Bass reflex type, magnetically shielded

### Speaker unit

<b>Tweeter:</b>	1 inch (2.5 cm) balanced drive type
<b>Midbass:</b>	4 inches (10 cm) cone type
<b>Subwoofer:</b>	8 inches (20 cm) cone type
<b>Satellite speaker (SS-T900)</b>	<b>Tweeter:</b> 1 inch (2.5 cm) balanced drive type <b>Midbass:</b> 3 inches (8 cm) cone type × 2

## General

### Power requirements

120 V AC, 60 Hz

### Power consumption

200 W

### Dimensions (approx.)

#### Main unit (Left/ Right) including front speaker:

Approx.  $12\frac{5}{8} \times 46 \times 17$  inches  
( $320 \times 1167 \times 430$  mm)  
(w/h/d including speaker base)

#### Satellite speaker (SS-T900)

Approx.  $4\frac{1}{2} \times 13\frac{7}{8} \times 5$  inches  
( $112 \times 352 \times 126$  mm)  
(w/h/d including grille net)

### Mass

#### Main unit (Left) including front speaker:

Approx. 58 lb 7 oz (26.5 kg)

#### Main unit (Right) including front speaker:

Approx. 38 lb 9 oz (17.5 kg)

#### Satellite speaker (SS-T900)

Approx. 5 lb 8 oz (2.5 kg)

### Operating temperature

41°F to 95°F (5°C to 35°C)

### Operating humidity

5% to 90%

### Supplied accessories

See page 8.

### Optional

Wireless speaker system SA-IF70

Design and specifications are subject to change without notice.

## Glossary

### Bit rate (page 46)

Value indicating the amount of video data compressed in a DVD per second. The unit is Mbps (Mega bit per second). 1 Mbps indicates that the data per second is 1,000,000 bits. The higher the bit rate is, the larger the amount of data. However, this does not always mean that you can get higher quality pictures.

### Chapter

Sections of a picture or a music piece on a DVD that are smaller than titles. A title is composed of several chapters. Each chapter is assigned a chapter number enabling you to locate the chapter you want.

### Digital Cinema Sound (DCS)

This is the generic name of the surround sound produced by digital signal processing technology developed by Sony. Unlike previous surround sound fields mainly directed at the reproduction of music, Digital Cinema Sound is designed specifically for the enjoyment of movies.

### Dolby Digital

This sound format for movie theaters is more advanced than Dolby Pro Logic Surround. In this format, the rear speakers output stereo sound with an expanded frequency range and a subwoofer channel for deep bass is independently provided. This format is also called "5.1" because the subwoofer channel is counted as 0.1 channel (since it functions only when a deep bass effect is needed). All six channels in this format are recorded separately to realize superior channel separation. Furthermore, since all the signals are processed digitally, less signal degradation occurs. The name "AC-3" comes from the fact that it is the third audio coding method to be developed by the Dolby Laboratories Licensing Corporation.

### Dolby Pro Logic Surround

As one method of decoding Dolby Surround, Dolby Pro Logic Surround produces four channels from two-channel sound. Compared with the former Dolby Surround system, Dolby Pro Logic Surround reproduces left-to-right panning more naturally and localizes sounds more precisely. To take full advantage of Dolby Pro Logic Surround, you should have one pair of rear speakers and a center speaker. The rear speakers output monaural sound.

Continued on the next page

### DTS

Digital audio compression technology that the Digital Theater Systems, Inc. developed. This technology conforms to 5.1-channel surround. The rear channel is stereo and there is discrete subwoofer channel in this format. DTS provides the same 5.1 discrete channels of high quality digital audio. The good channel separation is realized because the all channel data is recorded discrete and processed in digital.

### DVD

A disc that contains up to 8 hours of moving pictures even though its diameter is the same as a CD.

The data capacity of a single-layer and single-sided DVD, at 4.7 GB (Giga Byte), is 7 times that of a CD.

Furthermore, the data capacity of a dual-layer and single-sided DVD is 8.5 GB, a single-layer and double-sided DVD 9.4 GB, and a dual-layer and double-sided DVD 17 GB.

The picture data uses the MPEG 2 format, one of the worldwide standards of digital compression technology. The picture data is compressed to about 1/40 of its original size. The DVD also uses the variable rate coding technology that changes the data to be allocated according to the status of the picture.

The audio data is recorded in Dolby Digital as well as in PCM, allowing you to enjoy more real audio presence. Furthermore, various advanced functions such as the multi-angle, multilingual, and Parental Control functions are provided with the DVD.

### Multi-angle function (page 43)

Various angles, or viewpoints of the video camera, for a scene are recorded on some DVDs.

### Multilingual function (pages 15, 41, 43)

Several languages for the sound or subtitles in a picture are recorded on some DVDs.

### Parental Control (page 54)

A function of the DVD to limit playback of the disc by the age of the users according to the limitation level in each country. The limitation varies from disc to disc; when it is activated, playback is completely prohibited, violent scenes are skipped or replaced with other scenes and so on.

### Playback Control (PBC) (page 30)

Signals encoded on VIDEO CDs (Version 2.0) to control playback.

By using menu screens recorded on VIDEO CDs with PBC functions, you can enjoy playing simple interactive programs, programs with search functions, and so on.

### Title

The longest sections of a picture or a music piece on a DVD; a movie, etc., for a picture piece on video software; or an album, etc., for a music piece on an audio software. Each title is assigned a title number enabling you to locate the title you want.

### Track

Sections of a picture or a music piece on a CD or VIDEO CD. Each track is assigned a track number enabling you to locate the track you want.

### VIDEO CD

A compact disc that contains moving pictures.

The picture data uses the MPEG 1 format, one of the worldwide standards of digital compression technology.

The picture data is compressed to about 1/140 of its original size. Consequently, a 12 cm VIDEO CD can contain up to 74 minutes of moving pictures.

VIDEO CDs also contain compact audio data. Sounds outside the range of human hearing are compressed while the sounds we can hear are not compressed. VIDEO CDs can hold 6 times the audio information of conventional audio CDs.

There are 2 versions of VIDEO CDs.

- Version 1.1: You can play only moving pictures and sounds.
- Version 2.0: You can play high-resolution still pictures and enjoy PBC functions.

This system conforms to both versions.



# Language Code List

For details, see pages 41 and 43.

The language spellings conform to the ISO 639: 1988 (E/F) standard.

Code	Language	Code	Language	Code	Language	Code	Language
1027	Afar	1186	Scots Gaelic	1350	Malayalam	1513	Siswati
1028	Abkhazian	1194	Galician	1352	Mongolian	1514	Sesotho
1032	Afrikaans	1196	Guarani	1353	Moldavian	1515	Sundanese
1039	Amharic	1203	Gujarati	1356	Marathi	1516	Swedish
1044	Arabic	1209	Hausa	1357	Malay	1517	Swahili
1045	Assamese	1217	Hindi	1358	Maltese	1521	Tamil
1051	Aymara	1226	Croatian	1363	Burmese	1525	Telugu
1052	Azerbaijani	1229	Hungarian	1365	Nauru	1527	Tajik
1053	Bashkir	1233	Armenian	1369	Nepali	1528	Thai
1057	Byelorussian	1235	Interlingua	1376	Dutch	1529	Tigrinya
1059	Bulgarian	1239	Interlingue	1379	Norwegian	1531	Turkmen
1060	Bihari	1245	Inupiak	1393	Occitan	1532	Tagalog
1061	Bislama	1248	Indonesian	1403	(Afan) Oromo	1534	Setswana
1066	Bengali; Bangla	1253	Icelandic	1408	Oriya	1535	Tonga
1067	Tibetan	1254	Italian	1417	Punjabi	1538	Turkish
1070	Breton	1257	Hebrew	1428	Polish	1539	Tsonga
1079	Catalan	1261	Japanese	1435	Pashto; Pushto	1540	Tatar
1093	Corsican	1269	Yiddish	1436	Portuguese	1543	Twi
1097	Czech	1283	Javanese	1463	Quechua	1557	Ukrainian
1103	Welsh	1287	Georgian	1481	Rhaeto-Romance	1564	Urdu
1105	Danish	1297	Kazakh	1482	Kirundi	1572	Uzbek
1109	German	1298	Greenlandic	1483	Romanian	1581	Vietnamese
1130	Bhutani	1299	Cambodian	1489	Russian	1587	Volapük
1142	Greek	1300	Kannada	1491	Kinyarwanda	1613	Wolof
1144	English	1301	Korean	1495	Sanskrit	1632	Xhosa
1145	Esperanto	1305	Kashmiri	1498	Sindhi	1665	Yoruba
1149	Spanish	1307	Kurdish	1501	Sangho	1684	Chinese
1150	Estonian	1311	Kirghiz	1502	Serbo-Croatian	1697	Zulu
1151	Basque	1313	Latin	1503	Singhalese	1703	Not specified
1157	Persian	1326	Lingala	1505	Slovak		
1165	Finnish	1327	Laothian	1506	Slovenian		
1166	Fiji	1332	Lithuanian	1507	Samoan		
1171	Faroese	1334	Latvian; Lettish	1508	Shona		
1174	French	1345	Malagasy	1509	Somali		
1181	Frisian	1347	Maori	1511	Albanian		
1183	Irish	1349	Macedonian	1512	Serbian		

# Index to Parts and Controls

Refer to the pages indicated in parentheses for details.

## Front Panel

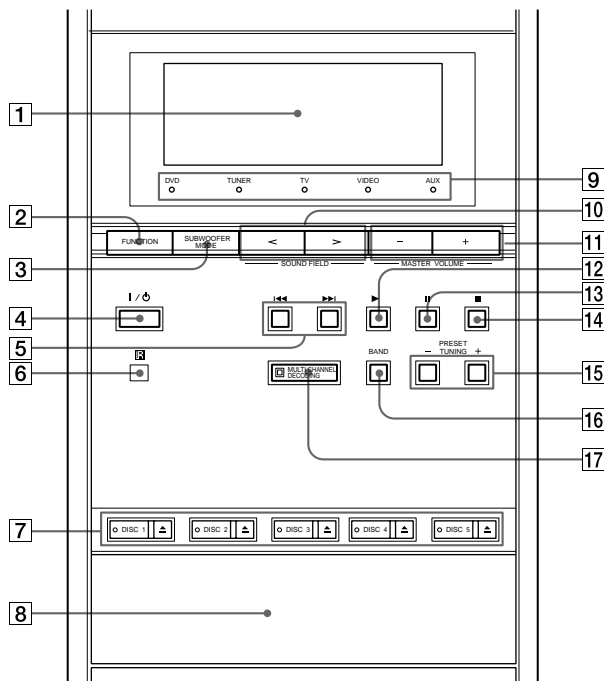

- 1 Front Panel Display (33)**  
Indicates the playing time, etc.
- 2 FUNCTION button (20)**  
Selects the component you want to use.
- 3 SUBWOOFER MODE button (27)**  
Changes between mode 1, 2, and OFF.
- 4 I/O (power) switch (14)**  
Turns on and off the power of the system.
- 5 <</> button (21)**  
Press to go to the next chapter or track or to go back to the previous chapter or track.
- 6 Remote sensor (8)**  
Accepts the remote control signals.
- 7 DISC 1-DISC 5, buttons and indicators (20)**  
DISC 1-DISC 5: Select the disc tray, and start playback (20).  
: Opens or closes the disc tray (20).  
The indicators turn; (21)  
– green when the disc tray is chosen, or the disc is being play backed.  
– off: when there is no disc.  
– orange: when a disc is placed on the disc tray, however, the disc tray is not chosen.
- 8 Disc tray (20)**  
Place a disc on the tray.
- 9 Indicators (9)**  
Shows the function mode.
- 10 SOUND FIELD </> buttons (22)**  
Select the sound field.
- 11 MASTER VOLUME +/- buttons (20)**  
Adjust the volume.
- 12 > button (20)**  
Plays a disc.
- 13 PAUSE button (21)**  
Pauses playing a disc.
- 14 STOP button (21)**  
Stops playing a disc.
- 15 PRESET TUNING +/- buttons**  
Scan all preset stations.
- 16 BAND button**  
Selects AM or FM band.
- 17 MULTI-CHANNEL DECODING indicator**  
Lights when a program source recorded in a multi-channel format is play backed.

## Rear Panel

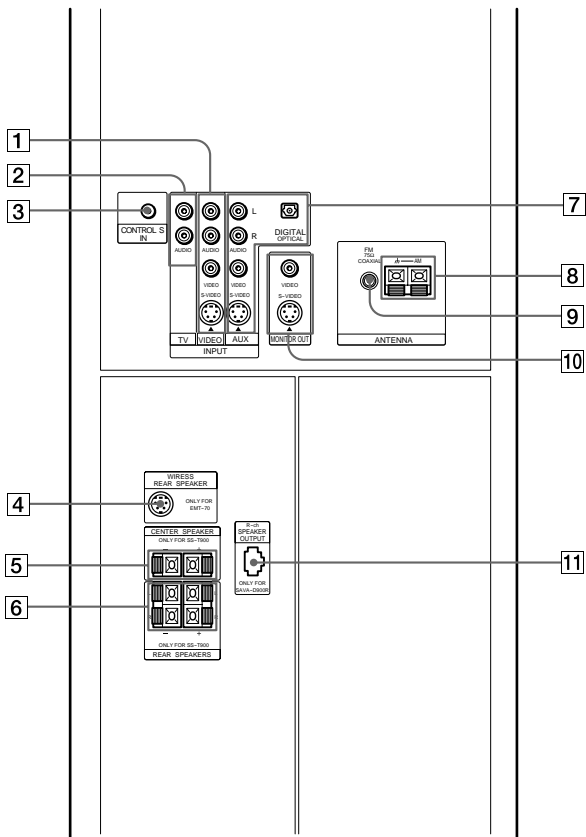

- 1 VIDEO connectors (12)**  
Connect to a VCR.
- 2 TV jacks (11)**  
Connect to a TV.
- 3 CONTROL S IN jack (12)**  
Connects to Sony XBR<sup>2</sup> series TV or Sony Projection TV equipped with a speaker switch.
- 4 WIRELESS REAR SPEAKER connector (10)**  
Connects to an optional wireless rear speaker transmitter.
- 5 CENTER SPEAKER terminals (11)**  
Connect to the supplied satellite speaker (center).
- 6 REAR SPEAKERS terminals (11)**  
Connect to the supplied satellite speakers (rear).
- 7 AUX connectors (12)**  
Connect to digital satellite receiver with OPTICAL jack, or VCR, LD player, MD deck.
- 8 AM loop antenna terminals (12)**  
Connect to the supplied AM loop antenna.
- 9 FM 75 Ω COAXIAL wire antenna connector (12)**  
Connects to the supplied FM wire antenna.
- 10 MONITOR OUT (VIDEO/S VIDEO) connectors (11)**  
Connect to a TV monitor.
- 11 R-ch SPEAKER OUTPUT connector (11)**  
Connects to the supplied front right speaker.

Continued on the next page

Remote

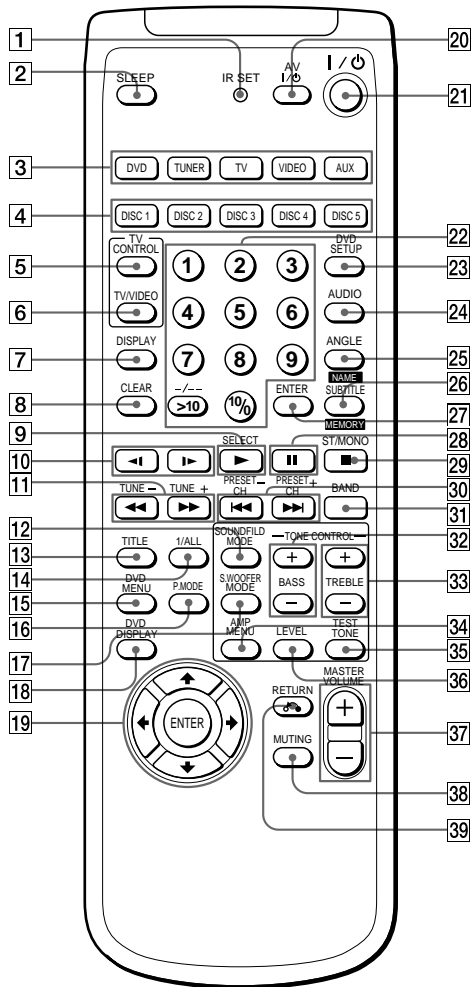

- 1 IR SET button (60)**  
Programs the remote with the signals to control non-Sony components.
- 2 SLEEP button (65)**  
Activates the sleep timer.
- 3 Function buttons (59)**  
Press one of the buttons to select the component you want to use. When you press a button, the system turns on.

To select	Press
Built-in DVD	DVD
Built-in tuner	TUNER
TV	TV*
VCR	VIDEO**
VCR, MD deck, LD player, digital satellite receiver	AUX***

\* Factory setting: Sony TV  
 \*\* Factory setting: Sony VCR mode 3 (VHS)  
 \*\*\* Factory setting: no setting

See the table on page 63 for information on the buttons you can use to control each component. Note that the function buttons are factory-set as described in the table. If you want to change the factory setting of the buttons to match your particular components, do the procedure "Operating Sony Components," or "Operating Non-Sony Components" on pages 59-61.

**Note**  
 Before you turn on the system, make sure that you have adjusted the volume to minimum using the MASTER VOLUME - button to avoid damaging your speakers.

- 4 DISC1-DISC5 buttons**  
Select the disc tray, and starts playback.
- 5 TV CONTROL button (63)**  
Turns on the TV and changes the remote to a TV remote. In this case, the I/O, MASTER VOLUME +/-, MUTING buttons work only on the TV, not on the system.
- 6 TV/VIDEO button (63)**  
Changes the input mode of the TV.

Additional Information

- 7 DISPLAY button (33)**  
Switches the item displayed on the front panel display.  
remaining or playing time → DVD or CD TEXT →  
sound field
- 8 CLEAR button**  
Aborts the previous selection.
- 9 ►PLAY, SELECT button**  
►PLAY: Plays a disc (20).
- 10 ◀/▶ buttons (21)**  
Play back the disc in slow motion.
- 11 ◀◀/▶▶, TUNE +/- buttons**  
◀◀/▶▶: Locate a point quickly while monitoring the  
picture (21).  
TUNE +/- : Scan all available radio stations (19).
- 12 SOUNDFIELD MODE button (22)**  
Selects the sound field.
- 13 TITLE button (29)**  
Displays the title menu on the TV screen.
- 14 1/ALL button (44)**  
Selects to playback only 1 disc or all discs.
- 15 DVD MENU button (29)**  
Displays the DVD menu on the TV screen.
- 16 P. MODE button (31)**  
Selects program, shuffle or normal play mode.
- 17 S.WOOFER MODE button (27)**  
Selects the subwoofer mode.
- 18 DVD DISPLAY button (36)**  
Displays the Control Menu display on the TV screen  
to set or adjust the items.
- 19 ◀/↑/↓/→, ENTER buttons (29)**  
Select and execute the items or settings.
- 20 AV I/⏻ (power) switch (63)**  
Turns on/off the power of the connected audio and  
visual component selected by the function button.
- 21 I/⏻ (power) switch (20)**  
Turns on and off the power of the system.
- 22 Number buttons (30)**  
Select the items or settings.
- 23 DVD SETUP button (49)**  
Shows the DVD SETUP menu on the TV screen.
- 24 AUDIO button (41)**  
Changes the sound while playing a DVD or VIDEO  
CD.
- 25 ANGLE, NAME button**  
ANGLE: Changes the angles when playing a DVD  
(43).  
NAME: Inputs name of the preset radio stations (64).
- 26 SUBTITLE, MEMORY button**  
SUBTITLE: Displays the "SUBTITLE" menu in the  
Control Menu display (43).  
MEMORY: Memorizes preset radio stations (19).
- 27 ENTER button (60)**  
Executes the items or settings selected using the  
number buttons.
- 28 II PAUSE button (21)**  
Pauses playing a disc.
- 29 ■ STOP, ST/MONO button**  
■STOP: Stops playing a disc (21).  
ST/MONO: Changes the FM program reception  
between monaural and stereo (63).
- 30 ◀◀/▶▶IPREV/NEXT, PRESET +/-, CH +/- buttons**  
◀◀/▶▶IPREV/NEXT : Press to go to the next  
chapter or track or to go back to the previous chapter  
or track (21).  
PRESET +/- : Scan all preset stations (19).  
CH +/-: Change TV channels (63).
- 31 BAND button (19)**  
Selects AM or FM band.
- 32 TONE CONTROL BASS +/- buttons (27)**  
Adjust the bass level.
- 33 TONE CONTROL TREBLE +/- buttons (27)**  
Adjust the treble level.
- 34 AMP MENU button (33)**  
Shows the AMP MENU on the front panel display.
- 35 TEST TONE button (18)**  
Starts/ stops test tone of the speakers.
- 36 LEVEL button (18)**  
Adjusts the speaker level.
- 37 MASTER VOLUME +/- buttons (20)**  
Adjust the volume.
- 38 MUTING button (21)**  
Mutes the sound.
- 39 ↶ RETURN button (30)**  
Press to return to the previously selected screen, etc.





# Index

## Numerics

- 1 DISC 44
- 4:3 LETTER BOX 53
- 4:3 PAN SCAN 53
- 4:3 WIDE MODE 53
- 16:9 53

## A

- A-B REPEAT 45
- A↔B Repeat 45
- ALL DISCS 44
- AM antenna 10, 12
- Angle 43
- ANGLE 43
- AUDIO 41, 43
- AUDIO SETUP 57

## B

- BACKGROUND 53
- BALANCE 18
- Batteries 8

## C

- CD 20
- Chapter 5, 39, 71
- CHAPTER 39
- Connecting 10
- Continuous play
  - CD/VIDEO CD 20
  - DVD 20
- Control Menu display 36
- CUSTOM SETUP 54

## D, E

- DCS 71
- Display
  - Control Menu display 36
  - Front panel display 33
  - Setup display 49
- DISTANCE 17
- Dolby Digital 5, 22, 71
- DTS 22, 72
- Dummy disc 6, 13
- DVD 21
- DVD MENU 29
- EXCHANGE 7

## F, G

- Fast Forward 21
- Fast Reverse 21
- FM antenna 10, 12
- Front panel display 33

## H

- Handling discs 7
- Hi-speed search 21
- Hooking up 10

## I, J, K

- INDEX 39

## L, M, N

- LANGUAGE SETUP 52
- LETTER BOX 53
- LEVEL 18
- Locating
  - a specific point 21
- Main unit 9
- Numeric codes 61

## O

- On-screen display
  - Control Menu display 36
  - Setup display 49
- OSD 52

## P, Q

- PAN SCAN 53
- PARENTAL CONTROL 54
- PBC functions 30
- PBC Playback 30
- PRO LOGIC 71
- Program Play 31

## R

- Remote 8, 76
- REPEAT 45
- Resume Play 29

## S

- S video output 12
- Scene 5
- SCENE 39
- SCREEN SAVER 53
- SCREEN SETUP 53
- Searching 21
- Setup display 49
- Shuffle Play 33
- SIZE 57
- Sleep 65
- Slow-motion Play 21
- SOUND FIELD
  - customizing 25
  - selecting 22
- SPEAKER SETUP 57
- Speakers
  - hookup 10
  - set up 16
- STROBE PLAYBACK 48
- SUBTITLE 43

## T

- TEST TONE 18
- TIME/TEXT 40, 41
- Timer 65
- Title 5, 39, 72
- TITLE 39
- Title menu 29
- Track 5, 39, 72
- TRACK 39
- Troubleshooting 66
- TV TYPE 53

## U

- Usable discs 4

## V, W, X, Y, Z

- VIDEO CD 21, 72



## Free Manuals Download Website

<http://myh66.com>

<http://usermanuals.us>

<http://www.somanuals.com>

<http://www.4manuals.cc>

<http://www.manual-lib.com>

<http://www.404manual.com>

<http://www.luxmanual.com>

<http://aubethermostatmanual.com>

Golf course search by state

<http://golfingnear.com>

Email search by domain

<http://emailbydomain.com>

Auto manuals search

<http://auto.somanuals.com>

TV manuals search

<http://tv.somanuals.com>