



BD/DVD Home Theatre System

Operating Instructions

BDV-IT1000/BDV-IS1000



* 4 1 0 9 7 0 8 3 1 * (1)

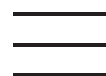

WARNING

To reduce the risk of fire or electric shock, do not expose this apparatus to rain or moisture.

Do not install the appliance in a confined space, such as a bookcase or built-in cabinet.

To reduce the risk of fire, do not cover the ventilation opening of the apparatus with newspapers, tablecloths, curtains, etc. Do not place the naked flame sources such as lighted candles on the apparatus.

To reduce the risk of fire or electric shock, do not expose this apparatus to dripping or splashing, and do not place objects filled with liquids, such as vases, on the apparatus.

Do not expose batteries or apparatus with battery-installed to excessive heat such as sunshine, fire or the like.

In door use only.

Caution - The use of optical instruments with this product will increase eye hazard.

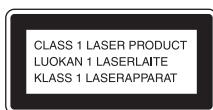

This appliance is classified as a CLASS 1 LASER product. This marking is located on the rear exterior.



Disposal of Old Electrical & Electronic Equipment (Applicable in the European Union and other European countries with separate collection systems)

This symbol on the product or on its packaging indicates that

this product shall not be treated as household waste. Instead it shall be handed over to the applicable collection point for the recycling of electrical and electronic equipment. By ensuring this product is disposed of correctly, you will help prevent potential negative consequences for the environment and human health, which could otherwise be caused by inappropriate waste handling of this product. The recycling of materials will help to conserve natural resources. For more detailed information about recycling of this product, please contact your local

Civic Office, your household waste disposal service or the shop where you purchased the product.



Disposal of waste batteries (applicable in the European Union and other European countries with separate collection systems)

This symbol on the battery or on the packaging indicates that the battery provided with this product shall not be treated as household waste. By ensuring these batteries are disposed of correctly, you will help prevent potentially negative consequences for the environment and human health which could otherwise be caused by inappropriate waste handling of the battery. The recycling of the materials will help to conserve natural resources. In case of products that for safety, performance or data integrity reasons require a permanent connection with an incorporated battery, this battery should be replaced by qualified service staff only. To ensure that the battery will be treated properly, hand over the product at end-of-life to the applicable collection point for the recycling of electrical and electronic equipment. For all other batteries, please view the section on how to remove the battery from the product safely. Hand the battery over to the applicable collection point for the recycling of waste batteries. For more detailed information about recycling of this product or battery, please contact your local Civic Office, your household waste disposal service or the shop where you purchased the product.

Notice for customers: the following information is only applicable to equipment sold in countries applying EU directives.

The manufacturer of this product is Sony Corporation, 1-7-1 Konan Minato-ku Tokyo, 108-0075 Japan. The Authorized Representative for EMC and product safety is Sony Deutschland GmbH, Hedelfinger Strasse 61, 70327 Stuttgart, Germany. For any service or guarantee matters please refer to the addresses given in separate service or guarantee documents.

Precautions

On power sources

- The unit is not disconnected from the mains as long as it is connected to the AC outlet, even if the unit itself has been turned off.
- As the main plug is used to disconnect the unit from the mains, connect the unit to an easily accessible AC outlet. Should you notice an abnormality in the unit,

disconnect the main plug from the AC outlet immediately.

Copyrights and Trademarks

- This product incorporates copyright protection technology that is protected by U.S. patents and other intellectual property rights.

Use of this copyright protection technology must be authorized by Macrovision, and is intended for home and other limited viewing uses only unless otherwise authorized by Macrovision.

Reverse engineering or disassembly is prohibited.

- This system incorporates with Dolby* Digital and Dolby Pro Logic (II) adaptive matrix surround decoder and the DTS** Digital Surround System.

* Manufactured under license from Dolby Laboratories.

“Dolby”, “Pro Logic”, and the double-D symbol are trademarks of Dolby Laboratories.

** Manufactured under license under U.S. Patent #’s: 5,451,942; 5,956,674; 5,974,380; 5,978,762; 6,226,616; 6,487,535 & other U.S. and worldwide patents issued & pending. DTS is a registered trademark and the DTS logos, Symbol, DTS-HD and DTS-HD Master Audio are trademarks of DTS, Inc. © 1996-2008 DTS, Inc. All Rights Reserved.

- This system incorporates High-Definition Multimedia Interface (HDMI™) technology. HDMI, the HDMI logo and High-Definition Multimedia Interface are trademarks or registered trademarks of HDMI Licensing LLC.
- “AVCHD” and the “AVCHD” logo are trademarks of Matsushita Electric Industrial Co., Ltd. and Sony Corporation.
- Java and all Java-based trademarks and logos are trademarks or registered trademarks of Sun Microsystems, Inc.
- “BD-Live” and “BonusView” are trademarks of Blu-ray Disc Association.
- “BRAVIA” is a trademark of Sony Corporation.
- “S-AIR” and its logo are trademarks of Sony Corporation.
- “XMB,” and “xross media bar” are trademarks of Sony Corporation and Sony Computer Entertainment Inc.
- “PLAYSTATION” is a trademark of Sony Computer Entertainment Inc.
- “Blu-ray Disc” is a trademark.
- “Blu-ray Disc,” “DVD+RW,” “DVD-RW,” “DVD+R,” “DVD-R,” “DVD VIDEO,” and “CD” logos are trademarks.
- “x.v.Colour” and “x.v.Colour” logo are trademarks of Sony Corporation.

- “PhotoTV HD” and the “PhotoTV HD” logo are trademarks of Sony Corporation.
- Other system and product names are generally trademarks or registered trademarks of the manufacturers. ™ and ® marks are not indicated in this document.

About These Operating Instructions

- The instructions in these Operating Instructions describe the controls on the remote. You can also use the controls on the unit if they have the same or similar names as those on the remote.
- Icons, such as **BD**, listed at the top of each explanation indicate what kind of media can be used with the function being explained. For details, see “Playable Discs” (page 140).
- In this manual, “disc” is used as a general reference for the BDs, DVDs, or CDs unless otherwise specified by the text or illustrations.
- The instructions in this manual are for BDV-IT1000 and BDV-IS1000. BDV-IT1000 is the model used for illustration purposes. Any difference in operation is clearly indicated in the text, for example, “BDV-IT1000.”
- The Control Menu items may vary depending on the area.
- The default setting is underlined.

About the S-AIR function

The system is compatible with the S-AIR function, which allows transmission of sound between S-AIR products wirelessly.

The following S-AIR products can be used with the system:

- Surround amplifier (supplied): You can enjoy surround speaker sound wirelessly.
- Surround back amplifier (optional): You can enjoy surround back speaker sound wirelessly.
- S-AIR receiver (optional): You can enjoy system sound in another room.

The S-AIR product can be purchased as an option (the S-AIR product lineup differs depending on the area).

Notes or instructions for the surround amplifier or S-AIR receiver in these operating instructions refer only to when the surround amplifier or S-AIR receiver is used.

For details on the S-AIR function, see “Using an S-AIR Product” (page 99).

Table of Contents

About These Operating Instructions	4
About the S-AIR function.....	4
Index to Parts and Control	6

Getting Started

Step 1: Assembling the Speakers.....	18
Step 2: Positioning the System... 37	
Step 3: Connecting the System... 52	
Step 4: Setting up the Wireless System	67
Step 5: Performing the Easy Setup.....	69
Step 6: Enjoying Sound by Each Function.....	73

Playback

Playing a BD/DVD	74
Playing a CD	82
Playing Photo Files	84

Sound Adjustment

Enjoying Surround Sound.....	86
Selecting the Sound Mode	89
Changing the Sound	90

Tuner

Listening to the Radio.....	92
Using the Radio Data System (RDS)....	97

External Audio Device

Using the DIGITAL MEDIA PORT Adapter	98
Using an S-AIR Product	99

Other Operations

Using the Control for HDMI Function for “BRAVIA” Sync	105
Calibrating the Appropriate Settings Automatically	108
Setting the Speakers	110
Controlling the TV or Other Components with the Supplied Remote.....	111
Using the Sound Effect	115
Using the Sleep Timer	116
Deactivating the Buttons on the Unit..	116

Settings and Adjustments

Using the Setup Display	117
[Network Update].....	118
[Video Settings].....	119
[Audio Settings].....	121
[BD/DVD Viewing Settings].....	122
[Photo Settings]	124
[HDMI Settings].....	124
[System Settings]	126
[Network Settings].....	127
[Easy Setup].....	128
[Resetting]	129

Additional Information

Precautions.....	130
Notes about the Discs	131
Troubleshooting.....	132
Self-diagnosis Function	139
Playable Discs.....	140
Supported Audio Formats.....	143
Video Output Resolution	144
Specifications.....	146
Language Code List.....	149
Terms and Conditions of Use and End User License Agreement	150
Glossary	153
Index	156

Index to Parts and Control

For more information, refer to the pages indicated in parentheses.

Remote control

For details of using the remote, see “Using the remote” (page 16).

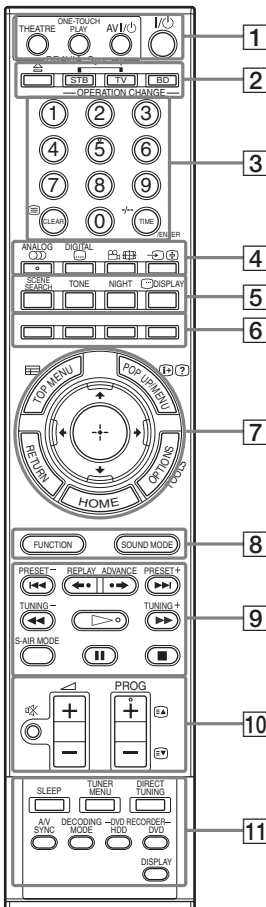

With the cover opened.

Number 5, ANALOG/DIGITAL, PROG +, and ► buttons have a tactile dot. Use the tactile dot as a reference when operating.

- **BD** : For system operations
- **TV** : For TV operations
- **STB** : For set-top box/digital satellite receiver/Sony component (such as VCR, or DVD player/recorder, etc.) operations (For details, see “Controlling the TV or Other Components with the Supplied Remote” (page 111).)

1 THEATRE (106) **TV**

Switches to the optimum video mode for watching movies automatically.

ONE-TOUCH PLAY (74, 106) **BD**

By only pressing the button, the TV turns on, the TV is set for BD/DVD input selector, and the system starts playing a disc automatically.

AV I/O (on/standby) (111) **TV**

STB

Turns on the connected component such as the TV or set-top box/digital satellite receiver, or set to standby mode.

I/O (on/standby) (69, 74, 92) **BD**

Turns on the system, or set to standby mode.

2 **≡** (open/close) (74) **BD**

Opens or closes the disc tray.

OPERATION CHANGE (16, 111)

Changes the source to be operated on the remote.

STB : You can operate set-top box/digital satellite receiver.

TV : You can operate TV.

BD : You can operate the unit.

3 Number buttons (74, 93, 111) **BD**

TV **STB**

Enters the title/chapter numbers or radio frequencies, etc.

CLEAR (79, 111) **BD** **TV** **STB**

Clears the entry field.

≡ (text) (114) **TV**

Accesses text.

TIME (80) **BD**

Displays the elapsed/remaining playback time in the front panel display.

ENTER (111) TV STB

Enters the selected item.

-/- (114) TV

-/- is for selecting a channel number greater than 10.

4  **(audio) (90)** BD

Selects the audio format/track.

  **(subtitle) (77)** BD

Selects the subtitle language when multi-lingual subtitles are recorded on a BD-ROM/DVD VIDEO.

  **(angle) (77)** BD

Switches to other viewing angles when multi-angles are recorded on a BD-ROM/DVD VIDEO.

  **(TV input) (111)** TV

Switches the TV's input source between the TV and other input sources.

ANALOG (111) TV

Switches to analogue mode.

DIGITAL (111) TV

Switches to digital mode.

  **(wide) (111)** TV

Changes the aspect ratio of the connected TV.

5 **SCENE SEARCH (79)** BD

Switches to Scene Search mode that lets you move quickly between scenes within the title currently being played back.

tone icon (115) BD

Adjusts the sound by changing the frequency envelope of a sound.

NIGHT (115) BD

Activates the night mode function.

  **DISPLAY (80)** BD

Displays the playback information on the TV screen.

6 **Color buttons (red/green/yellow/blue) (94, 127)** BD TV

Short cut keys for selecting items on some BD's menus (can also be used for BD's Java interactive operations).

7 **TOP MENU (78)** BD

Opens or closes the BD's or DVD's Top Menu.

POP UP/MENU (78) BD TV

Opens or closes the BD-ROM's Pop-up Menu, or the DVD's menu.

  **(info./text reveal) (114)** TV

Displays the information.

OPTIONS (74, 82, 84, 92) BD STB

Displays the options menu that can be selected appears on the TV screen.

HOME (69, 74, 82, 84, 92, 99, 108, 117) BD TV STB

Enters or exits the system's home menu.

RETURN (92, 111, 127) BD TV STB

Returns to the previous display.

←/↑/↓/→ (69, 74, 82, 84, 92, 99, 108, 117) BD TV STB

Moves the highlight to select a displayed item.

  **(ENTER) (69, 74, 82, 84, 92, 99, 108, 117)** BD TV STB

Enters the selected item.

  **(guide) (111)** TV

Displays the Digital Electronic Programme Guide (EPG).

TOOLS (111) TV

Displays the operation menu for the current display.

8 **FUNCTION (73, 74, 82, 84, 92, 98)** BD

Selects the playback source.

SOUND MODE (89) BD

Selects a suitable sound mode for movies or music.

9  **(previous/next) (74, 82, 84)**

Skips to the previous/next chapter, track, or file. To go to the beginning of the previous track, press  twice.

PRESET +/- (92) 

Selects the preset radio station.

 **REPLAY/ADVANCE (74)**

  

Replays the scene/briefly fast forwards the scene.

 **(fast reverse/fast forward) (74, 82)**   



Fast reverses/fast forwards the disc when pressed during playback.

Each time you press the button, search speed changes.

To resume normal speed, press .

TUNING +/- (92) 

Searches the radio station.

 **(play) (74, 82, 84)**  





Starts or re-starts playback.

Plays a slideshow when a disc containing JPEG image files is inserted.



S-AIR MODE (99) 

Selects playback mode for the S-AIR receiver.

II (pause) (74, 82, 84)  





Pauses or re-starts playback.

■ (stop) (74, 82, 84)  





Stops playback and remembers the stop point (resume point).



The resume point for a title/track is the last point you played or the last photo for a photo folder.

10  **(muting) (74, 82, 111)**  

Turn off the sound temporarily.



 **(volume) +/- (74, 111)**  

Adjusts the volume.

PROG +/- (111)  

Selects the channels up and down.

 **(114)** 

After pressing , you can select the next () or previous () text page.

11 **SLEEP (116)** 

Sets the sleep timer.

TUNER MENU (95) 

Enters the menu for the tuner settings.

DIRECT TUNING (95) 

Selects the radio frequencies.

A/V SYNC (82) 

Adjusts the delay between the picture and sound.

DECODING MODE (86) 

Selects the system's pre-programmed decoding modes that bring exciting and powerful sound of movie theaters into your home.

DVD RECORDER (111) 

Changes the operation mode for Sony DVD recorders.

HDD: HDD mode

DVD: DVD mode

DISPLAY (92) 

Changes the radio information in the front panel display between radio frequency and station name.

Front panel

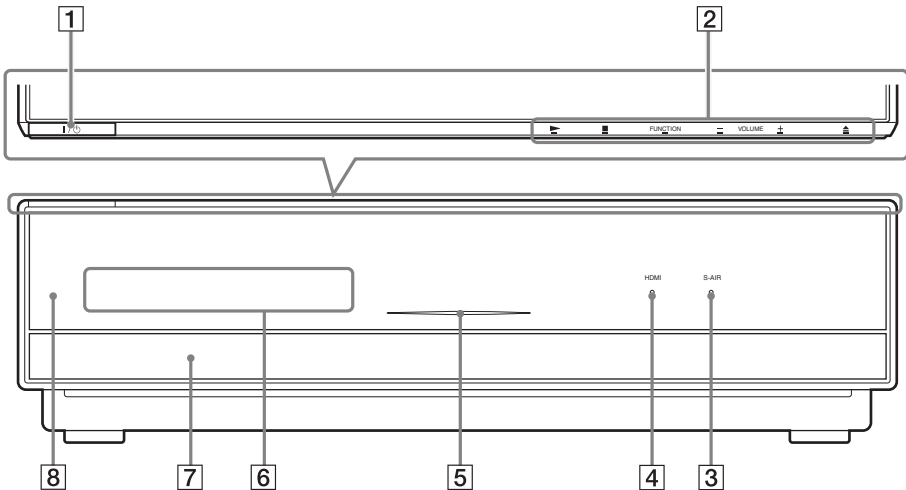

1 I/O (on/standby) (74)

Turns on the unit, or sets to standby mode.

2 Soft-touch buttons (74)

These buttons work by touching lightly around the printed area or projecting part. Do not press them strongly.

▷ (play)

Starts or re-starts playback.

Plays a slideshow when a disc containing JPEG image files is inserted.

■ (stop)

Stops playback and remembers the stop point (resume point).

The resume point for a title/track is the last point you played or the last photo for a photo folder.

FUNCTION

Selects the playback source.

VOLUME +/-

Adjusts the system's volume.

⌵ (open/close)

Opens or closes the disc tray.

3 S-AIR indicator

Lights up when the S-AIR transceiver is inserted in the unit and the system transmits the sound.

4 HDMI indicator

Lights up when the HDMI OUT jack is correctly connected to HDCP (High-bandwidth Digital Content Protection) compliant device with HDMI or DVI (Digital Visual Interface) input.

5 DISC indicator

Flashing: The system is loading a disc.

Lighting up: A disc is loaded. (When no disc is loaded, the DISC indicator is not lit.)

6 Front panel display

7 Disc tray (74)

8  (remote sensor) (16)

Front panel display

About the indications in the front panel display

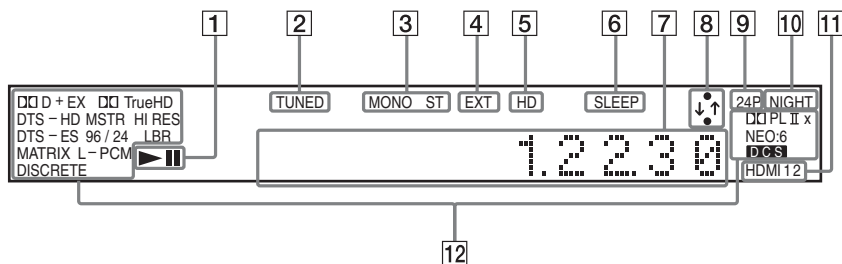

- 1** Playing status
- 2** Lights up when a station is received. (Radio only) (92)
- 3** Monaural/Stereo effect (Radio only) (92)
- 4** Lights up when the external memory is recognized. (64)
- 5** Lights up when outputting 720p/1080i/1080p video signals from the HDMI OUT jack or 720p/1080i video signals from the COMPONENT VIDEO OUT jacks.
- 6** Flashes when the sleep timer is set. (116)
- 7** Displays system's status such as chapter, title, or track number, time information, radio frequency, playing status, decoding mode, etc.
- 8** Lights up when the system is accessing the network.
- 9** Lights up when outputting 1920 x 1080p/24Hz video signals.
- 10** Lights up when the night mode is on. (115)
- 11** Lights up when the HDMI IN1 or 2 jack is correctly connected to HDCP (High-bandwidth Digital Content Protection) compliant device with HDMI or DVI (Digital Visual Interface) output.
- 12** Current sound format

Rear panel

BDV-IT1000

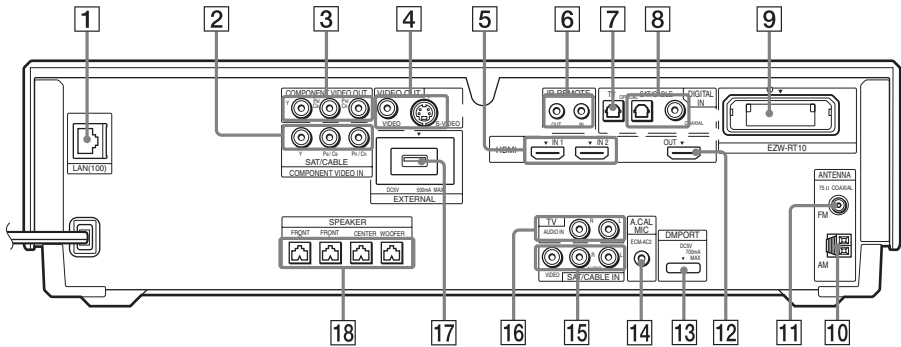

BDV-IS1000

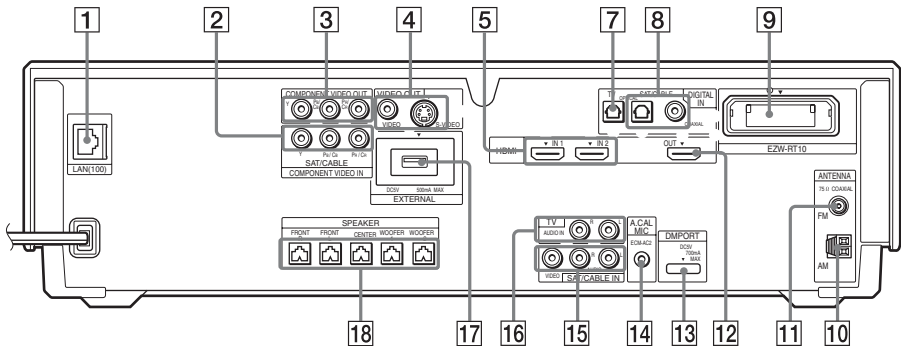

- | | |
|--|---|
| 1 LAN (100) terminal (65) | 10 AM terminal (62) |
| 2 COMPONENT VIDEO IN (SAT/CABLE) jacks (59) | 11 FM 75Ω COAXIAL jack (62) |
| 3 COMPONENT VIDEO OUT jacks (57) | 12 HDMI OUT jack (57) |
| 4 VIDEO OUT (VIDEO, S VIDEO) jacks (57) | 13 DMPORT (DIGITAL MEDIA PORT) jack (59) |
| 5 HDMI IN1/2 jacks (59) | 14 A.CAL MIC jack (69, 108) |
| 6 IR REMOTE (IN, OUT) (16) (BDV-IT1000 only) | 15 SAT/CABLE IN (VIDEO, AUDIO R/L) jacks (59) |
| 7 DIGITAL IN (TV OPTICAL) jack (57) | 16 TV (AUDIO IN R/L) jacks (57) |
| 8 DIGITAL IN (SAT/CABLE OPTICAL, COAXIAL) jacks (59) | 17 EXTERNAL slot (64) |
| 9 EZW-RT10 slot (63) | 18 SPEAKER jacks (54) |

Surround amplifier

Front panel

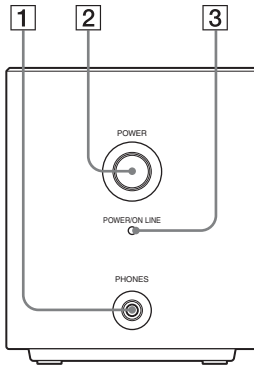

- 1 PHONES jack (67)
- 2 POWER (ON/OFF) (67, 102)
- 3 POWER / ON LINE indicator (67, 99)

Rear panel

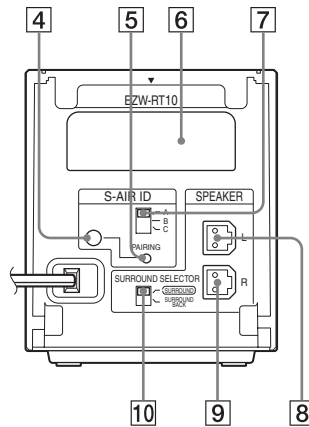

- 4 PAIRING indicator (102)
- 5 PAIRING (102)
- 6 Wireless transceiver (EZW-RT10) slot (63)
- 7 S-AIR ID switch (67, 99)
- 8 SPEAKER L jack (54)
- 9 SPEAKER R jack (54)
- 10 SURROUND SELECTOR switch (67, 102)

Unpacking

BDV-IT1000

- Front speakers (2)

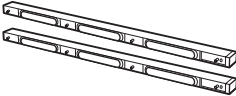

- Surround speakers (2)

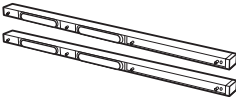

- Center speaker (1)

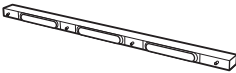

- Subwoofer (1)

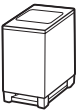

- Baffle covers (short 3, long 2)

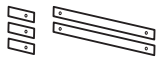

- Grilles (5)

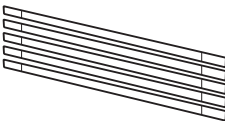

- Floor bases (4)



- Poles (4)

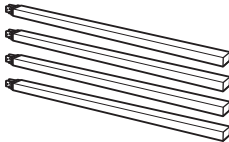

- Long screws (8, black)



- Foot pads (thick 2, thin 2)

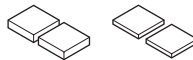

- Wall mounting brackets (top) (5)



- Wall mounting brackets (bottom) (5)



- Bracket covers (10)



- Screws (5)

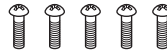

- AM loop antenna (aerial) (1)



- FM wire antenna (aerial) (1)

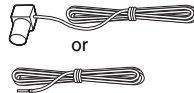

- Speaker cords (6, white/red/blue/gray/green/purple)



- Video cord (1)



- Remote commander (remote) (1)



- R6 (size AA) batteries (2)



- Calibration mic (1)

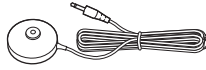

- Surround amplifier (1)

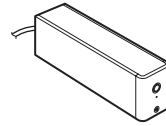

- Speaker cord cover (1)



- Speaker cord holder (1)



- Wireless transceivers for the unit (2)



- Operating Instructions
- Basic connections (card)
- Speaker Installation Guide (card)
- Caution on using the speakers (leaflet)
- Software License Information (leaflet)

Note

- Unpack the speakers, being careful not to touch the speaker units.
- Keep speakers away from one another. Speakers are magnetically attracted, may hit each other, and cause damage.
- Keep magnetic objects such as watches, magnetic card, etc., away from the speakers.

BDV-IS1000

- Front speakers (2), center speaker (1), and surround speakers (2)

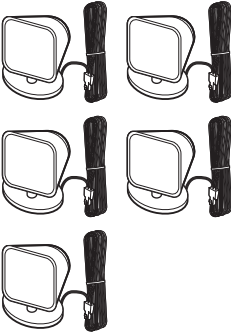

- Subwoofer (1)

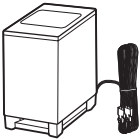

- AM loop antenna (aerial) (1)



- FM wire antenna (aerial) (1)

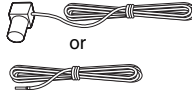

- Video cord (1)



- Remote commander (remote) (1)



- R6 (size AA) batteries (2)



- Calibration mic (1)



- Brackets (5)



- Wrench (1)



- Surround amplifier (1)

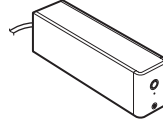

- Speaker cord cover (1)



- Speaker cord holder (1)



- Wireless transceivers for the unit (2)

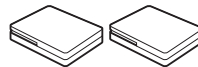

- Operating Instructions
- Basic connections (card)

Using the remote

Inserting batteries into the remote

Insert two R6 (size AA) batteries (supplied) by matching the ⊕ and ⊖ ends on the batteries to the markings inside the compartment.

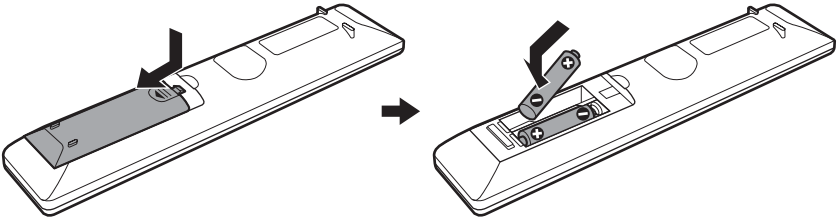

Note

- Do not leave the remote in an extremely hot or humid place.
- Do not use a new battery with an old one.
- Do not drop any foreign object into the remote casing, particularly when replacing the batteries.
- If you do not intend to use the remote for an extended period of time, remove the batteries to avoid possible damage from battery leakage and corrosion.

About operation of the remote

You can operate this system, TV, and set-top box/digital satellite receiver using the supplied remote. Change the operation mode by using OPERATION CHANGE.

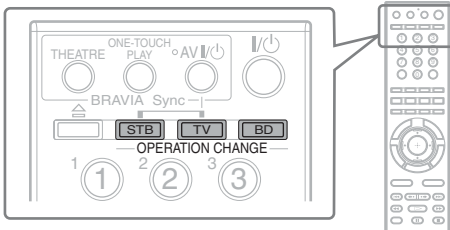

■ System operation

Press BD (BD lights up for 1 second).

The remote enters system operation mode, and BD lights up when you press buttons for operation.

When operating the system, point the remote at the remote sensor  on the unit.

■ TV operation

Press TV (TV lights up for 1 second).

The remote enters TV operation mode, and TV lights up when you press buttons for operation (TV does not light up when you press a button that is not available for the TV).

To operate the TV, set the remote signal to suit your TV. For details, see “Controlling the TV or Other Components with the Supplied Remote” (page 111).

■ Set-top box/digital satellite receiver/Sony component (such as VCR, DVD player/recorder, etc.) operation

Press STB (STB lights up for 1 second).

The remote enters set-top box/digital satellite receiver operation mode, and STB lights up when you press buttons for operation (STB does not light up when you press a button that is not available for the set-top box/digital satellite receiver).

To operate the set-top box/digital satellite receiver/Sony Component, set the remote signal to suit your set-top box/digital satellite receiver. For details, see “Controlling the TV or Other Components with the Supplied Remote” (page 111).

Note

- Do not expose the remote sensor to direct sunlight or lighting apparatus. Doing so may cause a malfunction.

To use the remote at a distance from the system

(BDV-IT1000 only)

You can use the remote away from the system by connecting an IR repeater system (not supplied) to the unit. Use this optional item when you install the unit in a place where the remote signal cannot be received.

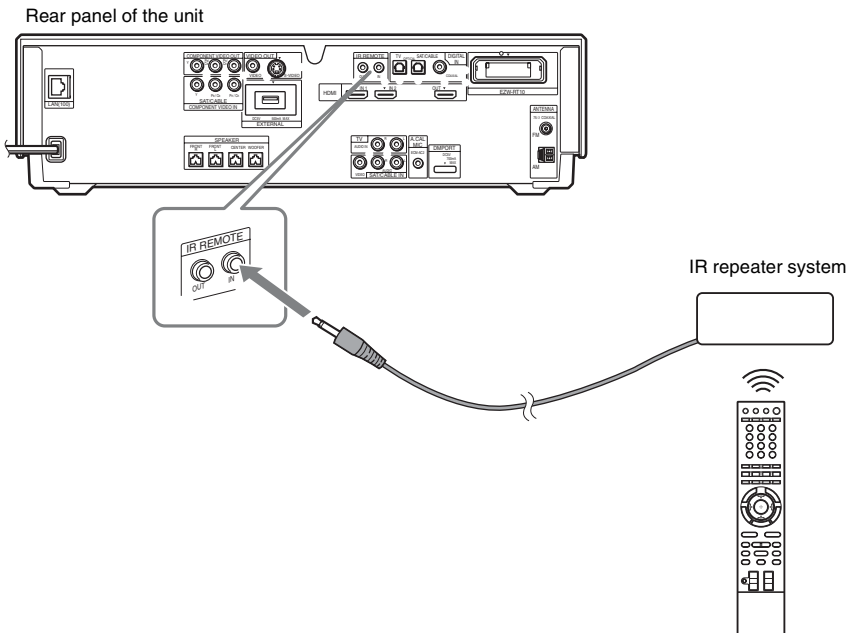

Step 1: Assembling the Speakers

(BDV-IT1000 only)

You can set speakers in two ways using stands: if you would like to place them on a floor, use speaker stands (page 23) and if on a desk, shelf, etc., use desktop stands (page 31).

Before connecting the speakers, assemble the speakers.

Caution on using the speakers

- When moving the speakers, keep one hand under the desktop stand and hold both sides of the speaker. When you use speaker stands with the speakers, hold the pole and the base.

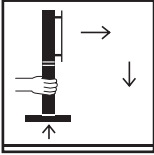

- The following actions may damage the speaker.

Topping the speaker.



Shaking the speaker.

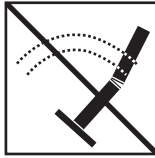

Swinging the speaker.



Pushing on the speaker.

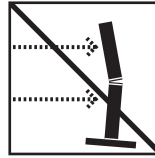

Hitting the speaker.



Speaker assembly

Use the parts as follows:

- Front speakers (2)
- Surround speakers (2)
- Center speaker (1)
- Speaker cords (5, white/red/blue/gray/green)
- Baffle covers (short 3, long 2)
- Grilles (5)

Use the following if you use speaker stands:

- Floor bases (4)
- Poles (4)
- Long screws (8, black)

Use the following if you use desktop stands:

- Desktop stands (4) *

* Desktop stands are screwed on the floor bases. When using desktop stands, unscrew and detach them.

Although the front part of the front speaker is slightly different from that of the surround speaker, the assembly method is the same.

About how to connect the speaker cords, see page 54.

Note

- Spread a cloth on the floor to avoid damaging the floor when you assemble the speakers.
- When assembling, take care not to touch the speaker units.

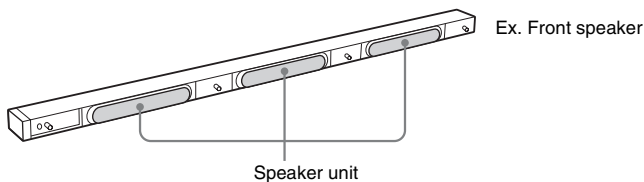
**Tip**

- You can install the front, center, and surround speakers on a wall by using the wall mounting bracket (supplied) (page 42). In this case, you need to attach neither the speaker stand nor desktop stand to the speaker.

How to identify the speakers

Check the label on the speaker.

- Front left speaker (L): FRONT L (white)
- Front right speaker (R): FRONT R (red)
- Surround left speaker (L): SUR L (blue)
- Surround right speaker (R): SUR R (gray)
- Center speaker: CENTER (green)

Assembling the center speaker

1 Remove the cover from the speaker.

Pry up the cover by inserting a thin, flat object into the slit in the cover. To replace the cover, see Step 3. The removed cover is used in a later step, so be careful not to lose it.

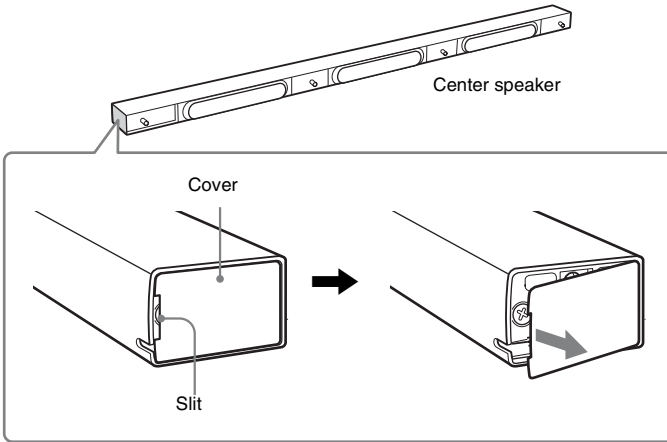

Note

- When assembling, take care not to touch the speaker unit.

2 Connect the speaker cords to the speaker.

Use the speaker cords (green). Be sure to match the speaker cords to the appropriate terminals on the speakers: the speaker cord with the color tube to \oplus , and the speaker cord without the color tube to \ominus . Do not catch the speaker cord insulation in the speaker terminals.

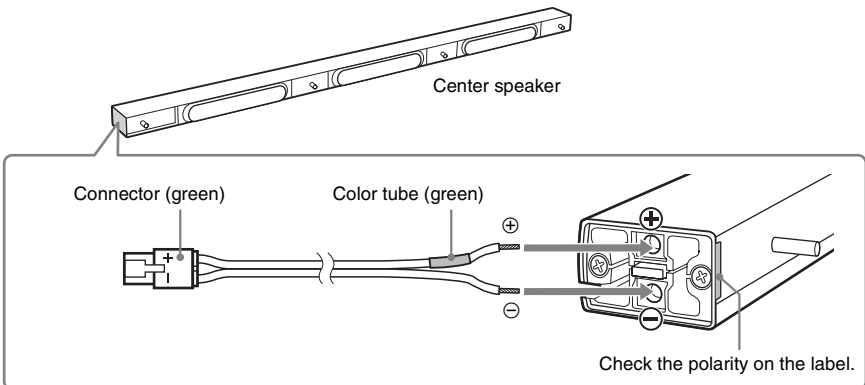

Note

- When assembling, take care not to touch the speaker unit.

- 3** Secure the speaker cord by running it through the slot, then attach the cover to the speaker.

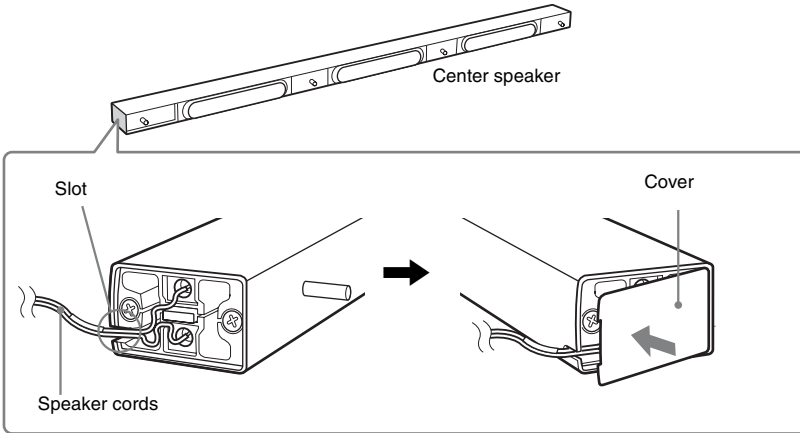

- 4** Attach the baffle cover to the speaker.

Use the baffle cover (short). Press the ends of the baffle cover over the pin, then press down to flush fit the speaker front.

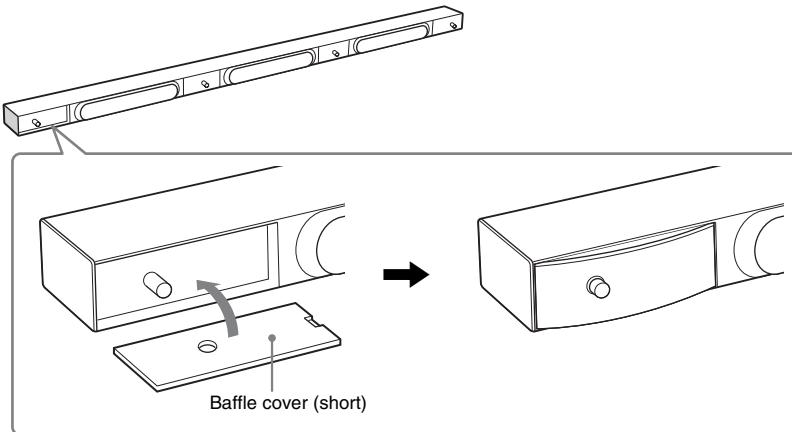

5 Attach the grille to the speaker.

Be careful with the orientation of the grille. The "SONY" logo should be at the left side of the grille.

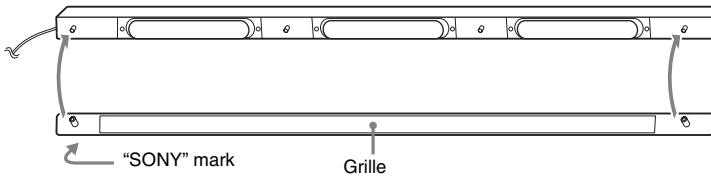

Note

- When assembling, take care not to touch the speaker unit.
- Be sure to use the speakers with their grilles attached.
- Do not push on the attached grille. It may cause damage to the speaker unit.

6 Attach the foot pads to the bottom of the speaker.

Attach the foot pads (thick) to the front of the speaker and the foot pads (thin) to the rear so that the speaker tilts up when installed on a TV stand, etc.

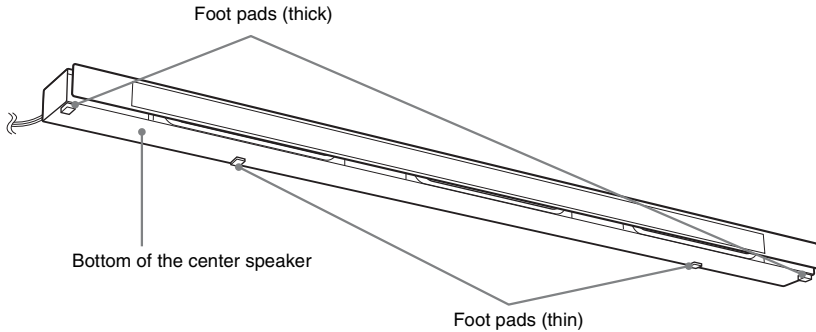

Side view

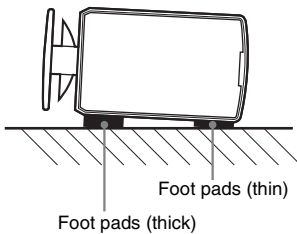

Assembling the front and surround speakers with the speaker stands

1 Attach the pole to the floor base.

When attaching, match the orientation of the protruding parts of the pole and the base. Secure the pole to the floor base with two long black screws (supplied).

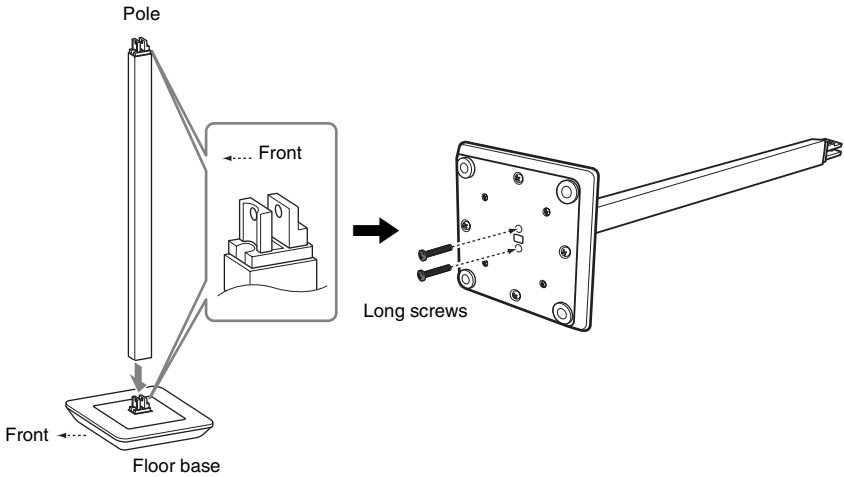

2 Thread the speaker cord through the hole in the bottom of the floor base and pull the cord out from the top of the pole.

Twist the split ends of the speaker cord together before you thread the cord.

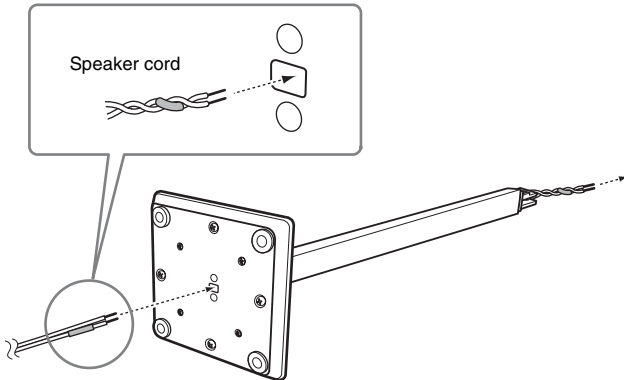

3 Remove the screw from the speaker.

The removed screw is used to attach the speaker to the pole, so be careful not to lose it.

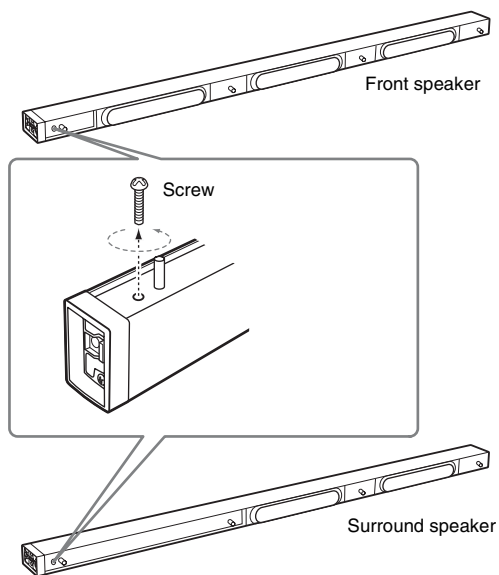
**Note**

- When assembling, take care not to touch the speaker unit.

4 Connect the speaker cords to the speaker.

The connector and color tube of the speaker cords are the same color as the label of the jacks to be connected.

Use the speaker cords as follows:

- Front left speaker (L): White
- Front right speaker (R): Red
- Surround left speaker (L): Blue
- Surround right speaker (R): Gray

Be sure to match the speaker cords to the appropriate terminals on the speakers: the speaker cord with the color tube to \oplus , and the speaker cord without the color tube to \ominus . Do not catch the speaker cord insulation in the speaker terminals.

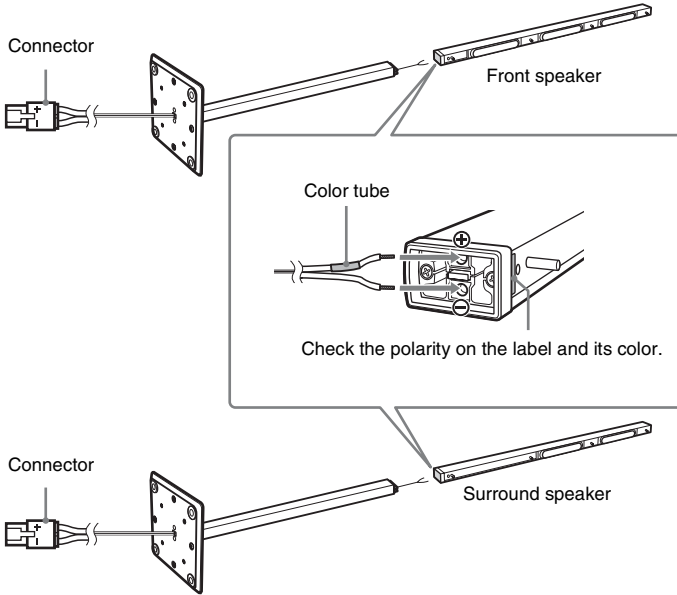

Insert the speaker cords into the speaker terminal of the speaker as far as they will go. Ensure that the cords are secure by gently pulling on them one at a time.

Note

- When assembling, take care not to touch the speaker unit.

Tip

- When removing the speaker cords from the speaker terminals, pull out the speaker cords while pressing the white button on the speaker terminal with a tool such as a flathead screwdriver.

5 Attach the speaker to the pole.

When attaching, match the orientation of the pole and speaker.

Secure the speaker with the screw removed in Step 3.

Front speaker

Surround speaker

Front speaker

Surround speaker

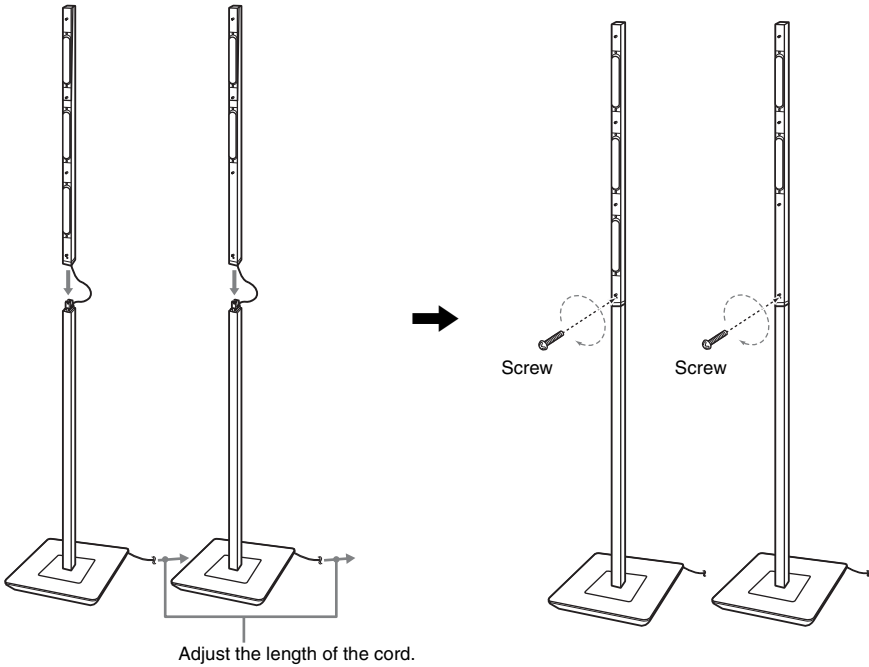

Note

- When assembling, take care not to touch the speaker unit.

6 Take up the slack in the speaker cord by pulling from the bottom of the floor base and secure it by running through the cord retainers.

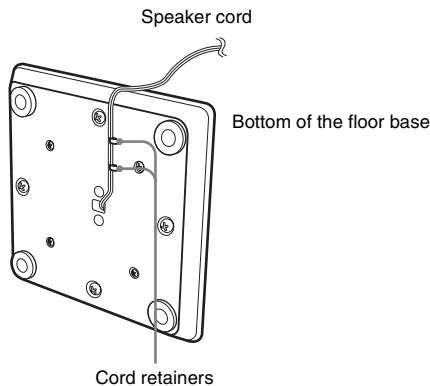

7 Attach the baffle cover to the speaker.

Use the baffle cover (short) for the front speaker, baffle cover (long) for the surround speaker. Press the ends of the baffle cover over the pin(s), then press down to flush fit the speaker front.

Front speaker

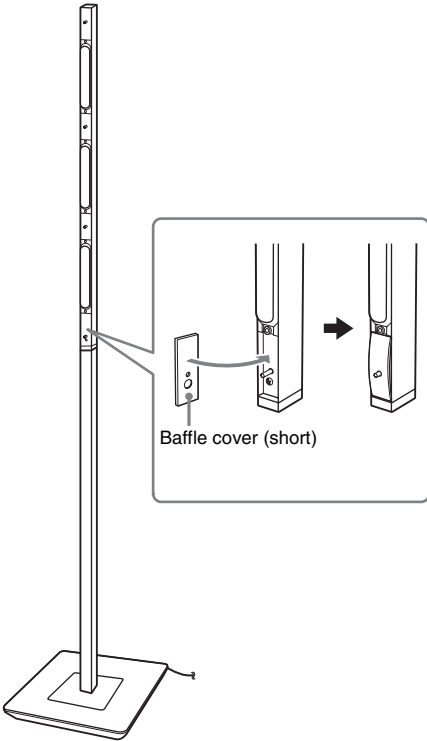

Surround speaker

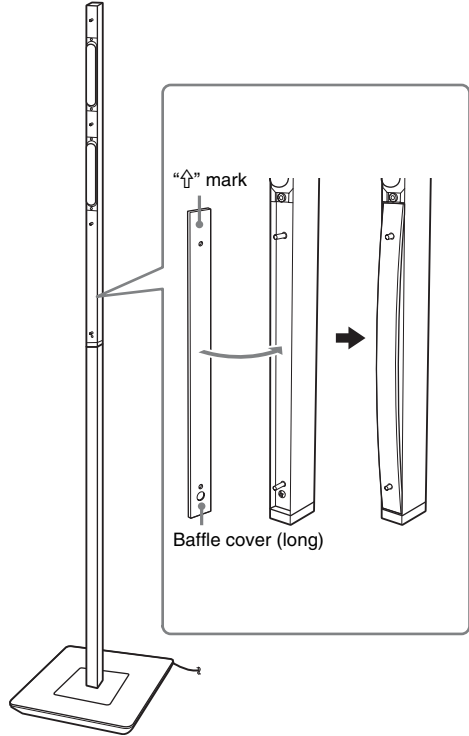

8 Attach the grille to the speaker.

Be careful with the orientation of the grille. The "SONY" logo should be at the bottom of the grille.

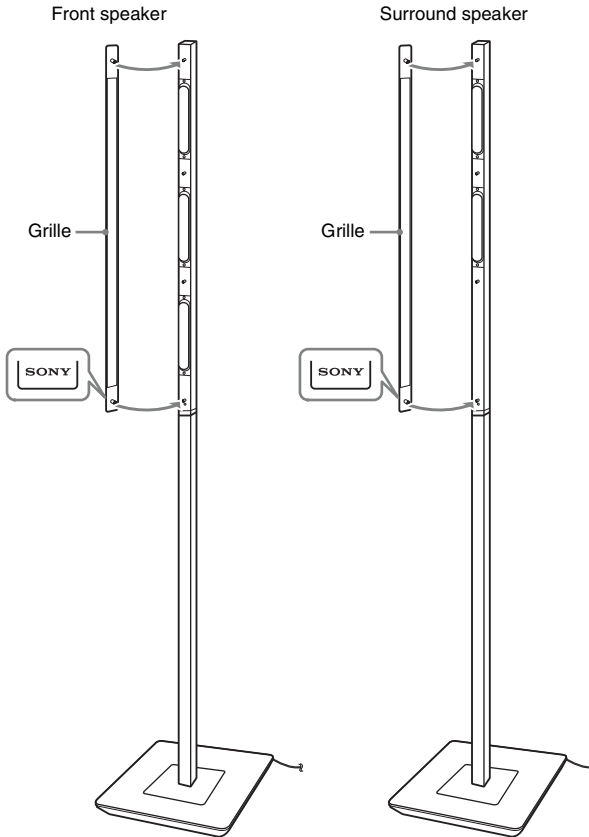

Note

- When assembling, take care not to touch the speaker unit.
- Be sure to use the speakers with their grilles attached.
- Do not push on the attached grille. It may cause damage to the speaker unit.

Fully-assembled illustration with the speaker stands

Front left speaker (L):
White label

Front right speaker (R):
Red label

Surround left speaker (L):
Blue label

Surround right speaker (R):
Gray label

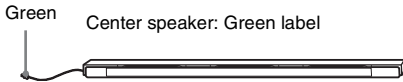
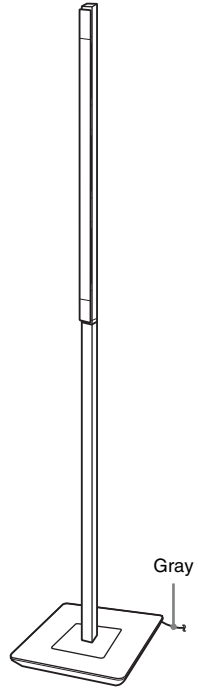
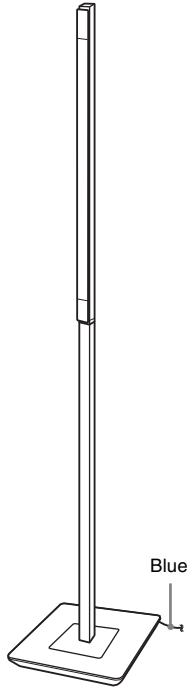
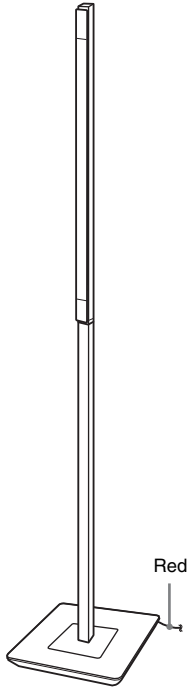
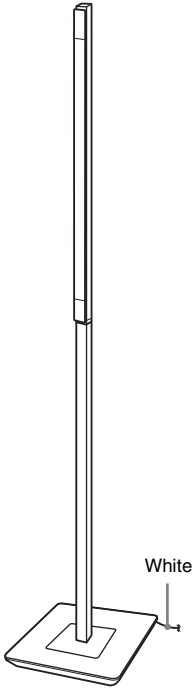

Note

- When moving the speakers, hold the floor base and the pole (①), not the speaker part (②).

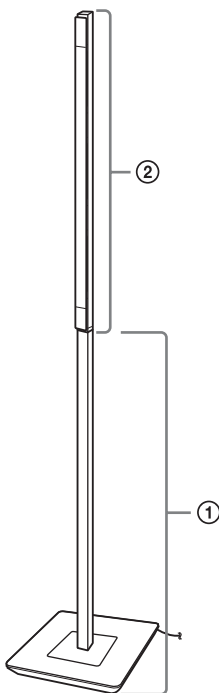

Assembling the front and surround speakers with the desktop stands

- 1 Unscrew the short screws from the bottom of the floor base and detach the desktop stand from the floor base.

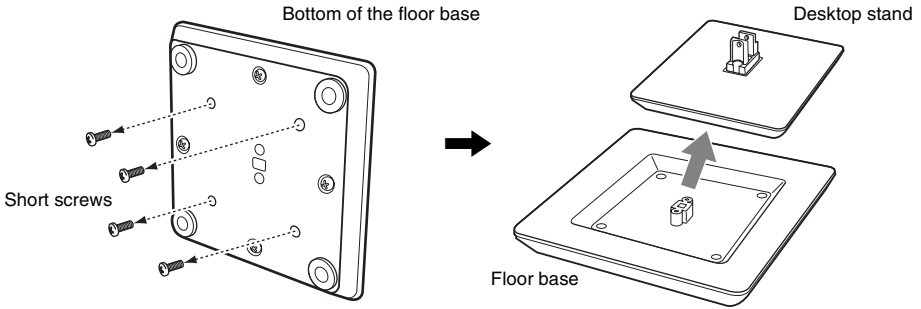
**Note**

- Set aside the removed screws so that you do not lose them.

- 2 Thread the speaker cord through the hole in the bottom of the desktop stand.

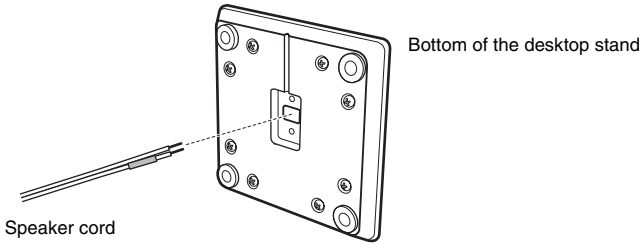

3 Remove the screw from the speaker.

The removed screw is used when attaching the desktop stand. Be sure not to lose the screw.

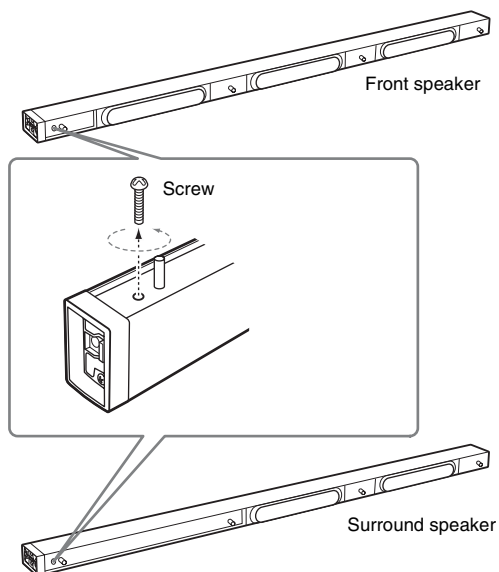
**Note**

- When assembling, take care not to touch the speaker unit.

4 Connect the speaker cords to the speaker.

The connector and color tube of the speaker cords are the same color as the label of the jacks to be connected.

Use the speaker cords as follows:

- Front left speaker (L): White
- Front right speaker (R): Red
- Surround left speaker (L): Blue
- Surround right speaker (R): Gray

Be sure to match the speaker cords to the appropriate terminals on the speakers: the speaker cord with the color tube to \oplus , and the speaker cord without the color tube to \ominus . Do not catch the speaker cord insulation in the speaker terminals.

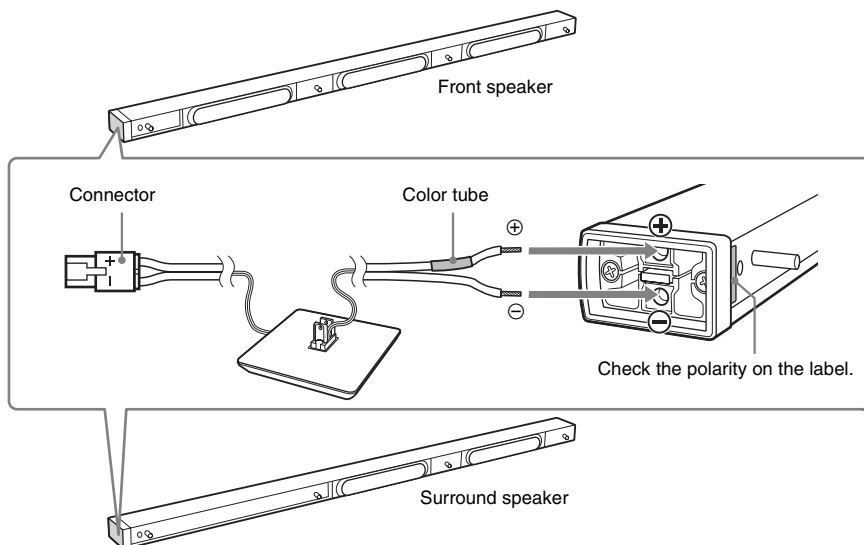

Insert the speaker cords into the speaker terminal of the speaker as far as they will go. Ensure that the cords are secure by gently pulling on them one at a time.

Note

- When assembling, take care not to touch the speaker unit.

Tip

- When removing the speaker cords from the speaker terminals, pull out the speaker cords while pressing the white button on the speaker terminal with a tool such as a flathead screwdriver.

5 Attach the speaker to the desktop stand.

When attaching, match the orientation of the desktop stand and speaker.
Secure the speaker with the screw removed in Step 3.

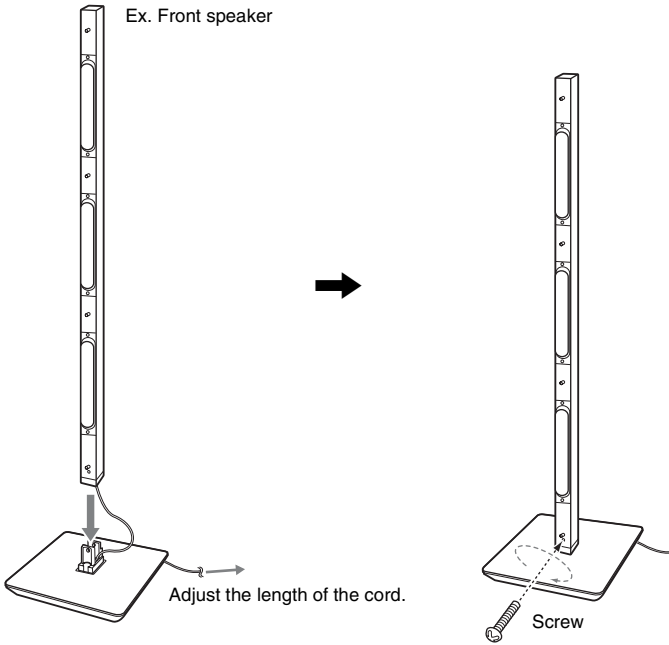

Note

- When assembling, take care not to touch the speaker unit.

6 Take up the slack in the speaker cord by pulling from the bottom of the desktop stand and secure the speaker cord by running it through the slot.

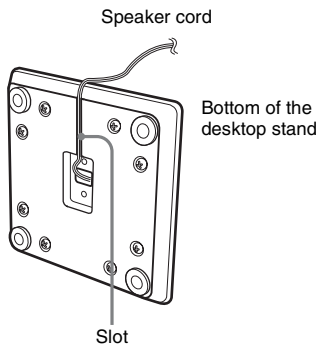

Note

- When assembling, take care not to touch the speaker unit.

7 Attach the baffle cover to the speaker.

Use the baffle cover (short) for the front speaker, baffle cover (long) for the surround speaker. Press the ends of the baffle cover over the pin(s), then press down to flush fit the speaker front.

Front speaker

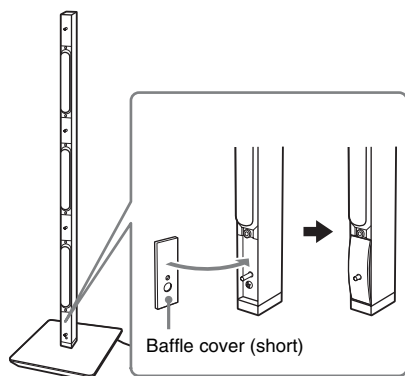

Surround speaker

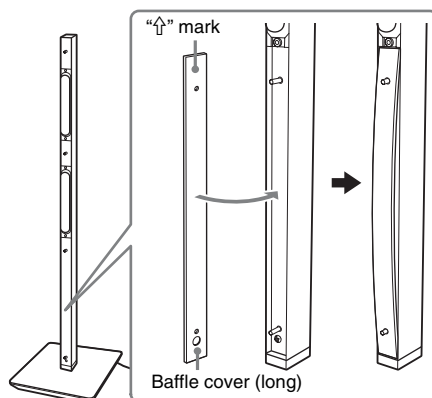

Note

- When assembling, take care not to touch the speaker unit.

8 Attach the grille to the speaker.

Be careful with the orientation of the grille. The "SONY" logo should be at the bottom of the grille.

Front speaker

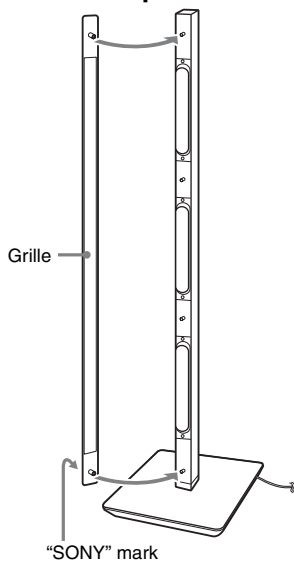

Surround speaker

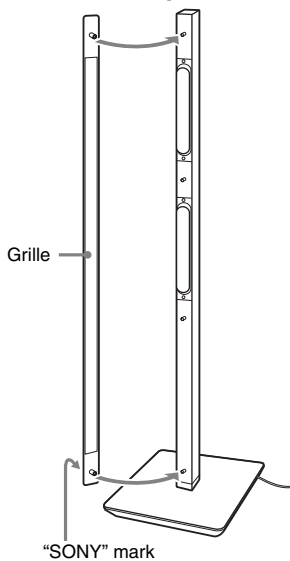

Note

- When assembling, take care not to touch the speaker unit.
- Be sure to use the speakers with their grilles attached.
- Do not push on the attached grille. It may cause damage to the speaker unit.

Fully-assembled illustration with the desktop stands

Front left speaker (L):
White label

Front right speaker (R):
Red label

Surround left speaker (L):
Blue label

Surround right speaker (R):
Gray label

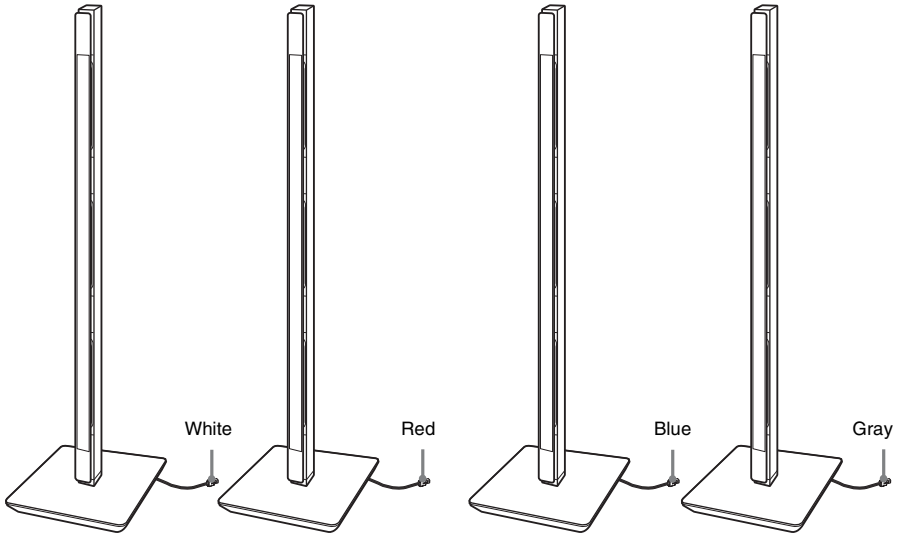

Green

Center speaker: Green label



Note

- When moving the front or surround speaker, hold the desktop stand part (①), not the speaker part (②).

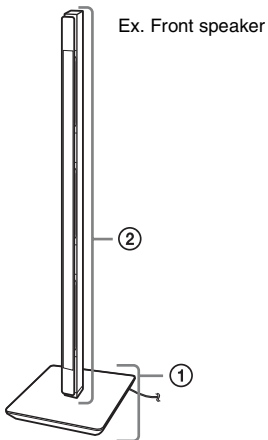

Step 2: Positioning the System

For the best possible surround sound, all the speakers other than the subwoofer should be placed at the same distance from the listening position (A).

Place the system as illustrated below.

BDV-IT1000

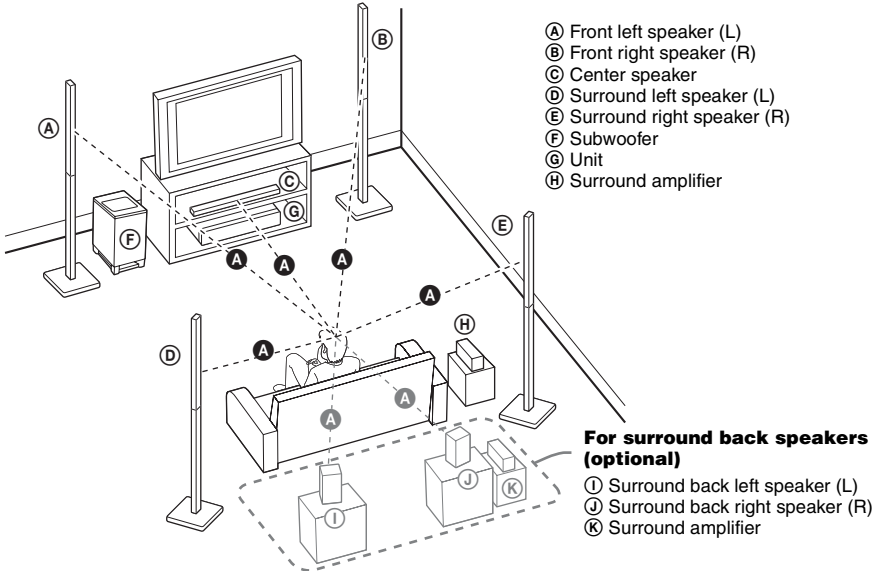

BDV-IS1000

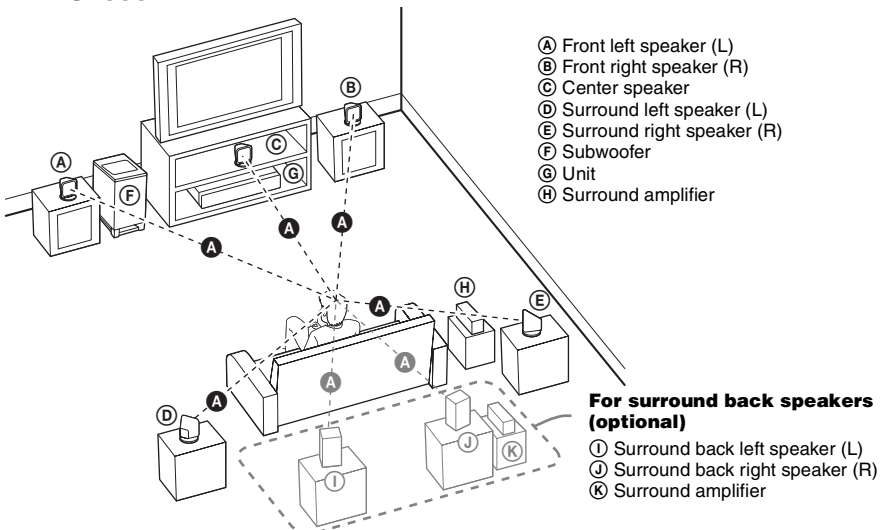

About the surround back speaker

You can enjoy 7.1 surround sound with the surround back speakers by purchasing the additional surround amplifier (optional). Use the commercially available speakers for the surround back speakers. To use the surround amplifier for the surround back speakers, connect the surround back speakers (not supplied) to the surround amplifier, see “Using an S-AIR Product” (page 99).

Note

- Avoid placing obstructions around the speaker.
- After installing the speakers, arrange the speaker cords so as not to topple the speakers by catching the speaker cords with your foot.
- Avoid placing the center speaker on the TV.
- Do not set the speakers in an inclined position.
- Avoid placing the speakers in locations that are:
 - Extremely hot or cold
 - Dusty or dirty
 - Very humid
 - Subject to vibrations
 - Subject to direct sunlight
- Use caution when placing the speakers and/or speaker stands attached to the speakers on a specially treated (waxed, oiled, polished, etc.) floor, as staining or discoloration may result.
- Do not use any type of abrasive pad, scouring powder, or solvent such as alcohol or benzene.
- Do not lean or hang on the speaker, as the speaker may fall down.
- Do not bend, twist, or fold the speaker grille. (BDV-IT1000 only)
- Do not insert an object (especially metal) into a hole on the front part of the speaker. (BDV-IT1000 only)
- Avoid placing the speakers close to a CRT-based TV. It may cause color irregularity. (BDV-IT1000 only)
- When using the speaker stands, we recommend that the speakers are installed on a flat and firm floor (not on a thick pile carpet, for example). The speakers may topple over if installed on an inclined or soft floor.

Tip

- When you change the positions of the speakers, Sony recommends that you change the settings. For details, see “Calibrating the Appropriate Settings Automatically” (page 108) and “Setting the Speakers” (page 110).

Using the subwoofer efficiently

To reinforce the bass sound, place the subwoofer as close as possible to a wall.

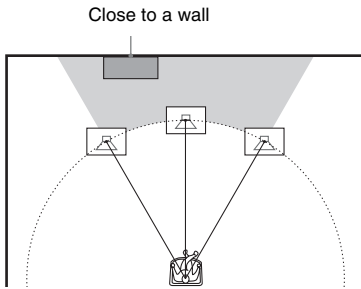

Note

- If the subwoofer is to be placed ahead of the front speaker, the distance should be less than 0.5 m (1.6 ft).*

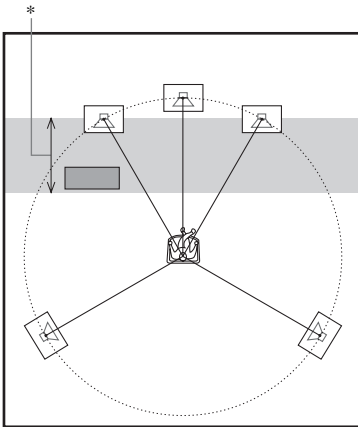

- You may not get the bass sound efficiently when the subwoofer is placed outside (③). You need to adjust the setting of the distance from the listening position.

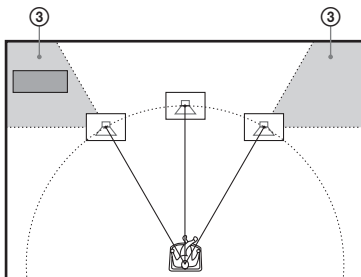

- Do not place objects on the top of the subwoofer where the speaker unit is installed.

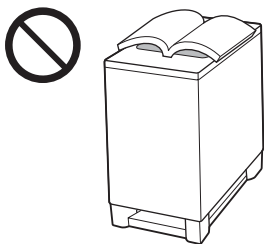

- Do not place the subwoofer under a desk or in a cabinet, etc.

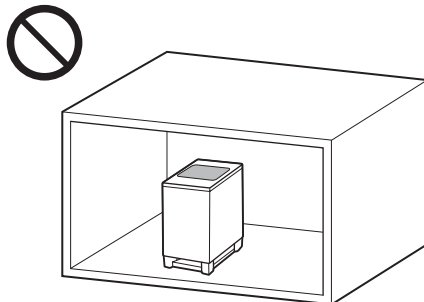
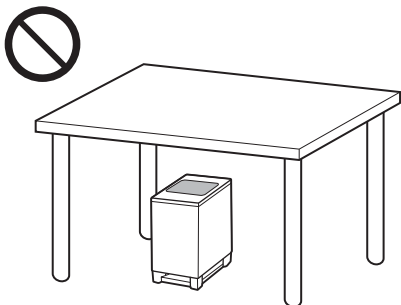

- Do not place the subwoofer behind an obstruction, such as a TV, etc. Middle range sound will fall.

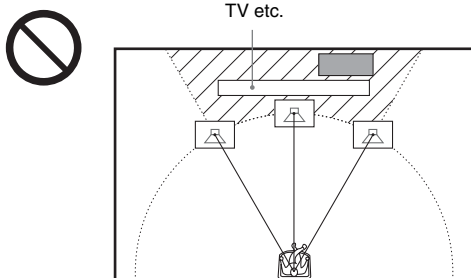

Note on handling the subwoofer

- Do not place your hand into the slit of the subwoofer when lifting it. The speaker driver may be damaged. When lifting, hold the bottom of the subwoofer.

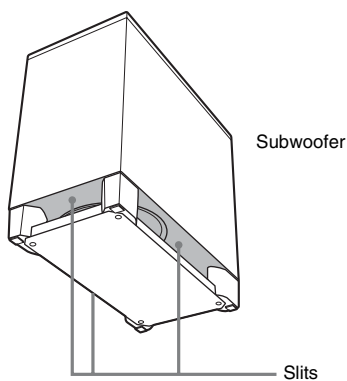

- Do not push the top of the subwoofer where the speaker unit is installed.

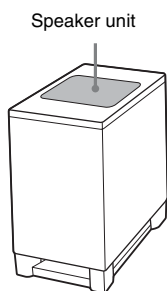

Installing the speakers on a wall

Caution

- Contact a screw shop or installer regarding the wall material or screws to be used.
- Use screws that are suitable for the wall material and strength. As a plaster board wall is especially fragile, attach the screws securely to a beam and fasten them to the wall. Install the speakers on a vertical and flat wall where reinforcement is applied.
- Sony is not responsible for accident or damage caused by improper installation, insufficient wall strength or improper screw installation, natural calamity, etc.

BDV-IT1000

1 Decide the installation of the speakers.

Recommended example:

Front View

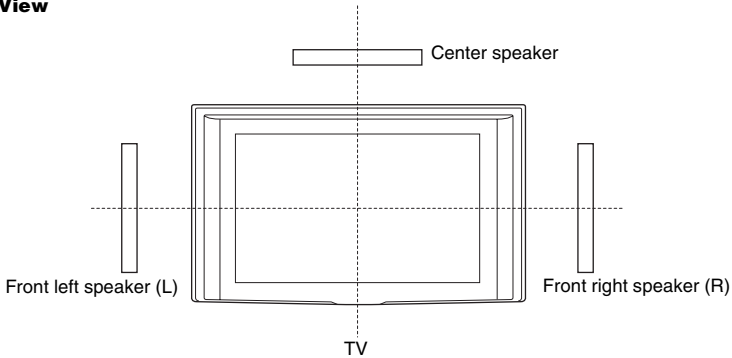

Position the front speakers so that their centers align with the TV. Position the center speaker so that the center of the speaker and the TV are aligned.

Top View

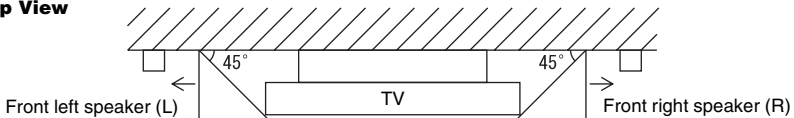

The surround speakers should be placed as high (or a little higher) than the front speakers.

Tip

- For details about positioning the speakers, see “Step 2: Positioning the System” (page 37).

2 Decide the speaker position and mark the screw positions.

You need two screws (not supplied) for each bracket. The following indicates the narrower positions of the two screws.

For the front/surround speakers

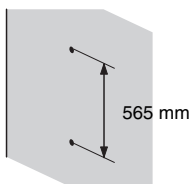

For the center speaker

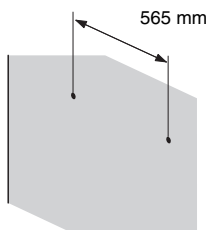

3 Remove the cover(s) from the speaker.

Pry up the cover by inserting a thin, flat object into the slit in the cover.

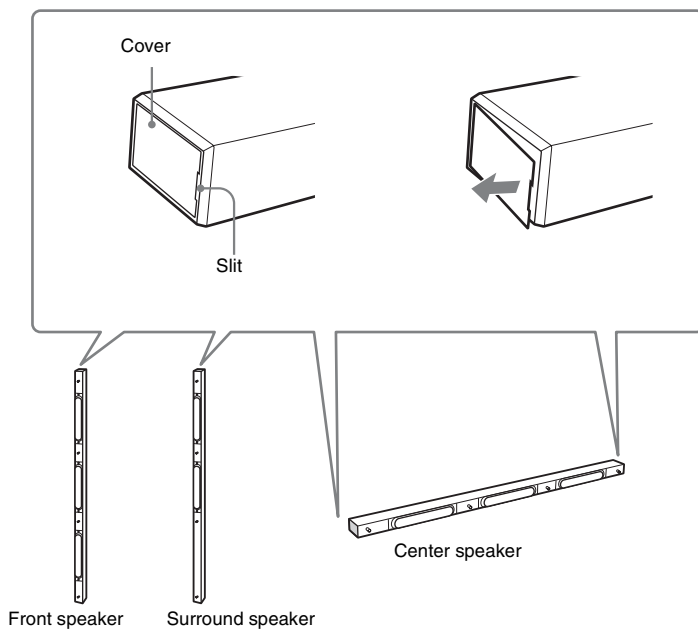

Note

- When assembling, take care not to touch the speaker unit.

4 Connect the speaker cords to the speaker.

Thread the speaker cord through the holes in the bracket (bottom).

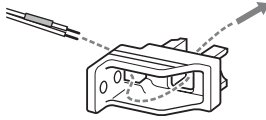

Use the speaker cords as follows:

- Front left speaker (L): White
- Front right speaker (R): Red
- Surround left speaker (L): Blue
- Surround right speaker (R): Gray
- Center speaker: Green

The connector and color tube of the speaker cords are the same color as the label of the jacks to be connected. Be sure to match the speaker cords to the appropriate terminals on the speakers: the speaker cord with the color tube to \oplus , and the speaker cord without the color tube to \ominus . Do not catch the speaker cord insulation in the speaker terminals.

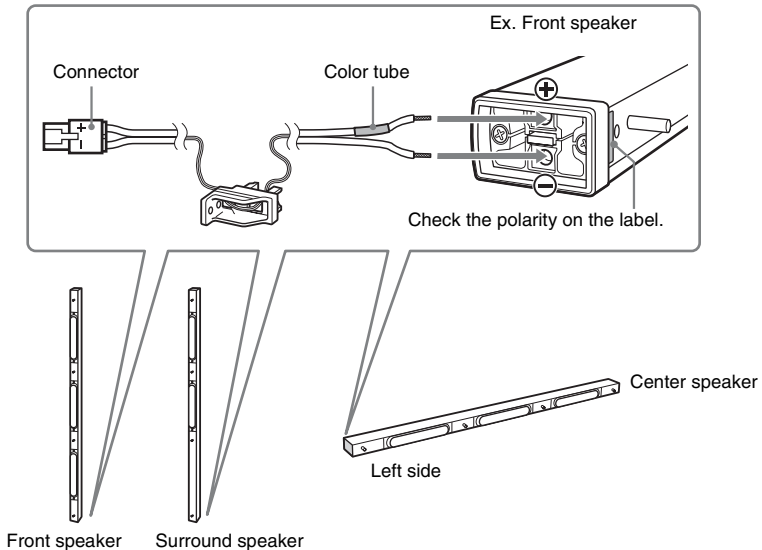

Insert the speaker cords into the speaker terminal of the speaker as far as they will go. Ensure that the cords are secure by gently pulling on them one at a time.

Note

- When assembling, take care not to touch the speaker unit.

Tip

- When removing the speaker cords from the speaker terminals, pull out the speaker cords while pressing the white button on the speaker terminal with a tool such as a flathead screwdriver.

5 Attach the baffle cover to the speaker.

Use the baffle cover (short) for the front speaker and center speaker, baffle cover (long) for the surround speaker. Press the ends of the baffle cover over the pin(s), then press down to flush fit the speaker front.

Front speaker

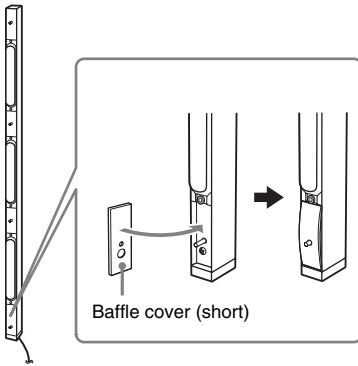

Surround speaker

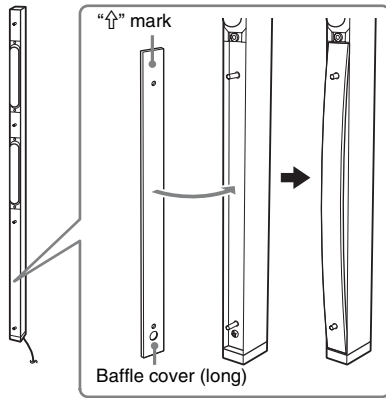

Center speaker

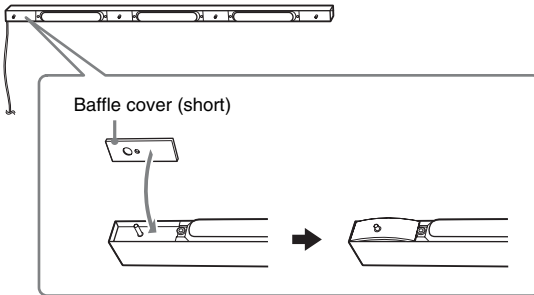

6 Attach the bracket (bottom) to the speaker.

Insert the bracket (bottom) into the speaker tightly.

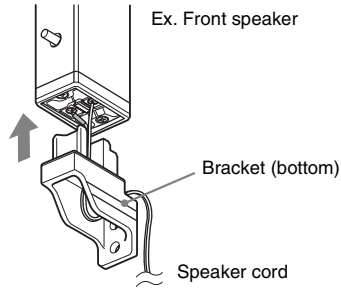

Note

- When attaching the bracket, take care not to catch the speaker cord between the speaker and bracket.
- When assembling, take care not to touch the speaker unit.

7 Attach the bracket (top) to the speaker.

Insert the bracket (top) into the speaker and secure it with the screw (supplied).

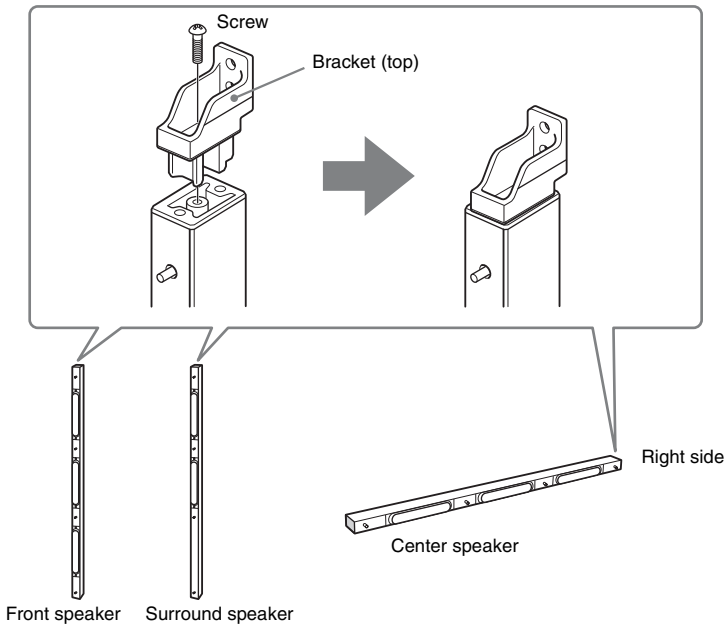

Note

- When assembling, take care not to touch the speaker unit.

8 Secure the speaker to the wall.

Check the horizontal and vertical position and tightly attach the speaker to the wall (making sure the wall is sufficiently thick) using two suitable screws for each bracket (not supplied) in order ① and ②.

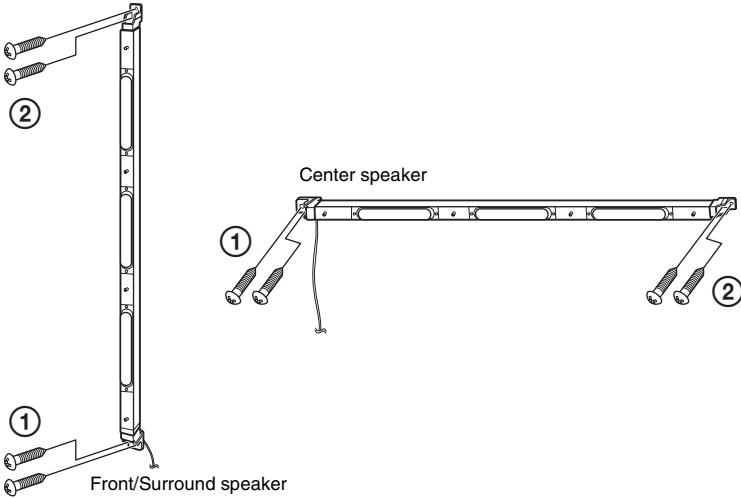

Note

- When attaching the speaker, take care not to catch the speaker cord between the speaker and the wall.
- When assembling, take care not to touch the speaker unit.

9 Attach the bracket cover to the speaker.

Slide the bracket cover from the front of the speaker.

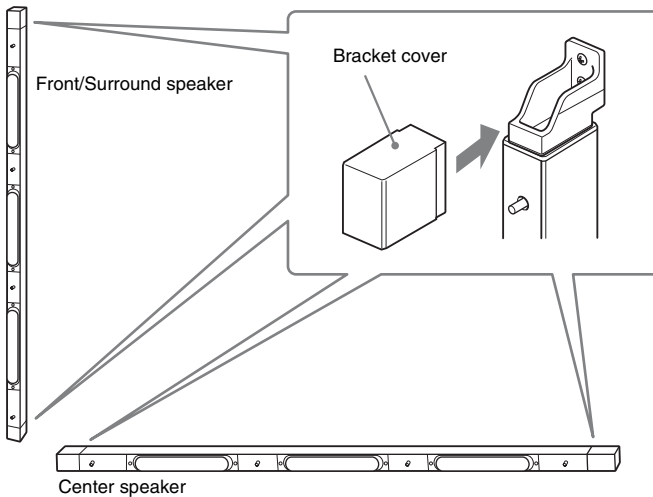

10 Attach the grille to the speaker.

Be careful with the orientation of the grille. The "SONY" logo should be at the bottom of the grille for the front/surround speaker, and at the left side of the grille for the center speaker.

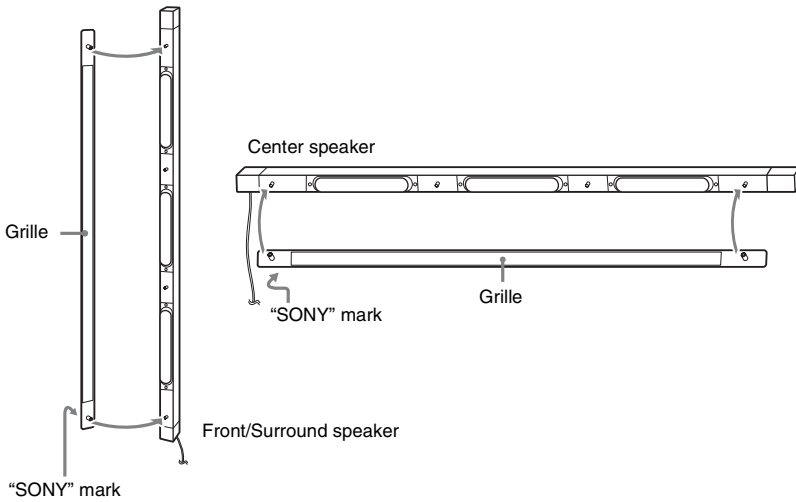
**Note**

- When assembling, take care not to touch the speaker unit.
- Do not push on the attached grille. It may cause damage to the speaker unit.

BDV-IS1000

- 1** Prepare screws (not supplied) that are suitable for the holes of the bracket.
- 2** Secure the bracket to the wall using hole ①.

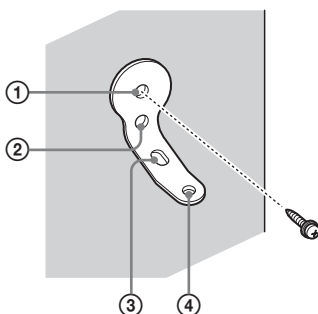
**Tip**

- To prevent the speaker from rotating, use the hole ②, too.

- 3** Remove the rear cap using the wrench (supplied), and remove the speaker pedestal using a screwdriver (+) (not supplied).

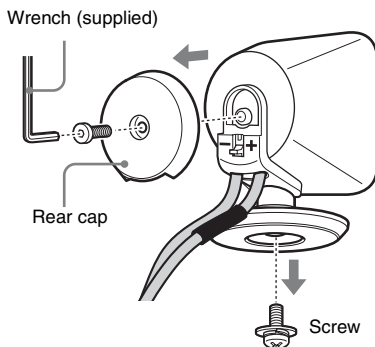
**Note**

- The removed screw is used in a later step. Be sure not to lose the screw.

- 4** Push **A** with the supplied wrench (1), and then remove the speaker cords (2).

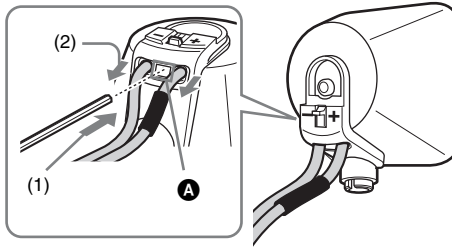

When the lever is down, the speaker cords are locked.

When the lever is up, the speaker cords can be removed.

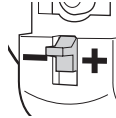
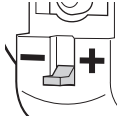

- 5** Thread the speaker cords through hole **3**.

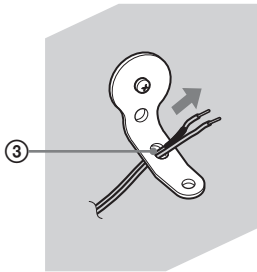

- 6** Reconnect the detached speaker cords, matching \oplus/\ominus to the appropriate speaker terminals (1), and then push the lever down completely (2).

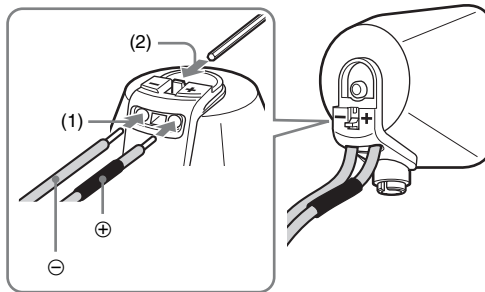

Tip

- If it is difficult to push the lever down, use the wrench (supplied).

7 Reattach the rear cap using the wrench (supplied).

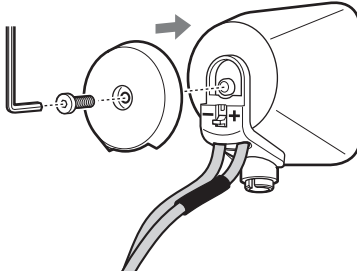

8 Secure the speaker to the bracket with the screw in Step 3 using hole ④.

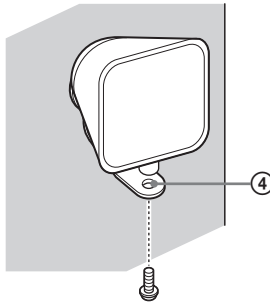

Step 3: Connecting the System

See the connection diagram below, and read the additional information from ① to ⑧ on the following pages.

Note

- Be sure to make connections securely to avoid hum and noise.
- When you connect another component with a volume control, turn up the volume of the other components to a level where sound is not distorted.

BDV-IT1000

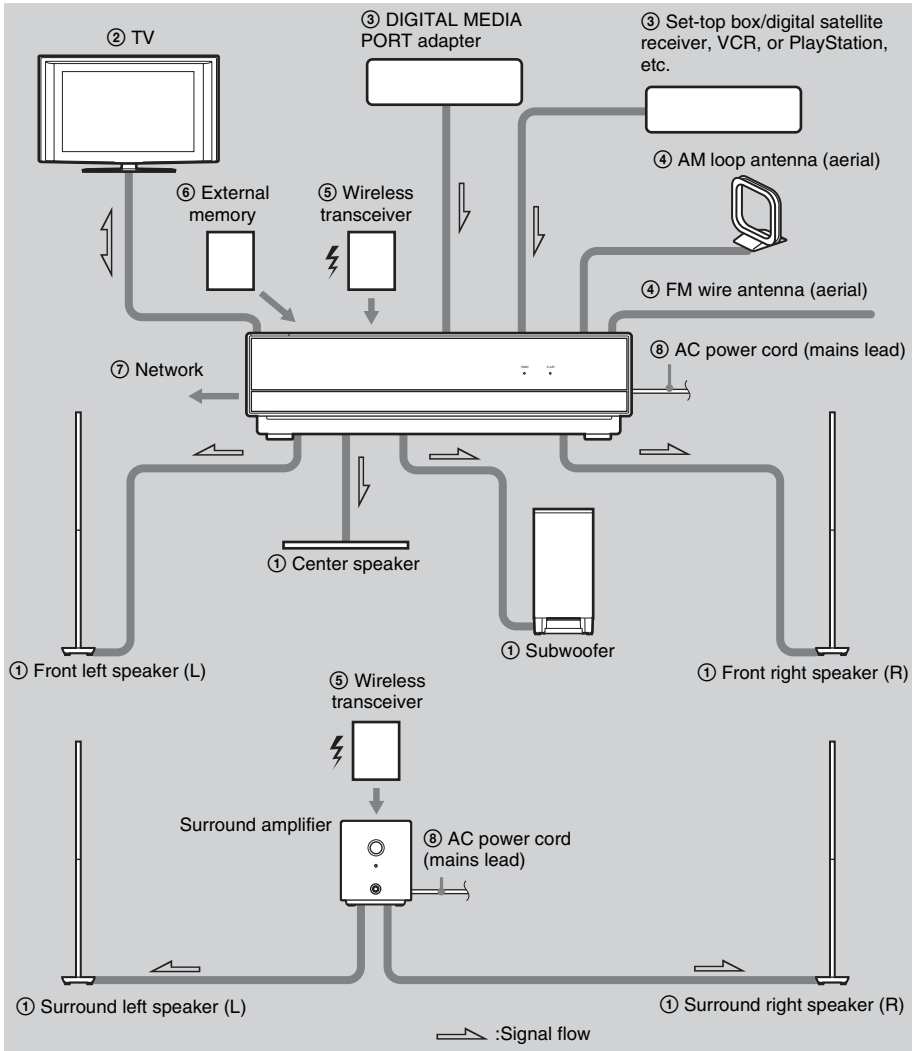

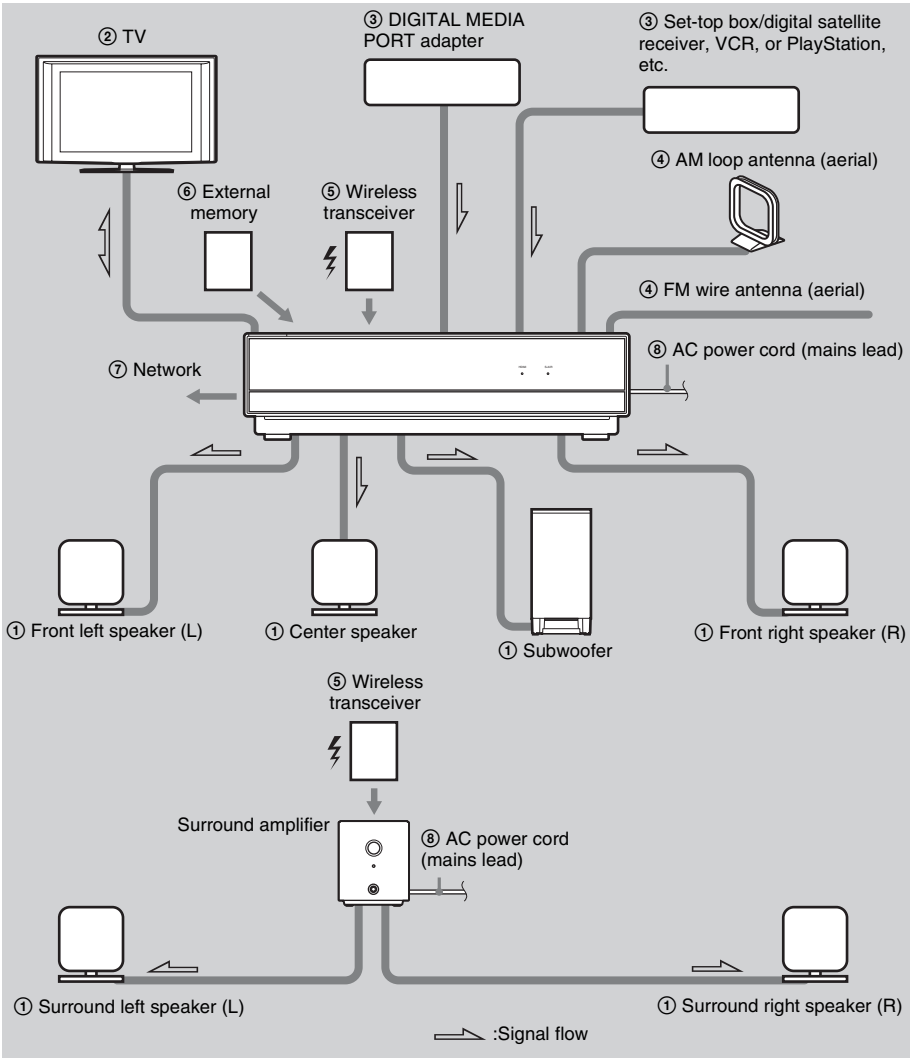

① Connecting the Speakers

Front/center speakers and subwoofer for BDV-IT1000

When connecting speaker cords to the unit, insert the connector until it clicks.

Rear panel of the unit

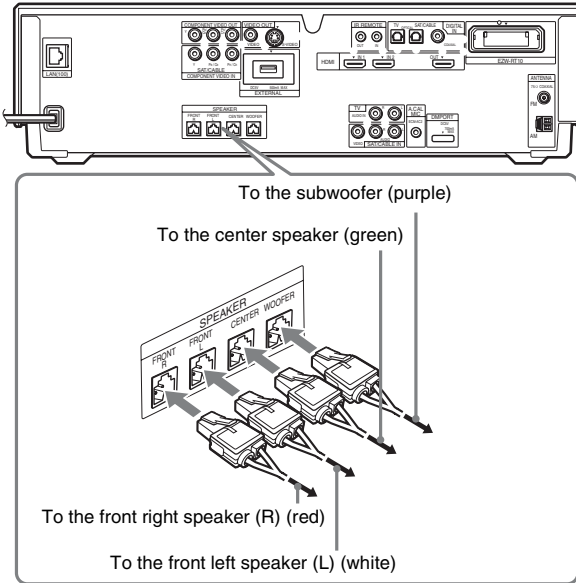

When connecting the speaker cords to the subwoofer, use the speaker cords (purple). Be sure to match the speaker cords to the appropriate terminals on the speakers: the speaker cord with the color tube to \oplus , and the speaker cord without the color tube to \ominus . Do not catch the speaker cord insulation in the speaker terminals.

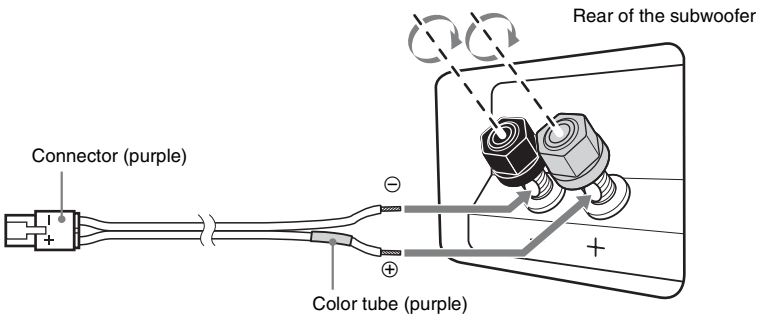

Front/center speakers and subwoofer for BDV-IS1000

When connecting to the unit, insert the connector until it clicks.

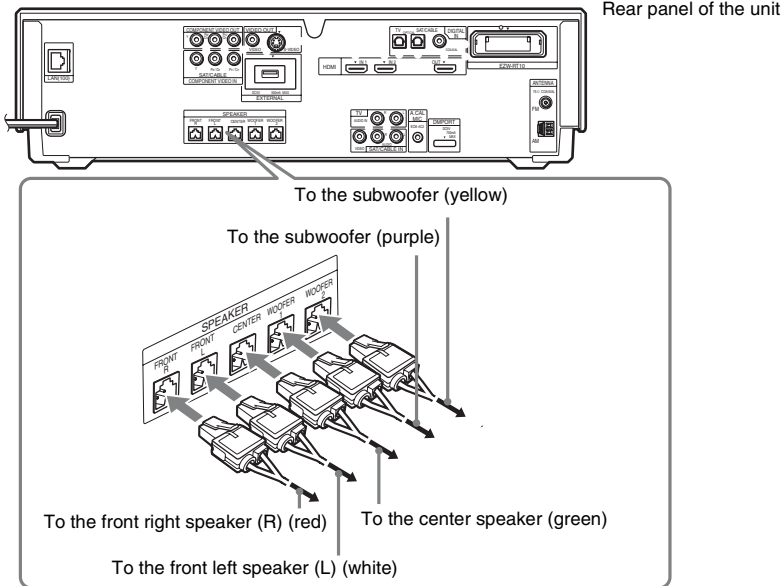

The speaker cords (yellow and purple) are connected to the subwoofer beforehand as follows. When re-connecting, be sure to match the speaker cords to the appropriate terminals on the speakers: the speaker cord with the color tube to \oplus , and the speaker cord without the color tube to \ominus . Do not catch the speaker cord insulation in the speaker terminals.

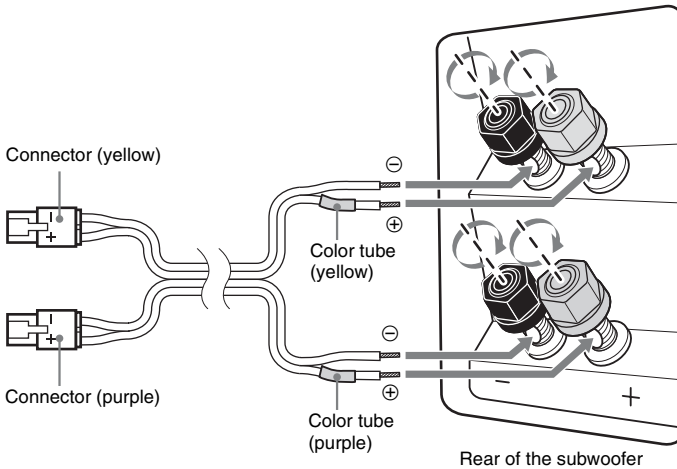

Surround speakers

Rear panel of the surround amplifier

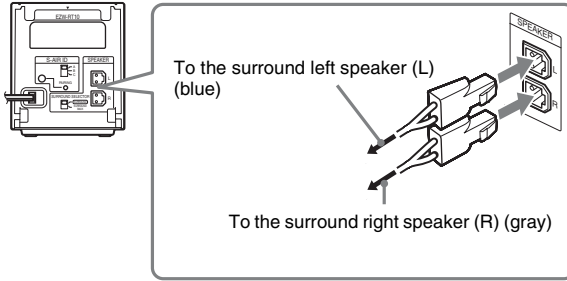

About the speaker cords of the front/center speakers and subwoofer

You can remove the speaker cords from the connector. With the catch facing down, press and hold the connector down against a flat surface (1) and remove the speaker cords from the connector (2).

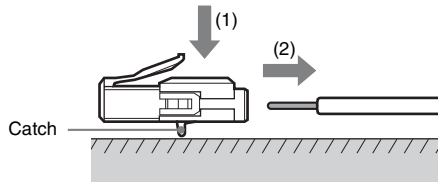

When attaching the speaker cords to the connector, be sure to match the polarity of the speaker cords and the connector.

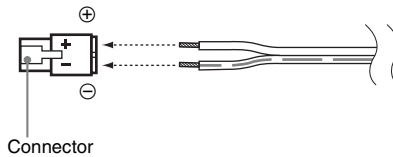

Note

- Short-circuiting of the speakers may damage the system. To prevent this, make sure the bare wire of each speaker cord does not touch another speaker terminal or the bare wire of another speaker cord.
- Be sure to match the speaker cords to the appropriate speaker terminals: \oplus to +, and \ominus to -. If the cords are reversed, the sound will lack bass and may be distorted.

② Connecting the TV

Use the parts as follows:

- Video cord (1)

To listen to TV sound from the six speakers of the system, connect the TV and the system with the audio cord (not supplied) (A).

For video output to your TV, check the video input jacks of the TV, and select connection method (A), (B), (C), or (D). Picture quality improves in order from (A) (standard) to (D) (HDMI).

When the TV has the digital optical output jack, you can improve sound quality by connecting with the digital optical cord (not supplied) (B).

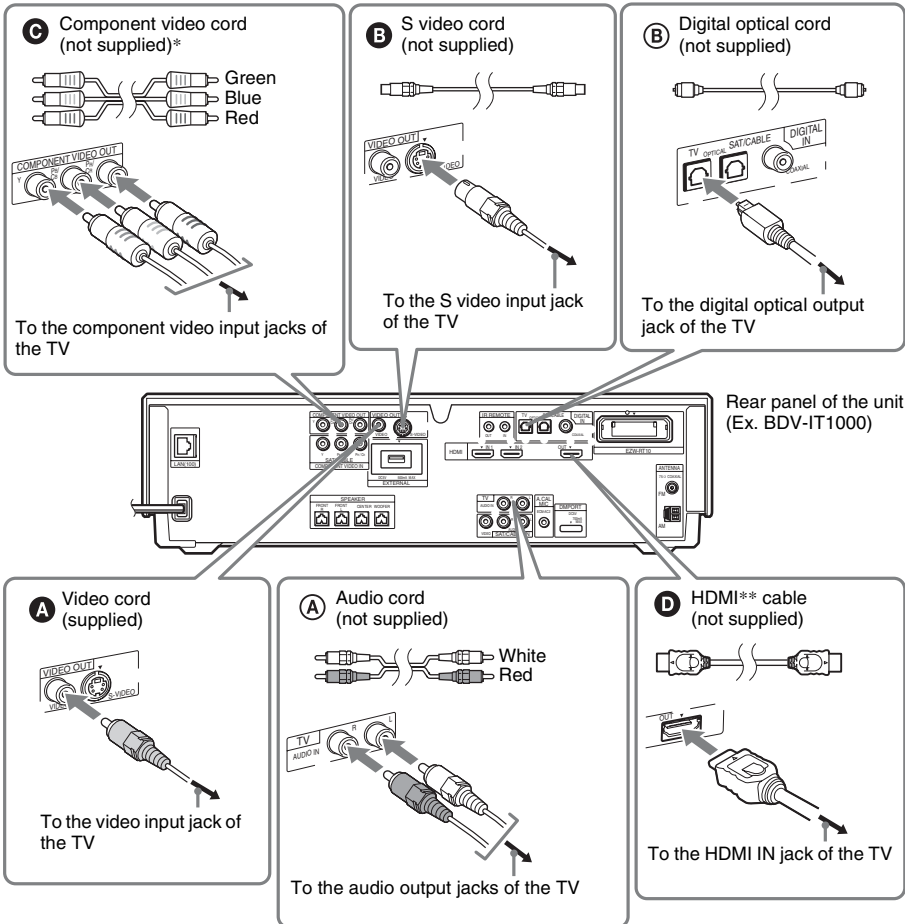

* If your TV accepts progressive format signals, make this connection.

** HDMI (High-Definition Multimedia Interface)

If your TV has the HDMI jack, make this connection.

About the HDMI connection

If you connect a 1080/24p- or 1080p-compatible TV, use a High Speed HDMI cable.

If you connect a Sony TV that is compatible with the Control for HDMI function (page 105), operation is simplified (ex. ONE-TOUCH PLAY: With one touch of the button, the connected TV turns on and the input selector on the TV is switched to the system automatically). For details, see “Using the Control for HDMI Function for “BRAVIA” Sync” (page 105).

Note

- Be sure to use only an HDMI cable that bears the HDMI logo.
- When connecting the HDMI cable, make sure that the direction of jacks are the same.

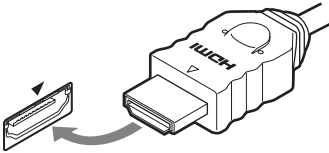

To connect to a TV with DVI input

Use an HDMI-DVI converter cable (not supplied). The DVI jack does not accept audio signals; therefore, the sound is not output from a TV.

Furthermore, you cannot connect the HDMI OUT jack to DVI jacks that are not HDCP compliant (e.g., DVI jacks on PC displays).

③ Connecting the other components

You can enjoy the connected component(s) using the six speakers of the system.

- Set-top box/digital satellite receiver, VCR, or PlayStation, etc. (without HDMI OUT jack): ①
- Set-top box/digital satellite receiver or PLAYSTATION®3, etc. (with HDMI OUT jack): ②
- DIGITAL MEDIA PORT adapter: ③

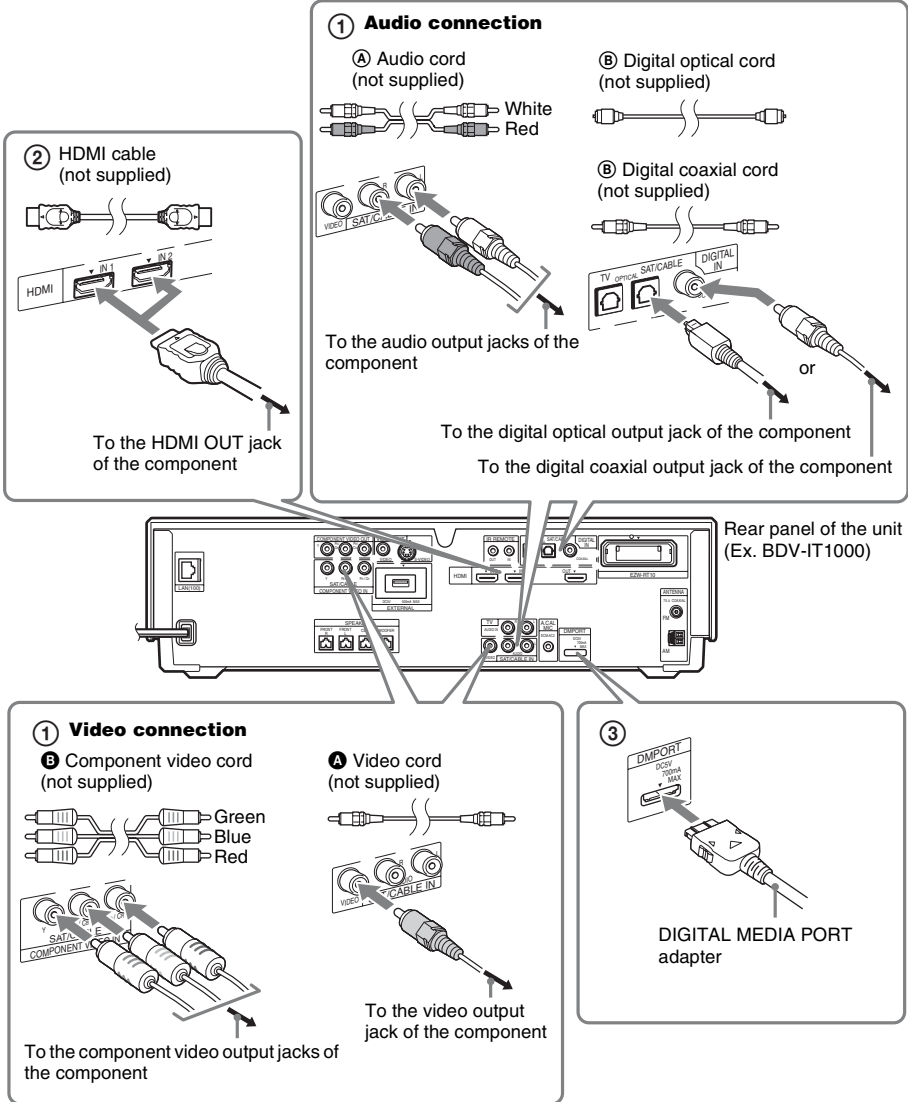

Connection ① (SAT/CABLE jacks)

You need to make both video and audio connections.

For video connection, check the video output jacks of the component, and select a connection method.

Ⓑ (component) offers the better picture quality than Ⓐ (standard).

For audio connection, connect the audio cords (Ⓐ). If the component has a digital optical or coaxial output jack, you can improve sound quality by connecting with the digital cord (Ⓑ).

Note

- The system can accept both digital and analog signals. Digital signals have priority over analog signals. (COAXIAL has priority over OPTICAL.) If the digital signal ceases, the analog signal will be processed after 2 seconds.

Connection ② (HDMI IN1/2 jacks)

When connecting the system and the component using an HDMI cable, you can enjoy high quality digital pictures and sound through the HDMI IN1 or 2 jack. You can connect up to two components.

Note

- When connecting the HDMI cable, make sure that the direction of jacks are the same.

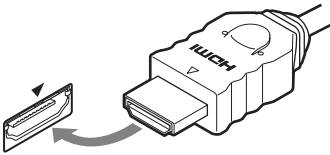

Connection ③ (DMPORT jack)

Connect a DIGITAL MEDIA PORT adapter (not supplied) to the DMPORT jack. For details, see “Using the DIGITAL MEDIA PORT Adapter” (page 98).

Note

- Connect the DIGITAL MEDIA PORT adapter so that the ▼ marks are aligned. When disconnecting, pull out while pressing Ⓐ.

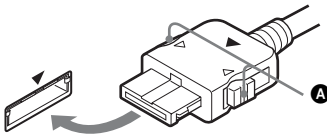

Relationship between input and output video signal

The relationship between input and output video signal for each function is as follows.

Function	Jack(s) that accept video signal input	Jack(s) where video signal is output			
		VIDEO OUT (VIDEO)	VIDEO OUT (S VIDEO)	COMPONENT VIDEO OUT	HDMI OUT
“BD/DVD” “TUNER FM” “TUNER AM”	None (only video signal output)	○*	○*	○*	○
“SAT/CABLE”	SAT/CABLE IN (VIDEO)	○	–	–	○
	COMPONENT VIDEO IN (SAT/CABLE)	–	–	○	○
“DMPORT”	DMPORT	○	–	–	○
“HDMI1” “HDMI2”	HDMI1, HDMI2	–	–	–	○

○: Video signals are output.

–: Video signals are not output.

* Depending on the setting of the video output resolution, video signals may be not output. For details, see “Video Output Resolution” (page 144).

Relationship between input and output audio signal

The relationship between input and output audio signal for each function is as follows.

Function	Jack(s) that accept audio signal input	Jack(s) where audio signal is output	
		SPEAKER	SPEAKER and HDMI OUT
“BD/DVD”	None (only audio signal output)	○	*
“TUNER FM” “TUNER AM”	None (only audio signal output)	○	–
“TV”	DIGITAL IN (TV OPTICAL)	○	–
	TV (AUDIO IN R/L)	○	–
“SAT/CABLE”	DIGITAL IN (SAT/CABLE OPTICAL, COAXIAL)	○	–
	SAT/CABLE IN (AUDIO R/L)	○	–
“DMPORT”	DMPORT	○	–
“HDMI1” “HDMI2”	HDMI1, HDMI2	○	*

○: Audio signals are output.

–: Audio signals are not output.

* You can output sound from both the system’s speakers and TV speaker if you connect the system and TV with an HDMI cable (not supplied). To output sound from the HDMI OUT jack, set [Audio (HDMI)] in [HDMI Settings] to [TV+AMP]. If the TV has stereo speakers, the sound output from the system’s speakers will also be stereo, even if you play a multi-channel source. For details on [Audio (HDMI)], see page 125.

④ Connecting the antenna (aerial)

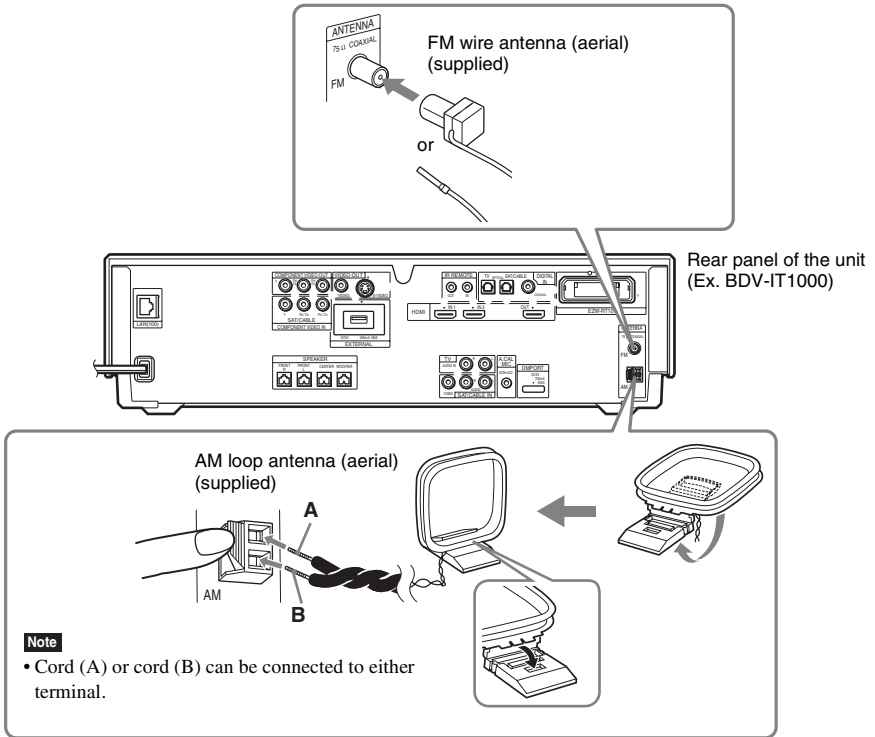

Note

- Keep the AM loop antenna (aerial) and cord away from the system or other AV components, as noise may result.
- Be sure to fully extend the FM wire antenna (aerial).
- After connecting the FM wire antenna (aerial), keep it as horizontal as possible.

Tip

- Adjust the direction of the AM loop antenna (aerial) for best AM broadcast sound.
- If you have poor FM reception, use a 75-ohm coaxial cable (not supplied) to connect the unit to an outdoor FM antenna (aerial) as shown below.

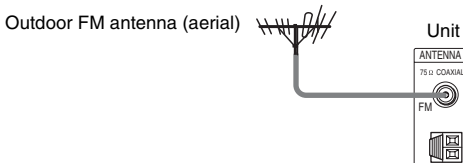

⑤ Inserting the wireless transceiver

You can transmit sound from the unit to an S-AIR product, such as a surround amplifier or S-AIR receiver.

An S-AIR product is a component that is compatible with the S-AIR function.

To use the S-AIR function, you need to insert the wireless transceivers into the unit, surround amplifier, and S-AIR receiver.

For details of the S-AIR function, see “Using an S-AIR Product” (page 99).

Rear panel of the unit (Ex. BDV-IT1000)

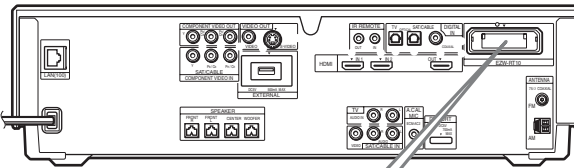

Rear panel of the surround amplifier

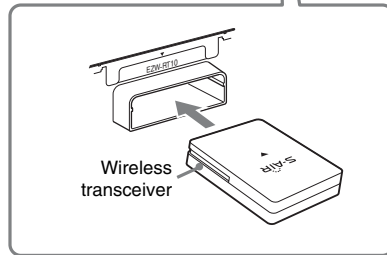
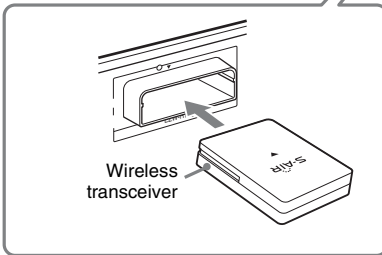
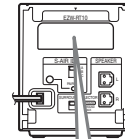

Note

- When you insert the wireless transceiver, make sure that the AC power cord (mains lead) is not connected to a wall outlet (mains).
- Do not touch the terminals of the wireless transceiver.
- Insert the wireless transceiver with the S-AIR logo facing up.
- Insert the wireless transceiver so that the ▼ marks are aligned.
- Do not insert other than the wireless transceiver into the EZW-RT10 slot.

⑥ Inserting the external memory

Insert the external memory (local storage) (not supplied: USM1GH (as of April 2008)) into the EXTERNAL slot. By connecting an external memory, you can enjoy additional contents (BonusView/BD-Live) depending on the disc.

Rear panel of the unit (Ex. BDV-IT1000)

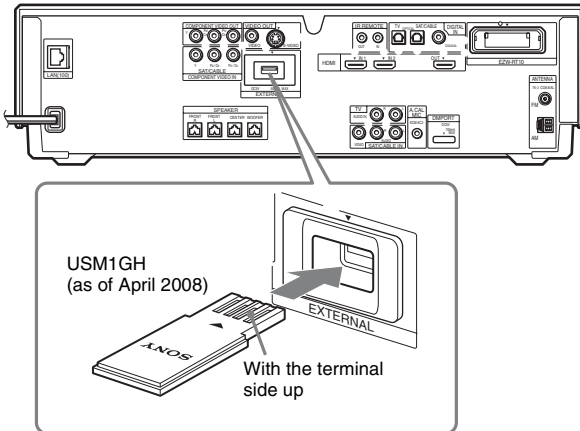

Note

- Insert the external memory in the ▼ direction into the EXTERNAL slot as far as it will go.
- Check that “EXT” lights up in the front panel display when turning the system on.

To enjoy BonusView/BD-Live

See “Enjoying BonusView/BD-Live” (page 78).

To remove the external memory

- 1 Press I/⏻ to turn the system off.
- 2 Pull out the external memory from the EXTERNAL slot.

Note

- Insert the external memory straight. If you force the external memory into the slot, this will cause damage to both the external memory and the unit.
- Keep the external memory away from small children to prevent them from accidentally swallowing the external memory.
- Do not apply too much pressure to the external memory in the slot, as it may cause a malfunction.
- Use the USM1GH (as of April 2008) external memory only.
- To avoid data corruption or damage to the external memory, turn the system off when inserting or removing the external memory.
- Do not insert the external memory that contains photo or music files to avoid corrupting the external memory data.

7 Connecting to the network

Connect the LAN (100) terminal of the unit to your Internet source using a network cable to update the system's software using the network. You can also enjoy BD-Live (page 78). Make the appropriate settings in [Internet Settings] under [Network Settings] (page 127).

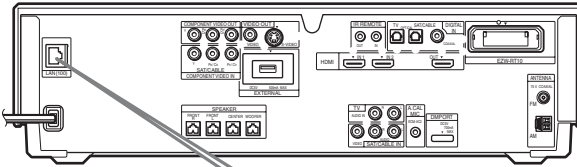

Rear panel of the unit
(Ex. BDV-IT1000)

When connecting to a broadband router directly

When connecting via a wireless LAN router

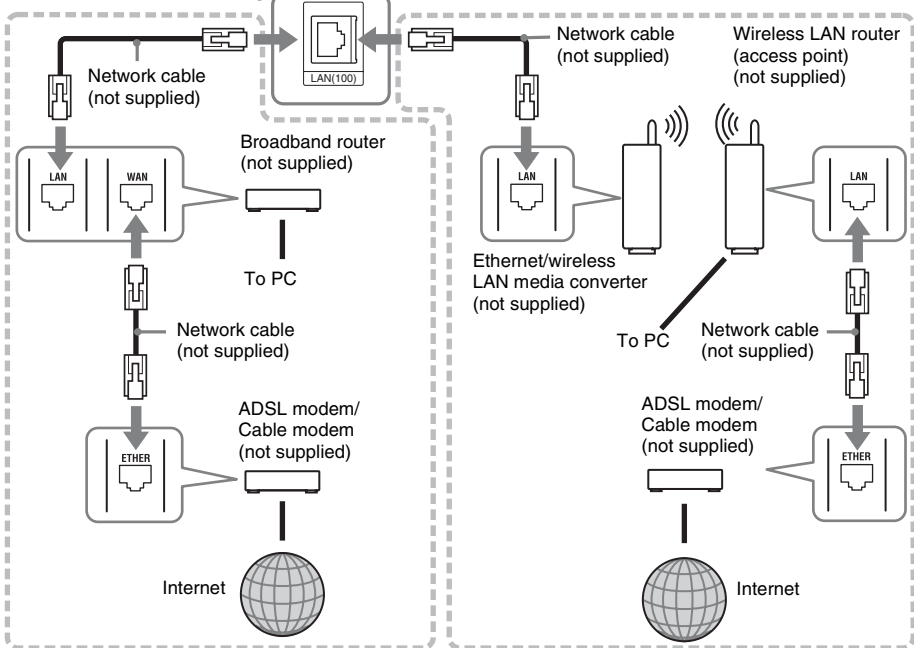

To update the system's software using the network

See [Network Update] (page 118) and [Software Update Notification] (page 126).

To enjoy BD-Live

See "Enjoying BonusView/BD-Live" (page 78).

Note

- Do not connect a phone line to the LAN (100) terminal, as it may cause a malfunction.
- Depending on the modem or router, the type of network (LAN) cable, straight or crossing, differs. For details on the network (LAN) cables, refer to the operating instructions supplied with the modem or router.
- Do not connect the LAN terminal of the unit to the LAN terminal of the PC.

- To enjoy the BD-Live function, we recommend using an Internet connection with an effective speed of 1 Mbps or greater, depending on your connection environment and network condition.

⑧ Connecting the AC power cords (mains leads)

Before connecting the AC power cords (mains leads) of the unit and the surround amplifier to a wall outlet (mains), connect the front, center speakers and subwoofer to the unit and surround speakers to the surround amplifier.

Rear panel of the unit (Ex. BDV-IT1000)

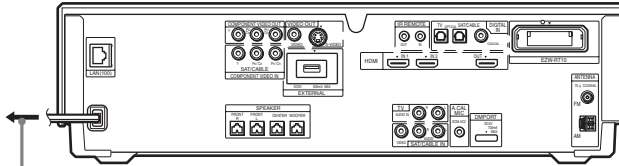

To the wall outlet (mains)

Rear panel of the surround amplifier

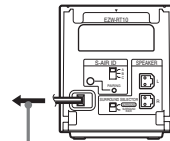

To the wall outlet (mains)

Step 4: Setting up the Wireless System

To use the wireless system, you need to set up the surround amplifier. Before setting, make sure that the wireless transceivers are inserted into the unit and the surround amplifier correctly (page 63).

This wireless system is called “S-AIR.” For details of the S-AIR function, see “Using an S-AIR Product” (page 99).

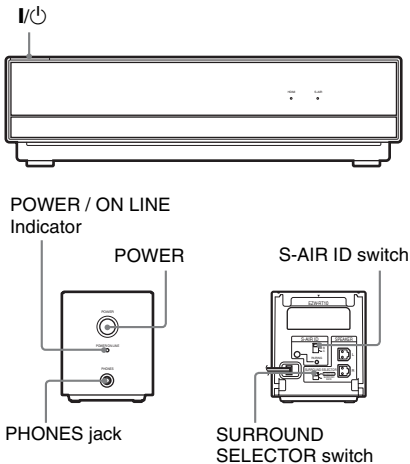

The unit transmits sound to the surround amplifier that is connected to the surround speakers. To establish sound transmission, perform the following Steps.

- 1** Press **I/O** on the unit.
The system turns on.
- 2** Make sure that the **SURROUND SELECTOR** switch of the surround amplifier is set to **SURROUND**.
- 3** Set the **S-AIR ID** switch of the surround amplifier to **A**.
- 4** Press **POWER** on the surround amplifier.

The POWER / ON LINE indicator turns green. If not, check the transmission status as follows.

To check the transmission status

You can check the status of sound transmission between the unit and surround amplifier by checking the POWER / ON LINE indicator of the surround amplifier.

POWER / ON LINE indicator	Status
Turns green.	Sound transmission is established.
Flashes green.	Sound transmission is not established. For details, see “Surround amplifier operation” (page 138).
Turns red.	The surround amplifier does not output sound. For details, see “Surround amplifier operation” (page 138).
Turns off.	The surround amplifier turns off or its protection is active. For details, see “Surround amplifier operation” (page 138).

To enjoy the sound by using headphones

You can enjoy the system’s sound in a place apart from the unit by connecting the headphones to the PHONES jack on the surround amplifier.

Note

- When you connect headphones to the surround amplifier, neither the unit nor the surround amplifier outputs sound from the system’s speakers.
- The volume of the unit may become minimum if you turn off the surround amplifier while the headphones are connected to the surround amplifier, or radio reception is poor. In this case, “HP NO LINK” and “VOLUME MIN” appear alternately in the front panel display. Check radio reception, and set the volume again.

When you use multiple S-AIR products

You can prevent miss transmission between the S-AIR products by setting a different ID for each S-AIR product. For details, see “Establishing sound transmission between the unit and S-AIR sub unit (ID setting)” (page 99).

To prevent transmission from your neighbors

To prevent the transmission from neighbors, you can identify the unit and the surround amplifier by performing the pairing operation. For details, see “Identifying the unit with a specific S-AIR sub unit (Pairing operation)” (page 102).

To use the surround amplifier for the surround back speakers

You can enjoy 7.1 surround sound with the surround back speakers by purchasing the additional surround amplifier.

To use the surround amplifier for the surround back speakers, connect the surround back speakers (not supplied) to the surround amplifier, set the SURROUND SELECTOR switch to SURROUND BACK, and make the S-AIR setting for the surround amplifier. For details, see “Using an S-AIR Product” (page 99).

To attach the cover to the surround amplifier

After connecting and setting, you can attach the cover to the surround amplifier for organizing and storing excess speaker cords.

1 Attach the speaker cord cover by sliding it down along the grooves along the edges of the surround amplifier.

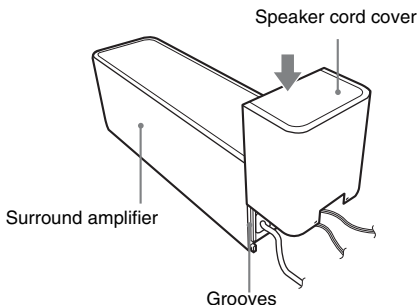

Push the speaker cord cover down until you hear a click. Turn the surround amplifier upside down, then store the cords in the speaker cord cover.

2 Insert the tabs of the speaker cord holder in the slots of the speaker cord cover, and press it into place.

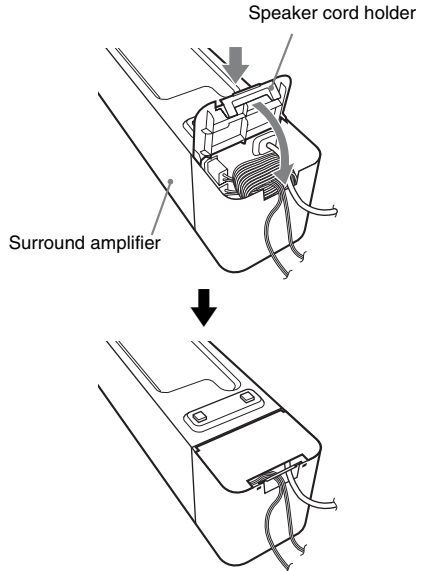

Note

- When detaching, remove the speaker cord holder, then remove the speaker cord cover. To remove the speaker cord holder, slightly press the catch of the holder and lift off. To remove the speaker cord cover, slightly splay open the edges of the cover and slide down.
- Do not use excessive force to store the cords.

Step 5: Performing the Easy Setup

Follow the Steps below to make the basic adjustments for using the system.

Displayed items vary depending on the country model.

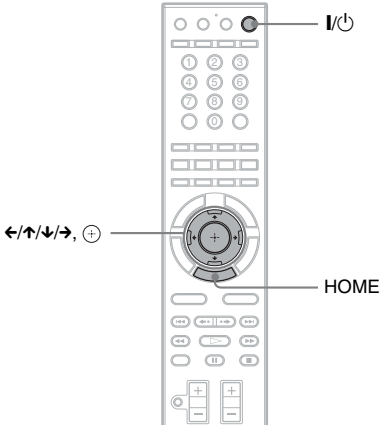

- 1 Turn on the TV.**
- 2 Press I/Power on the unit, and POWER on the surround amplifier.**
- 3 Switch the input selector on your TV so that the signal from the system appears on the TV screen.**

The Easy Setup Display for OSD language selection appears.

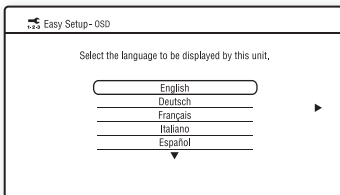

If the Easy Setup Display does not appear

Recall the Easy Setup Display. See “To recall the Easy Setup Display” (page 72).

- 4 Press ↑/↓ to select a language.**

The system displays the menu and subtitles in the selected language.

- 5 Press (+) or →.**

The setting message appears.

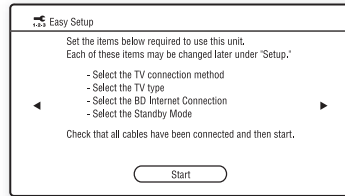

This message appears only for the first initial setting. It does not appear in the [Easy Setup] in [Setup] setting.

- 6 Press (+) or →.**

The Setup Display for video cable selection appears.

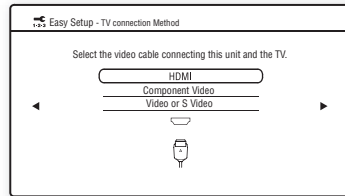

- 7 Press ↑/↓ to select the cable used to connect the unit and TV.**

Check the connection of the unit and TV (page 57).

- When you connect the unit and TV with the HDMI cable, select [HDMI], go to Step 8 and set the video output resolution for matching your TV.
- When you connect the unit and TV with the component video cord, select [Component Video], go to Step 8 and set the video output resolution for matching your TV.
- When you connect the unit and TV with the video or S video cord, select [Video or S Video] and go to Step 9.

Note

- When you do not connect the unit and TV with the HDMI cable, you cannot select [HDMI].
- When connecting the HDMI OUT jack and other video output jacks at the same time, select [Component Video].
- For details about video output resolution, see “Video Output Resolution” (page 144).

8 Press \oplus or \rightarrow .

The Setup Display for video output resolution selection appears. For details, see [Output Video Format] (page 120).

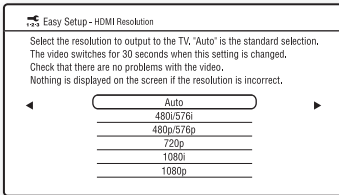
When you select [HDMI] in Step 7

Select from [Auto], [480i/576i], [480p/576p], [720p], [1080i], or [1080p].

When connecting the HDMI OUT jack and other video output jacks at the same time, video signals may not output from the jacks, other than from the HDMI OUT jack, when [Auto] or [1080p] is selected.

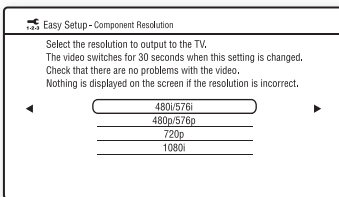
When you select [Component Video] in Step 7

Select from [480i/576i], [480p/576p], [720p], or [1080i].

When you change the video output resolution

A picture is displayed in the selected resolution for about 30 seconds, then the display asks for confirmation.

Follow the on-screen instructions and go to the next step.

Note

- If the picture is distorted or no picture appears, wait for about 30 seconds without pressing any buttons. [Is this resolution OK?] appears. Select [Cancel]. The display returns to the resolution setting screen.
- If the selected video output resolution is incorrect, no picture appears on the screen. In this case, press and hold \triangleright and \triangleleft on the unit for more than 5 seconds to reset the video output resolution to the lowest resolution. To change the video output resolution, set [Output Video Format] in [Video Settings] (page 119).

9 Press \ominus or \rightarrow .

The Setup Display for selecting the aspect ratio of the TV to be connected appears.

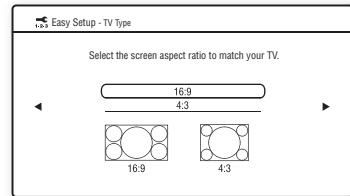
**10 Press \uparrow/\downarrow to select the setting that matches your TV type.**

- [16:9]: If you have a wide-screen TV or a 4:3 standard TV with a wide-screen mode. (page 119)
- [4:3]: If you have a 4:3 standard TV. (page 119)

11 Press \oplus or \rightarrow .**When you connect the unit and TV with the HDMI cable**

The Setup Display for the [Control for HDMI] function appears. Go to Step 12.

When you do not connect the unit and TV with the HDMI cable

The Setup Display for [BD Internet Connection] appears. Go to Step 14.

12 Press \uparrow/\downarrow to select the setting for the Control for HDMI function.

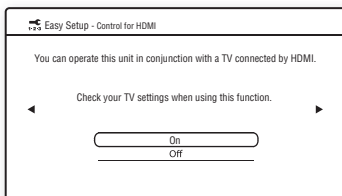

Select [On] to use the [Control for HDMI] function (page 105) when connecting Sony components that are compatible with the Control for HDMI function.

If you do not use the [Control for HDMI] function, select [Off].

13 Press \oplus or \rightarrow .

The Setup Display for [BD Internet Connection] appears.

14 Press \uparrow/\downarrow to select the setting for the BD Internet connections.

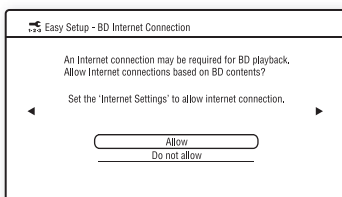

Select [Allow] to allow Internet connections.

If you do not allow the connections, select [Do not allow].

15 Press \oplus or \rightarrow .

The Setup Display for [Standby Mode] appears.

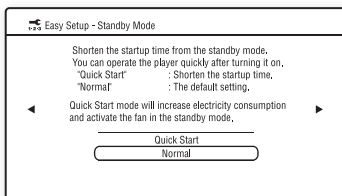

16 Press \uparrow/\downarrow to select the standby mode.

You can operate the player quickly after turning on this function.

Select [Quick Start] if you want to shorten the startup time from the standby mode. The default setting is [Normal].

Note

- Quick Start mode will increase electricity consumption and activate the fan in the standby mode.

17 Press \oplus or \rightarrow .

The Setup Display for [Auto Calibration] appears.

18 Connect the calibration mic to the A.CAL MIC jack on the rear panel.

Set up the calibration mic at the ear level using a tripod, etc. (not supplied). The front of each speaker should face the calibration mic, and there should be no obstruction between the speakers and the calibration mic.

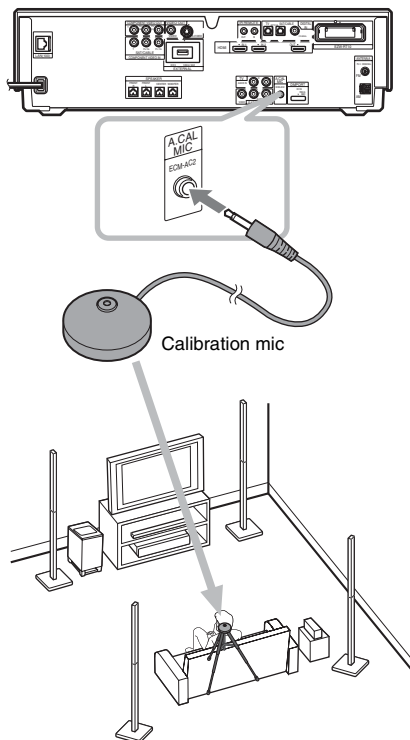

Ex. BDV-IT1000

19 Press **↑/↓** to select [OK].

To cancel, select [Cancel].

Note

- Make sure that the headphones are not connected to the surround amplifier. You cannot operate the following steps with the headphones connected.

20 Press **⊕**.

[Auto Calibration] starts.

The system adjusts the speaker setting automatically.

Be quiet during the measurement.

Note

- Loud test sound is output when [Auto Calibration] starts. You cannot turn the volume down. Give consideration to children and neighbors.
- Before [Auto Calibration], install the surround amplifier in the appropriate location. If you install the surround amplifier in an improper location, such as another room, proper measurement will not be obtained.
- Avoid being in the measurement area and making noise during the measurement (which takes about 1 minute), as it may interfere with measurement.
- When you use the surround back speakers with the optional surround amplifier, install the speakers in appropriate location and turn the surround amplifier on.

21 Confirm the conclusions of [Auto Calibration].

The conclusions appear on the TV screen. Press **←/→** to change the page. The first page shows the distance of speakers. The second page shows the level of speakers. If the conclusions are ok, unplug the calibration mic and press **↑/↓** to select [OK].

Note

- The environment of the room in which the system is installed may affect measurements.
- If measurement fails, follow the message then retry [Auto Calibration].

22 Press **⊕**.

Easy Setup is finished. All connections and setup operations are complete.

To quit the Easy Setup

Press HOME in any Step.

Tip

- If you change the position of the speakers, reset the speaker settings. See “Calibrating the Appropriate Settings Automatically” (page 108) and “Setting the Speakers” (page 110).
- If you want to change any of the settings, see “Settings and Adjustments” (page 117).

To recall the Easy Setup Display**1** Press HOME.

The home menu appears on the TV screen.

2 Press **←/→** to select **🗑️** [Setup].**3** Press **↑/↓** to select [Easy Setup], then press **⊕**.**4** Press **←/→** to select [Start], then press **⊕**.

The Easy Setup display appears.

Step 6: Enjoying Sound by Each Function

You can enjoy BD/DVD, TV, Set-top box/digital satellite receiver, or VCR sound from all the speakers in this system.

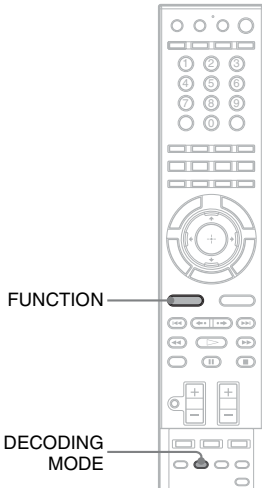

With the cover opened.

1 Press **FUNCTION** repeatedly until the desired function appears in the front panel display.

Each time you press **FUNCTION**, the function changes as follows.

“BD/DVD” → “TUNER FM” →
 “TUNER AM” → “TV” → “SAT/
 CABLE” → “HDMI1” → “HDMI2” →
 “DMPORT” → ...

Function	Source
“BD/DVD”	Disc that is played by the system
“TUNER FM”/ “TUNER AM”	FM/AM radio (page 92)
“TV”	TV
“SAT/CABLE”	Component that is connected to the SAT/CABLE jacks on the rear panel (page 59)

Function	Source
“HDMI1”/“HDMI2”	Component that is connected to the HDMI1 or 2 jack on the rear panel (page 59)
“DMPORT”	DIGITAL MEDIA PORT adapter (page 98)

Note

- When you use both the TV (AUDIO IN) jacks (analog connection) and DIGITAL IN (TV) jack (digital connection), or SAT/CABLE IN (AUDIO) jacks (analog connection) and DIGITAL IN (SAT/CABLE) jacks (digital connection) at the same time, the digital connection takes priority.

2 Press **DECODING MODE** repeatedly until the decoding mode you want appears in the front panel display.

When you want to output the TV sound or stereo sound of a 2 channel source from the six speakers, select the “PRO LOGIC,” “PLII MOVIE,” or “PLII MUSIC” decoding mode.

For details, see page 86.

Note

- Depending on your TV, you may need to turn off your TV’s speaker to enjoy surround sound of the system.

Tip

- When listening to MP3 files or other compressed music using the DIGITAL MEDIA PORT adapter, you can enhance the sound. Press **DECODING MODE** repeatedly until “A.F.D. STD” appears in the front panel display (page 86) and set the sound mode (page 89) to “MOVIE,” “MUSIC,” or “NEWS.” To cancel, select other than “A.F.D. STD.”
- When using the additional surround amplifier (optional) with the surround back speakers (optional), you can select “PLIIx MOVIE” and “PLIIx MUSIC” for the decoding mode (page 86).

If distortion occurs in the sound of a connected component

You can reduce the input level for the connected component. For details, see [Attenuate - TV] (page 121) and [Attenuate - SAT/CABLE] (page 121).

Playing a BD/DVD

BD **DVD**

Depending on the disc, some operations may be different or restricted.
Refer to the operating instructions supplied with your disc.

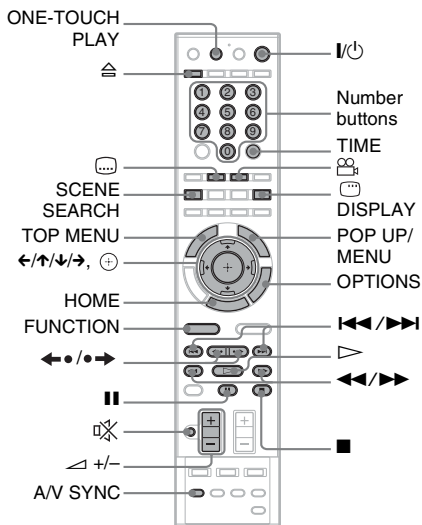
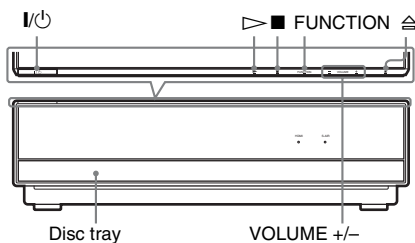

- 1** Turn on your TV.
- 2** Switch the input selector on the TV to this system.
- 3** Press I/⏻.
The system turns on.

- 4** Press FUNCTION repeatedly until "BD/DVD" appears in the front panel display.

- 5** Press ⏻.

- 6** Load a disc.

Place one disc on the disc tray, and then press ⏻.

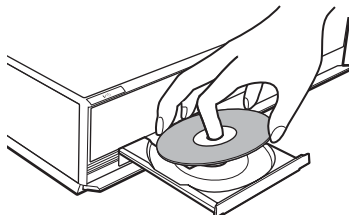

When you insert a commercially available BD-ROM or DVD VIDEO, playback automatically starts depending on the disc.

Note

- When you play an 8 cm disc, place it on the inner circle of the tray. Be careful that the disc is not skewed on the inner circle of the tray.
- Do not forcibly press the disc tray closed with your finger, as this may cause malfunction.
- Do not place more than one disc on the tray.

- 7** Press ←/→ to select [Video].

- 8** Press ↑/↓ to select ●, then press ▷ or ⊕.

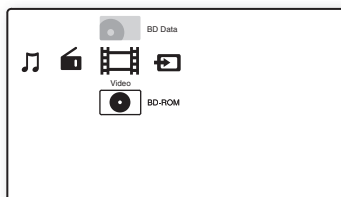

For commercially available BD-ROM or DVD VIDEO, playback starts.

For a BD or DVD recorded on other equipment, the title list appears. Press ↑/↓ to select ●, then press ▷ or ⊕.
Playback starts.

- 9** Adjust the volume by using ◀ +/- on the remote or VOLUME +/- on the unit.
The volume level appears on the TV screen and in the front panel display.

Note

- Depending on the system status, the volume level may not appear on the TV screen.
- When you set the [Control for HDMI] function to [On], the TV that is connected to the system with an HDMI cable (not supplied) can be sync-operated with the system. For details, see “Using the Control for HDMI Function for “BRAVIA” Sync” (page 105).

Tip

- You can change the speed at which the volume is turned up and down.
To turn the volume up/down quickly, press and hold the \triangleleft +/- on the remote or VOLUME +/- on the unit.
To set the volume up/down precisely, press the \triangleleft +/- on the remote or VOLUME +/- on the unit briefly.

To turn the system off

Press **I/⏻** while the system is on. The system enters standby mode.

To save power in standby mode

Press **I/⏻** while the system is on.
To enter power saving mode, make sure that the system is in the following status.

- [Control for HDMI] is set to [Off] (page 105).
- [S-AIR Standby] is set to [Off] (page 102).
- [Standby Mode] is set to [Normal] (page 126).

To use the headphones

Connect the headphones to PHONES jack on the surround amplifier. The sound of the system is muted. For details, see page “To enjoy the sound by using headphones” (page 67).

Other operations

To	Press
Stop	■
Pause	
Resume play after pause	or ▷
Go to the next chapter	▶▶
Go back to the preceding chapter	◀◀ twice in a second. When you press ◀◀ once, you can go to the beginning of the current chapter.

To	Press
Turn off the sound temporarily	⊠ To cancel, press it again or \triangleleft + to adjust the sound volume.
Stop play and remove the disc	⊞
Locate a point quickly by playing a disc in fast forward or fast reverse (Scan) ¹⁾	▶▶ or ◀◀ while playing a disc. Each time you press ▶▶ or ◀◀ during scan, the playback speed changes as follows: Playback direction ▶▶ 1 (×10) → ▶▶ 2 (×30) → ▶▶ 3 (×120) Reverse direction ◀◀ (×1) → ◀◀ 1 (×10) → ◀◀ 2 (×30) → ◀◀ 3 (×120)
Replay the previous scene ²⁾	◀● (instant replay) during playback.
Briefly fast forward the current scene ³⁾	●▶ (instant advance) during playback.

When you press and hold the button, fast forward/fast reverse continues at the selected speed until you release the button.
To return to normal speed, press ▷. Actual speeds may differ with some discs.

¹⁾Scan speeds may differ with some discs.
²⁾BD/DVD VIDEO/DVD-RW/DVD-R only.
³⁾BD/DVD VIDEO/DVD-RW/DVD-R/DVD+RW/DVD+R only.

Note

- You may not be able to use the instant replay or instant advance function with some scenes.

To play a restricted BD or DVD (Parental Control)

When you play a restricted BD
Change [BD Parental Control] in [BD/DVD Viewing Settings] (page 122).

When you play a restricted DVD
Change [DVD Parental Control] in [BD/DVD Viewing Settings] (page 122).

When you play a restricted BD or DVD, the display for entering your password appears on the screen.

Enter your four-digit password using the number buttons, and press \oplus .

Playback starts.

To register or change the password, see [Password] (page 123).

To play a restricted BD-RE or BD-R (Disc Lock)

When you play a BD-RE or BD-R restricted by the Disc Lock function, the display for entering your password appears on the screen.

1 Enter the four-digit password that has been registered when creating the disc using the number buttons, and press \oplus .

2 Select a title, and press \triangleright or \oplus .
Playback starts.

One-Touch Play (for HDMI connection only)

Press ONE-TOUCH PLAY.

The system and the connected TV turn on and the input selector on the TV is switched to the system, then you can enjoy the contents of a disc.

Note

- When using the HDMI connection, there may be a delay before the playback picture appears on the screen, and the beginning portion of the playback picture may not be displayed.
- To use the this function, set [Control for HDMI] to [On] in [HDMI Settings] (page 124).

Available OPTIONS

1 Press **OPTIONS**.

The options menu appears.

2 Press \uparrow/\downarrow to select an item, then press \oplus .

The available items differ depending on the disc type or system situation.

Items	Details
[Video Settings]	Adjusts settings for picture (page 81).
[Title List]	Displays the title list.
[Play]	Plays the title from the point where you pressed \blacksquare .
[Play from start]	Plays the title from the beginning.
[Top Menu]	Displays the disc's Top Menu (page 78).
[Menu/Popup Menu]	Displays the BD-ROM's Pop-up Menu or DVD's menu (page 78).
[Stop]	Stops playback.
[Title Search]	Searches for a title and starts playback from the beginning (page 79).
[Chapter Search]	Searches for a chapter and starts playback from the beginning (page 79).

Changing the angles

B D DVD

If various angles (multi-angles) for a scene are recorded on a disc, you can change the viewing angle.

Press  during playback to select the desired angle.

Note

- Depending on the disc, you may not be able to change the angle even if multi-angles are recorded on the disc.

Displaying the subtitles

B D DVD

If subtitles are recorded on a disc, you can turn the subtitles on/off during playback. If multilingual subtitles are recorded on the disc, you can change the subtitle language during playback, or turn the subtitles on/off whenever you want.

Press  during playback to select the desired subtitle language.

Note

- Depending on the disc, you may not be able to change the subtitles even if multilingual subtitles are recorded on the disc. You also may not be able to turn them off.

Resuming playback from the point where you stopped the disc

(Resume Play)

B D DVD

When you stop the disc, the system remembers the point where you pressed **■**. As long as you do not remove the disc, Resume Play will work even if the system is set to standby mode by pressing **I/⏏**.

- 1 While playing a disc, press **■** to stop playback.
- 2 Press **↑/↓** to select **●**, then press **▷** or **⊕**.

The system starts playback from the point where you stopped the disc in Step 1.

Note

- Depending on where you stop the disc, the system may not resume playback from exactly the same point.
- The point where you stopped playing may be cleared when:
 - you open the disc tray.
 - you play another title.
 - you change the settings on the system.
 - you disconnect the AC power cord (mains lead).
 - you remove the external memory (for BD-ROMs).
- This function may not work properly with some discs.

To play from the beginning of the title

Press **OPTIONS** to select [Play from start], then press **⊕**. Playback starts from the beginning of the title.

Using the BD's or DVD's menu

BD

DVD

To display Top Menu

A BD/DVD is divided into a lot of sections, which make up a picture or music feature. These sections are called "titles." When you play a BD/DVD which contains several titles, you can select the title you want using Top Menu. You can also select items such as the language for the subtitles and the language for the sound using Top Menu.

1 Press TOP MENU.

The disc's menu appears on the TV screen. The contents of the menu vary depending on the disc.

2 Press ←/↑/↓/→ or the number buttons to select the item you want to play or change.

3 Press ⊕.

To display Pop-up Menus

Some BD-ROMs contain Pop-up Menus that appear without interrupting playback.

1 Press POP UP/MENU during playback.

The Pop-up Menu appears.

2 Press ←/↑/↓/→, the color buttons, or number buttons to select the item, and follow the on-screen instructions.

Enjoying BonusView/BD-Live

BD

Some BD-ROMs have bonus contents and other data that can be downloaded to the external memory (local storage) for enjoyment.

1 Press I/⏻ to turn the system off.

2 Insert the external memory (not supplied) into the EXTERNAL slot on the rear of the unit.

The external memory is used as the local storage.

Make sure that the external memory is properly inserted into the unit (page 64).

3 Press I/⏻ to turn the system on.

4 Insert a BD-ROM with BonusView/BD-Live.

The operation method differs depending on the disc. Refer to the operating instructions supplied with the disc.

To delete data in the external memory

You can delete unnecessary data.

1 Press HOME.

2 Press ←/→ to select [Video].

3 Press ↑/↓ to select [BD Data], then press ⊕.

4 Select the disc name, then press OPTIONS.

5 Select [Erase], then press ⊕.

6 Select [OK], then press ⊕.

The data of the selected disc will be deleted.

Note

- Depending on the BD-ROM, the disc name may not be displayed.

Tip

- To delete all data in the external memory at once, select [Erase All] in Step 5.
- Press ⊕ instead of OPTIONS in Step 4 to skip Step 5.

Searching for a scene quickly

(Scene Search)

B D **DVD**

You can move quickly between scenes within the title currently being played back.

1 Press **SCENE SEARCH** during playback or in pause mode.

Playback pauses and a bar with a scene indicator (square-shaped – indicates the current point) appears at the bottom of the screen.

2 Press and hold **←/→** or **◀/▶** to move the scene indicator to the scene you are searching for.

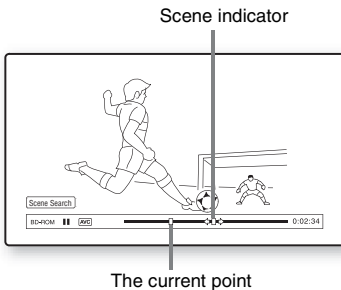

The scene indicator on the bar is displayed around the playing point.

3 Release the button at the point you want to watch.

The scene at which you released the button is displayed in pause mode.

To search for a scene again, move the scene indicator using **←/→** or **◀/▶**.

4 Press **SCENE SEARCH**, **⊕**, **▷**, or **II**. Playback starts.

To cancel Scene Search mode

Press **SCENE SEARCH**, **⊕**, **▷**, or **II**.

Playback starts from the point you pressed the button.

Note

- The Scene Search function is available for titles longer than 100 seconds and shorter than 100 hours.
- Depending on the disc, this function may not work.

Searching for a Title/Chapter

B D **DVD**

You can search for a chapter if the title contains chapter marks.

1 Press **OPTIONS** during playback or in pause mode.

The options menu appears.

2 Press **↑/↓** to select a search method, then press **⊕**.

- [Title Search] (for a BD-ROM/DVD VIDEO): Searches the desired title.
- [Chapter Search]: Searches the desired chapter.

The display for entering the number appears.

Example: Chapter Search

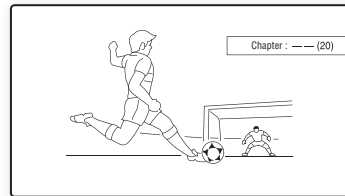

3 Press the number buttons to enter the number of the title or chapter.

If you make a mistake, press **CLEAR**, and re-enter another number.

4 Press **⊕**.

After a while, the system starts playback from the selected number.

To cancel [Title Search]/[Chapter Search]

Press **RETURN**.

Displaying the playing time and play information

B D

DVD

You can check the title information, including the video transmission rate, etc.

Press **[] DISPLAY** during playback.

The displayed information differs depending on the disc type and system status.

Example: When playing a BD-ROM

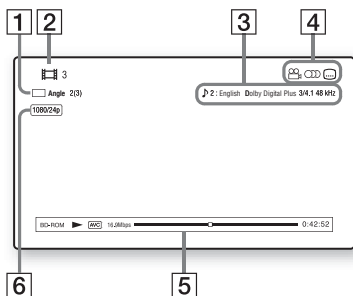

- 1 The current selected angle
- 2 Title number or name
- 3 The currently selected audio or subtitle setting
- 4 Available functions (angle / audio / subtitle)
- 5 Playback information
Displays Disc type/Play mode/Video codec/
Bit rate/Playing status bar/Playing time
(Remaining time*)
- 6 Output resolution/Video frequency

* Displayed when you press TIME repeatedly.

Tip

- You can also check the playback information in the front panel display.
- Press **[]**, **[]**, or **[]**, and you can check each type of information.

To view the playing time and remaining time in the front panel display

Press **TIME** repeatedly.

Each time you press **TIME** while playing the disc, the display changes:

① ↔ ②

- ① Playing time of the current title
- ② Remaining time of the current title

Some displayed items may disappear after a few seconds.

Adjusting pictures for videos

B D DVD

1 Press **OPTIONS** during playback.

The options menu appears.

2 Press **↑/↓** to select **[Video Settings]**, then press **+**.

The **[Video Settings]** screen appears.

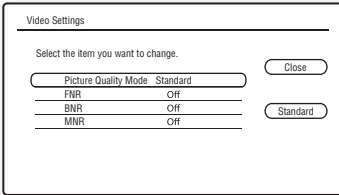

3 Press **↑/↓** to select an item, then press **+**.

+.

[Picture Quality Mode]

Optimizes the picture settings for different lighting environments.

- **[Standard]**
- **[Brighter Room]**
- **[Theatre Room]**

[FNR]

Reduces random noise appearing in the picture.

- **[Off]**
- **[Auto]**

[BNR]

Reduces mosaic-like block noise in the picture.

- **[Off]**
- **[Auto]**

[MNR]

Reduces minor noise around the picture outlines (mosquito noise).

- **[Off]**
- **[Auto]**

4 Press **←/↑/↓/→** to select or adjust the settings, then press **+**.

To adjust any other items, repeat steps 3 and 4.

Note

- Set the picture setting of your TV to **[Standard]** before changing **[Picture Quality Mode]**.
- **[Video Settings]** is not available when the connected TV is set to **Theatre Mode** (page 106).
- Depending on the disc or the scene being played, **[FNR]**, **[BNR]**, or **[MNR]** effects may be hard to discern.

Adjusting the delay between the picture and sound

(A/V SYNC)

B D

DVD

When the sound does not match the pictures on the TV screen, you can adjust the delay between the picture and sound.

1 Press A/V SYNC.

“A/V SYNC” appears in the front panel display.

2 Press \uparrow/\downarrow to adjust the delay between the picture and sound.

You can adjust from 0 ms to 300 ms in 25 ms increments.

Note

- Depending on the input stream, A/V SYNC may not be effective.

Playing a CD

CD

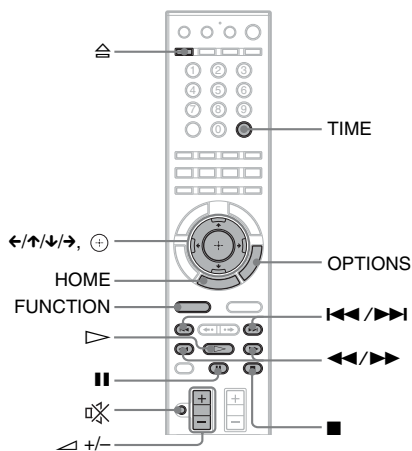

1 Press FUNCTION repeatedly until “BD/DVD” appears in the front panel display.

2 Load a CD.

The Music Player screen appears.

3 Press \blacktriangleright .

Playback starts.

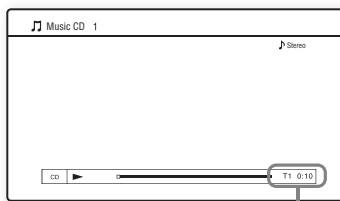

Current track number and elapsed time



4 Adjust the volume by using $\blacktriangleleft/\blacktriangleright$.

The volume level appears on the TV screen and in the front panel display.



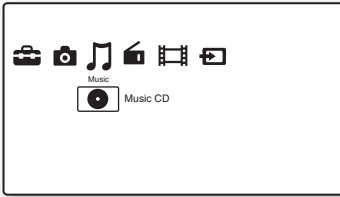











To select a track

- 1 Press HOME.
- 2 Press ←/→ to select  [Music].



- 3 Press  .
The music list appears.
- 4 Press ↑/↓ to select a track, then press  or  .
The system plays the selected track.

Other operations

To	Press
Stop	
Pause	
Resume play after pause	 or 
Start playback from the point where you pressed  .	
Go to the next track	
Go back to the preceding track	 twice in a second. When you press  once, you can go to the beginning of the current track.
Turn off the sound temporarily	 To cancel, press it again or  + to adjust the sound volume.
Stop play and remove the disc	
Fast reverse/fast forwards	 or  during playback.

Available OPTIONS

- 1 Press OPTIONS.
The options menu appears.
- 2 Press ↑/↓ to select an item, then press  .
The available items differ depending on the disc type or system situation.

Items	Details
[Play]	Plays the selected track.
[Play from start] (during playback)	Plays the current track from the beginning.
[Play from start] (in stop mode)	Plays the selected track from the beginning.
[Stop]	Stops playback.

Note

- The point where you stopped playing (resume point) is cleared from memory when:
 - You open the disc tray.
 - You turn the system off.

To view the playing time and remaining time in the front panel display

Press TIME repeatedly.

Each time you press TIME while playing the disc, the display changes:

① → ② → ③ → ④ → ① → ...

- ① Playing time of the current track
- ② Remaining time of the current track
- ③ Playing time of the disc
- ④ Remaining time of the disc

Playing Photo Files



- 1) BD-REs/BD-Rs containing JPEG image files
- 2) DVD+RWs/DVD+Rs/DVD-RWs/DVD-Rs containing JPEG image files
- 3) CD-RWs/CD-Rs containing JPEG image files

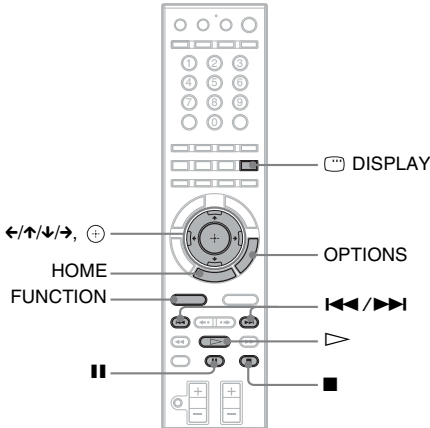

- 1 Press **FUNCTION** repeatedly until “BD/ DVD” appears in the front panel display.
- 2 Load a disc that contains photo files.
- 3 Press **HOME**.
- 4 Press **←/→** to select [Photo].

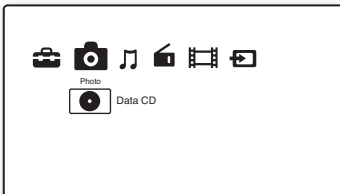

- 5 Press **↑/↓** to select , then press **+** .
The file list or folder list appears.

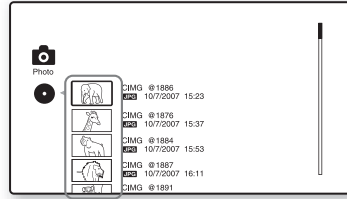

Thumbnails of files*

* Appears only when the file has thumbnail information.

- 6 Press **↑/↓** to select a file or folder, then press **+** .

When you select a folder, press **↑/↓** to select a file in the folder, then press **+** .
The selected photo file is displayed.

Other operations

To	Press
Play a slideshow	
Stop a slideshow	
Pause a slideshow	
Go to the next photo	▶▶
Go back to the preceding photo	◀◀
Display the file information	DISPLAY

Available **OPTIONS** for photo files

- 1 Press **OPTIONS**.
The options menu appears.
- 2 Press **↑/↓** to select an item, then press **+** .
The available items differ depending on the situation.

Items	Details
[Slideshow Speed] ¹⁾²⁾	Changes the slideshow speed. • [Fast] • [Normal] • [Slow]
[Stop] ¹⁾	Stops a slideshow.

Items	Details
[Rotate Left] ¹⁾	Rotates the photo counterclockwise by 90 degrees.
[Rotate Right] ¹⁾	Rotates the photo clockwise by 90 degrees.
[ViewImage] ²⁾	Displays the selected picture.
[Slideshow] ²⁾	Starts a slideshow.

¹⁾Appears when you press **OPTIONS** during playback of photo files.

²⁾Appears when you press **OPTIONS** while the file/folder list is displayed.

Note

- When you attempt to play the following photo files, the  mark appears on the screen and they cannot be played.
 - Photo files larger than 8,192 pixels (width or height)
 - Photo files smaller than 15 pixels (width or height)
 - Photo files exceeding 32 MB
 - Photo files with extreme aspect ratios (greater than 50:1 or 1:50)
 - Photo files in Progressive JPEG format
 - Photo files that have a “.jpeg” or “.jpg” extension, but not in JPEG format
 - Photo files that have an extremely long name
- The following photo files cannot be played.
 - Photo files recorded on BD-Rs in any format other than UDF (Universal Disk Format) 2.6
 - Photo files recorded on BD-REs in any format other than UDF (Universal Disk Format) 2.5
- The following photo files or folders cannot be displayed in the file list or folder list.
 - Photo files that have an extension other than “.jpeg” or “.jpg”
 - Photo files that have an extremely long name
 - Photo files in the 5th tree or lower
 - 501th or more folders when the total number of folders and files in a single tree exceeds 500
- Photo files edited on a PC may not be played.
- Thumbnail images of some photo files may not be displayed.
- Large photo files may take some time to display or to start a slideshow.

To view best quality images

If you have a Sony TV compatible with “PhotoTV HD,” you can enjoy best quality images by the following connection and setting.

- 1** Connect the unit to the TV using an **HDMI cable (not supplied)**.
- 2** Set the TV's video setting to **[VIDEO-A] mode**.

For details on [VIDEO-A], refer to the operating instructions supplied with the TV.

Enjoying Surround Sound

You can enjoy surround sound simply by selecting one of the system's pre-programmed decoding modes. They bring exciting and powerful sound of movie theaters into your home.

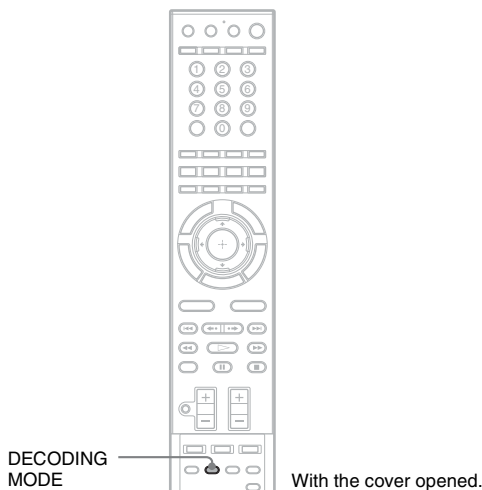

Press DECODING MODE repeatedly until the desired decoding mode appears in the front panel display.

Display	Decoding mode	Effect
"A.F.D. STD"	AUTO FORMAT DIRECT STANDARD	Presents sound as it was recorded/encoded. Depending on the source, the speakers that output sound will vary.
"A.F.D. MULTI"	AUTO FORMAT DIRECT MULTI	2 channel source: Sound that is recorded in 2 channel (front left and right channel) is also assigned to the surround left and right channel. This mode outputs sound from the front left and right speakers, surround left and right speakers, and subwoofer. The center speaker does not output any sound. Multi channel source: Depending on the source, speakers that output the sound will vary.
"PRO LOGIC"	Dolby Pro Logic	Performs Pro Logic decoding to the input signal and simulates surround sound from 2 channel sources. This mode outputs sound from all the speakers and subwoofer. Sound may not be output from all speakers depending on the source.
"PLII MOVIE"	Dolby Pro Logic II MOVIE	Performs Pro Logic II movie mode decoding to the input signal and produces five full-bandwidth output channels from 2 channel sources. This setting is ideal for watching videos of overdubbed or old movies. This mode outputs sound from all the speakers and subwoofer. Sound may not be output from all speakers depending on the source.

Display	Decoding mode	Effect
“PLII MUSIC”	Dolby Pro Logic II MUSIC	Performs Pro Logic II music mode decoding to the input signal and produces five full-bandwidth output channels from 2 channel sources. This setting is ideal for normal stereo sources such as a CD. This mode outputs sound from all the speakers and subwoofer. Sound may not be output from all speakers depending on the source.
“PLIIx MOVIE” ¹⁾	Dolby Pro Logic IIX MOVIE	Performs Pro Logic IIX movie mode decoding to the input signal and produces 7.1 output channels. This setting is ideal for watching videos of overdubbed or old movies. Sound may not be output from all speakers depending on the source.
“PLIIx MUSIC” ¹⁾	Dolby Pro Logic IIX MUSIC	Performs Pro Logic IIX music mode decoding to the input signal and produces 7.1 output channels. This setting is ideal for normal stereo sources such as a CD. Sound may not be output from all speakers depending on the source.
“NEO:6 CINEMA”	dts NEO:6 Cinema	Performs the DTS Neo:6 Cinema mode decoding to the input signal and produces 6.1 output channels. This setting is ideal for watching videos of overdubbed or old movies. This mode outputs sound from all the speakers and subwoofer. Sound may not be output from all speakers depending on the source.
“NEO:6 MUSIC”	dts NEO:6 Music	Performs the DTS Neo:6 Music mode decoding to the input signal and produces 6.1 output channels. This setting is ideal for normal stereo sources such as a CD. This mode outputs sound from all the speakers and subwoofer. Sound may not be output from all speakers depending on the source.
“2CH STEREO”	2 CHANNEL STEREO	Outputs the sound from the front left and right speakers and subwoofer. Multi channel surround formats are downmixed to 2 channels.
“HP THEATER” ²⁾³⁾	HEADPHONE THEATRE	Outputs the sound as surround from headphone left and right.
“HP 2CH” ²⁾	HEADPHONE 2 CHANNEL STEREO	Outputs the sound from headphone left and right. Multi channel surround formats are downmixed to 2 channels.

¹⁾Appears only when you use the additional surround amplifier (optional) with the surround back speakers (optional) (page 67).

²⁾Appears only when you connect headphones to the surround amplifier (page 67).

³⁾BDV-IT1000 only. DCS technology (page 89) is used.

To turn the surround effect off

Press DECODING MODE repeatedly until “A.F.D. STD” or “2CH STEREO” appears in the front panel display and set the sound mode (page 89) to “MOVIE” or “MUSIC.”

Note

- When you select “A.F.D. MULTI,” depending on the disc or source, the beginning of the sound may be cut off as the optimum mode is automatically selected. To avoid cutting the sound, select “A.F.D. STD.”
- When the input signal is multi channel source, “PRO LOGIC,” “PLII MOVIE,” “PLII MUSIC,” “NEO:6 CINEMA,” and “NEO:6 MUSIC” are canceled and the multi channel source is output directly.
- When the bilingual broadcast sound is input, “PRO LOGIC,” “PLII MOVIE,” and “PLII MUSIC” are not effective.

- “PRO LOGIC,” “PLII MOVIE,” “PLII MUSIC,” “PLIIX MOVIE,” “PLIIX MUSIC,” “NEO:6 CINEMA,” and “NEO:6 MUSIC” are canceled when you set the sound mode (page 89) to the following setting.
 - “SPORTS”
 - “OMNI-DIR”
 - “MOVIE-D.C.S.-” (BDV-IT1000 only)
- Depending on the input stream, the decoding mode may not be effective. To activate the decoding mode, set [Fs Limit] in [Audio Settings] (page 121) to [On].
- When changing the decoding mode while using the S-AIR receiver, sound from the S-AIR receiver may skip.

Tip

- The system memorizes the last decoding mode selected for each function mode. Whenever you select a function such as “BD/DVD” or “TUNER FM,” the decoding mode that was last applied to the function is automatically applied again when it is returned to. For example, if you listen to “BD/DVD” with “PRO LOGIC” as the decoding mode, then change to another function, and then return to “BD/DVD,” “PRO LOGIC” will be applied again.

Selecting the Sound Mode

You can select a suitable sound mode for movies or music.

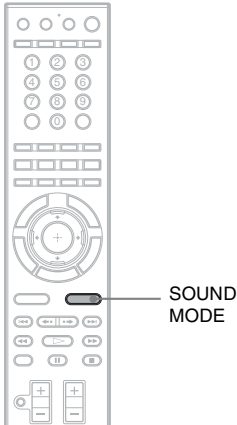

Press SOUND MODE repeatedly during playback until the desired mode appears in the front panel display.

- **“AUTO”**: The system selects “MOVIE” or “MUSIC” automatically to produce the sound effect depending on the disc or sound stream.
- **“MOVIE”**: The system provides the sound for movies.
- **“MUSIC”**: The system provides the sound for music.
- **“SPORTS”**: The system adds reverberation for the sports program.
- **“NEWS”**: The system provides the sound for the voice program, such as news.
- **“OMNI-DIR”**: The system outputs the same sound from all speakers; the same sound is audible anywhere in the room. Multi channel surround formats are downmixed to two channels.
- **“MOVIE-D.C.S.-”***: The system reproduces the sound characteristics of the Sony Pictures Entertainment “Cary Grant Theater” cinema production studio.

* BDV-IT1000 only. DCS technology is used.

Note

- When you connect headphones to the surround amplifier, SOUND MODE does not work.
- Depending on the disc or source, when you select “AUTO,” the beginning of the sound may be cut off as the system selects the optimum mode automatically. To avoid cutting the sound, select other than “AUTO.”
- Depending on the input stream, the sound mode may not be effective.
- When changing the sound mode while using the S-AIR receiver, sound from the S-AIR receiver may skip.

Enjoying Digital Cinema Sound

(BDV-IT1000 only)

About DCS (Digital Cinema Sound)

In collaboration with Sony Pictures Entertainment, Sony measured the sound environment of their studios and integrated the data of the measurement and the Sony DSP (Digital Signal Processor) technology to develop “Digital Cinema Sound.” “Digital Cinema Sound” simulates in a home theater an ideal movie theater sound environment based on the preference of the movie director.

About “MOVIE-D.C.S.-”

“MOVIE-D.C.S.-” is ideal for enjoying movie software encoded with multi channel format, such as the Dolby Digital DVD. This mode reproduces the sound characteristics of Sony Pictures Entertainment’s studios. “MOVIE-D.C.S.-” consists of the following three elements.

- **Virtual Multi Dimension**
The system creates five sets of virtual speakers surrounding the listener from a single pair of actual surround speakers.
- **Screen Depth Matching**
In a movie theater, sound seems to come from inside the image reflected on the movie screen. This element creates the same sensation in your listening room by shifting the sound of the front speakers “into” the screen.
- **Cinema Studio Reverberation**
The system reproduces the reverberations

peculiar to a movie theater.

“MOVIE-D.C.S.-” is the integrated mode which operates these elements simultaneously.

Note

- The virtual speaker effect may cause increased noise in the playback signal.
- With decoding modes that use virtual speakers, you will not be able to hear any sound coming directly from the surround speakers.

Changing the Sound

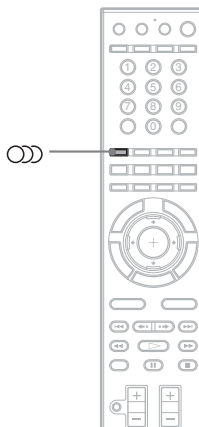

Selecting the audio format, multilingual tracks, or channel

When the system is playing a BD/DVD VIDEO recorded in multiple audio formats (PCM, Dolby Digital, MPEG audio, or DTS), you can change the audio format. If the BD/DVD VIDEO is recorded with multilingual tracks, you can also change the language. With a CD, you can select the sound from the right or left channel and listen to the sound of the selected channel through both the right and left speakers.

Press  repeatedly during playback to select the desired audio signal.

The audio information appears on the TV screen.

■ BD/DVD VIDEO

Depending on the BD/DVD VIDEO, the choice of language varies.

When 4 digits are displayed, they indicate a language code. See “Language Code List” (page 149) to confirm which language the code represents. When the same language is displayed two or more times, the BD/DVD VIDEO is recorded in multiple audio formats.

■ DVD-VR

The types of sound tracks recorded on a disc are displayed.

Example:

- [♪ Stereo]
- [♪ Stereo (Audio1)]
- [♪ Stereo (Audio2)]
- [♪ Main]
- [♪ Sub]
- [♪ Main/Sub]

Note

- [♪ Stereo (Audio1)] and [♪ Stereo (Audio2)] do not appear when one audio stream is recorded on the disc.

■ CD

- [♪ Stereo]: The standard stereo sound.
- [♪ 1/L]: The sound of the left channel (monaural).
- [♪ 2/R]: The sound of the right channel (monaural).

Enjoying multiplex broadcast Sound

(DUAL MONO)

You can enjoy multiplex broadcast sound when the system receives or plays the Dolby Digital multiplex broadcast signal.

Note

- To receive the Dolby Digital signal, you need to connect a TV or other component to the unit with an optical or coaxial digital cord (page 57) and set the digital output mode of the TV or other component to Dolby Digital.

Press  repeatedly until the desired signal appears in the front panel display.

- “MAIN”: Sound of the main language will be output.
- “SUB”: Sound of the sub language will be output.
- “MAIN/SUB”: Mixed sound of both the main and sub languages will be output.

Listening to the Radio

You can enjoy radio sound with the system's speakers.

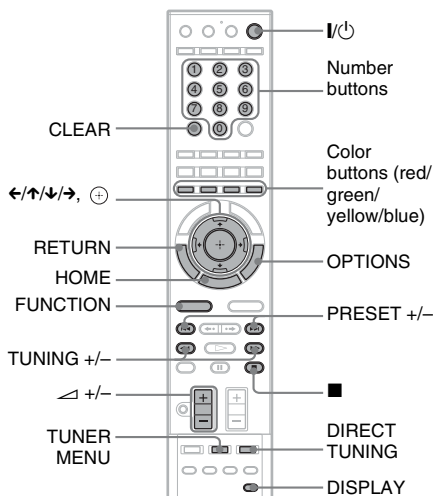

With the cover opened.

You can operate the tuner function by observing the following display on the TV screen.

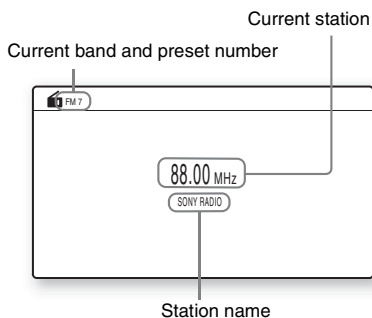

Tip

- You can operate the tuner function using the tuner menu on the front panel display. See "Operating the tuner function using the tuner menu" (page 95).

1 Press **FUNCTION** repeatedly until "TUNER FM" or "TUNER AM" appears in the front panel display.

2 Select the radio station.

Automatic tuning

Press and hold **TUNING +/-** until the auto scanning starts.

[Auto Tuning] appears on the TV screen. Scanning stops when the system tunes in a station.

To stop the automatic tuning manually, press **TUNING +/-** or **■**.

"TUNED" and "ST" (for stereo program) light up in the front panel display.

Manual tuning

Press **TUNING +/-** repeatedly.

3 Adjust the volume by pressing **∧ +/-**.

To turn off the radio

Press **I/Power**.

Tip

- To improve reception, reorient the connected antennas (aerials).

Presetting radio stations

You can preset 20 FM stations, and 10 AM stations. Before tuning, make sure to turn down the volume to minimum.

- 1 Press FUNCTION repeatedly until “TUNER FM” or “TUNER AM” appears in the front panel display.**
- 2 Press and hold TUNING +/- until the auto scanning starts.**
[Auto Tuning] appears on the TV screen. Scanning stops when the system tunes in a station.
“TUNED” and “ST” (for stereo program) light up in the front panel display.
- 3 Press OPTIONS.**
The options menu appears.
- 4 Press ↑/↓ to select [Preset Memory], then press ⊕.**
- 5 Press ↑/↓ to select the preset number you want.**
- 6 Press ⊕.**
The setting is made.

To change the preset number

Select the desired preset number by pressing PRESET +/-, then perform the procedure from Step 3.

Selecting the preset station

- 1 Press FUNCTION repeatedly until “TUNER FM” or “TUNER AM” appears in the front panel display.**
The last received station is tuned in.
- 2 Press PRESET +/- repeatedly to select the preset station.**
The preset number and frequency appear on the TV screen and front panel display. Each time you press the button, the system tunes in one preset station.

Tip

- You can select the preset station number directly by pressing the number buttons.

Selecting the radio station by inputting the frequencies directly

When you know the frequencies, you can select the radio station by inputting the frequencies directly.

- 1 Press FUNCTION repeatedly until “TUNER FM” or “TUNER AM” appears in the front panel display.**
- 2 Press OPTIONS.**
The options menu appears.
- 3 Press ↑/↓ to select [Direct Tuning], then press ⊕.**
- 4 Press the number buttons to select the frequencies.**
- 5 Press ⊕.**
The setting is made.

If an FM program is noisy

If an FM program is noisy, you can select monaural reception. There will be no stereo effect, but reception will improve.

- 1 Press OPTIONS.**
The options menu appears.
- 2 Press ↑/↓ to select [FM Mode], then press ⊕.**
- 3 Press ↑/↓ to select [Monaural].**
 - [Stereo]: Stereo reception.
 - [Monaural]: Monaural reception.
- 4 Press ⊕.**
The setting is made.

Naming preset stations

You can enter a name for preset stations. These names (for example, “XYZ”) appear in the front panel display when a station is selected.

Only one name can be entered for each preset station.

When an RDS broadcast is received, the station name appears in the front panel display.

1 Press FUNCTION repeatedly until “TUNER FM” or “TUNER AM” appears in the front panel display.

The last received station is tuned in.

2 Press PRESET +/- repeatedly to select the preset station you want to create an index name for.

3 Press OPTIONS.

The options menu appears.

4 Press ↕ to select [Preset Name Input], then press ⊕.

The display for entering characters appears.

To enter characters, see the following Steps.

To enter characters

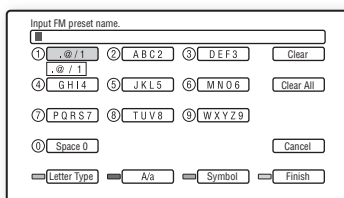

1 Press the number button repeatedly to select a character.

Example:

Press the number 3 button once to enter [D].

Press the number 3 button three times to enter [F].

2 Press →, and enter the next character.

3 Press the blue button ([Finish]) to finish.

You can use the following buttons to enter characters.

Buttons	Details
Red button [Letter Type]	Switches the keyboard between alphabet and numbers.
Green button [A/a]	Switches the keyboard between upper case and lower case.
Yellow button [Symbol]	Displays the keyboard for symbols.
Blue button [Finish]	The input is entered, and the system returns to the previous display.
CLEAR [Clear]/[Clear All]	Erases the character to the right of the cursor. To erase all displayed characters, press and hold CLEAR for 2 seconds or more.
RETURN [Cancel]	Returns to the previous display, canceling the input.
←/↑/↓/→, ⊕	<ul style="list-style-type: none"> Select an input function using ←/↑/↓/→, and press ⊕. Enter characters as follows: <ul style="list-style-type: none"> ① Select a character selection panel using ←/↑/↓/→, and press ⊕. ② Select a character using ←/→, and press ⊕.

Available OPTIONS for the Radio

1 Press OPTIONS.

The options menu appears.

2 Press ↕ to select an item, then press ⊕.

The available items differ depending on the situation.

Items	Details
[Preset Memory]	Preset 20 FM stations, 10 AM stations.
[Direct Tuning]	Input station frequency directly.
[Preset Name Input]	Enter a name for a preset station. [Preset Name Input] does not appear when the unit is receiving an RDS broadcast.
[FM Mode]	Select monaural or stereo reception of FM programs.

Viewing the station name or frequency in the front panel display

When the system is set to “TUNER FM” or “TUNER AM,” you can check the frequency using the front panel display.

Press DISPLAY.

Each time you press DISPLAY on the remote, the display changes as shown.

- ① Station name*
- ② Frequency**

* This is displayed if you have entered a name for a preset station.

** Returns to the original display when several seconds has elapsed.

Operating the tuner function using the tuner menu

You can operate the tuner function using the tuner menu on the front panel display.

To preset radio stations

- 1** Press FUNCTION repeatedly until “TUNER FM” or “TUNER AM” appears in the front panel display.
- 2** Press and hold TUNING +/- until the auto scanning starts.
Scanning stops when the system tunes in a station. “TUNED” and “ST” (for stereo program) light up in the front panel display.
- 3** Press TUNER MENU.
- 4** Press ↑/↓ repeatedly until “MEMORY?” appears in the front panel display.
- 5** Press ⊕ or →.



- 6** Press ↑/↓ to select the preset number you want.



Tip

- You can select the preset number directly by pressing the number buttons.

- 7** Press ⊕.
“COMPLETE!” appears in the front panel display, and the station is stored.
- 8** Repeat Steps 2 to 7 to store other stations.
- 9** Press TUNER MENU.
The system menu turns off.

To change the preset number

Select the desired preset number by pressing PRESET +/-, then perform the procedure from Step 3.

To listen to radio stations when you know the frequencies

- 1** Press FUNCTION repeatedly until “TUNER FM” or “TUNER AM” appears in the front panel display.
- 2** Press DIRECT TUNING.
- 3** Press the number buttons to select the frequencies.
- 4** Press ⊕.

Tip

- To improve reception, reorient the connected antennas (aerials).

If an FM program is noisy

If an FM program is noisy, you can select monaural reception. There will be no stereo effect, but reception will improve.

- 1** Press TUNER MENU.
- 2** Press ↑/↓ repeatedly until “FM MODE?” appears in the front panel display.



- 3** Press ⊕ or →.

4 Press ↑/↓ to select “MONO.”

- “STEREO”: Stereo reception.
- “MONO”: Monaural reception.

5 Press ⊕.

The setting is made.

6 Press TUNER MENU.

The system menu turns off.

7 Press ⊕.

“COMPLETE!” appears in the front panel display, and the station name is stored.

8 Press TUNER MENU.

The system menu turns off.

To name preset stations

You can enter a name for preset stations. These names (for example, “ABC”) appear in the front panel display when a station is selected.

Only one name can be entered for each preset station.

When an RDS broadcast is received, the station name appears in the front panel display.

1 Press FUNCTION repeatedly until “TUNER FM” or “TUNER AM” appears in the front panel display.

The last received station is tuned in.

2 Press PRESET +/- repeatedly to select the preset station you want to create an index name for.

3 Press TUNER MENU.

4 Press ↑/↓ repeatedly until “NAME IN?” appears in the front panel display.

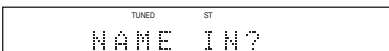

5 Press ⊕ or →.

6 Create a name by using ←/↑/↓/→.

Press ↑/↓ to select a character, then press → to move the cursor to the next position.



You can input letters, numbers, and other symbols for a radio station.

If you make a mistake

Press ←/→ repeatedly until the character to be changed flashes, then press ↑/↓ to select the desired character.

To erase the character, press ←/→ repeatedly until the character to be erased flashes, then press CLEAR.

Using the Radio Data System (RDS)

What is the Radio Data System?

The Radio Data System (RDS) is a broadcasting service that allows radio stations to send additional information along with the regular program signal. This tuner offers convenient RDS features, such as station name display. The station name appears on the TV screen as well.

RDS is available only for FM stations.*

Note

- RDS may not work properly if the station you are tuned to is not transmitting the RDS signal properly, or if the signal strength is weak.
- * Not all FM stations provide RDS service, nor do they provide the same type of services. If you are not familiar with the RDS system, check with your local radio stations for details on RDS services in your area.

Receiving RDS broadcasts

Simply select a station from the FM band.

When you tune in a station that provides RDS services, the station name* appears in the front panel display.

- * If an RDS broadcast is not received, the station name may not appear in the front panel display.

Using the DIGITAL MEDIA PORT Adapter

The DIGITAL MEDIA PORT (DMPORT) adapter (not supplied) is for enjoying sound from a portable audio source or computer. By connecting a DIGITAL MEDIA PORT adapter, you can enjoy sound from the connected component on the system.

Available DIGITAL MEDIA PORT adapters vary in each area.

For details on connecting the DIGITAL MEDIA PORT adapter, see “3 Connecting the other components” (page 59).

Note

- Do not connect an adapter other than the DIGITAL MEDIA PORT adapter.
- Do not connect or disconnect the DIGITAL MEDIA PORT adapter to/from the unit while the system is turned on.
- Depending on the type of DIGITAL MEDIA PORT adapter, the images are also output (page 61).
- When you use the system and the Bluetooth Wireless Audio Adapter (such as TDM-BT1, not supplied) at the same time, transmission distance between the Bluetooth transmitter and Bluetooth Wireless Audio Adapter may be reduced. In this case, place the Bluetooth transmitter as far as possible from the system, or move the Bluetooth Wireless Audio Adapter closer to the Bluetooth transmitter.
- When you use the system and the Wireless Network Audio Adapter (such as TDM-NC1, not supplied) at the same time, place the Wireless Network Audio Adapter as far as possible from the system.

Playing the connected component on the system

- 1 Press **FUNCTION** repeatedly until “DMPORT” appears in the front panel display.
- 2 Start playback of the connected component.

The sound and images from the connected component are played on the system or connected TV.

For operation details, refer to the operating instructions of the DIGITAL MEDIA PORT adapter.

Tip

- When listening to MP3 files or other compressed music using a portable audio source, you can enhance the sound. Select “A.F.D. STD” for the decoding mode (page 86) and set the sound mode (page 89) to “MOVIE,” “MUSIC,” or “NEWS.” To cancel, select other than “A.F.D. STD.”
- Depending on the type of DIGITAL MEDIA PORT adapter, you may be able to operate a connected component using either the buttons on the remote or the unit. The following illustration shows an example of buttons that can be used in this case.

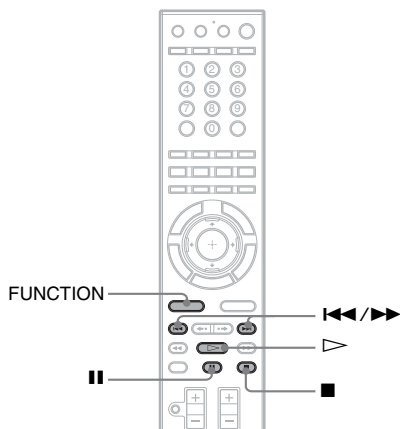

Using an S-AIR Product

The unit is compatible with the S-AIR function (page 155), which allows sound transmission between S-AIR products.

About S-AIR products

There are two types of S-AIR product.

- S-AIR main unit (this unit): This is for transmitting sound. You can use up to three S-AIR main unit. (The number of usable S-AIR main unit depends on the use environment.)
- S-AIR sub unit: This is for receiving sound.
 - **Surround amplifier:** You can enjoy surround speaker sound wirelessly.
 - **S-AIR receiver:** You can enjoy system sound in another room.

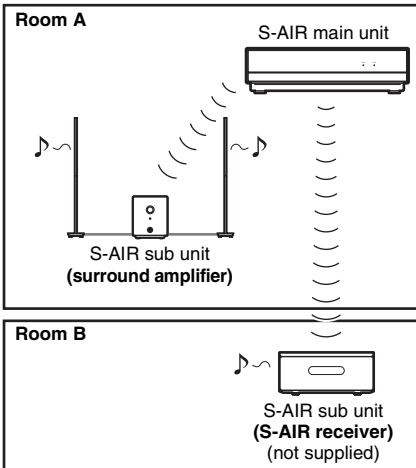

Note

- You cannot operate this function if you do not insert the wireless transceiver in the unit correctly (page 63).

Establishing sound transmission between the unit and S-AIR sub unit (ID setting)

For the surround amplifier

For the S-AIR receiver

Simply by matching the ID of the unit and the S-AIR sub unit, you can establish sound transmission.

To set the ID of the unit

- 1 Press I/⏻.**
The system turns on.
- 2 Press HOME.**
The home menu appears on the TV screen.
- 3 Press ←/→ to select [Setup].**
- 4 Press ↑/↓ to select [System Settings], then press ⊕.**
- 5 Press ↑/↓ to select [S-AIR ID], then press ⊕.**
- 6 Press ↑/↓ to select the desired ID, then press ⊕.**
You can select any ID (A, B, or C).
The confirmation display appears, then disappears automatically.
- 7 Set the S-AIR sub unit to the same ID.**
Sound transmission is established as follows (example):

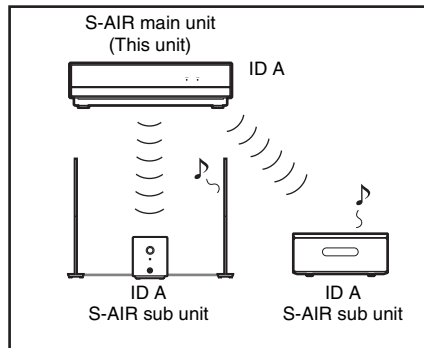

Tip

- To confirm the current ID, perform Steps 1 to 6 above. When you pair the unit with the S-AIR sub unit (page 102), [(Pairing)] appears beside ID on the display for selecting ID.

To set the ID of the surround amplifier

- 1** Make sure that the **SURROUND SELECTOR** switch of the surround amplifier is set to **SURROUND**.
- 2** Set the **S-AIR ID** switch of the surround amplifier to match the **ID (A, B, or C)** of the unit.
- 3** Press **POWER** on the surround amplifier.

When sound transmission is established, the **POWER / ON LINE** indicator of the surround amplifier turns green.

For details of the **POWER / ON LINE** indicator, see “To check the transmission status” (page 67).

Tip

- When you use the additional surround amplifier (optional) with the surround back speakers (optional), set the **SURROUND SELECTOR** switch to **SURROUND BACK**.

To set the ID of the S-AIR receiver

Refer to the operating instructions of the S-AIR receiver.

To use multiple S-AIR main units

You can use multiple S-AIR main units by setting a different ID for each component.

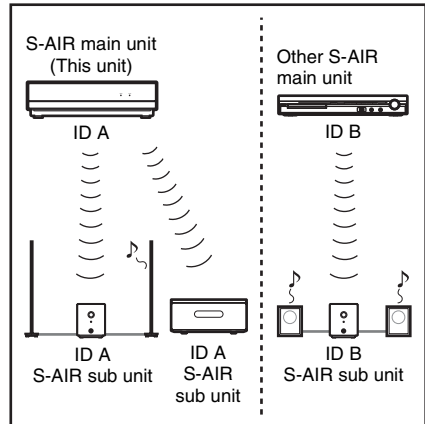

Enjoying the system's sound in another room

For the S-AIR receiver

You can enjoy the system's sound by using the S-AIR receiver. The S-AIR receiver can be installed anywhere, regardless of the location of the unit, for enjoying the system's sound in another room.

For details of the S-AIR receiver, refer to the operating instructions of the S-AIR receiver.

1 Set the ID of the S-AIR receiver to that of the main unit.

- To set the ID of the unit, see "To set the ID of the unit" (page 99).
- To set the ID of the S-AIR receiver, refer to the operating instructions of the S-AIR receiver.

2 Press S-AIR MODE on the remote of the main unit.

The S-AIR mode appears in the front panel display. Each time you press S-AIR MODE, the S-AIR mode changes.

- "PARTY": The S-AIR receiver outputs sound according to function set on the unit.
- "SEPARATE": You can set the desired function for the S-AIR receiver while unit functions do not change.

3 Select the desired function on the S-AIR receiver.

■ When "PARTY" is set

The S-AIR receiver's function changes sequentially as you press FUNCTION of the main unit (page 73).

■ When "SEPARATE" is set

The S-AIR receiver's function changes as follows.

"MAIN UNIT" → "TUNER FM" →
"TUNER AM" → "DMPORT" → ...

To enjoy the same function as the unit, select "MAIN UNIT."

When "TUNER FM" or "TUNER AM" is selected on the unit, you can only select the same band for the tuner on the S-AIR receiver. In this case, when you select other than "TUNER FM" or "TUNER AM" on the unit, you can select any band for the tuner on the S-AIR receiver.



4 Adjust the volume on the S-AIR receiver.

Note

- When the sound is other than 2 channel stereo, multi channel sound is downmixed to 2 channel.
- The sound of the S-AIR receiver may be cut off by operation of the unit.

To control the system from the S-AIR receiver

You can control the system from the S-AIR receiver by using the following buttons.

Press	Operation
	Share the same operations on the remote and unit.
	
S-AIR CH	Change the function of the system.

For details, refer to the operating instructions of the S-AIR receiver.

Enjoying the S-AIR receiver while the unit is in standby mode

For the S-AIR receiver

You can enjoy the S-AIR receiver while the unit is in standby mode by setting [S-AIR Standby] to [On].

- 1 Press I/\cup .**
The system turns on.
- 2 Press HOME.**
The home menu appears on the TV screen.
- 3 Press \leftarrow/\rightarrow to select [Setup] .**
- 4 Press \uparrow/\downarrow to select [System Settings], then press \oplus .**
- 5 Press \uparrow/\downarrow to select [S-AIR Standby], then press \oplus .**
- 6 Press \uparrow/\downarrow to select the desired setting.**
 - [On]: You can enjoy the S-AIR receiver while the unit is in standby mode or turned on.
 - [Off]: You cannot enjoy the S-AIR receiver while the unit is in standby mode.
- 7 Press \oplus .**
The setting is made.

Note

- When you set [S-AIR Standby] to [On], the power consumption during the standby mode increases.
- When you turn the system off while [S-AIR Standby] is set to [On], "S-AIR" flashes (when sound transmission between the unit and S-AIR receiver is not established), or lights up (when sound transmission between the unit and S-AIR receiver is established) in the front panel display.
- If you turn the system off with the disc tray opened while [S-AIR Standby] is set to [On], the disc tray may not close automatically.
- When the wireless transceiver is not inserted in the unit, you cannot set the [S-AIR Standby].
- [S-AIR Standby] is set to [Off] automatically when the wireless transceiver is removed from the unit.

Using the surround amplifier for the surround back speakers

For the surround amplifier

When you use the additional surround amplifier (optional) with surround back speakers (optional), set the SURROUND SELECTOR switch to SURROUND BACK. For details about the surround back speakers, see "About the surround back speaker" (page 38).

Identifying the unit with a specific S-AIR sub unit (Pairing operation)

For the surround amplifier

For the S-AIR receiver

It is easy to set the same ID for the unit and an S-AIR sub unit, such as a surround amplifier or S-AIR receiver, to establish sound transmission. However, neighbors may also receive your system's sound if IDs are the same, or you may receive the sound from neighbors. To prevent this, you can identify the unit with a specific S-AIR sub unit by performing the pairing operation.

■ Before pairing

Sound transmission is established by the ID (example).

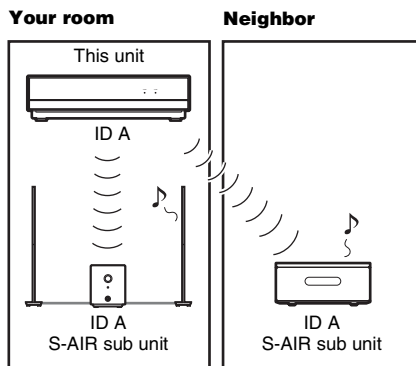

■ After pairing

Sound transmission is established between the paired unit and S-AIR sub unit(s) only.

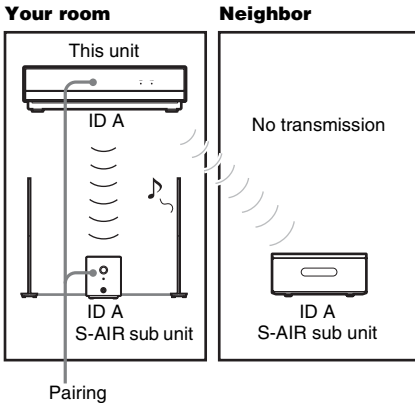

To perform pairing

1 Place the S-AIR sub unit that you want to pair near the unit.

Note

- Remove headphones from the surround amplifier (if connected).

2 Match the IDs of the unit and the S-AIR sub unit.

- To set the ID of the unit, see “To set the ID of the unit” (page 99).
- To set the ID of the surround amplifier, see “To set the ID of the surround amplifier” (page 100).
- To set the ID of the S-AIR receiver, refer to the operating instructions of the S-AIR receiver.

3 Press HOME.

The home menu appears on the TV screen.

4 Press \leftarrow/\rightarrow to select [Setup].

5 Press \uparrow/\downarrow to select [System Settings], then press \oplus .

6 Press \uparrow/\downarrow to select [S-AIR Pairing], then press \oplus .

The confirmation display appears.

7 Press \leftarrow/\rightarrow to select [OK], then press \oplus .

The unit starts pairing.

To not perform pairing, select [Cancel].

8 Start pairing of the S-AIR sub unit.

■ For the surround amplifier

Press POWER on the surround amplifier to turn on the surround amplifier and press PAIRING on the rear panel of the surround amplifier.

The PAIRING indicator of the surround amplifier flashes red when pairing starts. When sound transmission is established, the PAIRING indicator of the surround amplifier turns red and the confirmation display appears.

Tip

- To press PAIRING on the rear panel of the surround amplifier, a slim instrument, such as a paper clip, can be used.

■ For the S-AIR receiver

Refer to the operating instructions of the S-AIR receiver.

When sound transmission is established, the confirmation display appears.

Note

- Perform the pairing within several minutes after Step 8. If you do not, the pairing is canceled automatically and the confirmation display appears. To perform pairing, select [OK]. To return to the previous display, select [Cancel].

9 Press \leftarrow/\rightarrow to select the next operation.

■ To finish pairing

Select [Finish], then press \oplus .

■ To perform pairing of another S-AIR sub unit

Select [Continue], then press \oplus .

Note

- If you perform the pairing operation between the unit and another S-AIR sub unit (page 102), sound transmission established by ID is canceled.
- When you perform pairing, [(Pairing)] appears beside ID on the display for selecting ID.

To cancel pairing

Perform the ID setting of the unit according to the procedure of “To set the ID of the unit” (page 99). If you select a new ID (you can select the same ID as before), pairing is canceled.

If sound transmission is unstable

For the surround amplifier For the S-AIR receiver

If you use multiple wireless systems which sharing the 2.4 GHz band, such as wireless LAN or Bluetooth, the transmission of S-AIR products or other wireless systems may be unstable. In this case, the transmission may be improved by changing the following [S-AIR RF Change] setting.

1 Press HOME.

The home menu appears on the TV screen.

2 Press \leftarrow/\rightarrow to select [Setup].

3 Press \uparrow/\downarrow to select [System Settings], then press \oplus .

4 Press \uparrow/\downarrow to select [S-AIR RF Change], then press \oplus .

5 Press \uparrow/\downarrow to select the desired setting.

- [Auto]: Normally select this. The system changes the setting to [On] or [Off] automatically.
- [On]: The system transmits sound by searching the better channel for transmitting.
- [Off]: The system transmits sound by fixing the channel for transmitting.

6 Press \oplus .

The setting is made.

7 When you set to [Off], select the ID so that sound transmission is most stable (page 99).

Note

- In most cases, you will not need to change this setting.
- If [S-AIR RF Change] is set to [Off], transmission between the unit and S-AIR sub unit can be performed using one of the following channels.
 - S-AIR ID A: equivalent channel for Wi-Fi channel 1
 - S-AIR ID B: equivalent channel for Wi-Fi channel 6
 - S-AIR ID C: equivalent channel for Wi-Fi channel 11
- The transmission may be improved by changing the transmission channel (frequency) of the other wireless system(s). For details, refer to the operating instructions of the other wireless system(s).

Using the Control for HDMI Function for “BRAVIA” Sync

This function is available on TVs with the “BRAVIA” Sync function only.

By connecting Sony components that are compatible with the Control for HDMI function with an HDMI cable (not supplied), operation is simplified as below:

- Theatre Mode (page 106)
- One-Touch Play (page 106)
- System Power Off (page 107)
- Volume Limit (page 107)
- System Audio Control (page 107)
- Language Follow (page 107)

Control for HDMI is a mutual control function standard used by CEC (Consumer Electronics Control) for HDMI (High-Definition Multimedia Interface).

The Control for HDMI function will not work in the following cases:

- When you connect this system to a component which is not compatible with the Control for HDMI function.
- A component does not have an HDMI jack.

There are convenient buttons on the system’s remote for operating the TV, such as THEATRE, ONE-TOUCH PLAY, AV I/O. For details, see “Controlling the TV or Other Components with the Supplied Remote” (page 111) and refer to the operating instructions of the TV.

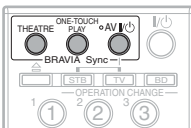

Note

- Depending on the connected component, the Control for HDMI function may not work. Refer to the operating instructions supplied with the component.
- The Control for HDMI function may not work if you connect a component other than Sony, even if the component is compatible with the Control for HDMI function.

Preparing for the Control for HDMI function

(Control for HDMI - Easy Setting)

The system is compatible with the Control for HDMI - Easy Setting function. If the TV is compatible with the Control for HDMI - Easy Setting function, you can set the system’s [Control for HDMI] function automatically by setting the TV. For details, refer to the operating instructions of the TV.

If the TV is not compatible with the Control for HDMI - Easy Setting function, set the Control for HDMI function of the system and TV manually.

Note

- Displayed items vary depending on the country model.

- 1 Make sure that the system is connected to the TV and the connected components (which should be compatible with the Control for HDMI function) using HDMI cables.**
- 2 Turn on the TV and press I/O to turn on the system.**
- 3 Switch the input selector on your TV so that the signal from the system through the HDMI input appears on the TV screen.**
- 4 Set the Control for HDMI function of the system and TV.**

The Control for HDMI function for the system and the connected component is simultaneously set to on.





During the setting, “SCANNING” appears in the front panel display. After you finish the setting, “COMPLETE” appears in the front panel display. Wait until the setting is complete.

Note

- For details on setting the TV and the connected components, refer to their operating instructions.

If “SCANNING” or “COMPLETE” does not appear after performing in Control for HDMI – Easy Setting

Set the Control for HDMI function to on for the system and the connected components individually.

- 1 Press HOME.**
The home menu appears on the TV screen.
- 2 Press ←/→ to select  [Setup].**
- 3 Press ↑/↓ to select [HDMI Settings], then press .**
The options for [HDMI Settings] appear.
- 4 Press ↑/↓ to select [Control for HDMI], then press .**
- 5 Press ↑/↓ to select [On], then press .**
The Control for HDMI function is set to on.
- 6 Set the Control for HDMI function of the connected component to on.**
For details on setting the connected component, refer to its operating instructions.
- 7 Select the input of the system connected to the component you want to use the Control for HDMI function for (HDMI1, HDMI2), and repeat Step 6.**

If you add or reconnect the component

Perform steps of “Preparing for the Control for HDMI function” again.

Note

- During the setting of the Control for HDMI function for the system, the System Audio Control function does not work.
- If the Control for HDMI function for the connected component cannot be set simultaneously by setting “CONTROL FOR HDMI” of the TV, set the Control for HDMI function using the menu of the connected component.
- For details on setting the TV and the connected components, refer to their operating instructions.

Tip

- The default setting of the Control for HDMI function of the system is [Off].

Using the Theatre Mode

(Theatre Mode)

When you press THEATRE, the system automatically switches to the optimum video mode for watching movies and the speaker output also switches automatically. When connected with a Theatre Mode-compatible TV using the HDMI cable, the TV's video mode switches to Theatre Mode.

Watching BD/DVD by a single button press

(One-Touch Play)

By only pressing ONE-TOUCH PLAY, the TV turns on, the TV is set for BD/DVD input selector, and the system starts playing a disc automatically.

The system and TV work as follows (e.g.):

This system	TV
Turns on. (If not already turned on.)	Turns on. (If not already turned on.)
↓	↓
Switches to “BD/DVD” function.	Switches to HDMI input.
↓	↓
Starts playing the disc and outputs the sound.	Minimizes sound level. (System Audio Control)

When playing back a connected component, the system and the TV turn on automatically and switch to the appropriate HDMI input.

Note

- Make sure the HDMI connection is correct, and set the [Control for HDMI] to [On].
- Depending on the TV, the beginning of the content may not be played back.
- Depending on the disc, playback may take a while to start.
- One-Touch Play does not work when you press .

Turning the system off in sync with the TV

(System Power Off)

When you turn the TV off by using the POWER button on the TV's remote or AV  on the system's remote, the system turns off automatically.

Note

- Before using the System Power Off function, set the function for TV power. For details, refer to the operating instructions of the TV.
- Depending on the status, the system or the connected components may not turn off automatically. For details, see the operating instructions supplied with the connected components.

Setting the Maximum Volume Level of the System

(Volume Limit)

If you change the output method of the TV to the system speaker on the TV menu or by pressing THEATRE, loud sound may be output depending on the volume level of the system. You can prevent this by limiting the maximum level of the volume. For details, see [Volume Limit] (page 124).

Enjoying TV sound from the speakers in this system

(System Audio Control)

You can enjoy TV sound in this system by easy operation.

To use this function, connect the system and the TV with an audio cord (not supplied) and an HDMI cable (not supplied) (page 57).

You can use the System Audio Control function as follows:

- You can enjoy TV sound from the speakers of the system by means of a simple operation. For details, see the operating instructions of the TV.

- When the system is turned on, the TV sound will be output from the speakers of the system.
- When the TV sound is output from the speakers of the system, you can adjust the volume and turn off the sound of the system using the TV remote.

Note

- If the TV is turned on before turning on the system, TV sound will not be output for a moment.
- While the TV is in PAP (picture and picture) mode, the System Audio Control function will not work. When the TV exits PAP mode, the output method of the TV returns to the one before PAP mode.
- When you switch the TV input selector, or depending on the status of the connected components, the system may switch the input automatically.

Tip

- You can connect the system and the TV audio digitally. For details, see page 57.

Changing the language for the on-screen display of the TV

(Language Follow)

When you change the language for the on-screen display of the TV, the system's on-screen display language is also changed after turning the system off and on.

Calibrating the Appropriate Settings Automatically

[Auto Calibration]

D. C. A. C. (Digital Cinema Auto Calibration) can set the appropriate surround sound automatically.

Note

- The system outputs a loud test sound when [Auto Calibration] starts. You cannot turn the volume down. Give consideration to children and neighbors.
- Make sure that the headphones are not connected to the surround amplifier. You cannot operate the following Steps with the headphones connected.

- 1 Press HOME.**
The home menu appears on the TV screen.
- 2 Press </> to select [Setup].**
- 3 Press ↑/↓ to select [Audio Settings], then press ⊕.**
- 4 Press ↑/↓ to select [Auto Calibration], then press ⊕.**
The confirmation display for [Auto Calibration] appears.

- 5 Connect the calibration mic to the A.CAL MIC jack on the rear panel.**
Set up the calibration mic at the ear level using a tripod, etc. (not supplied). The front of each speaker should face the calibration mic, and there should be no obstruction between the speakers and the calibration mic.

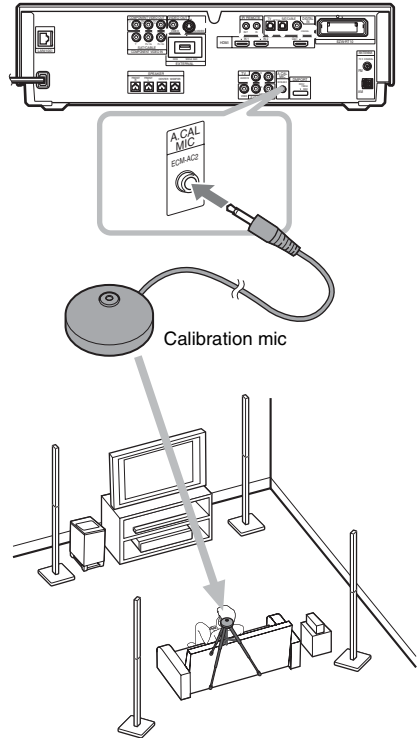

Ex. BDV-IT1000

- 6 Press ↑/↓ to select [OK].**
To cancel, select [Cancel].

7 Press \oplus .

[Auto Calibration] starts.

The system adjust the speaker setting automatically.

Be quiet during the measurement.

Note

- Before [Auto Calibration], make sure that the surround amplifier turns on and you install the surround amplifier in the appropriate location. If you install the surround amplifier in an improper location, such as another room, proper measurement will not be obtained.
- When you use the additional surround amplifier for the surround back speakers (optional), make sure that the additional surround amplifier turns on and you install the additional surround amplifier in the appropriate location.
- Avoid being in the measurement area and making noise during the measurement (about 1 minute), to avoid measurement failure. During the measurement, test signals are output from the speakers.
- The environment of the room in which the system is installed may affect measurements.
- Loud test sound is output when [Auto Calibration] starts. You cannot turn the volume down. Give consideration to children and neighbors.
- If an error message appears, follow the message, then select [OK].
An error message appears when:
 - the headphones are connected to the surround amplifier.
 - the calibration mic is not connected.
 - front speakers are not correctly connected.
 - surround speakers are not correctly connected.
 - surround back speakers (optional) are not correctly connected.
 - subwoofer is not connected.

8 Confirm the conclusions of [Auto Calibration].

The conclusions appear on the TV screen.

Press \leftarrow/\rightarrow to change the page. The first page shows the distance of speakers. The second page shows the level of speakers.

Note

- If measurement fails, follow the message then retry [Auto Calibration].

9 Press \uparrow/\downarrow to select [OK] or [Cancel], then press \oplus .

■ The measurement is OK.

Disconnect the calibration mic, then select [OK]. The result is implemented.

■ The measurement is not OK.

Follow the message, then select [OK] to retry.

Note

- While the Auto Calibration function works:
 - do not turn off the power.
 - do not press any button.
 - do not change the volume.
 - do not change the function.
 - do not change the disc.
 - do not insert or eject a disc.
 - do not connect the headphones to the surround amplifier.
 - do not disconnect the calibration mic.

Tip

- You can check the distance between the listening position and each speaker. See page 110.

Setting the Speakers

[Speaker Settings]

To obtain the best possible surround sound, set connection of the speakers and their distance from your listening position. Then use the test tone to adjust the level and the balance of the speakers to the same level.

Note

- You cannot operate [Speaker Settings] when you connect headphones to the surround amplifier.

1 Press HOME.

The home menu appears on the TV screen.

2 Press ←/→ to select [Setup].

3 Press ↑/↓ to select [Audio Settings], then press ⊕.

4 Press ↑/↓ to select [Speaker Settings], then press ⊕.

The [Speaker Settings] display appears.

5 Press ↑/↓ to select the item, press ⊕.

Setup the following settings.

■ [Connection]

If you do not connect center or surround speakers, set the parameters for [Center] and [Surround]. Since the front speaker and subwoofer setting is fixed, you cannot change them.

When you use the additional surround amplifier for the surround back speakers (optional) (page 37), set [Surround Back] also.

[Front]

[Yes]

[Center]

[Yes]: Normally select this.

[None]: Select this if no center speaker is used.

[Surround]

[Yes]: Normally select this.

[None]: Select this if no surround speaker is used.

[Surround Back]

[Yes]: Select this if surround back speaker is used.

[None]: Select this if no surround back speaker is used.

[Subwoofer]

[Yes]

■ [Distance]

When you move the speakers, be sure to set the parameters of the distance (A) from the listening position to the speakers.

You can set the parameters from 0.0 to 7.0 meters.

The speakers in the illustration correspond to the following:

- ① Center speaker
- ② Front left speakers (L)
- ③ Front right speakers (R)
- ④ Subwoofer
- ⑤ Surround left speakers (L)
- ⑥ Surround right speakers (R)
- ⑦ Surround back left speakers (L)
- ⑧ Surround back right speakers (R)

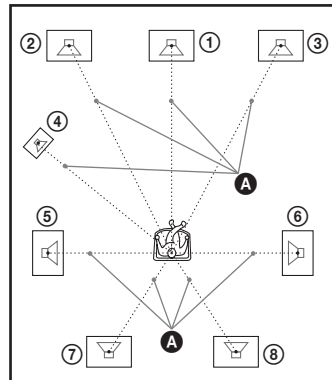

[Front L/R] 3.0 m: Set the front speaker distance.

[Center] 3.0 m*: Set the center speaker distance.

[Surround L/R] 3.0 m*: Set the surround speaker distance.

[Surround Back L/R] 3.0 m*: Set the surround back speaker distance.

[Subwoofer] 3.0 m: Set the subwoofer distance.

* This item appears when you set to [Yes] in the [Connection] setting.

Note

- When you perform [Auto Calibration] in the Easy Setup (page 69), the default settings are changed.
- Depending on the input stream, [Distance] may not be effective.

■ [Level]

You can adjust the sound level of the speakers, center speaker, and subwoofer. You can set the parameters from -6.0 dB to $+6.0$ dB. Be sure to set [Test Tone] to [On] for easy adjustment.

[Front L/R] 0.0 dB: Set the front speaker level.

[Center] 0.0 dB*: Set the center speaker level.

[Surround L/R] 0.0 dB*: Set the surround speaker level.

[Surround Back L/R] 0.0 dB*: Set the surround Back speaker level.

[Subwoofer] 0.0 dB: Set the subwoofer level.

* This item appears when you set to [Yes] in the [Connection] setting.

■ [Test Tone]

The speakers will emit a test tone to adjust [Level].

[Off]: The test tone is not emitted from the speakers.

[On]: The test tone is emitted from each speaker in sequence while adjusting level. When you select one of the [Speaker Settings] items, the test tone is emitted from each speaker in sequence.

Adjust the sound level as follows.

- 1** Set the [Test Tone] to [On].
- 2** Press $\leftarrow/\uparrow/\downarrow/\rightarrow$ repeatedly to select the desired speaker and the level.
- 3** Press \oplus .
- 4** Repeat Steps 1 to 3.
- 5** Press $\leftarrow/\uparrow/\downarrow/\rightarrow$ repeatedly to set [Test Tone] to [Off] after adjusting the speaker level.

Note

- The test tone signals are not output from the HDMI OUT jack.

Tip

- To adjust the volume of all the speakers at one time, press \triangleleft +/-.

Controlling the TV or Other Components with the Supplied Remote

By adjusting the remote signal, you can control your TV, a Sony component (such as a VCR, DVD player/recorder, etc.), CATV, or set-top box/digital satellite receiver with the supplied remote.

Note

- When you replace the batteries of the remote, the code number may reset itself to the default (SONY) setting. Reset the appropriate code number.

Preparing the remote for controlling the components

- 1** Press **POP UP/MENU** while pressing **TV (for TV) or STB (for a Sony component, CATV, set-top box/digital satellite receiver, etc.)**.
TV or STB (pressed button) flashes.
- 2** While **TV or STB** is flashing, enter the **manufacturer's code (see the table) using the number buttons, then press TIME**.

If you successfully set the manufacturer's code, TV or STB will flash twice slowly. If the setting is unsuccessful, TV or STB will flash five times quickly.

Code numbers of controllable components

If more than one code number is listed, try entering them one at a time until you find the code that works with your TV.

TV

Manufacturer	Code number
SONY	5001 (default), 5002
AIWA	5001
AKAI	5003
DAEWOO	5003, 5015, 5044
GE	5003, 5009, 5010, 5044
GOLDSTAR/LG	5003, 5015, 5017, 5044, 5068

Manufacturer	Code number
HITACHI	5003, 5014, 5015, 5017, 5044, 5057, 5071
JVC	5016
KMC	5017
MAGNAVOX	5003, 5015, 5017, 5018, 5044, 5066
MARANTZ	5027
MITSUBISHI/MGA	5003, 5027, 5044, 5066, 5068
NEC	5003, 5017, 5044, 5066
PANASONIC	5009, 5053, 5072
PHILIPS	5015, 5018, 5057, 5070, 5071
PIONEER	5009, 5025, 5051
RCA/PROSCAN	5003, 5010, 5044
SAMPO	5066
SAMSUNG	5003, 5015, 5017, 5044, 5057, 5066, 5069, 5074
SHARP	5017, 5035, 5065
TOSHIBA	5035, 5041, 5051

Sony component

VCR	7001, 7002, 7003
DVD player/recorder	4001, 4002, 4003, 4004

CATV

Manufacturer	Code number
SONY	8501
ABC	8513, 8555
ADELPHIA	8507, 8510
ADVANCED NEWHOUSE	8507
ALTRIO	8507
AMERICAST	8505
ATLANTIC BROADBAND	8507
BELL & HOWELL	8513
BELL SOUTH	8505
BLUE RIDGE	8507
BRIGTH HOUSE	8507
CABLEVISION	8507
CHARTER	8507
COMCAST	8507
COX	8507
DIRECTOR	8503
GEMINI	8036, 8543

Manufacturer	Code number
GENERAL INSTRUMENT	8018, 8032, 8503, 8512, 8513, 8514, 8515, 8516, 8517, 8518, 8519, 8532, 8553, 8554, 8557
GNC	8505
GOLDSTAR	5825
HAMLIN	8023, 8024, 8025, 8026, 8532, 8533, 8534, 8535, 8536
ILLICO	8507
JERROLD	8001, 8002, 8003, 8004, 8005, 8006, 8007, 8008, 8018, 8022, 8032, 8503, 8512, 8513, 8514, 8515, 8516, 8517, 8518, 8519, 8532, 8553, 8554, 8557
MACOM	8033, 8034, 8035, 8540, 8541, 8542
MAGNAVOX	8037
MEMOREX	8506, 8523, 8544
MOTOROLA	8503, 8510, 8511
NET	8030, 8552
OAK	8027, 8028, 8029, 8537, 8538, 8539
PACE	8507
PANASONIC	8019, 8020, 8021, 8523, 8529, 8530, 8531
PARAGON	8506, 8523
PHILIPS	8039, 8040, 8041, 8043, 8044, 8504, 8546, 8547, 8548, 8549, 8550, 8551
PIONEER	8014, 8015, 8507, 8525, 8526
PULSAR	8506, 8523
QUASAR	8523
REGAL	8532, 8533, 8534, 8535, 8536
RODGERS	8507
RUNCO	8506, 8523
SAMSUNG	8038, 8525, 8545
SCIENTIFIC ATLANTA	8009, 8010, 8011, 8502, 8507, 8508, 8509, 8520, 8521, 8522, 8555, 8556
SEREN	8507
SIGECOM	8507
SUSQUEHANNA	8507
TIME WARNER	8507
TOCOM	8016, 8017, 8031, 8527, 8528, 8553
TOSHIBA	8506, 8523
VIDEOTRON	8507

Manufacturer	Code number
WIDOPENWEST	8505, 8507
ZENITH	8012, 8013, 8505, 8506, 8523, 8524

Set-top box/digital satellite receiver

Manufacturer	Code number
SONY	8201, 8202 (default), 8203, 8701, 8702, 8703
ADB	8262
ALPHASTAR	8710
AMSTRAD	8204, 8225, 8226, 8247, 8259
B sky B	8243
CANAL +	8208
CROSSDIGITAL	8717
DGTEC	8292, 8293, 8294
DIRECTV	8713, 8717, 8718, 8719, 8723, 8714
DISH NETWORK	8712, 8714, 8725
ECHOSTAR	8712, 8720
GALAXIS	8212, 8214, 8216, 8232, 8233, 8254, 8272
GE	8719
GENERAL INSTRUMENT	8711
Gold Box	8238
Grundig	8228, 8229, 8237, 8265
HIRSCHMANN	8263
HITACHI	8707
HUGHES	8706
Hyundai	8245
Jerrold	8240
JVC	8712, 8714, 8720
KATHREIN	8224, 8244, 8250
MAGNAVOX	8715, 8716, 8718
MATSUI	8227
MEMOREX	8716
NIKKO	8223
NOKIA	8219, 8239, 8257, 8276, 7277
NTV PLUS 2000	8242
On digital	8273
PACE	8217, 8218, 8222, 8243, 8260, 8261
PANASONIC	8267, 8705

Manufacturer	Code number
PAYSAT	8716
PHILIPS	8255, 8278, 8715, 8716, 8718
PROSCAN	8704, 8709, 8719
RADIX	8213, 8226, 8231, 8253
RCA	8704, 8709, 8719, 8721
SABA	8210, 8211, 8230, 8234, 8235, 8248, 8270, 8286
SAMSUNG	8287, 8288, 8717, 8722
Sky	8243
SKY MASTER	8205, 8207, 8285
Sky+	8295
STAR SIGHT	8716
STRONG	8289, 8290, 8291
TECHNISAT	8220, 8221, 8236, 8241, 8246, 8252, 8266, 8268, 8279, 7280
Thomson	8234, 8271, 8274, 8275
TOMSON	8283, 8284
TOSHIBA	8708
TPS	8256
UNIDEN	8715, 8716
WATSON	8206
Zehnder	8209, 8215, 8249, 8251, 8264, 8268, 8269, 8281, 8282

Controlling the TV with the remote

You can control the TV using the following buttons. To use these buttons, set the remote to the TV mode by pressing TV (TV lights up for 1 second).

Note

- During the TV mode, if you press any of the following buttons, TV lights up. (Depending on the manufacturer setting, some buttons may not work, and TV does not light up.)
- When you press other than the following buttons during the remote is in the TV mode, TV does not light up.
- Depending on the TV, you may not be able to control your TV or to use some of the buttons.

By pressing	You can
AV I/⏻	Turn the TV on or off.
THEATRE	Enjoy optimal image suited for movies.
⏪/⏩	Switch the TV's input source between the TV and other input sources. After pressing ⏪, you can hold the current text page.
⏴ +/-	Adjust the TV volume.
PROG +/-, ⏪/⏩	Select the TV channel. After pressing ⏪, you can select the next (⏪) or previous (⏩) text page.
🔇	Turn off the TV sound temporarily.
Number buttons, -/--	Select the TV channel. After pressing ⏪, you can select the text page by entering the three digit page number.
HOME	Display the menu of the TV.
ANALOG	Switch to analogue mode.
DIGITAL	Switch to digital mode.
ⓘ/❓	Display the information.
☰	Access text.
☰	Display the Digital Electronic Programme Guide (EPG).
TOOLS	Display the operation menu for the current display.
RETURN	Return to the previous channel or layer on the menu of the TV.

By pressing	You can
⏶	Change the aspect ratio of the connected TV.
⏪/⏩/⏴/⏵, ⊕	Select the item on the menu.
▶*	Start playback.
⏸*	Pause playback.
■*	Stop playback.
⏮/⏭/⏪/⏩*	Skips to the previous/next chapter, track, or file.
◀••/••▶*	Replay the scene/briefly fast forward the scene.
⏮/⏭*	Fast reverse/fast forward during playback.

- * Only available for the component that is connected to the TV with the HDMI or iLINK connection. For details, see the operating instructions of the TV.

Tip

- The function of these buttons are same as the remote buttons of the Sony TV. For details, refer to the operating instructions of the TV.

Controlling the Sony component, CATV, or set-top box/digital satellite receiver

You can control the Sony component such as a VCR or DVD player/recorder, CATV, or set-top box/digital satellite receiver using the following buttons. To use these buttons, set the remote to the STB mode by pressing STB (STB lights up for 1 second).

Note

- During the STB mode, if you press any of the following buttons, STB lights up. (Depending on the manufacturer setting, some buttons may not work, and STB does not light up.)
- When you press other than the following buttons during the remote is in the STB mode, STB does not light up.
- Depending on the component, you may not be able to control the component or to use some of the buttons.

By pressing	You can
AV I/⏻	Turn the set-top box/digital satellite receiver on or off.
PROG +/-	Select the set-top box/digital satellite receiver channel.
Number buttons, ENTER	Select the set-top box/digital satellite receiver channel.
HOME	Display the menu of the set-top box/digital satellite receiver.
OPTIONS	Display the options menu that can be selected appears on the TV screen.
RETURN	Return to the previous channel or layer on the menu of the set-top box/digital satellite receiver.
CLEAR	Clear the entry field.
←/↑/↓/→, ⊕	Select the item on the menu.
DVD RECORDER (HDD, DVD)*	Change the operation mode for Sony DVD recorders.
▷*	Start playback.
⏸*	Pause playback.
■*	Stop playback.
•→*	Briefly fast forward the scene.
◀/▶*	Fast reverse/fast forward during playback.

* Only available for Sony component such as a VCR, DVD player/recorder, etc.

Using the Sound Effect

Enjoying the sound at low volume

You can enjoy sound effects or dialog, as you would in a movie theater, even at low volume. It is useful for watching movies at night.

Press NIGHT.

“NIGHT ON” appears in the front panel display and the sound effect is activated.

During the night mode is on, “NIGHT” lights up in the front panel display.

Note

- When sound is output from the center speaker, this effect is more pronounced, as speech (movie dialog, etc.) is easy to hear. When sound is not output from the center speaker, or you are using the headphones, the system optimally adjusts the volume.

To turn off the sound effect

Press NIGHT so that “NIGHT” disappears from the front panel display.

Adjusting the sound

You can adjust the sound by changing the tonal balance of the sound.

1 Press TONE repeatedly until the desired setting appears in the front panel display.

- “BASS”: You can adjust the bass frequencies.
- “MIDDLE” (BDV-IS1000 only): You can adjust the middle frequencies.
- “TREBLE”: You can adjust the treble frequencies.

2 Press ↑/↓ to adjust the sound.

The adjusted value appears in the front panel display. You can set the value from -6.0 to +6.0.

Using the Sleep Timer

You can set the system to turn off at a preset time, so you can fall asleep listening to music. You can preset the time in 10-minute increments.

Press SLEEP.

Each time you press SLEEP, the minutes display (the remaining time) changes by 10-minutes. When you set the sleep timer, "SLEEP" flashes in the front panel display.

To check the remaining time

Press SLEEP once.

To change the remaining time

Press SLEEP repeatedly to select the desired time.

Deactivating the Buttons on the Unit

(Child Lock)

You can deactivate the buttons on the unit (except for ) for preventing misoperation, such as child mischief (child lock function).

Press ■ on the unit for more than 5 seconds.

"CHILD LOCK" and "ON" appear in the front panel display.

The child lock function is activated and the buttons on the unit are locked. (You can operate the system by using the remote.)

To cancel, press ■ for more than 5 seconds so that "CHILD LOCK" and "OFF" appear in the front panel display.

Note

- When you operate the buttons on the unit while the child lock function is on, "CHILD LOCK" appears in the front panel display.

Using the Setup Display

You can make various adjustments of items such as picture and sound.

Select  (Setup) on the home menu when you need to change the settings of the system.

Note

- Playback settings stored in the disc take priority over the Setup Display settings and not all the functions described may work.

1 Press HOME.

The home menu appears on the TV screen.

2 Press \leftarrow/\rightarrow to select  [Setup].

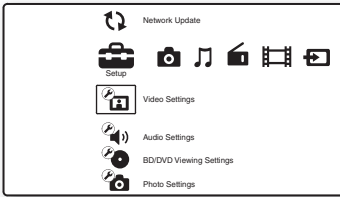

3 Press \uparrow/\downarrow to select the setup category icon to change, then press \oplus .

Example: [Video Settings]

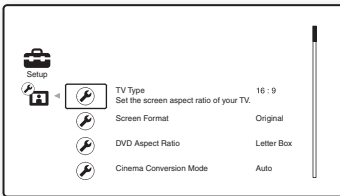

4 Press \uparrow/\downarrow to select an item, then press \oplus .





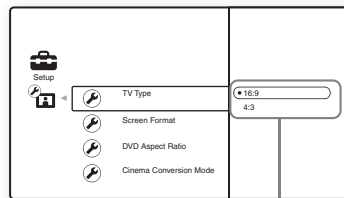





The options for the selected item appear.

Example: [TV Type]



Options

You can setup the following options.

Icon	Explanation
	[Network Update] (page 118) Updates the software of the system.
	[Video Settings] (page 119) Makes the video settings according to the type of connecting jacks.
	[Audio Settings] (page 121) Makes the audio settings according to the type of connecting jacks.
	[BD/DVD Viewing Settings] (page 122) Makes detailed settings for BD/DVD playback.
	[Photo Settings] (page 124) Makes the photo-related settings.
	[HDMI Settings] (page 124) Makes the HDMI settings.
	[System Settings] (page 126) Makes the system-related settings.
	[Network Settings] (page 127) Makes detailed settings for Internet and network.
	[Easy Setup] (page 128) Re-runs the Easy Setup to make the basic settings.
	[Resetting] (page 129) Resets the system to the factory settings.

5 Press \uparrow/\downarrow to select a setting, then press \oplus .

The setting is selected and setup is complete.

The options for the selected item appear.

Example: [4:3]

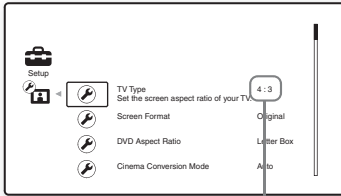

Selected setting

[Network Update]

You can update and improve the functions of the system.

For information about update functions, refer to the following website;

<http://www.sony.net/>

1 Press \uparrow/\downarrow to select [Network Update], then press \oplus .

The unit connects to the network, and the display asks for confirmation.

2 Press \leftarrow/\rightarrow to select [OK], then press \oplus .

The unit starts downloading, then updating the software automatically.

When updating finishes, “COMPLETE!” appears for 5 seconds in the front panel display, then the system automatically turns off.

3 Press I/Power to turn the system on.

The system starts up with the updated software.

Note

- Do not disconnect the AC power cord (mains lead) or network cable while downloading or updating software.
- Any operations, including opening the disc tray, are not available while updating.
- Downloading times may differ depending on the server provider or line status.
- When error messages on network connections appear, check the network connections using [Network Diagnostic] of [Internet Settings] in [Network Settings] (page 127).

Tip

- The “UPDATE */9” counter (“*” indicates update step) in the front panel display also shows progress of the update.
- You can check the current software version by selecting [System Information] in [System Settings] (page 126).
- The [Setup] settings remain after updating.
- The system informs you of newer software version information when [Software Update Notification] is set to [On] (default) (page 126).

To update the software using an update disc

You can update and improve the functions of the system using an update disc provided by Sony dealer or local authorized Sony service facility.

1 Insert the update disc.

The display asks for confirmation.

2 Select [OK], and press \oplus .

Software update starts.

When updating finishes, "COMPLETE!" appears for 5 seconds in the front panel display, then the disc tray automatically opens.

3 Remove the disc.

The system automatically turns off.

4 Press I/Power to turn the system on.

The system starts up with the updated software.

Note

- Do not disconnect the AC power cord (mains lead) while updating.
- Any operations, including opening the disc tray, are not available while updating.

Tip

- The "UPDATE */9" counter ("*" indicates update step) in the front panel display also shows progress of the update.
- You can check the current software version by selecting [System Information] in [System Settings] (page 126).
- The [Setup] settings remain after updating.
- For information about other software update methods, refer to the following website or consult your nearest Sony dealer or local authorized Sony Service facility;
<http://www.sony.net/>

[Video Settings]

You can make the video settings according to the type of connecting jacks.

■ [TV Type]

You can select the aspect ratio of the connected TV.

[16:9]: Select this when connecting to a wide-screen TV or a TV with a wide mode function.

[4:3]: Select this when connecting to a 4:3 screen TV without a wide mode function.

■ [Screen Format]

You can select the display configuration for a 4:3 screen picture on a 16:9 wide screen TV.

[Original]: Select this when connecting to a TV with a wide mode function. Displays a 4:3 screen picture in 16:9 aspect ratio even on a wide-screen TV.

[Fixed Aspect Ratio]: Changes the picture size to fit the screen size with the original picture aspect ratio.

■ [DVD Aspect Ratio]

You can select the display configuration for playback of 16:9 screen pictures on a 4:3 screen TV (selectable when [TV Type] is set to [4:3] and [Screen Format] is set to [Fixed Aspect Ratio]).

[Letter Box]: Displays a wide picture with black bands on the top and bottom.



[Pan & Scan]: Displays a full-height picture on the entire screen, with trimmed sides.



■ [Cinema Conversion Mode]

You can set the video conversion method for 480p/576p, 720p, 1080i, or 1080p* signals from the HDMI OUT jack or the COMPONENT VIDEO OUT jacks.

* HDMI only

[Auto]: Normally select this. The unit automatically detects whether the material is video-based or film-based, and switches to the appropriate conversion method.

[Video]: The conversion method suited for video-based material will always be selected regardless of the material.

■ [Output Video Format]

Select the jack type to output video signals ([TV Connection Method]), then select output resolution for the HDMI/component connection ([HDMI Resolution]/[Component Resolution]).

1 Press **↑/↓** to select the jack type to output video signals, then press **⊕**.

Note

- When connecting the HDMI OUT jack and other video output jacks at the same time, select [Component Video].

[TV Connection Method]

[HDMI]: Outputs signals from the HDMI OUT jack according to the [HDMI Resolution] setting below.

[Component Video]: Outputs signals from the COMPONENT VIDEO OUT jacks according to the [Component Resolution] setting below.

[Video or S Video]: Outputs signals from the VIDEO OUT (VIDEO) or VIDEO OUT (S VIDEO) jack.

2 (When you select [HDMI] or [Component Video])

Press **↑/↓** to select the signal type for the HDMI OUT jack or COMPONENT VIDEO OUT jacks, then press **⊕**.

When you change the video output resolution, a picture is displayed in the selected resolution for about 30 seconds, then the display asks for confirmation.

Follow the on-screen instructions.

“HD” lights up in the front panel display when outputting 720p/1080i/1080p video signals.

Note

- If the picture is distorted or no picture appears, wait for about 30 seconds without pressing any buttons. The display returns to the resolution setting screen.
- If the selected video output resolution is incorrect, no picture appears on the screen when you press any button in 30 seconds. In this case, press and hold **▷** and **⊕** on the unit for more than 5 seconds to reset the video output resolution to the lowest resolution.
- When connecting the HDMI OUT jack and other video output jacks at the same time, video signals may not output from the jacks, other than from the HDMI OUT jack, when [Auto] or [1080p] is selected.

[HDMI Resolution]/[Component Resolution]

[Auto] (HDMI only): Normally select this. The unit outputs signals starting from the highest resolution acceptable to the TV: 1080p > 1080i > 720p > 480p/576p > 480i/576i

If the resulting image format is undesirable, try another setting that suits your TV.

[480i/576i]: Outputs 480i/576i video signals.

[480p/576p]: Outputs 480p/576p video signals.

[720p]: Outputs 720p video signals.

[1080i]: Outputs 1080i video signals.

[1080p] (HDMI only): Outputs 1080p video signals.

■ [Pause Mode] (BD/DVD VIDEO/DVD-R/DVD-RW only)

You can select the picture in pause mode.

[Auto]: The picture, including subjects that move dynamically, is output with no jitter. Normally select this position.

[Frame]: The picture, including subjects that do not move dynamically, is output in high resolution.



[Audio Settings]

You can make the audio settings.

■ [BD Audio Setting]

Selects whether to mix or not mix interactive audio and secondary audio (commentary) when playing a BD that contains such audio.

[Mix]: Outputs the audio obtained by mixing the interactive audio and secondary audio to the primary audio.

[Direct]: Outputs the primary audio only.

■ [Audio DRC] (BD/DVD VIDEO only)

You can compress the dynamic range of the sound track. [Audio DRC] is useful for watching movies at low volume late at night.

[Auto]: Performs playback at the dynamic range specified by the disc (BD-ROM only). Other discs are played back at the “Standard” level.

[Off]: No compression of dynamic range.

[Standard]: The system reproduces the sound track with the kind of dynamic range that the recording engineer intended.

[Max]: The system compresses dynamic range fully.

■ [Fs Limit]

You can select the upper limit of sampling frequency in the audio signal for full sound adjustment.

[On]: Sets to 48kHz. You can operate all of the sound control functions of the system.

[Off]: Sets to 192kHz.

Note

- [Fs Limit] works only for the “BD/DVD,” “HDMI1,” or “HDMI2” function.
- In DTS96/24 format, some sound control functions do not work even if you set to [On].

■ [Attenuate - TV]

Distortion may occur when you listen to a component connected to the TV jacks.

Distortion is not a malfunction and will depend on the component connected.

To prevent distortion, reduce the input level on the unit.

[On]: Attenuates the input level. The output level is changed.

[Off]: Normal input level.

■ [Attenuate - SAT/CABLE]

Distortion may occur when you listen to a component connected to the SAT/CABLE IN jacks. Distortion is not a malfunction and will depend on the component connected.

To prevent distortion, reduce the input level on the unit.

[On]: Attenuates the input level. The output level is changed.

[Off]: Normal input level.

■ [Speaker Settings]

To obtain the best possible surround sound, set the speakers. For details, see “Setting the Speakers” (page 110).

■ [Auto Calibration]

You can calibrate the appropriate settings automatically. For details, see “Calibrating the Appropriate Settings Automatically” (page 108).

[BD/DVD Viewing Settings]

You can make detailed settings for BD/DVD playback.

■ [BD/DVD Menu]

You can select the default menu language for BD-ROMs or DVD VIDEOS. When you select [Select Language Code], the display for entering the language code appears. Enter the code for your language by referring to “Language Code List” (page 149).

■ [Audio]

You can select the default track language for BD-ROMs or DVD VIDEOS. When you select [Original], the language given priority in the disc is selected. When you select [Select Language Code], the display for entering the language code appears. Enter the code for your language by referring to “Language Code List” (page 149).

■ [Subtitle]

You can select the default subtitle language for BD-ROMs or DVD VIDEOS. When you select [Select Language Code], the display for entering the language code appears. Enter the code for your language by referring to “Language Code List” (page 149).

■ [BD Parental Control]

Playback of some BD-ROMs can be limited according to the age of the users. Scenes may be blocked or replaced with different scenes.

- 1 Enter your four-digit password using the number buttons.**
- 2 Press \uparrow/\downarrow to select [OK], then press \oplus .**
- 3 Press \uparrow/\downarrow to select the age restriction, then press \oplus .**

The lower the value, the stricter the limitation.

If you select [Select Age Restriction], you can enter the age from [0] to [255] using \leftarrow/\rightarrow and the number buttons.

To cancel the Parental Control setting
Select [No Restrictions].

Note

- If you forget the password, reset the system (page 129) and set a new password (see [Password] (page 123)).
- When you play discs which do not have the Parental Control function, playback cannot be limited on this unit.
- Depending on the disc, you may be asked to change the Parental Control level while playing the disc. In this case, enter your password, then change the level.
- When [255] is selected in [Select Age Restriction], the Parental Control setting is canceled.

Tip

- You can change the password. See [Password] (page 123).

■ [DVD Parental Control]

Playback of some DVD VIDEOS can be limited according to a predetermined level such as the age of the users. Scenes may be blocked or replaced with different scenes.

- 1 Enter your four-digit password using the number buttons.**
- 2 Press \uparrow/\downarrow to select [OK], then press \oplus .**
- 3 Press \uparrow/\downarrow to select a level, then press \oplus .**

The lower the value, the stricter the limitation.

To cancel the Parental Control setting
Select [No Restrictions].

Note

- If you forget the password, reset the system (page 129) and set a new password (see [Password] (page 123)).
- When you play discs which do not have the Parental Control function, playback cannot be limited on this unit.
- Depending on the disc, you may be asked to change the Parental Control level while playing the disc. In this case, enter your password, then change the level.

Tip

- You can change the password. See [Password] (page 123).

■ [Parental Control Region Code]

Playback of some BD-ROMs or DVD VIDEOS can be limited according to the geographic area. Scenes may be blocked or replaced with different scenes.

- 1 Enter your four-digit password using the number buttons.**
- 2 Press \uparrow/\downarrow to select [OK], then press \oplus .**
- 3 Press \uparrow/\downarrow to select the area restriction, then press \oplus .**

When you select [Select Region Code], the display for entering the region code appears. Enter the code for the area restriction by referring to “Parental Control/ Area Code List” (page 149).

Note

- If you forget the password, reset the system (page 129) and set a new password (see [Password] (page 123)).
- When you play discs which do not have the Parental Control function, playback cannot be limited on this unit.
- Depending on the disc, you may be asked to change the Parental Control level while playing the disc. In this case, enter your password, then change the level.

Tip

- You can change the password. See [Password] (page 123).

■ [Password]

You can set or change the password for the Parental Control function. A password allows you to set a restriction on BD-ROM or DVD VIDEO playback. If necessary, you can differentiate the restriction levels for BD-ROMs and DVD VIDEOS.

- 1 Enter your four-digit password using the number buttons.**
- 2 Press \uparrow/\downarrow to select [OK], then press \oplus .**

To change the password

- 1 After Step 1, enter your four-digit password using the number buttons.**
- 2 Press \uparrow/\downarrow to select [OK], then press \oplus .**
- 3 Enter a new password using the number buttons.**
- 4 Press \uparrow/\downarrow to select [OK], then press \oplus .**

■ [Hybrid Disc Playback Layer]

You can select the layer priority when playing a Hybrid Disc. To change the setting, turn the system off and on again.

[BD]: Plays BD layer.

[DVD/CD]: Plays DVD or CD layer.

■ [BD Internet Connection]

You can set whether to allow Internet connections from the contents of a BD (in BDMV mode) being played. Network connections and settings are required when using this function (page 127).

 **[Photo Settings]**

You can make the photo-related settings.

■ [Slideshow Speed]

You can change the slideshow speed.

[Fast]: Photos change rapidly.

[Normal]: Photos change at normal speed.

[Slow]: Photos change slowly.

 **[HDMI Settings]**

You can make the HDMI settings.

■ [Control for HDMI]

You can set the [Control for HDMI] function to on/off. This function is available when you connect the system and TV with an HDMI cable. For details, see “Using the Control for HDMI Function for “BRAVIA” Sync” (page 105).

[On]: On. You can operate mutually between components that are connected with an HDMI cable.

[Off]: Off.

Note

- This function is available only when you connect the unit and TV with the HDMI cable.
-

■ [Volume Limit]

If you change the output method of the TV to the system speaker on the TV menu or by pressing THEATRE, the System Audio Control (page 107) is activated and loud sound may be output depending on the volume level of the system. You can prevent this by limiting the maximum level of the volume.

[Level3]: Maximum volume level is set to 15.

[Level2]: Maximum volume level is set to 20.

[Level1]: Maximum volume level is set to 30.

[Off]: Off.

Note

- This function is available only when you connect the unit and TV with the HDMI cable and [Control for HDMI] is set to [On].

■ [BD-ROM 1080/24p Output]

You can set to output 1920 × 1080p/24 Hz video signals when playing film-based materials on BD-ROMs (720p/24 Hz or 1080p/24 Hz). 1920 × 1080p/24 Hz video signals can be output when all of the following conditions are met.

- You connect a 1080/24p-compatible TV using the HDMI OUT jack,
- [Output Video Format] is set to [HDMI], and
- [HDMI Resolution] is set to [Auto] or [1080p].

The 24P indicator lights up when outputting 1920 × 1080p/24 Hz video signals.

[Auto]: Outputs 1920 × 1080p/24 Hz video signals only when connecting a 1080/24p-compatible TV using the HDMI OUT jack.

[On]: Outputs 1920 × 1080p/24 Hz video signals regardless of the connected TV type.

[Off]: Select this when your TV is not compatible with 1080/24p video signals.

Note

- Video signals may not be output when [BD-ROM 1080/24p Output] is set to [On].
-

■ [YCbCr/RGB]

You can set the color setting for video signals output from the HDMI OUT jack. Select the setting that matches the connected TV type.

[Auto]: Automatically detects the type of external device, and switches to the matching color setting.

[YCbCr (4:2:2)]: Outputs YCbCr 4:2:2 video signals.

[YCbCr (4:4:4)]: Outputs YCbCr 4:4:4 video signals.

[RGB (16-235)]: Select this when connecting to a device with an HDCP-compliant DVI jack.

[RGB (0-255)]: Select this when connecting to an RGB (0-255) device.

■ [x.v.Colour Output]

Sets whether to send xvYCC information to the connected TV.

Combining xvYCC-compatible video with a TV that supports x.v.Colour display makes it possible to more accurately reproduce object colors present in the natural world.

[Auto]: Normally select this.

[Off]: Select this when the picture is unstable or colors appear unnatural.

■ [Audio (HDMI)]

You can set the output type for the audio signal from the HDMI OUT jack.

[AMP]: HDMI audio signals are output to the system speakers only. The multi-channel sound can be played back as it is.

[TV+AMP]: HDMI audio signals are output from the TV's speaker and the system's speakers.

Note

- If you set to [TV+AMP], the sound quality of the system depends on the TV's sound quality, such as the number of channels, the sampling frequency, etc. When the TV has stereo speakers, the sound output from the system's speakers is also stereo as that of the TV, even if you play multi-channel source.
- When you connect the system to a video component (projector, etc.), sound may not be output from the system. In this case, select [AMP].
- When the System Audio Control function (page 107) is activated, this setting may change automatically.



[System Settings]

You can make the system-related settings.

■ [OSD]

You can select your language for the system on-screen displays.

■ [Dimmer]

You can adjust the lighting of the front panel display.

[Bright]: Bright lighting.

[Dark]: Low lighting.

■ [Standby Mode]

You can shorten the startup time when turning the system on.

[Quick Start]: Shortens the startup time from standby mode. You can operate the system quickly after turning it on.

[Normal]: The default setting.

Note

- When [Standby Mode] is set to [Quick Start],
 - power consumption will be higher than when [Standby Mode] is set to [Normal].
 - the ventilation fan may turn on depending on the surrounding temperature.

■ [Auto Display]

You can display information when switching audio modes or during playback.

[On]: Automatically displays information on the screen when changing the viewing titles, picture modes, audio signals, etc.

[Off]: Displays information only when you press  DISPLAY.

■ [Screen Saver]

The screen saver image appears when you do not use the system for more than 15 minutes while an on-screen display, such as the home menu, is displayed on your TV screen. The screen saver image helps prevent your display device from becoming damaged (ghosting).

[On]: Turns on the screen saver function.

[Off]: Off.

■ [S-AIR ID]

You can set the S-AIR ID of the system. For details, see “Establishing sound transmission between the unit and S-AIR sub unit (ID setting)” (page 99).

■ [S-AIR Pairing]

You can pair the system and S-AIR sub unit, such as surround amplifier or S-AIR receiver. For details, see “Identifying the unit with a specific S-AIR sub unit (Pairing operation)” (page 102).

■ [S-AIR Standby]

You can enjoy the S-AIR receiver while the unit is in standby mode. For details, see “Enjoying the S-AIR receiver while the unit is in standby mode” (page 102).

■ [S-AIR RF Change]

You can improve the S-AIR transmission by changing the setting. For details, see “If sound transmission is unstable” (page 104).

■ [Software Update Notification]

You can get information of newer software version. The information appears on the TV screen when you turn the system on. Network connections and settings are required when using this function (page 127).

[On]: Sets the system to inform you of newer software version information (page 118).

[Off]: Off.

■ [System Information]

You can display the system’s software version information and the MAC address.



[Network Settings]

You can make detailed settings for Internet and network.

■ [Internet Settings]

These items are necessary when you connect to the Internet via a network cable. Enter the respective (alphanumeric) values for your broadband router or Wireless LAN router. The items that need to be set may differ, depending on the Internet service provider or the router. For details, refer to the instruction manuals that have been provided by your Internet service provider or supplied with the router.

- 1 Press **↑/↓** to select [IP Address Acquisition], then press **+**.
- 2 Press **↑/↓** to select an item, then press **+**.

[Use DHCP]: Select this when DHCP (Dynamic Host Configuration Protocol) server settings are available from your Internet service provider. The network settings necessary for the system will be assigned automatically.

If you set [DNS Server Auto Acquisition] to [Off], set the following item:

- [DNS Server (Primary)]
- [DNS Server (Secondary)]

[Use Static IP Address]: Set the IP address manually according to your network environment.

Set the following items:

- [IP Address]
- [Subnet Mask]
- [Default Gateway]
- [DNS Server (Primary)]
- [DNS Server (Secondary)]

Note

- When you set the [DNS Server (Primary)]/[DNS Server (Secondary)] addresses manually, enter the [DNS Server (Secondary)] address. Otherwise, the [Internet Settings] will be set incorrectly.

- 3 If your ISP has a specific proxy server setting, press **↑/↓** to select [Proxy Settings], then press **+**.

The [Proxy Settings] display appears.

If the proxy server does not have a specific setting, go to step 8.

- 4 Press **↑/↓** to select [Use of Proxy Server], then press **+**.
- 5 Press **↑/↓** to select [On], then press **+**.
- 6 Select [Proxy Server] and [Port], and enter the settings.
To enter the proxy server, see “To enter characters” (page 127).
- 7 Press RETURN.
- 8 Press **↑/↓** to select [Network Diagnostic], then press **+**.
- 9 Press **←/→** to select [Start], then press **+**.
- 10 Check that the message [Network connections are correct.] appears.
The setup is finished. If the message does not appear, follow the on-screen messages.

To enter characters

The display for entering characters appears when you select [Proxy Server] in [Proxy Settings].

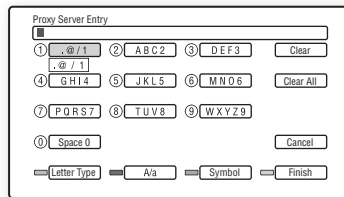

- 1 Press the number button repeatedly to select a character.
Example:
Press the number 3 button once to enter [D].
Press the number 3 button three times to enter [F].
- 2 Press **→**, and enter the next character.
- 3 Press the blue button ([Finish]) to finish.

You can use the following buttons to enter characters.

Buttons	Details
Red button [Letter Type]	Switches the keyboard between alphabet and numbers.
Green button [A/a]	Switches the keyboard between upper case and lower case.
Yellow button [Symbol]	Displays the keyboard for symbols.
Blue button [Finish]	The input is entered, and the system returns to the previous display.
CLEAR [Clear]/[Clear All]	Erases the character to the right of the cursor. To erase all displayed characters, press and hold CLEAR for 2 seconds or more.
RETURN [Cancel]	Returns to the previous display, canceling the input.
←/↑/↓/→, ⊕	<ul style="list-style-type: none">• Select an input function using ←/↑/↓/→, and press ⊕.• Enter characters as follows: ① Select a character selection panel using ←/↑/↓/→, and press ⊕. ② Select a character using ←/→, and press ⊕.

[Easy Setup]

You can recall the Easy Setup to make the basic settings.

- 1** Press ←/→ to select [Start], then press ⊕.
- 2** Follow the instructions for “Step 5: Performing the Easy Setup” (page 69) from step 4.

[Resetting]

You can reset the system settings to the factory default by selecting the group of settings. All the settings within the group will be reset.

- 1** Press \oplus to select [Reset to Factory Default Settings], then press \oplus .
- 2** Press \uparrow/\downarrow to select the settings you want to reset to default, then press \oplus .

You can reset the following settings:

- [Video Settings]
- [Audio Settings]
- [BD/DVD Viewing Settings]
- [Photo Settings]
- [HDMI Settings]
- [System Settings]
- [Network Settings]
- [All Settings]

The display asks for confirmation.

- 3** Press \leftarrow/\rightarrow to select [Start], then press \oplus .

To cancel, select [Cancel].

Note

- When [All Settings] is selected in Step 2, all system settings are reset, and the system turns off.

Precautions

On safety

- To prevent fire or shock hazard, do not place objects filled with liquids, such as vases, on the unit, or place the unit near water, such as near a bathtub or shower room. Should any solid object or liquid fall into the cabinet, unplug the unit and have it checked by qualified personnel before operating it any further.
- Do not touch the AC power cord (mains lead) with wet hands. Doing so may cause an electric shock.

WARNING

To prevent injury, this apparatus must be securely attached to the floor/wall in accordance with the installation instructions.

On power sources

- Unplug the unit from the wall outlet (mains) if you do not intend to use it for an extended period of time. To disconnect the cord, pull it out by the plug, never by the cord.

On placement

- Place the system in a location with adequate ventilation to prevent heat build-up in the system.
- At high volume, over long periods of time, the cabinet becomes hot to touch. This is not a malfunction. However, touching the cabinet should be avoided. Do not place the unit in a confined space where ventilation is poor as this may cause overheating.
- Do not block the ventilation slots by putting anything on the system. The system is equipped with a high power amplifier. If the ventilation slots are blocked, the unit can overheat and malfunction.
- Do not place the unit on surfaces (rugs, blankets, etc.) or near materials (curtains, draperies) that may block the ventilation slots.
- Do not install the unit in a confined space, such as a bookshelf or similar unit.
- Do not install the unit near heat sources such as radiators, air ducts, or in a place subject to direct sunlight, excessive dust, mechanical vibration, or shock.
- Do not install the unit in an inclined position. It is designed to be operated in a horizontal position only.
- Keep the unit and discs away from components with strong magnets, such as microwave ovens, or large loudspeakers.

- Do not place heavy objects on the unit.

On operation

- If the system is brought directly from a cold to a warm location, or is placed in a very damp room, moisture may condense on the lenses inside the control unit. Should this occur, the system may not operate properly. In this case, remove the disc and leave the system turned on for about half an hour until the moisture evaporates.
- When you move the system, take out any disc. If you don't, the disc may be damaged.
- If anything falls into the cabinet, unplug the unit and have it checked by qualified personnel before operating it any further.

On adjusting volume

- Do not turn up the volume while listening to a section with very low level inputs or no audio signals. If you do, the speakers may be damaged when a peak level section is suddenly played.

On cleaning

- Clean the cabinet, panel, and controls with a soft cloth slightly moistened with a mild detergent solution. Do not use any type of abrasive pad, scouring powder or solvent such as alcohol or benzine. If you have any questions or problems concerning your system, please consult your nearest Sony dealer.

On cleaning discs, disc/lens cleaners

- **Do not use cleaning discs or disc/lens cleaners (including wet or spray types). These may cause the apparatus to malfunction.**

On replacement of parts

- In the events that this unit is repaired, repaired parts may be collected for reuse or recycling purposes.

On your TV's color

- If the speakers should cause the TV screen to have color irregularity, turn off the TV then turn it on after 15 to 30 minutes. If color irregularity should persist, place the speakers further away from the TV set.

IMPORTANT NOTICE

Caution: This system is capable of holding a still video image or on-screen display image on your television screen indefinitely. If you leave the still video image or on-screen display image displayed on your TV for an extended period of time you risk permanent damage to your television screen. Projection televisions are especially susceptible to this.

On moving the system

Before moving the system, make sure that there is no disc inserted, and remove the AC power cord (mains lead) from the wall outlet (mains).

About S-AIR function

- As the S-AIR function transmits sound by radio waves, sound may skip when radio waves are obstructed. This is a characteristic of radio waves and is not malfunction.
- As the S-AIR function transmits sound by radio waves, equipment that generates electromagnetic energy, such as a microwave oven, may interfere with sound transmission.
- As the S-AIR function uses the radio waves that share the same frequency as other wireless systems, such as wireless LAN or Bluetooth, interference or poor transmission may result. In this case, take the following steps:
 - Do not install the system near other wireless systems.
 - Do not use the system and the other wireless systems at the same time.
- The transmission distance differs depending on the usage environment. Find a location where transmission between the S-AIR main unit and sub unit is most effective, and install the S-AIR main unit and sub unit there.

About the surround amplifier

- The nameplate is located on the side exterior.

Notes about the Discs

On handling discs

- To keep the disc clean, handle the disc by its edge. Do not touch the surface.
- Do not stick paper or tape on the disc.



- Do not expose the disc to direct sunlight or heat sources such as hot air ducts, or leave it in a car parked in direct sunlight as the temperature may rise considerably inside the car.
- After playing, store the disc in its case.

On cleaning

- Before playing, clean the disc with a cleaning cloth. Wipe the disc from the center out.



- Do not use solvents such as benzine, thinner, commercially available cleaners, or anti-static spray intended for vinyl LPs.

This system can only play back a standard circular disc. Using neither standard nor circular discs (e.g., card, heart, or star shape) may cause a malfunction.

Do not use a disc that has a commercially available accessory attached, such as a label or ring.

Troubleshooting

If you experience any of the following difficulties while using the system, use this troubleshooting guide to help remedy the problem before requesting repairs. Should any problem persist, consult your nearest Sony dealer.



Note that if service personnel changes some parts during repair, these parts may be retained.

In the event of a problem with the S-AIR function, have a Sony dealer check the entire system together (S-AIR main unit and sub unit).





Power

Symptom	Remedy
The power is not turned on.	<ul style="list-style-type: none">• Check that the AC power cord (mains lead) is connected securely.• Press I/⏻ after “STANDBY” disappears from the front panel display.
If “PROTECTOR” and “PUSH POWER” appear alternately in the front panel display.	<p>Press I/⏻ to turn off the system, and check the following items after “STANDBY” disappears.</p> <ul style="list-style-type: none">• Are the + and – speaker cords short-circuited?• Are you using only the specified speakers?• Is anything blocking the ventilation holes of the system?• After checking the above items and fixing any problems, turn on the system. If the cause of the problem cannot be found even after checking all the above items, consult your nearest Sony dealer.

Picture

Symptom	Remedy
There is no picture.	<ul style="list-style-type: none"> • The video connecting cords are not connected securely. • The video connecting cords are damaged. • The unit is not connected to the correct TV input jack (page 57). • The video input on the TV is not set so that you can view pictures from the system. • Check the output method on your system (page 57). • Re-connect the connecting cord securely. • The unit is connected to an input device that is not HDCP (High-bandwidth Digital Content Protection) compliant (“HDMI” on the front panel does not light up) (page 57). • When playing a double-layer DVD, the video and audio may be momentarily interrupted at the point where the layers switch.
No picture appears when the video output resolution selected in [Output Video Format] is incorrect.	<ul style="list-style-type: none"> • Press and hold  and  on the unit for more than 5 seconds to reset the video output resolution to the lowest resolution.
Video signals are not output from the jacks, other than from the HDMI OUT jack, when connecting the HDMI OUT jack and other video output jacks at the same time.	<ul style="list-style-type: none"> • Set [Output Video Format] to [Component Video] in [Video Settings] (page 119).
The dark area of the picture is too dark/the bright area is too bright or unnatural.	<ul style="list-style-type: none"> • Set [Picture Quality Mode] to [Standard] (default) (page 81).
The picture is not output correctly.	<ul style="list-style-type: none"> • Check the [Output Video Format] settings in [Video Settings] (page 119).
Picture noise appears.	<ul style="list-style-type: none"> • The disc is dirty or flawed. • If the picture output from your system goes through your VCR to get to your TV, the copy-protection signal applied to some BD/DVD programs could affect picture quality. If you still experience problems even when you connect your unit directly to your TV, try connecting your unit to the other input jacks (page 57).
Even though you set the aspect ratio in [TV Type] of [Video Settings], the picture does not fill the TV screen.	<ul style="list-style-type: none"> • The aspect ratio on the disc is fixed.
Color irregularity occurs on the TV screen.	<ul style="list-style-type: none"> • If the speakers are used with a CRT-based TV or projector, install the speakers at least 0.3 meters (1.0 ft) from the TV set. • If the color irregularity persists, turn off the TV set once, then turn it on after 15 to 30 minutes. • If howling occurs, reposition the speakers farther away from the TV set. • Make sure that no magnetic object (magnetic latch on a TV stand, health care device, toy, etc.) is placed near the speakers.

Sound

Symptom	Remedy
There is no sound.	<ul style="list-style-type: none"> • The speaker cord is not connected securely. • Press  on the remote if “MUTING ON” is displayed in the front panel display. • The system is in pause mode. Press  to return to normal play mode. • Fast forward or fast reverse is performed. Press  to return to normal play mode. • Check the speaker settings (page 110).
No sound is output from the HDMI OUT jack.	<ul style="list-style-type: none"> • The HDMI OUT jack is connected to a DVI (Digital Visual Interface) device (DVI (Digital Visual Interface) jacks do not accept audio signals). • Try the following: ① Turn the system off and on again. ② Turn the connected component off and on again. ③ Disconnect and then connect the HDMI cable again. • Set [Audio (HDMI)] in [HDMI Settings] to [TV+AMP] (page 125).
The Super Audio CD sound of a component that is connected to the HDMI1 or HDMI2 jack is not output.	<ul style="list-style-type: none"> • HDMI1 and HDMI2 does not accept an audio format that contains copy protection (page 143). Connect the analog audio output of the component to the SAT/CABLE IN (AUDIO R/L) or TV (AUDIO IN R/L) jacks of the unit.
The left and right sounds are unbalanced or reversed.	<ul style="list-style-type: none"> • Check that the speakers and components are connected correctly and securely.
There is no sound from the subwoofer.	<ul style="list-style-type: none"> • Check the speaker connections and settings (pages 54, 110). • Select “A.F.D. STD” for the decoding mode (page 86).
Severe hum or noise is heard.	<ul style="list-style-type: none"> • Check that the speakers and components are connected securely. • Check that the connecting cords are away from a transformer or motor, and at least 3 meters (10 ft) away from your TV set or a fluorescent light. • Move your TV away from the audio components. • The plugs and jacks are dirty. Wipe them with a cloth slightly moistened with alcohol. • Clean the disc.
The sound loses stereo effect when you play a CD.	<ul style="list-style-type: none"> • Select stereo sound by pressing  (page 90). • Make sure the unit is connected properly.
The surround effect is difficult to hear when you are playing a sound track of Dolby Digital, DTS, or MPEG audio.	<ul style="list-style-type: none"> • Make sure the decoding mode setting (page 86). • Check the speaker connections and settings (pages 54, 110). • Depending on the BD/DVD, the output signal may not be the entire 5.1 channel. It may be monaural or stereo even if the sound track is recorded in Dolby Digital or MPEG audio format.
The sound comes from the center speaker only.	<ul style="list-style-type: none"> • Depending on the disc, the sound may come from the center speaker only.
No sound is heard from the center speaker.	<ul style="list-style-type: none"> • Check the speaker connections and settings (pages 54, 110). • Make sure the decoding mode setting (page 86). • Depending on the source, the effect of the center speaker may be less noticeable. • A 2 channel source is being played.
No sound or only a very low-level sound is heard from the surround speakers.	<ul style="list-style-type: none"> • Check the speaker connections and settings (pages 54, 110). • Make sure the decoding mode setting (page 86). • Depending on the source, the effect of the surround speakers may be less noticeable. • Check the wireless setting (page 67). • A 2 channel source is being played.

Symptom	Remedy
The beginning of the sound is cut off.	<ul style="list-style-type: none"> • Set the sound mode to “MOVIE” or “MUSIC” (page 89). • Select “A.F.D. STD” for the decoding mode (page 86).

Operation

Symptom	Remedy
Radio stations cannot be tuned in.	<ul style="list-style-type: none"> • Check that the antenna (aerial) is connected securely. Adjust the antenna (aerial) or connect an external antenna (aerial) if necessary. • The signal strength of the stations is too weak (when tuning in with automatic tuning). Use direct tuning. • No stations have been preset or the preset stations have been cleared (when tuning by scanning preset stations). Preset the stations (page 92). • Press DISPLAY so that the frequency appears in the front panel display.
Noise is heard on AM radio.	<ul style="list-style-type: none"> • Check the location of the AM loop antenna (aerial) and cord (page 62).
The remote does not function.	<ul style="list-style-type: none"> • There are obstacles between the remote and the unit. • The distance between the remote and the unit is too far. • The remote is not pointed at the remote sensor on the unit. • The batteries in the remote are weak.
The disc does not play.	<ul style="list-style-type: none"> • The disc is dirty. • There is no disc inserted. • The disc is upside down. Insert the disc with the playback side facing down. • The disc is skewed on the disc tray. • You are attempting to play a disc with a format that cannot be played back by this system (page 140). • The region code on the BD/DVD does not match the system. • Moisture has condensed inside the unit and may cause damage to the lenses. Remove the disc and leave the unit turned on for about half an hour. • The system cannot play a recorded disc that is not correctly finalized (page 140).
The JPEG image file cannot be played.	<ul style="list-style-type: none"> • The following photo files cannot be played. <ul style="list-style-type: none"> – Photo files larger than 8,192 pixels (width or height) – Photo files smaller than 15 pixels (width or height) – Photo files exceeding 32 MB – Photo files with extreme aspect ratios (greater than 50:1 or 1:50) – Photo files in Progressive JPEG format – Photo files that have a “.jpeg” or “.jpg” extension, but not in JPEG format – Photo files that have an extremely long name – Photo files recorded on BD-Rs in any format other than UDF (Universal Disk Format) 2.6 – Photo files recorded on BD-REs in any format other than UDF (Universal Disk Format) 2.5 • Photo files edited on a PC may not be played. • It does not fit the TV screen.
The file name are not displayed correctly.	<ul style="list-style-type: none"> • The system can only display ISO 8859-1-compliant character formats. Other character formats may be displayed differently. • Depending on the writing software used, the input characters may be displayed differently.

Symptom	Remedy
A disc does not start playing from the beginning.	<ul style="list-style-type: none"> • Resume Play has been selected. Press OPTIONS and select [Play from start], then press ⊕. • The title or BD/DVD menu automatically appears on the TV screen.
The system starts playing the disc automatically.	<ul style="list-style-type: none"> • The BD/DVD features an auto playback function.
Playback stops automatically.	<ul style="list-style-type: none"> • Some discs may contain an auto pause signal. While playing such a disc, the system stops playback at the auto pause signal.
You cannot perform some functions such as stop or search.	<ul style="list-style-type: none"> • Depending on the disc, you may not be able to perform some of the operations above. Refer to the operating instructions supplied with the disc.
Messages do not appear on the TV screen in the language you want.	<ul style="list-style-type: none"> • In the Setup Display, select the desired language for the on-screen display in [OSD] in [System Settings] (page 126).
The language for the soundtrack/subtitle or angles cannot be changed.	<ul style="list-style-type: none"> • Try using the BD's or DVD's menu instead of the direct selection button on the remote (page 78). • Multi-lingual tracks/subtitles or multi-angles are not recorded on the BD or DVD being played. • The BD or DVD prohibits the changing of the language for the sound track/subtitle or angles.
The disc tray does not open and you cannot remove the disc even after you press ⏏ .	<ul style="list-style-type: none"> • Try the following: ① Press and hold VOLUME – and ⏏ on the unit for more than 5 seconds to open the disc tray. ② Remove the disc. ③ Disconnect the AC power cord (mains lead) from the wall outlet (mains), then reconnect after several minutes.
A disc cannot be ejected and "LOCKED" appears in the front panel display.	<ul style="list-style-type: none"> • Contact your Sony dealer or local authorized Sony service facility.
The system does not work normally.	<ul style="list-style-type: none"> • Disconnect the AC power cord (mains lead) from the wall outlet (mains), then reconnect after several minutes.
The Control for HDMI function does not work.	<ul style="list-style-type: none"> • When "HDMI" does not light up in the front panel display, check the HDMI connection (page 57). • Set [Control for HDMI] in [HDMI Settings] to [On] (page 124). • Make sure that the connected component is compatible with the [Control for HDMI] function. • Check that the AC power cord (mains lead) of the connected component is connected securely. • Check the connected component's setting for the Control for HDMI function. Refer to the operating instructions supplied with the component. • If you change the HDMI connection, connect and disconnect the AC power cord (mains lead), or have a power failure, set [Control for HDMI] in [HDMI Settings] to [Off], then set [Control for HDMI] in [HDMI Settings] to [On] (page 124). • For details, see "Using the Control for HDMI Function for "BRAVIA" Sync" (page 105).
No sound is output from the system and TV while using the System Audio Control function.	<ul style="list-style-type: none"> • Make sure that the connected TV is compatible with the System Audio Control function. • For details, see "Using the Control for HDMI Function for "BRAVIA" Sync" (page 105).
The external memory is not recognized.	<ul style="list-style-type: none"> • Try the following: ① Turn the system off. ② Align the ▼ mark of the EXTERNAL slot with the ▼ mark on the external memory, and insert the external memory (page 64). ③ Turn the system on. ④ Check that the EXTERNAL indicator lights up in the front panel display.

Symptom	Remedy
Bonus contents or other data that are contained in a BD-ROM cannot be played.	<ul style="list-style-type: none"> • Try the following: ① Remove the disc. ② Turn the system off. ③ Remove and re-insert the external memory (page 64). ④ Turn the system on. ⑤ Check that the EXTERNAL indicator lights up in the front panel display. ⑥ Insert the BD-ROM with BonusView/BD-Live.
A message indicating that the local storage does not have enough space appears on the screen.	<ul style="list-style-type: none"> • Delete unnecessary data in the external memory (page 78).
The unit does not work and “CHILD LOCK” appears in the front panel display when you press any button on the unit.	<ul style="list-style-type: none"> • Set the child lock function to off (page 116).

The S-AIR function

Symptom	Remedy
<p>S-AIR connection is not established (sound transmission is not established), e.g., the indicator of the S-AIR sub unit does the following:</p> <ul style="list-style-type: none"> • Turns off. • Flashes. • Turns red. 	<ul style="list-style-type: none"> • If you use another S-AIR main unit, place it more than 8 m away from the unit. • Confirm the ID of the unit and S-AIR sub unit (page 99). • You performed pairing the unit and another S-AIR sub unit. Perform pairing of the desired S-AIR sub unit (page 102). • The unit is paired to another S-AIR sub unit. To cancel pairing, reset the ID of the unit and S-AIR sub unit (page 99). • Install the S-AIR main unit and S-AIR sub unit away from other wireless products. • Stop using another wireless product. • The S-AIR sub unit is turned off. Make sure the AC power cord (mains lead) is connected and turn on the S-AIR sub unit.
No sound is heard from the S-AIR sub unit.	<ul style="list-style-type: none"> • If you use another S-AIR main unit, place it more than 8 m away from the unit. • Confirm the ID of the unit and S-AIR sub unit (page 99). • Confirm the pairing setting (page 102). • Install the S-AIR main unit and S-AIR sub unit closer together. • Avoid use of equipment that generates electromagnetic energy, such as a microwave oven. • Install the S-AIR main unit and S-AIR sub unit away from other wireless products. • Stop using another wireless product. • Change the [S-AIR RF Change] setting (page 104). • Change the ID settings of the S-AIR main unit and S-AIR sub unit. • Turn off the system and S-AIR sub unit, then turn on them.
There is noise or the sound skips.	<ul style="list-style-type: none"> • If you use another S-AIR main unit, place it more than 8 m away from the unit. • Install the S-AIR main unit and S-AIR sub unit closer together. • Avoid use of equipment that generates electromagnetic energy, such as a microwave oven. • Install the S-AIR main unit and S-AIR sub unit away from other wireless products. • Stop using another wireless product. • Change the [S-AIR RF Change] setting (page 104). • Change the ID settings of the S-AIR main unit and S-AIR sub unit.

Surround amplifier operation

If no sound is output from the surround speakers, check the status of the POWER / ON LINE indicator on the surround amplifier. For details of the POWER / ON LINE indicator, see “Step 4: Setting up the Wireless System” (page 67).

Symptom	Remedy
The power is not turned on.	<ul style="list-style-type: none">• Check that the AC power cord (mains lead) is connected securely.
The POWER / ON LINE indicator does not turn on.	<p>Turn off the surround amplifier and remove the AC power cord (mains lead) of the surround amplifier, then check the following items.</p> <ul style="list-style-type: none">• Are the + and – speaker cords short-circuited?• Is anything blocking the ventilation holes of the surround amplifier?• After checking the above items and fixing any problems, connect the AC power cord (mains lead) of the surround amplifier and turn on the surround amplifier. If the cause of the problem cannot be found even after checking all the above items, consult your nearest Sony dealer.
There is no sound. Check the status of the POWER / ON LINE indicator on the surround amplifier.	<ul style="list-style-type: none">• turns green<ul style="list-style-type: none">– Check the speaker connections and settings.– The volume of the unit is set to minimum.– The unit is in muting status.– Depending on the source or the settings of the unit, the effect of the speakers may be less noticeable.– Headphones are connected.• flashes green<ul style="list-style-type: none">– The unit is not turned on.– You performed pairing the unit and another S-AIR sub unit.– The surround amplifier is paired to another S-AIR main unit.– Confirm the IDs of the unit and surround amplifier (page 99).– Pairing operation is not completed.– Sound transmission is poor. Move the surround amplifier so that the POWER / ON LINE indicator turns green.– Install the unit and surround amplifier apart from another wireless product.– Stop using another wireless product.– The wireless transceiver(s) is/are not inserted correctly.• turns red<ul style="list-style-type: none">– Change the SURROUND SELECTOR switch (SURROUND or SURROUND BACK) of the surround amplifier to match the unit.
“HP NO LINK” and “VOLUME MIN” appear alternately in the front panel display, and the volume of the unit becomes minimum.	<ul style="list-style-type: none">• Volume becomes the minimum when you turn off the surround amplifier with headphones connected before you turn off the unit or if radio reception is poor. In these cases, check radio reception, and set the volume again.

Self-diagnosis Function

When the self-diagnosis function is activated to prevent the system from malfunctioning, an error code appears in the front panel display, or just  appears without any messages on the entire screen. In these cases, check the following.

When an error code appears in the front panel display

Error code	Corrective action
Exxxx	Contact your nearest Sony dealer or local authorized Sony service facility and give the error code.
SYSTEM ERROR	Turn off the system, then turn it on. If the system does not work normally, consult your nearest Sony dealer or local authorized Sony service facility.

When just appears without any messages on the entire screen

Contact your nearest Sony dealer or local authorized Sony service facility.

Playable Discs

Type	Disc logo	Characteristics	Icon
Blu-ray Disc		BD-ROMs and BD-REs/BD-Rs in BDMV and BDAV mode, including 8 cm discs (single layer) and DL discs	
DVD VIDEO		Discs such as movies that can be purchased or rented	
DVD/DATA DVD	    	DVD+RWs/DVD+Rs in +VR mode or DVD-RWs/DVD-Rs in video and VR mode, including 8 cm discs (single layer) and DVD+R DL/DVD-R DL discs DVD+RWs/DVD+Rs/DVD-RWs/DVD-Rs containing JPEG* image files	 
CD		Music CDs or CD-Rs/CD-RWs in music CD format	
DATA CD	–	CD-Rs/CD-RWs containing JPEG image files	

* JPEG format conforming to UDF (Universal Disk Format).

Notes about BD-ROM compatibility

Since the Blu-ray Disc specifications are new and evolving, some discs may not be playable depending on the disc type and the version.

The audio output differs depending on the source, connected output jack, and selected audio settings.

Discs that cannot be played

- BDs with cartridge
- DVD-RAMs
- HD DVDs
- DVD Audio discs
- PHOTO CDs
- Data part of CD-Extras
- VCDs/Super VCDs
- HD layer on Super Audio CDs
- BD-ROMs/DVD VIDEOS with a different region code (page 141)

Note on playback operations of a BD/DVD

Some playback operations of a BD/DVD may be intentionally set by software producers. Since this system plays a BD/DVD according to the disc contents the software producers designed, some playback features may not be available. Refer to the instructions supplied with the BD/DVD.

Region code (BD-ROM/DVD VIDEO only)

Your system has a region code printed on the rear of the unit and will only play a BD-ROM/DVD VIDEO (playback only) labeled with identical region codes. This system is used to protect copyrights. DVD VIDEO labeled  will also play on this system.

If you try to play any other DVD VIDEO, the message [Playback prohibited by region code.] will appear on the TV screen. Depending on the BD-ROM/DVD VIDEO, no region code may be indicated even though playing the BD-ROM/DVD VIDEO is prohibited by area restrictions.

Notes about BD-REs/BD-Rs, DVD+RWs/DVD+Rs, DVD-RWs/DVD-Rs, or CD-Rs/CD-RWs

Some BD-REs/BD-Rs, DVD+RWs/DVD+Rs, DVD-RWs/DVD-Rs, or CD-Rs/CD-RWs cannot be played on this system due to the recording quality or physical condition of the disc, or the characteristics of the recording device and authoring software.

A DVD disc will not play if it has not been correctly finalized. For more information, refer to the operating instructions supplied with the recording device. Note that some playback functions may not work with some DVD+RWs/DVD+Rs, even if they have been correctly finalized. In this case, view the disc using normal playback.

Music discs encoded with copyright protection technologies

This product is designed to play back discs that conform to the Compact Disc (CD) standard. Various music discs encoded with copyright protection technologies are being marketed by some record companies. Please be aware that among those discs, there are some that do not conform to the CD standard and may not be playable by this product.

Note on DualDiscs

A DualDisc is a two sided disc product which mates DVD recorded material on one side with digital audio material on the other side. However, since the audio material side does not conform to the Compact Disc (CD) standard, playback on this product is not guaranteed.

Note about double-layer DVDs

The playback pictures and sound may be momentarily interrupted when the layers switch.

Note about 8 cm BD-REs/8 cm BD-Rs

Some 8 cm BD-REs/8 cm BD-Rs cannot be played on this system.

Note about BD-REs/BD-Rs

This system supports Ver. 2.1 BD-RE and Ver. 1.1 and 1.2 BD-R including organic pigment type BD-R (LTH type).

About playback of discs recorded in AVCHD format

This system can play AVCHD format discs.



What is the AVCHD format?

The AVCHD format is a high-definition digital video camera format used to record SD (standard definition) or HD (high definition) signals of either the 1080i specification* or the 720p specification** on DVDs, using efficient data compression coding technology. The MPEG-4 AVC/H.264 format is adopted to compress video data, and the Dolby Digital or Linear PCM system is used to compress audio data. The MPEG-4 AVC/H.264 format is capable of compressing images at higher efficiency than that of the conventional image compressing format. The MPEG-4 AVC/H.264 format enables a high definition (HD) video signal shot on a digital video camera recorder to be recorded on DVD discs, in the same way as it would be for a standard definition (SD) television signal.

* A high-definition specification which utilizes 1080 effective scanning lines and the interlace system.

** A high-definition specification which utilizes 720 effective scanning lines and the progressive system.

Note

- Some AVCHD format discs may not play, depending on the recording condition.
- The AVCHD format disc will not play if it has not been correctly finalized.

Supported Audio Formats

Audio formats supported by this system are as follows.

Function	Format							
	LPCM 2ch	LPCM 5.1ch, LPCM 7.1ch	Dolby Digital, Dolby Digital EX	Dolby Digital Plus	Dolby TrueHD	DTS, DTS-ES Discrete 6.1, DTS-ES Matrix 6.1, DTS96/24	DTS-HD High Resolution Audio	DTS-HD Master Audio
“BD/DVD”	○	○	○	○	○	○	○	○*
“HDMI1” “HDMI2”	○	○	○	○	○	○	○	○
“SAT/CABLE” “TV” (DIGITAL IN)	○	-	○	-	-	○	-	-

○: Supported format.

-: Unsupported format.

* When [Output Video Format] is set to [Video or S Video] (page 120), or [HDMI Resolution]/[Component Resolution] is set to [480i/576i] or [480p/576p] (page 120), the sound is DTS decoded.

Note

- The table above is valid only when you set [BD Audio Setting] to [Direct] (page 121) and [Fs Limit] to [Off] (page 121). If another setting is used, depending on the audio format, sound may be decoded to a suitable format automatically.
- HDMI1 and HDMI2 do not input sound in the case of an audio format that contains copy protections such as Super Audio CD or DVD-Audio.

Video Output Resolution

Output resolution differs depending on the [Output Video Format] setting in [Video Settings] (page 119).

Resolution setting	When [Output Video Format] is set to [HDMI]		
	VIDEO OUT (VIDEO, S VIDEO) jack	COMPONENT VIDEO OUT jack	HDMI OUT jack
480i/576i	480i/576i	480i/576i	480i/576i
480p/576p	480i/576i	480i/576i	480p/576p
720p	480i/576i	480i/576i	720p
1080i	480i/576i	480i/576i	1080i
1080p	no picture	no picture	1080p

Resolution setting	When [Output Video Format] is set to [Component Video]		
	VIDEO OUT (VIDEO, S VIDEO) jack	COMPONENT VIDEO OUT jacks	HDMI OUT jack
480i/576i	480i/576i	480i/576i	480i/576i
480p/576p	480i/576i	480p/576p	480p/576p
720p	480i/576i	720p*	720p*
1080i	480i/576i	1080i*	1080i*
1080p	unselectable	unselectable	unselectable

* Protected contents on DVDs are output at 480p/576p resolution.

When [Output Video Format] is set to [Video or S Video]

480i/576i video signals are output from the VIDEO OUT (VIDEO, S VIDEO) or COMPONENT VIDEO OUT jack, and 480p/576p video signals are output from the HDMI OUT jack.

Note

- The video input signal from the SAT/CABLE IN (VIDEO) jack or COMPONENT VIDEO IN (SAT/CABLE) jacks is not output from the VIDEO OUT (S VIDEO) jack.

About the video output resolution of a connected component

Function	Input jack	Resolution of the input video signal	Resolution of the output video signal	
			VIDEO OUT (VIDEO) jack	VIDEO OUT (S VIDEO) jack
"SAT/CABLE"	VIDEO IN jack	480i/576i	480i/576i	no picture
		480i/576i	no picture	no picture
	COMPONENT VIDEO IN jacks	480p/576p	no picture	no picture
		720p	no picture	no picture
		1080i	no picture	no picture
"DMPORT"*	DMPORT jack	480i/576i	480i/576i	no picture

Function	Input jack	Resolution of the input video signal	Resolution of the output video signal	
			COMPONENT VIDEO OUT jacks	HDMI OUT jack
"SAT/CABLE"	VIDEO IN jack	480i/576i	no picture	480p/576p
		480i/576i	480i/576i	480p/576p
	COMPONENT VIDEO IN jacks	480p/576p	480p/576p	480p/576p
		720p	720p	720p
		1080i	1080i	1080i
"DMPORT"*	DMPORT jack	480i/576i	no picture	480p/576p

* Available only when connecting a DIGITAL MEDIA PORT adapter that can output video signal.

Note

- You cannot change the video output resolution of a connected component.

Specifications

Amplifier Section (HCD-IT1000)

Power output (rated)	
Front L / Front R:	80 W + 80 W (at 3.5 ohms, 1 kHz, 1 % THD)
RMS output power (reference)	
Front L / Front R*:	100 W + 100 W (at 3.5 ohms, 1 kHz, 10 % THD)
Center*:	100 W (at 3.5 ohms, 1 kHz, 10 % THD)
Subwoofer*:	200 W (at 2 ohms, 100 Hz, 10 % THD)

* Depending on the decoding mode settings and the source, there may be no sound output.

Amplifier Section (HCD-IS1000)

Power output (rated)	
Front L / Front R:	35 W + 35 W (at 10 ohms, 1 kHz, 1 % THD)
RMS output power (reference)	
Front L / Front R*:	50 W + 50 W (at 10 ohms, 1 kHz, 10 % THD)
Center*:	50 W (at 10 ohms, 1 kHz, 10 % THD)
Subwoofer*:	100 W (at 4 ohms, 70 Hz, 10 % THD) + 100 W (at 4 ohms, 500 Hz, 10 % THD)

* Depending on the decoding mode settings and the source, there may be no sound output.

Inputs (Analog)	
TV, SAT/CABLE	Sensitivity: 450 mV (ATT ON), 250 mV (ATT OFF) Impedance: 50 kilohms
Inputs (Digital/COAXIAL)	
SAT/CABLE	Impedance: 75 ohms

Video Section

Outputs	VIDEO: 1 Vp-p 75 ohms S VIDEO: Y: 1 Vp-p 75 ohms C: 0.286 Vp-p 75 ohms COMPONENT: Y: 1 Vp-p 75 ohms
---------	--

Inputs	PB/CB, PR/CR: 0.7 Vp-p 75 ohms VIDEO: 1 Vp-p 75 ohms COMPONENT: Y: 1 Vp-p 75 ohms PB/CB, PR/CR: 0.7 Vp-p 75 ohms
--------	--

HDMI section

Connector	HDMI 19pin-standard connector
Video inputs	HDMI1, HDMI2: 640 × 480p@60 Hz 720 × 480i@59.94/60 Hz 720 × 480p@59.94/60 Hz 1280 × 720p@59.94/60 Hz 1920 × 1080i@59.94/60 Hz 1920 × 1080p@59.94/60 Hz 720 × 576i@50 Hz 720 × 576p@50 Hz 1280 × 720p@50 Hz 1920 × 1080i@50 Hz 1920 × 1080p@50 Hz 1920 × 1080p@24 Hz

BD/DVD/CD System

Laser	Semiconductor laser (BD: $\lambda = 405$ nm) (DVD: $\lambda = 650$ nm) (CD: $\lambda = 790$ nm) Emission duration: continuous
Signal format system	PAL/NTSC

Tuner Section

System	PLL quartz-locked digital synthesizer
FM tuner section	
Tuning range	87.5 MHz - 108.0 MHz (50 kHz step)
Antenna (aerial)	FM wire antenna (aerial)
Antenna (aerial) terminals	75 ohms, unbalanced
Intermediate frequency	10.7 MHz
AM tuner section	
Tuning range	531 - 1,602 kHz (9 kHz step)
Antenna (aerial)	AM loop antenna (aerial)
Intermediate frequency	450 kHz

Speakers (BDV-IT1000)**Front (SS-ITF1)**

Speaker system	2-way speaker system, Bass reflex
Speaker unit	16 mm × 120 mm, cone type × 3
Rated impedance	3.5 ohms
Dimensions (approx.)	19.5 mm × 546 mm × 30.5 mm (w/h/d) 19.5 mm × 602 mm × 35 mm (w/h/d) with the wall mounting brackets 121 mm × 560 mm × 121 mm (w/h/d) with the desktop stand 181 mm × 1,200 mm × 181 mm (w/h/d) with the speaker stand
Mass (approx.)	0.5 kg 0.5 kg with the wall mounting brackets 1.0 kg with the desktop stand 2.0 kg with the speaker stand

Center (SS-ITC1)

Speaker system	2-way speaker system, Bass reflex
Speaker unit	16 mm × 120 mm, cone type × 3
Rated impedance	3.5 ohms
Dimensions (approx.)	540 mm × 19.5 mm × 30.5 mm (w/h/d) 597 mm × 19.5 mm × 35 mm (w/h/d) with the wall mounting brackets
Mass (approx.)	0.5 kg 0.5 kg with the wall mounting brackets

Surround (SS-ITR1)

Speaker system	Full range speaker system, Bass reflex
Speaker unit	16 mm × 120 mm, cone type × 2
Rated impedance	3.5 ohms
Dimensions (approx.)	19.5 mm × 546 mm × 30.5 mm (w/h/d) 19.5 mm × 602 mm × 35 mm (w/h/d) with the wall mounting brackets 121 mm × 560 mm × 121 mm (w/h/d) with the desktop stand 181 mm × 1,200 mm × 181 mm (w/h/d) with the speaker stand
Mass (approx.)	0.4 kg 0.4 kg with the wall mounting brackets 0.9 kg with the desktop stand 1.9 kg with the speaker stand

Subwoofer (SS-ITW1)

Speaker system	Subwoofer system, Bass reflex
Speaker unit	150 mm, cone type × 2
Rated impedance	2 ohms
Dimensions (approx.)	196 mm × 410 mm × 372 mm (w/h/d)
Mass (approx.)	10.5 kg

Speakers (BDV-IS1000)**Front/Center/Surround (SS-IS15)**

Speaker system	Full range speaker system
Speaker unit	35 mm, cone type
Rated impedance	10 ohms
Dimensions (approx.)	45 mm × 55 mm × 40 mm (w/h/d)
Mass (approx.)	0.07 kg

Subwoofer (SS-ISW1)

Speaker system	2-way subwoofer system, Bass reflex
Speaker unit	120 mm, cone type + 160 mm, cone type
Rated impedance	4 ohms
Dimensions (approx.)	196 mm × 360 mm × 372 mm (w/h/d)
Mass (approx.)	9.0 kg

General

Power requirements	220 - 240 V AC, 50/60 Hz
Power consumption (BDV-IT1000)	On: 140 W Standby: 0.3 W (at the Power Saving mode)
Power consumption (BDV-IS1000)	On: 100 W Standby: 0.3 W (at the Power Saving mode)
Output voltage/current (DIGITAL MEDIA PORT)	DC 5 V/700 mA
LAN (100) EXTERNAL	100BASE-TX Terminal External memory slot (For connecting the external memory) DC output: 5 V 500 mA Max
Dimensions (approx.)	430 mm × 125 mm × 355 mm (w/h/d) incl. projecting parts 430 mm × 125 mm × 385 mm (w/h/d) with the wireless transceiver inserted
Mass (approx.)	10 kg

Surround amplifier (TA-SA100WR)

Amplifier Section (BDV-IT1000)

RMS output power (reference)	100 W + 100 W (at 3.5 ohms, 1 kHz, 10 % THD)
------------------------------	---

Amplifier Section (BDV-IS1000)

RMS output power (reference)	50 W + 50 W (at 10 ohms, 1 kHz, 10 % THD)
------------------------------	--

Rated impedance	3 - 16 Ω
-----------------	----------

General

Power requirements	220 - 240 V AC, 50/60 Hz
Power consumption	On: 50 W
Dimensions (approx.)	85 mm × 100 mm × 330 mm (w/h/d) (incl. EZW-RT10) 85 mm × 100 mm × 345 mm (w/h/d) incl. speaker cord cover and speaker cord holder
Mass (approx.)	1.7 kg incl. speaker cord cover and speaker cord holder

Wireless transceiver (EZW-RT10)

Communication system	S-AIR Specification version 1.0
Output	12.0 mW
Frequency band	2.4000 GHz - 2.4835 GHz
Modulation method	DSSS
Power requirements	DC 3.3 V, 350 mA
Dimensions (approx.)	50 mm × 13 mm × 60 mm (w/h/d)
Mass (approx.)	24 g

Design and specifications are subject to change without notice.



- Standby power consumption 0.3 W.
- Halogenated flame retardants are not used in the printed wiring boards.
- Over 85% power efficiency of amplifier block is achieved with the full digital amplifier, S-Master.

Language Code List

The language spellings conform to the ISO 639: 1988 (E/F) standard.

Code Language	Code Language	Code Language	Code Language
1027 Afar	1183 Irish	1347 Maori	1507 Samoan
1028 Abkhazian	1186 Scots Gaelic	1349 Macedonian	1508 Shona
1032 Afrikaans	1194 Galician	1350 Malayalam	1509 Somali
1039 Amharic	1196 Guarani	1352 Mongolian	1511 Albanian
1044 Arabic	1203 Gujarati	1353 Moldavian	1512 Serbian
1045 Assamese	1209 Hausa	1356 Marathi	1513 Siswati
1051 Aymara	1217 Hindi	1357 Malay	1514 Sesotho
1052 Azerbaijani	1226 Croatian	1358 Maltese	1515 Sundanese
1053 Bashkir	1229 Hungarian	1363 Burmese	1516 Swedish
1057 Byelorussian	1233 Armenian	1365 Nauru	1517 Swahili
1059 Bulgarian	1235 Interlingua	1369 Nepali	1521 Tamil
1060 Bihari	1239 Interlingue	1376 Dutch	1525 Telugu
1061 Bislama	1245 Inupiak	1379 Norwegian	1527 Tajik
1066 Bengali; Bangla	1248 Indonesian	1393 Occitan	1528 Thai
1067 Tibetan	1253 Icelandic	1403 (Afan)Oromo	1529 Tigrinya
1070 Breton	1254 Italian	1408 Oriya	1531 Turkmen
1079 Catalan	1257 Hebrew	1417 Punjabi	1532 Tagalog
1093 Corsican	1261 Japanese	1428 Polish	1534 Setswana
1097 Czech	1269 Yiddish	1435 Pashto;	1535 Tonga
1103 Welsh	1283 Javanese	Pushto	1538 Turkish
1105 Danish	1287 Georgian	1436 Portuguese	1539 Tsonga
1109 German	1297 Kazakh	1463 Quechua	1540 Tatar
1130 Bhutani	1298 Greenlandic	1481 Rhaeto-	1543 Twi
1142 Greek	1299 Cambodian	Romance	1557 Ukrainian
1144 English	1300 Kannada	1482 Kirundi	1564 Urdu
1145 Esperanto	1301 Korean	1483 Romanian	1572 Uzbek
1149 Spanish	1305 Kashmiri	1489 Russian	1581 Vietnamese
1150 Estonian	1307 Kurdish	1491 Kinyarwanda	1587 Volapük
1151 Basque	1311 Kirghiz	1495 Sanskrit	1613 Wolof
1157 Persian	1313 Latin	1498 Sindhi	1632 Xhosa
1165 Finnish	1326 Lingala	1501 Sangho	1665 Yoruba
1166 Fiji	1327 Laothian	1502 Serbo-	1684 Chinese
1171 Faroese	1332 Lithuanian	Croatian	1697 Zulu
1174 French	1334 Latvian;	1503 Singhalese	
1181 Frisian	Lettish	1505 Slovak	
	1345 Malagasy	1506 Slovenian	1703 Not specified

Parental Control/Area Code List

Code Area	Code Area	Code Area	Code Area
2044 Argentina	2165 Finland	2362 Mexico	2149 Spain
2047 Australia	2174 France	2376 Netherlands	2499 Sweden
2046 Austria	2109 Germany	2390 New Zealand	2086 Switzerland
2057 Belgium	2248 India	2379 Norway	2528 Thailand
2070 Brazil	2238 Indonesia	2427 Pakistan	2184 United Kingdom
2079 Canada	2254 Italy	2424 Philippines	
2090 Chile	2276 Japan	2436 Portugal	
2092 China	2304 Korea	2489 Russia	
2115 Denmark	2363 Malaysia	2501 Singapore	

Terms and Conditions of Use and End User License Agreement

The Sony Blu-ray Disc player ("Product") and associated software ("Software") are provided and maintained by Sony Electronics Inc. and its affiliates ("Sony"). Sony also provides and maintains associated service (the "Service"), including any subsite accessible through the Service's Internet homepage (the "Site"). The Software includes software embedded in the Product; stored on any media, bundled with the Product or otherwise provided by Sony; downloaded from the Site or otherwise made accessible or provided by Sony; any such media and any printed or "on-line" or electronic documentation associated with the Product and all updates and upgrades thereto.

WHEN YOU ACCESS, BROWSE, OR USE THE SERVICE, PRODUCT, SOFTWARE, AND/OR SITE, YOU ACCEPT, WITHOUT LIMITATION OR QUALIFICATION, THE TERMS AND CONDITIONS SET FORTH HEREIN, SONY'S PRIVACY POLICY POSTED ON THE SITE, AND ANY ADDITIONAL TERMS AND CONDITIONS OF USE SET FORTH IN ANY PORTION OF THE SERVICE AND SITE (COLLECTIVELY THE "AGREEMENT"). IF YOU DO NOT AGREE WITH THE TERMS AND CONDITIONS OF THIS AGREEMENT, SONY DOES NOT GRANT THE LIMITED RIGHTS HEREIN, AND PLEASE DO NOT USE THE SERVICE, PRODUCT, SOFTWARE, AND/OR SITE.

1. Ownership

The Software and all materials on the Service and/or Site, including but not limited to images, software and text (the "Content") are protected by copyright under U.S. copyright law, international conventions, and other copyright laws. You cannot use the Software, Service, Product, Content, and Site except as specified herein. There may be proprietary logos, service marks, and trademarks found on this Service or Site. By making them available on the Service and/or Site, Sony is not granting you any license to utilize those proprietary logos, service marks, or trademarks. Any unauthorized use of the Service, Site, Content or Software may violate copyright laws, trademark laws, the laws of privacy and publicity, and civil and criminal statutes. All title and copyright in and to the Software or materials on the Service/Site and any copies of the Software, are owned by Sony, its licensors, or suppliers. All rights not specifically granted under this Agreement are reserved by Sony, its licensors, and suppliers.

2. Your Rights & Limited License

The Service, Site, Software, Content, and Product are only for your personal use. You are responsible for all your activities hereunder, including all legal liability incurred from your use of the Service or others who use the Service via your Product or Account (as defined below). You may use the Service, Site, Software, Content and Product for lawful purposes only. You may not distribute, exchange, modify, sell, or transmit anything you may copy from the Service or Site, including but not limited to any text, images, audio, and video, for any business, commercial, or public purpose. As long as you comply with the terms of this Agreement, Sony grants you a non-exclusive, non-transferable, limited right to enter, display, and use the Service, Site, and Software as set forth in this Agreement. You agree not to interrupt/disrupt or attempt to interrupt/disrupt the operation of this Service, Site or Software in any way.

3. User Account & Privacy

As part of your usage of the Product, Service, Site, and/or Software, Sony may require that you establish a user account ("Account") for which you must provide Sony true, accurate, current, and complete information about yourself and maintain/promptly update such information. You are responsible for maintaining the confidentiality of any and all of your passwords associated with the Account. You agree to notify Sony immediately of any unauthorized use of your

password or any other breach of security related to the Service, Site, and/or Software.

Sony's Privacy Policy is posted on the Site and at <http://products.sel.sony.com/SEL/legal/privacy.html>, the terms of which are incorporated herein, and applies to your use of the Account, Product, Service, Site, and Software.

4. Automatic Update

The Software contains a functionality by which it is updated automatically when the Product is connected to a server belonging to Sony or to a third party designated by Sony. When you specify your intention not to use this automatic update functionality, or when the setting asking whether you wish to update automatically is activated and you decline to execute updates, it is assumed that you agree that the security functionality improvements, error corrections, other functional updates or any other changes offered by Sony through such updates would not be made to the Software and that your current and further use of the Software may be affected thereby.

When the automatic update functionality described in the previous paragraph is activated, it is assumed that you agree (a) that the Software will be automatically updated as necessary to improve security functionality, to correct errors, to improve update functionality, or for other purposes, and (b) that this updating of the Software may be accompanied by the augmenting, modifying, or removing of functionality of the Software.

5. Additional Terms Governing Product Software

You may use the Software solely in conjunction with the Product that accompanied the Software. The Software is licensed, not sold. In addition to the terms set forth in other portions of this Agreement, the Software is subject to the following:

Use of Software. You may use the Software in conjunction with the Product for personal use.

Limitation on Reverse Engineering, Decompilation and Disassembly. You may not modify, reverse engineer, decompile, or disassemble the Software in whole or in part.

Separation of Components. The Software is licensed as a single product. Its component parts may not be separated for use on more than one device unless expressly authorized by Sony.

Data Files. The Software may create data files automatically for use with the Software. Any such data files will be deemed as part of the Software.

Rental. You may not rent or lease the Software.

Software Transfer. You may permanently transfer all of your rights under this Agreement only as part of a sale or transfer of Software accompanying the sale or transfer of your Product, provided you retain no copies, transfer all of the Software (including all copies, component parts, the media and printed materials, all versions and any upgrades of the Software and this Agreement), and the recipient agrees to the terms of this Agreement.

Dependent Software. The software, network services or other products other than Software upon which the Software's performance depends on might be interrupted or discontinued at the discretion of the suppliers (software suppliers, service providers or Sony).

High Risk Activities. The Software is not fault-tolerant and is not designed, manufactured or intended for use or resale as on-line control equipment in hazardous environments requiring fail-safe performance, such as in the operation of nuclear facilities, aircraft navigation or communication systems, air traffic control, direct life support machines, or weapons systems, in which the failure of the Software could lead to death, personal injury, or severe physical or environmental damage ("High Risk Activities"). Sony and its suppliers specifically disclaim any express or implied warranty of fitness for High Risk Activities.

U.S. Government Restricted Rights. The Software is provided with RESTRICTED RIGHTS. Use, duplication, or disclosure by the United States Government is subject to restriction as set forth in subparagraph (c) (1) and (2) of the Commercial Computer Software-Restricted Rights at 48 CFR 52.227-19, as applicable. Manufacturer is Sony Electronics Inc., 16530 Via Esprillo, San Diego, CA 92127.

GNU General Public, Lesser General Public, & Other Licenses. Notwithstanding terms in this Agreement, certain portions of the Software are governed by the GNU Lesser General Public License, Version 2.1 (LGPL), GNU General Public License Version 2 (GPL), and other open source code licenses ("Open Source Licenses"), copies of which are attached hereto and incorporated herein. For such portions of the Software, to the extent there is any conflict between this Agreement and the Open Source Licenses, the Open Source Licenses shall govern as applicable.

Certain Source Code Availability. Sony is making available the source code of certain portions of the SOFTWARE per the GPL/LGPL LICENSES. Please see <http://www.sony.com/linux> for access to and instructions on obtaining such source code.

6. Changes to Service

Sony reserves the right to discontinue one, some, or all of the features of the Service you receive at any time at its discretion. Sony may, at its discretion and from time to time change, add or remove features and functionality, upgrade or modify the Service, Site and/or Software without notice. You may, at Sony's discretion, receive messages regarding these changes and new features/functionality. Any new text, content, file, data, product, services, information, software, software tool or other feature provided by Sony (through the network or by CD-ROM or other means) (including, but not limited to, any update to Software provided to you automatically pursuant to Section 4 of this Agreement) will be subject to this Agreement; provided that, if separate terms and conditions applicable to such feature are provided to you, such terms and conditions shall apply to such feature in priority to this Agreement.

7. Confidentiality

You shall maintain the confidentiality of any information with regard to the Product and Documentation that is provided under this Agreement and is not publicly known. You agree not to disclose such information to any third party without the prior written consent.

8. Sony's Right to Terminate or Modify Terms or Conditions of this Agreement

Sony may add to, change, or remove any part, term, or condition of this Agreement at any time, without prior notice. Any changes to this Agreement or any terms posted on the Service and/or Site apply as soon as they are posted. By continuing to use the Service, Product, Software and/or Site after any changes are posted, you are indicating your acceptance of those changes. SONY MAY ADD, CHANGE, DISCONTINUE, REMOVE, OR SUSPEND ANY OTHER CONTENT POSTED ON THE SERVICE AND/OR SITE, INCLUDING FEATURES AND SPECIFICATIONS OF PRODUCTS DESCRIBED OR DEPICTED ON THE SERVICE AND/OR SITE, TEMPORARILY OR PERMANENTLY, AT ANY TIME, WITHOUT NOTICE AND WITHOUT LIABILITY. WITHOUT PREJUDICE TO ANY OTHER RIGHTS, SONY MAY SUSPEND OR TERMINATE THIS AGREEMENT IMMEDIATELY UPON NOTICE IF YOU FAIL TO COMPLY WITH THE TERMS AND CONDITIONS OF THIS AGREEMENT. Upon termination, you shall destroy the Software within fourteen (14) days after the date of such termination, and upon Sony's request, provide Sony with the certification of such destruction. Sony may take any legal and technical remedies to prevent the violation of and/or to enforce this Agreement, including without limitation, immediate termination of your access to the Service if we believe in our discretion you are violating this Agreement.

9. Indemnification

You agree to indemnify, defend, and hold Sony and all of its agents, directors, employees, information providers, licensors and licensees, affiliates, content providers, officers, and parent (collectively, "Indemnified Parties"), harmless from and against any and all liability and costs (including, without limitation, attorneys' fees and costs), incurred by the Indemnified Parties in connection with any claim arising out of (i) any breach or alleged breach by you of this Agreement in any manner, (ii) any information you submit to Sony hereunder, (iii) any breach or alleged breach by you of a third party's rights or (iv) any damage caused by or alleged to have been caused by you to the Service. You will cooperate as fully as reasonably required in Indemnified Party(s) defense of any claim. Sony and/or Indemnified Parties reserve the right, at its own expense, to assume the exclusive defense and control of any matter otherwise subject to indemnification by you and you shall not in any event settle any matter without the written consent of Sony and/or Indemnified Parties.

10. DISCLAIMER OF WARRANTIES AND DAMAGES; LIMITATION OF LIABILITY

YOU UNDERSTAND THAT USAGE OF THE PRODUCT AND SERVICE REQUIRES INTERNET SERVICE PROVIDED BY YOU, FOR WHICH YOU ARE SOLELY RESPONSIBLE. OPERATION OF THE PRODUCT AND/OR SERVICE MAY BE LIMITED OR RESTRICTED DEPENDING UPON THE CAPABILITIES OR TECHNICAL LIMITATIONS OF YOUR INTERNET SERVICE.

YOUR USE OF THE SOFTWARE, SERVICE, PRODUCT, CONTENT AND/OR SITE IS AT YOUR OWN RISK. THE SOFTWARE, SERVICE, CONTENT AND SITE ARE PROVIDED "AS IS" AND, TO THE FULLEST EXTENT PERMISSIBLE BY LAW, SONY MAKES NO REPRESENTATIONS OR WARRANTIES OF ANY KIND WHATSOEVER (1) FOR THE ACCURACY, MERCHANTABILITY, FITNESS FOR A PARTICULAR PURPOSE, OR NON-INFRINGEMENT ASSOCIATED WITH THE SERVICE, SITE, AND/OR SOFTWARE; (2) THAT THE SERVER(S) THAT MAKES THE SERVICE, SOFTWARE, AND/OR SITE AVAILABLE ARE FREE OF VIRUSES OR OTHER COMPONENTS THAT MAY INFECT, HARM, OR CAUSE DAMAGE TO YOUR COMPUTER, TELEVISION, OTHER EQUIPMENT, OR ANY OTHER PROPERTY. FURTHERMORE, SONY DOES NOT WARRANT OR MAKE ANY REPRESENTATIONS REGARDING THE USE OR THE RESULTS OF THE USE OF THE SOFTWARE, SERVICE, AND/OR SITE IN TERMS OF ITS CORRECTNESS, ACCURACY, RELIABILITY, OR OTHERWISE. NO ORAL OR WRITTEN INFORMATION OR ADVICE GIVEN BY SONY OR A SONY AUTHORIZED REPRESENTATIVE SHALL CREATE A WARRANTY OR IN ANY WAY INCREASE THE SCOPE OF THIS WARRANTY. SHOULD THE SOFTWARE, SERVICE, AND/OR SITE PROVE DEFECTIVE YOU (AND NOT SONY OR A SONY AUTHORIZED REPRESENTATIVE) ASSUME THE ENTIRE COST OF ALL NECESSARY SERVICING, REPAIR OR CORRECTION.

UNDER NO CIRCUMSTANCES, INCLUDING BUT NOT LIMITED TO SONY'S NEGLIGENCE OR ISSUES RELATED TO THIRD PARTY CONTENT PROVIDERS, SHALL SONY BE LIABLE FOR ANY CONSEQUENTIAL, DIRECT, INCIDENTAL, INDIRECT, PUNITIVE, OR SPECIAL DAMAGES RELATED TO (A) THE USE OF, (B) THE INABILITY TO USE, OR (C) ERRORS OR OMISSIONS IN THE SOFTWARE, SERVICE, PRODUCT, AND/OR SITE, EVEN IF SONY OR AN AUTHORIZED REPRESENTATIVE THEREOF HAS BEEN ADVISED OF THE POSSIBILITY OF SUCH DAMAGES. SOME STATES DO NOT ALLOW THE EXCLUSION OR LIMITATION OF CONSEQUENTIAL OR INCIDENTAL DAMAGES, SO THE ABOVE LIMITATION OR EXCLUSION MAY NOT APPLY TO YOU. IN NO EVENT SHALL SONY'S TOTAL LIABILITY TO YOU FOR ALL DAMAGES, LOSSES, AND CAUSES OF ACTION (WHETHER IN CONTRACT OR TORT, INCLUDING, BUT NOT LIMITED TO, NEGLIGENCE OR OTHERWISE) EXCEED \$100.00.

11. General Provisions

This Agreement, the limited warranty accompanying the Product, plus any additional terms posted on the Service or Site, together constitute the entire agreement between Sony and you with respect to your use of the Product, Service, Site, Content, and Software. Any notice by Sony hereunder may be made by letter, email, or posting on the Service or Site. Any cause of action you may have with respect to your use of this Site must be commenced within one (1) year after the claim or cause of action arises. If for any reason a court of competent jurisdiction finds any provision of this Agreement, or portion thereof, to be unenforceable, that provision shall be enforced to the maximum extent permissible so as to affect the intent of this Agreement, and the remaining terms and conditions of the Agreement shall continue in full force and effect. This Agreement shall be governed by and construed in accordance with the laws of the State of Delaware, United States of America, without reference to its conflicts of law rules. You agree to submit to the personal and exclusive jurisdiction of federal or state courts in Delaware.

Glossary

AACS

“Advanced Access Content System” is a specification for managing digital entertainment contents stored on the next generation of prerecorded and recorded optical media. The specification enables consumers to enjoy digital entertainment content, including high-definition content.

AVCHD

The AVCHD format is a high-definition digital video camera format used to record SD (standard definition) or HD (high definition) signals of either the 1080i specification* or the 720p specification** on DVDs, using efficient data compression coding technology. The MPEG-4 AVC/H.264 format is adopted to compress video data, and the Dolby Digital or Linear PCM system is used to compress audio data. The MPEG-4 AVC/H.264 format is capable of compressing images at higher efficiency than that of the conventional image compression format. The MPEG-4 AVC/H.264 format enables a high definition (HD) video signal shot on a digital video camera recorder to be recorded on DVD discs in the same way as it would be for a standard definition (SD) television signal.

* A high definition specification that utilizes 1080 effective scanning lines and the interlace format.

** A high definition specification that utilizes 720 effective scanning lines and the progressive format.

BD-J application

The BD-ROM format supports Java for interactive functions.

“BD-J” offers content providers almost unlimited functionality when creating interactive BD-ROM titles.

BD-R

BD-R (Blu-ray Disc Recordable) is a recordable, write-once Blu-ray Disc, available in the same capacities as the BD below. Since contents can be recorded and cannot be overwritten, a BD-R can be used to archive valuable data or storing and distributing video material.

BD-RE

BD-RE (Blu-ray Disc Rewritable) is a recordable and rewritable Blu-ray Disc, available in the same capacities as the BD below. The re-recordable feature makes extensive editing and time-shifting applications possible.

BD-ROM

BD-ROMs (Blu-ray Disc Read-Only Memory) are commercially produced discs and are available in the same capacities as the BD below. Other than conventional movie and video contents, these discs have enhanced features such as interactive content, menu operations using pop-up menus, selection of subtitle display, and slideshow. Although a BD-ROM may contain any form of data, most BD-ROM discs will contain movies in High Definition format, for playback on Blu-ray Disc/DVD players.

Blu-ray Disc (BD)

A disc format developed for recording/playing high-definition (HD) video (for HDTV, etc.), and for storing large amounts of data. A single layer Blu-ray Disc holds up to 25 GB, and a dual-layer Blu-ray Disc holds up to 50 GB of data.

Digital Cinema Auto Calibration

Digital Cinema Auto Calibration was developed by Sony to automatically measure and adjust the speaker settings to your listening environment in a short period of time.

Dolby Digital

This movie theater sound format is more advanced than Dolby Surround Pro Logic. In this format, the surround speakers output stereo sound with an expanded frequency range, and a subwoofer channel for deep bass is independently provided. This format is also called “5.1” with the subwoofer channel designed as the 0.1 channel (since it functions only when a deep bass effect is needed). All six channels in this format are recorded separately for superior channel separation. Furthermore, since all the signals are processed digitally, less signal degradation occurs.

Dolby Digital Plus

Developed as an extension to Dolby Digital, the audio coding technology supports 7.1 multi-channel surround sound.

Dolby Pro Logic II

Dolby Pro Logic II creates five full-bandwidth output channels from 2 channel sources. This is done using an advanced, high-purity matrix surround decoder that extracts the spatial properties of the original recording without adding any new sounds or tonal colorations.

■ Movie mode

The Movie mode is for use with stereo television shows and all programs encoded in Dolby Surround. The result is enhanced sound field directionality that approaches the quality of discrete 5.1-channel sound.

■ Music mode

The Music mode is for use with any stereo music recordings, and provides a wide and deep sound space.

Dolby Surround Pro Logic

As one method of decoding Dolby Surround, Dolby Surround Pro Logic produces four channels from 2 channel sound. Compared with the former Dolby Surround system, Dolby Surround Pro Logic reproduces left-to-right panning more naturally and localizes sounds more precisely. To take full advantage of Dolby Surround Pro Logic, you should have one pair of surround speakers and a center speaker. The surround speakers output monaural sound.

Dolby TrueHD

Dolby TrueHD is a lossless coding technology that supports up to 8 channels of multi-channel surround sound for the next generation optical discs. The reproduced sound is true to the original source bit-for-bit.

DTS

Digital audio compression technology developed by DTS, Inc. This technology conforms to 5.1-channel surround. This format comprises of stereo rear channel and there is discrete subwoofer channel in this format. DTS provides the same 5.1 discrete channels of high quality digital audio. The good channel separation is realized due to the all channel data

being recorded discretely and processed in digitally.

DTS-HD High Resolution Audio

Developed as an extension to DTS Digital Surround format. It supports a maximum sampling frequency of 96 kHz, and 7.1 multi-channel surround.

DTS-HD High Resolution Audio has a maximum transmission rate of 6 Mbps, with lossy compression (Lossy).

DTS-HD Master Audio

DTS-HD Master Audio has a maximum transmission rate of 24.5 Mbps, and uses lossless compression (Lossless), and DTS-HD Master Audio corresponds to a maximum sampling frequency of 192 kHz, and maximum of 7.1ch.

HDMI (High-Definition Multimedia Interface)

HDMI is an interface that supports both video and audio on a single digital connection, allowing you to enjoy high quality digital picture and sound. The HDMI specification supports HDCP (High-bandwidth Digital Content Protection), a copy protection technology that incorporates coding technology for digital video signals.

LTH (Low to High)

LTH is a recording system that supports organic pigment type BD-R.

Parental Control

A function of the BD/DVD to limit playback of the disc by the age of the users according to the limitation level in each country. The limitation varies from disc to disc; when it is activated, playback is completely prohibited, violent scenes are skipped or replaced with other scenes and so on.

PhotoTV HD

“PhotoTV HD” allows for a highly-detailed pictures, and photo-like expression of subtle textures and colors. By connecting Sony “PhotoTV HD” compatible devices using an HDMI cable, whole new world of photos can be enjoyed in breathtaking Full HD quality. For instance, the delicate texture of the human skin, flowers, sand and waves can now be displayed on a large screen in beautiful photo-like quality.

Pop-up menu

An enhanced menu operation available on BD-ROMs. The pop-up menu appears when POP UP/MENU is pressed during playback, and can be operated while playback is in progress.

S-AIR**(Sony Audio Interactive Radio frequency)**

Recent times have seen the rapid spread of DVD media, Digital Broadcasting, and other high-quality media.

To ensure that the subtle nuances of these high-quality media are transmitted with no deterioration, Sony has developed a technology called “S-AIR” for the radio transmission of digital audio signals with no compression, and has incorporated this technology into the EZW-RT10/EZW-T100.

This technology transfers digital audio signals with no compression using the 2.4 GHz band range of ISM band (Industrial, Scientific, and Medical band), such as wireless LANs and Bluetooth applications.

x.v.Colour

x.v.Colour is a familiar term for the xvYCC standard proposed by Sony.

xvYCC is an international standard for color space in video.

This standard can express a wider color range than the currently used broadcast standard.

24p True Cinema

Movies shot with a film camera consist of 24 frames per second.

Since conventional televisions (both CRT and flat panels) display frames either at 1/60 or 1/50 second intervals, the 24 frames do not appear at an even pace.

When connected to a TV with 24p capabilities, the player displays each frame at 1/24 second intervals — the same interval originally shot with the film camera, thus faithfully reproducing the original cinema image.

Index

Numerics

24p True Cinema 155

A

Angle 77
Attenuate - SAT/CABLE 121
Attenuate - TV 121
Audio 122
Audio DRC 121
Audio Settings 121
Auto Calibration 108, 121
Auto Display 126
AVCHD 142, 153

B

BD Audio Setting 121
BD Data 78, 137
BD Internet Connection 123
BD Parental Control 122
BD/DVD Menu 122
BD/DVD Viewing Settings 122
BD-RE 153
BD-Live 78
BDMV 140
BD-R 153
BD-RE 153
Blu-ray Disc 153

C

CD 82, 140
Child Lock 116
Cinema Conversion Mode 120
Control for HDMI 76, 105, 124

D

D. C. A. C. (Digital Cinema
Auto Calibration) 108, 153
Digital Cinema Sound 89
DIGITAL MEDIA PORT 98
Dimmer 126
Disc Lock 76
Dolby Digital 90, 153
Dolby Digital Plus 154
Dolby Pro Logic II 154
Dolby Surround Pro Logic 154
Dolby TrueHD 154
DTS 90, 154
DTS-HD 154
DUAL MONO 91
DVD 74, 140
DVD Aspect Ratio 119

DVD Parental Control 122

E

Easy Setup 69, 128

F

Front panel 9
Front panel display 10
Fs Limit 121

H

HDMI
YCbCr/RGB 125
HDMI (High-Definition
Multimedia Interface) 154
HDMI Settings 124
Hybrid Disc Playback
Layer 123

I

Instant Advance 75
Instant Replay 75
Internet Settings 127

L

Language Code List 149
LTH 154

M

MOVIE-D.C.S.- 89
Multiplex broadcast sound 91

N

Naming preset stations 94
Network Settings 127
Network Update 118
NIGHT 115

O

One-Touch Play 76
OPTIONS 84
OSD 126
Output Video Format 120

P

PARENTAL CONTROL 154
Parental Control 75
Parental Control Region
Code 123
Password 123
Pause Mode 120

Photo Settings 124
PhotoTV HD 85, 155
Playable discs 140
POP UP/MENU 78

R

RDS 97
Rear panel 11
Region code 141
Remote 16
Resetting 129
Resume Play 77

S

S-AIR 4, 99, 155
S-AIR ID 99, 126
S-AIR Pairing 102, 126
S-AIR receiver 99
S-AIR RF Change 104, 126
S-AIR Standby 102, 126
Screen Format 119
Screen Saver 126
Slideshow Speed 124
Sound Mode 89
Speaker Settings 110, 121
Connection 110
Distance 110
Level 111
Standby Mode 126
Subtitle 122
Surround amplifier 12, 99
System Information 126

T

Test Tone 111
TV Type 119

U

Update 118

V

Video Settings 119

X

x.v.Colour 125, 155

Free Manuals Download Website

<http://myh66.com>

<http://usermanuals.us>

<http://www.somanuals.com>

<http://www.4manuals.cc>

<http://www.manual-lib.com>

<http://www.404manual.com>

<http://www.luxmanual.com>

<http://aubethermostatmanual.com>

Golf course search by state

<http://golfingnear.com>

Email search by domain

<http://emailbydomain.com>

Auto manuals search

<http://auto.somanuals.com>

TV manuals search

<http://tv.somanuals.com>