

# SONY®

3-293-642-12(1)

# Micro HI-FI Component System

Operating Instructions  
CMT-BX50BTi



© 2008 Sony Corporation

Download from [www.somanuals.com](http://www.somanuals.com). All Manuals Search And Download.

## WARNING

**To reduce the risk of fire or electric shock, do not expose this apparatus to rain or moisture.**

### CAUTION

The use of optical instruments with this product will increase eye hazard.

### Notice for the customers in the U.S.A.

The following CAUTION marking is located on the rear exterior.

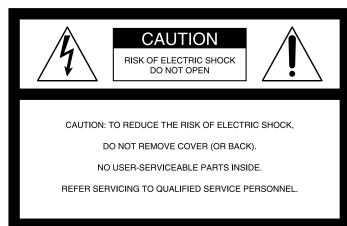

This symbol is intended to alert the user to the presence of uninsulated “dangerous voltage” within the product’s enclosure that may be of sufficient magnitude to constitute a risk of electric shock to persons.



This symbol is intended to alert the user to the presence of important operating and maintenance (servicing) instructions in the literature accompanying the appliance.

### Owner’s Record

The model and serial numbers are located on the rear of the unit. Record these numbers in the space provided below. Refer to them whenever you call upon your Sony dealer regarding this product.

Model No. \_\_\_\_\_

Serial No. \_\_\_\_\_

### Note to CATV system installer:

This reminder is provided to call the CATV system installer’s attention to Article 820-40 of the NEC that provides guidelines for proper grounding and, in particular, specifies that the cable ground shall be connected to the grounding system of the building, as close to the point of cable entry as practical.

**The following FCC statement applies only to the version of this model manufactured for sale in the U.S.A. Other versions may not comply with FCC technical regulations.**

### NOTE:

This equipment has been tested and found to comply with the limits for a Class B digital device, pursuant to Part 15 of the FCC Rules. These limits are designed to provide reasonable protection against harmful interference in a residential installation. This equipment generates, uses and can radiate radio frequency energy and, if not installed and used in accordance with the instructions, may cause harmful interference to radio communications. However, there is no guarantee that interference will not occur in a particular installation. If this equipment does cause harmful interference to radio or television reception, which can be determined by turning the equipment off and on, the user is encouraged to try to correct the interference by one or more of the following measures:

- Reorient or relocate the receiving antenna.
- Increase the separation between the

equipment and receiver.

— Connect the equipment into an outlet on a circuit different from that to which the receiver is connected.

— Consult the dealer or an experienced radio/TV technician for help.

## **CAUTION**

You are cautioned that any changes or modifications not expressly approved in this manual could void your authority to operate this equipment.

This equipment must not be co-located or operated in conjunction with any other antenna or transmitter.

This equipment complies with FCC radiation exposure limits set forth for uncontrolled equipment and meets the FCC radio frequency (RF) Exposure Guidelines in Supplement C to OET65. This equipment has a very low RF energy level that is deemed to comply with FCC radio frequency (RF) Exposure Guidelines in Supplement C to OET65 without maximum permissive exposure evaluation (MPE).

This equipment is desirable that it should be installed and operated with at least 20cm and more between the radiator and person's body (excluding extremities: hands, wrists, feet and ankles).

## **Notice for the customers in Canada**

Operation is subject to the following two conditions: (1) this device may not cause interference, and (2) this device must accept any interference, including interference that may cause undesired operation of this device.

This equipment complies with IC radiation exposure limits set forth for uncontrolled equipment and meets the RSS-102 of the IC radio frequency (RF) Exposure rules. This equipment has a very low RF energy level that is deemed to comply with RSS-102 without maximum permissive exposure evaluation (MPE).

This equipment is desirable that it should be installed and operated with at least 20cm and more between the radiator and person's body (excluding extremities: hands, wrists, feet and ankles).

## **Note on DualDiscs**

A DualDisc is a two sided disc product which mates DVD recorded material on one side with digital audio material on the other side. However, since the audio material side does not conform to the Compact Disc (CD) standard, playback on this product is not guaranteed.

## **Music discs encoded with copyright protection technologies**

This product is designed to playback discs that conform to the Compact Disc (CD) standard. Recently, various music discs encoded with copyright protection technologies are marketed by some record companies. Please be aware that among those discs, there are some that do not conform to the CD standard and may not be playable by this product.

- The Bluetooth word mark and logos are owned by the Bluetooth SIG, Inc. and any use of such marks by Sony Corporation is under license. Other trademarks and trade names are those of their respective owners.
- MPEG Layer-3 audio coding technology and patents licensed from Fraunhofer IIS and Thomson.
- iPod is a trademark of Apple Inc., registered in the U.S. and other countries.

---

# Table of Contents

Guide to parts and controls .....	5
Information on the display.....	9

## Getting Started

Hooking up the system securely.....	10
Setting the clock .....	12

## Basic Operations

Playing a CD/MP3 disc .....	13
Listening to the radio .....	14
Using the Bluetooth function.....	15
Playing the iPod.....	21
Using optional audio components.....	23
Adjusting the sound .....	23
Changing the display .....	24

## Other Operations

Creating your own program (Program Play).....	25
Presetting radio stations .....	26
Using the Timers.....	27

## Others

Troubleshooting.....	29
Messages.....	33
Precautions.....	34
Specifications .....	36
Bluetooth wireless technology .....	38
Compatible devices with this system.....	40

## Guide to parts and controls

This manual mainly explains operations using the remote, but the same operations can also be performed using the buttons on the unit having the same or similar names.

### Unit (HCD-BX50BTi/Compact Disc Receiver)

#### Front panel

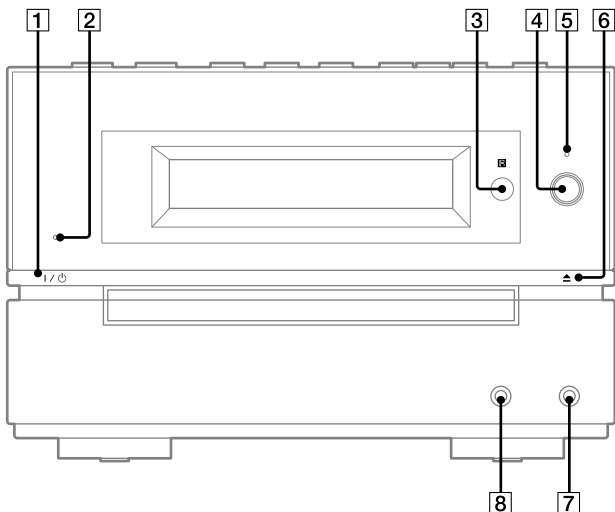

#### Top panel

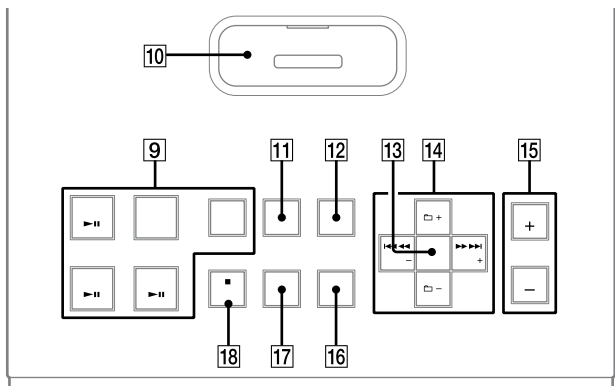

Continued  5<sup>GB</sup>

## Remote (RM-AMU009)

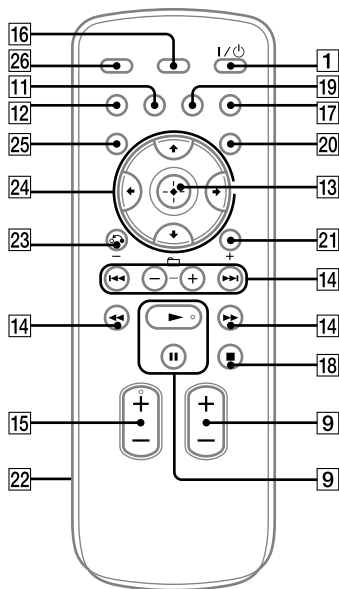

**1**  
I/O (power) button (page 12, 27, 32)  
Press to turn on the system.

**2**  
STANDBY indicator (page 24, 29)  
Lights up when the system is turned off.

**3**  
Remote sensor (page 29)

**4**  
BLUETOOTH button (page 17, 19, 20)

Press to make a connection, disconnection, or pairing with a Bluetooth device.

**5**  
BLUETOOTH indicator (page 19, 20)  
Lights up when the Bluetooth function is active.

**6**  
▲ (open/close) button (page 13)  
Press to open or close the disc tray.



**7**  
AUDIO IN jack (page 23)  
Connect to an optional audio component.

**8**  
PHONES jack  
Connect the headphones.

**9**  
Playback buttons and function buttons  
Unit: BLUETOOTH ►|| (play/pause) button (page 16, 17)  
Press to select the Bluetooth function. Press to start or pause playback of the music on the Bluetooth device (Bluetooth mobile phone, etc.).

**Unit:** CD  (play/pause) button (page 13)  
 Press to select the CD function.  
 Press to start or pause playback of a disc.

**Unit:** iPod  (play/pause) button (page 21, 22)  
 Press to select the iPod function.  
 Press to start or pause playback of the iPod.

**Remote:**  (play) button,  
 (pause) button  
 Press to start or pause playback.

**TUNER/BAND button** (page 14)  
 Press to select the TUNER function.  
 Press to select FM or AM reception mode.

**Unit:** FUNCTION button (page 13, 14, 19, 20, 21, 23)  
**Remote:** FUNCTION +/- button (page 13, 14, 19, 20, 21, 23)  
 Press to select the function.

**10**  
**iPod connector**  
 Place an iPod on the connector to listen to audio contents stored in the iPod.

**11**  
**REPEAT/FM MODE button** (page 13, 14)  
 Press to listen to a disc, a single track or file repeatedly.  
 Press to select the FM reception mode (monaural or stereo).

**12**  
**PLAY MODE/TUNING MODE button** (page 13, 14, 25, 26)  
 Press to select the play mode of a CD or MP3 disc.  
 Press to select the tuning mode.

**13**  
**Unit:** ENTER button (page 22, 25)  
**Remote:**  (enter) button (page 12, 16, 22, 25, 26, 27)  
 Press to enter the settings.

**14**  
 (go back/go forward) button (page 13, 16, 17, 21, 22, 25)  
 Press to select a track or file.

**Unit:** TUNE +/- (tuning) button (page 14)  
**Remote:** +/- (tuning) button (page 14, 26)  
 Press to tune in the desired station.

 +/- (select folder) button (page 13, 16, 17, 25)  
 Press to select a folder.

 (rewind/fast forward) button (page 13, 16, 17, 22)  
 Press to find a point in a track or file.

**15**

Unit: VOL +/- button (page 13, 14, 17, 20, 21, 23)

Remote: VOLUME +/- button (page 13, 14, 17, 20, 21, 23)

Press to adjust the volume.

**16**

DISPLAY button (page 17, 22, 24)

Press to change the information on the display.

**17**

Sound buttons (page 23)

Unit: DSGX button

Remote: EQ button

Press to select the sound effect.

**18**

Unit: ■/CANCEL (stop/cancel) button (page 13, 14, 16, 17, 19)

Remote: ■ (stop) button (page 13, 14, 16, 17, 19)

Press to stop playback.

**19**

CLEAR button (page 17, 19, 25)

Press to delete a pre-programmed track or file.

Press to erase the pairing registration information of the Bluetooth device.

**20**

TIMER MENU button (page 12, 27)

Press to set the clock and the Play Timer.

**21**

TOOL MENU button (page 22)

Press to select a menu when using the iPod.

**22**

Battery compartment lid (page 11)

**23**

↶ RETURN button (page 22)

Press to return to the previous menu when using the iPod.

**24**

▲/▼/◀/▶ button (page 12, 22, 27)

Press to select the menu items.

**25**

TUNER MEMORY button (page 26)

Press to preset the radio station.

**26**

SLEEP button (page 27)

Press to set the Sleep Timer.



## Information on the display

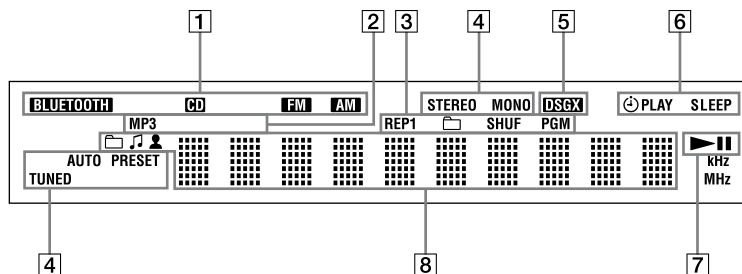

**1**

Function

**5**

DSGX (page 23)

**2**

Audio format

**6**

Timer (page 27)

**3**

Play mode (page 13)

**7**

Play/Pause

**4**

Tuner reception mode (page 14)

**8**

Text information

Tuner reception (page 14)

## Getting Started

### Hooking up the system securely

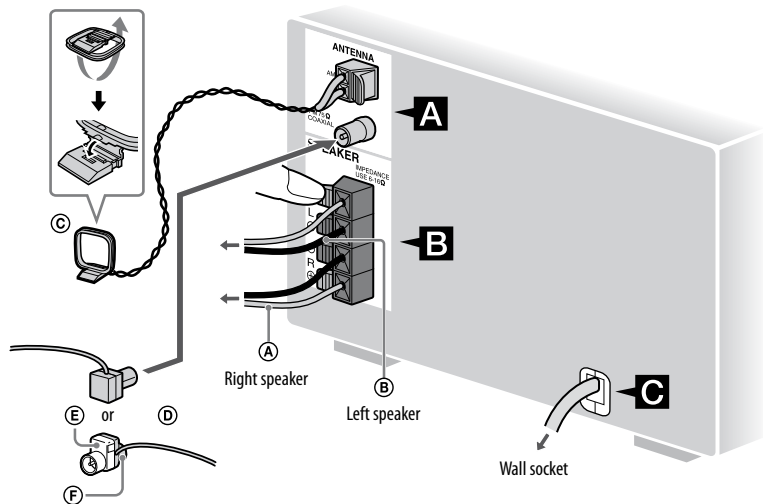

- (A) Speaker cord (Red/⊕)
- (B) Speaker cord (Black/⊖)
- (C) AM loop antenna
- (D) FM lead antenna (Extend it horizontally.)
- (E) White side for North American model
- (F) Brown side for other regions

## A Antennas

Find a location and an orientation that provide good reception, and then set up the antenna.

Keep the antennas away from the speaker cords and the power cord to avoid picking up noise.

## B Speakers

Insert only the stripped portion of the speaker cords into the SPEAKER jacks.

## C Power

Connect the power cord to a wall socket. If the plug does not fit the wall socket, detach the supplied plug adaptor (only for models equipped with an adaptor).

## When carrying this system

- 1 Remove a disc to protect the CD mechanism.
- 2 Press FUNCTION +/- (or FUNCTION on the unit) [9] repeatedly to select the CD function.
- 3 Hold down VOL + [15] and DSGX [17] on the unit, and press ▲ [6] on the unit until "STANDBY" appears.
- 4 After "LOCK" appears, unplug the power cord.

## To use the remote

Slide and remove the battery compartment lid [22], and insert the two supplied R6 (size AA) batteries, ⚡ side first, matching the polarities shown below.

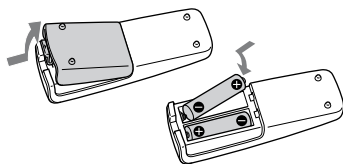

## Notes

- With normal use, the batteries should last for about six months.
- Do not mix an old battery with a new one or mix different types of batteries.
- If you do not use the remote for a long period of time, remove the batteries to avoid damage from battery leakage and corrosion.

## To use the iPod

Insert an iPod Dock Adapter into the unit's connector [10] before use.

For details on the supplied iPod Dock Adapters, refer to the instructions supplied with the Dock Adapters.

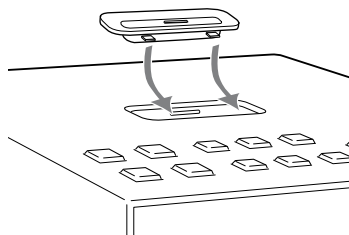

To remove the iPod Dock Adapter, pull it up with your fingernail or a flat object using the slot inside the adapter.

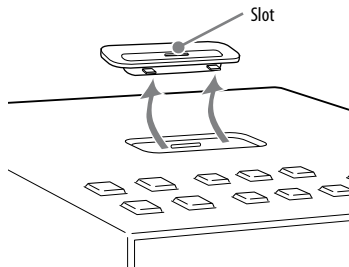

---

## Setting the clock

Use buttons on the remote to set the clock.

- 1** Press I/⏻ [1] to turn on the system.
- 2** Press TIMER MENU [20].  
The hour indication flashes in the display.  
If "PLAY SET?" flashes in the display, press ▲/▼ [24] repeatedly to select "CLOCK SET?" and then press ⊕ [13].
- 3** Press ▲/▼ [24] repeatedly to set the hour, and then press ⊕ [13].
- 4** Use the same procedure to set the minutes.  
The clock settings are lost when you disconnect the power cord or if a power failure occurs.

### To display the clock when the system is off

Press DISPLAY [16]. The clock is displayed for about 8 seconds.

## Basic Operations

### Playing a CD/MP3 disc

- 1 Select the CD function.  
Press FUNCTION +/- (or FUNCTION on the unit) [9] repeatedly.
- 2 Place a disc.  
Press ▲ [6] on the unit, and place a disc with the label side up on the disc tray.

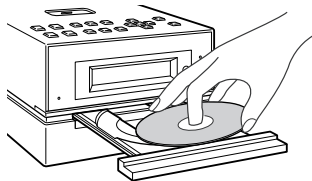

To close the disc tray, press ▲ [6] on the unit again.  
Do not force the disc tray closed with your finger, as this may damage the unit.

- 3 Start playback.  
Press ► (or CD ►|| on the unit) [9].
- 4 Adjust the volume.  
Press VOLUME +/- (or VOL +/- on the unit) [15].

### Other operations

To	Press
Pause playback	(or CD ►   on the unit) [9]. To resume play, press the button again.
Stop playback	■ [18].
Select a folder on an MP3 disc	📁 +/- [14].
Select a track or file	◀◀/▶▶ [14].
Find a point in a track or file	Hold down ◀◀/▶▶ [14] during playback, and release the button at the desired point.
Select Repeat Play	REPEAT [11] repeatedly until "REP" or "REP1" appears.

### To change the play mode

Press PLAY MODE [12] repeatedly while the player is stopped. You can select normal play ("📁\*") for all MP3 files in the folder on the disc, shuffle play ("SHUF" or "📁 SHUF\*"), or program play ("PGM").

\* When playing a CD-DA disc, 📁 (SHUF) Play performs the same operation as normal (shuffle) play.

### Notes on Repeat Play

- All tracks or files on a disc are played repeatedly up to five times.
- "REP1" indicates that a single track or file is repeated until you stop it.

## Notes on playing MP3 discs

- Do not save other types of files or unnecessary folders on a disc that has MP3 files.
- Folders that have no MP3 files are skipped.
- MP3 files are played back in the order that they are recorded onto the disc.
- The system can only play MP3 files that have a file extension of “.MP3”.
- If there are files on the disc that have the “.MP3” file extension, but that are not MP3 files, the unit may produce noise or may malfunction.
- The maximum number of:
  - folders is 255 (including the root folder).
  - MP3 files is 511.
  - MP3 files and folders that can be contained on a single disc is 512.
  - folder levels (the tree structure of files) is 8.
- Compatibility with all MP3 encoding/writing software, recording device, and recording media cannot be guaranteed. Incompatible MP3 discs may produce noise or interrupted audio or may not play at all.

## Notes on playing multisession discs

- If the disc begins with a CD-DA (or MP3) session, it is recognized as a CD-DA (or MP3) disc, and other sessions are not played back.
- A disc with a mixed CD format is recognized as a CD-DA (audio) disc.

# Listening to the radio

## 1 Select “TUNER FM” or “TUNER AM.”

Press FUNCTION +/- (or TUNER/BAND on the unit) [9] repeatedly.

## 2 Select the tuning mode.

Press TUNING MODE [12] repeatedly until “AUTO” appears.

## 3 Tune in the desired station.

Press +/- (or TUNE +/- on the unit) [14]. Scanning stops automatically when a station is tuned in, and then “TUNED” and “STEREO” (for stereo programs only) appear.

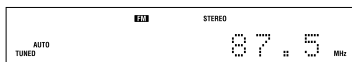

## 4 Adjust the volume.

Press VOLUME +/- (or VOL +/- on the unit) [15].

## To stop automatic scanning

Press ■ [18].

## To tune in a station with a weak signal

If “TUNED” does not appear and the scanning does not stop, press TUNING MODE [12] repeatedly until “AUTO” and “PRESET” disappear, and then press +/- (or TUNE +/- on the unit) [14] repeatedly to tune in the desired station.

## To reduce static noise on a weak FM stereo station

Press FM MODE [11] repeatedly until “MONO” appears to turn off stereo reception.

## Using the Bluetooth function

This system supports Bluetooth A2DP and AVRCP profiles. For details on Bluetooth wireless technology, see “Bluetooth wireless technology” (page 38).

Check the websites below for the latest information about compatible devices.

For customers in the U.S.A.:

<<http://www.sony.com/shelfsupport>>

For customers in Canada:

English <<http://www.sony.ca/ElectronicsSupport/>>

French <<http://fr.sony.ca/ElectronicsSupport/>>

For customers in Europe:

<<http://support.sony-europe.com/>>

For customers in Latin America:

<<http://www.sony-latin.com/index.crp>>

For customers in Asia and Oceania:

<<http://www.sony-asia.com/support>>

## Listening to music of a Bluetooth mobile phone or Bluetooth device

You can listen to music from your Bluetooth mobile phone or Bluetooth device over a wireless connection.

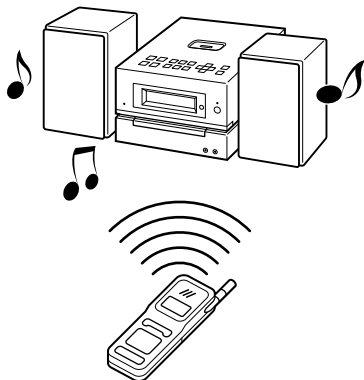

Follow the procedure below to listen to music from Bluetooth devices with this system.

Pairing this system with a Bluetooth device



Connecting to registered devices





Playing music of a Bluetooth device

For details about the operations of the Bluetooth device, also refer to the operation manual supplied with your Bluetooth device.

## Pairing this system with a Bluetooth device

Pairing is an operation where Bluetooth devices register with each other beforehand. Use the procedure below to pair the system with your Bluetooth device. Once a pairing operation is performed, it does not need to be performed again. If pairing is already completed, proceed to “Playing music of a Bluetooth device” (page 17).

- 1 Place the Bluetooth device to be connected to this system within 1 meter of the system.
- 2 Select the Bluetooth function. Press **BLUETOOTH**    on the unit.
- 3 Operate the Bluetooth device and perform the pairing operation.

For details about the operations of the Bluetooth device, refer to the operation manual supplied with your Bluetooth device.

When searching for this system with the Bluetooth device, a list of the devices found may appear in the Bluetooth device display depending on the type of Bluetooth device. This system appears as “CMT-BX50BTi.”









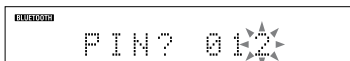



When establishing a connection with this system, select the audio profile (A2DP, AVRCP) at the Bluetooth device. If the Bluetooth device does not support the AVRCP profile, you cannot perform playback or other operations with the system (page 17).

## 4 Enter the passkey.

Passkey entry may be required depending on the type of Bluetooth device.

When “PIN?” and a countdown appear, enter the passkey at the system as follows:



Press   and   on the remote (or   and     on the unit)  to enter the same passkey that was entered at the Bluetooth device, and then press  .

Once pairing is completed and the connection is established, the system display changes as follows:

“Connect” → Name of the Bluetooth device

## To cancel passkey entry partway

Press  .

If passkey entry still required, turn off the Bluetooth device.

## Notes

- “Passkey” may be called “Passcode,” “PIN code,” “PIN number” or “Password,” etc. depending on the device.
- This system only supports numerical passkeys up to 4 digits.
- The pairing standby status of the system is cancelled after about 30 seconds.
- If pairing is not successful, redo the procedure from step 1.
- While connected to a Bluetooth device, this system cannot be detected and a connection cannot be established from another Bluetooth device.



## To erase all the pairing registration information

- Press **BLUETOOTH** [9] on the unit.  
When the system is connected with a Bluetooth device (when the Bluetooth device name or other information appears in the system display), press and hold **BLUETOOTH** [4] on the unit for about 2 seconds to put the system in Bluetooth standby mode.
- Press **CLEAR** [19].  
“Delete?” appears.
- Press **+** [13].  
“Complete!” appears and all the pairing information is erased.

### Note

In order to connect with a Bluetooth device after performing this operation, you must enter the passkey again.

## Playing music of a Bluetooth device

You can operate a Bluetooth device by connecting the system and a Bluetooth device using AVRCP.

- Select the Bluetooth function.  
Press **BLUETOOTH** [9] on the unit.
- Establish a connection from the Bluetooth device.  
For details about the operations of the Bluetooth device, refer to the operation manual supplied with your Bluetooth device.  
Once the connection is established, the system display changes as follows: “Connect” → Name of the Bluetooth device

- Start playback.  
Press (or **BLUETOOTH** on the unit) [9].  
Depending on the Bluetooth device, you may need to start up the AV software of the Bluetooth device beforehand.
- Adjust the volume.  
Press **VOLUME +/-** (or **VOL +/-** on the unit) [15].

## To check the address of a connected Bluetooth device

Press **DISPLAY** [16] while the Bluetooth device name appears in the system display.  
The Bluetooth device address appears for 8 seconds.

## To cancel the connection with a Bluetooth device

Press and hold **BLUETOOTH** [4] on the unit for about 2 seconds until “Disconnect” appears, or until the information on the display (device name, etc.) disappears.



## Other operations

To	Press
Pause playback	(or <b>BLUETOOTH</b> on the unit) [9].
Stop playback	[18].
Select a folder	+/- [14].
Select a file	[14].
Find a point in a file	Hold down   [14].

### Note



These operations may not be available for certain Bluetooth devices. In addition, the actual operations may differ depending on the connected Bluetooth device.

## Notes on connections with Bluetooth devices

- If you cannot connect with a paired Bluetooth device, perform the pairing operation between the system and the Bluetooth device again.
- Depending on the type of Bluetooth device, you can adjust the volume using the controls of the Bluetooth device.
- When **BLUETOOTH**   on the unit is pressed while connected to Bluetooth headphones, it may take some time until a connection is made to the system from another Bluetooth device.
- Use the A2DP-capable or A2DP- and AVRCP-capable Bluetooth device with the system in a peer-to-peer environment.

### Tip

Bluetooth devices that have been connected with this system in the past are registered with this system.

When a Bluetooth connection is not currently established, you can easily connect the system to a Bluetooth device by pressing **BLUETOOTH**   on the unit. (Connection is attempted with up to 3 devices in order from the most recently connected device, and the attempts end when a connection is established.) This function may not be available depending on the Bluetooth device you are using.

If a connection cannot be made, the system returns to the standby mode.

## Listening to music on this system using Bluetooth headphones

You can listen to music played on this system using your Bluetooth headphones over a wireless connection.

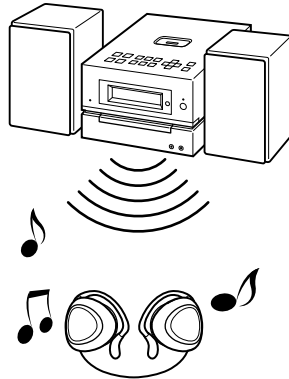

Follow the procedure below to listen to music on this system with Bluetooth headphones.

Pairing this system with Bluetooth headphones



Connecting to registered headphones



Playing music on this system

For details about the operations of the Bluetooth headphones, also refer to the operation manual supplied with your Bluetooth headphones.

## Pairing this system with Bluetooth headphones

Pairing is an operation where Bluetooth devices register with each other beforehand. Use the procedure below to pair the system with your Bluetooth headphones. Once a pairing operation is performed, it does not need to be performed again. If pairing is already completed, proceed to “Playing music on this system” (page 20).

### 1 Select a function other than the Bluetooth function.

Press FUNCTION +/- (or FUNCTION on the unit) [9] repeatedly.

### 2 Place the Bluetooth headphones to be connected to this system within 1 meter of the system.

### 3 Put the Bluetooth headphones in pairing mode.

For details about the operations of the Bluetooth headphones, refer to the operation manual supplied with your Bluetooth headphones.

### 4 Press and hold BLUETOOTH [4] on the unit for about 7 seconds until the BLUETOOTH indicator [5] flashes.

Sound output from the speakers is stopped.

### 5 Enter the passkey.

Follow the same procedure as in step 4 of “Pairing this system with a Bluetooth device” (page 16).

Once pairing is completed and the connection is established, the system display changes as follows:  
“Connect” → Name of the Bluetooth device

## To cancel passkey entry partway

Press ■ [18].

### Notes

- “Passkey” may be called “Passcode,” “PIN code,” “PIN number” or “Password,” etc. depending on the device.
- This system only supports numerical passkeys up to 4 digits.
- The pairing standby status of the system is cancelled after about 30 seconds.
- If pairing is not successful, redo the procedure from step 1.
- While connected to a Bluetooth device, this system cannot be detected and a connection cannot be established from another Bluetooth device.
- Pairing may not be possible if other Bluetooth devices are present around the system. In this case, turn off the other Bluetooth devices.

## To erase all the pairing registration information

### 1 Press BLUETOOTH ►|| [9] on the unit.

When the system is connected with a Bluetooth device (when the Bluetooth device name or other information appears in the system display), press and hold BLUETOOTH [4] on the unit for about 2 seconds to put the system in Bluetooth standby mode.

### 2 Press CLEAR [19]. “Delete?” appears.

### 3 Press + [13]. “Complete!” appears and all the pairing information is erased.

### Note

To connect with Bluetooth headphones after performing this operation, you must enter the passkey again.

## Playing music on this system

You can operate this system from Bluetooth headphones by connecting the system and Bluetooth headphones using AVRCP.

### 1 Select a function other than the Bluetooth function.

Press FUNCTION +/- (or FUNCTION on the unit) [9] repeatedly.

### 2 Establish a connection with the Bluetooth headphones.

Press and hold BLUETOOTH [4] on the unit for about 2 seconds until the BLUETOOTH indicator [5] lights up, then release the button. Sound output from the speakers is stopped.

If more than one Bluetooth device that has been connected in the past is present around the system, the system attempts to connect with up to 3 most recently connected devices. (Connection is attempted with up to 3 devices in order from the most recently connected device, and the attempts end when a connection is established.)

Once the connection is established, the system display changes as follows: "Connect" → Name of the Bluetooth device

### 3 Start playback of the music for the function selected in step 1.

Depending on the type of Bluetooth headphones, you can operate this system (playback, volume control, etc.) using the headphone's controls.

For details about the operations of the Bluetooth headphones, refer to the operation manual supplied with your Bluetooth headphones.

### 4 Adjust the volume.

Press VOLUME +/- (or VOL +/- on the unit) [15].

### To cancel the connection with Bluetooth headphones

Press and hold BLUETOOTH [4] on the unit for about 2 seconds until the BLUETOOTH indicator [5] turns off. Sound is output from the speakers.

#### Notes

- If you cannot connect with paired Bluetooth headphones, perform the pairing operation between the system and the Bluetooth headphones again.
- When the system is changed to a function other than the Bluetooth function and BLUETOOTH [4] on the unit is pressed while connected to a Bluetooth device, it may take some time until a connection is made with the Bluetooth headphones.
- This system stores separate volume settings for when listening through the speakers or PHONES jack [8] on the unit, or when listening through Bluetooth headphones.
- Use the A2DP-capable or A2DP- and AVRCP-capable Bluetooth device with the system in a peer-to-peer environment.

## Playing the iPod

You can listen to audio contents stored in the iPod.

### 1 Select the iPod function.

Press FUNCTION +/- (or FUNCTION on the unit) **[9]** repeatedly.

### 2 Place the iPod.

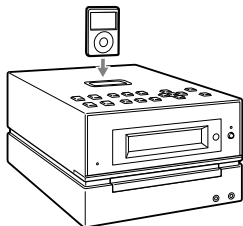

### 3 Start playback.

Press **[▶]** (or iPod **[▶||]** on the unit) **[9]**.

### 4 Adjust the volume.

Press VOLUME +/- (or VOL +/- on the unit) **[15]**.

## Notes

- When placing or removing the iPod, handle the iPod in the same angle as that of the iPod connector **[10]** on the unit and do not twist or sway the iPod to prevent connector damage.
- Do not carry the unit with an iPod set on the connector. Doing so may cause a malfunction.
- When placing or removing the iPod, brace the unit with one hand and take care not to press the controls of the iPod by mistake.
- Before disconnecting the iPod, pause playback.
- While playing video, you cannot use **[◀▶]** **[14]**. You can fast rewind (fast forward) by holding down **[◀▶]** **[14]**.
- To change the volume level, use VOLUME +/- (or VOL +/- on the unit) **[15]**. The volume level does not change even if adjusted on the iPod.
- This system is designed for iPod only. You cannot connect any other portable audio players.
- To use an iPod, refer to the user's guide of your iPod.
- Sony cannot accept responsibility in the event that data recorded to iPod is lost or damaged when using an iPod with this unit.

## Other operations

You can control your iPod with the following buttons on the remote or unit.

To	Press
Pause playback	⏸ (pause) (or iPod ▶⏸ (play/pause) on the unit) [9] or ■ (stop) [18].
Scroll up/down the iPod menus	⬆/⬇ [24]. You can scroll up or down the iPod menus much like the Click Wheel operations of the iPod or the drag up-or-down operations of the iPod touch.
Select a track or chapter of audiobook/podcast	⏮/▶⏭ (go back/go forward) [14]. To fast-forward or fast-rewind, hold down the button.
Choose the selected item	➡ [24]/⊕ (or ENTER on the unit) [13]. You can choose the selected item much like the center button on the iPod or the touch operation of the iPod touch.
Find a point in a track or chapter of audiobook/podcast	⏮/▶⏭ (fast rewind/fast forward) [14] during playback, and release the button at the desired point.
Return to the previous menu or select a menu	⬅ [24]/TOOL MENU [21]/↶ (return) [23]. You can return to the previous menu or select a menu much like the Menu button on the iPod or the touch operation of the iPod touch.

## To use the system as a battery charger

You can use the system as a battery charger for the iPod when the system is both on and off.

The charging begins when the iPod is placed on the unit's connector [10].

The charging status appears in the iPod display. For details, see the user's guide of your iPod.

## To stop charging the iPod

Remove the iPod. If you stop charging the iPod when the system is off, press DISPLAY [16] until the clock disappears in the display.

## Using optional audio components

- 1** Connect additional audio component to the AUDIO IN jack [7] on the unit using an audio analog cord (not supplied).
- 2** Turn down the volume.  
Press VOLUME – (or VOL – on the unit) [15].
- 3** Select the AUDIO IN function.  
Press FUNCTION +/- (or FUNCTION on the unit) [9] repeatedly.
- 4** Start playing the connected component.
- 5** Adjust the volume.  
Press VOLUME +/- (or VOL +/- on the unit) [15].

## Adjusting the sound

### To add a sound effect

To	Press
Generate a more dynamic sound (Dynamic Sound Generator X-tra)	DSGX [17] on the unit.
Set the sound effect	EQ [17] repeatedly to select “BASS” or “TREBLE,” and then press +/- [14] repeatedly to adjust the level.

## Changing the display

To	Press
Change information on the display <sup>1)2)</sup>	DISPLAY [16] repeatedly when the system is on.
Check the clock when the system is off <sup>3)</sup>	DISPLAY [16] when the system is off <sup>3)</sup> . The clock is displayed for 8 seconds.

- <sup>1)</sup> For example, you can view CD/MP3 disc information, such as;
- track or file number during normal play.
  - track or file name (“🎵”) during normal play.
  - artist name (“👤”) during normal play.
  - album or folder name (“📁”) during normal play.
  - total playing time while the player is stopped.
- <sup>2)</sup> When the system and a Bluetooth device are connected using the Bluetooth function, you can view the Bluetooth device address.
- If the connected Bluetooth device supports metadata transfer, you can also view the Bluetooth device information, such as the elapsed playing time, track title, artist name or album name during playback.
- <sup>3)</sup> The clock is displayed continuously while the iPod is being charged. To turn off the clock display, press DISPLAY [16] (See “To stop charging the iPod” (page 22)).
- <sup>4)</sup> The STANDBY indicator [2] on the unit lights up when the system is off.

### Notes on the display information

- Characters that cannot be displayed appear as “\_”.
- The following are not displayed:
  - total playing time for a CD-DA disc depending on the play mode.
  - total playing time and remaining playing time for an MP3 disc.
- The following is not displayed correctly:
  - folder and file names that do not follow either the ISO9660 Level 1, Level 2 or Joliet in the expansion format.
- The following is displayed:
  - ID3 tag information for MP3 files when ID3 version 1 and version 2 tags are used (up to 62 characters for an MP3 disc).
- The display information may not be updated or displayed properly depending on the Bluetooth device you are using.
- The display information may differ depending on the connected Bluetooth device.
- The display information for the Bluetooth device may not be updated properly depending on the communication environment or surrounding conditions.



## Other Operations

### Creating your own program

(Program Play)

- 1 Select the desired function.  
Press FUNCTION +/- (or FUNCTION on the unit) [9] repeatedly to select the CD function.
- 2 Press PLAY MODE [12] repeatedly until "PGM" appears while the system is stopped.
- 3 Press I◀◀/▶▶ [14] repeatedly until the desired track or file number appears.  
When programming files, press [14] repeatedly to select the desired folder, and then select the desired file.  
Example: When programming tracks on a CD

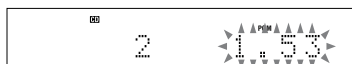

Selected track or file number

Total playing time of program (including selected track or file)

- 4 Press ⊕ (or ENTER on the unit) [13] to add the track or file to the program.  
“— —.— —” appears when the total program time exceeds 100 minutes for a CD, or when you select a CD track whose number is 21 or over, or when you select an MP3 file.
- 5 Repeat steps 3 through 4 to program additional tracks or files, up to a total of 25 tracks or files.
- 6 To play your program of tracks or files, press ▶ [9].  
The program remains available until you open the disc tray. To play the same program again, press ▶ [9].

#### To cancel Program Play

Press PLAY MODE [12] repeatedly until “PGM” disappears while the system is stopped.

#### To delete the last track or file of the program

Press CLEAR [19] while the system is stopped.

## Presetting radio stations

You can preset your favorite radio stations and tune them in instantly by selecting the corresponding preset number.

Use buttons on the remote to preset stations.

**1** Tune in the desired station (see “Listening to the radio” (page 14)).

**2** Press TUNER MEMORY .



**3** Press +/–  repeatedly to select your desired preset number.



If another station is already assigned to the selected preset number, the station is replaced by the new stations.

**4** Press .

**5** Repeat steps 1 through 4 to store other stations.

You can preset up to 20 FM and 10 AM stations.

The preset stations are retained for about half a day even if you disconnect the power cord or if a power failure occurs.

**6** To call up a preset radio station, press TUNING MODE  repeatedly until “PRESET” appears, and then press +/–  repeatedly to select the desired preset number.

## Using the Timers

The system offers two timer functions. If you use the Play Timer with the Sleep Timer, the Sleep Timer has priority.

### Sleep Timer:

You can fall asleep to music. This function works even if the clock is not set.

Press SLEEP [26] repeatedly.

If you select "AUTO," the system automatically turns off after the current disc stops or in 100 minutes.

### Play Timer:

You can wake up to CD, tuner or iPod at a preset time.

Use buttons on the remote to control the Play Timer. Make sure you have set the clock.

- 1 Prepare the sound source.  
Prepare the sound source, and then press VOLUME +/- [15] to adjust the volume.  
To start from a specific track or file, create your own program (page 25).
- 2 Press TIMER MENU [20].
- 3 Press  $\uparrow/\downarrow$  [24] repeatedly to select "PLAY SET?," and then press  $\oplus$  [13].  
"ON TIME" appears, and the hour indication flashes.

- 4 Set the time to start playing.  
Press  $\uparrow/\downarrow$  [24] repeatedly to set the hour, and then press  $\oplus$  [13]. The minute indication flashes. Use the procedure above to set the minutes.
- 5 Use the same procedure as in step 4 to set the time to stop playing.
- 6 Select the sound source.  
Press  $\uparrow/\downarrow$  [24] repeatedly until the desired sound source appears, and then press  $\oplus$  [13]. The display shows the timer settings.
- 7 Press I/⏻ [1] to turn off the system.  
The system turns on 15 seconds before the preset time. If the system is on at the preset time, the Play Timer will not play.

### Note

Before the system is turned off, if a connection is made with the Bluetooth headphones, sounds played by the Play Timer may be output to the Bluetooth headphones.

### Note on the iPod touch user

The Play Timer may not be activated depending on the status of the connected iPod touch.

## To activate or check the timer again

- 1 Press TIMER MENU **20**.  
"TIMER SEL?" flashes in the display.
- 2 Press **+** **13**.
- 3 Press **▲/▼** **24** repeatedly to select  
"PLAY SEL?."
- 4 Press **+** **13**.

## To cancel the timer

- 1 Press TIMER MENU **20**.  
"TIMER SEL?" flashes in the display.
- 2 Press **+** **13**.
- 3 Press **▲/▼** **24** repeatedly to select  
"TIMER OFF?."
- 4 Press **+** **13**.

## To change the setting

Start over from step 1.

### Tip

The Play Timer setting remains as long as the setting is not canceled manually.

## Troubleshooting

- 1 Make sure the power cord and speaker cords are correctly and firmly connected.
- 2 Find your problem in the checklist below, and take the indicated corrective action.  
If the issue persists, contact your nearest Sony dealer.

### If the STANDBY indicator flashes

Immediately unplug the power cord, and check the following items.

- If your system has a voltage selector, is the voltage selector set to the correct voltage?
- Are you using only the supplied speakers?
- Is anything blocking the ventilation holes on the top or back of the system?
- Is the iPod connector [10] short-circuited?

After the STANDBY indicator [2] stops flashing, reconnect the power cord, and turn on the system. If the issue persists, contact your nearest Sony dealer.

### Severe hum or noise.

- Move the system away from sources of noise.
- Connect the system to a different wall socket.
- Install a noise filter (available separately) to the power cord.

### There is no sound.

- If the BLUETOOTH indicator [5] is lit or flashing when a function other than the Bluetooth function is selected, no sound is heard through the speakers or PHONES jack [8]. Press and hold BLUETOOTH [4] for about 2 seconds until the BLUETOOTH indicator [5] turns off.

### The remote does not function.

- Remove any obstacles between the remote and the remote sensor [3] on the unit, and position the unit away from fluorescent lights.
- Point the remote at the system's sensor.
- Move the remote closer to the system.

### The STANDBY indicator [2] remains lit after unplugging the power cord.

- The STANDBY indicator [2] may not turn off immediately after unplugging the power cord. This is not a malfunction. The indicator will turn off after about 40 seconds.

## General

### Sound comes from one channel, or the left and right volumes are unbalanced.

- Place the speakers as symmetrically as possible.
- Connect only the supplied speakers.

## CD/MP3 player

---

### The sound skips, or the disc will not play.

- Wipe the disc clean, and replace it.
- Move the system to a location away from vibration (for example, on top of a stable stand).
- Move the speakers away from the system, or place them on separate stands. At high volume, speaker vibration may cause the sound to skip.

### Play does not start from the first track.

- Press PLAY MODE  repeatedly until both "PGM" and "SHUF" disappear to return to normal play.

### Starting playback takes more time than usual.

- The following discs take a longer time to start playback.
  - a disc recorded with a complicated tree structure.
  - a disc recorded in multisession mode.
  - a disc that has not been finalized (a disc to which data can be added).
  - a disc that has many folders.

## Bluetooth device

---

### Pairing cannot be done.

- Move the Bluetooth device closer to the system.
- Pairing may not be possible if other Bluetooth devices are present around the system. In this case, turn off the other Bluetooth devices.
- Enter the same passkey that was entered at the Bluetooth device correctly.

### Connection is not possible.

- The Bluetooth device you attempted to connect does not support the A2DP profile, and cannot be connected with the system.
- Enable the Bluetooth function of the Bluetooth device.
- Establish a connection from the Bluetooth device.
- The pairing registration information has been erased. Perform the pairing operation again.
- While connected to a Bluetooth device, this system cannot be detected and a connection cannot be established from another Bluetooth device.
- Erase the pairing registration information of a Bluetooth device and perform the pairing operation again.

**The sound skips or fluctuates, or the connection is lost.**

- The system and the Bluetooth device are too far apart.
- If there are obstacles between the system and your Bluetooth device, remove or avoid the obstacles.
- If there is equipment that generates electromagnetic radiation, such as a wireless LAN, other Bluetooth device, or a microwave oven nearby, move them away.

**The sound of your Bluetooth device cannot be heard on this system.**

- Turn up the volume on your Bluetooth device first, and then adjust the volume using VOLUME +/- (or VOL +/- on the unit) [15].

**Severe hum or noise**

- If there are obstacles between the system and your Bluetooth device, remove or avoid the obstacles.
- If there is equipment that generates electromagnetic radiation, such as a wireless LAN, other Bluetooth device, or a microwave oven nearby, move them away.
- Turn down the volume of the connected Bluetooth device.

**The sound from the Bluetooth headphones is distorted.**

- Turn down the volume of the system using VOLUME - (or VOL - on the unit) [15]. If your headphones have a volume control, also adjust the volume using the headphone's volume control.
- Press DSGX [17] on the unit repeatedly until "DSGX OFF" appears.
- Press EQ [17] repeatedly to select "BASS" or "TREBLE," and then press - [14] repeatedly to turn down the level.

**iPod****There is no sound.**

- Make sure the iPod is connected securely.
- Make sure the iPod is playing music.
- Adjust the volume.

**The sound is distorted.**

- Turn down the volume.
- Set the "EQ" setting of the iPod to "Off" or "Flat."

**The iPod cannot be charged.**

- Make sure the iPod is connected securely.

## Tuner

---

### Severe hum or noise, or stations cannot be received. ("TUNED" or "STEREO" flashes on the display.)

- Connect the antenna properly.
- Find a location and an orientation that provide good reception, and then set up the antenna again.
- Keep the antennas away from the speaker cords and the power cord to avoid picking up noise.
- Connect a commercially available external antenna.
- Consult your nearest Sony dealer if the supplied AM antenna has come off the plastic stand.
- Turn off nearby electrical equipment.

### To change the AM tuning interval

The AM tuning interval is factory-preset to 9 kHz (or 10 kHz, for some areas). Use buttons on the unit to change the AM tuning interval.

- 1 Tune in any AM station, and then turn off the system.
- 2 While holding down ENTER **[13]**, press I/⏻ **[1]**.  
All the AM preset stations are erased. To reset the interval to the factory preset, repeat the procedure.

### To improve tuner reception

Turn off CD player power by using the CD power management function. By default, CD power is turned on.

- 1 Press FUNCTION +/- (or FUNCTION on the unit) **[9]** repeatedly to select the CD function, and then turn off the system.
- 2 After "STANDBY" stops flashing, press I/⏻ **[1]** on the unit while holding down ■ **[18]** on the unit. "CD POWER OFF" appears. With CD player power turned off, disc access time is increased. To turn on CD player power, repeat the procedure until "CD POWER ON" appears.

### To reset the system to factory settings

If the system still does not operate properly, reset the system to factory settings.

Use buttons on the unit to reset the system to its factory default settings.

- 1 Disconnect and reconnect the power cord, and then turn on the system.
- 2 Press ■ **[18]**, VOL + **[15]** and I/⏻ **[1]** at the same time.  
All user-configured settings, such as preset radio stations, timer, and the clock, are deleted.



## Messages

### CD/MP3 player, Tuner

**CD Over:** You have reached the end of the disc while pressing ►► [14] during playback or pause.

**Complete!:** The preset operation ended normally.

**LOCKED:** The disc tray does not open. Contact your nearest Sony dealer.

**No Disc:** There is no disc in the system, or you have loaded a disc that cannot be played.

**No Step:** All of the programmed tracks or files have been erased.

**Push STOP!:** You pressed PLAY MODE [12] during playback.

**Reading:** The system is reading information of the disc. Some buttons are not available.

**Step Full!:** You tried to program more than 26 tracks or files (steps).

**TIME NG!:** The Play Timer start and end times are set to the same time.

### Bluetooth device

**Connect:** Bluetooth communication was established.

**Connecting:** The system is attempting to connect with recently connected Bluetooth devices.

**Disconnect:** Communication with a Bluetooth device was cut off for some reason, or Bluetooth communication was ended.

**No Device:** A pairable Bluetooth device was not found, or connection was not possible.

**Not in Use:** The system is not connected with a Bluetooth device using A2DP, or the Bluetooth device does not support a command for selecting a folder operations (📁 +/- [14]).

**PIN?:** The system is asking for the passkey. For details, see "Using the Bluetooth function" (page 15).

**Please Wait:** The system is readying for usage of a Bluetooth device.

---

## Precautions

### Discs that this system CAN play

- Audio CD
- CD-R/CD-RW (audio data/MP3 files)

### Discs that this system CANNOT play

- CD-ROM
- CD-R/CD-RW other than those recorded in music CD format or MP3 format conforming to ISO9660 Level 1/Level 2, Joliet or multisession
- CD-R/CD-RW recorded in multisession that have not ended by "closing the session"
- CD-R/CD-RW of poor recording quality, CD-R/CD-RW that have scratches or are dirty, or CD-R/CD-RW recorded with an incompatible recording device
- CD-R/CD-RW which is finalized incorrectly
- Discs containing files other than MPEG 1 Audio Layer-3 (MP3) files
- Discs of non-standard shape (for example, heart, square, star)
- Discs that have adhesive tape, paper, or sticker attached to them
- Rental or used discs with attached seals where the glue extends beyond the seal
- Discs that have labels printed using ink that feels tacky when touched

### Notes on discs

- Before playing, wipe the disc with a cleaning cloth from the center out to the edge.
- Do not clean discs with solvents, such as benzene thinner, or commercially available cleaners or anti-static spray intended for vinyl LPs.
- Do not expose discs to direct sunlight or heat sources such as hot air ducts, nor leave it in a car parked in direct sunlight.

### On safety

- Completely disconnect the power cord (mains lead) from the wall socket (mains) if it is not going to be used for an extended period of time. When unplugging the unit, always grip the plug. Never pull the cord itself.
- Should any solid object or liquid get into the system, unplug the system, and have it checked by qualified personnel before operating it again.
- The AC power cord can be changed only by a qualified service facility.

**On placement**

- Do not place the system in an inclined position or in locations that are extremely hot, cold, dusty, dirty, or humid or lacking adequate ventilation, or subject to vibration, direct sunlight or a bright light.
- Be careful when placing the unit or speakers on surfaces that have been specially treated (for example, with wax, oil, polish) as staining or discoloration of the surface may result.
- If the system is brought directly from a cold to a warm location or is placed in a very damp room, moisture may condense on the lens inside the CD player, and cause the system to malfunction. In this situation, remove the disc, and leave the system turned on for about an hour until the moisture evaporates.

**On heat buildup**

- Heat buildup on the unit during operation is normal and is not cause for alarm.
- Do not touch the cabinet if it has been used continuously at a high volume because the cabinet may have become hot.
- Do not obstruct the ventilation holes.

**On the speaker system**

This speaker system is not magnetically shielded, and the picture on nearby TV sets may become magnetically distorted. In this situation, turn off the TV, wait 15 to 30 minutes, and turn it back on. If there is no improvement, move the speakers far away from the TV.

**Cleaning the cabinet**

Clean this system with a soft cloth slightly moistened with a mild detergent solution. Do not use any type of abrasive pad, scouring powder, or solvent, such as thinner, benzene, or alcohol.

# Specifications

## Main unit (HCD-BX50BTi/Compact Disc Receiver)

### AUDIO POWER SPECIFICATIONS

#### POWER OUTPUT AND TOTAL

#### HARMONIC DISTORTION:

(The United States model only)

With 6 ohm loads, both channels driven, from 120 – 10,000 Hz; rated 25 watts per channel minimum RMS power, with no more than 10% total harmonic distortion from 250 milliwatts to rated output.

## Amplifier section

Continuous RMS power output (reference): 25 + 25 watts (6 ohms at 1 kHz, 10% THD)

### Inputs:

AUDIO IN (stereo mini jack):  
voltage 250 mV, impedance  
47 kilohms

### Outputs:

PHONES (stereo mini jack): accepts  
headphones of 8 ohms or more  
SPEAKER: accepts impedance of  
6 ohms

## Bluetooth section

### Communication system:

Bluetooth Standard version 2.0

### Output:

Bluetooth Standard Power Class 2

### Maximum communication range:

Line of sight approx. 10 m<sup>1)</sup>

### Frequency band:

2.4 GHz band (2.4000 GHz –  
2.4835 GHz)

### Modulation method:

FHSS

### Compatible Bluetooth profiles<sup>2)</sup>:

A2DP (Advanced Audio Distribution  
Profile)  
AVRCP (Audio Video Remote  
Control Profile)

### Supported codecs:

Receive: SBC (Sub Band Codec), MP3

Transmit: SBC (Sub Band Codec)

- <sup>1)</sup> The actual range will vary depending on factors such as obstacles between devices, magnetic fields around a microwave oven, static electricity, reception sensitivity, antenna's performance, operating system, software application, etc.
- <sup>2)</sup> Bluetooth standard profiles indicate the purpose of Bluetooth communication between devices.

## CD player section

System: Compact disc and digital audio system

### Laser Diode Properties

Emission Duration: Continuous

Laser Output\*: Less than 44.6µW

\* This output is the value measurement at a distance of 200mm from the objective lens surface on the Optical Pick-up Block with 7mm aperture.

Frequency response: 20 Hz – 20 kHz

Signal-to-noise ratio: More than 90 dB

Dynamic range: More than 90 dB

## Tuner section

FM stereo, FM/AM superheterodyne tuner

### FM tuner section:

Tuning range:

87.5 – 108.0 MHz (100 kHz step)

Antenna: FM lead antenna

Antenna terminals: 75 ohms unbalanced

Intermediate frequency: 10.7 MHz

### AM tuner section:

Tuning range:

530 – 1,710 kHz (with 10 kHz tuning interval)

531 – 1,710 kHz (with 9 kHz tuning interval)

Antenna: AM loop antenna, external antenna terminal

Intermediate frequency: 450 kHz

## Speaker (SS-CBX20)

Speaker system: Full-range, bass-reflex, 10 cm, cone type

Rated impedance: 6 ohms

Dimensions (w/h/d): Approx. 140 × 245 × 215 mm

Mass: Approx. 1.9 kg

## General

Power requirements: 120 V AC, 60 Hz

Power consumption: 63 watts

Dimensions (w/h/d) (excl. speakers):

Approx. 215 × 140 × 298 mm

Mass (excl. speakers): Approx. 3.9 kg

Supplied accessories: Remote Commander (RM-AMU009) (1), R6 (Size AA) batteries (2), AM loop antenna (1), FM lead antenna (1), iPod Dock Adapters (1 set)

Design and specifications are subject to change without notice.



- Standby power consumption: 0.5 W
- Halogenated flame retardants are not used in the certain printed wiring boards.
- Halogenated flame retardants are not used in cabinets. (Except for the United States model)

---

# Bluetooth wireless technology

Bluetooth wireless technology is a short-range wireless technology linking digital devices, such as personal computers and digital still cameras. Using the Bluetooth wireless technology, you can operate the units involved within a range of about 10 meters.

The Bluetooth wireless technology is commonly used between two devices, but a single device can be connected to multiple devices.

You do not need wires to get connected as you do with a USB connection, and you do not need to place the devices face to face as you do with wireless infrared technology. You can use the technology with one Bluetooth device in your bag or pocket.

Bluetooth wireless technology is a global standard supported by thousands of companies. These companies produce products that meet the global standard.

## Supported Bluetooth version and profiles

Profile refers to a standard set of capabilities for various Bluetooth product capabilities. This system supports the following Bluetooth version and profiles.

Supported Bluetooth version:

Bluetooth Standard version 2.0

Supported Bluetooth profiles:

A2DP (Advanced Audio Distribution Profile)

AVRCP (Audio Video Remote Control Profile)

## Effective communication range

Bluetooth devices should be used within approximately 10 meters (unobstructed distance) of each other. The effective communication range may become shorter under the following conditions.

- When a person, metal object, wall or other obstruction is between the devices with a Bluetooth connection
- Locations where a wireless LAN is installed
- Around microwave ovens that are in use
- Locations where other electromagnetic waves occur

## Effects of other devices

Bluetooth devices and wireless LAN (IEEE 802.11b/g) use the same frequency band (2.4 GHz). When using your Bluetooth device near a device with wireless LAN capability, electromagnetic interference may occur. This could result in lower data transfer rates, noise, or inability to connect. If this happens, try the following remedies:

- Try connecting this system and Bluetooth mobile phone or Bluetooth device when you are at least 10 meters away from the wireless LAN equipment.
- Turn off the power to the wireless LAN equipment when using your Bluetooth device within 10 meters.

## Effects on other devices

The radio waves broadcast by this system may interfere with the operation of some medical devices. Since this interference may result in malfunction, always turn off the power on this system, Bluetooth mobile phone and Bluetooth device in the following locations:

- In hospitals, on trains, in airplanes, at gas stations, and any place where flammable gasses may be present
- Near automatic doors or fire alarms

## Notes

- This system supports security functions that comply with the Bluetooth specification as a means of ensuring security during communication using Bluetooth technology. However, this security may be insufficient depending on the setting contents and other factors, so always be careful when performing communication using Bluetooth technology.
- Sony cannot be held liable in any way for damages or other loss resulting from information leaks during communication using Bluetooth technology.
- Bluetooth communication is not necessarily guaranteed with all Bluetooth devices that have the same profile as this system.
- Bluetooth devices connected with this system must comply with the Bluetooth specification prescribed by the Bluetooth SIG, Inc., and must be certified to comply. However, even when a device complies with the Bluetooth specification, there may be cases where the characteristics or specifications of the Bluetooth device make it impossible to connect, or may result in different control methods, display or operation.
- Noise may occur or the audio may cut off depending on the Bluetooth device connected with this system, the communications environment, or surrounding conditions.

---

## Compatible devices with this system

### Bluetooth devices

You can check the websites below for the Bluetooth compatible devices.

For customers in the U.S.A.:

<<http://www.sony.com/shelfsupport>>

For customers in Canada:

English <[http://www.sony.ca/  
ElectronicsSupport/](http://www.sony.ca/ElectronicsSupport/)>

French <[http://fr.sony.ca/  
ElectronicsSupport/](http://fr.sony.ca/ElectronicsSupport/)>

For customers in Europe:

<<http://support.sony-europe.com/>>

For customers in Latin America:

<<http://www.sony-latin.com/index.crp>>

For customers in Asia and Oceania:

<<http://www.sony-asia.com/support>>



## iPod models

You can use the following iPod models on this system. Update your iPod with the latest software before using it.



iPod touch



iPod nano 3rd generation (video)



iPod classic



iPod nano 2nd generation (aluminum)



iPod 5th generation (video)



iPod nano 1st generation



iPod 4th generation (color display)



iPod 4th generation



iPod mini







## Free Manuals Download Website

<http://myh66.com>

<http://usermanuals.us>

<http://www.somanuals.com>

<http://www.4manuals.cc>

<http://www.manual-lib.com>

<http://www.404manual.com>

<http://www.luxmanual.com>

<http://aubethermostatmanual.com>

Golf course search by state

<http://golfingnear.com>

Email search by domain

<http://emailbydomain.com>

Auto manuals search

<http://auto.somanuals.com>

TV manuals search

<http://tv.somanuals.com>