

Micro Hi-Fi Component System

Operating Instructions

Owner's Record

The model and serial numbers are located on the rear of the unit. Record the serial number in the space provided below. Refer to them whenever you call upon your Sony dealer regarding this product.

Model No. _____ Serial No. _____



***CMT-GPX7
CMT-GPX6
CMT-GPX5***

WARNING

To prevent fire or shock hazard, do not expose the unit to rain or moisture.

To prevent fire, do not cover the ventilation of the apparatus with news papers, table-cloths, curtains, etc. And don't place lighted candles on the apparatus.

To prevent fire or shock hazard, do not place objects filled with liquids, such as vases, on the apparatus.

Do not install the appliance in a confined space, such as a bookcase or built-in cabinet.

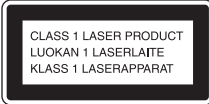

This appliance is classified as a CLASS 1 LASER product. This marking is located on the rear exterior.



Don't throw away the battery with general house waste, dispose of it correctly as chemical waste.

For customers in the United States

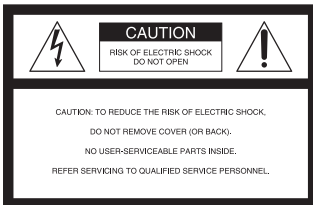

This symbol is intended to alert the user to the presence of uninsulated "dangerous voltage" within the product's enclosure that may be of sufficient magnitude to constitute a risk of electric shock to persons.



This symbol is intended to alert the user to the presence of important operating and maintenance (servicing) instructions in the literature accompanying the appliance.

CAUTION

The use of optical instruments with this product will increase eye hazard.

WARNING

This equipment has been tested and found to comply with the limits for a Class B digital device, pursuant to Part 15 of the FCC Rules. These limits are designed to provide reasonable protection against harmful interference in a residential installation. This equipment generates, uses, and can radiate radio frequency energy and, if not installed and used in accordance with the instructions, may cause harmful interference to radio communications. However, there is no guarantee that interference will not occur in a particular installation. If this equipment does cause harmful interference to radio or television reception, which can be determined by turning the equipment off and on, the user is encouraged to try to correct the interference by one or more of the following measures:

- Reorient or relocate the receiving antenna.
- Increase the separation between the equipment and receiver.
- Connect the equipment into an outlet on a circuit different from that to which the receiver is connected.
- Consult the dealer or an experienced radio/TV technician for help.

CAUTION

You are cautioned that any changes or modification not expressly approved in this manual could void your authority to operate this equipment.

Note to CATV system installer:

This reminder is provided to call the CATV system installer's attention to Article 820-40 of the NEC that provides guidelines for proper grounding and, in particular, specifies that the cable ground shall be connected to the grounding system of the building, as close to the point of cable entry as practical.

For customers in Canada

CAUTION

TO PREVENT ELECTRIC SHOCK, MATCH WIDE BLADE OF PLUG TO WIDE SLOT, FULLY INSERT.

CAUTION

The use of optical instruments with this product will increase eye hazard.

Except for European model



ENERGY STAR[®] is a U.S. registered mark. As an ENERGY STAR[®] partner, Sony Corporation has determined that this product meets the ENERGY STAR[®] guidelines for energy efficiency.

Table of Contents

How to use this manual.....	4
Playable discs.....	4

Getting Started

Hooking up the system.....	6
Setting the clock.....	8

CD/MP3 – Play

Loading a disc.....	8
Playing a disc.....	9
— Normal Play/Shuffle Play	
Playing repeatedly.....	10
— Repeat Play	
Creating your own program.....	11
— Program Play	

Tuner

Presetting radio stations.....	12
Listening to the radio.....	13
— Preset Tuning	
— Manual Tuning	
Using the Radio Data System (RDS)....	14
(European model only)	

Tape – Play

Loading a tape.....	15
Playing a tape.....	15

Tape – Recording

Recording your favorite CD tracks on a tape.....	16
— CD-TAPE Synchro Recording	
Recording on a tape manually.....	17
— Manual Recording	

Sound Adjustment

Adjusting the sound.....	18
--------------------------	----

Timer

Falling asleep to music.....	18
— Sleep Timer	
Waking up to music.....	19
— Play Timer	
Timer recording radio programs.....	20
— Rec Timer	

Display

Turning off the display.....	21
— Power Saving Mode	
Viewing information about the disc in the display.....	21

Optional Components

Hooking up optional components.....	22
-------------------------------------	----

Troubleshooting

Problems and remedies.....	23
Messages.....	25

Additional Information

Precautions.....	27
Specifications.....	28
List of button locations and reference pages.....	31





How to use this manual

This manual mainly explains operations using the remote, but the same operations can also be performed using the buttons on the system having the same or similar names.

Playable discs

You can play back the following discs on this system. Other discs cannot be played back.

List of playable discs

Format of discs	Disc logo
Audio CDs	
CD-R/CD-RW (audio data/MP3 files*)	   

*CMT-GPX7/CMT-GPX6 only

Discs that this system cannot play

- CD-ROMs
- CD-Rs/CD-RWs other than those recorded in the following formats:
 - music CD format
 - MP3 format that conforms to ISO9660*
Level 1/Level 2, Joliet or Multi Session**
- A disc that has a non-standard shape (e.g., card, heart).
- A disc with paper or stickers on it.
- A disc that has the adhesive, cellophane tape, or a sticker still left on it.

* ISO 9660 Format

The most common international standard for the logical format of files and folders on a CD-ROM. There are several specification levels. In Level 1, file names must be in the 8.3 format (no more than eight characters in the name, no more than three characters in the extension “.MP3”) and in capital letters. Folder names can be no longer than eight characters. There can be no more than eight nested folder levels. Level 2 specifications allow file names and folder names up to 31 characters long. Each folder can have up to 8 trees.

For Joliet in the expansion format (file and folder names can have up to 64 characters) make sure of the contents of the writing software, etc.

** Multi Session

This is a recording method that enables adding of data using the Track-At-Once method. Conventional CDs begin at a CD control area called the Lead-in and end at an area called Lead-out. A Multi Session CD is a CD having multiple sessions, with each segment from Lead-in to Lead-out regarded as a single session.

CD-Extra: This format records audio (audio CD data) on the tracks in session 1 and data on the tracks in session 2.

Mixed CD: This format records data on the first track and audio (audio CD data) on the second and subsequent tracks of a session.

Notes on CD-R and CD-RW

- Some CD-Rs or CD-RWs cannot be played on this system depending upon the recording quality or physical condition of the disc, or the characteristics of the recording device. Furthermore, the disc will not play if it has not been correctly finalized. For more information, see the operating instructions for the recording device.
- Discs recorded on CD-R/CD-RW drives may not be played back because of scratches, dirt, recording condition or the driver's characteristics.
- CD-R and CD-RW discs recorded in multi-session that have not ended by "closing the session" are not supported.
- The system may be unable to play MP3 format files that do not have the extension ".MP3".
- Attempting to play non-MP3 format files that have the extension ".MP3" may result in noise or malfunction.
- With formats other than ISO 9660 level 1 and 2, folder names or file names may not be displayed correctly.
- The following discs take a longer time to start playback.
 - a disc recorded with complicated tree structure.
 - a disc recorded in Multi Session.
 - a disc to which data can be added (non-finalized disc).

Music discs encoded with copyright protection technologies

This product is designed to playback discs that conform to the Compact Disc (CD) standard. Recently, various music discs encoded with copyright protection technologies are marketed by some record companies. Please be aware that among those discs, there are some that do not conform to the CD standard and may not be playable by this product.

Cautions when playing a disc that is recorded in Multi Session

- If the disc begins with a CD-DA session, it is recognized as a CD-DA (audio) disc, and MP3 sessions are played back without sound.
- If the disc begins with an MP3 session, it is recognized as an MP3 disc, and CD-DA sessions are played back without sound.
- The playback range of an MP3 disc is determined by the tree structure of files produced by analyzing of the disc.
- A disc with a mixed CD format will be recognized as a CD-DA (audio) disc.

Getting Started

Hooking up the system

Perform the following procedures **1** to **4** to hook up your system using the supplied cords and accessories.

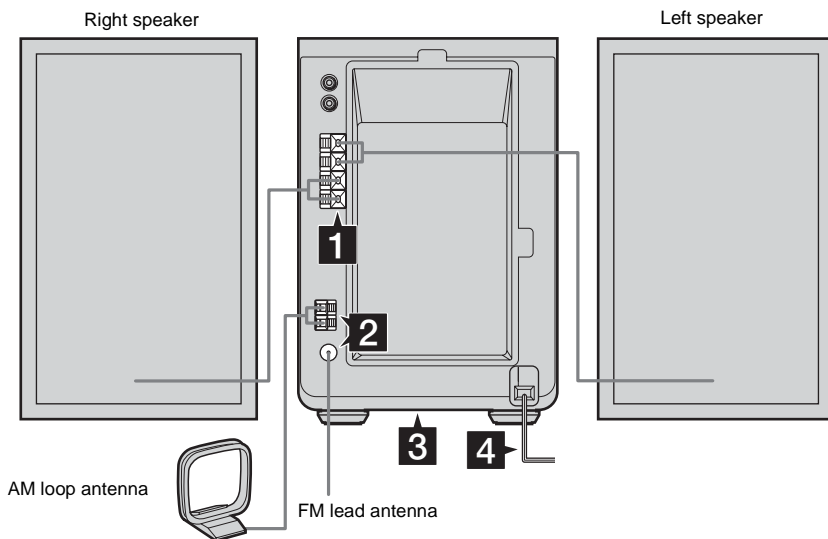

1 Connect the speakers.

Connect the right and left speaker cords to the SPEAKER terminals as shown below.

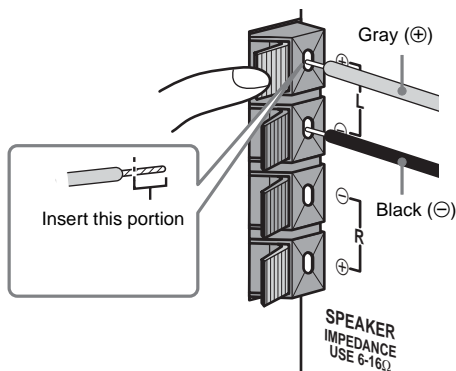

2 Connect the FM and AM antennas.

Set up the AM loop antenna, then connect it.

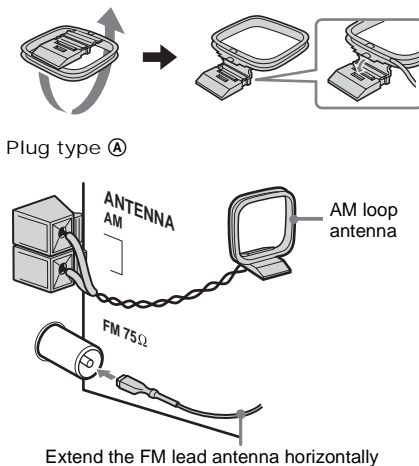

Plug type ②

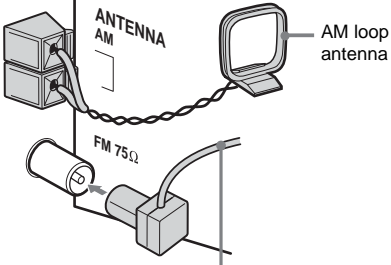

Extend the FM lead antenna horizontally

Plug type ③

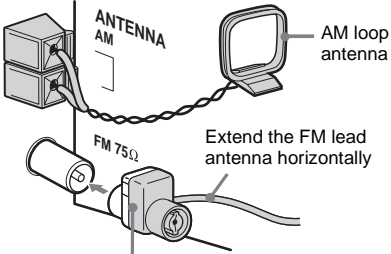

North American models:
Connect using the white side
Other models:
Connect using the brown side

Note

To prevent noise pickup, keep the antennas away from the system and other components.

- 3 For models with a voltage selector, set VOLTAGE SELECTOR to the local power line voltage. The voltage selector is located at the bottom of the apparatus.**

Refer to the print on your system's VOLTAGE SELECTOR for available settings.

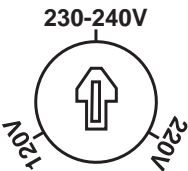

- 4 Connect the power cord to a wall outlet.**

If the plug does not fit the wall socket, detach the supplied plug adaptor (only for models equipped with an adaptor).

To turn on the system, press I/⏻.

Inserting two R6 (size AA) batteries into the remote

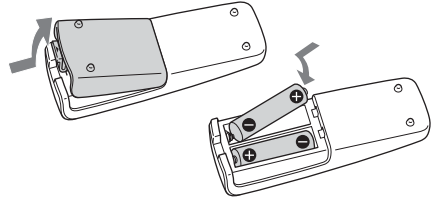

Note

If you do not use the remote for a long period of time, remove the batteries to avoid possible damage from battery leakage and corrosion.

Tip

When the remote no longer operates the system, replace both batteries with new ones.

Setting the clock

Use buttons on the remote for the operation.

- 1 Press I/⏻ to turn on the system.
- 2 Press CLOCK/TIMER SET.
- 3 Press I◀◀/▶▶I repeatedly to set the hour.
- 4 Press ENTER.
- 5 Press I◀◀/▶▶I repeatedly to set the minute.
- 6 Press ENTER.

The clock starts working.

To adjust the clock

- 1 Press CLOCK/TIMER SET.
- 2 Press I◀◀/▶▶I until "CLOCK SET" appears, then press ENTER.
- 3 Do the same procedures as step 3 to 6 above.

Note

The clock is not displayed in Power Saving Mode (page 21).

CD/MP3 – Play

Loading a disc

- 1 Press CD (or FUNCTION repeatedly on the unit) to switch the function to CD.
- 2 Insert a disc in the disc slot with the label side up.

When you play a disc, insert it with the label side up.

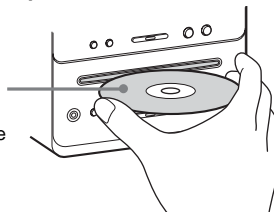

Notes

- **When you turn on the system, the disc is not pulled into the disc slot until "NO DISC" appears in the display. Do not attempt to push in the disc until "NO DISC" appears.**
- Do not use a disc with tape, seals or paste on it as this may cause malfunction.
- Do not use a non-standard shape disc.
- Do not load an 8 cm disc with an adaptor. Doing so may cause the system to malfunction.
- When you eject a disc, handle the disc by its edge. Do not touch the surface.
- If you load a disc that is not playable by this system, it will be ejected automatically.

Playing a disc

— Normal Play/Shuffle Play

You can play audio CDs and discs with MP3 audio tracks.

MP3 audio tracks cannot be played on CMT-GPX5.

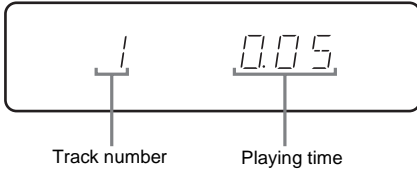

- 1 Press CD (or FUNCTION repeatedly on the unit) to switch the function to CD.**
- 2 Press PLAY MODE in stop mode repeatedly until the mode you want appears.**

Select	To play
No display (Normal Play)	The tracks on the disc in original order.
ALBM (Normal Play)	All MP3 audio tracks in the album on the disc in original order. When playing a non-MP3 disc, Album Play performs the same operation as Normal Play.
SHUF (Shuffle Play)	All tracks on the disc in random order.
ALBM SHUF (Shuffle Play)	All MP3 audio tracks in the album on the disc in random order. When playing a non-MP3 disc, Album Shuffle Play performs the same operation as Shuffle Play.
PGM (Program Play)	The tracks on the disc in the order you want them to be played (see “Creating your own program” on page 11).

- 3 Press ► (or CD/►|| on the unit).**

Other operations

To	Do this
Stop play	Press ■ (CD stop).
Pause	Press (or CD/► on the unit). Press again to resume play.
Select a track	Press ◀◀/▶▶ (or ◀◀◀◀/▶▶▶▶) on the unit except for CMT-GPX5 repeatedly.
Select an album of MP3	Press ALBUM +/- repeatedly after step 2.
Find a point in a track	Keep pressing ◀◀/▶▶ during playback and release it at the desired point.
Remove a disc	Press ⏏ on the unit.

Notes

- You cannot change the play mode during playback.
- Some time may be needed to start playback of discs recorded in complex configurations such as many layers.
- When the disc is inserted, the player reads all the audio tracks on that disc. If there are many albums or non-MP3 audio tracks on the disc, it may take a long time for play to begin or for the next MP3 audio track to start play.
- Do not save unnecessary albums or audio tracks other than MP3 ones in the disc to be used for MP3 listening. We recommend that you do not save other types of audio tracks or unnecessary albums on a disc that has MP3 audio tracks.
- An album that does not include an MP3 audio track is skipped.
- Maximum album number: 150 (including root album and empty albums)
- The maximum number of MP3 audio tracks and albums that can be contained on a single disc is 300.
- Playback is possible up to 8 trees.
- MP3 audio tracks are played back in the order that they are recorded on the disc.
- Depending on the encoding/writing software, recording device or the recording media used at the time an MP3 audio track is recorded, you may encounter such problems as disabled playback, sound interruptions and noise.
- When playing back an MP3 audio track, the playback elapsed time indication may differ from the actual time in the following cases.
 - When you play back a VBR (variable bit rate) MP3 audio track
 - When you perform Fast Forward or Rewind (Manual Search)

Tip

When disc access takes a long time, set “CD POWER” and “ON” by CD power manage function (page 13).

Playing repeatedly

— Repeat Play

You can play all the tracks or a single track on a disc repeatedly.

MP3 audio tracks cannot be played on CMT-GPX5.

Press REPEAT repeatedly during playback until “REP” or “REP 1” appears.

REP: For all tracks (depending on the selected play mode) up to five times or endlessly for MP3 tracks when “SHUF” is displayed.

REP 1: For a single track only.

To cancel Repeat Play

Press REPEAT repeatedly until both “REP” and “REP 1” disappear.

Note

When you select “REP 1”, that track is repeated endlessly until “REP 1” is canceled.

Creating your own program

— Program Play

You can make a program of up to 25 steps.
You can synchro record the programed tracks onto a cassette tape (page 16).
MP3 audio tracks cannot be played on CMT-GPX5.

- 1 Press CD (or FUNCTION repeatedly on the unit) to switch the function to CD.**
- 2 Press PLAY MODE in stop mode repeatedly until “PGM” appears.**
- 3 Press ◀◀/▶▶ (or ◀◀◀/▶▶▶▶) on the unit except for CMT-GPX5) repeatedly until the desired track number appears.**

When programing an MP3, press ALBUM +/- repeatedly to select the album, then press ◀◀/▶▶ (or ◀◀◀/▶▶▶▶) on the unit except for CMT-GPX5) repeatedly until the desired track number appears.

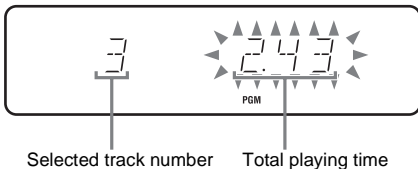

- 4 Press ENTER.**
The track is programed.
The program step number appears, followed by the last programed track number.
- 5 To program additional tracks, repeat steps 3 and 4.**
- 6 Press ▶ (or CD/▶▶ on the unit).**
Program Play starts.

Other operations

To	Do this
Cancel Program Play	Press PLAY MODE in stop mode repeatedly until both “PGM” and “SHUF” disappears.
Erase the program	Press CLEAR in step 4. Each time you press the button, a track is cleared from the end of the program.
Add a track to the end of the program	Perform steps 3 and 4 in stop mode.

Tips

- The program you made remains after Program Play finishes. To play the same program again, press ▶ (or CD/▶▶ on the unit). However, the program is cleared when you eject the disc.
- “- - -” appears if the total program time exceeds 100 minutes, if you select a track whose number is 21 or over, or when you programed an MP3 audio track.
- If you select “AL” in step 3, you can select all tracks on the disc at once. If you select an album in step 3, you can select all MP3 audio tracks in the album at once.

Tuner

Presetting radio stations

You can preset up to 20 FM stations and 10 AM stations. You can then tune in any of those stations simply by selecting the corresponding preset number.

Automatic tuning preset

You can automatically tune in all of the stations that can be received in your area and then store the radio frequency of the desired stations.

- 1 Press TUNER/BAND repeatedly to select “FM” or “AM”.**
- 2 Press TUNING MODE repeatedly until “AUTO” appears in the display.**
- 3 Press +/- (or TUNING +/- on the unit).**
The frequency changes as the system scans for a station. Scanning stops automatically when a station is tuned in. At that time, “TUNED” and “STEREO” (for stereo program only) appear.

If “TUNED” does not appear and the scanning does not stop

Set the frequency of the desired radio station as described in steps 2 and 3 of “Manual tuning preset” (page 12).

- 4 Press TUNER MEMORY.**
A preset number flashes. Perform steps 5 and 6 while the preset number flashes.

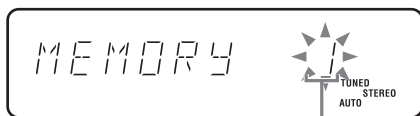

Preset number

- 5 Press +/- (or TUNING +/- on the unit) repeatedly to select the desired preset number.**
- 6 Press TUNER MEMORY.**
- 7 Repeat steps 3 through 6 to preset other stations.**

Tip

Press TUNING MODE to stop scanning.

Manual tuning preset

You can manually tune in and store the radio frequency of the desired stations.

- 1 Press TUNER/BAND repeatedly to select “FM” or “AM”.**
- 2 Press TUNING MODE repeatedly until “AUTO” and “PRESET” disappear from the display.**
- 3 Press +/- (or TUNING +/- on the unit) repeatedly to tune in the desired station.**
- 4 Press TUNER MEMORY.**
- 5 Press +/- (or TUNING +/- on the unit) repeatedly to select the desired preset number.**
- 6 Press TUNER MEMORY.**
- 7 Repeat steps 3 through 6 to preset other stations.**

Other Operations

To	Do this
Tune in a station with a weak signal	Follow the procedure described in “Manual tuning preset” (page 12).
Set another station to the existing preset number	After step 4, press +/- (or TUNING +/- on the unit) repeatedly to select the preset number you want to store the station.

To change the AM tuning interval (Except for European model)

The AM tuning interval is factory-preset to 9 kHz (or 10 kHz for some areas). To change the AM tuning interval, tune into any AM station first, then turn off the power by pressing I/⏻. While holding TUNING +, press I/⏻.

When you change the interval, all AM preset stations are erased. To reset the interval, repeat the above procedure.

To improve tuner reception

When tuner reception is poor, set CD player power off by the CD power manage function. CD power is factory set to on.

- 1 Press FUNCTION repeatedly to switch the function to CD.
- 2 Press I/⏻ to turn off the system.
- 3 Press I/⏻ on the unit while holding ■ (CD stop) on the unit.
“CD POWER” and “OFF” appear.

To set the CD power on

Repeat the procedure above, and “CD POWER” and “ON” appear.

Notes

- When “CD POWER” and “OFF” are selected, CD access time is increased.
- In the Power Saving Mode, switching the CD power on or off using the CD power manage function is not possible.

Tips

- The preset stations are retained for about half a day even if you disconnect the power cord or if a power failure occurs.
- To improve the reception, adjust the supplied antennas or connect an external antenna.

Listening to the radio

You can listen to a radio station either by selecting a preset station, or by manually tuning in the station.

Listening to a preset station

— *Preset Tuning*

Preset radio stations in the tuner’s memory first (see “Presetting radio stations” on page 12).

- 1 Press TUNER/BAND repeatedly to select “FM” or “AM”.
- 2 Press TUNING MODE repeatedly until “PRESET” appears in the display.
- 3 Press +/- (or TUNING +/- on the unit) repeatedly to select the desired preset station.

Listening to non-preset radio station

— *Manual Tuning*

- 1 Press TUNER/BAND repeatedly to select “FM” or “AM”.
- 2 Press TUNING MODE repeatedly until “AUTO” and “PRESET” disappear from the display.
- 3 Press +/- (or TUNING +/- on the unit) repeatedly to tune in the desired station.

continued

Tips

- To improve broadcast reception, adjust the supplied antennas, or connect a commercially available external antenna.
- When an FM stereo program has static noise, press FM MODE until "MONO" appears. There will be no stereo effect, but the reception will improve.
- Press TUNING MODE repeatedly until "AUTO" appears in step 2 above, then press +/- (or TUNING +/- on the unit). The frequency indication changes and scanning stops when the system tunes in a station (Automatic Tuning).
- To record the radio programs, use manual recording (page 17).

Using the Radio Data System (RDS)

(European model only)

What is the Radio Data System?

Radio Data System (RDS) is a broadcasting service that allows radio stations to send additional information along with the regular program signal. RDS is available only on FM stations.*

Note

RDS may not work properly if the station you are tuned in is not transmitting the RDS signal properly or if the signal is weak.

* Not all FM stations provide RDS service, nor do they provide the same types of services. If you are not familiar with the RDS system, check with your local radio stations for details on RDS services in your area.

Receiving RDS broadcasts

Simply select a station from the FM band.

When you tune in a station that provides RDS services, the station name appears in the display.

To check the RDS information

Each time you press DISPLAY the display changes cyclically as follows:

Station name* → Frequency → Clock display
→ Bass level → Treble level

* If the RDS broadcast is not properly received, the station name may not appear in the display.

Loading a tape

- 1 Press \triangle PUSH EJECT on the unit.
- 2 Load a tape into the cassette holder.

With the side you want to play/record facing up.

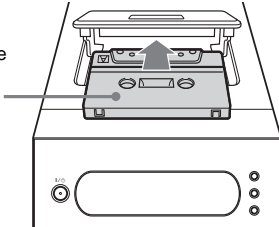

Playing a tape

You can use TYPE I (normal).

- 1 Press TAPE (or FUNCTION repeatedly) to switch the function to TAPE.
- 2 Press DIRECTION on the unit repeatedly to select “ \rightleftarrows ” to play one side of a tape, “ \leftrightarrow ” to play both sides, or “ \leftleftarrows ” to play both sides repeatedly.
 * The tape deck stops automatically after repeating the sequence five times.
- 3 Press \blacktriangleright (or TAPE/ $\blacktriangleleft\blacktriangleright$ on the unit). Press \blacktriangleright (or TAPE/ $\blacktriangleleft\blacktriangleright$ on the unit) again to play the reverse side.

Other operations

To	Do this
Stop play	Press \blacksquare (TAPE stop).
Pause	Press \mathbb{I} . Press again to resume play.
Fast-forward or rewind	Press $\blacktriangleleft/\blacktriangleright$.
Remove a tape	Press \triangle PUSH EJECT on the unit in stop mode.

Recording your favorite CD tracks on a tape

— CD-TAPE Synchro Recording

You can record a whole CD on a tape.

You can use TYPE I (normal).

Use buttons on the unit for the operation.

1 Load a recordable tape.

2 Load a CD you want to record.

When you want to record an album from an MP3 disc, be sure to press PLAY MODE to select ALBM, then use ALBUM +/- to select the desired album before proceeding.

3 Press CD SYNCHRO on the unit.

“SYNC”, “REC” and “▶” (or “◀”) appear.

The tape deck stands by for recording and the CD player pauses for playback.

4 Press DIRECTION repeatedly to select “→” to record on one side or “↔” (or “↔”) to record on both sides.

5 Press TAPE/◀▶ repeatedly to select the recording side.

If you select both sides recording or front side recording, press TAPE/◀▶ until “▶” appears. If you record on the reverse side, press TAPE/◀▶ again until “◀” appears.

6 Press ● REC PAUSE/START.

Recording starts.

When the recording is completed, the CD player and the tape deck stop automatically.

To stop recording

Press ■.

To record a disc by specifying track order

You can record only your favorite CD tracks using Program Play. Between steps 2 and 3, perform steps 1 to 5 of “Creating your own program” (page 11).

Tip

If you select both sides recording and the tape reaches the end of the front side part-way through a track, the entire track is recorded again from the beginning of the reverse side.

Recording on a tape manually

— Manual Recording

You can record just the portions you like from a CD on a tape.

You can also record a radio program.

Use buttons on the unit for the operation.

- 1 Load a recordable tape.**
- 2 Select the desired source to record.**
 - TUNER: To record from this system's tuner.
 - CD: To record from this system's CD player.
 - MD or VIDEO: To record from the optional component connected to the MD/VIDEO jacks.
- 3 Press ● REC PAUSE/START.**

“REC” flashes and “▶” appears and the tape deck stands by for recording.
- 4 Press DIRECTION repeatedly to select “→” to record on one side or “↔” (or “↔↔”) to record on both sides.**
- 5 Press TAPE/◀▶ repeatedly to select the recording side.**

If you select both sides recording or front side recording, press TAPE/◀▶ until “▶” appears. If you record on the reverse side, press TAPE/◀▶ again until “◀” appears.
- 6 Press ● REC PAUSE/START, then start playing the desired source to record.**

Recording starts.

Other operations

To	Do this
Stop recording	Press ■ (TAPE stop).
Pause recording	Press ● REC PAUSE/START.

Tip

For recording from a CD, you can press ◀▶/▶▶ (or ◀◀◀/▶▶▶▶) on the unit except for CMT-GPX5) to select tracks during recording pause mode (after step 3 and before step 5).

Note

When you record on both sides, be sure to start from the front side. If you start from the reverse side, recording stops at the end of the reverse side.

Adjusting the sound

You can adjust the bass and treble to enjoy more powerful sound.

Generating a more dynamic sound (Dynamic Sound Generator X-tra)

Press DSGX on the unit.

To cancel the DSGX, press DSGX on the unit again.

Adjusting the bass and treble

You can adjust the bass and treble.

- 1 Press EQ to select "BASS" or "TREBLE".**
- 2 Press ◀◀/▶▶ repeatedly to adjust the level while "BASS" or "TREBLE" appears.**

Tip

You can also adjust the bass and treble levels by turning BASS +/- or TREBLE +/- on the unit.

Falling asleep to music

— Sleep Timer

You can set the system to turn off after a certain time, so that you can fall asleep to music. Use buttons on the remote for the operation.

Press SLEEP repeatedly.

Each time you press the button, the minute display (the turn-off time) changes cyclically as follows:

AUTO* → 90MIN → 80MIN → ... → 10MIN → SLEEP OFF

* The system automatically turns off in 100 minutes or after the current CD or tape finishes playing.

Other operations

To	Press
Check the remaining time**	SLEEP once.
Change the time to turn off	SLEEP repeatedly to select the time you want.
Cancel the Sleep Timer function	SLEEP repeatedly until "OFF" appears.

** You cannot check the remaining time if you select "AUTO".

Tip

You can use Sleep Timer, even if you have not set the clock.

Waking up to music

— Play Timer

You can wake up to music at a preset time. Make sure you have set the clock (see “Setting the clock” on page 8).

Use buttons on the remote for the operation.

1 Prepare the sound source you want to play.

- CD: Load a disc. To start from a specific track, make a program (see “Creating your own program” on page 11).
- TAPE: Load a tape (see “Playing a tape” on page 15).
- TUNER: Tune in a radio station (see “Listening to the radio” on page 13).

2 Adjust the volume.

3 Press CLOCK/TIMER SET.

4 Press ◀◀/▶▶ repeatedly until “PLAY SET” appears, then press ENTER.

“ON” appears and the hour indication flashes.

5 Set the time to start playing.

Press ◀◀/▶▶ repeatedly to set the hour, then press ENTER.

The minute indication flashes.

Press ◀◀/▶▶ repeatedly to set the minute, then press ENTER.

6 Set the time to stop playing following the same procedure as step 5.

7 Press ◀◀/▶▶ repeatedly until the desired sound source appears.

Each time you press the button, the display changes cyclically as follows:

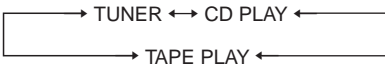

8 Press ENTER.

The start time, the stop time, and the sound source appear in turn, then the original display returns.

9 Press I/⏻ to turn off the system.

Other operations

To	Do this
Check the setting	<ol style="list-style-type: none">1 Press CLOCK/TIMER SELECT.2 Press ◀◀/▶▶ repeatedly until “PLAY SEL” appears, then press ENTER.
Change the setting	Start over from step 1.
Cancel the timer	<ol style="list-style-type: none">1 Press CLOCK/TIMER SELECT.2 Press ◀◀/▶▶ repeatedly until “TIMER OFF” appears, then press ENTER.

Notes

- If you use Play Timer and Sleep Timer at the same time, Sleep Timer has priority.
- Do not operate the system from the time the system turns on until the play starts (about 15 seconds before the preset time).
- If the system is on about 15 seconds before the preset time, Play Timer will not be activated.
- You cannot use the optional component connected to the MD/VIDEO jacks as sound sources for Play Timer.
- You cannot activate Play Timer and Rec Timer simultaneously.

Timer recording radio programs

— Rec Timer

To timer record, you must first preset the radio station (see “Presetting radio stations” on page 12) and set the clock (see “Setting the clock” on page 8).

Use buttons on the remote for the operation.

- 1 Tune in the preset radio station (see “Listening to a preset station” on page 13).**
- 2 Press CLOCK/TIMER SET.**
- 3 Press ◀◀/▶▶ repeatedly until “REC SET” appears, then press ENTER.**
“ON” appears and the hour indication flashes.
- 4 Set the time to start recording.**
Press ◀◀/▶▶ repeatedly to set the hour, then press ENTER.
The minute indication flashes.
Press ◀◀/▶▶ repeatedly to set the minute, then press ENTER.
- 5 Set the time to stop recording following the same procedure as step 4.**
Rec Timer settings and the desired station appear, then the original display returns.
- 6 Load a recordable tape.**
- 7 Press DIRECTION on the unit repeatedly to select “↔” to record on one side or “↔” (or “↔”) to record on both sides.**
- 8 Press ▶ (or TAPE/◀▶ on the unit) repeatedly to select the recording side.**
If you select both sides recording or front side recording, press ▶ (or TAPE/◀▶ on the unit) until “▶” appears. If you record on the reverse side, press ▶ (or TAPE/◀▶ on the unit) again until “◀” appears.
- 9 Press I/⏻ to turn off the system.**

Other operations

To	Do this
Check the setting	<ol style="list-style-type: none"> 1 Press CLOCK/TIMER SELECT. 2 Press ◀◀/▶▶ repeatedly until “REC SEL” appears, then press ENTER.
Change the setting	Start over from step 1.
Cancel the timer	<ol style="list-style-type: none"> 1 Press CLOCK/TIMER SELECT. 2 Press ◀◀/▶▶ repeatedly until “TIMER OFF” appears, then press ENTER.

Notes

- If you use Rec Timer and Sleep Timer at the same time, Sleep Timer has priority.
- Do not operate the system from the time the system turns on until the recording starts (about 15 seconds before the preset time).
- If the system is on about 15 seconds before the preset time, Rec Timer will not be activated.
- The volume is reduced to minimum during recording.
- Note that if Rec Timer is set at the same time as Play Timer sound source is set to tape, Rec Timer sound may be recorded onto the tape.
- You cannot activate Play Timer and Rec Timer simultaneously.

Turning off the display

— Power Saving Mode

The clock display can be turned off to minimize the amount of power consumed during standby (Power Saving Mode).

Press DISPLAY repeatedly while the system is off until the clock display disappears.

To cancel Power Saving Mode

Press DISPLAY while the system is off. Each time you press the button, the display switches as follows:

Clock display* ↔ No display (Power Saving Mode)

* The clock is displayed only if you set the clock.

Tips

- The I/⏻ indicator lights up even in Power Saving Mode.
- The timer continues to operate in Power Saving Mode.

Note

You cannot perform the following operations in Power Saving Mode.

- setting the clock
- switching the MD/VIDEO function
- switching the CD power on or off using the CD power manage function
- changing the AM tuning interval

Viewing information about the disc in the display

You can check the playing time and remaining time of the current track or that of the disc. When a disc with MP3 audio tracks is loaded, you can also check the information recorded on disc, such as the titles.

Checking the remaining time and titles (CD/MP3)

Press DISPLAY repeatedly during playback.

Each time you press the button, the display changes cyclically as follows:

Current track number and elapsed playing time → Current track number and remaining time or “_ _ _ _”* → Remaining time of the disc or “_ _ _ _”* → Track title (disc with MP3 audio tracks** only) → Album name* → Clock display → Bass level → Treble level

* For discs with MP3 audio tracks

** When you play back a track with an ID3 tag ver. 1 (ver. 1.0 or 1.1), the ID3 tag appears. The ID3 tag displays only the track title information.

Checking the total playing time and titles (CD/MP3)

Press DISPLAY repeatedly in stop mode.

Each time you press the button, the display changes cyclically as follows:

TOC display* or total number of albums on the disc** or total track number of the current album** → Disc name** → Clock display → Bass level → Treble level

* TOC = Table of Contents; displays total number of tracks on the disc and total playing time of the disc.

** For discs with MP3 audio tracks, album titles may not be displayed depending on the play mode.

Hooking up optional components

To enhance your system, you can connect optional components. Refer to the operating instructions provided with each component.

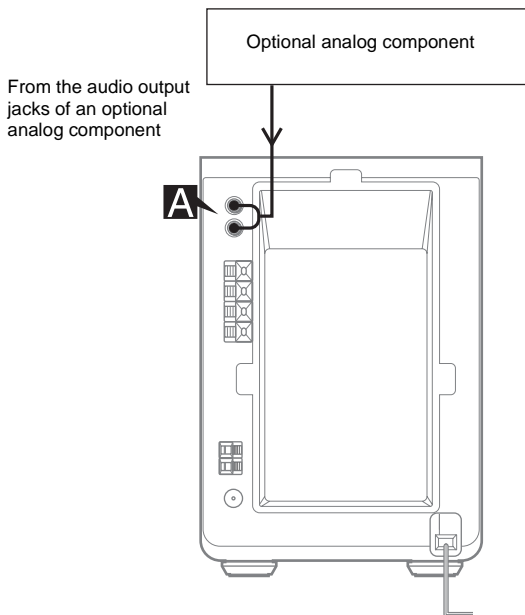

A MD/VIDEO jacks

Use audio cords (not supplied) to connect an optional analog component (MD deck, etc.) to these jacks. You can then listen to the sound from the component.

Listening to audio from a connected component

- 1 Connect audio cords.
See the illustration above.
- 2 Press **FUNCTION** repeatedly until "MD" or "VIDEO" appears.
Start playing the connected component.

Tip

If you cannot select "VIDEO" by pressing **FUNCTION** repeatedly, turn off the system and then press **I/⏻** on the unit while holding down **FUNCTION** on the unit. The function will change from "MD" to "VIDEO", and "VIDEO" will appear in the display. To change back to "MD", repeat the same procedure. However, you cannot switch the MD/VIDEO function in Power Saving Mode.

Problems and remedies

Should you encounter a problem with your system, do the following:

- 1 Make sure the power cord and speaker cords are correctly and firmly connected.
- 2 Find your problem in the troubleshooting checklist below and take the indicated corrective action.

If the problem persists after doing all of the above, consult your nearest Sony dealer.

When the I/⏻ indicator flashes

Immediately unplug the power cord and check the following items.

- If your system has a voltage selector, is the voltage selector set to the correct voltage? Check the voltage for your region, then make sure the voltage selector is set correctly.
- Are the + and – speaker cords short-circuited?
- Are you using the supplied speakers?
- Is anything blocking the ventilation holes on the rear of the system?

Check all the above items and fix any problems found. After I/⏻ indicator stops flashing, reconnect the power cord and turn on the system. If the indicator still flashes, or if the cause of the problem cannot be found even after checking all the above items, consult your nearest Sony dealer.

General

“-- --” appears in the display.

- A power interruption has occurred. Set the clock (page 8) and timer settings (pages 19 and 20) again.

There is no sound.

- Press VOLUME + on the remote repeatedly (or turn VOLUME on the unit clockwise).
- Make sure the headphones are not connected.
- Check the speaker connections (page 6).

Sound comes from one channel, or unbalanced left and right volume.

- Place the speakers as symmetrically as possible.
- Connect the supplied speakers.

There is severe hum or noise.

- Move the system away from the source of noise.
- Connect the system to a different wall outlet.
- Install a noise filter (commercially available) to the power line.

The timer cannot be set.

- Set the clock again (page 8).

The timer does not function.

- Press CLOCK/TIMER SELECT on the remote to set the timer and light up “⏻ PLAY” or “⏻ REC” in the display (pages 19 and 20).
- Check the timer setting and set the correct time (pages 19 and 20).
- Cancel the Sleep Timer function (page 18).
- Make sure the clock is correctly set.

The color on the TV screen is irregular.

- Move the speakers farther away from the TV set.

The remote does not function.

- Remove the obstacle.
- Move the remote closer to the system.
- Point the remote at the system’s sensor.
- Replace the batteries (R6/size AA).
- Locate the system away from the fluorescent light.

Speakers

Sound comes from one channel, or the left and right volumes are unbalanced.

- Check the speaker connections and placement.

CD/MP3 player

“LOCKED” appears.

- Contact your Sony dealer or local authorized Sony service facility.

Play does not start.

- Eject the disc and check whether a disc is loaded.
- Wipe the disc clean (page 27).
- Replace the disc.
- Load the disc that this system can play (page 4).
- Load the disc correctly.
- Load the disc with the label side up.
- Remove the disc and wipe away the moisture on the disc, then leave the system turned on for a few hours until the moisture evaporates.
- Press ► (or CD/►|| on the unit) to start play.

Disc access takes a long time.

- Set “CD POWER” and “ON” by the CD power manage function (page 13).

The sound skips.

- Wipe the disc clean (page 27).
- Replace the disc.
- Try moving the system to a place without vibration (e.g., on top of a stable stand).
- Try moving the speakers away from the system, or placing them on separate stands. When you listen to a track with bass sounds at high volume, the speaker vibration may cause the sound to skip.

Play does not start from the first track.

- Press PLAY MODE repeatedly until both “PGM” and “SHUF” disappear to return to Normal Play.

MP3 audio track cannot be played back.

- CMT-GPX5 does not play MP3 audio.
- Recording was not performed according to the ISO 9660 level 1 or level 2 format, or Joliet in the expansion format.
- The MP3 audio track does not have the extension “.MP3”.
- The data is not stored in MP3 format.
- Discs containing tracks other than MPEG1, 2 Audio Layer-3 files cannot be played.

MP3 audio tracks take longer to play back than others.

- After the system reads all tracks on the discs, playback may take more time than usual if:
 - the number of albums or tracks on the disc is very large.
 - the album and track organization structure is very complex.

The album title, track title and ID3 tag do not appear correctly.

- Use a disc that conforms with ISO 9660 level 1, level 2, or Joliet in the expansion format.
- The disc ID3 tag is not ver. 1 (ver. 1.0 or 1.1).

Tuner

Severe hum or noise/stations cannot be received.

- Set the proper band and frequency (page 12).
- Connect the antenna properly (page 6).
- Find a place and an orientation that provide good reception, then set up the antenna again. If you cannot obtain good reception, we recommend you connect a commercially available external antenna.
- The supplied FM lead antenna receives signals along its entire length, so make sure you extend it fully.
- Keep the antennas away from the system and other components.
- Consult your nearest Sony dealer if the supplied AM antenna has come off the plastic stand.
- Try turning off surrounding electrical equipment.
- Set “CD POWER” and “OFF” by the CD power manage function (page 13).

A stereo FM program cannot be received in stereo.

- Press FM MODE until “MONO” disappears in the display.

Tape deck

The tape does not record or play, or there is a decrease in sound level.

- The heads are dirty. Clean them (page 28).
- The record/playback heads are magnetized. Demagnetize them (page 28).

The tape does not erase completely.

- The record/playback heads are magnetized. Demagnetize them (page 28).

There is excessive wow or flutter, or the sound drops out.

- The capstans in the tape deck are dirty. Clean them using a cleaning cassette (page 28).

Noise increases or the high frequencies are erased.

- The record/playback heads are magnetized. Demagnetize them (page 28).

The tape does not record.

- No cassette is loaded. Load a cassette.
- The tab has been removed from the cassette. Cover the broken tab with adhesive tape (page 28).
- The tape has wound to the end.

Optional components

There is no sound.

- Refer to General item “There is no sound.” (page 23) and check the condition of the system.
 - Connect the component properly (page 22) while checking:
 - if the cords are connected properly.
 - if the cord plugs are firmly inserted all the way.
 - Turn on the connected component.
 - Refer to the operating instructions supplied with the connected component and start playing.
 - Press FUNCTION repeatedly until “MD” or “VIDEO” appears (page 22).
-

The sound is distorted.

- Set the volume of the connected component lower.
-

If the system still does not operate properly after performing the above measures, reset the system as follows:

Use buttons on the unit for the operation.

- 1 Disconnect the power cord.
- 2 Reconnect the power cord.
- 3 Press I/⏻ to turn on the system.
- 4 Press ■ (CD stop), DSGX and I/⏻ at the same time.

The system is reset to the factory settings. You should set the settings you made, such as the preset stations, clock, and timer.

Messages

One of the following messages may appear or flash in the display during operation.

CD/MP3

NO DISC

There is no disc in the player.

NO STEP

All of the programmed tracks have been erased.

CD OVER

You have reached the end of the disc while pressing and holding ►► during playback or pause.

STEP FULL

You tried to program 26 or more tracks (steps).

PUSH STOP

You pressed PLAY MODE during playback.

Tuner

COMPLETE

The preset operation ended normally.

Tape

NO TAB

You cannot record the tape because the tab has been removed from the cassette.

NO TAPE

There is no tape in the tape deck.

Timer

SET TIMER

You cannot select the timer function when Play Timer or Rec Timer are not set.

TIME NG

Play Timer or Rec Timer start and end times are set to the same time.

PUSH SELECT

You tried to set the clock or timer during timer operation.

SET CLOCK

You tried to select the timer with the clock not set.

Other

INVALID

You pressed an invalid button.

Precautions

On operating voltage

- Before operating the system, check that the operating voltage of your system is identical with the voltage of your local power supply.
- The voltage selector is located at the bottom of the apparatus.

On safety

- The unit is not disconnected from the AC power source (mains) as long as it is connected to the wall outlet, even if the unit itself has been turned off.
- Unplug the system from the wall outlet (mains) if it is not to be used for an extended period of time. To disconnect the power cord (mains lead), pull it out by the plug. Never pull the cord itself.
- Should any solid object or liquid fall into the system, unplug the system and have it checked by qualified personnel before operating it any further.
- AC power cord must be changed only at the qualified service shop.

On placement

- Do not place the system in an inclined position.
- Do not place the system in locations where it is;
 - Extremely hot or cold
 - Dusty or dirty
 - Very humid
 - Subject to vibrations
 - Subject to direct sunlight.
- Use caution when placing the unit or speakers on surfaces that have been specially treated (with wax, oil, polish, etc.) as staining or discoloration of the surface may result.

On heat buildup

- Although the system heats up during operation, this is not a malfunction.
- Place the system in a location with adequate ventilation to prevent heat build-up in the system.
- If you continuously use this system at a high volume, the cabinet temperature of the top, side and bottom rises considerably. To avoid burning yourself, do not touch the cabinet.
- To prevent a malfunction, do not cover the ventilation hole.

On operation

- If the system is brought directly from a cold to a warm location, or is placed in a very damp room, moisture may condense on the lens inside the CD player. Should this occur, the system will not operate properly. Remove the disc and leave the system turned on for about an hour until the moisture evaporates.
- When you move the system, take out any disc.

If you have any questions or problems concerning your system, please consult your nearest Sony dealer.

Notes on discs

- Before playing, clean the disc with a cleaning cloth. Wipe the disc from the center out.
- Do not use solvents such as benzene, thinner, commercially available cleaners or anti-static spray intended for vinyl LPs.
- Do not expose the disc to direct sunlight or heat sources such as hot air ducts, nor leave it in a car parked in direct sunlight.
- Do not use discs encircled with a protection ring. This may cause a malfunction to the system.
- When using discs that have glue or similar tacky substance on the label side of the disc or that used a special ink when the label was printed, there is a chance that the disc or label may become attached to parts inside this unit. When this occurs, it may not be possible to remove the disc, and may also cause this unit to malfunction. Be sure to check that the label side of the disc is not sticky before using.
The following types of disc should not be used:
 - Rental or used discs with attached seals where the glue extends beyond the seal. The perimeter of the seal on the disc is tacky.
 - Discs that have labels printed using a special ink that feels tacky when touched.
- Discs with non-standard shapes (e.g., heart, square, star) cannot be played on this unit. Attempting to do so may damage the unit. Do not use such discs.

Cleaning the cabinet

Clean the cabinet, panel and controls with a soft cloth slightly moistened with mild detergent solution. Do not use any type of abrasive pad, scouring powder or solvent such as thinner, benzene or alcohol.

To save a tape permanently

To prevent a tape from being accidentally recorded over, break off the cassette tab from side A or B as illustrated.

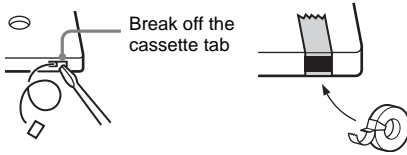

If you later want to reuse the tape for recording, cover the broken tab with adhesive tape.

Before placing a cassette in the tape deck

Take up any slack in the tape. Otherwise, the tape may get entangled in the parts of the tape deck and become damaged.

When using a tape longer than 90 minutes

The tape is very elastic. Do not change the tape operations such as play, stop, and fast-winding frequently. The tape may get entangled in the tape deck.

Cleaning the tape heads

Clean the tape heads after every 10 hours of use. Be sure to clean the tape heads before you start an important recording or after playing an old tape. Use a separately sold dry-type or wet-type cleaning cassette. For details, refer to the instructions of the cleaning cassette.

Demagnetizing the tape heads

Demagnetize the tape heads and the metal parts that have contact with the tape after every 20 to 30 hours of use with a separately sold demagnetizing cassette. For details, refer to the instructions of the demagnetizing cassette.

Specifications

AUDIO POWER SPECIFICATIONS

POWER OUTPUT AND TOTAL HARMONIC DISTORTION:
(The United States model only)

With 6 ohm loads, both channels driven, from 120-10,000 Hz; rated 35 watts per channel minimum RMS power, with no more than 10% total harmonic distortion from 250 milliwatts to rated output.

Main unit (HCD-GPX7/HCD-GPX6/HCD-GPX5)

Amplifier section

HCD-GPX7 for CMT-GPX7

Argentine model:

DIN power output (rated): 40 + 40 W (6 ohms at 1 kHz, DIN)

Continuous RMS power output (reference):
55 + 55 W (6 ohms at 1 kHz, 10% THD)

Music power output (reference):
100 + 100 W

Other models:

DIN power output (rated): 40 + 40 W (6 ohms at 1 kHz, DIN)

Continuous RMS power output (reference):
60 + 60 W (6 ohms at 1 kHz, 10% THD)

Music power output (reference):
100 + 100 W

HCD-GPX6 for CMT-GPX6

North American model:

Continuous RMS power output (reference):
40 + 40 W
(6 ohms at 1 kHz, 10% THD)

Other models:

The following measured at AC 240 V, AC 220 V or AC 120 V

DIN power output (rated): 30 + 30 W
(6 ohms at 1 kHz, DIN)

Continuous RMS power output (reference):
35 + 35 W
(6 ohms at 1 kHz, 10% THD)

HCD-GPX5 for CMT-GPX5

UK model:

DIN power output (rated): 40 + 40 W (6 ohms at 1 kHz, DIN)

Continuous RMS power output (reference):
50 + 50 W (6 ohms at 1 kHz, 10% THD)

Music power output (reference):
90 + 90 W

Other models:

DIN power output (rated): 30 + 30 W
(6 ohms at 1 kHz, DIN)

Continuous RMS power output (reference):
35 + 35 W
(6 ohms at 1 kHz, 10% THD)

Music power output (reference):
60 + 60 W

Inputs

MD/VIDEO: Sensitivity 450/250 mV,
impedance 47 kilohms

Outputs

PHONES: Accepts headphones with
an impedance of 8 ohms or
more

SPEAKER: Accepts impedance of 6 to
16 ohms.

CD player section

Laser Semiconductor laser
($\lambda=780$ nm)
Emission duration:
continuous

Frequency response 20 Hz – 20 kHz

Wavelength 780 – 790 nm

Tape deck section

Recording system 4-track 2-channel, stereo

Frequency response 50 – 13,000 Hz (± 3 dB),
using Sony TYPE I
cassettes

Wow and flutter $\pm 0.15\%$ W. Peak (IEC)
 0.1% W. RMS (NAB)
 $\pm 0.2\%$ W. Peak (DIN)

Tuner section

FM stereo, FM/AM superheterodyne tuner

FM tuner section

Tuning range 87.5 – 108.0 MHz

Antenna FM lead antenna

Antenna terminals 75 ohms unbalanced

Intermediate frequency 10.7 MHz

AM tuner section

Tuning range

Pan-American model: 530 – 1,710 kHz
(with the tuning interval
set at 10 kHz)
531 – 1,710 kHz
(with the tuning interval
set at 9 kHz)

European model: 531 – 1,602 kHz
(with the tuning interval
set at 9 kHz)

Other models: 530 – 1,710 kHz
(with the tuning interval
set at 10 kHz)
531 – 1,602 kHz
(with the tuning interval
set at 9 kHz)

Antenna AM loop antenna, external
antenna terminal

Intermediate frequency 450 kHz

Speaker (SS-CGPX7/SS-CGPX6/ SS-CGPX5)

SS-CGPX7

Speaker system 2-way, bass-reflex type

Speaker units

Woofer: 13 cm dia., cone type

Tweeter: 4 cm dia., cone type

Nominal impedance 6 ohms

Dimensions (w/h/d) Approx. 163 \times 261.5 \times
259.5 mm

Mass Approx. 3.0 kg net per
speaker

SS-CGPX6

Speaker system 2-way, bass-reflex type

Speaker units

Woofer: 12 cm dia., cone type

Tweeter: 4 cm dia., cone type

Nominal impedance 6 ohms

Dimensions (w/h/d) Approx. 160 \times 261.5 \times
229.5 mm

Mass Approx. 2.6 kg net per
speaker

SS-CGPX5

Speaker system 2-way, bass-reflex type

Speaker units

Woofer: 13 cm dia., cone type

Tweeter: 4 cm dia., cone type

Nominal impedance 6 ohms

Dimensions (w/h/d) Approx. 160 \times 261.5 \times
229.5 mm

Mass Approx. 2.7 kg net per
speaker

General

Power requirements

North American model:	120 V AC, 60 Hz
European model:	230 V AC, 50/60 Hz
Korean model:	220 V AC, 60 Hz
Australian model:	230 – 240 V AC, 50/60 Hz
Taiwanese model:	110 – 120 V AC, 50/60 Hz
Argentine model:	220 V AC, 50/60 Hz
Other models:	110 – 120 V or 220 – 240 V AC, 50/60 Hz Adjustable with voltage selector

Power consumption

CMT-GPX7:	105 W 0.25 W (in Power Saving Mode)
CMT-GPX6:	80 W
CMT-GPX5 (UK model):	95 W 0.25 W (in Power Saving Mode)
CMT-GPX5 (other models):	80 W 0.25 W (in Power Saving Mode)

Dimensions (w/h/d)	Approx. 181.5 × 261.5 × 357.5 mm incl. projecting parts and controls
--------------------	--

Mass

HCD-GPX7:	Approx. 6.3 kg
HCD-GPX6:	Approx. 5.8 kg
HCD-GPX5:	Approx. 5.8 kg

Supplied accessories	Remote Commander (1) R6 (size AA) batteries (2) AM loop antenna (1) FM lead antenna (1)
----------------------	--

Design and specifications are subject to change without notice.

Main unit (CMT-GPX5)

ALPHABETICAL ORDER

A - O

- BASS +/- **28** (18)
- Cassette compartment **4**
- CD SYNCHRO **7** (16)
- DIRECTION **6** (15, 16, 17, 20)
- Disc slot **24** (8)
- DISPLAY **31** (14, 21)
- Display window **3**
- DSGX **12** (18, 25)
- FM MODE **26** (14, 24)
- FUNCTION **30** (9, 11, 13, 15, 22)

P - Z

- PHONES jack **23**
- PLAY MODE **22** (9, 11)
- Remote sensor **2**
- REPEAT **21** (10)
- TREBLE +/- **13** (18)
- TUNER/BAND **15** (12, 13, 17, 19)
- TUNER MEMORY **27** (12)
- TUNING +/- **25** (12, 13)
- TUNING MODE **14** (12, 13)
- VOLUME **11** (19, 23)

BUTTON DESCRIPTIONS

- I/⏻ (power) **1** (7, 13, 19, 20, 25)
- ◀◀/▶▶ (CD skip back/skip forward) **20** (9, 11)
- ◀◀/▶▶ (CD rewind/fast forward) **19** (9)
- ◀◀/▶▶ (tape rewind/fast forward) **29** (9, 15)
- (CD stop) **17** (9, 13, 25)
- (tape stop) **9** (15, 16, 17)
- REC PAUSE/START **8** (16, 17)
- CD/▶▶|| (play/pause) **18** (9, 11)
- TAPE/◀▶ (play) **10** (15, 16, 17, 20)
- ⊞ (CD eject) **16** (9)
- ⊞ PUSH EJECT (tape open/close) **5** (15)

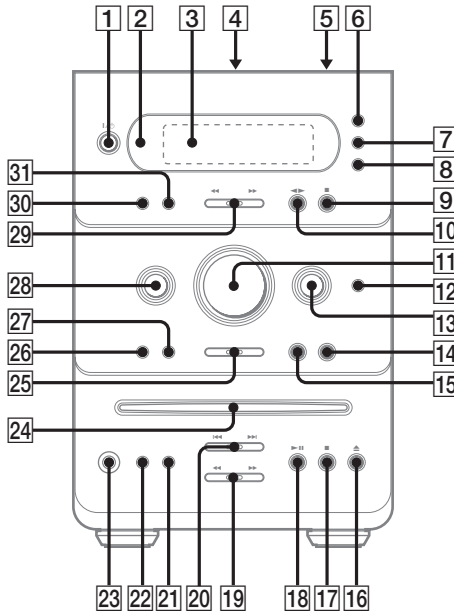

Remote control

ALPHABETICAL ORDER

A - O

- ALBUM +/- **11** (9, 11)
- CD **16** (9, 11, 13, 17, 19)
- CLEAR **13** (11)
- CLOCK/TIMER SELECT **2** (19, 20)
- CLOCK/TIMER SET **3** (8, 19, 20)
- DISPLAY **19** (14, 21)
- ENTER **9** (8, 11, 19, 20)
- EQ **12** (18)
- FM MODE **4** (14, 24)
- FUNCTION **6** (9, 11, 13, 15, 22)

P - Z

- PLAY MODE **18** (9, 11)
- REPEAT **4** (10)
- SLEEP **20** (18)
- TAPE **15** (15, 19)
- TUNER/BAND **5** (12, 13, 17, 19)
- TUNER MEMORY **17** (12)
- TUNING MODE **18** (12, 13)
- VOLUME +/- **10** (19, 23)

BUTTON DESCRIPTIONS

- I/⏻ (power) **1** (7, 13, 19, 20, 25)
- ◀◀/▶▶ (rewind/fast forward) **7** (9, 15)
- ◀◀/▶▶ (skip back/skip forward) **14** (8, 9, 11, 18, 19, 20)
- (stop) **8** (9, 13, 15, 16, 17, 25)
- ⏸ (pause) **8** (9, 15)
- ▶ (play) **8** (9, 11, 15, 16, 17, 20)
- +/- (tuning) **14** (12, 13)

CMT-GPX5

CMT-GPX7/CMT-GPX6

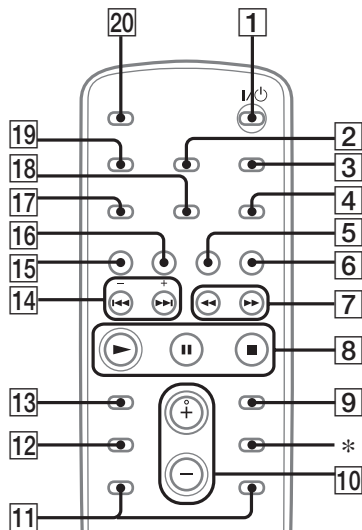
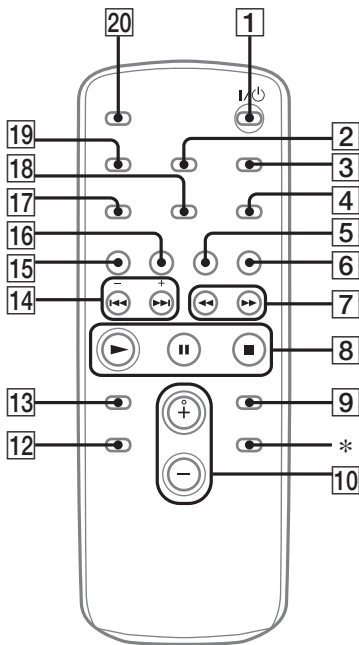

* This button is not available for this model.

Free Manuals Download Website

<http://myh66.com>

<http://usermanuals.us>

<http://www.somanuals.com>

<http://www.4manuals.cc>

<http://www.manual-lib.com>

<http://www.404manual.com>

<http://www.luxmanual.com>

<http://aubethermostatmanual.com>

Golf course search by state

<http://golfingnear.com>

Email search by domain

<http://emailbydomain.com>

Auto manuals search

<http://auto.somanuals.com>

TV manuals search

<http://tv.somanuals.com>