

UH-1000

SERVICE MANUAL

*US Model
Canadian Model
AEP Model*

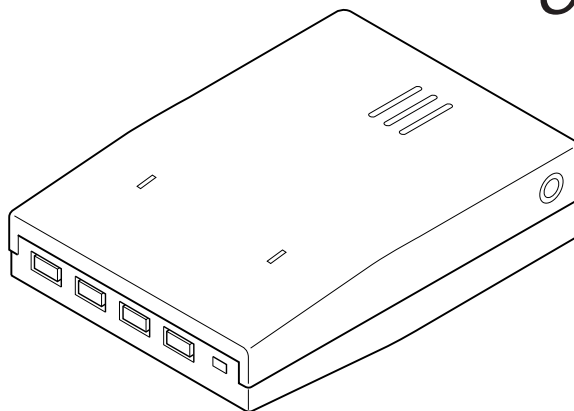

SPECIFICATIONS

Mass	500 g (1 lb 1.6 oz)
Dimensions	185 × 134 × 51 mm (l/w/h) (7 ³ / ₈ × 5 ³ / ₈ × 2 ¹ / ₈ in.)
USB terminals	Upstream : 1, Downstream : 4
Voltage per port	DC + 5V
Current per port	500 mA (max.)
Operating temperature	0 – 40 °C (32 – 104 °F)
Supplied accessories	AC power cord (1), USB cable (1), Rubber feet (4), Stand (1), Instruction manual (1)

NOTICE

This notice is applicable for USA /
Canada only.

If shipped to USA / Canada, install only
a UL LISTED / CSA LABELLED power
supply cord meeting the following
specifications:

SPECIFICATIONS

Plug Type	Nema-Plug 5-15p
Cord	Type SVT or SJT, minimum 3 × 18 AWG
Length	Maximum 15 feet
Rating	Minimum 7 A, 125 V



USB HUB UNIT
SONY®

TABLE OF CONTENTS

<i>Section</i>	<i>Title</i>	<i>Page</i>
1. GENERAL	1-1
2. DISASSEMBLY		
2-1. Box Removal	2-1
3. DIAGRAMS		
3-1. Schematic Diagrams and Printed Wiring Boards	..	3-1
3-2. Semiconductors	3-7
4. EXPLODED VIEWS		
4-1. Base	4-1
4-2. Packing Materials	4-2
5. ELECTRICAL PARTS LIST	5-1

SAFETY-RELATED COMPONENT WARNING!!
 COMPONENTS IDENTIFIED BY SHADING AND MARK  ON THE SCHEMATIC DIAGRAMS, EXPLODED VIEWS AND IN THE PARTS LIST ARE CRITICAL FOR SAFE OPERATION. REPLACE THESE COMPONENTS WITH SONY PARTS WHOSE PART NUMBERS APPEAR AS SHOWN IN THIS MANUAL OR IN SUPPLEMENTS PUBLISHED BY SONY. CIRCUIT ADJUSTMENTS THAT ARE CRITICAL FOR SAFE OPERATION ARE IDENTIFIED IN THIS MANUAL. FOLLOW THESE PROCEDURES WHENEVER CRITICAL COMPONENTS ARE REPLACED OR IMPROPER OPERATION IS SUSPECTED.

ATTENTION AUX COMPOSANTS RELATIFS À LA SÉCURITÉ!!
 LES COMPOSANTS IDENTIFIÉS PAR UNE TRAME ET UNE MARQUE  SONT CRITIQUES POUR LA SÉCURITÉ. NE LES REMPLACER QUE PAR UNE PIÈCE PORTANT LE NUMÉRO SPECIFIÉ. LES RÉGLAGES DE CIRCUIT DONT L'IMPORTANCE EST CRITIQUE POUR LA SÉCURITÉ DU FONCTIONNEMENT SONT IDENTIFIÉS DANS LE PRÉSENT MANUEL. SUIVRE CES PROCÉDURES LORS DE CHAQUE REMPLACEMENT DE COMPOSANTS CRITIQUES, OU LORSQU'UN MAUVAIS FONCTIONNEMENT EST SUSPECTÉ.

SECTION 1

GENERAL

The operating instructions mentioned here are partial abstracts from the Operating Instruction Manual. The page numbers of the Operating Instruction Manual remain as in the manual.

A

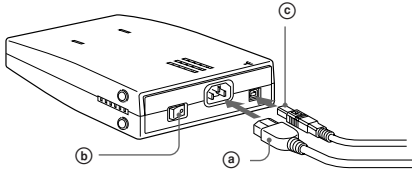

B

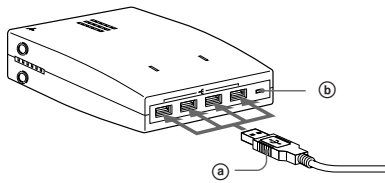

C

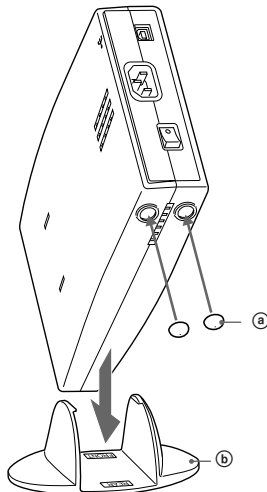

- Windows® is registered trademark of Microsoft Corporation in the United States and other countries.
- All other product names mentioned herein may be the trademarks or registered trademarks of their respective companies.
- Furthermore, "™" and "®" are not mentioned in each case in this manual.

English

Setup

This USB unit provides a fast and easy way to connect USB compliant peripheral devices (such as a mouse, keyboards, printers, and scanners) to your computer using a standardized USB cable.

- 1 Turn "on" the power of your computer and any self-powered USB compliant peripheral devices.
- 2 Connect one end of the AC power cord to the unit (fig. A-Ⓒ), and the other end to a power outlet.
- 3 Turn "on" the power switch. (fig. A-Ⓓ)
- 4 Connect the square end of the supplied USB cable to the unit's square connector. (fig. A-Ⓐ) Then connect the rectangular end to your computer.

If the LED is green (fig. B-Ⓓ), you are ready to use the USB unit. If the LED is orange, see "Troubleshooting" on the reverse page.

For customers using Windows®

If a message appears on your screen, follow the on-screen instructions and select Generic USB Hub as the default setting.

- 5 Connect your peripheral devices to the rectangular USB connectors. (fig. B-Ⓓ)

To set the unit on its side:

Attach the supplied rubber feet (2) to the holes on the side of the unit. (fig. B-Ⓐ) Then attach the stand by inserting the nibs into the slots on the unit. (fig. B-Ⓑ) Make sure that the word FRONT on the stand is facing the side of the unit with the LED. You can stand the unit on either of its sides.

Notes:

- This hub unit is not guaranteed to work with all USB peripheral devices.
- The unit does not include driver software for individual USB devices. In most cases, USB driver software needs to be installed on the host computer. Refer to the peripheral device's instruction manual for further details. (This unit does not require special software to operate.)
- Not all computers and /or operating systems support USB configurations. If you are using Windows®, the version must be OSR 2.1 or later and have USB support. Check your computer's instruction manual to see if you can connect USB devices.
- If you connect a keyboard or mouse to the USB connectors and then boot your computer for the first time, the peripheral devices may not function. First connect the keyboard and mouse directly to the computer and setup the USB compliant devices.

English

Troubleshooting

The LED is not lit

- Turn "on" the power switch. The unit must be "on" to work as a hub for USB peripheral devices.

The LED is orange

- Check that the USB cables are securely connected to the unit.
- Check that the USB port is enabled on the host computer's basic input/output system (BIOS). Refer to your computer's manual to change the port setting.

Individual USB peripheral devices do not work

- If the connected USB peripheral device uses software, install the software on the host computer.
- Turn the unit's power switch "off" and "on." If your USB peripheral devices are self-powered, turn their switches "off" and "on" as well.
- Check that the connectors are secure in their sockets.
- Install the latest version of the device driver on your computer. Contact your device's manufacturer for information about the appropriate device driver.

For customers using Windows® 95

If you are having trouble using this USB unit, try the steps below.

1. Right-click on My Computer and select Properties.
2. Click on the Device Manager tab. Scroll down and select Universal Serial Bus Controller.
 - ➔ If Universal Serial Bus Controller does not appear, you need to load a USB supplement disk. Contact your computer's manufacturer for more information about obtaining a USB supplement disk.
3. Select Generic USB Device from the USB controller list and click on Properties. If there is a check in the box next to "Disable in this hardware profile," remove the check.
4. Click on Refresh.

SECTION 2 DISASSEMBLY

2-1. BOX REMOVAL

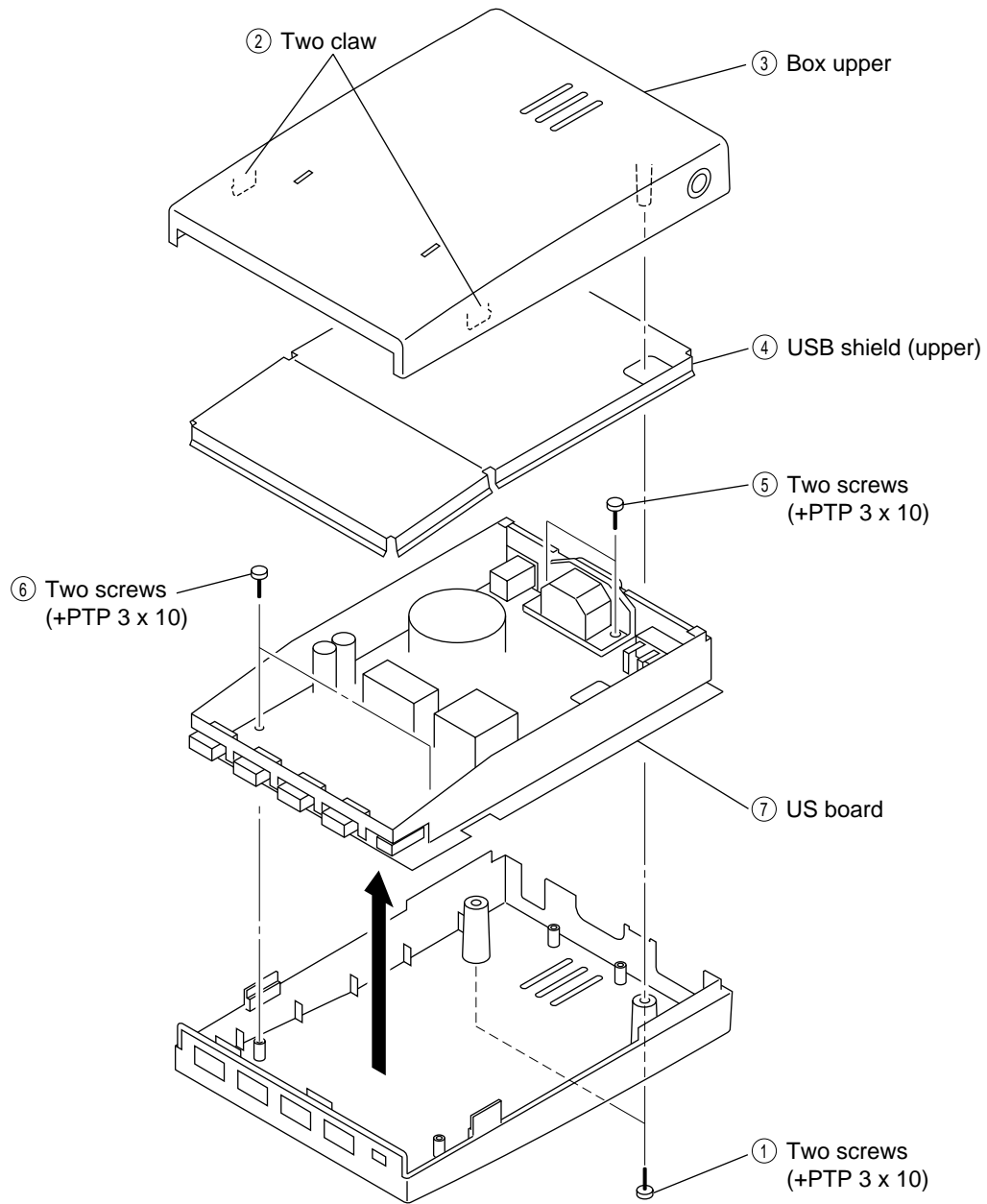

3-1. SCHEMATIC DIAGRAMS AND PRINTED WIRING BOARDS

Note:

- All capacitors are in μF unless otherwise noted. (pF: μpF) Capacitors without voltage indication are all 50 V.
- Indication of resistance, which does not have one for rating electrical power, is as follows.

Pitch: 5 mm
Rating electrical power 1/4 W (CHIP : 1/10 W)

- All resistors are in ohms.
- : nonflammable resistor.
- : fusible resistor.
- Δ : internal component.
- : panel designation, and adjustment for repair.
- All variable and adjustable resistors have characteristic curve B, unless otherwise noted.
- \perp : earth-ground.
- $\text{---}\text{||}\text{---}$: earth-chassis.
- All voltages are in V.
- Readings are taken with a 10 M digital multimeter.
- Voltage value is non signal state.
- Voltage variations may be noted due to normal production tolerances.
- : B + bus.
- : B - bus.

Terminal name of semiconductors in silk screen printed circuit (*):

Device	Printed symbol	Terminal name	Circuit
① Transistor		Collector Base Emitter	
② Transistor		Collector Base Emitter	
③ Diode		Cathode Anode	
— Discrete semiconductor			

(Chip semiconductors that are not actually used are included.)

Note: The components identified by shading and mark Δ are critical for safety. Replace only with part number specified.

Note: Les composants identifiés par un trame et une marque Δ sont critiques pour la sécurité. Ne les remplacer que par une pièce portant le numéro spécifié.

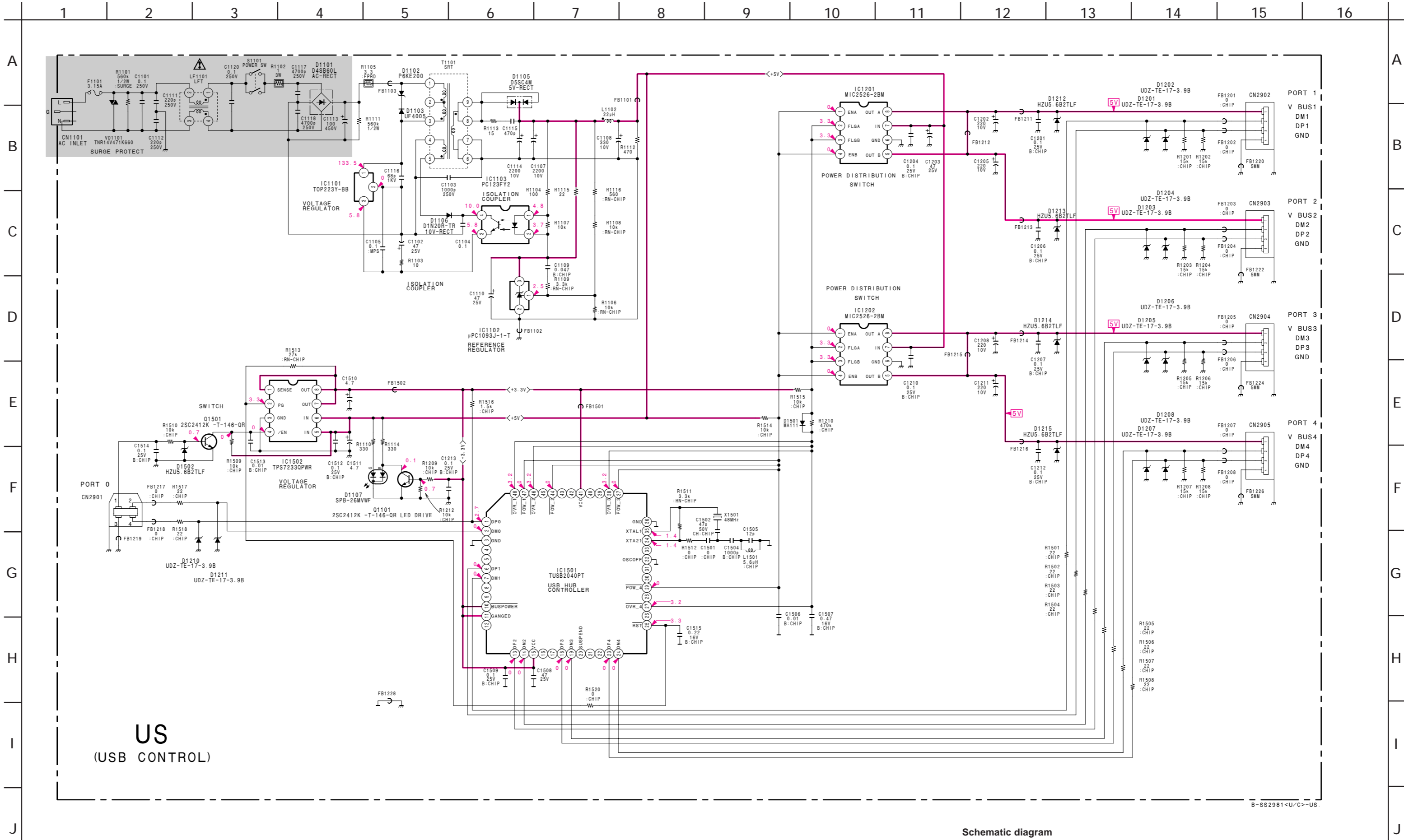

Schematic diagram
← US board

— US BOARD (Conductor Side) —

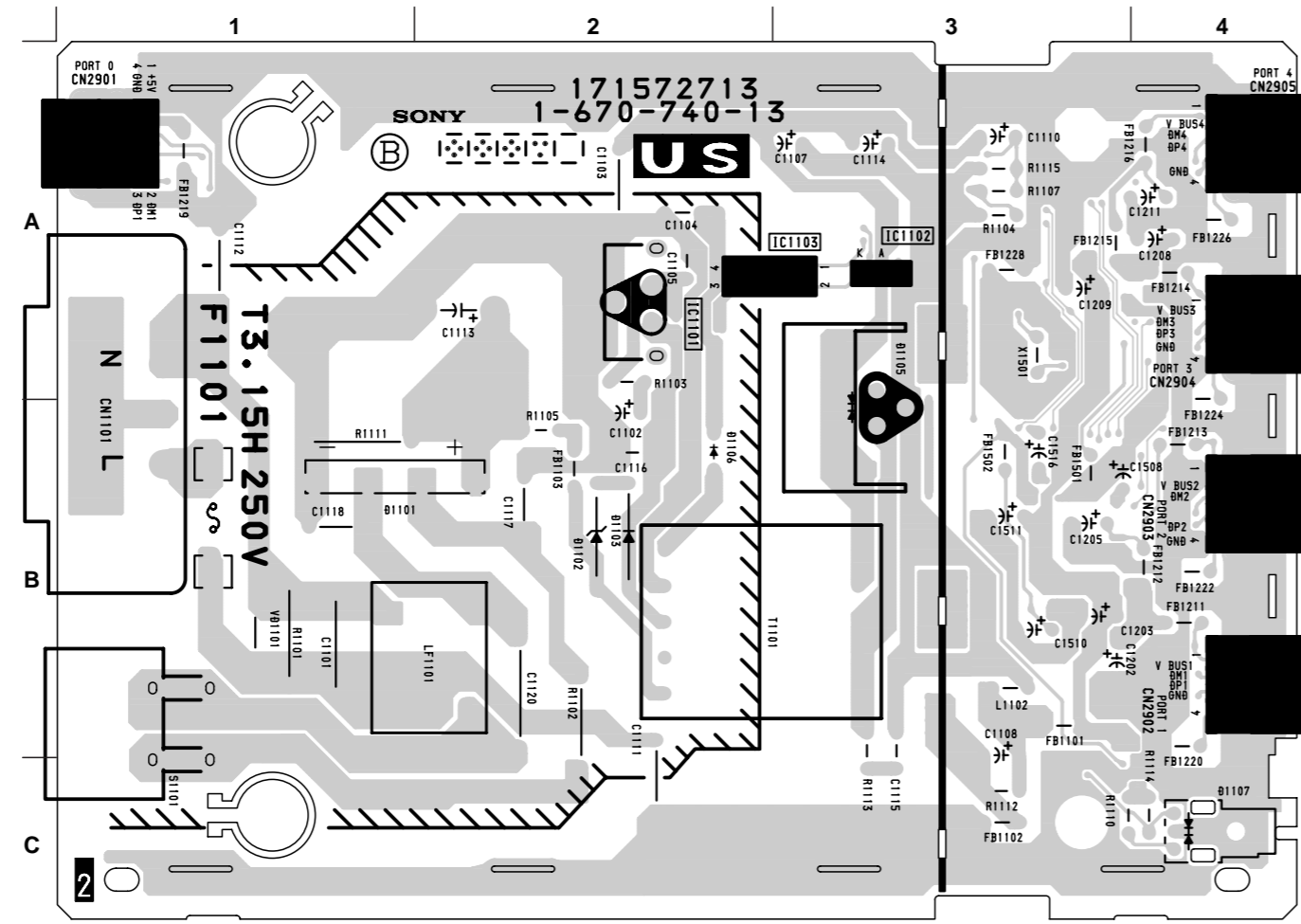

• US BOARD SEMICONDUCTOR LOCATION

IC	(Conductor Side) (Component Side)	
	IC1101	A-2
IC1102	A-3	A-2
IC1103	A-2	A-2
IC1201	A-2	B-1
IC1202	A-2	A-1
IC1501	A-2	B-1
IC1502	A-2	B-1

TRANSISTOR	(Conductor Side) (Component Side)*	
	Q1101	C-1
Q1501	B-1	②

DIODE	(Conductor Side) (Component Side)*	
	D1101	B-1
D1102	B-2	B-2
D1103	B-2	B-2
D1105	A-3	A-2
D1106	B-2	B-2
D1107	C-4	C-1
D1201	B-1	③
D1202	B-1	③
D1203	B-1	③
D1204	B-1	③
D1205	A-1	③
D1206	A-1	③
D1207	A-1	③
D1208	A-1	③
D1210	A-1	③
D1211	A-1	③
D1212	B-1	③
D1213	B-1	③
D1214	A-1	③
D1215	A-1	③
D1502	B-1	③

CRYSTAL		
X1501	A-3	A-1

*: Refer to Terminal name of semiconductors in silk screen printed circuit (see page 3-1)

— US BOARD (Component Side) —

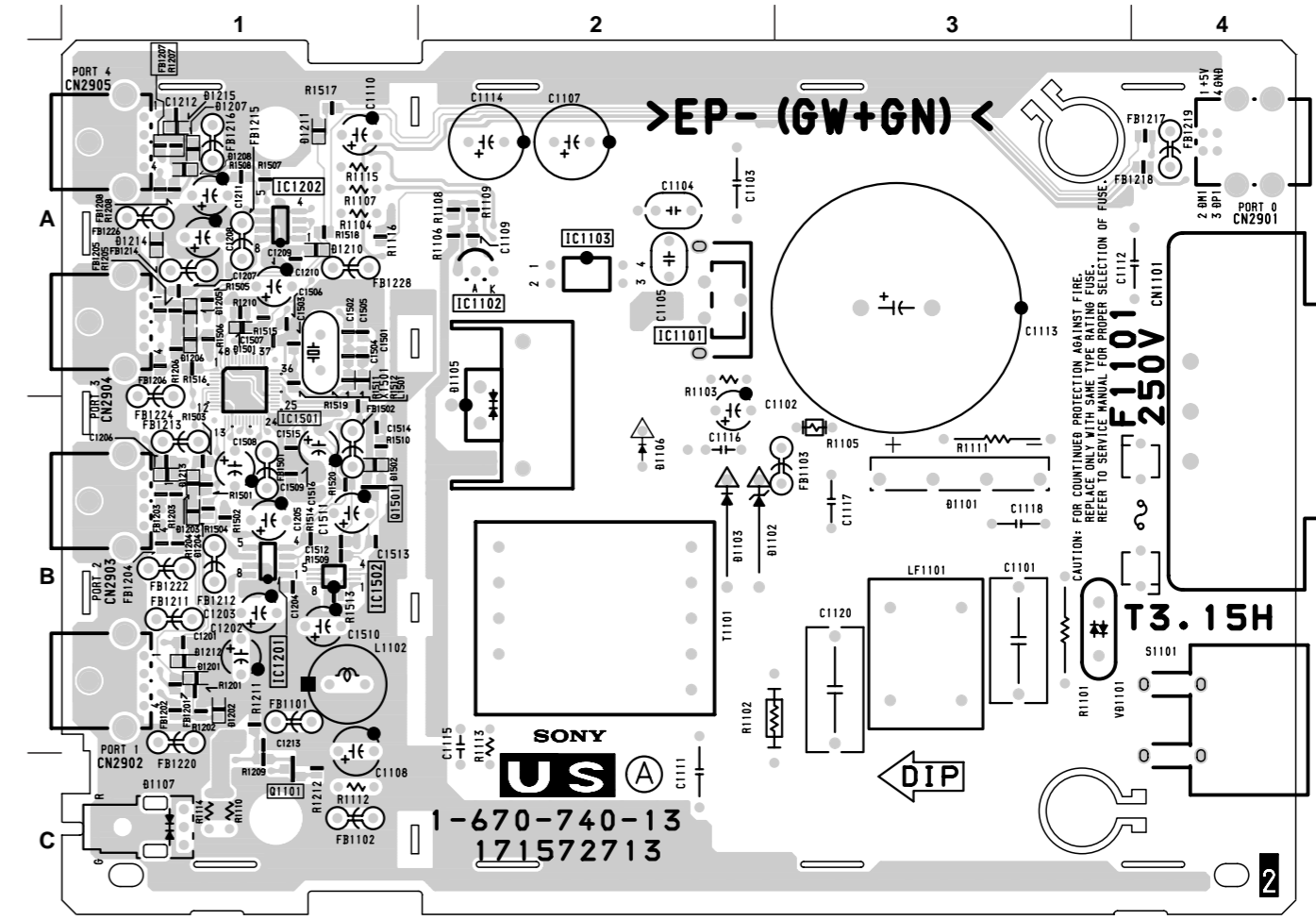

3-2. SEMICONDUCTORS

MIC2526-2BM-T&R
TPS7233QPWR

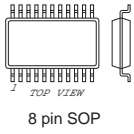

D5SC4M

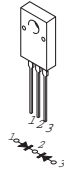

UF4005PKG23

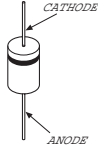

TOP223Y-BB

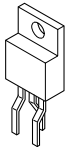

HZU5.6B2TLF
HZU5.6B2TRF

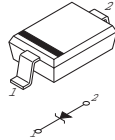

SPB-26MVWF

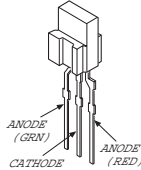

TUSB2040PT

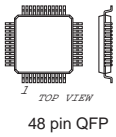

MA8039

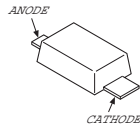

UPC1093J-1-T

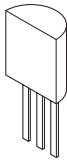

PC123F2
PC123FY2

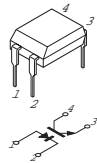

2SC1623-L5L6
2SC2412K-T-146-QR

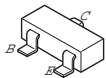

P6KE200AG23

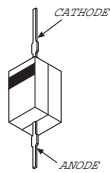

D1N20R

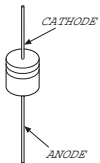

UDZ-TE-17-3.9B

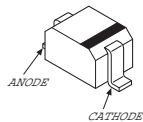

D4SB60L

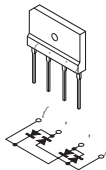

SECTION 4 EXPLODED VIEWS

NOTE:

- Items with no part number and no description are not stocked because they are seldom required for routine service.
- The construction parts of an assembled part are indicated with a collation number in the remark column.
- Items marked " * " are not stocked since they are seldom required for routine service. Some delay should be anticipated when ordering these items.

The components identified by shading and mark Δ are critical for safety. Replace only with part number specified.

Les composants identifiés par un tramé et une marque Δ sont critiques pour la sécurité. Ne les remplacer que par une pièce portant le numéro spécifié.

4-1. BASE

- 7-685-647-79 +PTP 3X10

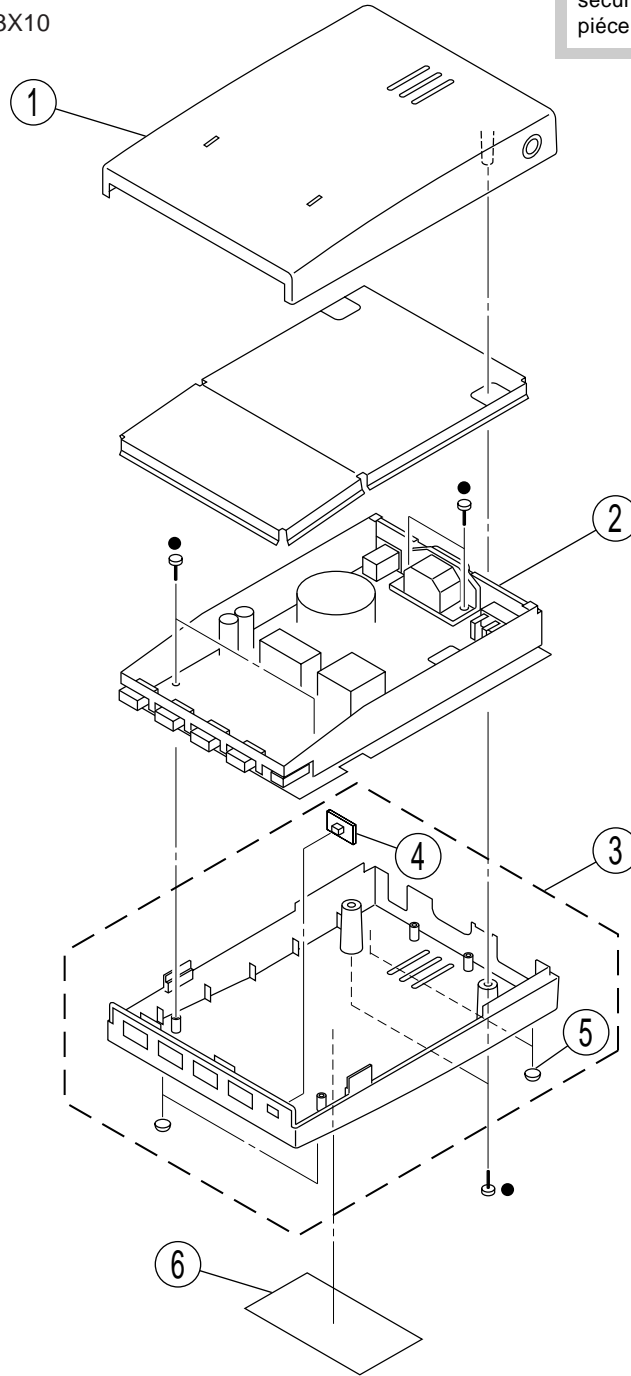

REF.NO.	PART NO.	DESCRIPTION	REMARK	REF.NO.	PART NO.	DESCRIPTION	REMARK
1	4-066-341-01	BOX UPPER		4	4-066-336-01	BAR, OPTICAL	
2	* A-1373-692-A	US BOARD, COMPLETE		5	4-066-332-01	FOOT (SMALL)	
3	X-4035-969-1	BOX LOWER ASSY	4,5	6	* 4-066-337-01	LABEL, INFORMATION	

4-2. PACKING MATERIALS

The components identified by shading and mark \triangle are critical for safety. Replace only with part number specified.

Les composants identifiés par un tramé et une marque \triangle sont critiques pour la sécurité. Ne les remplacer que par une pièce portant le numéro spécifié.

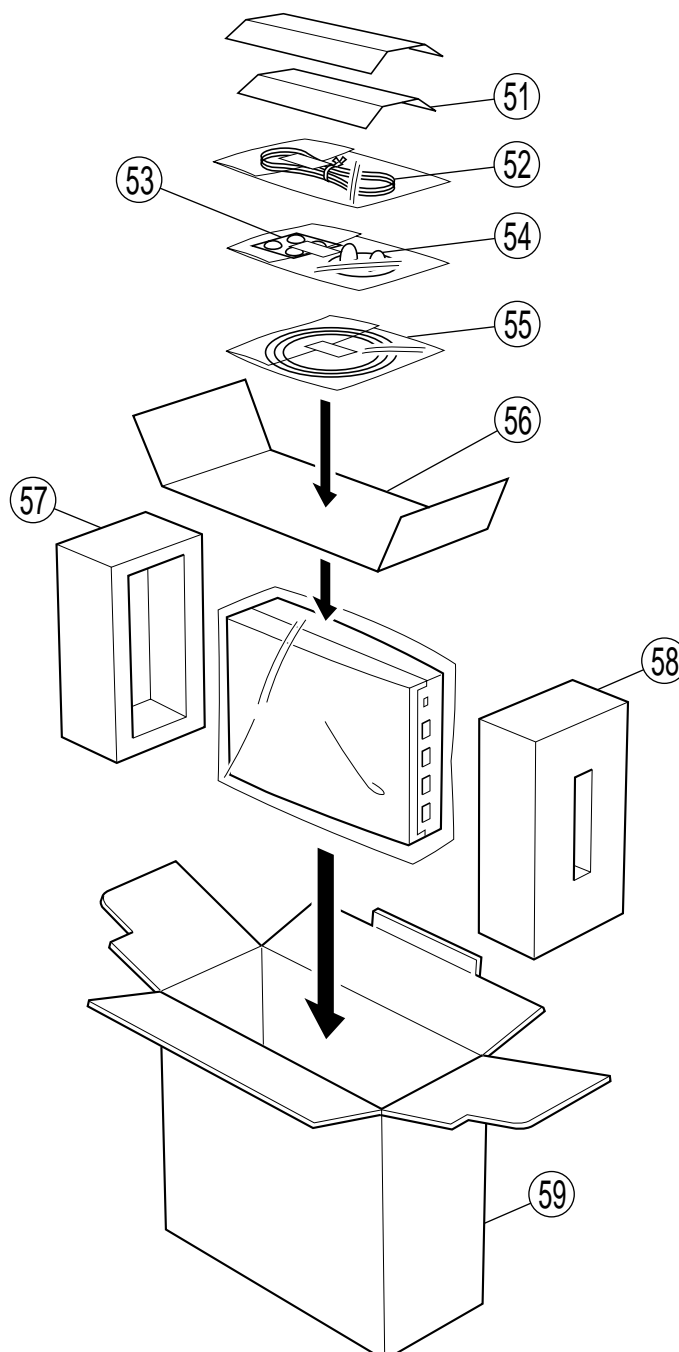

REF.NO.	PART NO.	DESCRIPTION	REMARK	REF.NO.	PART NO.	DESCRIPTION	REMARK
51	3-864-554-11	MANUAL, INSTRUCTION		55	1-790-081-11	CABLE, USB	
52	\triangle 1-765-719-21	CORD SET, POWER (AEP)		56	* 4-066-558-01	TRAY	
	\triangle 1-765-720-21	CORD SET, POWER (U/C)		57	* 4-066-561-01	CUSHION, REAR	
53	4-066-333-01	FOOT (LARGE)		58	* 4-066-560-01	CUSHION, FRONT	
54	X-4035-968-1	STAND ASSY		59	* 4-066-557-01	INDIVIDUAL CARTON	



SECTION 5

ELECTRICAL PARTS LIST

NOTE:

The components identified by shading and mark Δ are critical for safety. Replace only with part number specified.

Les composants identifiés par un trame et une marque Δ sont critiques pour la sécurité. Ne les remplacer que par une pièce portant le numéro spécifié.

When indicating parts by reference number, please include the board name.

• All variable and adjustable resistors have characteristic curve B, unless otherwise noted.

RESISTORS

- All resistors are in ohms
- F : nonflammable

• Items marked " * " are not stocked since they are seldom required for routine service. Some delay should be anticipated when ordering these items.

CAPACITORS

MF : μ F

COILS

UH : μ H

REF.NO.	PART NO.	DESCRIPTION	REMARK	REF.NO.	PART NO.	DESCRIPTION	REMARK
	* A-1373-692-A	US BOARD, COMPLETE *****		C1502	1-163-243-11	CERAMIC CHIP 47PF	5% 50V
	2-371-561-00	BUSHING (P), INSULATING (IC1101)		C1504	1-163-009-11	CERAMIC CHIP 0.001MF	10% 50V
	* 4-049-002-01	HOLDER, LED (D1107)		C1505	1-163-229-11	CERAMIC CHIP 12PF	5% 50V
	4-060-842-01	SHEET, INSULATING (IC1101)		C1506	1-163-021-91	CERAMIC CHIP 0.01MF	10% 50V
	4-382-854-11	SCREW (M3X10), P, SW (+) (D1105)		C1507	1-107-823-11	CERAMIC CHIP 0.47MF	10% 16V
	4-389-025-01	SCREW (M4) (EXT TOOTH WASHER)		C1508	1-104-664-11	ELECT 47MF	20% 25V
	7-682-947-01	SCREW +PSW 3X6 (IC1101)		C1509	1-164-004-11	CERAMIC CHIP 0.1MF	10% 25V
		<CAPACITOR>		C1510	1-126-963-11	ELECT 4.7MF	20% 50V
	C1101	Δ 1-104-705-51 FILM	0.1MF 20% 250V	C1511	1-126-963-11	ELECT 4.7MF	20% 50V
	C1102	1-104-664-11 ELECT	47MF 20% 25V	C1512	1-164-004-11	CERAMIC CHIP 0.1MF	10% 25V
	C1103	1-113-903-11 CERAMIC	0.001MF 20% 250V	C1513	1-163-021-91	CERAMIC CHIP 0.01MF	10% 50V
	C1104	1-130-495-00 FILM	0.1MF 5% 50V	C1514	1-164-004-11	CERAMIC CHIP 0.1MF	10% 25V
	C1105	1-136-165-00 FILM	0.1MF 5% 50V	C1515	1-164-489-11	CERAMIC CHIP 0.22MF	10% 16V
	C1107	1-126-927-11 ELECT	2200MF 20% 10V			<CONNECTOR>	
	C1108	1-126-924-11 ELECT	330MF 20% 10V	CN1101	Δ 1-251-457-21	INLET, AC	
	C1109	1-104-760-11 CERAMIC CHIP	0.047MF 10% 50V	CN2901	1-779-677-11	CONNECTOR, USB (B)	
	C1110	1-104-664-11 ELECT	47MF 20% 25V	CN2902	1-779-642-12	CONNECTOR, USB (A)	
	C1111	Δ 1-113-896-51 CERAMIC	220PF 10% 250V	CN2903	1-779-642-12	CONNECTOR, USB (A)	
	C1112	Δ 1-113-896-51 CERAMIC	220PF 10% 250V	CN2904	1-779-642-12	CONNECTOR, USB (A)	
	C1113	Δ 1-125-977-11 CAPACITOR	100 450V	CN2905	1-779-642-12	CONNECTOR, USB (A)	
	C1114	1-126-927-11 ELECT	2200MF 20% 10V			<DIODE>	
	C1115	1-102-824-00 CERAMIC	470PF 5% 50V	D1101	Δ 8-719-510-63	DIODE D4SB60L-F	
	C1116	1-117-219-11 CERAMIC	68PF 5% 1KV	D1102	8-719-059-23	DIODE P6KE200AG23	
	C1117	Δ 1-113-926-91 CERAMIC	0.0047MF 250V	D1103	8-719-979-64	DIODE UF4005PKG23	
	C1118	Δ 1-113-926-91 CERAMIC	0.0047MF 250V	D1105	8-719-031-79	DIODE D5SC4M	
	C1120	Δ 1-104-705-51 FILM	0.1MF 20% 250V	D1106	8-719-510-48	DIODE D1N20R	
	C1201	1-164-004-11 CERAMIC CHIP	0.1MF 10% 25V	D1107	8-719-045-19	DIODE SPB-26MVWF	
	C1202	1-126-934-11 ELECT	220MF 20% 10V	D1201	8-719-422-12	ZENER DIODE MA8039	
	C1203	1-104-664-11 ELECT	47MF 20% 25V	D1202	8-719-422-12	ZENER DIODE MA8039	
	C1204	1-164-004-11 CERAMIC CHIP	0.1MF 10% 25V	D1203	8-719-422-12	ZENER DIODE MA8039	
	C1205	1-126-934-11 ELECT	220MF 20% 10V	D1204	8-719-422-12	ZENER DIODE MA8039	
	C1206	1-164-004-11 CERAMIC CHIP	0.1MF 10% 25V	D1205	8-719-422-12	ZENER DIODE MA8039	
	C1207	1-164-004-11 CERAMIC CHIP	0.1MF 10% 25V	D1206	8-719-422-12	ZENER DIODE MA8039	
	C1208	1-126-934-11 ELECT	220MF 20% 10V	D1207	8-719-422-12	ZENER DIODE MA8039	
	C1210	1-164-004-11 CERAMIC CHIP	0.1MF 10% 25V	D1208	8-719-422-12	ZENER DIODE MA8039	
	C1211	1-126-934-11 ELECT	220MF 20% 10V	D1210	8-719-422-12	ZENER DIODE MA8039	
	C1212	1-164-004-11 CERAMIC CHIP	0.1MF 10% 25V	D1211	8-719-422-12	ZENER DIODE MA8039	
	C1213	1-164-004-11 CERAMIC CHIP	0.1MF 10% 25V	D1212	8-719-047-98	ZENER DIODE HZU5.6B2TRF	
	C1501	1-216-295-91 SHORT	0	D1213	8-719-047-98	ZENER DIODE HZU5.6B2TRF	

The components identified by shading and mark Δ are critical for safety. Replace only with part number specified.

Les composants identifiés par un trame Δ sont critiques pour la sécurité. Ne les remplacer que par une pièce portant le numéro spécifié.



REF.NO.	PART NO.	DESCRIPTION	REMARK	REF.NO.	PART NO.	DESCRIPTION	REMARK
D1214	8-719-047-98	ZENER DIODE HZU5.6B2TRF				<TRANSISTOR>	
D1215	8-719-047-98	ZENER DIODE HZU5.6B2TRF					
D1501	8-719-404-49	DIODE MA111		Q1101	8-729-120-28	TRANSISTOR 2SC1623-L5L6	
D1502	8-719-047-98	ZENER DIODE HZU5.6B2TRF		Q1501	8-729-120-28	TRANSISTOR 2SC1623-L5L6	
		<FUSE>				<RESISTOR>	
F1101	Δ 1-576-230-11	FUSE (H.B.C.) (3.15A/250V)		R1101	Δ 1-220-827-91	REGISTER 560K	5% 1/2W
	1-533-223-11	HOLDER, FUSE ; F1101		R1102	Δ 1-217-249-11	WIREWOUND 1	10% 3W F
		<FERRITE BEAD>		R1103	1-249-393-11	CARBON 10	5% 1/4W
FB1101	1-412-911-11	FERRITE 0UH		R1104	1-247-807-31	CARBON 100	5% 1/4W
FB1102	1-412-911-11	FERRITE 0UH		R1105	1-249-387-11	CARBON 3.3	5% 1/4W F
FB1103	1-412-911-11	FERRITE 0UH		R1106	1-216-675-11	METAL CHIP 10K	0.50%1/10W
FB1201	1-216-295-91	SHORT 0		R1107	1-249-429-11	CARBON 10K	5% 1/4W
FB1202	1-216-295-91	SHORT 0		R1108	1-216-675-11	METAL CHIP 10K	0.50%1/10W
FB1203	1-216-295-91	SHORT 0		R1109	1-216-663-11	METAL CHIP 3.3K	0.50%1/10W
FB1204	1-216-295-91	SHORT 0		R1110	1-249-411-11	CARBON 330	5% 1/4W
FB1205	1-216-295-91	SHORT 0		R1111	1-220-827-91	REGISTER 560K	5% 1/2W
FB1206	1-216-295-91	SHORT 0		R1112	1-249-413-11	CARBON 470	5% 1/4W
FB1207	1-216-295-91	SHORT 0		R1113	1-249-395-11	CARBON 15	5% 1/4W
FB1208	1-216-295-91	SHORT 0		R1114	1-249-411-11	CARBON 330	5% 1/4W
FB1211	1-412-911-11	FERRITE 0UH		R1115	1-247-791-91	CARBON 22	5% 1/4W
FB1212	1-412-911-11	FERRITE 0UH		R1116	1-216-645-11	METAL CHIP 560	0.50%1/10W
FB1213	1-412-911-11	FERRITE 0UH		R1201	1-216-077-00	RES,CHIP 15K	5% 1/10W
FB1214	1-412-911-11	FERRITE 0UH		R1202	1-216-077-00	RES,CHIP 15K	5% 1/10W
FB1215	1-412-911-11	FERRITE 0UH		R1203	1-216-077-00	RES,CHIP 15K	5% 1/10W
FB1216	1-412-911-11	FERRITE 0UH		R1204	1-216-077-00	RES,CHIP 15K	5% 1/10W
FB1217	1-216-295-91	SHORT 0		R1205	1-216-077-00	RES,CHIP 15K	5% 1/10W
FB1218	1-216-295-91	SHORT 0		R1206	1-216-077-00	RES,CHIP 15K	5% 1/10W
FB1219	1-412-911-11	FERRITE 0UH		R1207	1-216-077-00	RES,CHIP 15K	5% 1/10W
FB1228	1-412-911-11	FERRITE 0UH		R1208	1-216-077-00	RES,CHIP 15K	5% 1/10W
FB1501	1-412-911-11	FERRITE 0UH		R1209	1-216-073-00	RES,CHIP 10K	5% 1/10W
FB1502	1-412-911-11	FERRITE 0UH		R1210	1-216-113-00	RES,CHIP 470K	5% 1/10W
		<IC>		R1212	1-216-073-00	RES,CHIP 10K	5% 1/10W
IC1101	8-759-470-64	IC TOP223Y-BB		R1501	1-216-009-00	RES,CHIP 22	5% 1/10W
IC1102	8-759-198-31	IC uPC1093J-1-T		R1502	1-216-009-00	RES,CHIP 22	5% 1/10W
IC1103	8-749-010-64	PHOTO COUPLER PC123F2		R1503	1-216-009-00	RES,CHIP 22	5% 1/10W
IC1201	8-759-542-74	IC MIC2526-2BM-T&R		R1504	1-216-009-00	RES,CHIP 22	5% 1/10W
IC1202	8-759-542-74	IC MIC2526-2BM-T&R		R1505	1-216-009-00	RES,CHIP 22	5% 1/10W
IC1501	8-759-542-53	IC TUSB2040PT		R1506	1-216-009-00	RES,CHIP 22	5% 1/10W
IC1502	8-759-542-69	IC TPS7233QPWR		R1507	1-216-009-00	RES,CHIP 22	5% 1/10W
		<COIL>		R1508	1-216-009-00	RES,CHIP 22	5% 1/10W
L1102	1-406-661-41	INDUCTOR 22UH		R1509	1-216-073-00	RES,CHIP 10K	5% 1/10W
L1501	1-412-003-41	INDUCTOR CHIP 5.6UH		R1510	1-216-073-00	RES,CHIP 10K	5% 1/10W
		<FILTER>		R1511	1-216-663-11	METAL CHIP 3.3K	0.50%1/10W
LF1101	Δ 1-424-117-11	FILTER, LINE		R1512	1-216-295-91	SHORT 0	
				R1513	1-216-685-11	METAL CHIP 27K	0.50%1/10W
				R1514	1-216-073-00	RES,CHIP 10K	5% 1/10W
				R1515	1-216-073-00	RES,CHIP 10K	5% 1/10W
				R1516	1-216-053-00	RES,CHIP 1.5K	5% 1/10W
				R1517	1-216-009-00	RES,CHIP 22	5% 1/10W
				R1518	1-216-009-00	RES,CHIP 22	5% 1/10W
				R1520	1-216-295-91	SHORT 0	

UH-1000

US

Les composants identifiés par un triangle et une marque Δ sont critiques pour la sécurité. Ne les remplacer que par une pièce portant le numéro spécifié.

The components identified by shading and mark Δ are critical for safety. Replace only with part number specified.

REF.NO.	PART NO.	DESCRIPTION	REMARK
---------	----------	-------------	--------

<SWITCH>

S1101 Δ 1-771-242-11 SWITCH, POWER (AJ7231BK)

<TRANSFORMER>

T1101 1-433-440-11 TRANSFORMER, CONVERTER (SRT)

<VARISTOR>

VD1101 Δ 1-801-268-51VARISTOR TNR14V471K660

<CRYSTAL>

X1501 1-767-587-31 VIBRATOR, CRYSTAL

UH-1000

9-978-624-01 98FL24176-1

SONY

Free Manuals Download Website

<http://myh66.com>

<http://usermanuals.us>

<http://www.somanuals.com>

<http://www.4manuals.cc>

<http://www.manual-lib.com>

<http://www.404manual.com>

<http://www.luxmanual.com>

<http://aubethermostatmanual.com>

Golf course search by state

<http://golfingnear.com>

Email search by domain

<http://emailbydomain.com>

Auto manuals search

<http://auto.somanuals.com>

TV manuals search

<http://tv.somanuals.com>