

HANNSpree

HANNSpree, Inc.
2F, No.362, RueliGuang Rd., Neihu District,
Taipei City 114, Taiwan, R.O.C.
TEL: 886-2-87520000
FAX: 886-2-87527092

For more information on **Batman** visit
www.dccomics.com

For further information visit
www.hannspree.com



NTSCTVTWEN1203
MAC-001138

TM & © DC Comics.
(s04)

Download from Www.Somanuals.com. All Manuals Search And Download.

HANNSpree

15" Liquid Crystal Display Television

WT01-15A1

User's Manual

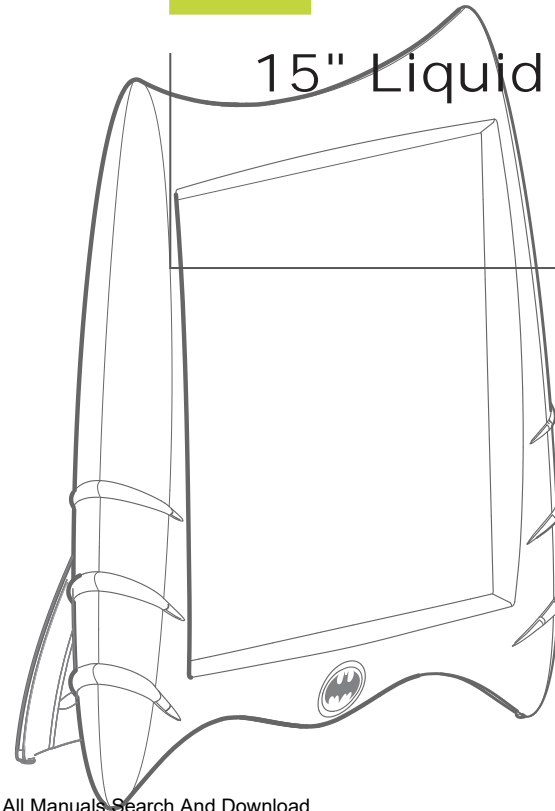

Table of Contents

1. Warranty and Service	3
2. Preface	4
3. Description of Warning Symbols.....	5
4. Safety Notices.....	6
5. Regulatory Information	14
6. Introducing the TV	16
Features.....	16
7. Checking Package Contents	17
8. Getting to Know Your TV	18
Front View.....	18
Input and Output Ports	19
9. Getting Started.....	21
Connecting to an Antenna or Cable TV	21
Connecting to AV Devices	22
Connecting to a VCR/VCD/DVD Player	22
Connecting to a Video Camera	23
Connecting to a Game Device	24
Connecting External Speakers or Headphones.....	25
Connecting to a PC.....	26
Connecting the Power Adapter	27
10. Using the TV	28
Using the Remote Control	28
Turning the TV On and Off	29
Selecting Channels.....	29
Switching Source Signals	30
Adjusting the Volume	30
11. Adjusting On-Screen Display (OSD) Settings.....	31
Brightness	32
Contrast	33
Audio Setting.....	34
Treble.....	35
Bass	36
Balance	37
SRS	38

Table of Contents

Mute	39
Video Setting	40
Hue	41
Saturation	42
Sharpness	43
Color Temperature	44
TV Setting	45
TV/CATV	46
MTS	47
Auto Program.....	49
Manual Program.....	50
Channel Add/Erse	51
PC Setting	52
Horizontal Position	53
Vertical Position	54
Phase	55
Clock	56
Color Temperature	57
Miscellaneous Setting	59
Language	60
Sleeper.....	61
OSD Display	62
Time Setting	63
OSD Background	64
Reset	65
12. Taking Care of Your TV	67
13. Troubleshooting.....	68
14. Specifications	70
15. Glossary	71

The instructions on this manual are for the model(s) listed on the front cover. Before you start reading, check your product number by looking at the rear of your TV.

Thank you for purchasing our Liquid Crystal Display Television (LCD TV). With this product, you will be able to enjoy superior audio and video while enriching your lifestyle with advanced technology.

The Hannspree TV is warranted for one year limited service from the date the product is received (as shown on the Warranty and Service Manual); please refer to the “Warranty and Service Manual” for the detailed warranty information.

Hannspree provides complete service information in the included “Warranty and Service Manual”, or directly from Hannspree global customer service center. Our service representatives will be very happy to serve you to your satisfaction.

Hannspree global customer service center telephone number:
From Taiwan please call 0800-008-800

Hannspree e-mail address:
service@hannspree.com

This manual is designed to assist users in setting up and using the LCD TV. Information in this document has been carefully checked for accuracy; however, no guarantee is given to the correctness of the contents. The information in this document is subject to change without notice.

Copyright

© Copyright 2003 Hannspree, Inc.

All rights reserved. This product and related documentation are protected by copyright and are distributed under licenses restricting their use, copying, and distribution. No part of this documentation may be reproduced in any form by any means without prior written authorization of Hannspree, Inc., and its licensors, if any.

Warning



This symbol is used to remind users to pay attention to important descriptions regarding usage and maintenance (repair) or additional important information related to this product.

Caution



This symbol is used to remind users to pay attention to the danger of electric shocks due to dangerous internal non-insulated components.

Electric Power Notice

Electric power may cause personal injury and mechanical damage if it is misused. Although safety has been taken into consideration during the design and production of this product, electric shock or fire can result when the product is misused. To prevent potential danger, follow the instructions below when installing, operating and cleaning the product. In addition, read the following “Safety Notices” carefully before using the product to ensure that your TV is safe and long-lasting.

**Power Supply Safety Notes**

1. To avoid electric shocks, do not use an extended power cord or an outlet that does not match this product's plug or leaves the plug exposed.
2. This product has a 3-pin grounded plug. The third pin connects to ground; do not remove it.
3. If the power cord or plug is damaged or worn, unplug it immediately and contact a qualified service technician for maintenance.
4. To avoid fire or electric shocks, do not overload electric power outlets.

**Installation Safety Notes****Antenna**

We suggest that you use an outdoor antenna to get the best signal possible unless you have cable TV or a centralized indoor antenna system. You may, however, use an antenna indoors if it is placed in a location free from interference.

Location

Avoid allowing the TV to get prolonged exposure to sunlight or other strong sources of heat. Leave sufficient distance between the TV and the wall to provide enough space for the emission of heat.



Before You Proceed

1. Read the Safety Notices and the User's Manual carefully before turning the product on.
2. Keep your User's Manual in a safe place for future reference. Keep the box and packaging in case the product needs to be shipped in the future.
3. Follow the product and warning label instructions.
4. Any changes or modifications that do not follow the instructions in this manual will void this product's warranty.



Warning

To reduce the risk of fire or electric shock, do not expose this product to rain or moisture.



Power

To avoid danger of fires or electric shock, make sure that you use a proper adapter. The TV is compatible with the following adapters:

- EDAC POWER ELECTRONICS CO., LTD.: EA 1050A-120
- LI SHIN INTERNATIONAL ENTERPRISE CORP.: 0218B1260

Optimal Viewing Distance

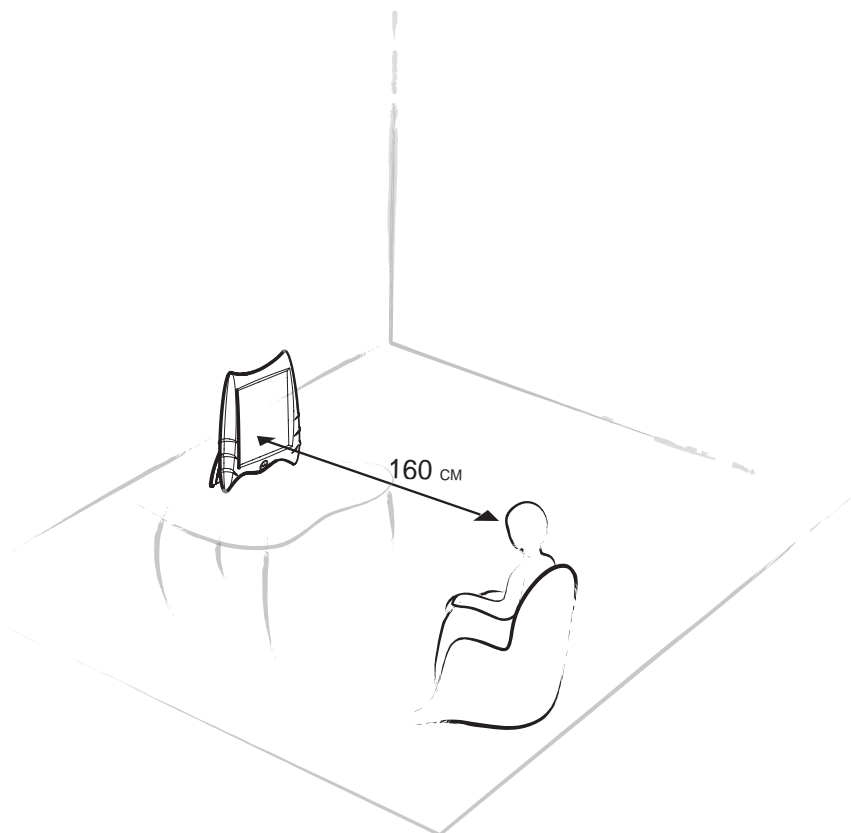

Important Safety Instructions



1. Read these instructions.
 2. Keep these instructions.
 3. Heed all warnings.
 4. Follow all instructions.
-



5. Do not use this apparatus near water.
-



6. Clean only with a dry cloth.
-



7. Do not block any ventilation openings. Install in accordance with the manufacturer's instructions.
-



8. Do not install near any heat sources such as radiators, heat registers, stoves, or other apparatus (including amplifiers) that produce heat.
-

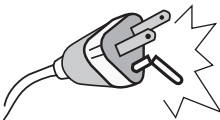

9. Do not defeat the safety purpose of the polarized or grounding-type plug: A polarized plug has two blades with one wider than the other. A grounding type plug has two blades and a third grounding prong. The wide blade or the third prong are provided for your safety. If the provided plug does not fit into your outlet, consult an electrician for replacement of the obsolete outlet.
-

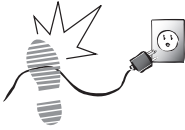

10. Protect the power cord from being walked on or pinched particularly at the plug, convenience receptacles, and the point where they exit from the apparatus.



11. Use only with a cart, stand, tripod, bracket, or table specified by the manufacturer, or sold with the apparatus. When a cart is used, use caution when moving the cart/apparatus combination to avoid injury from tip-over.



12. Only use attachments/accessories specified by the manufacturer.



13. Unplug this apparatus during lightning storms or when unused for long periods of time.



14. Refer all servicing to qualified service personnel. Servicing is required when the apparatus has been damaged in any way, such as if the power-supply cord or plug is damaged, liquid has been spilled or objects have fallen into the apparatus, the apparatus has been exposed to rain or moisture, does not operate normally, or has been dropped.

Personal Safety

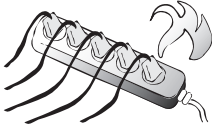

To avoid overloading the power supply, do not plug too many electrical devices into an outlet or extension cable.



Dangerous high-voltage electric power components are located inside the TV. To avoid electric shock, do not disassemble the casing.



Do not place or drop metals, small objects, or flammable materials in the vent to avoid an electric shock or a fire.



If the TV is dropped, falls down, or is otherwise damaged, unplug the power cord immediately and notify a qualified service technician.



If any fluid is sprayed or dropped into the TV, remove the power plug immediately and notify a qualified service technician.



The screen of the TV is made of glass, be careful to avoid hitting or scraping it. If the screen is broken, avoid cutting yourself on the broken glass.



Do not allow children to use the TV unattended to avoid accidents caused by improper operation.

Installation



To avoid damage to power circuits, do not place the TV in locations where there is excessive steam or dust.



Do not place the TV on a bed, sofa, carpet, or in a sealed cabinet to avoid blocking the product's vents.

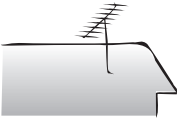

Install the outdoor antenna far from power transmission lines to avoid possible danger.



Remove the power cord and antenna connector when there is a storm or when the TV is not in use for a long period to avoid electric shock from lightning.

Operation



This product is designed for power sources as labeled on the casing. Avoid using any other power accessories to avoid electric shock or other damage.



The plug can be inserted into an outlet in only one direction. Notify a qualified service technician if you cannot plug it in correctly.



If there is any problem that cannot be resolved according to the instructions given in this manual, notify a qualified service technician immediately. Do not attempt any methods not covered in this manual.

Maintenance



Do not attempt to repair the TV by yourself. Notify a qualified service technician. Ask the service technician to complete a safety inspection before switching the power on after completing any maintenance.

FCC Compliance Statement¹

This device complies with part 15 of the FCC Rules. Operation is subject to the following two conditions: (1) This device may not cause harmful interference, and (2) this device must accept any interference received, including interference that may cause undesired operation.

This equipment has been tested and found to comply with the limits for a Class B digital device, pursuant to part 15 of the FCC Rules. These limits are designed to provide reasonable protection against harmful interference in a residential installation. This equipment generates, uses and can radiate radio frequency energy and, if not installed and used in accordance with the instructions, may cause harmful interference to radio communications. However, there is no guarantee that interference will not occur in a particular installation. If this equipment does cause harmful interference to radio or television reception, which can be determined by turning the equipment off and on, the user is encouraged to try to correct the interference by one or more of the following measures:

- Reorient or relocate the receiving antenna
- Increase the separation between the equipment and receiver
- Connect the equipment into an outlet on a circuit different from that to which the receiver is connected
- Consult the dealer or an experienced radio/TV technician for help

Warning: A shielded-type power cord is required in order to meet FCC emission limits and also to prevent interference to nearby radio and television reception. It is essential that only the supplied power cord be used. Use only shielded cables to connect I/O devices to this equipment. You are cautioned that changes or modifications not expressly approved by the party responsible for compliance could void your authority to operate the equipment.

1. applies only to products purchased in the United States of America

DOC Compliance Notice¹

This digital apparatus does not exceed the Class B limits for radio noise emissions from digital apparatus as set out in the Radio Interference Regulations of the Canadian Department of Communications. This device complies with Canada ICES-003 Class B.

CE Conformity Statement²

This device complies with the requirements set out in the Council Directive on the approximation of the Laws of the Member States relating to Electromagnetic Compatibility (89/336/EEC) and the Amendment Directive (92/31/EEC), Low-Voltage Directive (73/23/EEC) and the Amendment Directive (93/68/EEC).

-
1. applies only to products purchased in Canada
 2. applies only to products purchased in the European Union

Thank you for purchasing this 15-inch Liquid Crystal Display TV. Your LCD TV is designed to be safe, versatile, and easy to use. The design of the product is based on **Batman**, which makes it a fun addition to any room.

You can watch broadcast or cable television channels, and easily connect a VCR, VCD or DVD player or a game device to the standard RCA and S-Video input ports that are included in the 4-IN-1 cable. You can also connect your TV to a PC and use the TV as an external monitor.

Convenient control buttons located on the front panel and a handy remote control let you change channels, adjust the volume, and change display settings through an easy-to-use on-screen menu system. The built-in stereo speakers provide full rich sound and a convenient audio output port lets you connect to an external audio system or headphones.

Features

- 15-inch color TFT LCD TV
- Safe and sturdy construction
- Built-in TV tuner
- 4-IN-1 cable
- On-Screen Display (OSD) menu system
- Built-in 3W+3W speakers

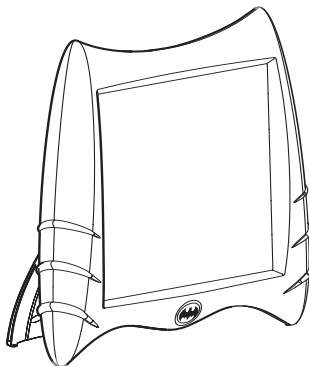

Checking Package Contents

Make sure the following components are included in the box. Contact your vendor immediately if anything is missing or damaged.

TV

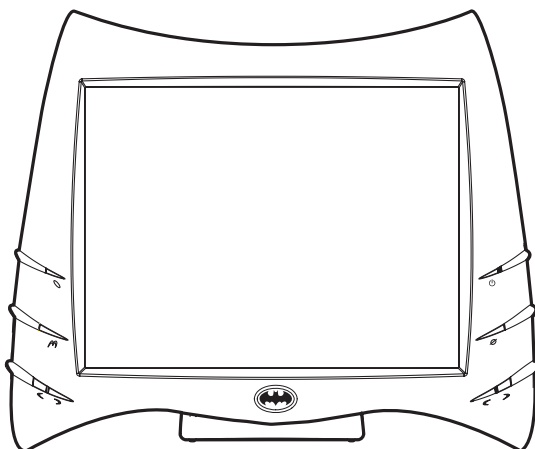

User's Manual



Quick Start Guide

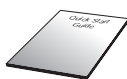

Warranty and Service Manual



Wire Material Package

VGA Cable



Power Cord

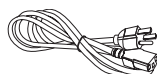

Power Adapter

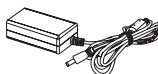

4-IN-1 Cable



RCA Jack x 3



Front View

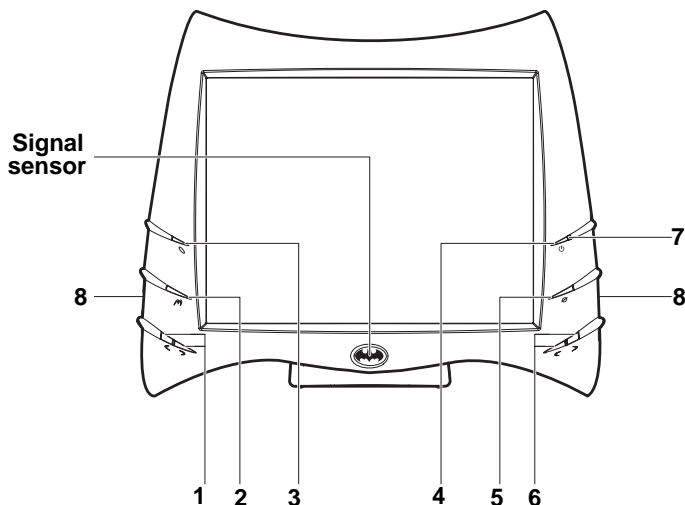

Description		Function
1	Adjust volume	Press VOL < to increase the audio volume. Press VOL > to decrease the audio volume.
2	Menu	Turns the On-Screen Display (OSD) menu on and off.
3	Source	Selects the input source to be displayed (TV/CATV, AV1, AV2 or PC).
4	Power	Turns the TV on and off.
5	Auto/Mute	Automatically adjusts the screen parameters in PC mode. In TV/AV mode, press this button to mute the audio.
6	Select channel	Changes channels. Press CH > to increase the channel number. Press CH < to decrease the channel number. In PC or AV mode, press either button to return to TV mode.
7	Power LED	Green LED indicates power on.
8	Stereo speakers	Play audio content.

Input and Output Ports

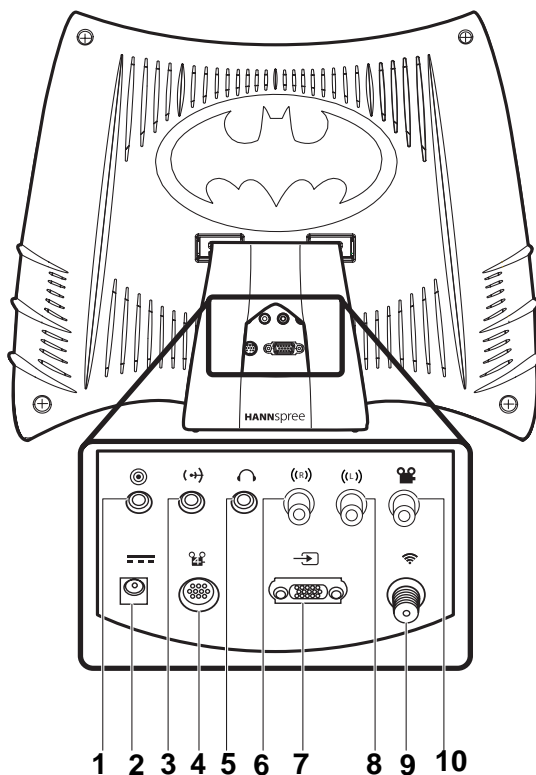

	Description	Function
1	LINE OUT	Connects to external amplifier or speakers.
2	DC 12V	Connects to the included power adapter.
3	LINE IN	Connects to a PC's DVI port.

4	AV2	<p>Use the included 4-IN-1 Audio/Video cable to connect external devices, such as a VCR, VCD, or DVD player.</p> <p>Audio Input: AV connectors white and red audio cables.</p> <p>Video Input: AV connector video (yellow) or S-Video cables.</p>
5	HEADPHONE	Connects to headphones.
6	R-AUDIO	Connects to a right audio (red) cable
7	VGA	Connects to a PC.
8	L-AUDIO	Connects to a left audio (white) cable
9	ANT	Connects to an antenna or CATV cable television line.
10	VIDEO	Connects to a video (yellow) cable

Connecting to an Antenna or Cable TV

- 1 Connect one end of the UHF or CATV cable to ANT Jack (VHF/UHF IN Jack) on the back of the TV.
- 2 Connect the other end of the VHF/UHF (Antenna) or CATV cable to the antenna socket or CATV cable.

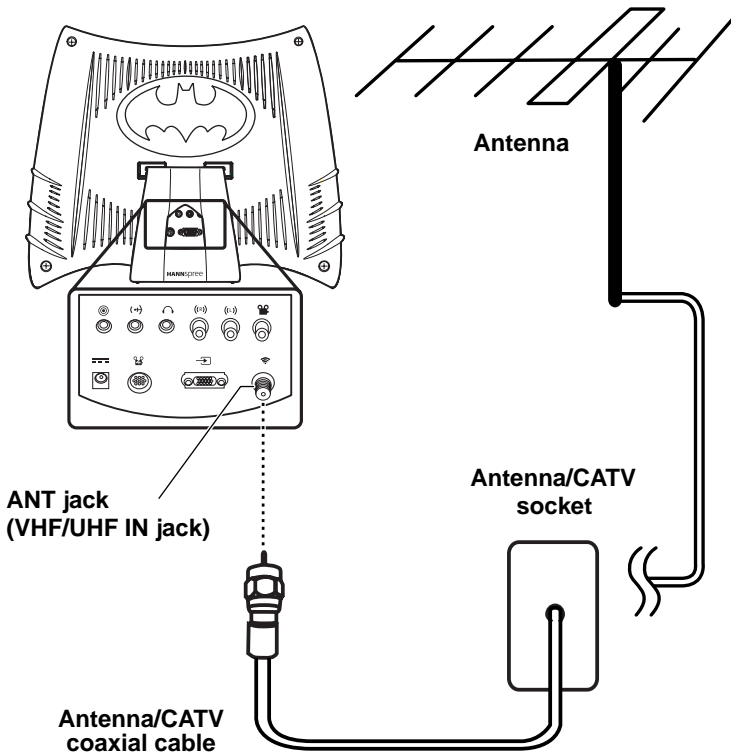

Note

If you cannot receive channels after connecting to an antenna or cable TV line, try scanning for channels. See "Auto Program" on page 49.

Connecting to AV Devices

Connect external devices such as a VCR, VCD or DVD player, or video game to the TV using the 4-IN-1 cable.

Connecting to a VCR/VCD/DVD Player

The illustration presented here shows how to connect the TV to a VCR, VCD or DVD player. Actual connections may vary according to the make and model of the device. Refer to the user's manual included with the device for more detailed instructions.

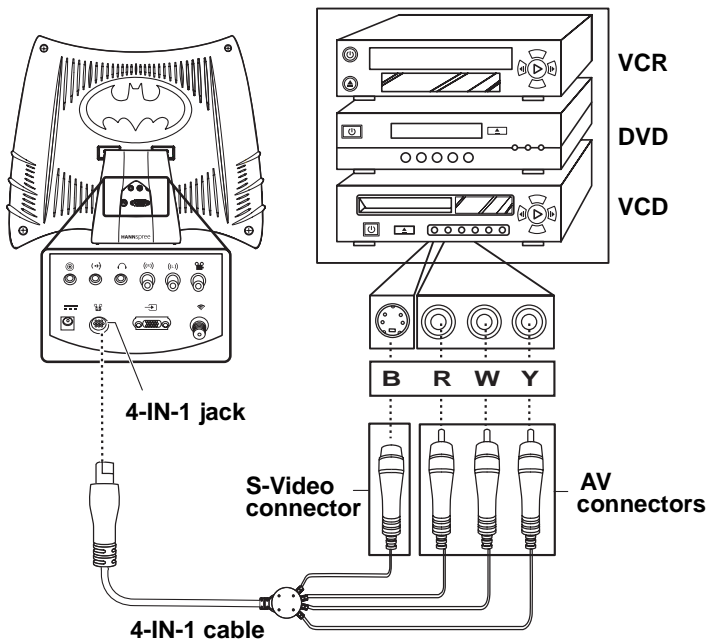

Note

The cables are color-coded (black, red, white, yellow). Connect each color-coded cable to the appropriate connector on your device.

Connecting to a Video Camera

The instructions presented here are a general guide to connecting the TV to a camcorder or other type of digital camera. Actual connections may vary according to the make and model of the device. Refer to the user's manual included with the camcorder or camera for more detailed instructions.

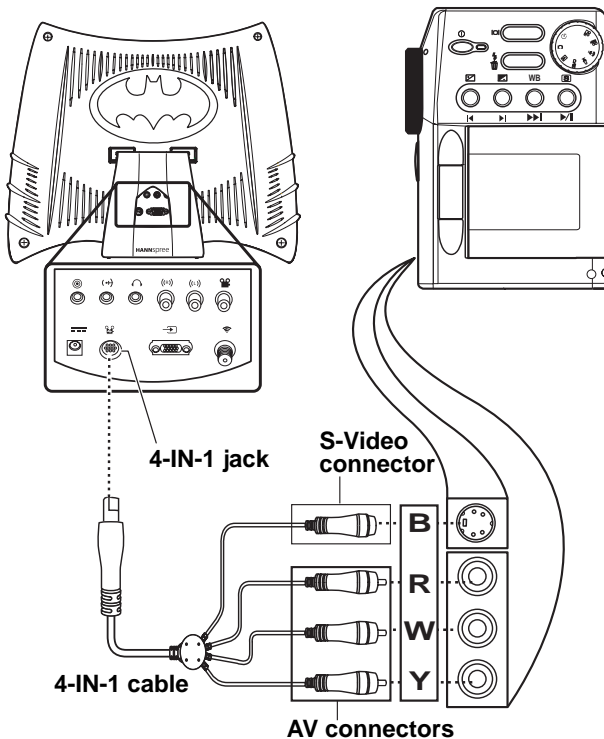

Note

The cables are color-coded (black, red, white, yellow). Connect each color-coded cable to the appropriate connector on your device.

Connecting to a Game Device

The instructions presented here are a general guide to connecting the TV to a game device using the RCA Jacks provided (some game devices may require a unique adapter that is not provided). Actual connections may vary according to the make and model of the game device. Refer to the user's manual included with the game device for more detailed instructions.

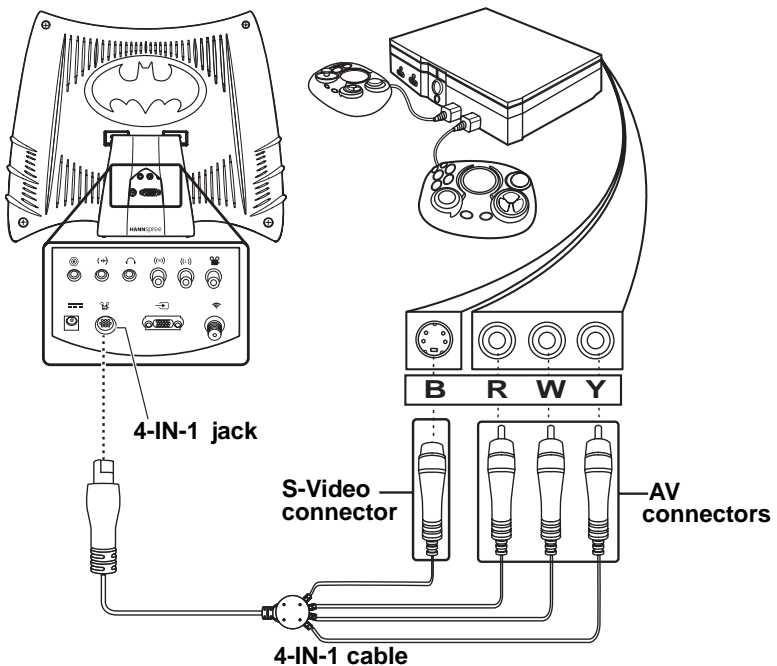

Notes

- Connect the 4-IN-1 cable connectors to the corresponding connectors on your game device adapter.
- If the 4-in-1 cable does not fit the game device, then insert the included RCA jack between the 4-in-1 cable and game device.

Connecting External Speakers or Headphones

External speakers or headphones may be used to listen to the TV rather than using the built-in speakers. Connect external speakers or headphones to the speaker line out port as illustrated.

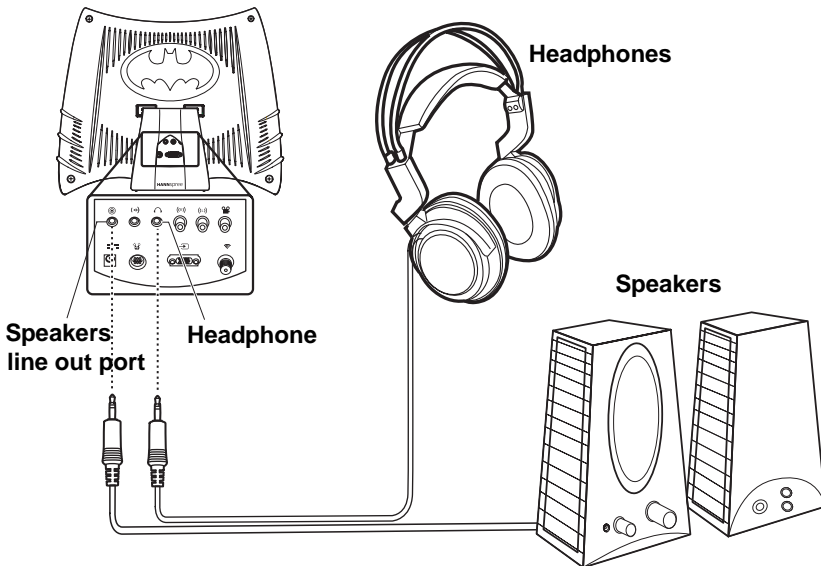

Notes

- External speakers or headphones are not included with the product.
- The internal TV speakers will not output sound when headphones are plugged in.
- Use external speakers with amplifiers only.

Connecting to a PC

You can connect the TV to a PC and use it as an external monitor. Connect the TV's VGA port to the PC's VGA port. Connect the TV's line in port to the PC's line out port to listen to the PC's audio output on the TV's speakers. Refer to the following illustration.

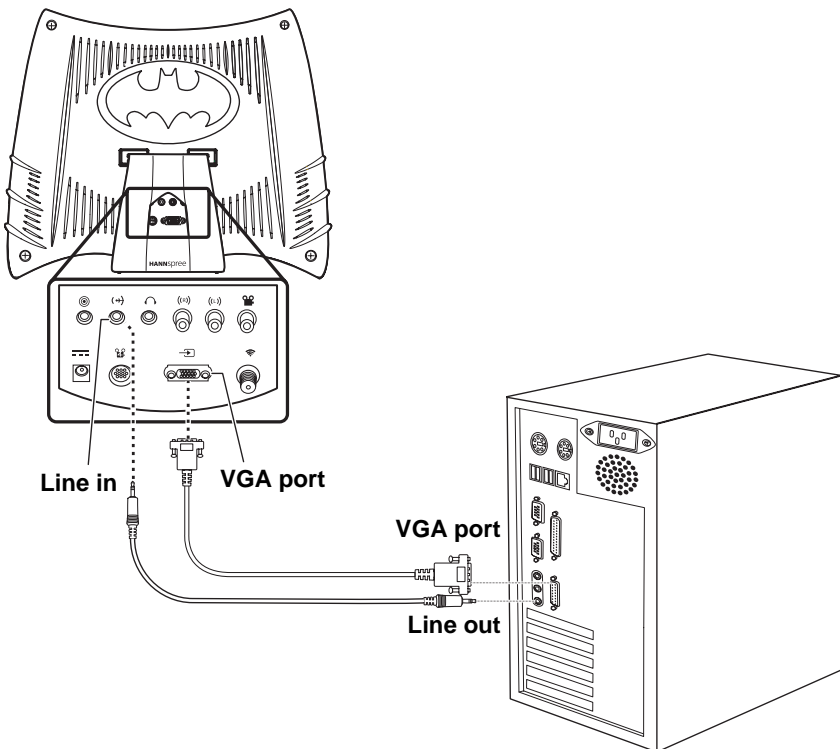

Note

You can connect the line out port of a CD-ROM player, stereo, or other device to the TV's line in port to listen to the devices audio output.

Connecting the Power Adapter

- 1 Connect the power cord to the power adapter as illustrated.
- 2 Plug the power adapter connector into the DC-IN input jack on the rear panel of the TV.
- 3 Insert the three-pronged plug at the other end of the power cord into a power outlet.

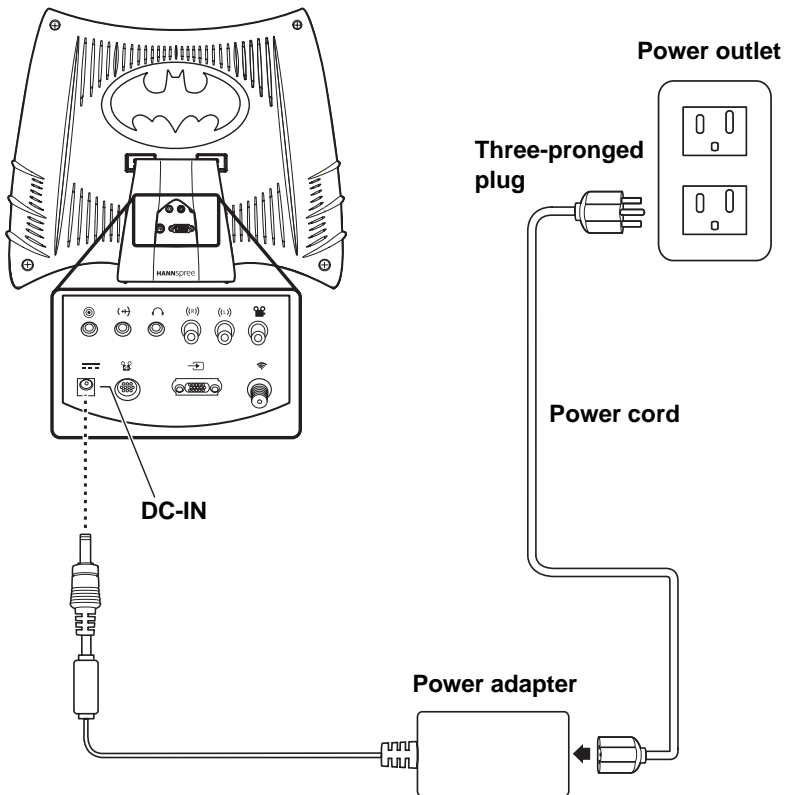

Using the Remote Control

For best results, use the remote control within a distance of 5 meters from the front of the TV's signal sensor. Do not exceed an angle of 30 degrees when pointing at the signal sensor. Refer to the following illustration.

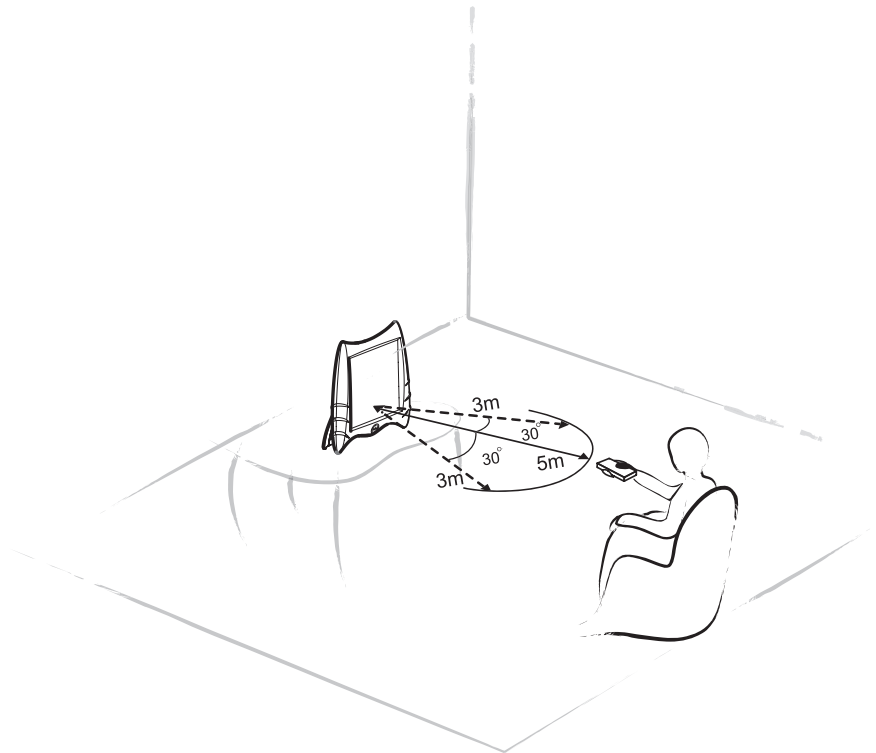

Turning the TV On and Off

- 1** Press the **POWER** button on the remote control (or control panel). The power LED on the front of the TV changes from red to green, indicating that the power has been turned on.
- 2** Press the **POWER** button again; the power LED changes from green to red, indicating that the TV is in off mode. When signal is not detected in PC mode, the power LED turns amber, indicating that the PC is in standby mode.

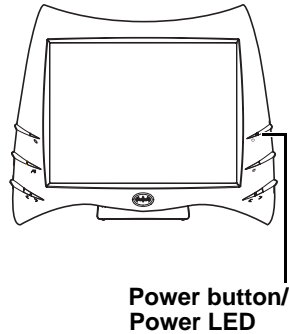

Selecting Channels

Press **CH UP** or **CH DOWN** button on the control panel to select the channel or enter the specific channel number buttons on the remote control.

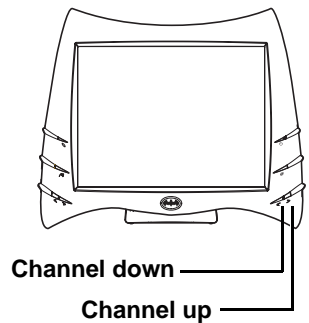

Switching Source Signals

Press **SOURCE** to select the incoming source signal..

The current source setting (TV/CATV, AV1, AV2 or PC) appears on the upper left corner of the screen.

Note

The TV supports S-Video input in addition to normal video and audio signals. The TV detects the signal type automatically and gives priority to S-Video when two signals are detected at the same time.

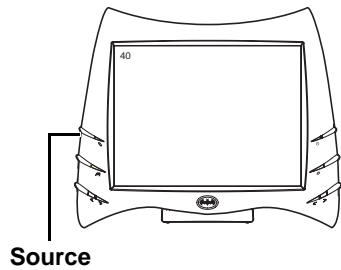

Adjusting the Volume

Press **VOL UP** button to increase the volume. Press **VOL DOWN** button to decrease the volume. The volume level is displayed on the TV.

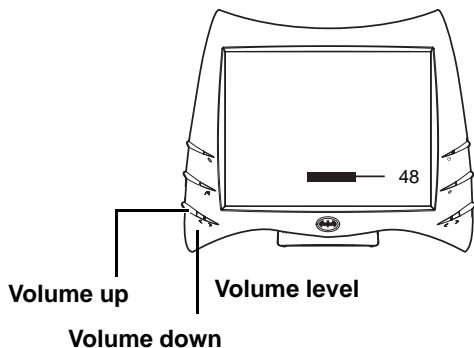

Adjusting On-Screen Display (OSD) Settings

The On-Screen Display (OSD) menu system provides a quick and simple method to adjust your TV's settings. This chapter describes how to change each of the available settings.

The OSD can be used with either the remote control or the control panel.

Button Descriptions	Control Panel
MENU	MENU
CH UP	CH >
CH DOWN	CH <
ENTER	MENU

Note:

The following sections explain how to adjust settings in the OSD menus using the control panel.

OSD Setting Menu

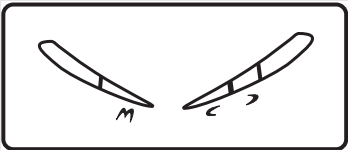

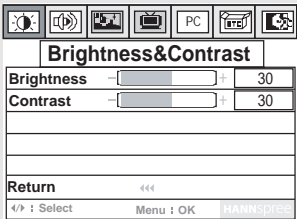

Press the **MENU** button to enter the OSD menus.

The Main Menu appears

Note

To exit the OSD menus, press the **CH UP** button or **CH DOWN** button to select Exit . Then press **MENU** to exit the OSD menus. Also, after you finish setting OSD parameters, follow these instructions to exit the OSD menus.

Brightness

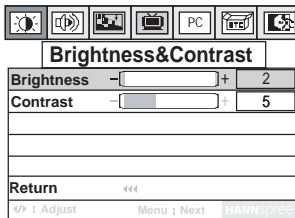

- 1 Press **MENU** to enter the OSD menus.
- 2 Press the **CH UP** button or **CH DOWN** button to select Brightness & Contrast.
- 3 Press **MENU** to enter the Brightness & Contrast menu.
- 4 Press the **CH UP** button to increase the brightness. Press the **CH DOWN** button to decrease the brightness.
- 5 Press **MENU** to select Return.
- 6 Press the **CH DOWN** button to exit the Brightness & Contrast menu.

Note

The new setting is confirmed automatically when the OSD times out.

Contrast

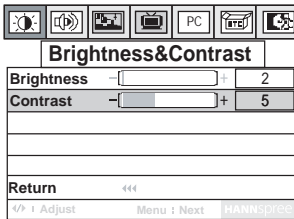

- 1 Press **MENU** to enter the OSD menus.
- 2 Press the **CH UP** button or **CH DOWN** button to select Brightness & Contrast.
- 3 Press **MENU** to enter the Brightness & Contrast menu.
- 4 Press **MENU** to select Contrast.
- 5 Press the **CH UP** button to increase the contrast. Press the **CH DOWN** button to decrease the contrast.
- 6 Press **MENU** to select Return.
- 7 Press the **CH DOWN** button to exit the Brightness & Contrast menu.

Note

The new setting is confirmed automatically when the OSD times out.

Audio Setting

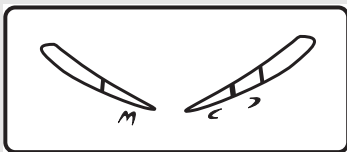

Press the **MENU** button to enter the OSD menus.

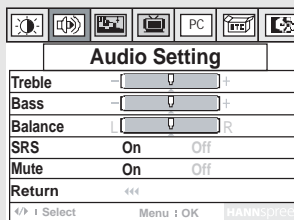

- 1 Press the **CH UP** button or **CH DOWN** button to select Audio Setting.
- 2 Press **MENU** to enter the Audio Setting menu.

Treble

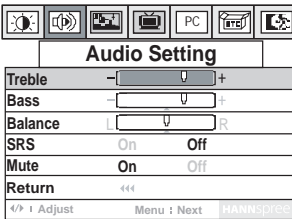

- 1 Press **MENU** to enter the OSD menus.
- 2 Press the **CH UP** button or **CH DOWN** button to select Audio Setting.
- 3 Press **MENU** to enter the Audio Setting menu.
- 4 Press the **CH UP** button to increase the treble. Press the **CH DOWN** button to decrease the treble.
- 5 Press **MENU** to select Return.
- 6 Press the **CH DOWN** button to exit the Audio Setting menu.

Note

The new setting is confirmed automatically when the OSD times out.

Bass

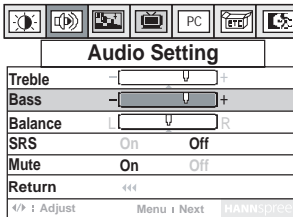

- 1 Press **MENU** to enter the OSD menus.
- 2 Press the **CH UP** button or **CH DOWN** button to select Audio Setting.
- 3 Press **MENU** to enter the Audio Setting menu.
- 4 Press **MENU** to select Bass.
- 5 Press the **CH UP** button to increase the bass. Press the **CH DOWN** button to decrease the bass.
- 6 Press **MENU** to select Return.
- 7 Press the **CH DOWN** button to exit the Audio Setting menu.

Note

The new setting is confirmed automatically when the OSD times out.

Balance

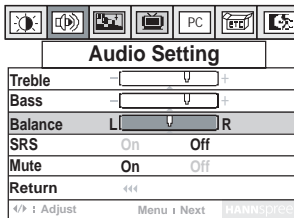

- 1 Press **MENU** to enter the OSD menus.
- 2 Press the **CH UP** button or **CH DOWN** button to select Audio Setting.
- 3 Press **MENU** to enter the Audio Setting menu.
- 4 Press **MENU** to select Balance.
- 5 Press the **CH UP** button to change the balance to the right speaker. Press the **CH DOWN** button to change the balance to the left speaker.
- 6 Press **MENU** to select Return.
- 7 Press the **CH DOWN** button to exit the Audio Setting menu.

Note

The new setting is confirmed automatically when the OSD times out.

SRS

This option enables the 3D Surround Sound feature.

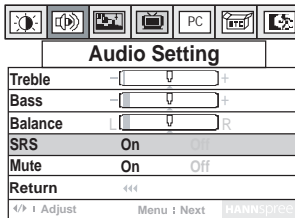

- 1 Press **MENU** to enter the OSD menus.
- 2 Press the **CH UP** button or **CH DOWN** button to select Audio Setting.
- 3 Press **MENU** to enter the Audio Setting menu.
- 4 Press **MENU** to select SRS.
- 5 Press the **CH DOWN** button to turn the SRS on. Press the **CH UP** button to turn the SRS off.
- 6 Press **MENU** to select Return.
- 7 Press the **CH DOWN** button to exit the Audio Setting menu.

Note

The new setting is confirmed automatically when the OSD times out.

Mute

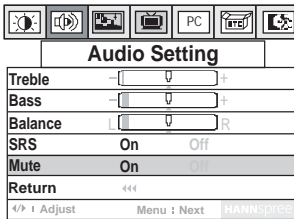

- 1 Press **MENU** to enter the OSD menus.
- 2 Press the **CH UP** button or **CH DOWN** button to select Audio Setting.
- 3 Press **MENU** to enter the Audio Setting menu.
- 4 Press **MENU** to select Mute.
- 5 Press the **CH DOWN** button to turn the mute on. Press the **CH UP** button to turn the mute off.
- 6 Press **MENU** to select Return.
- 7 Press the **CH DOWN** button to exit the Audio Setting menu.

Note

The new setting is confirmed automatically when the OSD times out.

Video Setting

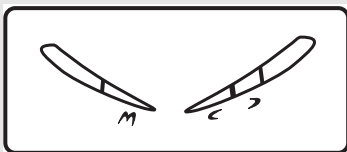

Press the **MENU** button to enter the OSD menus.

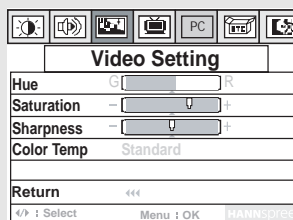

- 1** Press the **CH UP** button or **CH DOWN** button to select Video Setting.
- 2** Press **MENU** to enter the Video Setting menu.

Hue

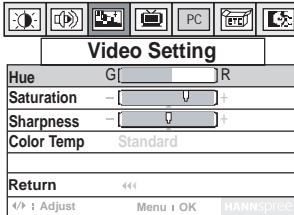

- 1 Press **MENU** to enter the OSD menu.
- 2 Press the **CH UP** button or **CH DOWN** button to select Video Setting.
- 3 Press **MENU** to enter the Video Setting menu.
- 4 Press the **CH DOWN** button to increase the red hue. The image becomes more red. Press the **CH UP** button to increase the hue towards the green hue. The image becomes more green.
- 5 Press **MENU** to select Return.
- 6 Press the **CH DOWN** button to exit the Video Setting menu.

Note

The new setting is confirmed automatically when the OSD times out.

Saturation

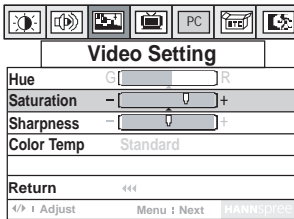

- 1 Press **MENU** to enter the OSD menus.
- 2 Press the **CH UP** button or **CH DOWN** button to select Video Setting.
- 3 Press **MENU** to enter the Video Setting menu.
- 4 Press **MENU** to select Saturation.
- 5 Press the **CH UP** button to increase the saturation. The screen image becomes more vibrant. Press the **CH DOWN** button to decrease the saturation. The screen image becomes less vibrant.
- 6 Press **MENU** to select Return.
- 7 Press the **CH DOWN** button to exit the Video Setting menu.

Note

The new setting is confirmed automatically when the OSD times out.

Sharpness

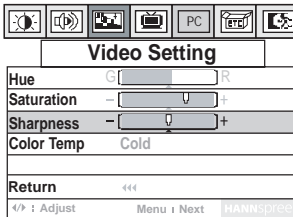

- 1 Press **MENU** to enter the OSD menus.
- 2 Press the **CH UP** button or **CH DOWN** button to select Video Setting.
- 3 Press **MENU** to enter the Video Setting menu.
- 4 Press **MENU** to select Sharpness.
- 5 Press the **CH UP** button to increase the sharpness. Press the **CH DOWN** button to decrease the sharpness.
- 6 Press **MENU** to select Return.
- 7 Press the **CH DOWN** button to exit the Video Setting menu.

Note

The new setting is confirmed automatically when the OSD times out.

Color Temperature

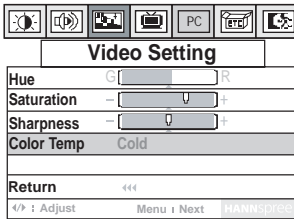

- 1 Press **MENU** to enter the OSD menus.
- 2 Press the **CH UP** button or **CH DOWN** button to select Video Setting.
- 3 Press **MENU** to enter the Video Setting menu.
- 4 Press **MENU** to select Color Temp. The following choices are available.
Warm
Press the **CH UP** button or **CH DOWN** button to select Warm.
Standard
Press the **CH UP** button or **CH DOWN** button to select Standard.
Cold
Press the **CH UP** button or **CH DOWN** button to select Cold.
- 5 Press **MENU** to select Return.
- 6 Press the **CH DOWN** button to exit the Video Setting menu.

Note

The default color temperature is Standard.

TV Setting

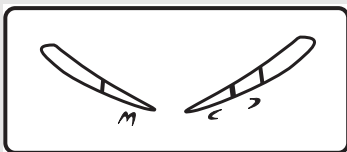

Press the **MENU** button to enter the OSD menus.

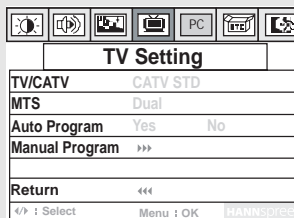

- 1** Press the **CH UP** button or **CH DOWN** button to select TV Setting.
- 2** Press **MENU** to enter the TV Setting menu.

TV/CATV

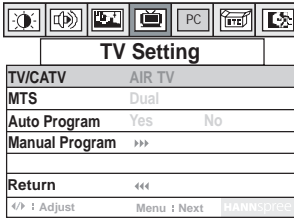

- 1 Press **MENU** to enter the OSD menus.
- 2 Press the **CH UP** button or **CH DOWN** button to select TV Setting.
- 3 Press **MENU** to enter the TV Setting menu.
- 4 Select one of the following choices.

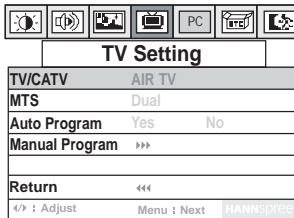

Receiving Air TV

Press the **CH UP** button or **CH DOWN** button to select AIR TV when using an antenna to receive TV.

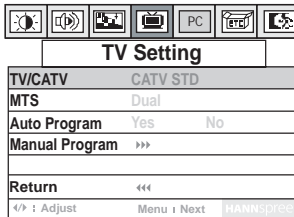

Receiving Cable TV

Press the **CH UP** button or **CH DOWN** button to select CATV STD (default) when connected to cable.

- 5 Press **MENU** to select Return.
- 6 Press the **CH DOWN** button to exit the TV Setting menu.

Note

The new setting is confirmed automatically when the OSD times out.

MTS

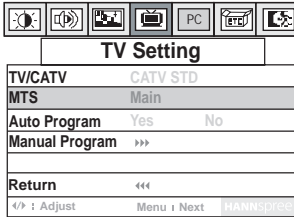

- 1 Press **MENU** to enter the OSD menus.
- 2 Press the **CH UP** button or **CH DOWN** button to select TV Setting.
- 3 Press **MENU** to enter the TV Setting menu.
- 4 Press **MENU** to select MTS. The following choices are available.

MAIN

Press the **CH UP** button or **CH DOWN** button to select Main (default), the default audio signal belonging to a particular channel.

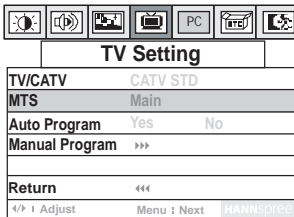

SAP

Press the **CH UP** button or **CH DOWN** button to select SAP (Secondary Audio Program), an audio channel used with the NTSC TV standard for auxiliary transmission of such items as foreign language broadcasting.

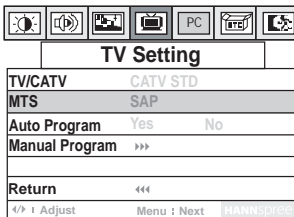

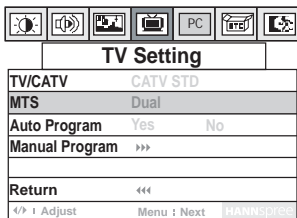

DUAL

Press the **CH UP** button or **CH DOWN** button to select Dual, which enables broadcast of the main signal on one speaker, and the alternate audio signal on the other speaker.

- 5** Press **MENU** to select Return.
- 6** Press the **CH DOWN** button to exit the TV Setting menu.

Note

The new setting is confirmed automatically when the OSD times out.

Auto Program

TV Setting		
TV/CATV	CATV STD	
MTS	Dual	
Auto Program	Yes	No
Manual Program	»»	
Return	««	
←/→ : Adjust	Menu Next	HANNspree

- 1 Press **MENU** to enter the OSD menus.
- 2 Press the **CH UP** button or **CH DOWN** button to select TV Setting.
- 3 Press **MENU** to enter the TV Setting menu.
- 4 Press **MENU** to select Auto Program.
- 5 Press the **CH DOWN** button to select Yes.

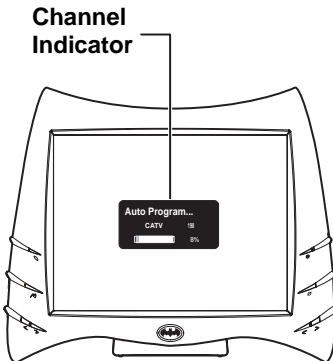

Channel indicator values scans from 2 to 69 (antenna connection) or from 1 to 125 (CATV cable connection).

Manual Program

This function allows you search present channels and erase channels.

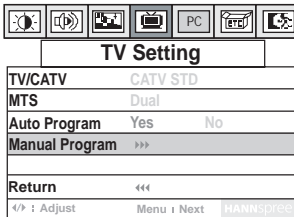

- 1** Press **MENU** to enter the OSD menus.
- 2** Press the **CH UP** button or **CH DOWN** button to select TV Setting.
- 3** Press **MENU** to enter the TV Setting menu.
- 4** Press **MENU** to select Manual Program.
- 5** Press the **CH UP** button to enter the Manual Program menu..
- 6** Press the **CH UP** button and the **CH DOWN** button to find the channel you want to add.

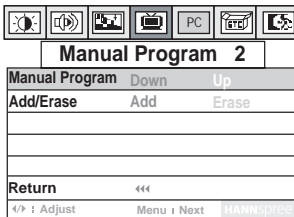

When you have found the channel, see the next section “Channel Add/Erase” to add or erase the channel.

Channel Add/Erase

After you have found a channel using Manual Program, follow the following instruction to add or erase the channel.

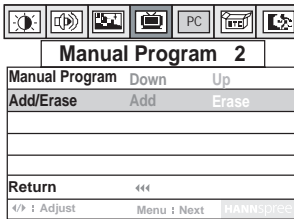

- 1 Press **MENU** to select Add/Erase.
- 2 Select one of the following options.

Add Channel

Press the **CH DOWN** button to select Add. The channel is added to the channel list.

Erase Channel

Press the **CH UP** button to select Erase. The channel is erased from the channel list.

When you return to the normal TV screen and use the **CH UP** button and the **CH DOWN** button to browse channels, a deleted channel (for example, Channel 3) is skipped automatically.

Note

You can still access a deleted channel by entering the channel number using the number keys on the remote control.

PC Setting

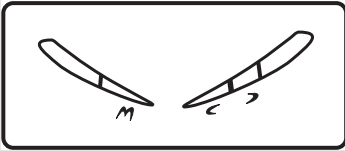

Press the **MENU** button to enter the OSD menus.

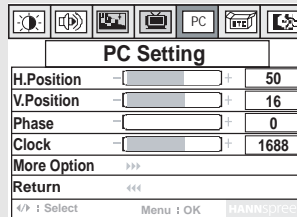

- 1 Connect product to a PC.
- 2 Press **SOURCE** to select PC.
- 3 Press the **CH UP** or **CH DOWN** button to select PC.
- 4 Press **MENU** to enter the PC menu.

Horizontal Position

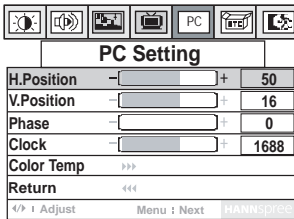

- 1 Press **MENU** to enter the OSD menu.
- 2 Press the **CH UP** button or **CH DOWN** button to select PC Setting.
- 3 Press **MENU** to enter the PC Setting menu.
- 4 Press the **CH UP** button to move the display to the right. Press the **CH DOWN** button to move the display to the left.
- 5 Press **MENU** to select Return.
- 6 Press the **CH DOWN** button to exit the PC setting menu.

Note

The new setting is confirmed automatically when the OSD times out.

Vertical Position

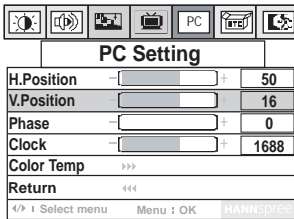

- 1 Press **MENU** to enter the OSD menu.
- 2 Press the **CH UP** button or **CH DOWN** button to select PC Setting.
- 3 Press **MENU** to enter the PC Setting menu.
- 4 Press **MENU** to select V.Position.
- 5 Press the **CH UP** button to move the display up. Press the **CH DOWN** button to move the display down.
- 6 Press **MENU** to select Return.
- 7 Press the **CH DOWN** button to exit the PC setting menu.

Note

The new setting is confirmed automatically when the OSD times out.

Phase

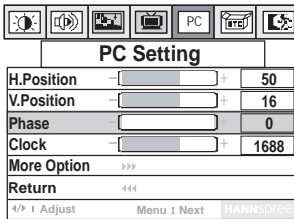

PC Setting	
H.Position	50
V.Position	16
Phase	0
Clock	1688
More Option	>>>
Return	<<<
</> Adjust	Menu : Next
Main/Setup	

- 1 Press **MENU** to enter the OSD menu.
- 2 Press the **CH UP** button or **CH DOWN** button to select PC Setting.
- 3 Press **MENU** to enter the PC Setting menu.
- 4 Press **MENU** to select Phase.
- 5 Press the **CH UP** button to increase the phase. Press the **CH DOWN** button to decrease the phase.
- 6 Press **MENU** to select Return.
- 7 Press the **CH DOWN** button to exit the PC setting menu.

Note

The new setting is confirmed automatically when the OSD times out.

Clock

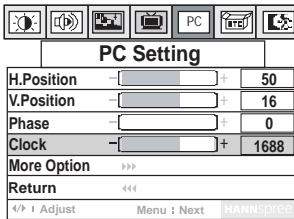

- 1 Press **MENU** to enter the OSD menu.
- 2 Press the **CH UP** button or **CH DOWN** button to select PC Setting.
- 3 Press **MENU** to enter the PC Setting menu.
- 4 Press **MENU** to select Clock.
- 5 Press the **CH UP** button to increase the clock. Press the **CH DOWN** button to decrease the clock.
- 6 Press **MENU** to select Return.
- 7 Press the **CH DOWN** button to exit the PC setting menu.

Note

The new setting is confirmed automatically when the OSD times out.

Color Temperature

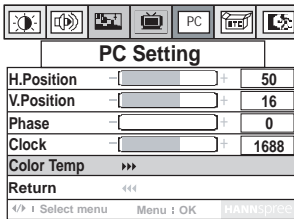

- 1 Press **MENU** to enter the OSD menu.
- 2 Press the **CH UP** button or **CH DOWN** button to select PC Setting.
- 3 Press **MENU** to enter the PC Setting menu.
- 4 Press **MENU** to select the More option.

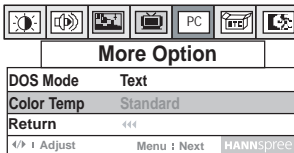

- 5 Press the **CH UP** button to enter the Color Temp menu.
- 6 Press **MENU** to select Color Temp.

Warm

Press the **CH DOWN** button to select Warm.

Standard

Press the **CH UP** button or **CH DOWN** button to select Standard.

Cold

Press the **CH UP** button to select Cold.

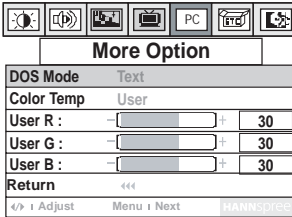

User

The User option enables users to make their own color settings.

Press the **CH UP** button to select User. The user menu appears.

- press **MENU** to select User R, User G, or User B.
- press the **CH UP** button or **CH DOWN** button to increase or decrease the selected color temperature.

7 Press **MENU** to select Return.

8 Press the **CH DOWN** button to exit the More Option menu.

Note

The new setting is confirmed automatically when the OSD times out.

Miscellaneous Setting

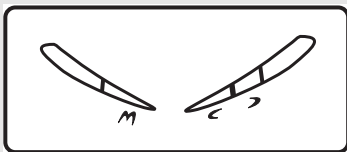

Press the **MENU** button to enter the OSD menus.

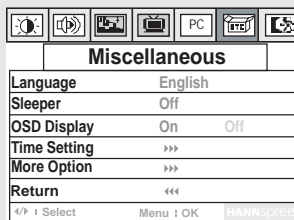

- 1 Press the **CH UP** button or **CH DOWN** button to select Miscellaneous.
- 2 Press **MENU** to enter the Miscellaneous menu.

Language

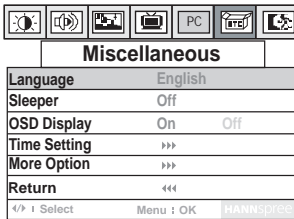

- 1 Press **MENU** to enter the OSD menus.
- 2 Press the **CH UP** button or **CH DOWN** button to select Miscellaneous.
- 3 Press **MENU** to enter the Miscellaneous menu.
- 4 Press the **CH UP** button or **CH DOWN** button to select Chinese or English.
- 5 Press **MENU** to select Return.
- 6 Press the **CH DOWN** button to exit the Miscellaneous menu.

Note

The default language setting is Traditional Chinese.

Sleeper

The sleeper turns the TV off automatically after a set period of time.

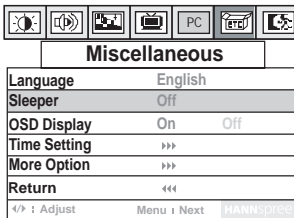

Miscellaneous		
Language	English	
Sleeper	Off	
OSD Display	On	Off
Time Setting	>>>	
More Option	>>>	
Return	<<<	
←/→ : Adjust	Menu : Next	EXIT/Back

- 1 Press **MENU** to enter the OSD menu.
- 2 Press the **CH UP** button or **CH DOWN** button to select Miscellaneous.
- 3 Press **MENU** to enter the Miscellaneous menu.
- 4 Press **MENU** to select Sleeper.
- 5 Press the **CH UP** button or **CH DOWN** button to select a power off time:
 - Off
 - 30 minutes
 - 60 minutes
 - 90 minutes
 - 120 minutes
- 6 Press **MENU** to select Return.
- 7 Press the **CH DOWN** button to exit the Miscellaneous menu.

OSD Display

When set to Off, the OSD display (source data on top left corner of the TV screen) turns off after approximately 5 seconds. When set to On, the OSD does not turn off automatically.

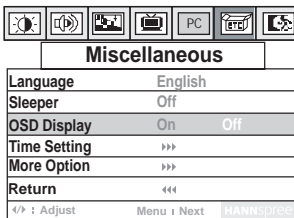

- 1 Press **MENU** to enter the OSD menu.
- 2 Press the **CH UP** button or **CH DOWN** button to select Miscellaneous.
- 3 Press **MENU** to enter the Miscellaneous menu.
- 4 Press **MENU** to select OSD Display.
- 5 Press the **CH DOWN** button to select On. Press the **CH UP** button to select Off.
- 6 Press **MENU** to select Return.
- 7 Press the **CH DOWN** button to exit the Miscellaneous menu.

Time Setting

This setting allows you to set the TV clock.

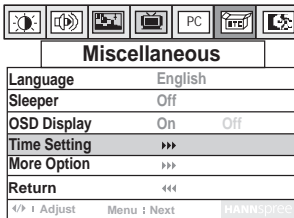

- 1 Press **MENU** to enter the OSD menus.
- 2 Press the **CH UP** button or **CH DOWN** button to select Miscellaneous.
- 3 Press **MENU** to enter the Miscellaneous menu.
- 4 Press **MENU** to select Time Setting.
- 5 Press the **CH UP** button to enter the Time Setting menu.
- 6 Press **MENU** to select the Hour or Minute.
- 7 Press the **CH UP** button or **CH DOWN** button to decrease or increase the time.
- 8 Press **MENU** to select Return.
- 9 Press the **CH DOWN** button to exit the Time Setting menu.

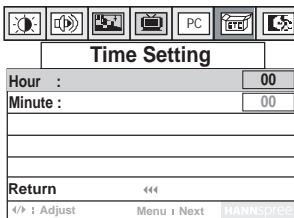

Note

The new setting is confirmed automatically when the OSD times out.

OSD Background

This setting allows you to make the OSD background transparent or opaque.

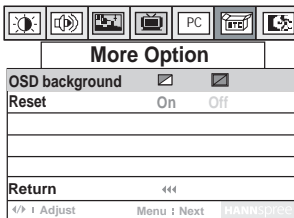
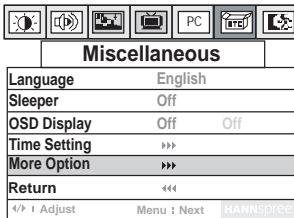

- 1 Press **MENU** to enter the OSD menu.
- 2 Press the **CH UP** button or **CH DOWN** button to select Miscellaneous.
- 3 Press **MENU** to enter the Miscellaneous menu.
- 4 Press **MENU** to select More Option.
- 5 Press the **CH UP** button to enter the More Option menu.
- 6 Press **MENU** to select OSD background.
- 7 Press the **CH DOWN** button to make the background transparent. Press the **CH UP** button to make the background opaque.
- 8 Press **MENU** to select Return.
- 9 Press the **CH DOWN** button to exit the More Option menu.

Note

The new setting is confirmed automatically when the OSD times out.

Reset

The Reset function returns all of your TV's user settings to their factory defaults.

Warning:

The reset function will erase all of your custom and favorite channel settings, and will reset all display settings (such as contrast, brightness, etc.) to the factory default values. The reset function cannot be reversed once it begins.

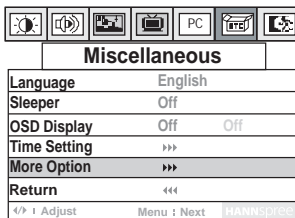

- 1 Press **MENU** to enter the OSD menus.
- 2 Press the **CH UP** button or **CH DOWN** button to select Miscellaneous.
- 3 Press **MENU** to enter the Miscellaneous menu.
- 4 Press **MENU** to select More Option.
- 5 Press the **CH UP** button to enter the More Option menu.
- 6 Press **MENU** to select Reset.
- 7 Press the **CH DOWN** button to reset the OSD settings.

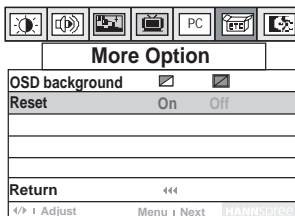

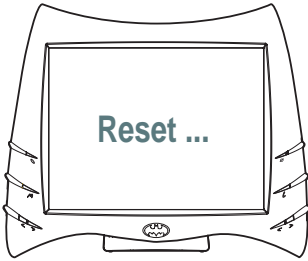

By default, OFF is already selected (highlighted in yellow). The TV immediately resets when ON is selected and you see the message on the screen.

- 8** Press **MENU** to select Return.
- 9** Press the **CH DOWN** button to exit the More Option menu.



Turn the power off before you begin cleaning the TV.



For best results, use a clean lens cloth to remove dust and fingerprints from the screen.



Do not wipe the shell of the TV with alcohol, methanol, gasoline or oil products to avoid damaging the finish. Wipe the shell with a dry soft cloth and use neutral cleaning fluids.

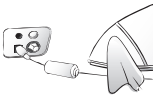

If your model has leather components, wipe the leather parts with a dry cloth and keep the area dry. Place the TV far from sources of steam to avoid making the leather wet.



Be careful to remove the power plug correctly. Hold the plug instead of pulling the power cord.

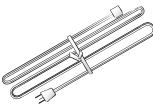

Arrange the power cord with other cords to avoid knotting or bending which may cause fire due to damage or electric leakage.

Situation	Solution
No picture and sound.	<ul style="list-style-type: none"> • Connect the power cord properly. • Press the POWER button on the control panel or remote control. • Press the SOURCE button to cycle through connected video sources. • Press CH UP or CH DOWN to switch to other TV stations. • Check the TV/CATV OSD settings. See "TV/CATV" on page 46. • Make sure all cables are connected properly.
No picture, or poor picture, sound is OK.	<ul style="list-style-type: none"> • Check the antenna and cable connections. • Adjust the brightness in the OSD menus. See "Brightness" on page 32.
Picture is not in color.	<ul style="list-style-type: none"> • Adjust the saturation in the OSD menus. See "Saturation" on page 42.
Picture is OK, no sound.	<ul style="list-style-type: none"> • Press the VOL UP button on the control panel or remote control. • Make sure the MTS option is set to Main or Dual. See "MTS" on page 47.
One of the speakers has no sound.	<ul style="list-style-type: none"> • Adjust the balance in the OSD menus. See "Balance" on page 37.
Can't receive some TV channels using cable TV.	<ul style="list-style-type: none"> • Try the Auto Program function in the OSD "TV Setting" menu. See "Auto Program" on page 49.
Want to reset TV settings.	<ul style="list-style-type: none"> • Use the Reset function in the OSD menu.
Cannot operate menus.	<ul style="list-style-type: none"> • If OSD items are colored in light blue, the system is in a state such that those settings are not available.
No image but have sound.	<ul style="list-style-type: none"> • Make sure the video signal cable is connected properly.

Situation	Solution
No sound but have image.	<ul style="list-style-type: none"> • Make sure the source device is functioning properly. • Set the volume to a higher level. • Make sure the audio cable is connected securely. • Turn the mute off.
Screen image turns over.	<ul style="list-style-type: none"> • Make sure the video signal cable is connected properly.
Snow appears on the screen.	<ul style="list-style-type: none"> • Adjust the location of the antenna, placing it far from roads or sources of interference. • Check the antenna and the video signal line connections.
Blurred or overlapped images.	<ul style="list-style-type: none"> • Readjust the sharpness setting. • Choose programs with high quality signals. • Adjust the direction of the antenna or change the video signal cable.

WT01-15A1	
LCD Panel Size	15-inch TFT
Aspect Ratio	4:3
Best Resolution	1024 (horizontal) x 768 (vertical)
Maximum Display Area	304.1 mm (H) x 228.1 mm (W)
TV System	NTSC
Video System	VGA input (15 pin D-SUB), S-Video Input and Composite Video Input (through the 4-IN-1 cable)
Audio System	Line in, Line out 10-pin mini-DIN (Audio Input through the 4-IN-1 Cable) 3.5 mm \varnothing headphone jack x 1 (Audio Output)
Built-in Speakers	3W+3W
Power Supply	100-240V, 50/60 Hz, 12V DC
Power Consumption	60 W Maximum
Power Consumption (Standby)	3 W Maximum
Weight (including base)	3.8 kg
Dimensions (including base)	358 mm (H) x 435 mm (W) x 171 mm (D)

PC Mode Support Timing

	Pixel Format	Hor. Freq. (kHz)	Hor. Polarity	Ver. Freq. (Hz)	Vertical Polarity	Standard
1	640*400	31.47	-	70	+	DOS_Graphic
2	720*400	31.47	-	70	+	DOS_Text
3	640*480	31.47	-	60	-	VESA
4	640*480	37.861	-	72	-	VESA
5	640*480	37.5	-	75	-	VESA
6	800*600	35.156	+	56	+	VESA
7	800*600	37.879	+	60	+	VESA
8	800*600	48.077	+	72	+	VESA
9	800*600	46.875	+	75	+	VESA
10	1024*768	48.363	-	60	-	VESA
11	1024*768	56.476	-	70	-	VESA
12	1024*768	60.023	+	75	+	VESA
13	832*624	49.7	-	75	-	MAC
14	1024*768	60.2	-	75	-	MAC
15	640*480	35	-	67	-	MAC

Aspect Ratio The ratio of width to height of a film, image or display screen.

Broadcast TV Broadcasting video signals using high-frequency electromagnetic waves to distribute television channels to viewers (standard TV broadcast).

CATV Community Antenna Television, the original name for cable TV. A television distribution system that uses coaxial cable instead of the traditional radio broadcasting (over-the-air) method to deliver television, FM radio, and other services to consumers.

Color Temperature Adjusting the color temperature enables you to set the intensity of white light. Color temperature is measured in Kelvin (K). Higher color temperatures result in a blue tint. Lower temperatures result in a red tint.

DUAL Used with SAP and NTSC, enables broadcast of the main broadcast signal on one speaker, and the alternate audio speaker on the other speaker.

Hue Colors in a color system are measured by hue, saturation and luminance. Hue indicates the predominant color.

LCD Liquid Crystal Display. A display technology that uses rod-shaped molecules (liquid crystals) that flow like liquid and bend light.

Main is the default audio signal belonging to a particular channel.

MTS Multi-channel Television Sound. Enables reception of audio other than the primary (MAIN) audio signal. DUAL enables reception of a stereo audio signal, while SAP (Second Audio Program) enables reception of a separate channel that may be a different language or completely different information such as the news.

RCA connector An RCA or phono connector is a plug and socket for a two-wire (signal and ground) coaxial cable that is widely used to connect audio and video components. RCA sockets are commonly found at the rear of audiovisual equipment.

RCA jack An RCA jack enables you to attach the 4-IN-1 cable to a device socket. Refer to "Checking Package Contents" on page 17 and "Connecting to a Game Device" on page 24.

SAP (Secondary Audio Program) is an audio channel used with the NTSC TV standard for auxiliary transmission of such items as foreign language broadcasting or teletext.

Saturation Chromatic purity indicating the amount of white contained in a color. Fully saturated colors are pure colors; less saturated colors appear as pastel shades.

S-Video Super-video, a video cabling standard used to transmit video by keeping brightness (Y) and color information (C) on separate channels. Most often used with camcorders, VCRs, and quality receivers and amplifiers to provide sharper pictures.

VCD A compact disk format developed in 1993 by Sony and Philips to capture full-motion video. A standard Video CD can hold 74 minutes of near VHS-quality video and CD-quality sound.

SRS  is a trademark of
SRS Labs, Inc.
SRS technology is incorporated under license from SRS
Labs, Inc.

Free Manuals Download Website

<http://myh66.com>

<http://usermanuals.us>

<http://www.somanuals.com>

<http://www.4manuals.cc>

<http://www.manual-lib.com>

<http://www.404manual.com>

<http://www.luxmanual.com>

<http://aubethermostatmanual.com>

Golf course search by state

<http://golfingnear.com>

Email search by domain

<http://emailbydomain.com>

Auto manuals search

<http://auto.somanuals.com>

TV manuals search

<http://tv.somanuals.com>