

LCD Digital Color TV



Operating Instructions

| | | |
|--------------------|--------------------|--------------------|
| KDL-32XBR6 | KDL-40V4100 | KDL-40W4100 |
| KDL-37XBR6 | KDL-42V4100 | KDL-46W4100 |
| KDL-40V4150 | KDL-46V4100 | KDL-52W4100 |
| | KDL-52V4100 | KDL-46W4150 |

BRAVIA

Owner's Record

The model and serial numbers are located at the rear of the TV. Record these numbers in the spaces provided below. Refer to them whenever you call upon your Sony dealer regarding this TV.

Model Name

Serial No.

CAUTION

To prevent electric shock and blade exposure, do not use this polarized AC plug with an extension cord, receptacle or other outlet unless the blades can be fully inserted.

- Operate the TV only on 120 V AC.

Declaration of Conformity

Trade Name: SONY
 Model: KDL-32XBR6/KDL-37XBR6/
 KDL-40V4150/KDL-40V4100/
 KDL-42V4100/KDL-46V4100/
 KDL-52V4100/KDL-40W4100/
 KDL-46W4100/KDL-52W4100/
 KDL-46W4150
 Responsible Party: Sony Electronics Inc.
 Address: 16530 Via Esprillo,
 San Diego, CA 92127 U.S.A.
 Telephone Number: 858-942-2230

This device complies with part 15 of the FCC rules. Operation is subject to the following two conditions: (1) This device may not cause harmful interference, and (2) this device must accept any interference received, including interference that may cause undesired operation.

NOTIFICATION

This equipment has been tested and found to comply with the limits for a Class B digital device, pursuant to Part 15 of the FCC Rules. These limits are designed to provide reasonable protection against harmful interference in a residential installation. This equipment generates, uses and can radiate radio frequency energy and, if not installed and used in accordance with the instructions, may cause harmful interference to radio communications.

However, there is no guarantee that interference will not occur in a particular installation. If this equipment does cause harmful interference to radio or television reception, which can be determined by turning the equipment off and on, the user is encouraged to try to correct the interference by one or more of the following measures:

- Reorient or relocate the receiving antenna.
- Increase the separation between the equipment and receiver.
- Connect the equipment into an outlet on a circuit different from that to which the receiver is connected.
- Consult the dealer or an experienced radio/TV technician for help.

Pursuant to FCC regulations, you are cautioned that any changes or modifications not expressly approved in this manual could void your authority to operate this equipment.

For Customers in Canada

This Class B digital apparatus complies with Canadian ICES-003.

Note

This television includes a QAM demodulator which should allow you to receive unscrambled digital cable television programming via subscription service to a cable service provider. Availability of digital cable television programming in your area depends on the type of programming and signal provided by your cable service provider.

Licensing Information

Macintosh is a trademark of Apple Inc., registered in the U.S. and other countries.

HDMI, the HDMI logo and High-Definition Multimedia Interface are trademarks or registered trademarks of HDMI Licensing, LLC.

Ferguson Patent Properties, LLC:
 U.S. Patent No. 5,717,422
 U.S. Patent No. 6,816,141

Manufactured under license from Dolby Laboratories. "Dolby" and double-D symbol are trademarks of Dolby Laboratories.

In the United States, TV Guide and other related marks are registered marks of Gemstar-TV Guide International, Inc. and/or one of its affiliates. In Canada, TV Guide is a registered mark of Transcontinental Inc., and is used under license by Gemstar-TV Guide International, Inc.

The TV Guide On Screen system is manufactured under license from Gemstar-TV Guide International, Inc. and/or one of its affiliates.

The TV Guide On Screen system is protected by one or more of the following United States patents 4,908,713; 6,498,895; 6,850,693; 6,396,546; 5,940,073; 6,239,794 to Gemstar-TV Guide International, Inc. and/or its subsidiaries.

Gemstar-TV Guide International Inc. and/or its related affiliates are not in any way liable for the accuracy or availability of the program schedule information or other data in the TV Guide On Screen system and cannot guarantee service availability in your area. In no event shall Gemstar-TV Guide International, Inc. and/or its related affiliates be liable for any damages in connection with the accuracy or availability of the program schedule information or other data in the TV Guide On Screen system.

CAUTION

Use the following Sony TVs only with the following WALL-MOUNT BRACKET or TV-stand.

| Sony TV Model No. | | | | | |
|-----------------------------------|------------|---|-------------|---|----------------------------|
| KDL-32XBR6 | KDL-37XBR6 | KDL-40V4150 KDL-40V4100 KDL-40W4100 | KDL-42V4100 | KDL-46V4100 KDL-46W4100 KDL-46W4150 | KDL-52V4100 KDL-52W4100 |
| Sony Wall-Mount Bracket Model No. | SU-WL500 | | | | |
| Sony TV Stand Model No. | — | | WS-S10LS | | |
| | SU-FL300M | | | — | |
| | — | | | SU-FL300L | |

Install TV Stands SU-FL300L and SU-FL300M using the red-printed paper template supplied with those stands.

Use with other WALL-MOUNT BRACKET or TV-stand may cause instability and possibly result in injury.

To Customers

Sufficient expertise is required for installing the specified TV. Be sure to subcontract the installation to a Sony dealer or licensed contractor and pay adequate attention to safety during the installation.

Blu-ray Disc is a trademark.

"BRAVIA" and BRAVIA, S-Force, Motionflow, BRAVIA Sync, DME³ and "x.v. Color" are trademarks or registered marks of Sony Corporation.

"XrossMediaBar" is a trademark of Sony Corporation. "XMB" is a trademark of Sony Corporation and Sony Computer Entertainment Inc.

"PLAYSTATION" is a registered trademark and "PS3" is a trademark of Sony Computer Entertainment Inc.

Adobe is a registered trademark or a trademark of Adobe Systems Incorporated in United States and/or other countries.



For Customers in the United States

Lamp in this product contains mercury. Disposal of these materials may be regulated due to environmental considerations. For disposal or recycling information, please contact your local authorities or the Electronic Industries Alliance (www.eiaa.org).

Contents

Welcome to the World of BRAVIA®

| | |
|--|---|
| The Four Steps to a Full HD Experience: Set, Sound, Source, and Setup | 4 |
| Picture Quality and Aspect Ratio | 4 |
| TV Home Menu: XMB™ (XrossMediaBar) | 5 |

Getting Started

| | |
|---|----|
| 1. Installing the TV | 6 |
| Carrying the TV | 6 |
| Preparation for Table-Top Stand | 6 |
| Preparation for Wall-Mount Bracket | 7 |
| When Installing the TV Against a Wall or Enclosed Area | 8 |
| Bundling the Connecting Cables | 8 |
| Securing the TV | 9 |
| 2. Locating Inputs and Outputs | 10 |
| 3. Connecting the TV | 12 |
| Cable System or VHF/UHF Antenna System | 12 |
| Cable System and VHF/UHF Antenna System | 12 |
| HD Cable Box/HD Satellite Box | 12 |
| PC | 14 |
| Other Equipment | 15 |
| 4. Setting Up the Channel List – Initial Setup | 16 |

Operating the TV

| | |
|--|----|
| Inserting Batteries into the Remote Control | 18 |
| When Using the Remote Control | 18 |
| TV Controls | 18 |
| Remote Control Button Description | 19 |
| Indicators | 23 |

Exploring Fun Features

| | |
|--|----|
| Favorites | 24 |
| Displaying Favorites | 24 |
| Navigating Favorites | 24 |
| Adding to Favorites | 24 |
| Removing from Favorites | 24 |
| Background TV | 25 |
| Navigating Background TV | 25 |
| Using BRAVIA Sync with Control for HDMI | 25 |
| How to Use TV Guide On Screen | 26 |
| Using P&P and PIP Features | 28 |
| To Enter P&P and PIP | 28 |
| To Change Inputs or Channels | 28 |
| To Exit from P&P and PIP | 28 |

Using TV Settings

| | |
|--|----|
| Media Category Icons | 29 |
| Adjusting TV Settings | 29 |
| Watching TV | 29 |
| Accessing External Inputs | 29 |
| Navigating through TV Home Menu on XMB™ | 30 |
| TV Settings Descriptions | 31 |
| Product Support | 31 |
| Clock/Timers Settings | 31 |
| Picture Settings | 32 |
| Sound Settings | 34 |
| Screen Settings | 35 |
| Channel Settings | 37 |
| Closed Captions (CC) Settings | 38 |
| Parental Lock Settings | 38 |
| External Inputs Settings | 41 |
| HDMI Settings | 41 |
| General Setup Settings | 42 |
| Initial Setup | 42 |

Other Information

| | |
|-----------------------|----|
| Troubleshooting | 43 |
| Specifications | 46 |
| Index | 47 |



Quick Setup Guide (separate volume)
Provides a variety of optional equipment
connection diagrams.



Customer Support
<http://www.sony.com/tvsupport>
On-line Registration
United States
<http://productregistration.sony.com>
Canada
<http://www.sonymstyle.ca/registration>

Welcome to the World of BRAVIA®

Thank you for purchasing this Sony BRAVIA® high-definition television. The quality of the image you see on your **BRAVIA** TV is only as good as the quality of the signal it receives. To experience the stunning detail of your new **BRAVIA** TV, you need access to HD programming. Your **BRAVIA** TV can receive and display HD programming from:

- Over-the-air broadcasting via HD-quality antenna
- HD cable subscription
- HD satellite subscription
- Blu-ray Disc™ player or other HD compatible external equipment

Contact your cable or satellite provider for information on upgrading to HD programming.

To learn more about HDTV, visit:
U.S.A. <http://www.sony.com/HDTV>
Canada <http://www.sonystyle.ca/hd>

The Four Steps to a Full HD Experience: Set, Sound, Source, and Setup

Along with your **BRAVIA** TV **set**, a complete HD system requires an HD **sound** system, a **source** of HD programming and proper **setup** connections. This manual explains basic setup connections (see page 12). The Quick Setup Guide, enclosed separately, illustrates how to connect other optional equipment.

Picture Quality and Aspect Ratio

You can enjoy crisp, clear images, smooth movement and high-impact visuals from 1080 HD signals. When you compare a high-definition signal to a standard analog signal, you will notice a big difference.

High-definition and standard-definition signals are transmitted with different aspect ratios (the width-to-height ratio of the image). HDTV uses a wider screen than conventional standard-definition TV.

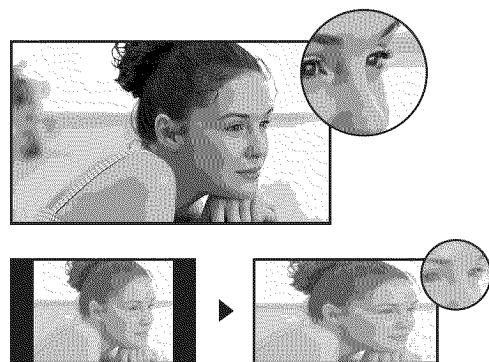

16:9 (high-definition) source

Most HDTV signals use a wide screen aspect ratio of 16:9. The 16:9 fills your **BRAVIA** screen, maintaining a crisp, clear, vivid picture.

4:3 (standard-definition) source

Most standard-definition signals use a boxy 4:3 aspect ratio. When a 4:3 image is displayed on an HDTV, you will see black bars on the sides. The picture quality may not be as sharp as with HD sources.



- You can use the **Wide Mode** function of the TV to adjust the 4:3 image to fit the entire screen (see pages 22, 35 and 36).

TV Home Menu: XMB™ (XrossMediaBar)

The **XMB™** is an easy way to access the TV settings for customizing, making adjustments, viewing the available TV channels and selecting the connected equipment. Press the **HOME** button on your remote control to display the **XMB™**.

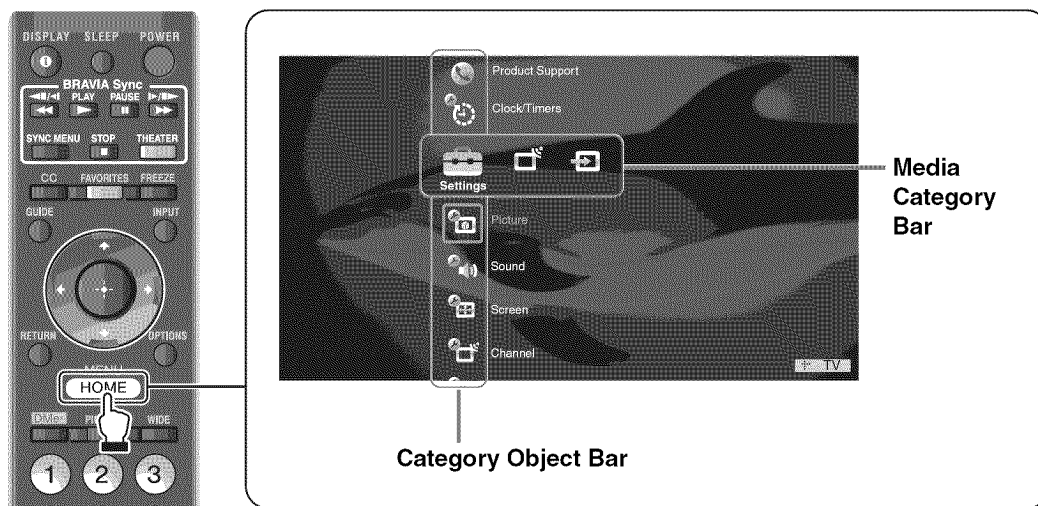

From the horizontal Media Category Bar you can control:

- **Settings:** timer, picture, sound, screen and other options (see page 31 for customization options).
- **TV Channels:** TV Guide On Screen™ and available channels are displayed on the vertical Category Object Bar.
- **External Inputs:** cable, satellite, VCR, DVD players or other optional equipment can also be selected from the Category Object Bar from the **External Inputs**.



- This manual is for the 32 class, 37, 40, 42, 46 and 52 inch **BRAVIA** KDL-XBR6, V and W series models with screen size measured diagonally. The 32 class has a 31.5 inch viewable image size (measured diagonally).

Getting Started

1. Installing the TV

This TV can be mounted on a wall using a Wall-Mount Bracket or placed on a TV stand (each sold separately). This section will explain:

- How to carry the TV
- Preparation for a Table-Top stand
- Preparation for a Wall-Mount Bracket
- Installation against a wall or enclosed area
- Bundling the connecting cables
- Securing the TV

Carrying the TV

Be sure to follow these guidelines to protect your property and avoid causing serious injury.

- Before carrying the TV, disconnect all cables.
- Carrying the large size TV requires two or more people.
- When carrying the TV, place your hand as illustrated and hold it securely. Do not subject the TV to shocks, vibration, or excessive force.

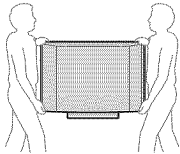

- Lift the TV by placing your palm directly underneath the panel but do not:
 - squeeze the speaker grill area
 - place your fingers in the groove above the speaker grill area
 - put stress on the LCD panel.

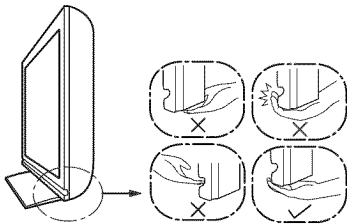

- Do not lift the TV from the bottom center.

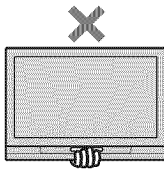

Preparation for Table-Top Stand

Follow the assembling steps required to place on a TV stand (except models: KDL-52V4100 and KDL-52W4100).

- 1 Remove the Table-Top Stand and screws from the carton. The screws can be found in the accessory bag.

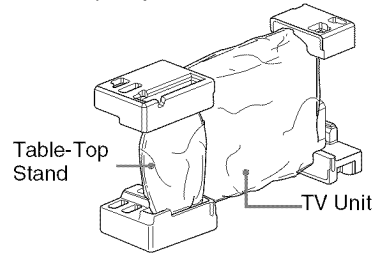

- 2 Place the Table-Top Stand on a level and stable surface.

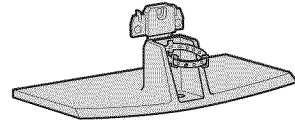

- 3 Gently slide the TV unit onto the neck of the Table-Top Stand and align the screw holes.

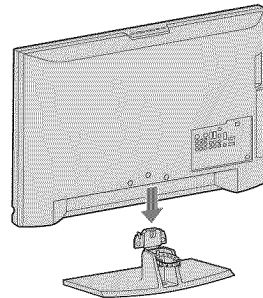

- Do not put stress on the LCD panel or the frame around the screen.
 - Be careful to not pinch your hands or the AC power cord when you install the TV unit to the Table-Top Stand.
- 4 Use the supplied screws to attach the TV unit to the Table-Top Stand. Shown here with a three screw model; other models may require screwing four screws (refer to the "Attaching the Table-Top Stand" flyer).

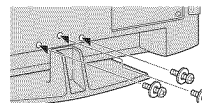

If an electric screwdriver is used, set the torque to tighten at approximately 1.5 N·m, 15 Kgf·cm.

Preparation for Wall-Mount Bracket

All models are ready to be mounted on a wall. Models KDL-52V4100 and KDL-52W4100 will require detaching the Table-Top Stand.

- **For product protection and safety reasons, Sony strongly recommends that you use the Wall-Mount Bracket model designed for your TV and the wall-mounting of your TV should be performed by a Sony dealer or licensed contractor.**
- For bracket installation, refer to the supplied “Installing the Wall-Mount Bracket” and the instruction guide provided by the Wall-Mount Bracket model for your TV. Sufficient expertise is required in installing this TV, especially to determine the strength of the wall for withstanding the TV’s weight.
- Be sure to use the screws supplied with the Wall-Mount Bracket when attaching the mounting hooks to the TV set. The supplied screws are designed so that they are 8 mm to 12 mm in length when measured from the attaching surface of the mounting hook. The diameter and length of the screws differ depending on the Wall-Mount Bracket model. Use of screws other than those supplied may result in internal damage to the TV set or cause it to fall, etc.

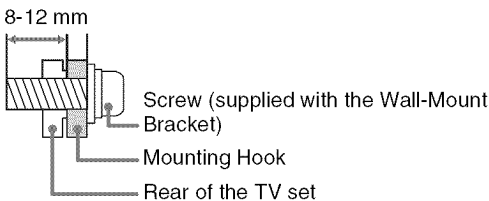

- Do not remove the Table-Top Stand of the KDL-52V4100 and KDL-52W4100 for any reason other than to wall-mount the TV.
- Models KDL-32/37XBR6, KDL-40V4150, KDL-40/42/46V4100, KDL-40/46W4100 and KDL-46W4150 can be wall-mounted as packaged. If you decided to use the TV with the TV stand and later want to wall-mount the TV, follow the steps provided on this page to remove the Table-Top Stand.
- Be sure to store the unused screws and Table-Top Stand in a safe place until you are ready to attach the Table-Top Stand. Keep the screws away from small children.

Follow the simple steps below to remove the Table-Top Stand:

- 1 Unplug the AC power cord and disconnect all the cables from the TV.
 - 2 Secure the Mounting Hook to the rear of the TV.
 - 3 Adjust the angle of the Mounting Hook.
 - 4 Remove the screws on the rear of the TV (see illustration in the next column). Do not remove any other screws from the TV.
 - 5 When screws are removed, lift the TV off the stand. Make sure that you carry out this task with at least two or three people. Do not attempt to lift the TV by yourself.
- Shown here is model KDL-52V4100; other models may only require removal of three screws (refer to the “Attaching the Table-Top Stand” flyer).

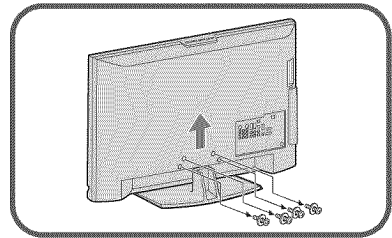

(Continued)

When Installing the TV Against a Wall or Enclosed Area

Make sure that your TV has adequate air circulation. Allow enough space around the TV as shown below. Avoid operating the TV at temperatures below 41 °F (5 °C).

Installed with stand

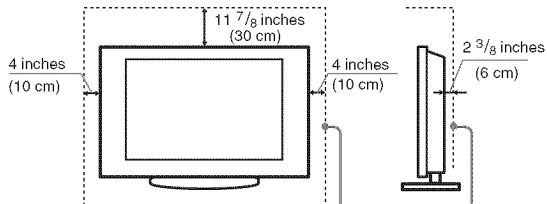

Leave at least this much space around the set.

Installed on the wall

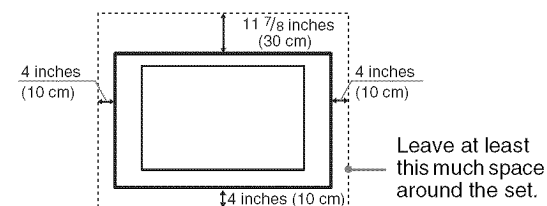

Leave at least this much space around the set.

Never install the TV set as follows:

Air circulation is blocked.

Air circulation is blocked.

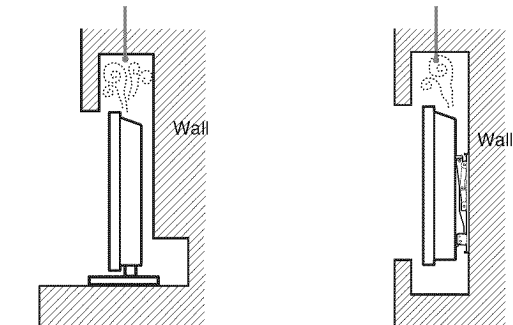

- Inadequate air circulation can lead to overheating of the TV and may cause damage to your TV or cause a fire.

Consider the following for best picture quality

- Do not expose the screen to direct illumination or sunlight.
- Use spot lighting directed down from the ceiling or cover the windows that face the screen with opaque drapery.
- Install the TV in a room where the floor and walls are not of a reflective material.

- When moving the TV from a cold area to a warm area, a sudden room temperature change may cause the TV's picture to blur or show poor color due to moisture condensation. Should this occur, please wait a few hours to allow the moisture to evaporate before powering on the TV.

Bundling the Connecting Cables

You can bundle the connecting cables as illustrated below.

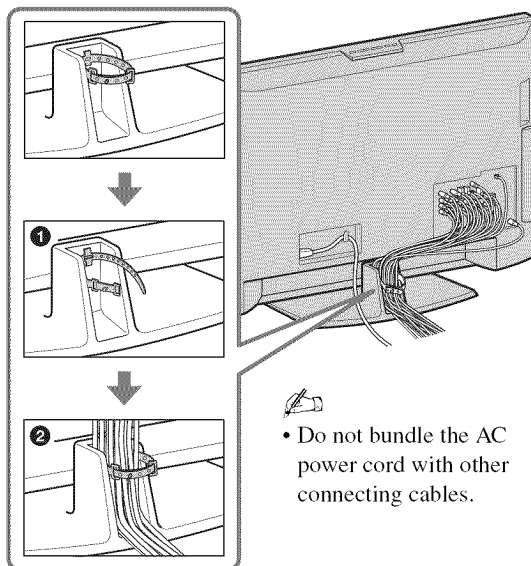

- Do not bundle the AC power cord with other connecting cables.

Securing the TV



Sony strongly recommends taking measures to prevent the TV from toppling over. Unsecured TVs may topple and result in property damage, serious bodily injury or even death.

Prevent the TV from Toppling Over

- Secure the TV to a wall and/or stand.
- Do not allow children to play or climb on furniture and TV sets.
- Avoid placing or hanging items on the TV.
- Never install the TV on:
 - slippery, unstable and/or uneven surfaces.
 - furniture that can easily be used as steps, such as a chest of drawers.
- Install the TV where it cannot be pulled, pushed, or knocked over.
- Route all AC power cords and connecting cables so that they are not accessible to curious children.

Use a Sony TV Stand

Use a Sony specified TV stand (see page 2) and follow the instruction manual provided with the Sony TV stand.

If a Sony specified TV stand is not used, consider the following recommended measures.

Recommended Measures to Secure the TV

Secure the Stand for the TV

Make sure the TV stand can adequately support the weight of the TV. Use two angle braces (not supplied) to secure the stand.

For each angle brace use the appropriate hardware to:

- attach one side of the angle brace to the wall stud.
- attach the other side to the TV stand.

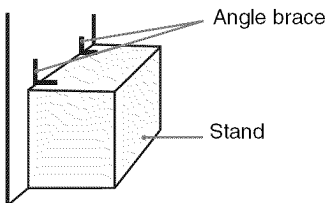

Secure the TV to the Stand

Use the optional hardware listed below (not supplied):

- M6 × 12-18 mm anchor bolt (screwed into the TV's Table-Top Stand)
- A screw or similar (attach it to the TV stand)

- Rope or chain (strong enough to support the weight of the TV). Make sure that there is no excess slack in the rope or chain.

An alternative way to secure the TV is with an optional Sony Support Belt Kit.

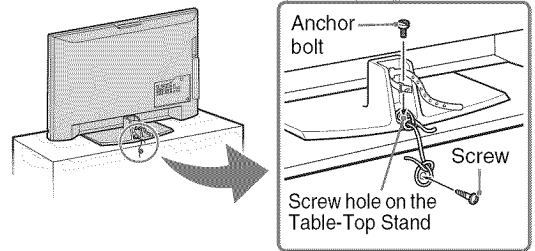

Contact Sony Customer Support to obtain the optional Support Belt Kit by providing your TV model name.

- For United States call: 1-800-488-7669 or visit: www.sony.com/accessories
- For Canada call: 1-877-899-7669

Anchor the TV to the Wall

Use the hardware listed below (not supplied):

- Two M6 × 12-18 mm anchor bolts (screw into the top-most wall-mount holes located on the rear of the TV)
- Rope or chain (attach to one M6 anchor bolt)
- Wall-anchor (attach to the wall stud) strong enough to support the weight of the TV (pass the rope through the wall-anchor, then attach to the other M6 anchor bolt)

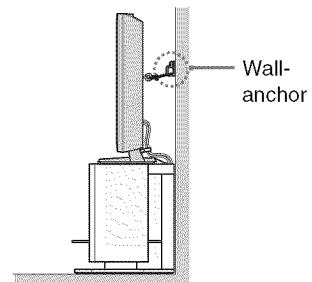
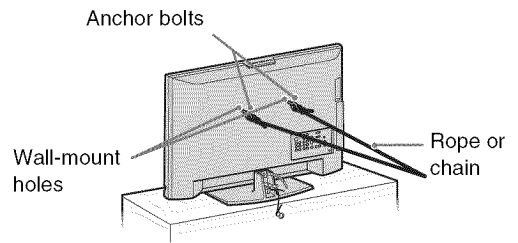

- Securing the TV to the stand without securing it and the stand to the wall provides minimum protection against the TV toppling over. For further protection, follow all three measures recommended above.

2. Locating Inputs and Outputs

Rear of TV

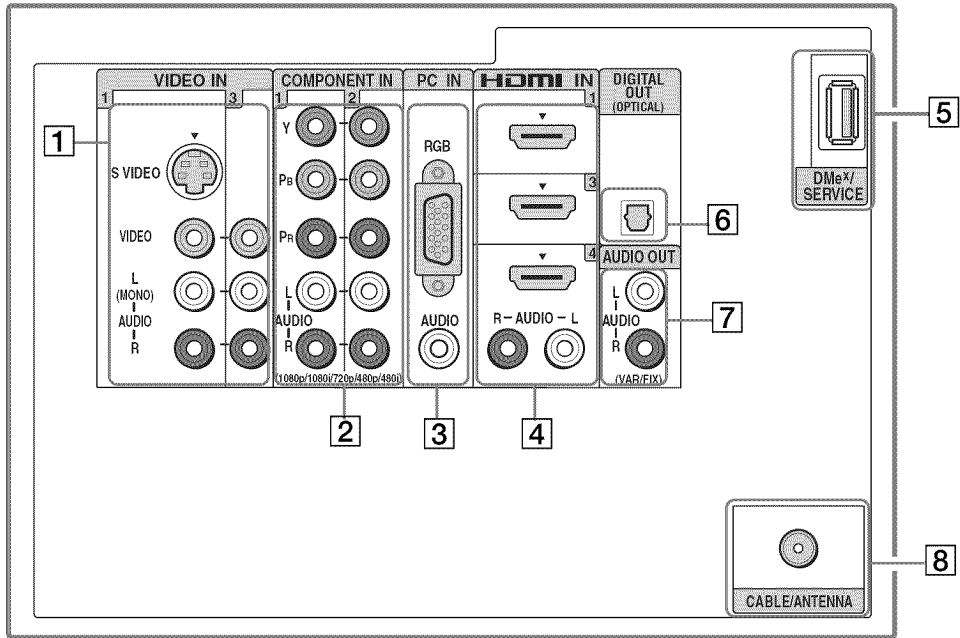

KDL-32XBR6/KDL-37XBR6/
KDL-42V4100

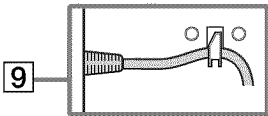

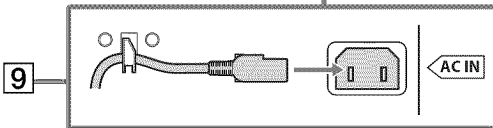

KDL-40V4150/KDL-40V4100/
KDL-46V4100/KDL-52V4100/
KDL-40W4100/KDL-46W4100/
KDL-52W4100/KDL-46W4150

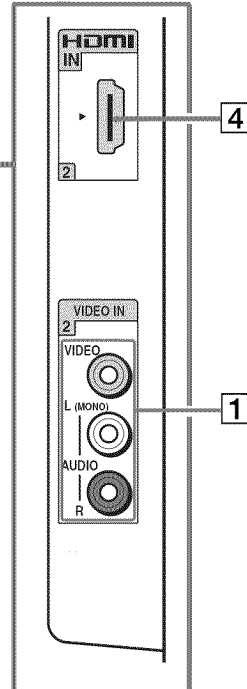

Side Panel



- This TV displays all video input signals in a resolution of 1,920 dots × 1,080 lines.
- An HDMI or Component video (YPbPr) connection is required to view 480i, 480p, 720p, 1080i and 1080p video formats. 1080/24p is available only with HDMI connection.

| Item | Description |
|--|--|
| 1 VIDEO IN 1 S VIDEO | Connects to the S VIDEO output jack of video equipment. If both composite video and S VIDEO are connected, S VIDEO signal has priority. |
| VIDEO IN 2/3 VIDEO/L(MONO)-AUDIO-R | <p>Connects to the composite video and audio output jacks on your A/V equipment.</p>  <ul style="list-style-type: none"> If you have mono equipment, connect its audio output jack to the TV's L (MONO) audio input jack. |
| 2 COMPONENT IN 1/2 (1080p/1080i/720p/480p/480i)/L-AUDIO-R | Connects to your equipment's component video (YPbPr) and audio (L/R) jacks. |
| 3 PC IN (RGB/AUDIO) | <p>Connects to a personal computer's video and audio output connector (see page 14). Can also be connected to other analog RGB equipment. See "PC Input Signal Reference Chart" on page 14 for the signals that can be displayed.</p>  <ul style="list-style-type: none"> For some Apple Macintosh computers, it may be necessary to use an adapter (not supplied). If this is the case, connect the adapter to the computer before connecting the HD15-HD15 cable. If the picture is noisy, flickering or not clear, adjust Phase and Pitch of Screen settings on page 36. |
| 4 HDMI IN 1/2/3 | HDMI (High-Definition Multimedia Interface) provides an uncompressed, all-digital audio/video interface between this TV and any HDMI-equipped A/V equipment. HDMI supports enhanced, or high-definition video, plus digital audio. |
| HDMI IN 4 R-AUDIO-L | <p>If the equipment has a DVI jack and not an HDMI jack, connect the DVI jack to the HDMI IN 4 (with DVI-to-HDMI cable or adapter) jack, and connect the audio jack to the AUDIO IN (L/R) jacks of HDMI IN 4.</p>  <ul style="list-style-type: none"> Be sure to use only an HDMI cable that bears the HDMI logo. When connecting a DVI-equipped PC to an HDMI jack, also connect an Audio cable between the PC and R-AUDIO-L jack. |
| 5 DMe^x/SERVICE | This USB port is for service only unless you are connecting the optional BRAVIA external module (DMe ^x). |
| 6 DIGITAL OUT (OPTICAL) | Connects to the optical audio input of your digital audio equipment that is PCM/Dolby* Digital compatible. |
| 7 AUDIO OUT (VAR/FIX) | Connects to the left and right audio input jacks of your analog audio equipment. You can use these outputs to listen to your TV's audio through your stereo system. |
| 8 CABLE/ANTENNA | RF input that connects to your cable or VHF/UHF antenna. |
| 9 AC power cord or AC IN | Connects to your power source. For models with attached cords: Plug the cord into the nearest wall outlet. For models with separate cords: Connect the supplied power cord to AC IN and the nearest wall outlet. |

* Manufactured under license from Dolby Laboratories. "Dolby" and the double-D symbol are trademarks of Dolby Laboratories.

3. Connecting the TV

Cable System or VHF/UHF Antenna System

You can enjoy high-definition and standard-definition digital programming (if available in your area) along with standard-definition analog programming.



- This TV is capable of receiving unscrambled digital programming for both cable (QAM and 8VSB) and external VHF/UHF antenna (ATSC).
- It is strongly recommended that you connect the CABLE/ANTENNA input using a 75-ohm coaxial cable to receive optimum picture quality. A 300-ohm twin lead cable can be easily affected by radio frequency interference, resulting in signal degradation.

Cable or VHF/UHF (or VHF only)

75-ohm coaxial cable

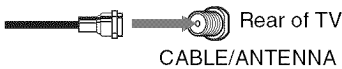

Cable System and VHF/UHF Antenna System

Use an optional A-B RF switch (not supplied) to switch between the cable and over-the-air antenna programming, as indicated below.

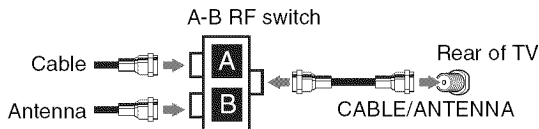

- Be sure to set the **Signal Type** setting to **Cable** or **Antenna** in the **Channel** settings for the type of input signal you choose (see page 37).

HD Cable Box/HD Satellite Box

You can enjoy high-definition programming by subscribing to a high-definition cable service or a high-definition satellite service. For the best possible picture, make sure you connect this equipment to your TV via the HDMI or component video (with audio) input on the back of your TV.

Shown with HDMI Connection

Rear of TV

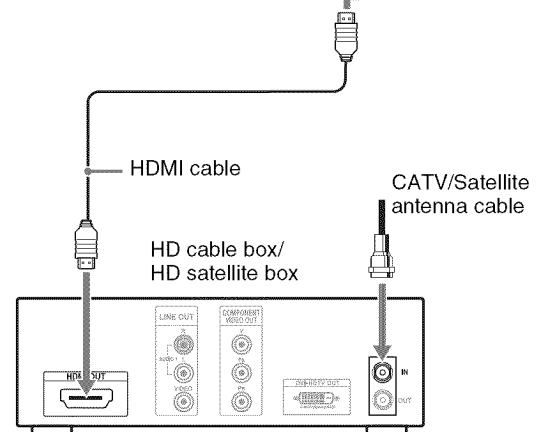
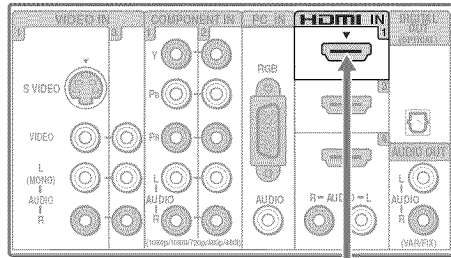

Shown with DVI Connection

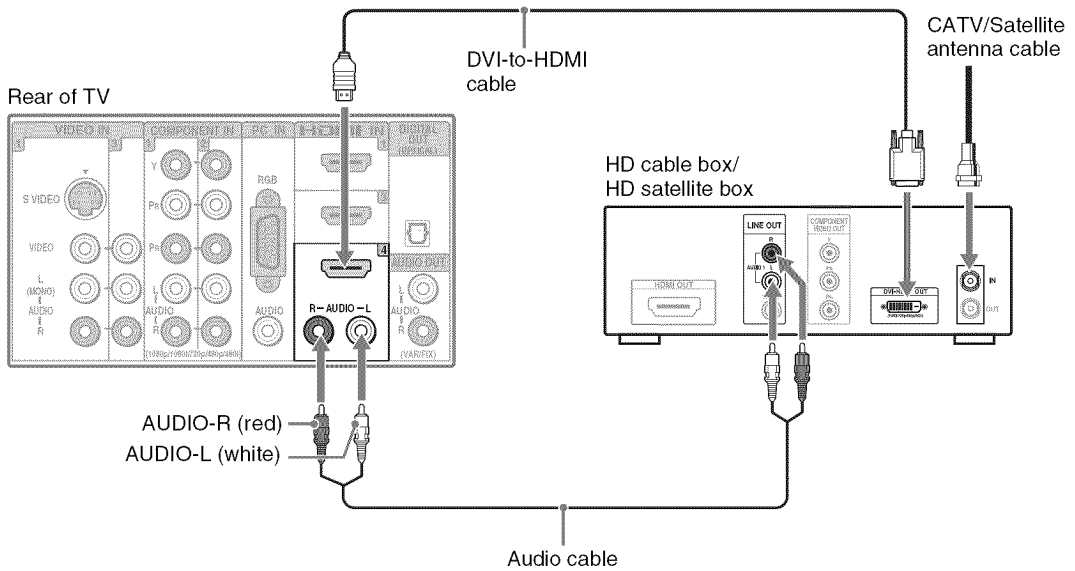

- If the equipment has a DVI jack and not an HDMI jack, connect the DVI jack to the HDMI IN 4 (with DVI-to-HDMI cable or adapter) jack and connect the audio jack to the AUDIO IN (L/R) jacks of HDMI IN 4. For details, see page 11.

Shown with Component Connection

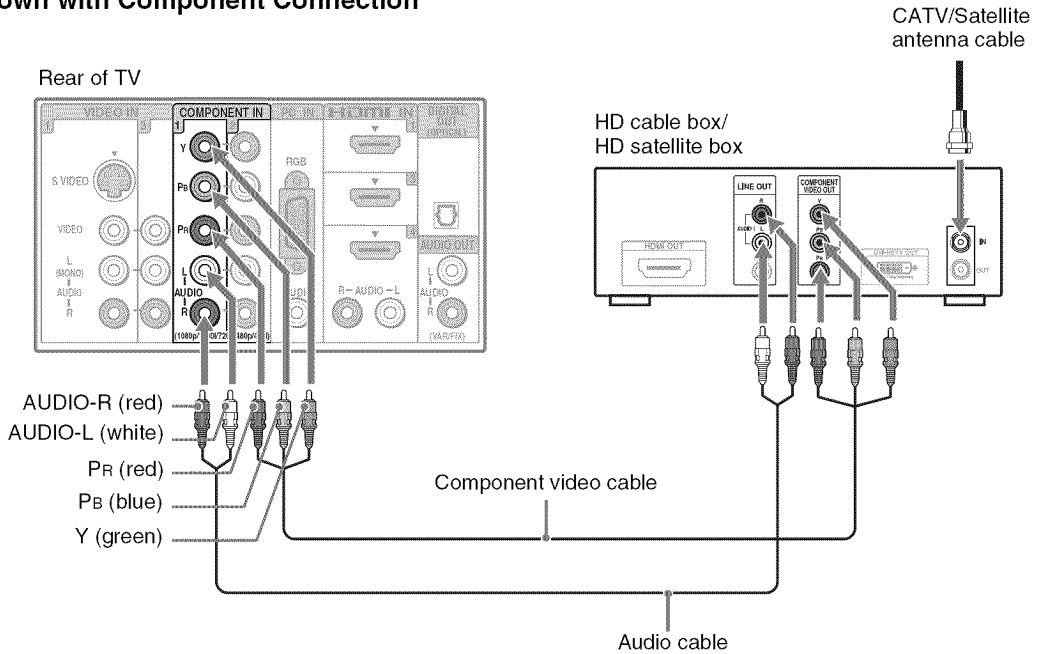

(Continued)

Use the TV as a monitor for your PC by connecting a HD15 to HD15 cable as shown below. This TV can also be connected to a PC with a DVI or HDMI output. (Refer to the separate Quick Setup Guide.)

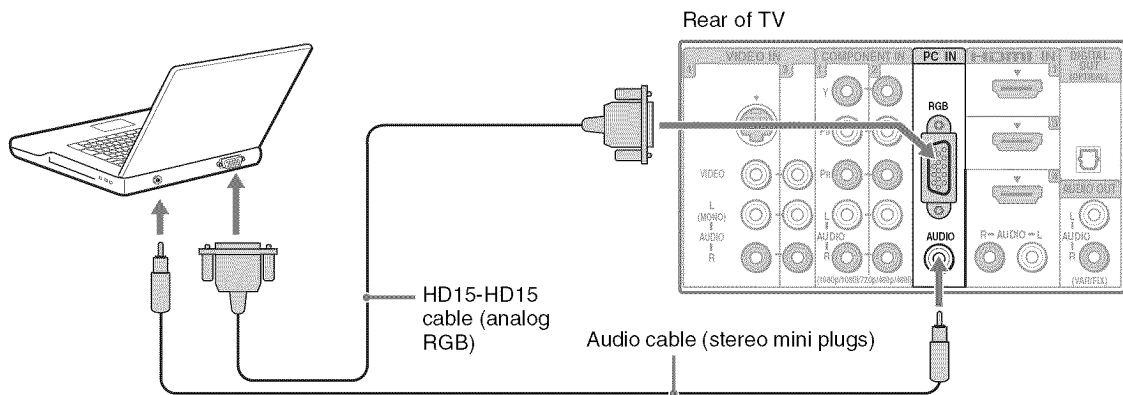

- Connect the PC IN jack to the PC using an HD15-HD15 cable with ferrite core (analog RGB) and audio cable (see page 11).

- If the PC is connected to the TV and no signal has been input from the PC for more than 30 seconds, the TV enters the standby mode automatically (see page 42).

PC Input Signal Reference Chart

After connecting the PC to the TV, set the output signal from the PC according to the supported resolutions and timings indicated below.

| Supported resolutions | | | | Horizontal frequency (kHz) | Vertical frequency (Hz) | Standard |
|-----------------------|--------------------|-------------------|--------------|----------------------------|-------------------------|------------------------|
| Signal | Horizontal (Pixel) | × Vertical (Line) | | | | |
| VGA | 640 | × | 480 | 31.5 | 60 | VGA |
| | 640 | × | 480 | 37.5 | 75 | VESA |
| | 720 | × | 400 | 31.5 | 70 | VGA-T |
| SVGA | 800 | × | 600 | 37.9 | 60 | VESA Guidelines |
| | 800 | × | 600 | 46.9 | 75 | VESA |
| XGA | 1,024 | × | 768 | 48.4 | 60 | VESA Guidelines |
| | 1,024 | × | 768 | 56.5 | 70 | VESA |
| | 1,024 | × | 768 | 60.0 | 75 | VESA |
| WXGA | 1,280 | × | 768 | 47.4 | 60 | VESA |
| | 1,280 | × | 768 | 47.8 | 60 | VESA |
| | 1,280 | × | 768 | 60.3 | 75 | |
| | 1,360 | × | 768 | 47.7 | 60 | VESA |
| SXGA | 1,280 | × | 1,024 | 64.0 | 60 | VESA |
| HDTV | 1,920 | × | 1,080 | 67.5 | 60 | CEA-861* |

- This TV's PC input does not support Sync on Green or Composite Sync.
- This TV's PC VGA input does not support interlaced signals.
- Your PC must support one of the above PC input signals to display on the television.
- For the best picture quality, it is recommended to use the signals (boldfaced) in the above chart with a 60 Hz vertical frequency. In plug and play, signals with a 60 Hz vertical frequency will be detected automatically. (PC reboot may be necessary.)

*The 1080p timing when applied to the HDMI input will be treated as a video timing and not PC timing. This affects **Picture** settings, **Wide Mode** settings, and **PIP** function. To view PC content set **Picture Mode** to **Custom**, **Wide Mode** to **Full**, and **Display Area** to **Full Pixel**.

Other Equipment

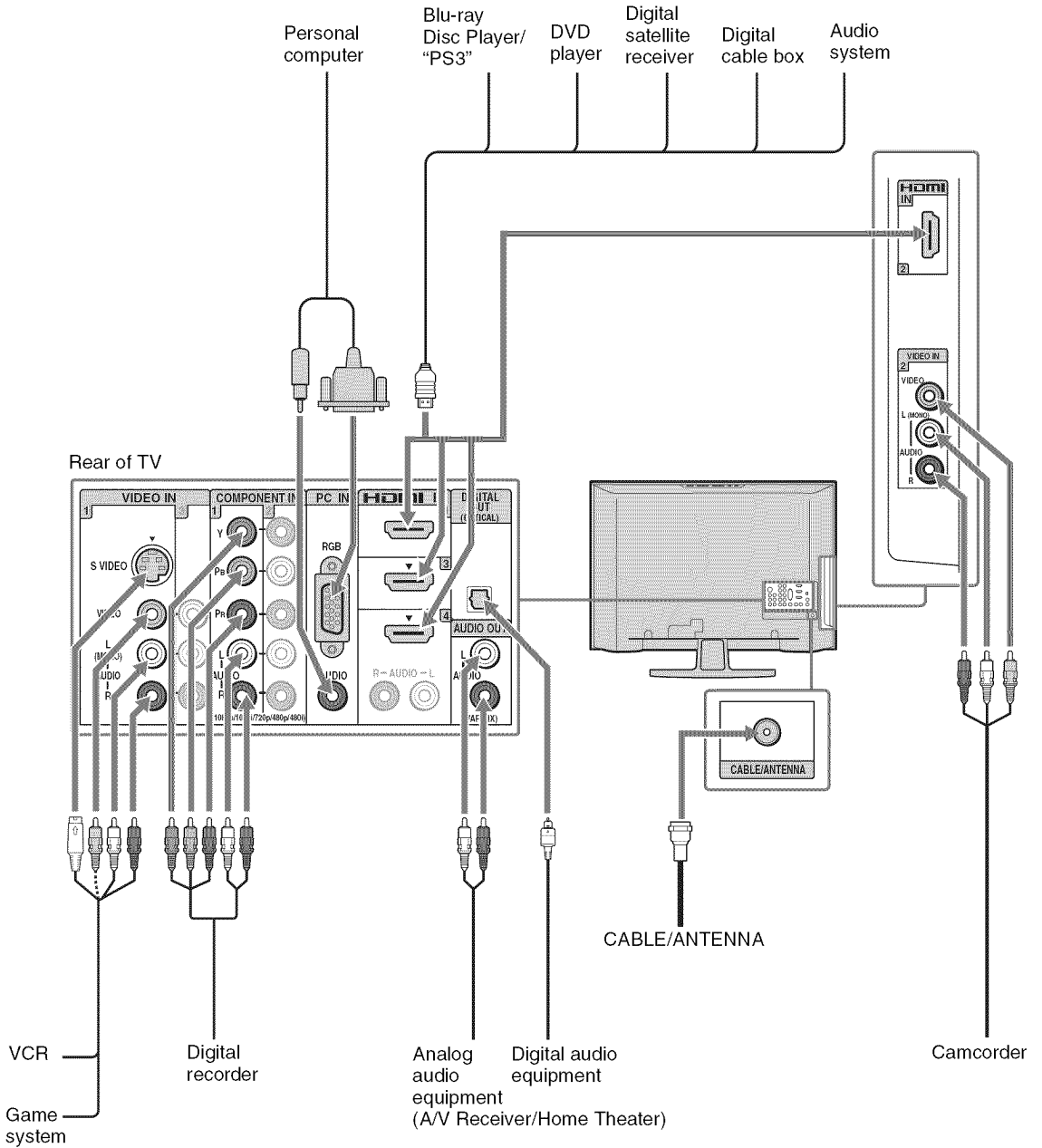

- Refer to the Quick Setup Guide (supplied) when connecting other equipment to your TV.

4. Setting Up the Channel List – Initial Setup

The **Initial Setup** screen appears when you turn on the TV for the first time.

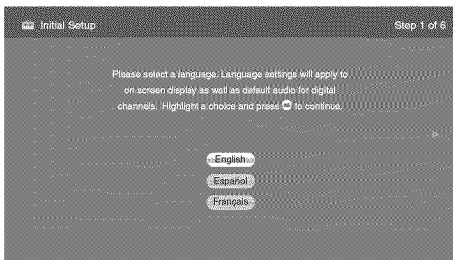

- 1 Complete your cable connections (refer to the preceding pages and the Quick Setup Guide provided separately) before proceeding with the **Initial Setup**.
- 2 Use the remote control to navigate through the **Initial Setup**:

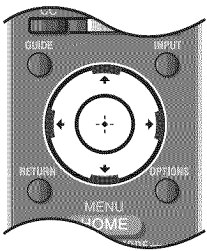

▲/▼ button:

Allows you to highlight options where applicable.

⊕ button:

Allows you to select the highlighted option and advance to the next screen.

◀ button:

Allows you to move back to the previous screen.

▶ button:

Allows you to move to the next screen.

- 3 Follow the help text provided on the screen to run **Auto Program**. **Auto Program** will scan for available channels from the signal source directly connected to the TV's CABLE/ANTENNA input.

If you receive channels from a cable box or satellite receiver without using the CABLE/ANTENNA input (e.g. using HDMI or component input), skip **Auto Program**.



- If you select **Skip**, you will be asked to disable **Channel Tuning Keys** to avoid accidental input change while using an external input; see page 41 for details.

- If the language that you have selected in the **Language** setting is available from the broadcaster as **Alternate Audio** language, your TV will automatically switch to the matching language with the **Alternate Audio** feature. The **Alternate Audio** option may be accessed by pressing **OPTIONS** on the remote control when an alternate audio stream is available from the broadcaster. **Alternate Audio** is available only for digital programs (see page 35).

- 4 Set the date and time.

Begin your TV Guide On Screen Setup

When the **Initial Setup** is completed, the TV will display this screen and prompt you to set up the electronic program guide. Follow the on screen instructions using your remote control.



Next, you will see a confirmation screen with instructions on how to acquire the TV Guide On Screen service.

- The service is free of charge.
- Your TV acquires program listing information while your TV is turned off.
- Allow 24 hours (some areas may take longer) for the TV to fully receive the program listing information.
- Once the program information is obtained by the TV, you will be able to view a guide of up to two days of TV programming. See page 26 on how to use the TV Guide On Screen.

☐ To Display TV Guide On Screen

Press **GUIDE**.

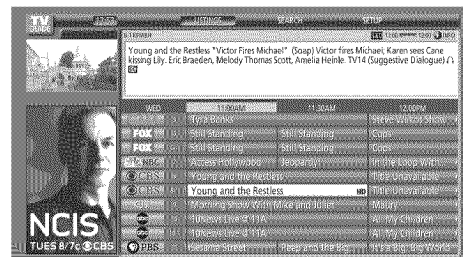

□ To Run Initial Setup Again or Auto Program at a Later Time

Select the **Initial Setup** feature from the **XMB™** or perform the steps described in the **Initial Setup** section on page 42. To run **Auto Program**, see page 37.

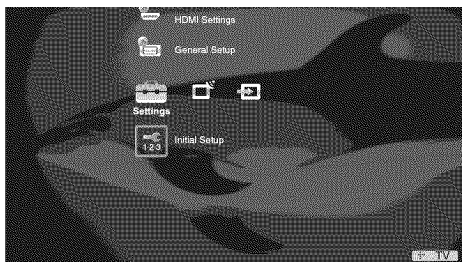

□ To Add Digital Channels

Use the **Add Digital Channels** feature as described on page 37. (Useful for antenna installations.)



- If you accidentally turn off the TV during the **Initial Setup** process, the **Initial Setup** will restart from the beginning when the TV is turned back on.
- **Auto Program** may be canceled while the channels are being scanned. Press **RETURN** first, then press either **◀/▶** on the remote control. Select **Yes** to cancel or **No** to resume **Auto Program**.

Operating the TV

Inserting Batteries into the Remote Control

Insert two size AA batteries (supplied) by matching **+** and **-** on the batteries to the diagram inside the battery compartment of the remote control.

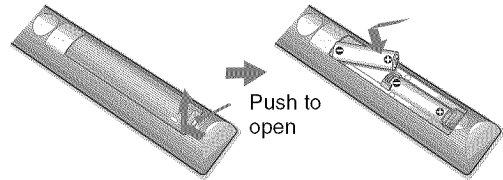

When Using the Remote Control

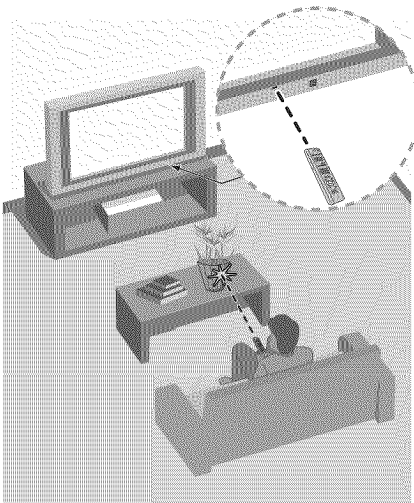

Follow the guidelines below

- Point your remote control directly at the IR sensor located on your TV.
- Make sure that no objects are blocking the path between the remote control and the IR sensor on your TV.
- Fluorescent lamps can interfere with your remote control; try turning off the fluorescent lamps.
- If you are having problems with the remote control, reinsert or replace your batteries and make sure that they are correctly inserted.

TV Controls

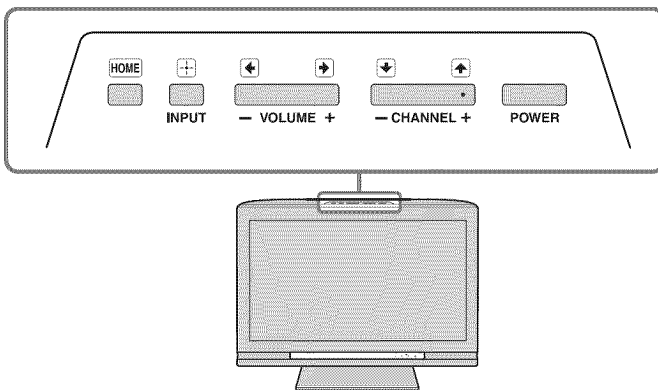

The buttons located on the top of the TV operate the same as the corresponding buttons on the remote control. See descriptions on the next page.

Remote Control Button Description



- The **5, PLAY** and **CH+** buttons have a tactile dot. Use them as a reference when operating the TV.

| Button | Description |
|-----------------------------|--|
| 1 DISPLAY | Press once to display the banner with channel/program information you are watching. The banner will time out in a few seconds or press again to exit. You can select the banner size based on the amount of information. See Info Banner on page 42. |
| 2 SLEEP | Press repeatedly until the TV displays the time in minutes (Off, 15 min, 30 min, 45 min, 60 min, 90 min or 120 min) that you want the TV to remain on before shutting off. To cancel Sleep Timer , press SLEEP repeatedly until Off appears. |
| 3 BRAVIA Sync | These buttons are used to control the connected equipment with Control for HDMI function (not available on all Control for HDMI equipment). ◀◀ (fast reverse) : Press to play a program in fast rewind mode. ▶▶ PLAY : Press to play a program at a normal speed. PAUSE : Press to pause playback. ▶▶ (fast forward) : Press to play a program in fast forward mode. SYNC MENU : Press once to display the Sync'd HDMI Devices (while a Control for HDMI device is not selected). Select the HDMI device and then press SYNC MENU to display the menu of connected equipment (not available on all Control for HDMI equipment). ■ STOP : Press to stop playback. THEATER : Press to turn on and off the Theater Mode . The picture settings will be set for a cinema-like experience and the audio will be switched to the audio output of the attached speakers of your BRAVIA Sync audio system. Your BRAVIA Sync audio system must be connected by an HDMI connection to your TV (see page 25 for details). |
| 4 CC | Press to turn on, turn on with muting or off the Closed Captions (CC) . To change or customize the CC Display , see page 38. |
| 5 FAVORITES | Press once to display the Favorites menu. Press again to exit from the Favorites menu. See pages 24 for detailed information. |
| 6 GUIDE | Press to open the TV Guide On Screen system. Press again to exit the Guide. For instructions on using a specific menu, see "How to Use TV Guide On Screen" on page 26. |

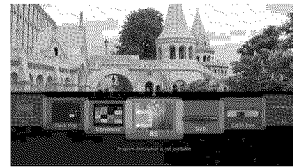

(Continued)

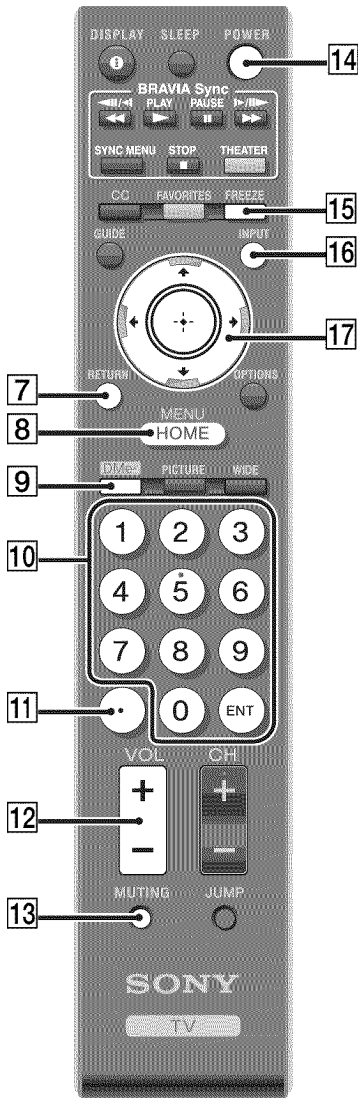

| Button | Description |
|---------------------------|---|
| 7 RETURN | Press to go back to the previous screen or exit from the screen when displaying menu items and settings. |
| 8 HOME | Press to display the TV Home Menu/XMB™ to access the TV Home Menu items such as the TV Settings , TV channels and External Inputs list (see pages 5 and 29). |
| 9 DMe ^x | Press to access features in the optional BRAVIA external module (e.g. DMX-NV1). See your dealer or www.sony.com/bravia for more information. The module may not be available in all regions. |
| 10 0-9 ENT | Press 0-9 to select a channel; the channel changes after two seconds. Press ENT to change channels immediately. |
| 11 | Use with 0-9 and ENT to select digital channels. For example, to enter 2.1, press 2 , . , 1 and ENT . |
| 12 VOL +/- | Press to adjust the volume. |
| 13 MUTING | Press to mute the sound. Press again or press VOL + to restore the sound. |
| 14 POWER | Press to turn on and off the TV. |
| 15 FREEZE | Press once to display a frozen image with the current program in a window. Press again to fill the screen with the frozen image. Press a third time to return to the current program. |
| | <p>Current program Frozen picture </p> <p>Press the to move the small window showing current program to a different location on the screen.</p> <ul style="list-style-type: none"> • With the Freeze feature active, some features are unavailable. • While the Freeze feature is active, pressing HOME will deactivate Freeze and display the XMB™. |
| 16 INPUT | Press to display the list of External Inputs and TV mode. Press repeatedly to toggle through the inputs. |
| 17 | Press to move focus/highlight. Press to select/confirm an item. |

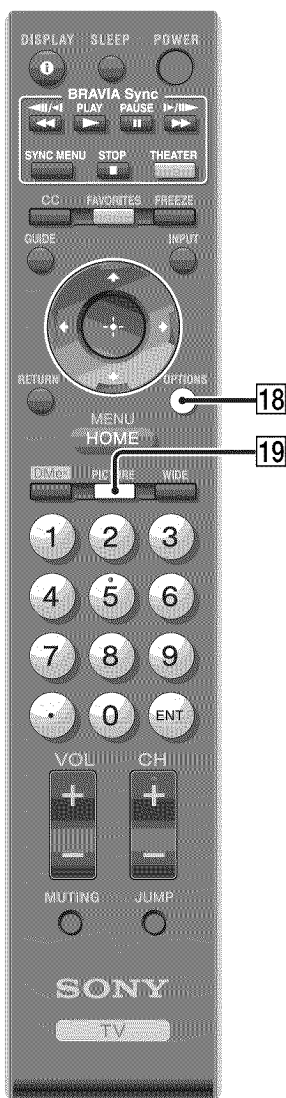

| Button | Description |
|--------|-------------|
|--------|-------------|

| | |
|-------------------|--|
| 18 OPTIONS | Press to display a list of convenient functions and menu shortcuts. The OPTIONS menu items vary based on current input and content. |
|-------------------|--|

| Menu Item | Reference Page |
|--|----------------|
| Picture Adjustments | See page 32 |
| Sound Adjustments | See page 34 |
| P&P or PIP | See page 28 |
| Exit P&P or Exit PIP | See page 28 |
| Motion Enhancer | See page 33 |
| Speakers | See page 34 |
| Audio Swap | See page 28 |
| Screen | See page 36 |
| Add to Favorites/ Remove from Favorites | See page 24 |
| MTS | See page 34 |
| Alternate Audio | See page 35 |
| Digital Rating | See page 39 |
| Background TV | See page 25 |
| Device Control | See page 41 |



- The **Digital Rating** and **Alternate Audio** options will appear in Options only when digital ratings or alternate audio streams are available in the currently tuned digital program.

| | |
|-------------------|--|
| 19 PICTURE | Press repeatedly to cycle through the available picture modes: Vivid, Standard, Cinema, Custom, Photo-Vivid, Photo-Standard, Photo-Original, Photo-Custom, Video, Text. (Available options depend on the current mode.) The picture modes can also be accessed in the Picture settings. For details, see Picture settings on page 32. |
|-------------------|--|

(Continued)

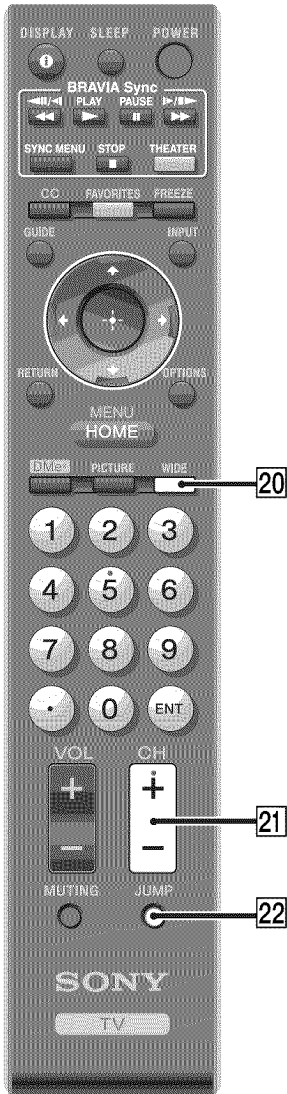

| Button | Description |
|--------|-------------|
|--------|-------------|

20 WIDE

Press repeatedly to cycle through the available **Wide Mode** settings: **Wide Zoom**, **Normal**, **Full**, **H Stretch**, **Zoom**. The **Wide Mode** settings can be also accessed in the **Screen** settings (see pages 35 and 36).

Changing the Wide Screen Mode

| 4:3 Original source Standard-definition source | 16:9 Original source High-definition source |
|---|--|
| | |
| Wide Zoom | Wide Zoom |
| Normal | Normal This mode is not available. |
| Full | Full |
| H Stretch This mode is not available. | H Stretch |
| Zoom | Zoom |



- **Normal** is available with 480i or 480p sources only.
- **H Stretch** is only available with 720p, 1080i, 1080p and 1080/24p sources.

Changing the Wide Screen Mode for PC Timing

| Incoming PC signal 800 × 600 | Incoming PC signal 1,280 × 768 |
|---------------------------------|-----------------------------------|
| | |
| Normal | Normal |
| Full 1 | Full 1 |
| Full 2 | Full 2 |

21 CH +/-

Press to scan through channels. To scan quickly through channels, press and hold down either **+/-**.

22 JUMP

Press to jump back and forth between two channels. The TV alternates between the current channel and the last channel that was selected.



Indicators

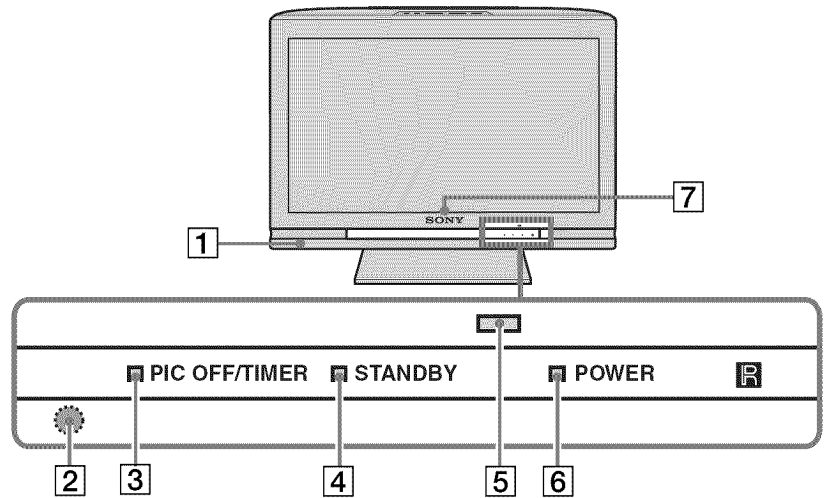

| Item | Description |
|---------------------------------|--|
| 1 Speaker | Outputs the audio signal. |
| 2 Light Sensor | Senses room light level and adjusts the screen brightness accordingly (see page 42 for details). Do not put anything near the sensor and the nearby general area (as shown above), as its function may be affected. |
| 3 PIC OFF/TIMER LED | Lights up in green when the Picture Off feature is activated. Lights up in orange when the timer is set. When the timer is set, this LED will remain lit even if the TV is turned off. For details, see page 31 (Timer) and page 42 (Picture Off). |
| 4 STANDBY LED | Lights up in red when your TV is in PC standby mode. If the LED blinks in red continuously, this may indicate that the TV needs servicing (see contacting Sony information on the back cover). |
| 5 (IR) Infrared Receiver | Receives IR signals from the remote control. Do not put anything near the sensor, as its function may be affected. |
| 6 POWER LED | Lights up in green when the TV is turned on. |
| 7 SONY Logo Illumination | The Sony logo will illuminate when the TV is powered on. You can turn off the logo illumination, for details see page 42.  • Logo Illumination is available only for KDL-W series. |

Exploring Fun Features

Favorites

With **Favorites**, you can manage and customize your preferred **TV** channels, **External Inputs** and **Background TV** themes for easy access.

Displaying Favorites

Press **FAVORITES**.

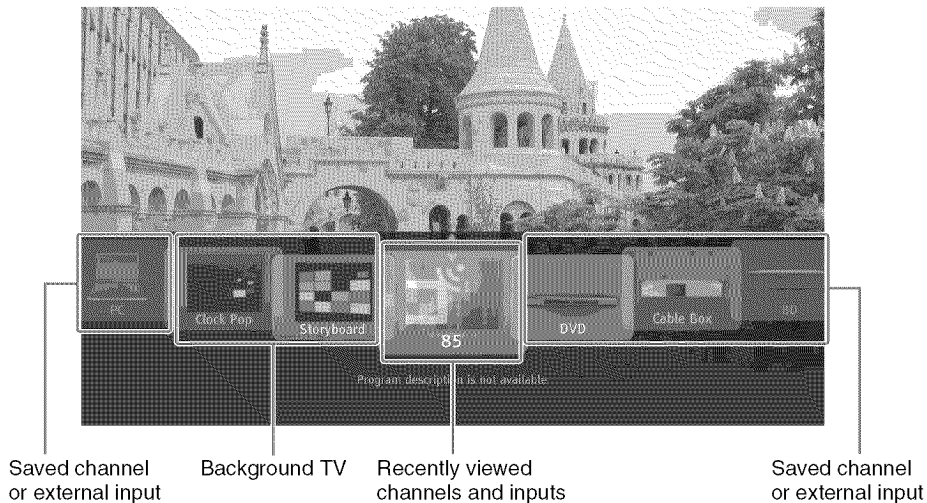

- The first time you enter **Favorites**, the recently viewed channels and inputs are highlighted.
- **Background TV** themes and some inputs are automatically saved into **Favorites** as a factory default. To remove from **Favorites**, follow the instructions below.

Navigating Favorites

- 1 Press **◀/▶** to move between saved selections in a carousel-like fashion.
- 2 When the recently viewed channels and inputs are highlighted, press **▲/▼** to move between them.
- 3 To tune to an item, highlight its icon and press **(+)**.



- To clear your recently viewed channels and inputs list, highlight the list in **Favorites** and press **OPTIONS**, then select **Clear Recently Viewed**. Recently viewed items are also cleared when the TV is powered off.

Adding to Favorites

- 1 While tuned to a channel or input you wish to add, press **OPTIONS**.
- 2 Press **▲/▼** to highlight **Add to Favorites** and press **(+)**.

Removing from Favorites

- 1 While tuned to the channel or input you wish to remove, press **OPTIONS**.
- 2 Press **▲/▼** to highlight **Remove from Favorites** and press **(+)**.



- **Auto Program** will clear your TV channels from **Favorites** (see pages 16 and 37).
- **Initial Setup** will return your **Favorites** to factory default settings (see page 42).

Background TV

Background TV displays images of current video on your TV that are similar to a screen saver. **Background TV** is available from the CABLE/ANTENNA and Composite inputs.

Navigating Background TV

- 1 Tune to one of the inputs listed above.
- 2 Press **OPTIONS**.
- 3 Highlight **Background TV** and press (+).
- 4 Highlight a theme and press (+). The TV will display the current channel or input using the selected **Background TV** theme.

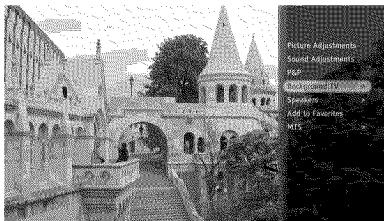

- 5 Press **RETURN** to exit the **Background TV** and return to the current channel or input.



- **Background TV** themes may also be saved to **Favorites**, so that you can launch these themes from the **Favorites** screen.

Using BRAVIA Sync with Control for HDMI

The BRAVIA Sync function on this TV communicates with other Sony equipment supporting the **Control for HDMI** function.

To connect Sony equipment with Control for HDMI

Use an HDMI cable that bears the HDMI logo for connection. See pages 12 to 15 or see the HDMI connection shown in the Quick Setup Guide provided with the TV documentation.

Setting the Control for HDMI

The **Control for HDMI** function must be set up in order for the TV to communicate with other **Control for HDMI** enabled equipment. See page 41 for information on how to set up this TV's **Control for HDMI** function. For other equipment, refer to its operating instructions.

Available options using Control for HDMI

The following operations are available after you connect the supported Sony equipment with **Control for HDMI** function to your TV:

- Automatically turn off the connected equipment when you turn off the TV.
- The TV will automatically turn on and select the respective HDMI input through the connected equipment is turned on by One-Touch-Play.
- Equipment listed under the **External Inputs** on the **XMB™** will turn on automatically when selected, see pages 5 and 29.
- Possible operations with **BRAVIA Sync** buttons, see page 19.

When a Sony A/V receiver with BRAVIA Sync is connected, the following additional operations are possible:

- Turning on the A/V receiver when the TV is turned on.
- Automatically switching to the audio output of the A/V receiver's attached speakers.
- Adjusting the volume and muting of the A/V receiver with the TV's remote control.



- The A/V receiver cannot be selected from the **XMB™**.

How to Use TV Guide On Screen

Use the Guide to find the show that you want to watch. The Guide allows you to search for shows by program categories and by keyword. The Guide provides up to two days of TV programming information. The Guide is available with cable service (without a cable box) or over-the-air antenna. Be sure to complete the **Initial Setup** on page 16 to use this service.

TV Guide On Screen System Components

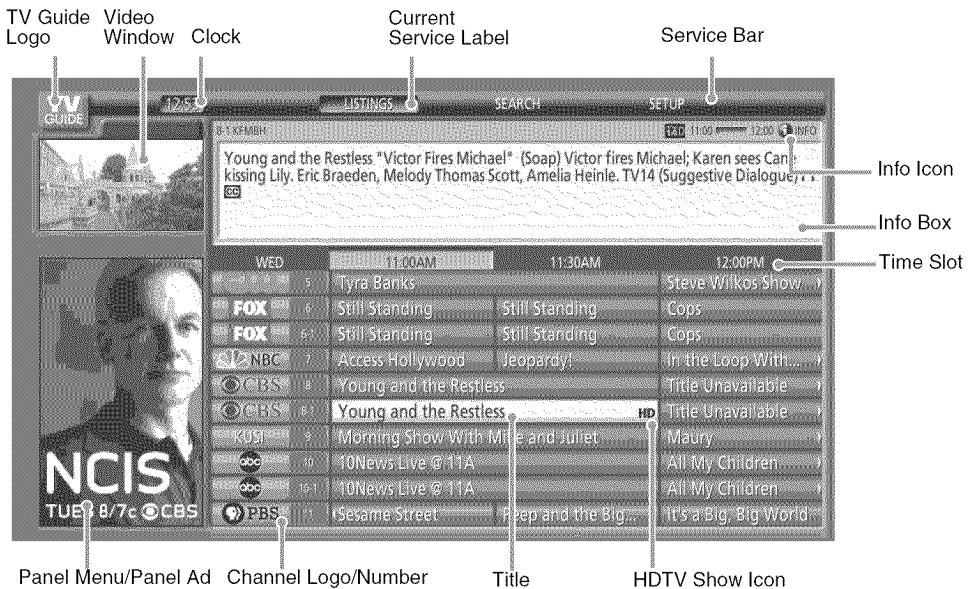

- Image shown above includes digital channels, which may not be available in some areas. If available, it may be necessary to manually change the channel display (see next page).

Use your TV's remote control to navigate the Guide system.

| To Do This ... | Do This... |
|-------------------------|--|
| View TV Guide | Press GUIDE to display the TV Guide. Press GUIDE again to exit or press HOME to exit to XMB™ . The TV Guide will time out in approximately 5 minutes when no action is taken. |
| Find a program to watch | Use ▲/▼/◀/▶ to highlight a program. The CH+/- buttons can be used to page up/down through the listings. The program information will appear in the Info Box. Press (+) to tune to the highlighted program. |
| Return to Service Bar | Press RETURN while in the TV Guide, or press OPTIONS to display the Panel Menu then highlight the go to Service Bar and press (+) . You can also press ▲ repeatedly to access the Service Bar. |
| Use shortcuts | Shortcuts allow viewing of listings for a different time slot or jumping to a channel of your choice. Enter a number using 0-9 buttons while LISTINGS on the Service Bar is highlighted. The Panel Menu will appear as soon as you enter a number. Complete entering the number in the Shortcuts. The entered number will determine the channel or listing hours ahead or back to view the program. Press ▲/▼ to make your selection. |

| To Do This ... | Do This... |
|--|--|
| Search program | Press ▲/▼/◀/▶ to highlight SEARCH on Service Bar. You can search for programs using the following options: KEYWORD, ALPHABETICAL, MOVIES, SPORTS, CHILDREN, EDUCATIONAL, NEWS, VARIETY, SERIES and HDTV . Press ⊕ then press ◀/▶ to highlight your search option. Press ▲/▼ to narrow your search. Press ⊕ when you found the program. If the program is airing now, press ⊕ to watch. |
| Keyword search | Keyword search can be done by type, category or subcategory of a program. Highlight SEARCH on the Service Bar, press ⊕ then press ◀/▶ to highlight KEYWORD . Press ⊕ again or press OPTIONS to display Keyword Options in the Panel Menu. Select new search to narrow your search by type, category or subcategory by pressing ▲/▼/◀/▶ . |
| Customizing the TV Guide On Screen system settings | Highlight SETUP on the Service Bar then press ▼ to highlight the available options to customize your system settings. You can change system settings, change channel display, change default options, display setup progress and diagnostics information. |
| Change channel display | Highlight SETUP on the Service Bar then press ▼ to highlight the Change channel display then press ⊕ . Highlight a channel then press OPTIONS to display the Grid Options. Make the changes using ▲/▼ and/or 0-9 buttons. When the changes are made, select done and press ⊕ . The Grid Options can also be used to re-sort the channel display numerically. Display the Grid Options and select re-sort numerically then press ⊕ . Confirm your numerically sorting by selecting yes to complete the task. |
| The Guide appears each time TV is turned on | Highlight SETUP on the Service Bar then press ▼ to highlight Change default options and then press ⊕ . Highlight General defaults and press ⊕ to display options in the Panel Menu. Set auto guide to on to have the Guide appear when the TV powers on. |
| Lock/unlock video | Allows you to set the Video Window display to remain on a single channel (locked) or change channels (unlocked) as you navigate through Listings. While in Service Bar, press OPTIONS to display the Listings Options in the Panel Menu. Press ◀/▶ to lock or unlock the video. The locked video option displays a single channel. |

Using P&P and PIP Features

This TV comes with the **P&P** and **PIP** features which allow you to view two pictures simultaneously. **P&P** (picture and picture) provides two windows side by side. **PIP** (picture in picture) provides PC input signal and TV channels.



- The CABLE/ANTENNA input must be connected to use the **P&P/PIP** features.
- **P&P** is not available with 1080/24p video format.
- **Closed Captions (CC)** is available with **P&P** (see page 38).

P&P

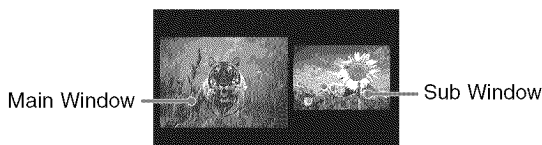

PIP

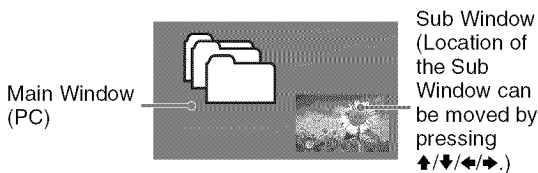

To Enter P&P and PIP

- 1 Press **OPTIONS** while watching one of the following inputs: TV channels, Video, Component, HDMI or PC.
- 2 Press \uparrow/\downarrow to highlight **P&P** or **PIP** and press (+).

| P&P Supported Inputs | |
|------------------------------------|----------------------------|
| In main window | In sub window |
| Video 1/2/3 | TV channel (CABLE/ANTENNA) |
| Component 1/2 | |
| HDMI IN 1/2/3/4 (except PC timing) | |

| PIP Supported Inputs | |
|-----------------------------|----------------------------|
| In main window | In sub window |
| PC | TV channel (CABLE/ANTENNA) |
| HDMI IN 1/2/3/4 (PC timing) | |



- To swap audio in **P&P** mode, use the \leftarrow/\rightarrow button to swap the highlight between the Main Window and Sub Window.
- To swap audio in **PIP** mode, press **OPTIONS**, then press \uparrow/\downarrow to highlight **Audio Swap**.
- For compatible PC Timings, refer to the PC Input Signal Reference Chart (see page 14).

To Change Inputs or Channels

- Press \leftarrow/\rightarrow to highlight the window to change for **P&P**. Press \leftarrow/\rightarrow to move the Sub Window for **PIP**.
- In the main window, press **INPUT** to select an input to watch.
 - In the sub window, change the channel by: pressing **CH+/-**; entering the channel number using the **0-9** numeric buttons; or pressing **JUMP** to switch to the previously viewed channel.

To Exit from P&P and PIP

- 1 Press **OPTIONS**.
- 2 Press \uparrow/\downarrow to highlight **Exit P&P** or **Exit PIP** (depends on the mode you are in), and press (+) to exit.



- You may also press **RETURN** while in these features to exit.
- Additional compatible device with TV tuner is required to watch two simultaneous live TV programs.

Using TV Settings



The **HOME** button allows you to access the **TV Home Menu** on the **XMB™** (XrossMediaBar) as well as a variety of TV features.

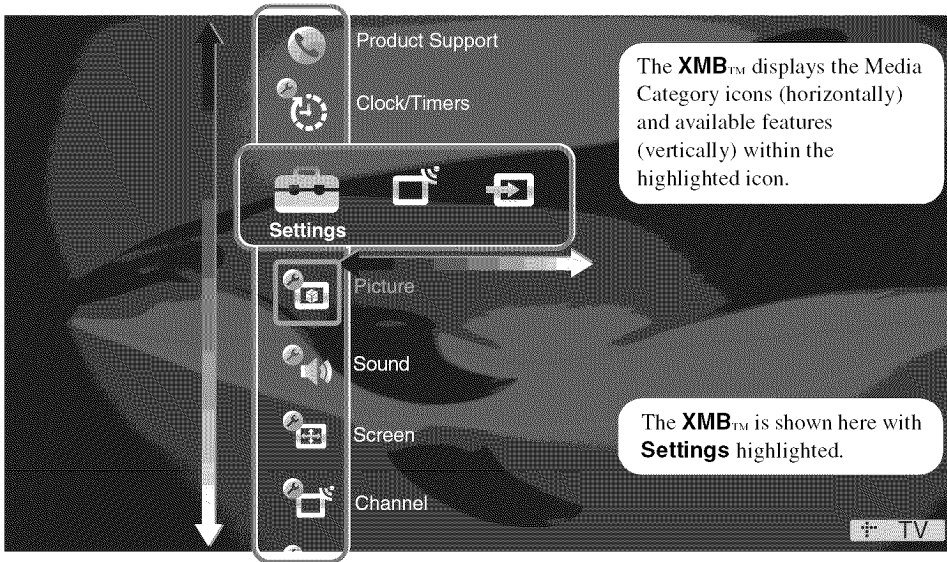

The **XMB™** displays the Media Category icons (horizontally) and available features (vertically) within the highlighted icon.

The **XMB™** is shown here with **Settings** highlighted.

Media Category Icons



Settings

Adjusting TV Settings

Customize the TV settings with various options. Explanations of different **Settings** start on page 31.

- The available options vary depending on the situations and conditions applied. Unavailable options are grayed out or not displayed.



TV

Watching TV

Navigate through the channel list or select the TV Guide On Screen icon located at the top of the channel list to select a channel (see page 26).

- You can also select a TV channel using the **0-9** or **CH+/-** buttons (see remote control section on pages 20 and 22).



External Inputs

Accessing External Inputs

Watch a movie, play a game, record a program or work on your PC.

Assign a label using the **Manage Inputs** feature for your convenience, see page 41.

Navigating through TV Home Menu on XMB™

1  Press **HOME** to display the XMB™.

2  Press **←/→** to select a Media Category icon.

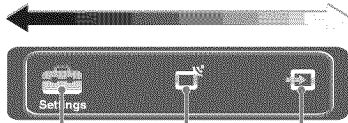



Available TV settings and features are listed under the **Settings** icon.

TV Guide On Screen and available channels are listed under the **TV** icon.

Select inputs from CTRL: HDMI (**Control for HDMI Video 1-3 Component 1-2 HDMI 1-4 PC**) under the **External Inputs** icon.

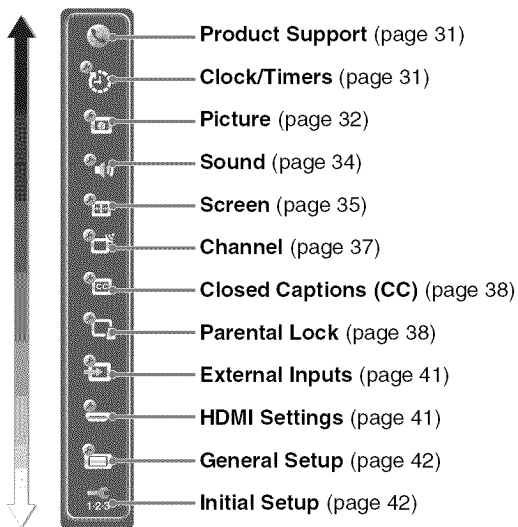
3  Press **↑/↓** to move within the Category Object Bar. (The Category Object Bar shown below is for **Settings**.)



4  Press **⊕** when desired item is highlighted.

5  Press **⊕** or **↑/↓** to select the highlighted item.

6  Press **RETURN** or **HOME** to exit.



TV Settings Descriptions



Product Support

| | |
|---------------------------|--|
| Contact Sony | Sony contact information is available from this screen for your convenience. Your TV's specific information such as Model Name, Serial Number, Software Version and downloadable ratings if available from the TV are displayed here. |
| Signal Diagnostics | Press to display the diagnostics information for the current signal. |
| Software Update | Press to view the current software version and check for software updates. Press to choose the new version and press to start the software update. <ul style="list-style-type: none">• The Broadcast Download service is available in the US.• CATV/antenna cable needs to be connected directly to the TV and have digital TV programming. (Not available with the use of a cable box.)• The software update is performed while the TV is powered on.• The Broadcast Download is performed while the TV is off.• Do not turn off the TV during software update; otherwise, software corruption may occur. |



Clock/Timers Settings

| | |
|---------------------|---|
| Current Time | Set the current day and time (date, hour, minutes, and AM/PM). The Timer feature will not be available until you set the Current Time . <ul style="list-style-type: none">• If the option is disabled, the TV Guide On Screen has automatically set the time. |
| Timer | Timer can be set to have the TV tune to a certain TV channel or other connected equipment as well as a specified volume at the specified time and duration you set. Turning on the Timer will allow setting the following: Day of the Week , Time , Duration , Input , Channel , and TV On Volume . |
| Sleep Timer | Sets the time in minutes (Off , 15 min , 30 min , 45 min , 60 min , 90 min , or 120 min) that you want the TV to remain on before shutting off automatically. This can also be set using the SLEEP button on the remote control (see page 19). |



Picture Settings

| | | | |
|----------------------------|---|-----------------------|--|
| Picture Adjustments | Picture Mode <i>For Video</i> | Vivid | For enhanced picture contrast and sharpness. |
| | | Standard | For standard picture settings. Recommended for home entertainment. |
| | | Cinema | For viewing film-based content. Most suitable for viewing in a theater-like environment. |
| | | Custom | Allows you to store your preferred settings. |
| | ----- <i>For Photo</i> | Photo-Vivid | For enhancing contrast and sharpness. |
| | | Photo-Standard | For standard viewing; select for home use. |
| | | Photo-Original | Images resemble the printed pictures from your photo album. |
| | | Photo-Custom | Allows you to store your preferred settings. |
| | ----- <i>For PC Timings</i> | Video | This option is available for PC timing (HDMI or PC input) signal to enhance the video shown on the screen. |
| | | Text | This option is available for PC timing (HDMI or PC input) signal to enhance the text shown on the screen. |



- **Picture Mode** for all inputs can also be accessed by pressing **PICTURE** on the remote control to directly toggle the modes.
- The options for **Picture Mode** may vary depending on the **Video/Photo Optimizer** setting (see page 33) and PC input.

| | | |
|---|--|--|
| Reset | Resets the current settings to the default values. | |
| Backlight | Brightens or darkens the backlight. | |
| Picture | Increases or decreases picture contrast. | |
| Brightness | Brightens or darkens the picture. | |
| Color | Increases or decreases color intensity. | |
| Hue | Increases or decreases the green tones. | |
| Color Temperature <i>White adjustment</i> | Cool | Gives the white colors a bluish tint. |
| | Neutral | Gives the white colors a neutral tint. |
| | Warm 1, 2 | Gives the white colors a reddish tint. |



- The option **Warm 1, 2** is not available for **Vivid** and **Photo-Vivid**.

| | |
|-----------------------------|---|
| Sharpness | Sharpens or softens the picture. |
| Noise Reduction | Reduces the picture noise level. |
| MPEG Noise Reduction | Reduces the mosaic effect in MPEG-compressed video. Useful for DVDs, Blu-ray and Digital TV channels. |

| | |
|---|--|
| Advanced Settings | Available in the following Picture Modes: Standard, Cinema, Custom, Photo-Standard, Photo-Original, and Photo-Custom. |
| Reset | Resets all the advanced settings to the default values. |
| Black Corrector | Enhances black areas of the picture for stronger contrast. |
| Advanced C.E. (Advanced Contrast Enhancer) | Automatically optimizes the backlight and contrast. This setting is especially effective for dark picture scenes. |
| Gamma | Adjusts the balance between light and dark areas of the picture. |
| Clear White | Emphasizes white and light colors. |
| Live Color | Makes colors more vivid and reproduces clear skin tones. |
| White Balance | Adjusts the color temperature in detail. |



- **Picture** settings available during PC input are **Picture Mode, Reset, Backlight, Picture, Brightness, and Color Temperature.**
- **Picture** settings for all inputs can also be accessed by pressing **OPTIONS** on the remote control, then selecting **Picture Adjustments** settings from the **OPTIONS** menu.

| | |
|--|--|
| Motion Enhancer <i>Motion Enhancer is available only for KDL-W series.</i> | Activates Motionflow to enhance the smoothness of picture movement and to reduce blur. |
| High | Provides smoother picture movement for film-based content. |
| Standard | Provides smooth picture movement. Use this setting for standard use. |
| Off | Use this setting when the High and Standard settings result in video artifacts such as ghosting. |



- Depending on the video, noticeable change may not be seen.
- **Motion Enhancer** is not available when **Game Mode** is set to **On**.

| | |
|-------------------|--|
| CineMotion | Automatically detects film-based content and applies an inverse 3-2 pull-down process and a motion estimation engine to improve film content and de-interlacing performance. |
| Auto 1 | Applies an inverse 3-2 pull-down process along with motion estimation to obtain the smoothest picture quality and reduces artifacts of moving images. Select for standard use. |
| Auto 2 | Applies only the inverse 3-2 pull-down process. Picture movement will be similar to the original film. |
| Off | Turns off CineMotion . |



- The **CineMotion** feature can be set separately for each input (except PC IN).

| | |
|------------------|---|
| Game Mode | Select On to optimize the enjoyment of fast paced video games where response time is important. Select Off to disable this feature. |
|------------------|---|



- The **Game Mode** can be set separately for each external input (except PC IN).

| | |
|------------------------------|---|
| Video/Photo Optimizer | Sets the picture settings to optimize the image quality of video (moving pictures) or photo (still image) content. Feature is only available for 1080i/p (excluding 1080/24p) content connected to the Component or HDMI input. |
|------------------------------|---|

| | |
|----------------|--|
| Video-A | The TV will automatically set the picture settings for video or still image content when Sony optional equipment that supports Video-A mode is connected to the HDMI input. |
| Video | Select to set the picture settings for video. |
| Photo | Select to set the picture settings for photos. |



- **Game Mode** and **Video/Photo Optimizer** features are not available when **Theater Mode** is set to **On**.



Sound Settings

Available **Sound** settings depend on the **Speakers** setting.

| | | | |
|--|--|--|---|
| Sound Adjustments | Sound Mode | Dynamic | Enhances treble and bass. |
| | | Standard | Standard sound optimized for home use. |
| | | Clear Voice | Suitable for spoken dialog. |
| | Reset | Resets the current settings to the default values. | |
| | Treble | Increases or decreases higher-pitched sounds. | |
| | Bass | Increases or decreases lower-pitched sounds. | |
| | Balance | Emphasizes left or right speaker balance. | |
| | Surround | S-FORCE | Provides a virtual surround sound experience made possible using just two front speakers. |
| | | Front Surround | |
| | | Off | Select for normal stereo or mono reception. |
| Voice Zoom | Adjusts the clarity of human voices. For example, if the voice of a news announcer is indistinct, you can turn up this setting to make the voice clearer. Conversely, if you are watching a sports program, you can turn down this setting to soften the voice of the commentator. | | |
| Sound Booster | The Sound Booster provides a fuller sound with a greater sense of depth and width, by emphasizing the high and low frequency sounds. Select High , Low or Off for the amount of boost you desire. Selecting Off will bypass the emphasis. | | |
| | | • Only available when in Standard mode. | |
| Steady Sound | Select On to stabilize the volume across all programs and commercials. Select Off to disable this feature. | | |
| Volume Offset | Adjusts the volume level of the current input (TV or video input) relative to other inputs. | | |
| | | • Sound Adjustments can also be accessed by pressing OPTIONS on the remote control. | |
| MTS <i>Enjoy stereo, bilingual and mono programs</i> | Stereo | For stereo reception when viewing a TV program broadcast in stereo. | |
| | Auto SAP | Automatically switches the TV to second audio programs when a SAP signal is received. If no SAP signal is present, the TV remains in Stereo mode. | |
| | Mono | For mono reception. Use to reduce noise during weak stereo broadcasts. | |
| | | • MTS is available only for analog programs. • MTS can also be accessed by pressing OPTIONS on the remote control. | |
| Speakers | TV Speakers | Select to use the TV speakers for audio. | |
| | Audio System | Select this option if you wish to use an external audio system for the TV sound. By selecting this option you are disabling the TV speakers. | |

| | | |
|--|-----------------|--|
| Audio Out <i>Easy control of volume adjustment</i> | Fixed | Select to fix the audio output and allow you to adjust the volume with your audio system's remote control. (The TV's remote control's VOL and MUTING buttons have no effect on the Audio Out .) |
| | Variable | Select to control the volume of your TV's speakers or audio system with your TV's remote control. |



- **Alternate Audio** is available only for digital programs. If the program you are watching is also available in other languages from the audio tracks, and if that language is what you have selected in the **Language** setting, your TV will automatically switch to the matching language with the **Alternate Audio** feature. The **Alternate Audio** option may be accessed by pressing **OPTIONS** on the remote control when an alternate audio stream is available from the broadcaster.



Screen Settings

| | | |
|------------------|------------------|---|
| Wide Mode | Wide Zoom | Fills the screen with minimum distortion. |
| | Normal | Displays the 4:3 picture in its original aspect ratio when the original source is 4:3. |
| | Full | Enlarges the picture horizontally to fill the screen when the original source is 4:3. When the original source is 16:9 (High-definition source), select this mode to display the 16:9 picture in its original size. |
| | H Stretch | Enlarges the picture horizontally to fill the screen when the original source is 16:9. It is useful for HD channels with 4:3 content. |
| | Zoom | Select to enlarge the picture horizontally and vertically to fill the screen while maintaining the aspect ratio. |



- **Wide Mode** can also be accessed by pressing **WIDE** on the remote control.
- See **WIDE** button description on page 22 for accessing the **Wide Mode**.
- **Normal** is available with 480i or 480p sources only.
- **H Stretch** is only available with 720p, 1080i, 1080p and 1080/24p sources.

| | | |
|------------------|------------|--|
| Auto Wide | On | Automatically changes Wide Mode setting based upon content. If frequent screen changes are disturbing to you, select Off . |
| | Off | Turns off the Auto Wide option. Choose a Wide Mode from the Wide Mode option. |

| | | |
|--|------------------|--|
| 4:3 Default <i>Select the default screen mode to use for 4:3 sources</i> | Wide Zoom | Enlarges the 4:3 picture to fill the 16:9 screen, displaying as much of the original image as possible. |
| | Normal | Displays the 4:3 picture in its original aspect ratio. |
| | Full | Select to enlarge the 4:3 picture horizontally only, to fill the screen. |
| | Zoom | Select to enlarge the picture horizontally and vertically to fill the screen while maintaining the aspect ratio. |
| | Off | Select to continue using the current Wide Mode setting when the channel or input is changed. |



- **4:3 Default** is not available if **Auto Wide** is set to **Off**.
- If **4:3 Default** is set to anything but **Off**, the **Wide Mode** setting applies only to the current channel. When you change channels (or inputs), **Wide Mode** is automatically replaced with the **4:3 Default** setting for 4:3 sources. To retain the current **Wide Mode** setting as channels and inputs are changed, set **4:3 Default** to **Off**.

(Continued)

| | | |
|---------------------|-------------------|---|
| Display Area | Full Pixel | Displays the picture for 1080i, 1080p or 1080/24p sources in its original size. |
| | Normal | Displays the picture in its original size. |
| | -1/-2 | Enlarges the picture to hide the edges of the picture. |



- For 720p, 1080i, 1080p and 1080/24p, feature is only available when **Wide Mode** is set to **Full**.

| | |
|------------------------|---|
| Screen Position | Adjust the Vertical positioning by pressing ▲/▼ . Press ◀/▶ to adjust the Horizontal positioning. |
|------------------------|---|



- **Screen Position** feature is useful if the TV is connected to game equipment.
- Vertical position is available only when **Wide Mode** is set to **Zoom**.
- For high-definition signals, **Vertical** and **Horizontal** positions are not available.

| | |
|----------------------|---|
| Vertical Size | Adjusts the vertical size of a standard-definition picture. |
|----------------------|---|



- **Vertical Size** is available only when **Wide Mode** is set to **Wide Zoom** or **Zoom** for standard-definition channels.

Screen settings for PC timings and HDMI-PC (PC input) differ from all other input modes and are shown below.

| | |
|--------------------|--|
| Auto Adjust | Select Yes to start the auto adjust for the PC input. |
| Reset | Resets the settings to the default values. |
| Phase | Adjust after Pitch to fine tune overall sharpness. |
| Pitch | Adjust uneven sharpness on screen. |



- For the PC input Signal Reference Chart, see page 14.

| | |
|-----------------|---|
| H Center | Allows you to move the position of the picture horizontally (left and right). |
| V Center | Allows you to move the position of the picture vertically (up and down). |

| | | |
|------------------|---------------|--|
| Wide Mode | Normal | Select to display the picture in its original resolution and aspect ratio. |
| | Full 1 | Select to enlarge the picture to fill the screen, while maintaining its original aspect ratio. |
| | Full 2 | Select to enlarge the picture to fill the screen. |







- **Wide Mode** can also be accessed by pressing **WIDE** on the remote control.
- See **WIDE** button description on page 22 for accessing **Wide Mode**.



- **Phase** and **Pitch** options are not available with PC signal connected to HDMI input.

Channel Settings

| | | |
|-----------------------------|---|--|
| Signal Type | Cable | For receiving cable channels via cable TV provider. |
| | Antenna | For receiving signal via over-the-air antenna. |
| |  | |
| | | • You should run Auto Program after changing the Signal Type setting. |
| Auto Program | Automatically sets the channel list in the TV for all receivable channels. Channel scanning will be based on the Signal Type (Cable/Antenna) setting. | |
| | 1 Select Auto Program . | |
| | 2 Select OK to start Auto Program . When Auto Program is completed, the screen will display the number of channels found. | |
| | 3 Press RETURN to exit Auto Program . | |
| |  | |
| | | • Running Auto Program will clear the Favorites channel list for the current signal type. |
| | | • If you run Auto Program again, previously scanned channels will be overwritten with the newly scanned channels. |
| Add Digital Channels | Select to add digital channels. Be sure to have the Signal Type option selected appropriately for the signal source. (Useful for antenna installations.) | |
| Show/Hide Channels | Allows you to show or hide channels when you surf with the CH +/- button or in the TV channel list on the XMB™ . | |
| | 1 Press ▲/▼ to scroll through the channels until you highlight the channel to show or hide. | |
| | 2 Press ⊕ to select Shown or Hidden . To show or hide more channels, repeat steps 1-2. | |
| |  | |
| | | • Hidden channels can be accessed by entering the channel number with 0-9 buttons on the remote control. |
| Edit Channel Labels | Assigns labels (such as station call letters) to channel numbers. | |
| | 1 Press ▲/▼ to scroll through the channel numbers. Then press ⊕ to select the channel number to assign a label. | |
| | 2 Press ▲/▼ to scroll through the label characters (A-Z, 0-9, etc.). Press ▶ to move to the next character. Repeat to add up to 7 characters to the label. Press ⊕ to set it. To assign labels to more channels, repeat steps 1-2. | |
| |  | |
| | | • This feature is not available when using the TV Guide On Screen system. |

Closed Captions (CC) Settings

| | |
|------------------------|--|
| CC Display | This option allows you to view Closed Captions (CC) . On Enables CC Display . Off Disables CC Display . On with Muting Automatically displays closed captions when the TV is muted. |
| Analog CC | For the basic analog (EIA-608) closed caption options. CC1, CC2, CC3, CC4 Displays a printed version of the dialogue or sound effects of a program. (Should be set to CC1 for most programs.) Text1, Text2, Text3, Text4 Displays network/station information presented using either half or the whole screen (if available). |
| Digital CC | For both analog (EIA-608) and digital (EIA-708) closed caption options. Select from Service 1-6 and CC1-4 (advanced digital closed caption options). |
| Display Options | Customize the Closed Captions (CC) displays with Text, Character Size, Character Style, Character Color, Character Opacity, Edge Type, Edge Color, Background Color and Background Opacity . |



- **Closed Captions (CC)** can be turned **On, Off** or **On with Muting** directly by pressing **CC** on the remote control.

Parental Lock Settings

The **Parental Lock** feature allows you to block programs according to their content and rating levels and block channels (regardless of the programs). Password is necessary in setting up blocking.



- The **Parental Lock** feature is also available with Video and Component (480i) inputs.

To View Blocked Programs

Press **ENT** when tuned to a blocked program, then enter the password. To reactivate the **Parental Lock** settings, turn off and on the TV.

| | |
|-----------------|---|
| Password | Use 0-9 button on the remote control to enter a four-digit password. The first time the password is created, you must re-enter it again to confirm the password. "Password set" message will appear on the screen upon confirmation. |
|-----------------|---|

Change Password

You can change your password by entering the **Parental Lock** setting with the previously set password. Highlight and select **Change Password**, then enter the new password.



- You need your password for any future access into the **Parental Lock** settings. If you lose your password, see "Lost password" on page 45.

| | |
|----------------|---|
| Country | Select the country name of U.S.A. or Canada for the appropriate ratings. The rating system varies between these two countries. See Custom Rating System Chart on page 40. |
|----------------|---|

| | | |
|---------------|--------------------|---|
| Rating | Off | Turns off Parental Lock . No programs are blocked from viewing based on their ratings. |
| | Child | Ratings permitted are: United States TV Rating: TV-Y, TV-G MPAA: G Canada English TV Rating: C, G French TV Rating: G |
| | Youth | Maximum ratings permitted are: United States TV Rating: TV-PG MPAA: PG Canada English TV Rating: PG French TV Rating: 8 ans+ |
| | Young Adult | Maximum ratings permitted are: United States TV Rating: TV-14 MPAA: PG-13 Canada English TV Rating: 14+ French TV Rating: 13 ans+ |
| | Custom | Sets ratings manually. U.S.: See page 40 for details. Canada: See page 40 for details. |



- If you are not familiar with the parental guideline rating system, you should select **Child**, **Youth**, or **Young Adult** to help simplify the rating selection. To set more specific ratings, select **Custom**.

| | | |
|--|------------------|--|
| Digital Rating (Available only in U.S.A. where advanced ratings exist) | Off | Turn Digital Rating off. No programs containing digital ratings are blocked from viewing. |
| | Clear All | Select to clear the downloaded ratings. |
| | Custom | Select to customize the Parental Lock with downloadable digital ratings. |
| Unrated (Available only when Country is set to U.S.A.) | Allow | Allows programs and movies that are broadcasted without a rating. |
| | Block | Blocks all programs and movies that are broadcasted without a rating. |



- If you block unrated TV programs, be aware that the following types of programs may be blocked: programs broadcast from another country, emergency broadcasts, political programs, sports, news, public service announcements, religious programs and weather.

| | |
|----------------------|--|
| Channel Block | Allows you to block specific channels regardless of program ratings. The password needs to be set up prior to blocking channels. The blocked channel can only be viewed by entering the correct password. To View a Blocked Channel Press ENT when tuned to the blocked channel then enter the password. |
|----------------------|--|

(Continued)

Custom Rating System Chart

For **Country** selection of **U.S.A.**:

| | | |
|---------------------|--------------------|--|
| Movie Rating | G | All children and general audience |
| | PG | Parental guidance suggested |
| | PG-13 | Parental guidance for children under 13 |
| | R | Restricted viewing, parental guidance is suggested for ages under 17 |
| | NC-17 and X | No one 17 or under allowed |

| | | |
|--|-----------------------|--------------------------------------|
| TV Rating <i>Block programs by their rating, content or both</i> | Age-Based Ratings | |
| | TV-Y | All children |
| | TV-Y7 | Directed to children age 7 and older |
| | TV-G | General audience |
| | TV-PG | Parental guidance suggested |
| | TV-14 | Parents strongly cautioned |
| | TV-MA | Mature audience only |
| | Content-Based Ratings | |
| | FV | Fantasy violence |
| | D | Suggestive dialogue |
| | L | Strong language |
| | S | Sexual situations |
| | V | Violence |



• To ensure maximum blocking capability, set the Age-Based Ratings.

For **Country** selection of **Canada**:

| | | |
|-----------------------|---|------------------------------------|
| English Rating | C | All children |
| | C8+ | Children 8 years and older |
| | G | General programming |
| | PG | Parental guidance |
| | 14+ | Viewers 14 and older |
| | 18+ | Adult programming |
| French Rating | G | General programming |
| | 8 ans+ | Not recommended for young children |
| | 13 ans+ | Not recommended for ages under 13 |
| | 16 ans+ | Not recommended for ages under 16 |
| | 18 ans+ | Programming restricted to adults |
| U.S.A. Rating | See TV Rating under U.S.A. for details. | |



External Inputs Settings

Manage Inputs

Follow the steps below to customize your input menu for easy recognition when the **INPUT** button is pressed or when selecting an input from the **XMB™**.

- 1** Press **▲/▼** to highlight your input selection.
- 2** Press **⊕** to set **Enable** setting to either **Always** or **Auto**. **Always** option will display this input in the input menu at all times. With the **Auto** option, the input with connected icon will only appear when external equipment is connected and/or an HDMI signal is present. Some external equipment may not be detected automatically.
- 3** To assign your own label to the input, press **➡** to highlight the label option, then press **▲/▼** to choose a name of the equipment that is connected to this input.



- You can assign following labels for each input (except PC IN):
-, DVD, Cable Box, Satellite, BD, VCR, Receiver, DVR, Game, Camcorder, PC.
- “-” indicates that no labels are assigned.

Channel Tuning Keys

This setting controls how the remote control channel tuning keys (**0-9, CH+/-** and **JUMP**) behave while using an external input.

- | | |
|-----------------|--|
| Enabled | Select to allow the TV to exit from the external input and return to a TV channel when pressing the tuning keys. |
| Disabled | Select to disable the tuning keys during external input mode and prevent unintentionally exiting the external input. |



- Useful for applications that do not have a connection to the CABLE/ANTENNA input.



HDMI Settings

HDMI inputs of this TV will recognize and communicate with other Sony equipment equipped with **Control for HDMI** function.





- | | |
|------------------------------|---|
| Control for HDMI | On/Off feature allows your TV to communicate with other equipment that supports Control for HDMI function. |
| Device Auto Power Off | Select On to have your connected equipment with Control for HDMI function to power off automatically when the TV is turned off. Select Off to disable this function. This feature is available when Control for HDMI is On . |
| TV Auto Power On | Select On to control your TV's power on from your connected equipment with Control for HDMI function. Select Off to disable this function. This feature is available when Control for HDMI is On . |
| Device List | Displays a list of equipment with Control for HDMI function connected to the TV. |



- Press **OPTIONS** while the equipment supporting **Control for HDMI** is connected to display the **Device Control** options. The **Device Control** option provides access to the **Menu, Options** and **Content List** of your connected equipment with your TV remote control.
- Some equipment with **Control for HDMI** does not support the **Device Control** feature.



General Setup Settings

| | |
|--|--|
| Language | Select the language of your choice from English , Español and Français to be used for displaying all the on-screen settings. |
| Info Banner | Displays the program name and the program information such as program title and program rating (if available from the broadcaster). Select the amount of program information to display when tuning. |
| | Small Select to display minimal channel and program information. |
| | Medium Select to display channel and program information. |
| | Large Select to display detailed channel and program information. |
| |  <ul style="list-style-type: none"> • Info Banner appears on the screen each time the channel is changed or when DISPLAY on the remote control is pressed. |
| Home Menu Scrolling | Adjust the navigation speed through menu items. |
| | Standard Select to scroll quickly with ▲/▼ buttons. |
| | Mode 1 Select to scroll slowly with ▲/▼ buttons. |
| | Mode 2 Select to scroll individually with repeated ▲/▼/◀/▶ button press. |
| Power Saving | Reduces the power consumption by adjusting the backlight brightness. This also enhances the black level. Select from Off , Low , High and Picture Off . |
| |  <ul style="list-style-type: none"> • While Picture Off is set, pressing VOL +/- or MUTING buttons will not disable this function. Press other buttons to disable it. |
| Light Sensor | Enables the automatic picture (screen) brightness control. The Light Sensor measures the room brightness which allows the TV to automatically adjust the backlight brightness based on the picture settings and the ambient room light conditions. |
| |  <ul style="list-style-type: none"> • Be sure not to put anything around the sensor, as its function may be affected (see page 18). • In low light the range of the backlight control is reduced when the Light Sensor is set to On. |
| PC Power Management | Select On to have the TV automatically enter standby mode when there is no signal input for more than 30 seconds. The STANDBY LED on the front panel illuminates with the On option. Select Off to disable this feature. |
| |  <ul style="list-style-type: none"> • Press POWER to exit from standby mode. • PC Power Management is not VESA-compliant. |
| Logo Illumination <i>Logo Illumination is available only for KDL-W series.</i> | Select On to illuminate the SONY logo on the front panel or select Off to disable this function. |



Initial Setup

If you missed the **Initial Setup** when you first connected the TV or if you want to scan all receivable channels, select **Initial Setup**. Follow the instructions on the screen. Some settings such as **Picture Adjustments**, **Sound Adjustments**, and **Parental Lock** will not be affected by this **Initial Setup**. If you wish to return your TV to factory settings, please see the Troubleshooting section on page 45.



- **Favorite** channel list will be cleared each time you run the **Initial Setup**.

Other Information

Troubleshooting

If you have questions, service needs, or require technical assistance related to the use of your Sony TV, please visit our website or call one of the following numbers:

<http://www.sony.com/tvsupport>
1-800-222-SONY(7669) for US Support
1-877-899-SONY(7669) for Canadian Support

| Condition | Explanation/Solution |
|--|---|
| No picture | |
| No picture | <ul style="list-style-type: none">• Check the Power Saving settings (see page 42). |
| Cannot receive any channels | <ul style="list-style-type: none">• Make sure the power cord is connected securely.• Turn on the power of the TV.• Check cable/antenna connections.• Make sure the Signal Type setting is correct for your TV signal source. |
| TV is locked to one channel | <ul style="list-style-type: none">• Perform Auto Program to add receivable channels that are not present in the TV's memory (see pages 16 and 37). |
| Cannot receive or select channels | <ul style="list-style-type: none">• Perform Auto Program to add receivable channels that are not present in the TV's memory (see pages 16 and 37).• To receive or select cable channels, make sure that Signal Type in the Channel settings is set to Cable (see page 37). To receive or select UHF channels over an antenna, make sure Signal Type is set to Antenna. |
| The TV turns off automatically | <ul style="list-style-type: none">• Check if Sleep Timer is activated, or confirm the Duration setting of Timer (see page 31).• Check PC Power Management in General Setup settings (see page 42). |
| No picture from some video sources | <ul style="list-style-type: none">• Check the connection between the optional video equipment and the TV.• Press INPUT on the remote control (see page 20).• Press HOME on the remote control. Select your desired input from the External Inputs list. |
| Poor picture | |
| Picture quality not as good as viewed at the store | <ul style="list-style-type: none">• Picture quality depends on the signal content. See Quick Setup Guide (supplied) to display the best possible picture for that signal. |
| Broadcast HD formats have poor quality | <ul style="list-style-type: none">• Content and signal quality are regulated by the signal provider. Many HD channels and content are actually upscaled versions of standard-definition broadcasts. The picture is affected by the quality of the signal received, which varies between channel and program.• Confirm the picture quality by selecting Signal Diagnostics in the Product Support settings (page 31). Then select Sample Image (or Additional Information first). An HD image will display on the screen to confirm routine panel operation. If your normal picture quality is worse than this sample image, it is most likely due to the signal provided by the broadcaster. |
| Double images or ghosts | <ul style="list-style-type: none">• Check cable/antenna connections.• Check the antenna location and direction. |
| Only snow and noise appear on the screen | <ul style="list-style-type: none">• Check if the antenna is broken or bent.• Check if the antenna has reached the end of its serviceable life. (3-5 years in normal use, 1-2 years at the seaside.) |
| Dotted lines or stripes | <ul style="list-style-type: none">• Keep the TV away from noise sources such as cars, motorcycles, or hair-dryers.• If using 300 ohm twin lead, move the excess lead away from the TV or try using 75 ohm coaxial cable instead. |

(Continued)

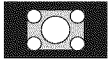
| Condition | Explanation/Solution |
|--|--|
| No color / Dark picture / Color is not correct / The picture is too bright | <ul style="list-style-type: none"> • Press PICTURE to select the desired Picture Mode (see page 21). • Adjust the Picture Mode options in the Picture settings (see page 32). • If you set the Power Saving mode to Low or High, it will enhance the black level (see page 42). |
| Noisy picture | <ul style="list-style-type: none"> • Make sure that the antenna is connected using a 75-ohm coaxial cable. • Keep the antenna cable away from other connecting cords. • To avoid TV interference, make sure to use an undamaged antenna cable. |
| Blurry picture / Poor color | <ul style="list-style-type: none"> • Transporting the TV from a cold to a warm location or a sudden change in room temperature may cause moisture condensation, resulting in a blurry picture or poor color. Turn off your TV and wait a few hours before powering on again. |
| No sound / Noisy sound | |
| No sound / Good picture | <ul style="list-style-type: none"> • Check the volume control. • Press MUTING or VOL + so that “Muting” disappears from the screen (page 20). • Set Speakers to TV Speakers in the Sound settings (see page 34). If it is set to Audio System, sound is not output from the TV’s speakers regardless of the TV’s volume control. • When using HDMI input with Super Audio CD or DVD-Audio, DIGITAL OUT (Optical) may not provide an audio signal. • When tuned to a digital channel with Alternate Audio, the broadcaster may not be broadcasting your preferred Alternate Audio language. Press OPTIONS, highlight and select Alternate Audio, and change the Alternate Audio language (see page 35). |
| Audio noise | <ul style="list-style-type: none"> • Make sure that the antenna is connected using a 75-ohm coaxial cable. • Keep the antenna cable away from other connecting cords. • To avoid TV interference, make sure to use an undamaged antenna cable. |
| No Audio or Low Audio with Home Theater System | <ul style="list-style-type: none"> • Press THEATER for BRAVIA Sync activated Theater System (see page 25). • Set Speakers to Audio System in the Sound settings (see page 34). • Set Audio Out to Fixed in the Sound settings (see page 35). |
| BRAVIA Sync | |
| Cannot find connected BRAVIA Sync HDMI device | <ul style="list-style-type: none"> • Make sure that the Control for HDMI is set up on both the TV and the optional device compatible with BRAVIA Sync (see page 25). |
| Second A/V receiver is not listed on the Device List | <ul style="list-style-type: none"> • Only one A/V receiver may be used with the BRAVIA Sync and Control for HDMI functions at one time (see page 41). |
| PC Input | |
| No picture / No signal | <ul style="list-style-type: none"> • Confirm the PC is correctly connected to the TV with either the PC IN (with an HD15 cable) or with the HDMI IN. • Ensure the output signal from the PC is one of the formats listed on page 14. • Turn the PC off. Confirm the PC connection and restart the PC. Plug-and-play will auto-detect the TV and correctly set up PC timing. • Verify PC Power Management is activated (see page 42). • Verify the PC is not in standby or hibernation mode. |
| Poor Picture | <ul style="list-style-type: none"> • Adjust the resolution (see page 14). • Adjust Pitch and Phase. |
| General | |
| Wide Mode changes automatically | <ul style="list-style-type: none"> • The current Wide Mode setting is automatically replaced with the 4:3 Default setting when you change the channel or video input, if 4:3 Default in the Screen settings is set to other than Off. If you want to lock in Wide Mode selected with WIDE on the remote control, set 4:3 Default to Off in the Screen settings (see page 35). • Check the Auto Wide option in the Screen settings (see page 35). |
| Suddenly the picture gets smaller | <ul style="list-style-type: none"> • The picture gets smaller during the commercials due to the method in which the provider broadcasts their content. When HD content channels switch to SD content (commercials), the picture may be small with a black border. • Auto Wide will not expand the picture during these content changes since the content information is regulated by the channel signal provider. You can manually change the Wide Mode if you prefer (see page 22). This setting will remain in effect until you change the channel or input or manually change the Wide Mode again. |
| |  |

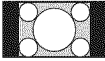
| Condition | Explanation/Solution |
|--|--|
| "Black box" on screen | <ul style="list-style-type: none"> You have selected a text option and no text is available (see page 38). To turn off this feature, set the CC Display option to Off. If you were trying to select closed captioning, select CC1 instead of Text1-4. |
| Black bands appear at the edges of the screen  | <ul style="list-style-type: none"> Some wide screen programs are filmed in aspect ratios that are greater than 16:9 (this is especially common with theatrical releases). Your TV will show these programs with black bands at the top and bottom of the screen. For more details, check the documentation that came with your DVD (or contact your program provider). Programs in 4:3 aspect ratio will have bands on left and right sides of the screen. Programs broadcast in HD formats (720p and 1080i) with 4:3 content will commonly have black bands on the left and right sides of the screen which are added by the broadcaster (see image on left). Auto Wide will not expand the picture when the black bands on the sides of the screen are added by the broadcaster. You can manually change the Wide Mode to Wide Zoom, H Stretch or Zoom to fill the screen, which will remain in affect until you change the channel or input or manually change the Wide Mode again. |
| Certain programs on DVD or other digital sources display a loss of detail, especially during fast-motion or dark scenes | <ul style="list-style-type: none"> This is due to the digital compression of the source content used by certain digital broadcasts and DVDs which may cause your TV's screen to display less detail than usual, or cause artifacts (small blocks or dots, pixelations) to appear on your screen. These signal compressions are more visible and are dependent on the clarity and resolution of the TV. |
| Remote control does not operate | <ul style="list-style-type: none"> To determine if the problem is with the remote control or not, press a button on the TV. Check the polarity of the batteries or replace the batteries. Point the remote control at the remote control sensor located at the front of the TV. Keep the remote control sensor area clear from obstacles. Fluorescent lamps can interfere with your remote control operation; try turning off the fluorescent lamps. |
| Some digital cable channels are not being displayed | <ul style="list-style-type: none"> Certain cable companies have limitations on the broadcast of digital cable channels. Check with your cable company for more information. The digital cable channel may be set to Hidden in the Show/Hide Channels setting (see page 37). |
| Lost password | <ul style="list-style-type: none"> Select the Password settings on the Parental Lock settings, then enter the following master password: 4357. This password clears your previous password and allows you to enter a new password (see page 38). |
| How to reset the TV to factory settings | <ul style="list-style-type: none"> Turn on the TV. While holding down ▲ on the remote control, press POWER on the TV. (The TV will turn itself off, then back on again.) Release ▲. WARNING: The reset will clear all of your customized settings including the Parental Lock setting. |

Specifications

| Model | KDL-32XBR6 | KDL-37XBR6 | KDL-40V4150 KDL-40V4100 KDL-40W4100 | KDL-42V4100 | KDL-46V4100 KDL-46W4100 KDL-46W4150 | KDL-52V4100 KDL-52W4100 | |
|---|--|--|---|--|--|--|---|
| System | | | | | | | |
| Television system | NTSC: American TV standard ATSC (8VSB terrestrial): ATSC compliant 8VSB QAM on cable: ANSI/SCTE 07 2000 (Does not include CableCARD functionality) | | | | | | |
| Channel coverage | Analog terrestrial: 2 - 69 / Digital terrestrial: 2 - 69 Analog Cable: 1 - 135 / Digital Cable: 1 - 135 | | | | | | |
| Panel system | LCD (Liquid Crystal Display) Panel | | | | | | |
| Speaker output | 10 W + 10 W | | | | | | |
| Input/Output jacks | | | | | | | |
| CABLE/ANTENNA | 75-ohm external terminal for RF inputs | | | | | | |
| VIDEO IN 1/2/3 | S VIDEO (4-pin mini DIN) (VIDEO 1 only): Y: 1.0 Vp-p, 75 ohms unbalanced, sync negative / C: 0.286 Vp-p (Burst signal), 75 ohms VIDEO: 1 Vp-p, 75 ohms unbalanced, sync negative AUDIO: 500 mVrms (Typical) / Impedance: 47 kilohms | | | | | | |
| COMPONENT IN 1/2 | YPBPR (Component Video): Y: 1.0 Vp-p, 75 ohms unbalanced, sync negative / PB: 0.7 Vp-p, 75 ohms / PR: 0.7 Vp-p, 75 ohms / Signal format: 480i, 480p, 720p, 1080i, 1080p AUDIO: 500 mVrms (Typical) / Impedance: 47 kilohms | | | | | | |
| HDMI IN 1/2/3/4 | HDMI: Video: 480i, 480p, 720p, 1080i, 1080p, 1080/24p / Audio: Two channel linear PCM 32, 44.1 and 48 kHz, 16, 20 and 24bits, Dolby Digital AUDIO (HDMI IN 4 only): 500 mVrms (Typical) / Impedance: 47 kilohms | | | | | | |
| AUDIO OUT | 500 mVrms (typical) | | | | | | |
| DIGITAL OUT (OPTICAL) | PCM/Dolby Digital optical signal | | | | | | |
| PC IN | D-sub 15-pin, analog RGB, 0.7 Vp-p, 75 ohms, positive See the PC Input Signal Reference Chart on page 14. | | | | | | |
| PC AUDIO INPUT | Stereo mini jack, 500 mVrms, (Typical) / Impedance: 47 kilohms | | | | | | |
| Power and others | | | | | | | |
| Power requirement | 120 V AC, 60 Hz | | | | | | |
| Power consumption | in use V and XBR6 series | 160 W | 200 W | 220 W | 240 W | 260 W | 285 W |
| | W series | | | 230 W | | 275 W | 295 W |
| in standby | All models less than 0.1 W* | | | | | | |
| Screen size (inches measured diagonally) | 31.5 (32 class) | 37 | 40 | 42 | 46 | 52 | |
| Display resolution | 1,920 dots (horizontal) × 1,080 lines (vertical) | | | | | | |
| Speaker/Full range (2)**(mm) (inches) | 55 × 120 2 1/8 × 4 3/4 | 58 × 126 2 1/4 × 5 | 58 × 126 2 1/4 × 5 | 58 × 126 2 1/4 × 5 | 65 × 150 2 1/2 × 5 7/8 | 65 × 150 2 1/2 × 5 7/8 | |
| Dimensions with stand (mm) (inches) | 794 × 577 × 242 31 3/8 × 22 3/4 × 9 3/8 | 920 × 649 × 279 36 1/4 × 25 5/8 × 11 | 986 × 684 × 279 38 7/8 × 27 × 11 | 1,033 × 718 × 307 40 3/4 × 28 3/8 × 12 1/8 | 1,120 × 782 × 307 44 1/8 × 30 7/8 × 12 1/8 | 1,262 × 871 × 347 49 3/4 × 34 3/8 × 13 3/4 | |
| | without stand (mm) (inches) | 794 × 540 × 99 31 3/8 × 21 3/8 × 4 | 920 × 610 × 110 36 1/4 × 24 1/8 × 4 3/8 | 986 × 646 × 110 38 7/8 × 25 1/2 × 4 3/8 | 1,033 × 677 × 110 40 3/4 × 26 3/4 × 4 3/8 | 1,120 × 742 × 115 44 1/8 × 29 1/4 × 4 5/8 | 1,262 × 829 × 119 49 3/4 × 32 3/4 × 4 3/4 |
| wall-mount hole pattern (mm) | 200 × 200 | 300 × 300 | 300 × 300 | 300 × 300 | 300 × 300 | 300 × 300 | |
| wall-mount screw size (mm) | M6 × 12 - 18 | | | | | | |
| Mass | with stand (kg) (lb.) | 15.0 34.0 | 21.0 47.0 | 23.0 51.0 | 28.5 63.0 | 30.0 67.0 | 38.0 84.0 |
| | without stand (kg) (lb.) | 12.0 27.0 | 18.0 40.0 | 20.0 45.0 | 24.5 54.0 | 26.0 58.0 | 32.0 71.0 |
| Supplied accessories | Remote control RM-YD023 (1) / Size AA batteries (2) / AC power cord (KDL-40V4150/KDL-40V4100/KDL-46V4100/KDL-52V4100/KDL-40W4100/KDL-46W4100/KDL-52W4100/KDL-46W4150) (1) / Cable holder (1 attached to the TV) / Operating Instructions (1) / Warranty Card (1) / Online Registration Card (U.S.A. and Canada only) (1) / Safety and Regulatory Booklet (1) / Attaching the Table-Top Stand (1) / Installing the Wall-Mount Bracket (1) | | | | | | |
| Optional accessories | Connecting cables / Support Belt Kit / Wall-Mount Bracket: SU-WL500 / TV Stand: see page 2 | | | | | | |

* While the TV is collecting TV Guide data and/or during software update the power consumption is less than 30 W.

** KDL-W series models come with additional 30 mm (1 1/8") tweeters.



- Optional accessories availability depends on its stock.
- Design and specifications are subject to change without notice.

Index

0-9 buttons 20
4:3 Default 35

A

AC IN 11
Add Digital Channels 37
Advanced Settings 33
Analog CC 38
Audio Out 35
AUDIO OUT jack 11
Auto Adjust 36
Auto Program 37
Auto Wide 35

B

Background TV 25
Backlight 32
Balance 34
Bass 34
Bilingual audio 34
BRAVIA Sync buttons 19
Brightness 32

C

CABLE/ANTENNA input 11
CC button 19
CC Display 38
CH +/- button 22
Channel Block 39
Channel Tuning Keys 41
CineMotion 33
Color 32
Color Temperature 32
COMPONENT IN jack (1080p/1080i/
720p/480p/480i) 11
Contact Sony 31
Control for HDMI 41
Country 38
Current Time 31

D

Device Auto Power Off 41
Device List 41
Digital CC 38
DIGITAL OUT (OPTICAL) jack 11
Digital Rating 39
Display Area 36
DISPLAY button 19
Display Options 38
DMe^x button 20
DMe^x/SERVICE 11

E

Edit Channel Labels 37
English Rating 40
ENT button 20

F

Favorites 24
FAVORITES button 19
FREEZE button 20

French Rating 40

G

Game Mode 33
GUIDE button 19

H

H Center 36
HDMI IN jack 11
HOME button 20
Home Menu Scrolling 42
Hue 32

I

Info Banner 42
Infrared Receiver (IR) 23
INPUT button 20
Installing the TV on a wall 7

J

JUMP button 22

L

Language 42
Light Sensor
 Described 23
 Setting 42
Logo Illumination 42

M

Manage Inputs 41
Motion Enhancer 33
Movie Rating 40
MPEG Noise Reduction 32
MTS 34
MUTING button 20

N

Noise Reduction 32

O

OPTIONS button 21

P

P&P 28
Password 38
PC IN jack 11
PC Power Management 42
Phase 36
PIC OFF/TIMER LED 23
Picture 32
Picture Adjustments 32
PICTURE button 21
Picture Mode 32
PIP 28
Pitch 36
POWER button 20
POWER LED 23
Power Saving 42

R

Rating 39

Reset 32, 34, 36, 45
RETURN button 20

S

S VIDEO jack 11
Screen Position 36
Settings
 Channel 37
 Clock/Timers 31
 Closed Captions (CC) 38
 External Inputs 41
 General Setup 42
 HDMI Settings 41
 Initial Setup 42
 Parental Lock 38
 Picture 32
 Product Support 31
 Screen 35
 Sound 34
Sharpness 32
Show/Hide Channels 37
Signal Diagnostics 31
Signal Type 37
SLEEP button 19
Sleep Timer 31
Software Update 31
Sound Adjustments 34
Sound Booster 34
Sound Mode 34
Speaker 23
Speakers 34
STANDBY LED 23
Steady Sound 34
Surround 34

T

Timer 31
Treble 34
Troubleshooting 43–45
TV Auto Power On 41
TV Guide On Screen 26
TV Rating 40

U

U.S.A. Rating 40
Unrated 39

V

V Center 36
Vertical Size 36
VIDEO IN jack 11
Video/Photo Optimizer 33
Voice Zoom 34
VOL +/- button 20
Volume Offset 34

W

WIDE button 22
Wide Mode 35, 36

For Your Convenience

Please contact Sony directly if you:

- Have questions on the use of your television after reading your Operating Instruction manual and Quick Setup Guide
- Experience difficulty operating your television

Contact Sony Customer Support at:

<http://www.sony.com/tvsupport>

or to speak with a support representative:

United States

1-800-222-SONY (7669)

Canada

1-877-899-SONY (7669)

Sony will work to resolve your questions more quickly than your retailer or place of purchase.

Please Do Not Return the Product to the Store



<http://www.sony.net/>

Printed in U.S.A.



Free Manuals Download Website

<http://myh66.com>

<http://usermanuals.us>

<http://www.somanuals.com>

<http://www.4manuals.cc>

<http://www.manual-lib.com>

<http://www.404manual.com>

<http://www.luxmanual.com>

<http://aubethermostatmanual.com>

Golf course search by state

<http://golfingnear.com>

Email search by domain

<http://emailbydomain.com>

Auto manuals search

<http://auto.somanuals.com>

TV manuals search

<http://tv.somanuals.com>