

SONY®



PS3™

PlayStation®3

Instruction Manual

Before using this product, carefully read all product documentation and retain it for future reference.

CECH-2102A
CECH-2102B
CECH-2103A
CECH-2103B

4-184-386-81(1)

WARNING

To avoid electrical shock, do not open the cabinet. Refer servicing to qualified personnel only.

Caution

Use of controls or adjustments or performance of procedures other than those specified herein may result in hazardous radiation exposure.

The use of optical instruments with this product will increase eye hazard.



This appliance is classified as a CLASS 1 LASER product under IEC60825-1+A2:2001.

NOTICE FOR CUSTOMERS IN THE UNITED KINGDOM



This equipment has been tested and found to comply with the limits set out in the R&TTE Directive using a connection cable shorter than 3 metres. Do not use cables longer than 3 metres.

A molded plug complying with BS1363 is fitted to this equipment for your safety and convenience. Should the fuse in the plug supplied need to be replaced, a 5AMP fuse approved by ASTA or BSI to BS1362, (i.e., marked with ⚡ or ⚡ mark) must be used. If the plug supplied with this equipment has a detachable fuse cover, be sure to attach the fuse cover after you change the fuse. Never use the plug without the fuse cover. If you should lose the fuse cover, please contact your nearest Sony service station.

The manufacturer of this product is Sony Computer Entertainment Inc., 2-6-21 Minami-Aoyama, Minato-ku Tokyo, 107-0062 Japan. The Authorised Representative for EMC and product safety is Sony Deutschland GmbH, Hedelfinger Strasse 61, 70327 Stuttgart, Germany.

Distributed in Europe by Sony Computer Entertainment Europe Ltd, 10 Great Marlborough Street, London, W1F 7LP.

Seizures induced by light stimulation (Photosensitive Epilepsy)

If you have an epileptic condition or have had seizures, consult your doctor prior to playing. Some individuals may experience eye soreness, altered vision, migraine, muscle twitching, convulsion, blackout, loss of awareness or disorientation when exposed to flashing or flickering lights or other light stimulation on a television screen or while playing video games. If you experience any of the above symptoms while playing, discontinue use immediately and consult your doctor.

Stop playing immediately when you experience the following symptoms

In addition to the above symptoms, whilst playing if you have a headache, dizziness, nausea, fatigue, similar symptoms to motion sickness, or if you feel a discomfort or pain in any body part such as eyes, ears, hands, arms, feet, discontinue use immediately. If the condition persists, seek medical attention.

Radio waves

Radio waves may affect electronic equipment or medical devices (for example, pacemakers), which may cause malfunctions and possible injuries.

- If you use a pacemaker or other medical device, consult your physician or the manufacturer of your medical device before using the wireless networking feature (Bluetooth® and wireless LAN).
- Do not use the wireless networking feature in the following locations:
 - Areas where wireless network use is prohibited, such as in hospitals. Abide by medical institution regulations when using the system on their premises.
 - Areas near fire alarms, automatic doors and other types of automated equipment.

System software

The System Software included within this product is subject to a limited licence from Sony Computer Entertainment Inc. Refer to <http://www.scei.co.jp/ps3-eula> for further details.

About national export control

This product may fall within the scope of national export control legislation. You must comply fully with the requirements of such legislation and of all other applicable laws of any jurisdiction in relation to this product.

Table of contents

WARNING	2	Connecting to the Internet	32
Precautions	5	Using the Internet browser.....	32
Online information about the PS3™ system	10	Viewing the user's guide	32
XMB™ (XrossMediaBar) menu.....	11	Creating a PlayStation®Network account.....	32
Part names	12	PS3™ system updates.....	33
Getting started.....	13	Using the on-screen keyboard.....	34
Connection methods.....	13	Parental control	35
Performing initial setup of the system software.....	15	Replacing the hard disk.....	36
Video output on the PS3™ system.....	16	Backing up data	36
Connecting digital audio devices	20	Removing the hard disk	37
Turning the PS3™ system on and off.....	21	Replacing the hard disk	38
Using the wireless controller.....	22	Reinstalling the system software	39
Playing content	24	Restoring data that has been backed up	40
Blu-ray Disc (BD)/DVD/CD.....	24	Restoring the PS3™ system	41
Playing content on USB devices.....	25	Before disposing of or transferring the PS3™ system	41
File formats that can be played or viewed.....	25	Before requesting service.....	43
Playing games	26	Specifications.....	48
Game compatibility	26	GUARANTEE	52
Playing games	26	Copyright and trademarks.....	56
Controller settings.....	26		
Saved data for PlayStation®3 format software	26		
Saved data for PlayStation® format software	27		
Adjusting network settings.....	28		
Adjusting network settings (wired)	29		
Adjusting network settings (wireless).....	29		
Adjusting custom settings	31		

Precautions

Safety

This product has been designed with the highest concern for safety. However, any electrical device, if used improperly, has the potential for causing fire, electrical shock or personal injury. To help ensure accident-free operation, follow these guidelines:

- Observe all warnings, precautions and instructions.
- Regularly inspect the AC power cord for damage and for dust build-up around the power plug or electrical outlet.
- Stop use, unplug the AC power cord from the electrical outlet and disconnect any other cables immediately if the device functions in an abnormal manner, produces unusual sounds or smells or becomes too hot to touch.
- Contact the appropriate PlayStation® customer service helpline which can be found within every PlayStation®3 software manual.

Use and handling

- Use in a well-lit area and keep a safe distance from the TV screen.
- Avoid prolonged use of the PS3™ system. Take a 15-minute break during each hour of play.
- Avoid playing when you are tired or need sleep.
- Stop using the system immediately if you begin to feel tired or if you experience discomfort or pain in your hands or arms while operating the Wireless Controller. If the condition persists, consult a doctor.
- If you experience any of the following health problems, discontinue use of the system immediately. If symptoms persist, consult a doctor.
 - Dizziness, nausea, fatigue or symptoms similar to motion sickness
 - Discomfort or pain in a part of the body, such as eyes, ears, hands or arms
- Keep the system and accessories, including cable ties and fasteners, out of the reach of small children.
- Do not connect cables other than a USB cable while the system is turned on (power indicator lit solid green).

- Do not touch the system or connected cables or accessories during an electrical storm.
- Do not use the system or accessories near water.
- Do not allow liquid, small particles or other foreign objects to get into the system or accessories.
- Do not touch the connectors of the system or accessories.
- Do not expose the system or accessories to dust, smoke or steam. Also, do not place the system in an area subject to excessive dust or cigarette smoke. Dust build-up or cigarette smoke residue on the internal components (such as the lens) may cause the system to malfunction.
- Do not expose the system or accessories to high temperatures, high humidity or direct sunlight.
- Do not place the system or accessories on surfaces that are unstable, tilted or subject to vibration.
- Do not set the system other than in the vertical or horizontal position. When setting the system in the vertical position, use the vertical stand (sold separately) for this model of the system. Also, do not change the position while the system is turned on.
- Be careful when carrying the system. If you do not have a good grip, the system may drop causing potential damage or injury.
- Do not move or change the position of the system with a disc inserted. The vibration may result in scratching of the disc or the system.
- Do not turn off the system while data is being saved on or loaded from the hard disk.
- Do not stand on or put objects on the system, and do not stack the system with other devices.
- Do not place the system and connected accessories on the floor or in a place where they may cause someone to trip or stumble.
- Do not allow bodily contact with the system or air from the system vents for an extended period of time while in use. Extended contact under these conditions may cause low-temperature burns.

Precautions

- When connecting the system to a plasma or projection* TV, do not leave a still image on the TV screen for an extended period of time, as this may leave a faint image permanently on the screen.
* Except LCD screen types
- Parents are encouraged to monitor children in online activities to ensure safe and responsible Internet usage. Refer to <http://www.ps-playsafeonline.com> for further details.

Notes on safety when using the DUALSHOCK®3 Wireless Controller*

- Do not use the vibration function if you have any ailment or injury to the bones, joints or muscles of your hands or arms. If you have an ailment or an injury, do not play such titles using the DUALSHOCK®3 Wireless Controller unless you have set the vibration function to [Off].
- When using the motion sensor function of the Wireless Controller, be cautious of the following points. If the controller hits a person or object, this may cause accidental injury or damage.
 - Before using the motion sensor function, make sure you have enough space to move around.
 - Firmly grip the Wireless Controller to prevent it from slipping out of your grasp and causing damage or injury.
 - When using the Wireless Controller with a USB cable, ensure that the cable cannot hit a person or any object, and do not pull the cable out of the PS3™ system whilst playing.

* These notes also apply to other controllers.

Vents

Do not block any vents. To maintain good ventilation, follow the guidelines below:

- Place the system at least 10 cm away from a wall surface.
- Do not place on a carpet or rug with long fibres.
- Do not place in a narrow or cramped space.

- Do not cover with cloth.
- Do not allow dust to build up on the vents.

AC power cord use

- To help ensure safe operation, regularly inspect the AC power cord. If damaged, stop use immediately and contact the appropriate PlayStation® customer service helpline which can be found within every PlayStation®3 software manual.
- Do not use a power cord other than the supplied AC power cord. Do not modify the cord.
- Do not touch the plug of the AC power cord with wet hands.
- Protect the AC power cord from being walked on or pinched particularly at plugs, expansion receptacles and the point where the cord exits from the system.
- Do not place heavy items on the cord.
- Do not place the AC power cord near heating equipment and do not expose the cord to heat.
- Do not allow dust or foreign matter to build up around the AC IN connector. Before connecting or plugging in the AC power cord, check that there is no dust or foreign matter in or on the power plug or connecting end of the cord, the electrical outlet or the AC IN connector on the system rear. If the plug or connector becomes dirty, wipe off with a dry cloth before connecting.
- Unplug the AC power cord from the electrical outlet before cleaning or moving the system, or when you do not intend to use the system for an extended period of time. When disconnecting, grasp the power cord by the plug and pull straight out of the electrical outlet. Never pull by the cord and do not pull out at an angle.
- Do not connect the AC power cord to a voltage transformer or inverter. Connecting the AC power cord to a voltage transformer for overseas travel or an inverter for use in an automobile may cause heat to build up in the system and may cause burns or a malfunction.

Never disassemble or modify the system or accessories

Use the PS3™ system and accessories according to the instructions in the product documentation. No authorisation for the analysis or modification of the system or accessories, or the analysis and use of its circuit configurations, is provided. Unauthorised modification of the system or accessories will void your warranty. There are no user serviceable components inside the PS3™ system (the supplied hard disk may be removed but not disassembled or modified). Additionally, there is a risk of exposure to laser radiation as well as to electrical shock.

Network

- A broadband Internet connection is required to connect to a network.
- User is responsible for Internet service fees. For details, refer to the information provided in your service contract or contact your Internet service provider.
- Use only an Ethernet cable compatible with 10BASE-T, 100BASE-TX or 1000BASE-T networks. Do not use a cord for a standard residential telephone line or cables of types other than those mentioned here. Using the wrong type of cord or cable can cause more electrical current than necessary to flow through the LAN connector, which may lead to heat build-up, fire or malfunction.

Wireless networking feature

- The 2.4 GHz range of radio waves used by the wireless networking feature of this product is a range shared by various devices. This product has been designed to minimise the effect of other devices using the same range. However, in some cases interference from other devices may reduce the connection speed, shorten the signal range or cause the connection to be terminated unexpectedly.

- When using the PS3™ system's scan function to select a wireless LAN access point, access points that are not intended for public use may be displayed. Only connect to an access point that you are authorised to use, or one that is available through a public wireless LAN or hotspot service.

Moisture condensation

If the system or disc is brought directly from a cold location to a warm one, moisture may condense on the lens inside the system or on the disc. Should this occur, the system may not operate properly. In this case, remove the disc and turn off and unplug the system. Do not put the disc back in until the moisture evaporates (this may take several hours). If the system still does not operate properly, contact the appropriate PlayStation® customer service helpline which can be found within every PlayStation®3 software manual.

Cleaning

For safety reasons, before cleaning the system or connected accessories, disconnect the AC power cord from the electrical outlet.

Exterior surfaces (plastic cover of system and Wireless Controller)

Follow the instructions below to help prevent the product exterior from deteriorating or becoming discoloured.

- Wipe with a soft, dry cloth.
- Do not apply insecticides or other volatile substances.
- Do not place any rubber or vinyl materials on the product exterior for an extended period of time.
- Do not use solvents or other chemicals. Do not wipe with a chemically-treated cleaning cloth.

Precautions

Vents

When dust accumulates in the system vents, remove the dust with a low-powered vacuum cleaner.

Connectors

Do not use when the connectors of the system or the AC power cord are not clean. If used when dirty, the flow of electrical current may be obstructed. Remove the dirt with a dry cloth.

Discs

Note on compatibility

Some media may have region or territorial restrictions and may not work with your system. See media packaging for details.

Handling

- Do not touch the disc surface when handling a disc; hold it by the edges.
- Do not stick paper or tape onto discs and do not write on discs.
- Fingerprints, dust, dirt or scratches on the disc can distort the picture or reduce sound quality. Always handle carefully and check that discs are clean before use.

Storage

- Do not expose discs to high temperatures, high humidity or direct sunlight.
- When discs will not be used for an extended period of time, store them in their cases. Stacking uncased discs or storing them at an angle can cause them to warp.

Cleaning method

- Clean discs with a soft cloth, lightly wiping from the centre outwards.
- Do not use solvents, record cleaners, anti-static spray or other chemicals as these can damage the discs.



Online information about the PS3™ system

This manual explains hardware features and provides basic information about how to set up and operate the PS3™ system, including warnings and precautions for the safe and proper use of the system. You can also access the following information available on the Internet.

Online user's guide access from : eu.playstation.com/manuals

This guide contains detailed information about using the PS3™ system.

System software updates <http://eu.playstation.com/ps3>

This site provides the latest information about system software updates.

PlayStation®3 official site <http://eu.playstation.com/ps3>

The official site for PlayStation®3 products provides the latest information about software titles and hardware accessories.

Support <http://eu.playstation.com/help-support>

The official site for PlayStation® product support provides the latest questions and answers about your product.

Check that you have all of the following items. If any items are missing, contact the appropriate PlayStation® customer service helpline which can be found within every PlayStation®3 software manual.

- PlayStation®3 system
- DUALSHOCK®3 Wireless Controller
- Printed materials

- AC Power Cord

One of the following two cable types is supplied with the system. The plug configuration varies depending on the country or region.

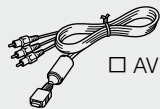

AV Cable



USB Cable

- Euro-AV Connector Plug
(supplied with the system sold in the UK only)



Friends

Chatting and exchanging messages



PlayStation®Network

Using PlayStation®Network services



Network

Connecting to the Internet



Game

Playing games



Video

Playing video



Music

Playing music



Photo

Displaying images



Settings

Adjusting PS3™ system settings



Users

Selecting users to log in to the PS3™ system

Information about system functionality and images published in this document may vary from those for your PS3™ system, depending on the system software version in use.

Download from www.SoftManuals.com. All Manuals Search And Download.

XMB™ (XrossMediaBar) menu

The PS3™ system includes a user interface called XMB™ (XrossMediaBar).



- 1 Select a category using the ◀ or ▶ button.
- 2 Select an item using the ▲ or ▼ button.
- 3 Press the ⊗ button to confirm the selected item.

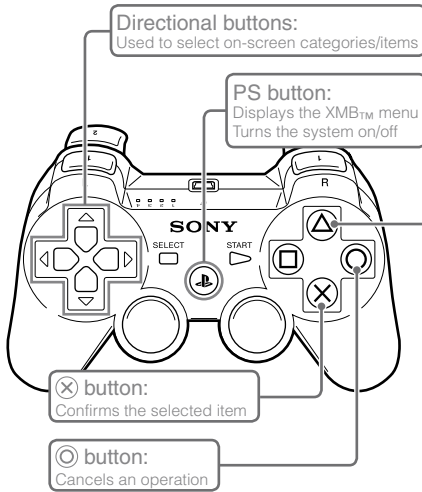

△ button: Displays the options menu/control panel

Selecting an icon and pressing the △ button will display the options menu. Pressing the △ button during content playback will display the control panel.

The three screenshots show the XMB interface in different states:

- Icons:** A screenshot of the XMB menu with a 'Sort By' options menu open over the 'Music' category.
- Options menu:** A screenshot of the 'Sort By' options menu with 'Group Content' selected.
- Control panel:** A screenshot of the XMB menu during content playback, showing a control panel overlay with playback controls and a numeric keypad.

Icons Options menu Control panel

Part names

System front / rear

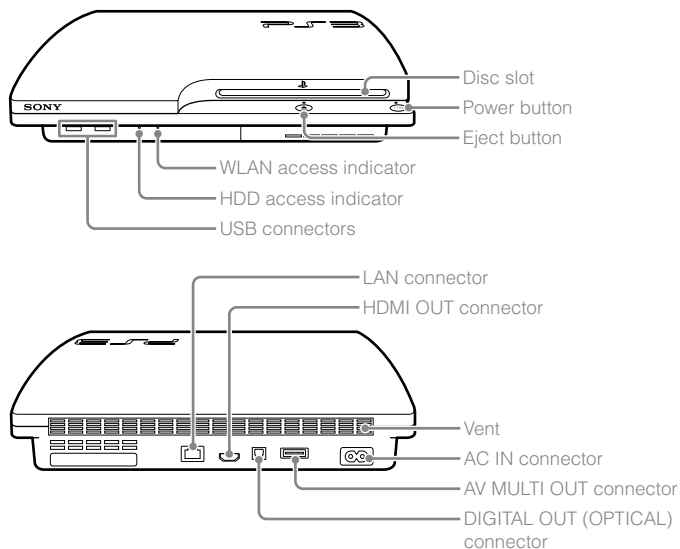

⚠ Caution

- Do not use the system in a closed cabinet or other locations where heat may build up. Doing so may cause the system to overheat and may lead to fire, injury or malfunction.
- If the system's internal temperature becomes elevated, the power indicator will flash alternately in red and green. In this case, turn off the system (▶▶ page 21) and leave it unused for a while. After the system cools down, move it to a location with good ventilation, and then resume use.

DUALSHOCK®3 Wireless Controller

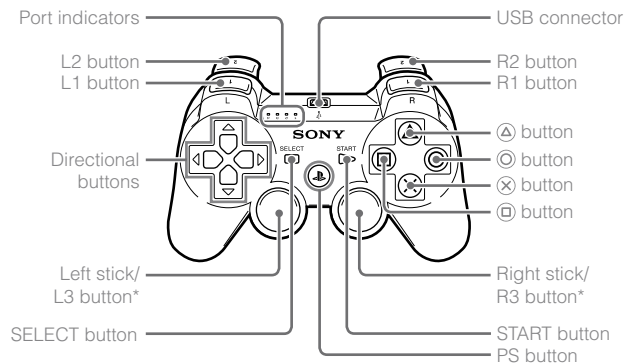

* The L3 and R3 buttons function when the sticks are pressed.

Notices

- Do not place the system in an area subject to excessive dust or cigarette smoke. Dust build-up or cigarette smoke residue on the internal components (such as the lens) may cause the system to malfunction.
- Do not move or change the position of the system while the power indicator is lit solid green or flashing green. The vibration that occurs as a result of moving the system may cause data loss or corruption, or damage to the system.

Hint

When placing the system in a vertical position, use the vertical stand (sold separately).

Getting started

Connection methods

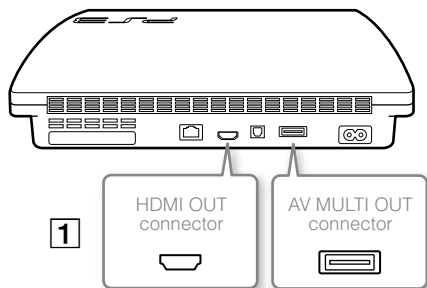

If video is not displayed on the screen

If you change the type of cable used to connect the system to a TV, video may not appear on the screen. If video does not appear, turn off the system and then turn it on again by pressing the power button for at least five seconds (until the system beeps twice). The video output setting will be reset and video will be output at standard definition (SD) resolution.

1 Connect your system to a TV

You can use any of the following methods to connect your system to a TV.

Video output in SD (Standard Definition) resolution

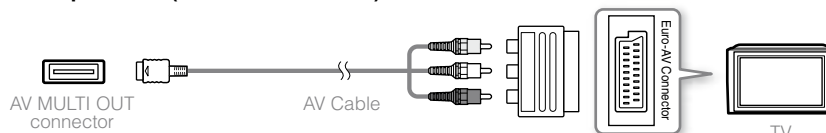

Video output in HD (High Definition) resolution - component video

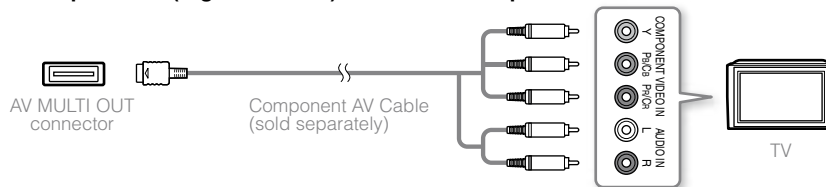

Video output in HD (High Definition) resolution - HDMI™

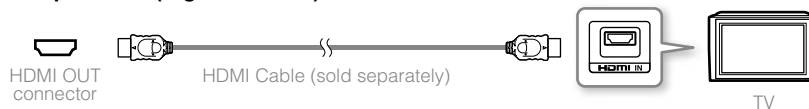

Hints

- For details about video output cable types and supported video modes, see "Video output on the PS3™ system" (→ page 16) and "Video output cable types" (→ page 17).
- You can connect audio devices that support digital audio playback, such as an AV receiver for home entertainment use. For details, see "Connecting digital audio devices" (→ page 20).

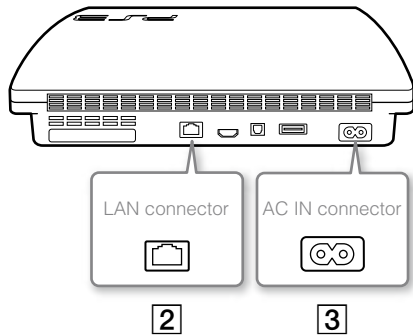

2 Connect an Ethernet cable (sold separately)

Use an Ethernet cable to connect the system to the Internet.

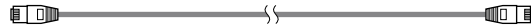

Hint

You can use a wireless network connection to connect to the Internet without using an Ethernet cable. For details, see "Adjusting network settings" (→ page 28).

⚠ Caution

Do not connect a standard telephone line or other types of cords or cables that are not compatible with the system directly to the LAN connector on the system, as this may cause heat build-up, fire or malfunction.

3 Connect the AC power cord

After plugging the AC power cord into the electrical outlet, the power indicator on the PS3™ system will light up in solid red (→ page 21).

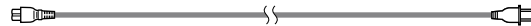

Some regions and countries may use a different electrical outlet plug from the one illustrated.

⚠ Caution

Do not plug the AC power cord for the system into an electrical outlet until you have made all other connections.

Performing initial setup of the system software

After turning on the system, perform initial setup.

- 1 Turn on the TV, and then switch the video input of the TV to match the input connector used by the PS3™ system.

- 2 Press the power button.

The power indicator turns green and the picture is displayed on the TV screen.

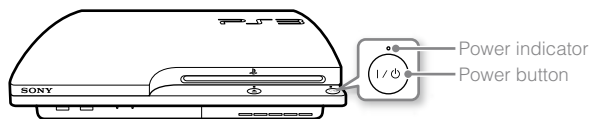

- 3 Connect the wireless controller to the system using a USB cable.

- 4 Press the PS button on the controller.

The system will recognise the controller. After it has recognised the controller, the initial setup screen will be displayed.

- 5 Perform initial setup.





Follow the on-screen instructions to enter settings for system language, time zone, date and time, and user name.

The screen for setting up the Internet connection will be displayed. When connecting using an Ethernet cable, basic settings will be selected automatically if you follow the on-screen instructions. When connecting over a wireless LAN, follow the instructions in "Adjusting network settings (wireless)" (➡ page 29) to set up the connection.

After the settings have been completed, the XMB™ menu (➡ page 11) will be displayed on the TV screen.

Hints

- When using an HDMI cable to connect the system to the TV, a screen for changing the video output resolution will be displayed during initial setup. If you select [Yes] on the screen and then press the  button, the optimal output resolution will be selected automatically.
- For details on entering text, see "Using the on-screen keyboard" (➡ page 34).
- Settings entered during initial setup can be changed under  (Settings) or  (Users). For details, refer to the online user's guide (access from : eu.playstation.com/manuals).

Getting started

Video output on the PS3™ system

The PS3™ system can output two types of resolution: HD and SD. Refer to the instruction manual for the TV in use to check which video mode is supported.

	HD (High Definition)			SD (Standard Definition)	
Video mode *1	1080p	1080i	720p	576p	576i *2
Aspect ratio	16:9	16:9	16:9	16:9 4:3	16:9 4:3

*1 This number indicates the number of scan lines. Note that "i" stands for "interlace" and "p" stands for "progressive". Using progressive results in high-quality video with minimal flickering.

*2 The video output setting on the system will display as [Standard (PAL)].

Screens showing the difference in resolution





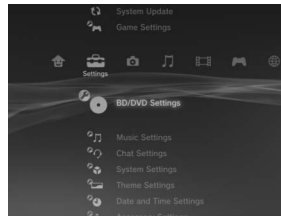





HD screen

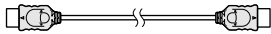

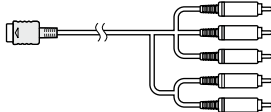
SD screen

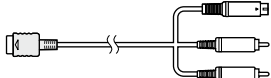
Video output cable types

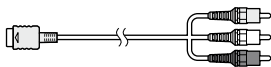
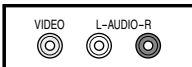
The resolution displayed on the TV varies depending on the input connectors on the TV and the type of cable in use. Select a cable to match the TV in use.

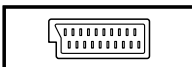
Cable type	Input connector on the TV	Supported video modes*1
HDMI Cable*2 (sold separately) 	HDMI IN connector 	1080p / 1080i / 720p / 576p
Component AV Cable (sold separately) 	Component VIDEO IN connector 	1080p / 1080i / 720p / 576p / 576i*3
S VIDEO Cable (sold separately) 	S VIDEO IN connector 	576i*3
AV Cable (supplied) 	VIDEO IN connector (composite) 	576i*3
AV Cable (supplied) Euro-AV Connector Plug (supplied with the system sold in the UK only) 	Euro-AV connector (SCART) 	576i*3

*1 Depending on the type of TV or content to be played, some video modes may not be supported.

*2 Connect the system to the TV using an HDMI cable (sold separately). An HDMI cable can output both video and audio and enables you to enjoy digital-quality video and audio.

*3 The video output setting on the system will display as [Standard (PAL)].

Getting started

Adjusting video output settings

Depending on the type of cables and the connectors used, you may need to adjust the PS3™ system's video output settings to display video at HD resolutions (➡ page 16) on a TV.

If video is not displayed

- Switch the video input of the TV to match the input connector used to connect to the system.
- Turn off the system, and then turn it on again by pressing the power button for at least five seconds (until the system beeps twice). The video output setting will be reset and video will be output at standard definition (SD) resolution.

1 Select  (Settings) ➡  (Display Settings) ➡ [Video Output Settings], and then press the  button.

2 Select the input connector (➡ page 17) in use on the TV, and then press the  button.

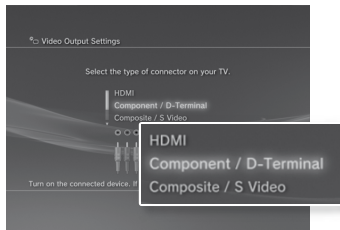

If you select [HDMI], you will have the option to choose [Automatic] or [Custom] on the next screen. In most cases, select [Automatic], and video output settings will be completed automatically.

If you select [AV MULTI / SCART], you must choose the type of output signal on the next screen. In most cases, select [Y Pb/Cb Pr/Cr].

3 Confirm the screen, and then press the  button.

If you changed the connector in step 2, a screen for confirming the change will be displayed.

4 Confirm the settings, select [Yes], and then press the  button.

If you changed the connector in step 2, a screen for confirming the settings will be displayed.



5 Select the resolutions supported by the TV, and then press the  button.

The resolution displayed on the TV varies depending on the input connector and the type of cable used (➡ page 17). The highest resolution you selected will be used for video output.

Depending on the connector selected in step 2, this screen may not be displayed.

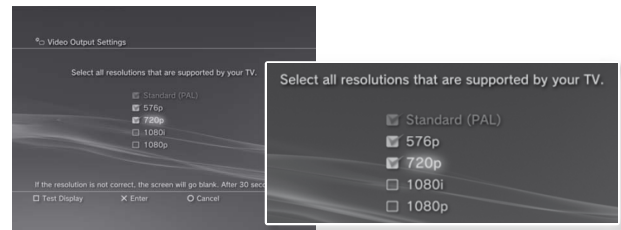

6 Confirm the settings, select [Yes], and then press the **X** button.

Depending on the connector selected in step 2 and the resolutions selected in step 5, this screen may not be displayed.



7 Select the type of TV, and then press the **▶** button.

If you selected [Standard (PAL)] or [576p] in step 5, a screen for selecting the TV screen size will be displayed. Adjust the setting to match the TV in use.

If you selected [720p] or a higher resolution in step 5, the TV type will automatically be set to 16:9 and the screen for selecting the TV screen size will not be displayed.

8 Confirm the settings, and then press the **X** button.

The video output settings will be saved on the system.

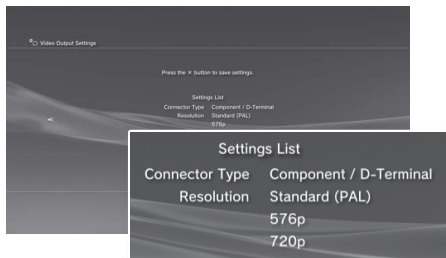

9 Adjust audio output settings.

Continue on to adjust audio output settings. Adjust settings to match the TV or audio device in use.



If you select [HDMI], you will have the option to choose [Automatic] or [Manual] on the next screen. In most cases, select [Automatic].

If using a cable other than an HDMI cable to output audio from the TV, select [Audio Input Connector / SCART / AV MULTI]. If using an optical digital cable to output audio, select [Digital Out (Optical)] and choose the output format on the next screen.

10 Confirm the settings, and then press the **X** button.

The audio output settings will be saved on the system.

Hint

You can adjust audio output settings under (Settings) (Sound Settings) [Audio Output Settings].

Getting started

Connecting digital audio devices





You can connect audio devices that support digital audio playback, such as an AV receiver for home entertainment use.

Audio output on the PS3™ system

The supported channels may vary depending on the output connector to be used.

PS3™ system output connectors	Channels that can be used for output		
	2 Ch.	5.1 Ch.	7.1 Ch.
AV MULTI OUT connector	○	-	-
DIGITAL OUT (OPTICAL) connector	○	○	-
HDMI OUT connector	○	○	○

Hints

- When connecting a digital audio device to the system, go to  (Settings) →  (Sound Settings) → [Audio Output Settings], and then adjust the settings as necessary for the audio device.
- For simultaneous audio output from multiple connectors, go to  (Settings) →  (Sound Settings) → [Audio Multi-Output], and set the option to [On].
- The system can output both audio and video through an HDMI cable. If both the TV and the audio device have HDMI connectors, you can output the TV picture to the TV through a connected audio device.
- If a device is connected to the PS3™ system via an HDMI cable, do not turn off the device while the system is turned on (power indicator is lit solid green), as doing so may cause sound distortion or produce abnormal sounds.

Examples when connecting an audio device

An HDMI cable or optical digital cable can be used to connect an audio device to the PS3™ system.

HDMI cable

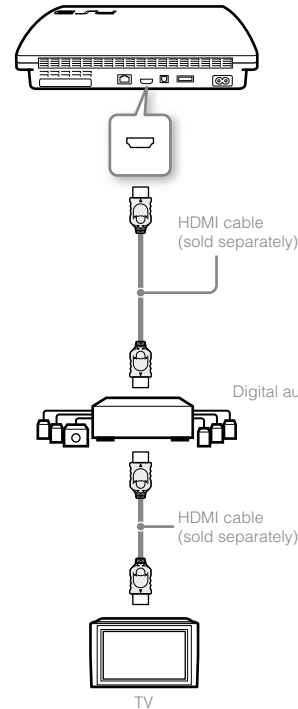

Optical digital cable

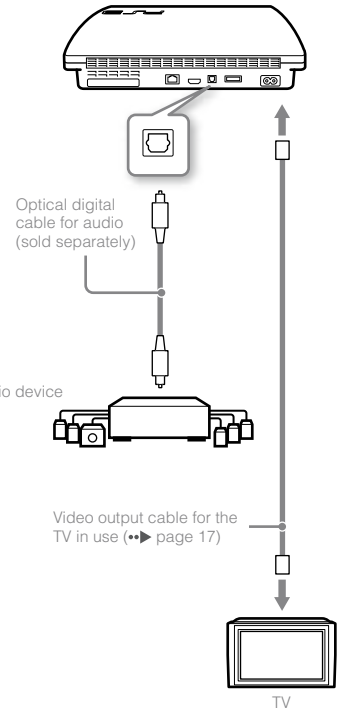

Turning the PS3™ system on and off

Turning on the system

1 Press the power button.

The power indicator lights up in solid green to indicate that the system is turned on.

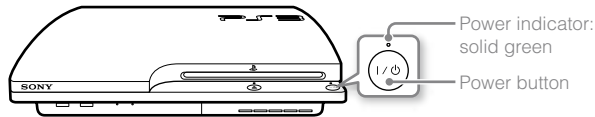

2 Press the PS button on the controller.

After the controller number is assigned, you can use the controller to operate the system.

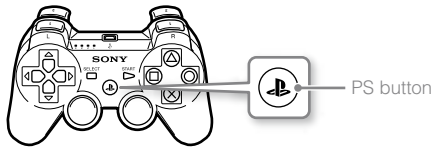

Power indicator status

You can check the power indicator on the PS3™ system to see the current status of the system.

○	Solid green	System on
◐◑	Flashing green	System turning off
●	Solid red	System off (in standby mode)

Turning off the system

1 Press the power button.

The power indicator lights up in solid red.

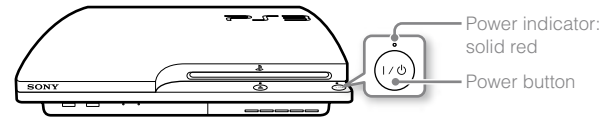



Notice

When the power indicator is lit solid green or flashing green, be sure to abide by the notices below. If you do not, data loss or corruption, or damage to the system may occur.

- Do not unplug the AC power cord from the electrical outlet.
- Do not move or change the position of the system.

Hints

- Before using a wireless controller, you must first pair it with the system (→ page 22).
- You can also turn the PS3™ system on and off using the PS button on the wireless controller. If you use the PS button to turn on the system, the controller number will be assigned at the same time. To turn off the system, press the PS button for more than one second, and then follow the on-screen instructions.
- You can also turn off the PS3™ system from the XMB™ menu. Select  (Users) →  (Turn Off System).
- If you will not be using the system for a long period of time, check that the power indicator is lit solid red, and then unplug the AC power cord from the electrical outlet.

Using the wireless controller

Preparing for use

To use a wireless controller, you must first register or "pair" the controller with the PS3™ system and assign a number to the controller.

Step 1: Pair the system and the controller.

- When using for the first time
- When using with a different PS3™ system



Step 2: Assign a controller number.

Every time the system is turned on

Step 1: Pair the system and the controller

When using the controller for the first time or when using with a different PS3™ system, you must first pair the devices. If you turn on the system and connect the controller using a USB cable, the pairing will be completed automatically.

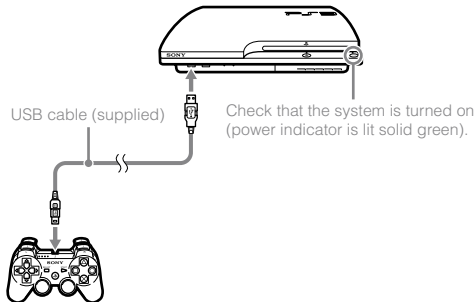

Step 2: Assign a controller number

Each time you turn on the system, a number must be assigned to the controller.

Press the PS button.

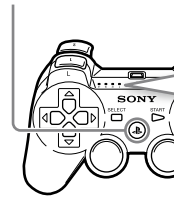

All of the port indicators flash.

1 2 3 4
= ■ □ ■ □ < ■ □ >



When the controller has been assigned a number, the port indicators for the assigned number turn solid red.

1 2 3 4
■ □ ■ □

You can connect up to 7 controllers at one time. The controller number is shown by the number above the port indicators. For numbers 5-7, add the numbers of the lit indicators.

Example: Controller number 5 has been assigned.

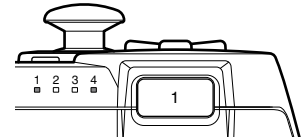

Hints

- Pairing and assigning controller numbers can only be done when the system is turned on (power indicator is lit solid green).
- When a paired controller is used with another PS3™ system, the pairing with the original system is cleared. Pair the controller with the system again if the controller has been used with another system.
- If the controller or the system is turned off, the port indicators on the controller will turn off and the assigned number will be cleared.

Using the controller wirelessly

If you disconnect the USB cable, you can use the controller wirelessly. To use it wirelessly, the controller's battery must be charged.

Hints

- The USB cable can be connected or disconnected while the controller and the system are turned on.
- If the controller does not function, press the PS button, and then reassign the controller number.

Charging the controller

With the system turned on (power indicator is lit solid green), connect the controller to the system using a USB cable. The port indicators of the controller flash slowly and charging begins. When charging has completed, the port indicators stop flashing.

Hints

- The controller can be used while charging.
- Charge in an environment where the temperature range is between 10°C - 30°C. Charging may not be as effective when performed in other environments.
- The controller cannot be charged when the system is off (in standby mode).

Battery charge level

If you press and hold down the PS button for more than one second, you can check the battery charge level on the screen.

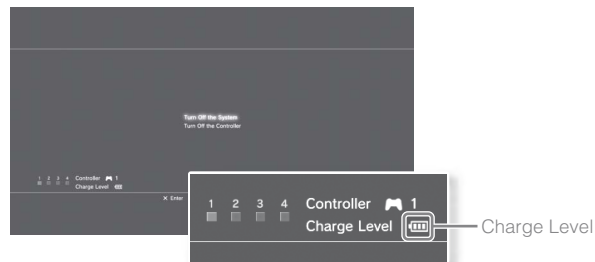

	The battery has plenty of charge.
	The battery has started losing its charge.
	The battery charge level is low.
	The battery has no charge. The port indicators on the controller flash rapidly. Charge the controller.

Hint

Depending on the environment or the conditions of use, the remaining charge level may not display correctly and the battery duration may vary.

Playing content

Blu-ray Disc (BD)/DVD/CD

1 Insert the disc.

The eject indicator turns solid blue to indicate that the disc is inserted.

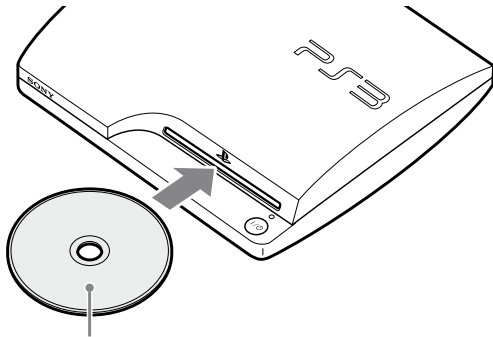

Insert the disc with the label side facing up.

Notices

- Discs that are not compatible with the system cannot be played.
- To play commercially available BD video software, in some cases the encryption key* may need to be renewed. The encryption key can be renewed when the system software is updated (•► page 33).

* AAC (Advanced Access Control System) key

2 An icon is displayed in the XMB™ menu, and playback of the disc begins.

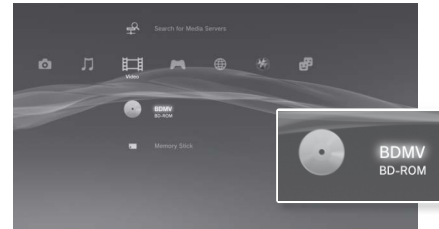

If the disc does not automatically start, select the icon for the disc from the XMB™ menu, and then press the (X) button.

Ejecting a disc

Stop playback, and then press the eject button.

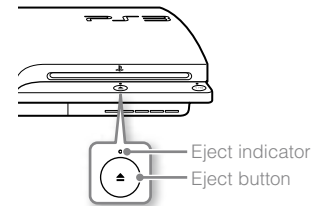

Playing content on USB devices

You can connect external devices, such as devices that are compatible with USB Mass Storage Class, using a USB cable. Devices can be connected while the system is turned on. Refer also to the instructions supplied with the device.

1 Connect the USB device.

An icon is displayed on the screen.

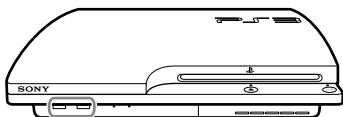

External device such as a digital camera

2 Select the icon, and then press the \otimes button.

A list of playable content is displayed.



Notices

- Do not remove USB devices or turn off the system while data is being saved, loaded or deleted. Doing so may cause data loss or corruption.
- When using a USB flash drive with a write-protect switch, do not operate the switch when the device is connected to the system. Doing so may cause data loss or corruption.

File formats that can be played or viewed

File formats that can be played or viewed on this system include ATRAC™, MP3, AAC, JPEG and MPEG-4. For the latest information, refer to the online user's guide (access from : eu.playstation.com/manuals).

Hints

- Only files that are playable or viewable on the PS3™ system are displayed in the column for the compatible category (Example: Image data is displayed under  (Photo)).
- Depending on the storage media, only a subset of the folders on the media may be displayed. If you select [Display All] from the options menu (\rightarrow page 11), all folders saved on the media will be displayed.

Notice

You should where possible make periodic back-ups of data stored on the hard disk drive as a precaution against possible loss or corruption. If for any reason software or data loss or corruption occurs, it is not possible to restore or repair the software or data. Note that SCEE will not be liable for any loss or corruption of data, files or software.

Playing games

Game compatibility

PlayStation®3 format software	Can be played on this system
PlayStation® format software	Can be played, but may not always perform correctly
PlayStation®2 format software	Cannot be played on this system

Playing games

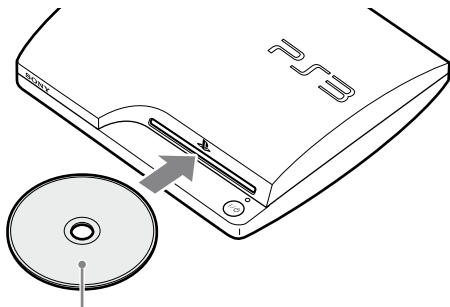

Starting a game

When you insert the disc, the game starts automatically.



Insert the disc with the label side facing up.



Quitting a game

During gameplay, press the PS button on the Wireless Controller. Then select  (Game) →  (Quit Game) to quit the game.

Hint

Depending on the type of software, such as PlayStation® format software,  (Quit Game) may not be displayed when the PS button is pressed. In this case, select [Quit Game] from the screen that is displayed.



Controller settings

You can change controller settings by selecting  (Settings) →  (Accessory Settings).



Reassign Controllers	If a controller port or number is specified by the software, you can use this setting to assign the appropriate controller port or number.*
Controller Vibration Function	You can set the vibration function to on or off. It is set to [On] by default.

* You cannot assign controller port 2-D using this system.

Hint

You can change settings for the controller during gameplay by pressing the PS button. Select  (Settings) →  (Accessory Settings) in the XMB™ screen, or select [Controller Settings] from the screen that is displayed.

Saved data for PlayStation®3 format software

Saved data for PlayStation®3 format software is saved on the system's hard disk. The data is displayed under  (Game) →  (Saved Data Utility).

Saved data for PlayStation® format software

To save data from PlayStation® format software, you must create the internal memory cards on the hard disk and assign the cards to slots.







Notice

This system does not support playback of PlayStation®2 format software. Even if you create an internal memory card for PlayStation®2 format software, you will not be able to use it to play games.





Hints

- Depending on the software, slots may be preassigned. For details, refer to the instructions supplied with the software.
- You can assign slots during gameplay. Press the PS button on the wireless controller, and then select [Assign Slots] from the screen that is displayed.

Creating internal memory cards

- 1 Select  (Game) →  (Memory Card Utility (PS/PS2)), and then press the  button.
- 2 Select + (Create New Internal Memory Card), and then press the  button.
- 3 Select [Internal Memory Card (PS)], and then press the  button.
Follow the on-screen instructions to complete the operation.

Assigning slots

- 1 Select  (Game) →  (Memory Card Utility (PS/PS2)), and then press the  button.
- 2 Select the internal memory card that you want to use, and then press the  button.
Select [Assign Slots], and then assign [Slot 1] or [Slot 2].

Adjusting network settings

Example of a network configuration (wired)

A wired network configuration requires items **1**, **2** and **3**.

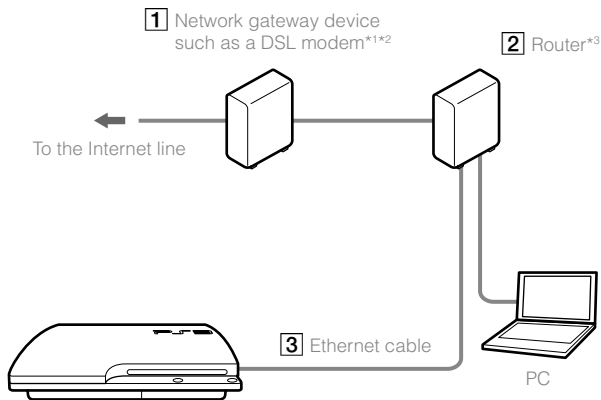

Example of a network configuration (wireless)

A wireless network configuration requires items **1** and **2**.

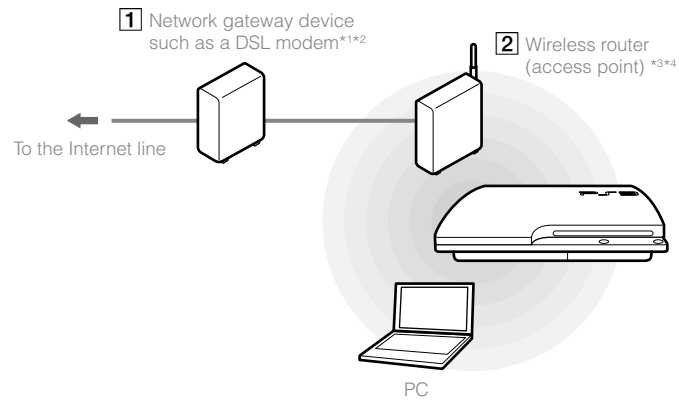



*¹ The connection method may vary depending on the environment in use. For example, you may be able to connect Ethernet cables directly into the wall outlet in housing complex units that have preinstalled LAN ports. If you are using such a network environment, you do not need a network gateway device.

*² Dial-up Internet is not recommended.

*³ A router is a device that enables multiple devices to be connected to one Internet line. A router is necessary if a PC and a PS3™ system will be connected to the Internet at the same time using one Internet connection. A router is not necessary if the DSL or cable modem or other network device has built-in router functionality.



*⁴ A wireless router is a device that adds access point functionality to a router.

Adjusting network settings (wired)

- 1 Connect an Ethernet cable (sold separately) to the system.
- 2 Select  (Settings) →  (Network Settings) → [Internet Connection Settings], and then press the  button.

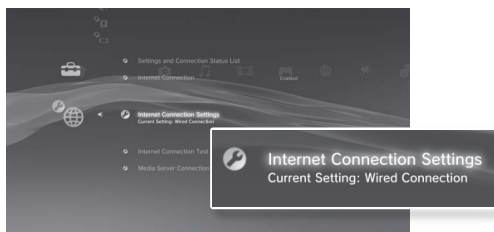

A message stating that the Internet connection will be terminated is displayed.



- 3 Select [Yes], and then press the  button.
- 4 Select [Easy], and then press the  button.
Basic settings are adjusted automatically, and a list of the settings is displayed. If the list is not displayed, you must adjust custom settings. Refer to the instructions supplied by your Internet service provider to adjust the custom settings (⇨ page 31).
- 5 Perform the Internet connection test.



If the connection is successful, you will be able to connect to the Internet.

Adjusting network settings (wireless)

- 1 Check that an Ethernet cable is not connected to the system.
- 2 Select  (Settings) →  (Network Settings) → [Internet Connection Settings], and then press the  button.

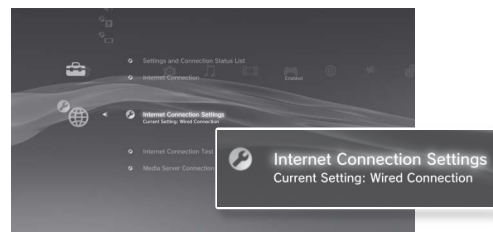
A message stating that the Internet connection will be terminated is displayed.



- 3 Select [Yes], and then press the  button.
- 4 Select [Easy], and then press the  button.
Basic settings are adjusted automatically.
- 5 Select [Wireless], and then press the  button.

Adjusting network settings

6 Adjust wireless LAN settings.

Select the access point that you want to use. You can usually select [Scan] and choose an access point within range of your system.

Scan	System scans for a nearby access point. Select the access point that you want to use.
Enter Manually	Specify the access point by entering its SSID manually.
Automatic	Use the automatic setting feature of the access point. You can follow the on-screen instructions to complete the required settings automatically.  AOSS™ A OSS Buffalo, Inc.

7 Adjust the security settings for the wireless network.

Enter the encryption key for the access point. If you selected [Automatic] in step 6, this screen will not be displayed.

None	Encryption key is not set.
WEP	Enter the encryption key. The encryption key field will display an asterisk (*) for each character you enter.
WPA-PSK/ WPA2-PSK	



8 Check the settings.

A list of the settings is displayed. If the list is not displayed, you must adjust custom settings. Refer to the instructions supplied by your Internet service provider to adjust the custom settings (⇄▶ page 31).

9 Perform the Internet connection test.

If the connection is successful, you will be able to connect to the Internet.

Hints

- SSID and WEP/WPA keys are types of security information that are required when connecting to an access point. If you do not have this information, contact the person who set up or maintains the access point.
- Depending on the access point you use, you may need the MAC address for the PS3™ system when connecting to the Internet. You can find the MAC address for the PS3™ system by going to  (Settings) ➔  (System Settings) ➔ [System Information].
- When connecting to the Internet wirelessly, signal interference may occur depending on the usage condition of the wireless network devices. If the Internet data transfer speed is decreased or the wireless controller does not function properly, try using a wired Internet connection.

Adjusting custom settings

In certain network environments, some settings may not be adjusted automatically by selecting [Easy]. Refer to the information below and also follow the on-screen instructions to adjust custom settings.

Ethernet operation mode

Specify the Ethernet data transfer rate and operation method. You can usually select [Auto-Detect].

IP Address Setting

Specify the method for obtaining an IP address when connecting to the Internet. The method varies depending on the Internet service provider you use.

Automatic	Use the IP address allocated by the DHCP server.
Manual	Enter the IP address manually.
PPPoE	Connect to the Internet using PPPoE. Enter the user name and password supplied by your Internet service provider.

DHCP host name

Specify the DHCP server host name. You can usually select [Do Not Set].

DNS Setting

Specify the DNS server. The method varies depending on the Internet service provider you use.

Automatic	System acquires the DNS server address automatically.
Manual	Enter the DNS server address manually. Enter the IP addresses of the primary and secondary DNS servers that are supplied by your Internet service provider.

MTU

Specify the MTU value used when transmitting data. You can usually select [Automatic].

Proxy Server

Specify the proxy server to be used. You can usually select [Do Not Use].

UPnP

Enable or disable UPnP (Universal Plug and Play). You can usually select [Enable].



Hint

If [UPnP] is set to [Disable], online communication may be restricted when using the voice / video chat feature or communication features in games.

Connecting to the Internet

If network settings are already completed, the PS3™ system will automatically connect to the Internet when the system is turned on. The connection will remain active as long as the system is on.

Using the Internet browser

- 1 Select  (Network) →  (Internet Browser), and then press the  button.

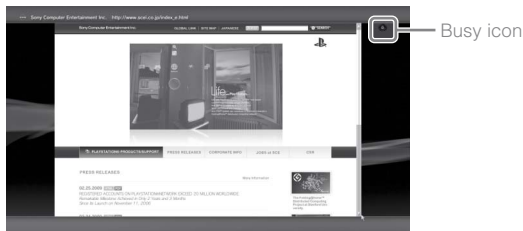

The Internet browser opens. A busy icon is displayed while the page is loading.



Basic operations of the Internet browser

Directional buttons	Move the pointer to a link.
Right stick	Scroll in the desired direction.
L1 button	Go back to the previous page.
START button	Enter an address.
 button	Switch between displaying and not displaying the menu.

Viewing the user's guide

You can use the Internet browser to view the online user's guide for the PS3™ system. Select  (Network) →  (Online Instruction Manuals), and then press the  button.

Online user's guide access from : eu.playstation.com/manuals
This guide contains detailed information about using the PS3™ system.

Creating a PlayStation®Network account

By creating a PlayStation®Network account, you can enjoy communicating with your Friends or download games or videos from  (PlayStation®Store).

Select  (PlayStation®Network) →  (Sign Up for PlayStation®Network), and then press the  button. The screen for creating an account will be displayed.



Hints

- An Internet connection is required to create an account.
- PlayStation®Network service content may vary depending on the region.

PS3™ system updates

By updating the PS3™ system software, you can add features and/or security patches. Frequently update your system to use the latest version of the system software.

System software updates <http://eu.playstation.com/ps3>

This site provides the latest information about system software updates.





Use the update data to overwrite the existing system software.

The system software is updated.

Notices

- During an update, do not turn off the system or remove media. If an update is cancelled before completion, the system software may become damaged, and the system may require servicing or exchange.
- During an update, the power button on the system and PS button of the controller are inactive.
- Depending on the content, you may not be able to play without first updating the system software.
- After you have updated the system software, you cannot go back to an earlier version.

Checking the system software version

You can check system version information by selecting  (Settings) →  (System Settings) → [System Information]. The current version is displayed in the [System Software] field.

Update methods

You can perform an update in any of the ways described below.



Network update

You can update by downloading the update data from the Internet. The latest update is automatically downloaded.

Select  (Settings) →  (System Update) → [Update via Internet].

Update using storage media

You can update using the update data saved on a USB flash drive or other media.

Select  (Settings) →  (System Update) → [Update via Storage Media].

Update using disc media

Update data may also be contained in some game discs and other types of disc media. When you play a disc that contains update data, a screen will be displayed to guide you through the update process.

Hint

If you cannot perform an update in any of the ways described above, contact your local Customer Service helpline (listed in PlayStation®3 software manuals).

Using the on-screen keyboard

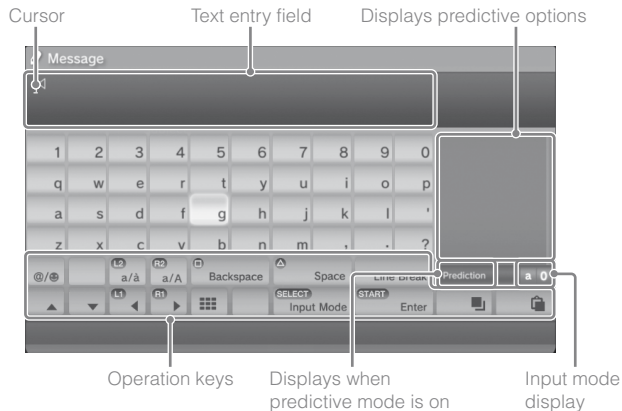

Entering text

The following steps explain how to enter text, using the word "fun" as an example.

1 Select [f] on the keyboard, and then press the ⊗ button.

Repeat this step for the characters [u] and [n].

2 Select [Enter], and then press the ⊗ button.

The characters you entered are confirmed.

3 Select [Enter], and then press the ⊗ button again.

The text is entered and the keyboard closes.

Hints

- For details about using the on-screen keyboard, refer to the online user's guide (access from : eu.playstation.com/manuals).
- You can also enter text using a USB keyboard or Bluetooth®-compatible keyboard (both sold separately). With the on-screen keyboard displayed, press any key on the connected keyboard to start entering text.

List of keys



Keys that are displayed vary depending on the input mode and other conditions.

Keys	Explanation
Line Break	Inserts a line break
▲ ▼ L1 R1	Moves the cursor
Backspace	Deletes the character to the left of the cursor
Space	Inserts a space
SELECT Input Mode	Switches the input mode
START Enter	Confirms characters that have been typed and then closes the keyboard
⌵	Switches to the mini-size keyboard
*%# / @/☺	Inserts a symbol or emoticon
L2 a/a / R2 A/A	Switches the type of characters to be entered
⌲ / ⌳	Copies or pastes text

Parental control

The PS3™ system includes a parental control feature. You can use this feature to set a password and limit the playback of content restricted by a parental control level (games, videos and other content). By setting the parental control level on the system, you can prevent the playback of restricted content by children.

Changing the security settings

You can set a parental control level for games or Blu-ray Discs or other content under  (Settings) →  (Security Settings).

A password is required to change parental control settings. You can set a password under  (Security Settings) → [Change Password]. The password is set to "0000" in the default settings.

Parental control levels for games

You can set the parental control level for games under  (Security Settings) → [Parental Control]. Select from [Off] or one of 11 levels.

Off	Play any content regardless of parental control level.
11-1	Set the parental control level based on the number. Note that the lower the number, the tighter the restriction.

The combination of the parental control levels of both the PS3™ system and the content determine whether the content can be played.

Example: If the parental control level of the system is set to [7], content with a level from [1] to [7] can be played on the system.

Refer to <http://www.ps-playsafeonline.com> for further details.

Other security settings

You can set parental control limitations on content other than games under  (Security Settings), as described below.

BD Parental Control	When playing a BD with parental control settings, restrict playback based on the age you have set. The lower the setting, the tighter the restriction.
DVD parental control	When playing a DVD with parental control settings, restrict playback based on the level you have set. Select from [Off] or one of eight levels. The lower the number, the tighter the restriction.
Internet Browser Start Control	Restrict the ability to start the Internet Browser with a password.

Hint

Security settings menu options may vary depending on the version of the system software in use. For the latest information, refer to the online user's guide (access from : eu.playstation.com/manuals).

Replacing the hard disk

You can replace the hard disk that is installed in the PS3™ system.

⚠ Caution

- Remove the hard disk in a location out of the reach of small children to help prevent accidental swallowing of small parts such as screws.
- The inside of the system is hot directly after use. Allow time for the system to cool down before starting to remove the hard disk.
- Be careful not to injure yourself when removing or handling the screw cover or the hard disk.
- Be sure to reattach the screw cover and the HDD bay cover before turning the PS3™ system on. If these covers are not attached, heat may build up inside the system.
- To attach or remove screws, use an appropriate crosshead screwdriver. If the size does not match, the groove on the screw's head may be damaged.

Notices

- Depending on the type of service performed, the hard disk that had been in use prior to servicing may need to be reformatted. Be sure to back up important data in advance.
- To help protect your personal information and prevent misuse of this information by others, be sure to clear passwords for all PlayStation®Network accounts and remove the hard disk before submitting the PS3™ system for service.



Backing up data

You can back up data that is saved on the hard disk using either of the following methods.

Notice

You should where possible make periodic back-ups of data stored on the hard disk as a precaution against possible loss or corruption. If for any reason software or data loss or corruption occurs or the hard disk must be formatted during authorised service, it may not be possible to restore or repair the software or data. Note that SCEE will not be liable for any loss or corruption of data, files or software.

Backing up data in a single operation

You can back up data that is saved on the hard disk to a USB mass storage device in a single operation. Select  (Settings) →  (System Settings) → [Backup Utility], and then follow the on-screen instructions to perform this operation.

Hints

- In some cases, you may not be able to use the backup utility feature to back up the system correctly. It is recommended that you create a spare backup for files that can be moved or copied separately. For details, refer to "Backing up selected data" (↔ page 36).
- For details on the backup utility feature, refer to the online user's guide (access from : eu.playstation.com/manuals).

Backing up selected data

The following file types saved on the system's hard disk can be copied or moved to a USB device. Select the file, press the  button, and then select [Copy] or [Move] from the options menu. For some types of video files, you may need to select [Back Up] instead.

File type	Back up destination
Saved data from games; video, music or photo files	USB mass storage device (USB flash drive, etc.)

Hints

- Some data cannot be copied, moved or backed up.
- By using a card reader/writer (USB connector type, sold separately), you can back up files saved on the hard disk to storage media such as a Memory Stick™ or an SD Memory Card.

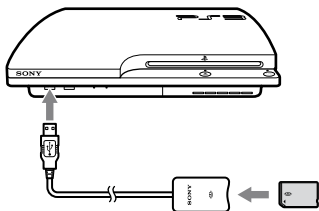
**Removing the hard disk****⚠ Caution**

- For safety reasons, be sure to turn off and unplug the system before attempting to remove the hard disk.
- The system may not be stable when placed upside down. Be careful not to injure yourself when removing the screw.

1 Press the power button to turn off the system.

The power indicator turns solid red and the system enters standby mode.

2 Unplug the AC power cord, and then disconnect the other cables from the system.

For safety reasons, remove the plug for the power cord from the electrical outlet, and then detach the other cables.

3 Place the system upside down on a soft, dry cloth, and then open the screw cover.

Use the notch located above the screw cover to slightly pull up the cover. Then rotate the cover as shown in the diagram. If the cover is hard to pull up, insert a tool such as a flathead screwdriver in the notch and gently pull the cover up.

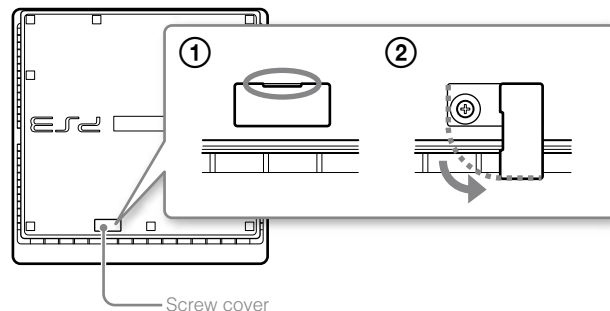
**4 Remove the screw that fastens the hard disk in place, and then remove the HDD bay cover.**

- ① Remove the blue screw with an appropriate crosshead screwdriver.
- ② Slide the HDD bay cover to the left, and then remove the cover.

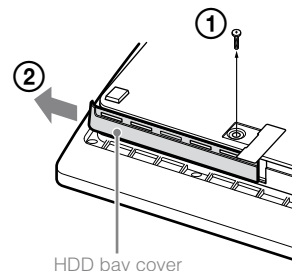

Replacing the hard disk

5 Remove the hard disk.

Pull the handle upwards, and then pull out the hard disk from the system.

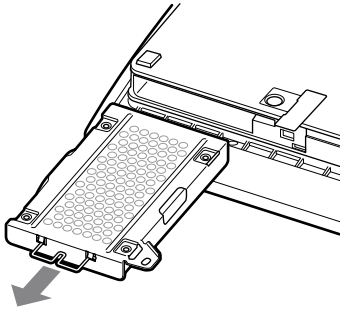

Notices

The hard disk is a sensitive piece of equipment and should be handled with care at all times. To help prevent software or data loss or corruption, or damage to the hard disk, carefully follow the precautions listed below:

- Do not throw or drop the system or hard disk, or otherwise expose either device to strong vibrations or strong physical impact.
- Do not allow liquid or small particles to get into the system or hard disk.
- Do not touch the connectors or insert foreign objects into the connectors.
- Do not place the system or hard disk close to magnetic fields such as those produced by magnets or loudspeakers. Also, do not place devices that may be sensitive to magnetic forces (such as a wrist watch or a credit card) near the hard disk.
- Do not put heavy objects on the hard disk.
- When handling the hard disk, hold it only by the edges or metal frame.
- The hard disk is sensitive to static electricity. Ensure that proper handling methods are used when installing the hard disk.
- Store in a cool, dry location.

Replacing the hard disk

⚠ Caution

For safety reasons, be sure to turn off and unplug the system before attempting to replace the hard disk.

When replacing the hard disk, follow the procedure below to remove the metal frame.

1 Using a crosshead screwdriver, remove the screws (4 places).

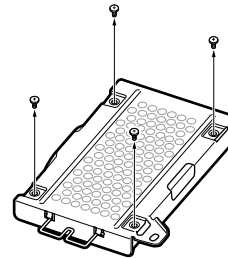

2 Hold the hard disk by the edges, and then turn it over.

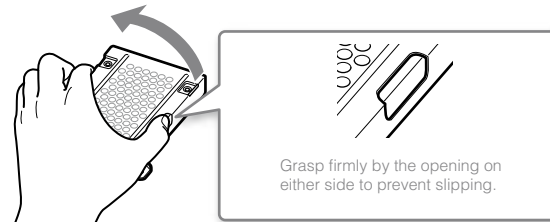

3 Remove the hard disk from the metal frame.

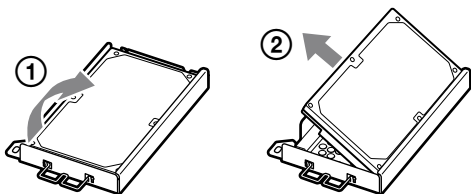

4 Place the replacement hard disk on the metal frame for the PS3™ system's hard disk, and then attach using the screws (4 places).

Do not overtighten the screws.

5 Install the hard disk in the system.

Refer to the instructions in "Removing the hard disk" (➡ page 37) and follow the steps in reverse order when installing. Be sure to fully insert the hard disk in the HDD bay.

6 Reinstall the system software.

After the hard disk has been replaced, the system software must be reinstalled (➡ page 39).

Hint

If you lose the HDD bay cover, screw cover, screws or the metal frame, contact your local Customer Service helpline (see manual back cover) for availability of replacement parts.

Reinstalling the system software

If the system software does not start when the system is turned on (such as when the hard disk has been replaced), a screen such as the one shown below is displayed. In this case, you must reinstall the system software using downloaded update data.

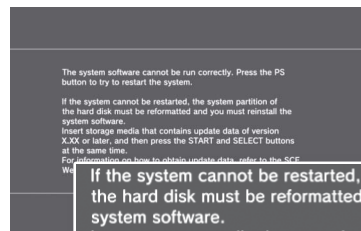

If the system cannot be restarted, the system partition of the hard disk must be reformatted and you must reinstall the system software. Insert storage media that contains update data of version X.XX or later, and then press the START and SELECT buttons at the same time.

Replacement hard disks

You can use hard disks of the following types with the PS3™ system.

Size	2.5 inch (internal type) *1
Interface format	Serial ATA *2

*1 Proper operation is not guaranteed for all models.

*2 Parallel ATA is not supported.

Downloading system software update data

Using a PC with Internet access, download the system software update data from the website shown below. Follow the instructions available on the website to copy the update data from the PC to storage media.

<http://eu.playstation.com/ps3>

Replacing the hard disk

Hints

- Use the latest version of the update data available on the website. You cannot reinstall the system software using a version that is earlier than the system software version that had previously been used. If the appropriate update data for your system is not available at the website, contact your local Customer Service helpline (see manual back cover).
- If you have a game disc or other disc that contains update data, you may be able to use that disc to reinstall the system software. If you insert the disc in the PS3™ system and follow the on-screen instructions, you can verify whether the update data can be used.
- If you do not have Internet access from a PC, contact your local Customer Service helpline (see manual back cover).

Installing the system software

Turn on the PS3™ system, and then insert the storage media containing the update data. Follow the on-screen instructions to reinstall the system software.



Notices

- Do not turn off the system or remove the storage media during the installation. If the installation is cancelled before completion, the system software may become damaged, and the system may require servicing or exchange.
- During the installation, the power button on the system and the PS button on the wireless controller are not active.

Restoring data that has been backed up

You can restore data that you backed up using either of the following methods.

Restoring data in a single operation

You can restore data that you backed up in a single operation by selecting  (Settings) ➔  (System Settings) ➔ [Backup Utility]. Connect the USB mass storage device that contains the backup data, and then follow the on-screen instructions to perform this operation.

Hints

- In some cases, you may not be able to use the backup utility feature to restore data correctly.
- For details on the backup utility feature, refer to the online user's guide (access from : eu.playstation.com/manuals).

Restoring selected data

You can manually restore files using the options menu for the file. Connect the USB mass storage device that contains the file, select the file that you want to restore, and then press the  button. Select [Copy] or [Move] from the options menu.

Hint



Some data cannot be copied, moved or backed up.

Restoring the PS3™ system

Notices



- If you restore the default settings or restore the PS3™ system, changes to the settings cannot be undone. Data loss or corruption is the responsibility of the user.
- Do not turn off the PS3™ system during this operation. If the operation is cancelled before completion, the system software may become damaged, and the system may require servicing or exchange.
- During this operation, the power button on the system and the PS button on the wireless controller are not active.
- You cannot use this feature to go back to an earlier version of the system software.

Restoring default settings

You can restore from the current settings under  (Settings) to the default settings by selecting  (Settings) →  (System Settings) → [Restore Default Settings].

After you complete the operation and restart the system, the initial setup screen will be displayed. Follow the on-screen instructions to perform initial setup of the system software (↔▶ page 15).

Deleting data on the hard disk drive

You can delete all data on the system's hard disk and restore from the current setting under  (Settings) to the default settings by selecting  (Settings) →  (System Settings) → [Restore PS3™ System].

You can shorten the time required to perform this operation by selecting [Quick Format] from the list of hard disk format options. It is recommended that you select [Full Format] when formatting a hard disk that contains important or sensitive data.

After you complete the operation and restart the system, the initial setup screen will be displayed. Follow the on-screen instructions to perform initial setup of the system software (↔▶ page 15).

Before disposing of or transferring the PS3™ system

Before disposing of your PS3™ system or giving your PS3™ system to a third party for any reason, including return (where permitted), be sure to follow the instructions in "Deleting data on the hard disk drive" and select [Full Format] to delete all the data on your PS3™ system. This will help prevent unauthorised access to or use of your credit card or other personal details.

Notice

SCEE shall not be liable for any direct and indirect, consequential, or special damages, including any damages that may arise from unauthorised access to or use of the data.

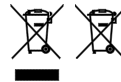

Where you see either symbol on any of our electrical products, batteries or packaging, it indicates that the relevant electrical product or battery should not be disposed of as general household waste in Europe. To ensure the correct waste treatment of the product and battery, please dispose of them in accordance with any applicable local laws or requirements for disposal of electrical equipment/batteries. In so doing, you will help to conserve natural resources and improve standards of environmental protection in treatment and disposal of electrical waste.

This symbol may be used on batteries in combination with additional chemical symbols. The chemical symbols for mercury (Hg) or lead (Pb) will appear if the battery contains more than 0.0005% mercury or more than 0.004% lead.

Restoring the PS3™ system

This product contains a battery which is permanently built-in for safety, performance or data integrity reasons. The battery should not need to be replaced during the lifetime of the product and should only be removed by skilled service personnel. To ensure the correct waste treatment of the battery, please dispose of this product as electrical waste.

Before requesting service

Go through this section if you experience difficulty in operating the PS3™ system. Should any problem persist, contact the appropriate PlayStation® customer service helpline which can be found within every PlayStation®3 software manual.

Power

The system does not turn on.

- ➔ Check that the AC power cord is securely inserted in the system and the electrical outlet.

Picture



There is no picture on the TV screen.

- ➔ Check that the cable is securely inserted. Try disconnecting the cable from the PS3™ system or TV and then reconnecting it.
- ➔ There may be a problem with the AV cable in use. Try using another cable that is compatible with the PS3™ system.
- ➔ Adjust the video input on the TV to match the input connector that is being used to connect to the PS3™ system.
- ➔ If the video output settings on the system do not match those of the cable or TV in use, there may be no picture. If the screen goes blank, turn off the system. Then, with only the system and the TV connected, press the system's power button for more than 5 seconds to turn the system back on. The video output settings will automatically be reset to the standard definition (SD) resolution.

The picture is distorted.

- ➔ Check that the cable is securely inserted. Try disconnecting the cable from the PS3™ system or TV and then reconnecting it.

The Blu-ray Disc (BD) or DVD cannot be played, or the picture is distorted.



- ➔ When outputting DVD content or PlayStation®3 format software in standard definition (SD) resolution, only discs recorded in the PAL standard can be played.
- ➔ If the system is connected to a VCR, copy protection encoding on some BDs and DVDs may cause image distortion, or may cause the image to become lighter or darker. In such cases, connect the system to the TV directly. You may also see a similar occurrence if using a combination TV/VCR unit.
- ➔ If the BD or DVD does not match the region code set in the system, it cannot be played. For details, see "Region codes" (↔ page 49).
- ➔ Some DVDs are preset with parental control restrictions. Enter the password that was set in  (Security Settings) to temporarily increase the parental control level.
- ➔ If you record video content on DVD-R, DVD-RW, DVD+R or DVD+RW media using a device such as a DVD recorder, you must finalise the media before playing it on the PS3™ system. Finalise the media using the recording device.
- ➔ Some BDs are preset with parental control restrictions. Enter the password that was set in  (Security Settings) to change the parental control level.
- ➔ The BD may be disc-locked. Enter the password that was set when the disc was created.
- ➔ See also the notices under "Playable discs" (↔ page 49).

Certain BDs cannot be played.

- ➔ To play commercially available BD video software, in some cases the encryption key for AACs (Advanced Access Control System) may need to be renewed. The encryption key can be renewed when the system software is updated.

Before requesting service

The size of the video image and the TV screen do not match.



- ➔ The settings of the connected TV and the video output settings of the system may not match. Check the following items:
 - Check that the system's settings under  (Settings) ➔  (Display Settings) ➔ [Video Output Settings] are correct.
 - Check that the settings of the connected TV are correct. For details, refer to the instructions supplied with your TV.
- ➔ With some video content, the screen size cannot be changed.

The screen colour does not seem right.

- ➔ If set to the default setting, the background colour changes as the time, day and month changes.

Audio

There is no sound.

- ➔ Check that the muting function on the TV or speakers is turned off. Also check that the volume is at the appropriate level.
- ➔ If an audio device is connected, check the settings of the device. For details, refer to the instructions supplied with the audio device.
- ➔ There may be a problem with the AV cable. Try using another cable that is compatible with the PS3™ system.
- ➔ Some software do not support digital audio output.
- ➔ If the system's audio output settings do not match the cable or device in use, the system may not produce sound. Check that the system's settings under  (Settings) ➔  (Sound Settings) ➔ [Audio Output Settings] are correct.
- ➔ Some content that support Dolby Digital, DTS, and other formats may not produce audio from all channels.

Music files do not play.





- ➔ Playback methods may be limited for some music files that are distributed via the Internet. In such cases, it may not be possible to play the content on the PS3™ system.

Network



A connection to the network cannot be established.

- ➔ If using a wired connection, check that the Ethernet cable is securely connected.
- ➔ Check that the network settings are correct. Refer to the instructions supplied by your Internet service provider or in the software manual to make the correct network settings.

The message [An error occurred during communication with the server. This is a DNS error. (80710102)] is displayed during the Internet connection test.

- ➔ If you connect the system to a modem that does not have a router feature (bridge modem), you may need to set PPPoE settings. Select  (Settings) ➔  (Network Settings) ➔ [Internet Connection Settings] ➔ [Custom] to start configuring the Internet connection. Continue adjusting settings until you see the IP address setting screen. Select [PPPoE], and then enter the user name and password provided by your Internet service provider.
- ➔ If you connect your system to a router, complete initial settings on the router first. After completing the settings on the router, try to adjust the network settings again by selecting  (Settings) ➔  (Network Settings) ➔ [Internet Connection Settings] ➔ [Easy] again. For details about the router settings, refer to the instructions supplied with your router.

The message [The attempt to obtain an IP address timed out.] is displayed during the Internet connection test.

- ➔ If you disconnected the Ethernet cable that is used to connect to a device such as a PC, and then reconnected it to the system, you must restart both your system and the modem. After restarting both devices, update your network settings by selecting  (Settings) ➔  (Network Settings) ➔ [Internet Connection Settings] ➔ [Easy]. For details about restarting your modem, refer to the instructions supplied with your modem.
- ➔ If you are using a wireless connection, the WEP key may be wrong. Check that you have the correct WEP key, and then enter it again.

The message [The PPPoE user name or password is not correct.] is displayed during the Internet connection test.

- ➔ Enter the correct user name and password for PPPoE. If you do not know the user name and password, contact your Internet service provider.

The Web page does not display properly.

- ➔ Certain content, such as content that requires specialized software, may not display properly on some Web pages.

Disc Media and USB Devices

The system does not recognise the disc.

- ➔ Remove the disc and reinsert it.
- ➔ If the disc has a label, insert it with the label side up.
- ➔ Check whether the disc is scratched or dirty. If dirty, wipe it gently with a soft cloth.
- ➔ See also the notices under "Playable discs" (➔ page 49).

The disc cannot be removed.

- ➔ Press the eject button for 10 seconds or longer to force the disc to eject. After removing and before reinserting a disc into the system, turn off the system, and then turn on the system again to resume use.

The system does not recognise the USB device, or the USB device does not operate properly.

- ➔ Check that the device is inserted correctly.
- ➔ The connected device may not be usable with the system.
- ➔ Try using a different USB connector on the PS3™ system. The device may not be recognised depending on the combination of USB connectors in use.
- ➔ In some cases, the system may not recognise the device if an external USB hub is used and more than the allotted number of devices are connected. Try removing unused devices.

When connecting a USB device, the message [An unknown USB device has been connected.] is displayed.

- ➔ The connected device may not be compatible with the system or software application.
- ➔ The device may be compatible with specific software only. Use software that is compatible with the device.
- ➔ There may be too many USB hubs connected. Try removing a USB hub.

Wireless controller

The wireless controller does not function.



- ➔ When using the wireless controller, you must pair it with the system and assign a controller number. With the system turned on (power indicator is lit solid green), connect the system and the controller using the USB cable, and then press the PS button on the controller.
- ➔ The controller number may have been cleared. Press the PS button on the controller to reassign the number.
- ➔ With some software, you may need to use a specified controller number. Refer to the manual for the software in use.
- ➔ Check the charge level of the wireless controller battery. When the controller is used in wireless mode, it will not function if the battery does not have any charge left. Charge the battery by connecting the controller to the system with the USB cable.
- ➔ If you cannot use the controller even after checking the items above, try resetting the wireless controller by pushing the reset button on the controller rear with a thin-tipped object such as a pen.



The wireless controller operates in an abnormal manner.

- ➔ Try resetting the wireless controller by pushing the reset button on the controller rear with a thin-tipped object such as a pen.

The wireless controller does not vibrate.

- ➔ Select  (Settings) ➔  (Accessory Settings) ➔ [Controller Vibration Function], and then try setting [Vibration Function] to [On].

- ➔ The software may not support the vibration function. Refer to the instruction manual for the software. For software downloaded from  (PlayStation®Store), refer to the compatibility notice information included in the software's online description.

The response to button operations is slow.

- ➔ The response speed may be slow on an LCD display or PC display. This is not a malfunction.

The battery does not charge or does not fully recharge.

- ➔ The battery can only be charged when the system is turned on (power indicator is lit solid green).
- ➔ See "Wireless controller battery" (➔ page 51).

The battery charge does not last long.

- ➔ The battery may be wearing out. Battery duration will gradually decrease with repeated usage and age. See "Wireless controller battery" (➔ page 51).

Even when the wireless controller is not being used, it loses its charge over time.

- ➔ The controller's battery slowly loses its charge even when the controller is not in use. It is recommended that you charge the controller frequently.



Other issues

The system makes noise.

- ➔ When using the system in a location where heat can build up, such as in an enclosed AV cabinet, on carpet or a cushion, or near a wall (within 10cm of the wall), the internal fan will rotate rapidly to reduce the system's temperature and this may generate increased noise. Move the system to a location with good ventilation.

- ➔ Depending on how a disc is being used, such as when copying an audio CD to the hard disk or starting software from a disc, disc noise may be louder than normal. Furthermore, some software may cause more disc noise than others.



You forgot your password for security settings.

- ➔ If you restore the system using  (Settings) ➔  (System Settings) ➔ [Restore Default Settings], your password will return to "0000". However, note that all settings other than the password will also be reset. Once these settings are reset, they cannot be recovered.

The system is warm.

- ➔ When the system is being used or is turned on, it may become warm. This is not a malfunction.

The screen freezes during gameplay.

- ➔ Check whether the disc is scratched or dirty. If dirty, wipe it gently with a soft cloth.
- ➔ If you have game data for PlayStation®3 format software installed, try deleting the game data and reinstalling the software. Select  (Game) ➔  (Game Data Utility), press the  button, and then delete the game data from the options menu. Next, reinstall the PlayStation®3 format software. Be careful not to delete the saved data for the game.

The screen is frozen. The system does not operate.

- ➔ Disconnect all accessories such as USB devices from the system, and then restart the system. Pressing the power button for 15 seconds or longer will force the system to turn off (enter standby mode). After the system turns off, turn it on again.

The power indicator is flashing red and green alternately.

- ➔ The interior of the system has become hot. Check whether the system is being used in a hot location or whether the vents are blocked. Continuing to use the system in the above condition will cause it to stop functioning. Turn the system off and leave it unused until it cools down. After the system cools down, turn it on again.

The power indicator is flashing red and the system does not operate.

- ➔ The temperature inside the system may be too high. Check whether the system is being used in a hot location or whether the vents are blocked. Press the power button to stop the flashing, and then leave the system turned off until it cools down. After it cools down, turn on the system again.

The system does not recognise content.

- ➔ The content may be of a format that is not supported by the system. Content of types not supported by the system will not be recognised. For information on supported formats, refer to the online user's guide (access from : eu.playstation.com/manuals).

Specifications

Design and specifications are subject to change without notice. Information about system functionality and images published in this document may vary from those for your PS3™ system, depending on the system software version in use.

PlayStation®3 system

CPU		Cell Broadband Engine™
GPU		RSX™
Audio output		LPCM 7.1ch, Dolby Digital, Dolby Digital Plus, Dolby TrueHD, DTS, DTS-HD, AAC
Memory		256 MB XDR Main RAM, 256 MB GDDR3 VRAM
Hard disk	2.5" Serial ATA	120 GB*1 (CECH-2102A / CECH-2103A) 250 GB*1 (CECH-2102B / CECH-2103B)
Inputs/ outputs*2	Hi-Speed USB (USB 2.0)	2
Networking		Ethernet (10BASE-T, 100BASE-TX, 1000BASE-T) × 1
		IEEE 802.11 b/g
		Bluetooth® 2.0 (EDR)
Controller		Wireless Controller (Bluetooth®)
AV output	Resolution	1080p, 1080i, 720p, 576p, 576i
	HDMI OUT connector*3	1
	AV MULTI OUT connector	1
	Digital out (optical) connector	1
BD/DVD/ CD drive (read only)	Maximum read rate	BD × 2 (BD-ROM) DVD × 8 (DVD-ROM) CD × 24 (CD-ROM)

Laser	Type: Semiconductor, continuous BD Wavelength: 400 - 410 nm Power: Max. 17.5 mW DVD Wavelength: 655 - 664 nm Power: Max. 2.6 mW CD Wavelength: 770 - 800 nm Power: Max. 4.0 mW
Power	AC 220 - 240 V, 50 / 60 Hz
Power consumption	Approx. 250 W
External dimensions (excluding maximum projecting part)	Approx. 290 × 65 × 290 mm (width × height × length)
Mass	Approx. 3.0 kg
Operating temperature	5°C - 35°C

*1 Hard disk capacity calculated using base 10 mathematics (1 GB = 1,000,000,000 bytes). The system software for this PS3™ system calculates capacity using binary mathematics (1 GB = 1,073,741,824 bytes) and subsequently displays lower capacity and free space. The difference in displayed values does not indicate a difference in the actual number of bytes.

*2 Usability of all connected devices is not guaranteed.

*3 "Deep Colour", "x.v.Colour" and "HD lossless audio format" are supported.

DUALSHOCK®3 Wireless Controller

Battery type	Built-in rechargeable Lithium-Ion battery
Voltage	DC 3.7 V
Battery capacity	610 mAh
Mass	Approx. 180 g

BRAVIA™ Sync



"BRAVIA™ Sync" is a Sony product feature that allows you to use the remote controls of BRAVIA™ televisions (Sony Corporation products) to operate various devices that are connected to each other through HDMI cables. BRAVIA™ Sync uses the control signals that are transferred through the HDMI connections.

To enable the BRAVIA™ Sync feature, go to (Settings) ➔ (System Settings) ➔ [Control for HDMI], and set the option to [On]. For details, refer to the online user's guide (access from : eu.playstation.com/manuals) and the instructions supplied with the BRAVIA™ products in use.

Hint

This feature can only be used on devices that support the BRAVIA™ Sync feature. Compatibility with all devices that comply with the HDMI CEC specification is not guaranteed.

Playable discs

Blu-ray Disc (BD)	PlayStation®3 format BD-ROM
	BD-ROM
	BD-R
	BD-RE* ¹
DVD	DVD-ROM
	DVD+R/RW
	DVD-R/RW
	AVCHD
	DSD Disc

CD	PlayStation® format CD-ROM* ^{2*3}
	CD-DA (audio CD)* ⁴
	CD-R/RW

*¹ Playback of BD-RE ver. 1.0 discs is not supported.

*² PlayStation®2 format software titles do not perform on this system.

*³ This product has limited backward compatibility with PlayStation® format software. Many PlayStation® format software titles operate, but full compatibility is not guaranteed.





*⁴ Playback of Super Audio CDs is not supported.

Region codes

Depending on the disc, a region code that is based on the geographic region where the disc is distributed may be assigned. This system can play discs marked with the following region codes.

Disc	Region code
Blu-ray Disc (BD)	
DVD	(Models sold in DVD Region 4 countries only)
	(Models sold in DVD Region 2 countries only)

Specifications

PlayStation®3 format BD-ROM	 4 (Models sold in PlayStation®3 BD Region 4 countries only)  2 (Models sold in PlayStation®3 BD Region 2 countries only)  ALL
PlayStation® format CD-ROM	 PAL

DVD and PlayStation®3 format software

- When outputting DVD content or PlayStation®3 format software in SD resolution, only discs recorded in the PAL standard will definitely be playable. You may not be able to play discs recorded for other standards (such as NTSC) on this system (unless an NTSC compatible TV is used).
- When playing PlayStation®3 format software in HD resolution, a TV that supports video playback at 59.94 Hz is required.

DVD-R/DVD-RW/DVD+R/DVD+RW discs

Discs that have not been finalised cannot be played.

Notices

- Use only circular-shaped discs with the system. Do not use irregularly-shaped discs (for example, heart- or star-shaped discs). Using irregularly-shaped discs may cause a malfunction.
- Do not use damaged, re-shaped or repaired discs. Use of such discs may cause a malfunction.
- When using an 8 cm disc, insert the disc in the system without an adaptor.

- The audio CD playback feature of this system is designed to conform to the Compact Disc (CD) standard. Some record companies have started marketing music discs encoded with copyright protection technologies. Some of these music discs do not conform to the CD standard and may not be playable on this system.
- A DualDisc is a dual-sided disc that combines a DVD side and an audio side. Note that the audio side is not guaranteed to play because this type of disc does not conform to the specifications required for an audio Compact Disc (CD).
- If a device that is not compatible with the HDCP (High-bandwidth Digital Content Protection) standard is connected to the system using an HDMI cable, video or audio cannot be output from the system.
- When you use the AV MULTI OUT connector of the system to connect to a TV, copyright-protected video from a BD or from video files may be output at resolutions lower than 1080p. Also, these types of video will be output at resolutions of 576p or lower if recorded at 1080i (50 Hz) or 720p (50 Hz).
- When playing discs with content that was copied fraudulently, abnormal sounds may be produced or the content may not play correctly.
- To continuously enjoy playback of copyright-protected BDs, in some cases the encryption key for AACS (Advanced Access Control System) may need to be renewed. To renew the encryption key, the system must be updated.
- Some discs may not be playable due to scratches, dust, the quality of recording, or the characteristics of the recording device.
- In rare instances, CDs, DVDs, BDs and other media may not operate properly when played on the PS3™ system. This is primarily due to variations in the manufacturing process or encoding of the software.

Wireless controller battery

Caution

- If you come into contact with material from a leaking battery, take the following actions:
 - If the material gets into the eyes, do not rub. Immediately flush the eyes with clean water and seek medical attention.
 - If the material comes into contact with the skin or clothes, immediately rinse the affected area with clean water. Consult your physician if inflammation or soreness develops.
- Do not allow the battery to come into contact with fire or subject it to extreme temperatures such as in direct sunlight, in a vehicle exposed to the sun or near a heat source.

Wireless controller battery life

- The battery has a limited lifespan. Battery duration will gradually decrease with repeated usage and age.
- Battery life also varies depending on the storage method, usage state, environment and other factors.

Storage

When the wireless controller is not used for an extended period of time, it is recommended that you fully charge it at least once a year in order to maintain battery functionality.

GUARANTEE

GUARANTEE FOR CONSUMERS IN AUSTRALIA & NEW ZEALAND

Thank you for buying this Product. We hope that you enjoy using it.

The term "Product" means the PlayStation®3 computer entertainment system ("the PS3™ system") and any official PlayStation®3 peripherals supplied in the box with the PS3™ system. The system software pre-installed in the PS3™ system or subsequently provided via updates or upgrade releases is licensed to you, not sold, and is for use only as part of the PS3™ system. The terms of such system software licence are at <http://www.scei.co.jp/ps3-eula>.

This Guarantee does not cover your data, any separate software or PlayStation® games whether or not packaged or included with the Product, or any PlayStation® accessories or peripheral devices that are not manufactured by or for SCEE.

This Guarantee is given to you, the first user of the Product. It is personal to you and cannot be used by anyone else.

Sony Computer Entertainment Europe Ltd ("SCEE") guarantees that this Product is free from defects in materials and workmanship that result in Product failure during normal usage in accordance with the terms set out in below and will, for a period of 1 (one) year from the date of original purchase, repair or (at SCEE's option) replace any component part of this Product, free of charge, where it is faulty due to defective materials or workmanship. Replacement will be with a new or refurbished component or unit, at SCEE's option, which is guaranteed for the remainder of the original Guarantee Period.

The benefits conferred by this Guarantee are also in addition to other rights and remedies which the consumer has in law in Australia and New Zealand in respect of this Product, including rights and remedies available under the Trade Practices Act 1974 and State and Territory legislation in Australia and the Fair trading Act 1986 in New Zealand and this Guarantee does not affect such rights and remedies in any way.

This Guarantee is given to you as first user by Sony Computer Entertainment Europe Ltd of 10 Great Marlborough Street, London, W1F 7LP, United Kingdom.

IMPORTANT

1. If you need to claim under this Guarantee, please call your local Customer Service helpline (listed in the PlayStation®3 software manuals) for return instructions.
2. Where SCEE has put this product on the market in Australia and New Zealand, this Guarantee is valid in Australia and New Zealand, provided:
 - i. the original sales receipt or invoice or other proof of purchase (indicating the date of purchase and retailer's name) is presented together with the defective Product within the Guarantee period (and has not been altered or defaced since the date of original purchase); and
 - ii. the Guarantee seal and the serial number on the Product have not been damaged, altered, defaced or removed.
3. SCEE may elect at its option to repair or replace the Product with a new or refurbished component or unit.
4. Repair or replacement will involve installation of the latest software or firmware updates for the Product.
5. When arranging for warranty service under this Guarantee, our Customer Service helpline will discuss with you whether you should leave the hard disk drive ("HDD") included in the PS3™ system on purchase inside the PS3™ system, or remove and retain the HDD prior to the return of the system for warranty service.
6. If the PS3™ system is returned with the HDD for warranty service, repair or replacement of the Product will involve reformatting of the HDD. This is the quickest form of warranty service we can offer.
7. If the PS3™ system is returned without the HDD for warranty service, we will where possible ensure the repaired or replaced unit has the same unique internal identification as the returned PS3™ system. Please note this form of warranty service will take longer than the service described in the previous paragraph. If for any reason we are unable to rewrite the original system ID and you wish to receive warranty service, you will need to reformat your HDD before you are able to use it with your repaired or replaced PS3™ system.

8. You understand and agree that reformatting of the HDD will result in loss of your stored data, files or software. To avoid loss or erasure of any software, data or files you may have stored on the hard disk and which you consider private or confidential or which you wish to retain, before submitting the Product for guarantee service you should where possible back these up and remove them. Clearing your PlayStation®Network password is helpful to protect your information.
 9. You understand that this Guarantee does not cover stored data and you agree that SCEE is not liable to you for any loss or corruption of your data, files or software resulting from repair or replacement of the Product under this Guarantee.
 10. You should back up your hard disk regularly to prevent loss or alteration of data, although some content cannot be backed up and must be reinstalled by the user.
 11. To avoid damage to or loss or erasure of removable external data storage media or peripherals or non-PS3™ components, you must remove these before submitting the Product for guarantee service.
 12. You may not claim under this Guarantee when the Product is damaged as a result of:
 - i. commercial use, accident, fair wear and tear, negligence, abuse, or misuse (including, without limitation, failure to use this Product for its normal purpose and/or in accordance with instructions on proper use and maintenance, or installation or use in a manner inconsistent with applicable local technical or safety standards);
 - ii. use in conjunction with any unauthorised peripheral (including, without limitation, game enhancement devices, hard disk drives, adaptors and power supply devices);
 - iii. any adaptation or adjustment to, or alteration of, the Product carried out for any reason, and whether properly carried out or not;
 - iv. maintenance or repair or attempted repair carried out other than by a SCEE authorised service facility;
 - v. use in conjunction with unauthorised software, virus infection, or fire, flood or other natural calamity; or
 - vi. operation or treatment of the Product inconsistent with normal personal or domestic use or operation outside the Product specifications.
 13. You may not claim under this Guarantee where you are in material breach of your system software licence (see <http://www.scei.co.jp/ps3-eula>).
 14. To the extent permitted by applicable law, this Guarantee will be your sole and exclusive remedy in relation to defects in this Product and all other guarantees, warranties, terms and conditions, express or implied by statute or otherwise, in respect of this Product are excluded and neither SCEE nor any its affiliates or suppliers, will be liable for any special, incidental, indirect or consequential loss or damage including loss of data, howsoever arising.
 15. SCEE does not warrant or guarantee any third party product or service which may be offered in connection with the Product.
- If this Product needs any repair which is not covered by this Guarantee, please call your local Customer Service helpline for advice. If your home country is not one of those listed, please contact your retailer.

GUARANTEE

GUARANTEE FOR CONSUMERS IN UK & EIRE

Thank you for buying this Product. We hope that you enjoy using it.

The term "Product" means the PlayStation®3 computer entertainment system ("the PS3™ system") and any official PlayStation®3 peripherals supplied in the box with the PS3™ system. The system software pre-installed in the PS3™ system or subsequently provided via updates or upgrade releases is licensed to you, not sold, and is for use only as part of the PS3™ system. The terms of such system software licence are at <http://www.scei.co.jp/ps3-eula>.

This Guarantee does not cover your data, any separate software or PlayStation® games whether or not packaged or included with the Product, or any PlayStation® accessories or peripheral devices that are not manufactured by or for SCEE.

This Guarantee is given to you, the first user of the Product. It is personal to you and cannot be used by anyone else.

Sony Computer Entertainment Europe Ltd ("SCEE") guarantees that this Product is free from defects in materials and workmanship that result in Product failure during normal usage in accordance with the terms set out in below and will, for a period of 1 (one) year from the date of original purchase, repair or (at SCEE's option) replace any component part of this Product, free of charge, where it is faulty due to defective materials or workmanship. Replacement will be with a new or refurbished component or unit, at SCEE's option, which is guaranteed for the remainder of the original Guarantee Period.

This Guarantee is in addition to your statutory consumer rights (under applicable law) and does not affect them in any way.

This Guarantee is given to you as first user by Sony Computer Entertainment Europe Ltd of 10 Great Marlborough Street, London, W1F 7LP, United Kingdom.

IMPORTANT

1. If you need to claim under this Guarantee, please call your local Customer Service helpline (listed in the PlayStation®3 software manuals) for return instructions.
2. Where SCEE has put this product on the market in the European Economic Area or Switzerland, this Guarantee is valid in all EU Member States plus Switzerland, Norway, Iceland and Liechtenstein, provided:
 - i. the original sales receipt or invoice or other proof of purchase (indicating the date of purchase and retailer's name) is presented together with the defective Product within the Guarantee period (and has not been altered or defaced since the date of original purchase); and
 - ii. the Guarantee seal and the serial number on the Product have not been damaged, altered, defaced or removed.
3. SCEE may elect at its option to repair or replace the Product with a new or refurbished component or unit.
4. Repair or replacement will involve installation of the latest software or firmware updates for the Product.
5. When arranging for warranty service under this Guarantee, our Customer Service helpline will discuss with you whether you should leave the hard disk drive ("HDD") included in the PS3™ system on purchase inside the PS3™ system, or remove and retain the HDD prior to the return of the system for warranty service.
6. If the PS3™ system is returned with the HDD for warranty service, repair or replacement of the Product will involve reformatting of the HDD. This is the quickest form of warranty service we can offer.
7. If the PS3™ system is returned without the HDD for warranty service, we will where possible ensure the repaired or replaced unit has the same unique internal identification as the returned PS3™ system. Please note this form of warranty service will take longer than the service described in the previous paragraph. If for any reason we are unable to rewrite the original system ID and you wish to receive warranty service, you will need to reformat your HDD before you are able to use it with your repaired or replaced PS3™ system.

8. You understand and agree that reformatting of the HDD will result in loss of your stored data, files or software. To avoid loss or erasure of any software, data or files you may have stored on the hard disk and which you consider private or confidential or which you wish to retain, before submitting the Product for guarantee service you should where possible back these up and remove them. Clearing your PlayStation®Network password is helpful to protect your information.
 9. You understand that this Guarantee does not cover stored data and you agree that SCEE is not liable to you for any loss or corruption of your data, files or software resulting from repair or replacement of the Product under this Guarantee.
 10. You should back up your hard disk regularly to prevent loss or alteration of data, although some content cannot be backed up and must be reinstalled by the user.
 11. To avoid damage to or loss or erasure of removable external data storage media or peripherals or non-PS3™ components, you must remove these before submitting the Product for guarantee service.
 12. You may not claim under this Guarantee when the Product is damaged as a result of:
 - i. commercial use, accident, fair wear and tear, negligence, abuse, or misuse (including, without limitation, failure to use this Product for its normal purpose and/or in accordance with instructions on proper use and maintenance, or installation or use in a manner inconsistent with applicable local technical or safety standards);
 - ii. use in conjunction with any unauthorised peripheral (including, without limitation, game enhancement devices, hard disk drives, adaptors and power supply devices);
 - iii. any adaptation or adjustment to, or alteration of, the Product carried out for any reason, and whether properly carried out or not;
 - iv. maintenance or repair or attempted repair carried out other than by a SCEE authorised service facility;
 - v. use in conjunction with unauthorised software, virus infection, or fire, flood or other natural calamity; or
 - vi. operation or treatment of the Product inconsistent with normal personal or domestic use or operation outside the Product specifications.
 13. You may not claim under this Guarantee where you are in material breach of your system software licence (see <http://www.scei.co.jp/ps3-eula>).
 14. To the extent permitted by applicable law, this Guarantee will be your sole and exclusive remedy in relation to defects in this Product and all other guarantees, warranties, terms and conditions, express or implied by statute or otherwise, in respect of this Product are excluded and neither SCEE nor any its affiliates or suppliers, will be liable for any special, incidental, indirect or consequential loss or damage including loss of data, howsoever arising.
 15. SCEE does not warrant or guarantee any third party product or service which may be offered in connection with the Product.
- If this Product needs any repair which is not covered by this Guarantee, please call your local Customer Service helpline for advice. If your home country is not one of those listed, please contact your retailer.

Copyright and trademarks

"PS", "PlayStation", "DUALSHOCK", "△○×□" and "PS" are registered trademarks of Sony Computer Entertainment Inc. "PS3" is a trademark of the same company.

"XMB" and "xross media bar" are trademarks of Sony Corporation and Sony Computer Entertainment Inc.

"SONY" and "PS" are registered trademarks of Sony Corporation. "Memory Stick", "Memory Stick Duo", "Memory Stick", "ATRAC", "BRAVIA" logo, "BRAVIA" and the "x.v.Colour" name and logo are trademarks or registered trademarks of Sony Corporation.

"AOSS™" and AOSS™ are the trademarks of BUFFALO INC.

"AVCHD" and "AVCHD" logo are trademarks of Panasonic Corporation and Sony Corporation.

AVCHD™

Contains Macromedia® Flash® Player technology by Adobe Copyright © 1995-2008 Adobe Systems Incorporated. All rights reserved. Flash, Macromedia, and Macromedia Flash are either trademarks or registered trademarks of Adobe Systems Incorporated in the United States and/or other countries.



© 2006 All Media Guide, LLC
Content and technology provided by **All Media Guide®**.

"Blu-ray Disc" and  are trademarks.



Copyright © 2004-2006 Cambridge Silicon Radio Ltd.

The Bluetooth® word mark and logos are owned by the Bluetooth SIG, Inc. and any use of such marks by Sony Computer Entertainment Inc. is under license. Other trademarks and trade names are those of their respective owners.



DivX, DivX Certified, and associated logos are trademarks of DivX, Inc. and are used under license.



DLNA and DLNA CERTIFIED are trademarks and/or service marks of Digital Living Network Alliance.



Manufactured under license under U.S. Patent #'s: 5,451,942; 5,956,674; 5,974,380; 5,978,762; 6,226,616; 6,487,535 & other U.S. and worldwide patents issued & pending.

DTS is a registered trademark and the DTS logos, Symbol, DTS-HD and DTS-HD Master Audio are trademarks of DTS, Inc.

© 1996-2008 DTS, Inc. All Rights Reserved.



Manufactured under licence from Dolby Laboratories. Dolby and the double-D symbol are trademarks of Dolby Laboratories.



U.S. and foreign patents licensed from Dolby Laboratories.

The DVD logo is a trademark.



All of the Japanese fonts and some parts of the Latin fonts in this machine use characters provided by Fontworks Japan, Inc.

HDMI, the HDMI logo and High-Definition Multimedia Interface are trademarks or registered trademarks of HDMI Licensing, LLC.



ATOK is a registered trademark of JUSTSYSTEM CORP. in Japan and other countries.



Copyright and trademarks

This product incorporates copyright protection technology that is protected by U.S. patents and other intellectual property rights. Use of this copyright protection technology must be authorized by Macrovision, and is intended for home and other limited viewing uses only unless otherwise authorized by Macrovision. Reverse engineering or disassembly is prohibited.

Anti-Grain Geometry - Version 2.0

Copyright © 2002-2004 Maxim Shemanarev (McSeem)

Permission to copy, use, modify, sell and distribute this software is granted provided this copyright notice appears in all copies.

This software is provided "as is" without express or implied warranty, and with no claim as to its suitability for any purpose.

This product includes RSA BSAFE® Cryptographic software from RSA Security Inc.

RSA, BSAFE are either registered trademarks or trademarks of RSA Security Inc. in the United States and/or other countries.

RSA Security Inc. All rights reserved.



This product adopts S3TC texture compression technology under licence from S3 Graphics, Co., Ltd.

Java and all Java based trademarks and logos are trademarks or registered trademarks of Sun Microsystems, Inc. in the U.S. and other countries.



@(#)fdlibm.h 1.5 95/01/18

Copyright © 1993 by Sun Microsystems, Inc. All rights reserved

Developed at SunSoft, a Sun Microsystems, Inc. business.

Permission to use, copy, modify, and distribute this software is freely granted, provided that this notice is preserved.

MPEG Layer-3 audio coding technology and patents licenced from Fraunhofer IIS and Thomson.

Mp3Surround audio coding technology and patents licensed from Fraunhofer IIS, Thomson, and Agere.

The USB-IF Logos are trademarks of Universal Serial Bus Implementers Forum, Inc.



eZiText® and Zi® are registered trademarks of Zi Corporation.



Portions of this software are copyright © 1996-2008 The FreeType Project (www.freetype.org). All rights reserved.

This software is based in part on the work of the Independent JPEG Group.



Visit <http://www.scei.co.jp/ps3-license/index.html> for other licensees and trademarks.

All other trademarks are the property of their respective owners.

Online user's guide

access from : eu.playstation.com/manuals

This guide contains detailed information about using the PS3™ system.

System software updates

<http://eu.playstation.com/ps3>

This site provides the latest information about system software updates.

PlayStation®3 official site

<http://eu.playstation.com/ps3>

The official site for PlayStation®3 products provides the latest information about software titles and hardware accessories.

Support

<http://eu.playstation.com/help-support>

The official site for PlayStation® product support provides the latest questions and answers about your product.



Free Manuals Download Website

<http://myh66.com>

<http://usermanuals.us>

<http://www.somanuals.com>

<http://www.4manuals.cc>

<http://www.manual-lib.com>

<http://www.404manual.com>

<http://www.luxmanual.com>

<http://aubethermostatmanual.com>

Golf course search by state

<http://golfingnear.com>

Email search by domain

<http://emailbydomain.com>

Auto manuals search

<http://auto.somanuals.com>

TV manuals search

<http://tv.somanuals.com>