

SONY®



EN

CT

User's Guide

用戶指南

SCPH-90006

SCPH-90007

NTSC J



Before using this product, carefully read this manual and the Quick Reference manual included in the package with the console, and retain them for future reference.

使用本機以前，請先詳細閱讀本說明書以及外裝箱中主機所隨附的快捷參考，並妥善保存，以備將來參考之用。

About the PlayStation®2 console documentation

The PlayStation®2 console documentation includes the following:

- **Quick Reference**

A manual that is included in the package with the console. It contains information on setting up and performing basic operations on the console, as well as safety and troubleshooting information.

- **User's Guide (this document)**

This document (in PDF format) is accessed from a PC through the Internet and contains information on performing advanced operations on the console, technical specifications and other information. You can download this document from the support page on the Sony Computer Entertainment Web site (<http://asia.playstation.com/support/>).

Table of contents

Preparation

Getting started	3
Part names	4
Connecting to a TV	5
Connecting digital audio equipment	6
Connecting the controller.....	7
Connecting the AC power cord.....	7
Turning the console on and off	8

Games

Playing a game	10
Using memory cards	13

Audio CDs

Playing an audio CD	15
---------------------------	----

DVDs

Watching a DVD	17
Using the playback modes.....	21
Adjusting DVD player settings	23

Main menu

Displaying the main menu.....	30
Using the Browser screen	30
Using the System Configuration menu	31
Using the Version Information screen.....	34

Networking

Connecting to a network.....	37
Creating network settings	39

Additional information

Specifications	40
----------------------	----

Getting started

Removing the 3-pin converting adaptor (SCPH-90006 only)

Electrical outlet configuration may vary depending on the region of use. If the plug on the supplied AC power cord does not match the electrical outlet, loosen the screw and remove the converting adaptor.

3-pin converting adaptor



Positioning the console

You can place the console in either the horizontal or vertical position.

Horizontal position

Set the console horizontally.



Vertical position

When setting the console in the vertical position, use the SCPH-90110 vertical stand (for PlayStation®2) (sold separately).

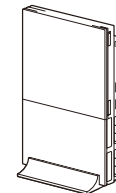

Hint

Some vertical stands (for PlayStation®2) cannot be used with this model of the PlayStation®2 console. For details, see the Quick Reference (→ page 2). Choose the SCPH-90110 when purchasing a vertical stand.

! Caution

Do not place the console in locations where it may be exposed to the following conditions:

- Places subject to excessive cigarette smoke or dust. Cigarette smoke residue or dust build-up on the internal components, such as the lens, may cause the console to malfunction.
- Places subject to extreme temperatures, in direct sunlight, near a heat source, or in a car with its windows closed (particularly in summer). These conditions may warp the exterior of the console or cause the console to malfunction.
- Places close to magnetic fields, such as those produced by magnets or loudspeakers.
- Places subject to vibration.

Part names

PlayStation®2 console front

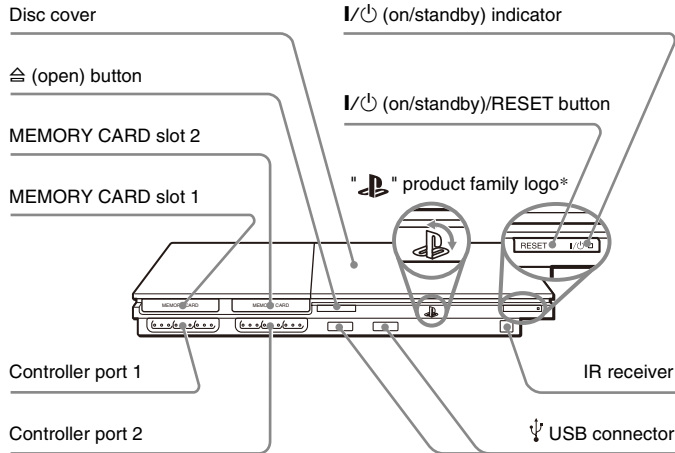

* The "PS" product family logo can be rotated to match the horizontal or vertical positioning of the console.

Hint

You can connect USB devices that are compatible with the PlayStation®2 console. Note, however, that not all USB-compatible products work with the PlayStation®2 console. Refer to the instructions supplied with the device to be connected for more information.

PlayStation®2 console rear

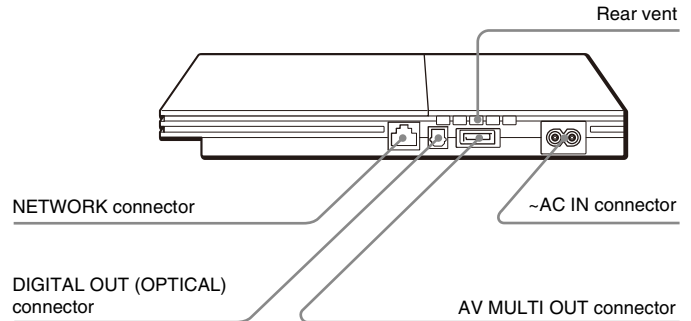

Hint

For part names of the analog controller (DUALSHOCK®2), see "Using the analog controller (DUALSHOCK®2)" (⇨ page 12).

Connecting to a TV

Before connecting

- Do not plug the AC power cord for the console into an electrical outlet until you have made all other connections.
- Check that the TV is turned off.

Connecting to a TV using the supplied AV cable

Connect the console to the TV as shown below.

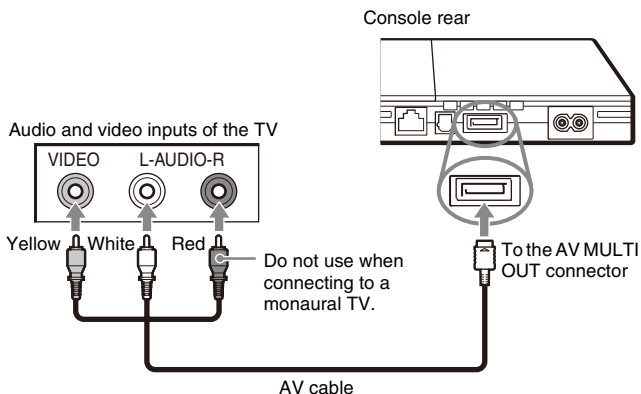

! Caution

If you display a still image on a plasma or projection* TV screen for an extended period of time, "ghosting" may occur. This is a characteristic of these types of TVs. Static, non-moving images, such as console setting menus, DVD menus or paused images, may leave a faint image permanently on the TV screen if left on for an extended time. Refer to the instructions supplied with your TV for details.

* Except those of LCD screen types

Hint

The console can be connected to a VCR or an integrated TV/VCR. Note, however, that if you play a DVD with copy-protection encryption, picture quality may be reduced.

When using cables sold separately

Picture quality differs depending on the type of cable used. Use the information below to determine the best connection method.

If you use a cable sold separately, refer to the instructions supplied with the cable.

TV	Cable type
A TV with S VIDEO inputs	S VIDEO cable (SCPH-10480)
A TV with component video input connectors	Component AV cable (SCPH-10490)

Picture quality scale

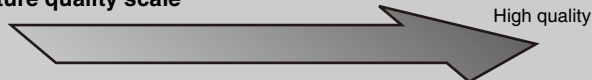

■ AV cable (supplied) ■ S VIDEO cable ■ Component AV cable

This scale is intended only as a reference. Depending on the product or condition of your TV, the picture quality may be different.

Hints

- To use progressive scan, you must have a TV that supports progressive scan (480p) and you must connect using the appropriate type of cable*. You must also check that the console settings are correct. For details, see "Progressive" in "Setting TV display options" (⇨ page 24).
 - * The component AV cable (sold separately) is compatible with progressive scan.
- You cannot connect the console to a TV with component video inputs that are exclusively for HDTV use (Y PB PR). Refer to the instructions supplied with your TV for details.

Connecting digital audio equipment

By using a commercially available optical digital cable, you can enjoy surround sound with the effect of being in a movie theater or a concert hall. When connecting the console to audio equipment with digital connectors, refer to the instructions supplied with the device to be connected.

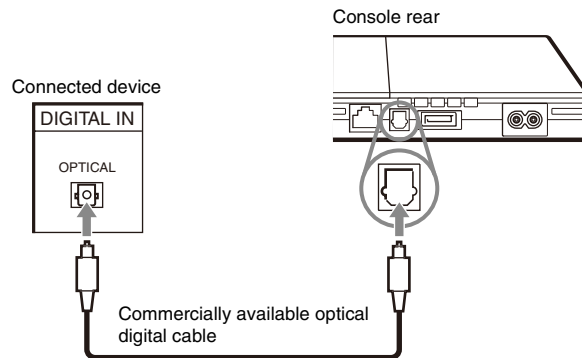

Hints

- If you connect the console to audio equipment using an optical digital cable, it may affect the audio output of some PlayStation®2 format software with the result that no sound is produced. If this happens, use a cable such as the supplied AV cable and connect it to the console's AV MULTI OUT connector. Do not use an optical digital cable.
- After connecting digital audio equipment, set "Digital Out (Optical)" to "On" in the System Configuration menu. For details, see "Digital Out (Optical)" (⇨ page 32).

Connecting the controller

- 1 Insert the analog controller (DUALSHOCK®2) into a controller port of the console.

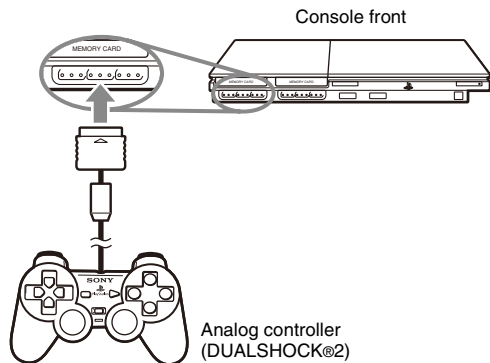

Hint

Some software titles designate a specific controller port to be used. Refer to the instructions supplied with the software for details.

Connecting the AC power cord

⚠ Warnings

- The socket-outlet shall be installed near the equipment and shall be easily accessible.
- Do not plug the AC power cord for the console into an electrical outlet until you have made all other connections.

- 1 Connect the AC power cord to the ~ AC IN connector on the console rear.

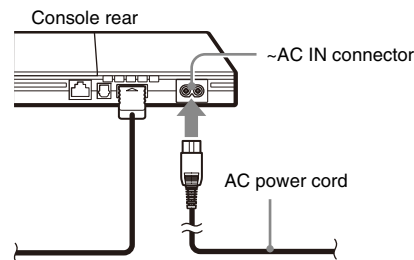

2 Plug the AC power cord into the electrical outlet.

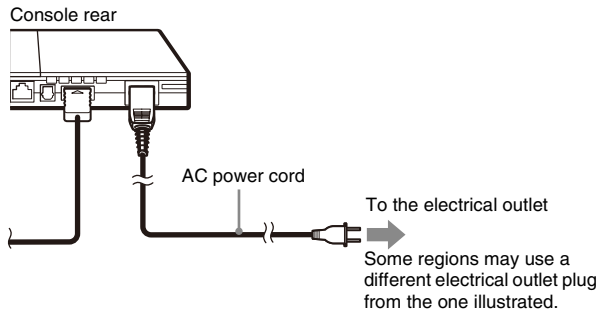

The I/⏻ (on/standby) indicator on the console front will light up in red to indicate that the console is in standby mode.

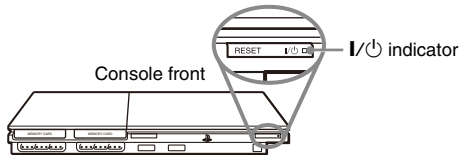

Turning the console on and off

Before turning on the console

Do not turn on the console until you have finished these steps. Refer to the instructions supplied with your TV for details.

- Turn on the TV.
- Change your TV setting to display output from the line to which the console is connected.

Turning on the console

1 Check that the I/⏻ (on/standby) indicator on the console front is lit up in red.

2 Press the I/⏻ (on/standby)/RESET button on the console front.

The I/⏻ indicator on the console front will turn green and output from the console will be displayed on the TV.

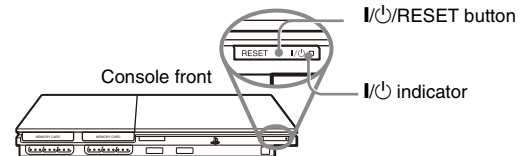

Hints

- The first time you turn on the console after purchase, screens for setting "Language", "Time Zone" and "Daylight Savings Time (Summer Time)" will be displayed. Follow the on-screen instructions to complete the settings.
- If you connect the console to a wide screen TV, set "Screen Size" in the System Configuration menu (➔ page 32).

Turning off the console

1 Press and hold the I/⏻/RESET button on the console front for more than a second.

The I/⏻ indicator will turn red to indicate that the console has entered standby mode.

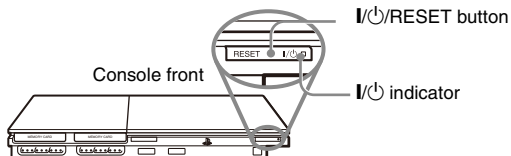

⚠ Warning

The power is not completely turned off when the console is in standby mode. If you do not plan to use the console for an extended period of time, unplug the AC power cord from the electrical outlet.

4 Close the disc cover.

After the disc cover is closed, the game will start.

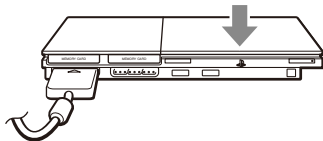

Hints

- You can also start a game from the Browser screen (→ page 30).
- If you turn on the console after inserting a disc, the game will start automatically.

To reset a game

Press the **I/⏻** (on/standby)/RESET button on the console front. Do not accidentally press the **I/⏻**/RESET button while playing a game, as doing so will cause the game to reset.

Ending a game

! Caution

When removing a disc, check that the disc has stopped completely. Do not touch the disc if it is spinning, as doing so may cause injury, damage to the disc or console malfunction.

1 Press the **⏻** button on the console front.

2 Remove the disc.

Hold down the black center part of the disc holder, and then lift the disc by the edges.



3 Close the disc cover.

4 Press the **I/⏻**/RESET button.

The main menu is displayed (→ page 30).

Changing game discs

1 Open the disc cover and remove the disc.

When removing a disc, hold down the black center part of the disc holder and then lift the disc by the edges.

2 Insert a new disc.

3 Close the disc cover and reset the console.

The new game will start.

Hint

You do not need to turn off the console when changing games.

Using the analog controller (DUALSHOCK®2)

The analog controller (DUALSHOCK®2) is equipped with a pressure-sensitive button function. It also has a vibration function.

Part names

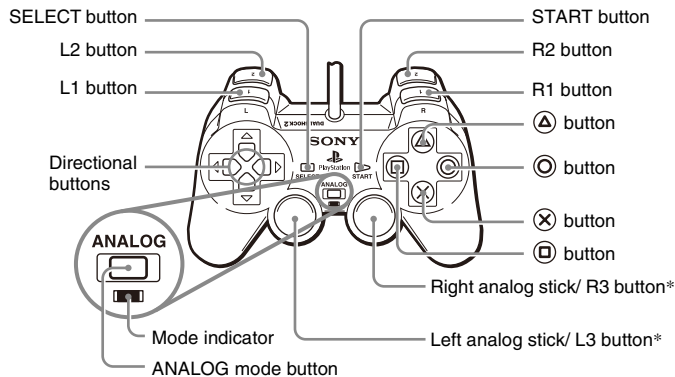

* The left and right analog sticks, or the L3 and R3 buttons, function only in analog mode (indicator: red).

* The L3 and R3 buttons function when the analog sticks are pressed.

Hint

Before using the analog controller (DUALSHOCK®2), with the console turned on, rotate the left and right analog sticks once with your thumbs before starting a game. Do not twist the analog sticks, but rotate as if drawing a circle as shown in the diagram.

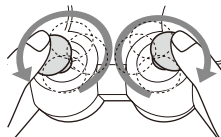

About mode switching

The ANALOG mode button can be used to switch between two modes. Switch to the appropriate mode for use. Note, however, that some software titles make this adjustment automatically.

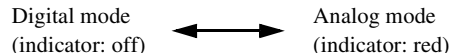

Hints

- When using the analog controller in digital mode, the left and right analog sticks do not function. Also, the pressure-sensitive button function is turned off.
- Depending on the software, you may not be able to switch modes even if you press the ANALOG mode button.

About analog controls

- When playing a PlayStation®2 format software title, you can use all buttons in analog mode except for the START, SELECT, L3 and R3 buttons.
- When playing a PlayStation® format software title, only the left and right analog sticks can be used in analog mode.

Hint

Depending on the software, the buttons for use in analog mode may be limited. Refer to the instructions supplied with the software for details.

About the vibration function

The vibration function can be set to ON or OFF in the software options menu.

Hint

Depending on the software, the vibration function may be set to "On" automatically.

About using the analog controller (DUALSHOCK®) (SCPH-110)

You can use the analog controller (DUALSHOCK®) (SCPH-110) with the PlayStation®2 console, but the functions of the buttons in analog mode may be different from those of the analog controller (DUALSHOCK®2). Only the left and right analog sticks can be used in analog mode.

Using memory cards

You can save and load game data using a memory card. You can also delete game data or copy game data from one memory card to another.

About memory card types

There are two types of memory cards. Select a memory card suitable for the software in use.

Memory card type	Compatible software	Amount of memory
Memory card (8MB) (for PlayStation®2) (SCPH-10020 G)	PlayStation®2 format software	Approx. 8 MB
Memory card (SCPH-1020)* * This product is no longer manufactured.	PlayStation® format software	15 memory blocks (approx. 120 KB)

MagicGate™ is a term of copyright protection technology developed by Sony Corporation.

Inserting a memory card

Insert the memory card into a MEMORY CARD slot on the console front.

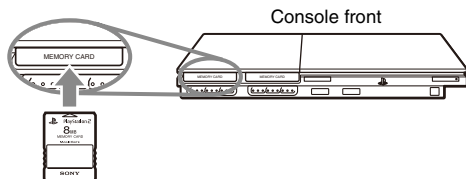

Hint

Some software titles designate a specific MEMORY CARD slot to use. Refer to the instructions supplied with the software for details.

Saving or loading game data

Depending on the software, the procedure for saving or loading may vary. Refer to the instructions supplied with the software for details.

Copying or deleting game data

- 1 At the Browser screen (→ page 30), use the directional buttons to select the icon for the memory card you want to use for copying or deleting data and then press the (X) button.**
- 2 Select the icon for the data you want to copy or delete, and then press the (X) button.**

- 3 Select "Copy" or "Delete", and then press the (X) button.**

When copying game data, check that two memory cards are inserted in the console. If you have selected "Delete", skip to step 5.

- 4 Select the destination, and then press the (X) button.**

- 5 Select "Yes", and then press the (X) button.**

While copying or deleting data, do not remove the memory cards.

- 6 When copying or deleting is completed, press the (O) button.**

Hints

- To view information about a game data item, select the icon for the data and then press the (A) button to check the details.
- Compatibility between software and memory cards:
 - You cannot save or copy PlayStation®2 format software to a memory card (SCPH-1020).
 - You cannot save PlayStation® format game data to a memory card (8MB) (for PlayStation®2). You can, however, copy PlayStation® format game data from a memory card (SCPH-1020) to a memory card (8MB) (for PlayStation®2) for storage purposes. Note that such game data cannot be loaded directly from a memory card (8MB) (for PlayStation®2).

Playing an audio CD

Playing a CD

1 Turn on the console and insert the disc (→ page 10).

Follow steps 1 to 4 of "Starting a game".
The track numbers are displayed.

2 Using the directional buttons, select the track number you want to play and then press the (X) button.

Playback begins.

Hints

- If you turn on the console after inserting a disc, the track numbers are displayed automatically.
- You can also start playback from the Browser screen (→ page 30).

! Caution

To play an audio CD recorded in DTS format, you must connect a device with a DTS decoder to the DIGITAL OUT (OPTICAL) connector (→ page 6). Note that an extremely loud noise may be emitted if the device does not have a DTS decoder or if it is connected to the AV MULTI OUT connector.

Operating the CD player during playback

Using the directional buttons, select the icon for the desired track and then press the (X) button.

Icon (button*)	Function
⏮ (L1 button)	Go to the beginning of the current or previous track
⏪ (L2 button)	Fast reverse
⏩ (R2 button)	Fast forward
⏭ (R1 button)	Go to the beginning of the next track
▶ (START button)	Start playback
⏸ (START button)	Pause playback
■ (SELECT button)	Stop playback

* You can operate directly by pressing the buttons of the analog controller (DUALSHOCK®2).

Hint

You can also use the DVD remote control (for PlayStation®2) (sold separately).

Ending audio CD playback

- 1 Using the directional buttons, select ■ and then press the ⊗ button.**

Playback stops. Press the ⏏ (open) button on the console front to remove the disc.

Playing in various modes

You can set for "Play Mode" and "Repeat".

Play Mode	Normal	Plays tracks as recorded on the CD
	Program	Plays tracks in a specified order
	Shuffle	Plays tracks in a random order
Repeat	Off	Does not play the CD repeatedly
	All	Plays all tracks repeatedly
	1	Plays a track repeatedly

- 1 At the Browser screen (→ page 30), use the directional buttons to select the audio CD icon and then press the ▲ button.**

The Play Options screen is displayed.
- 2 Select "Play Mode" or "Repeat", and then press the ⊗ button.**

- 3 Select the desired setting, and then press the ⊗ button.**

If you select "Program", the screen for specifying track order will be displayed. Select the tracks you want to play.

- 4 Press the ○ button.**

The Browser screen is displayed.

- 5 Select the audio CD icon, and then press the ⊗ button.**

The track numbers are displayed, and the setting option is shown in the lower left of the screen.

- 6 Select the desired track, and then press the ⊗ button.**

Playback begins.

Hints

- You can also access the Play Options screen from the screen displaying the tracks by selecting the Audio CD icon in the upper left corner of the screen and pressing the ▲ button.
- You can set "Play Mode" and "Repeat" at the same time.

Watching a DVD

You can operate the DVD player using the following methods.

- Using the on-screen Control Panel
- Operating directly using the analog controller (DUALSHOCK®2)
- Using the DVD remote control (for PlayStation®2) (sold separately)

The following instructions assume use of the Control Panel to operate the DVD player. Some operations may be different depending on the method used.

Hints

- For details about playing a DVD, refer to the instructions supplied with the DVD.
- The PlayStation®2 console plays disc content as recorded in the DVD software.
Note that not all features are available on all DVDs.

Using the Control Panel

1 Start playback of the DVD (→ page 19).

2 Press the SELECT button.

The Control Panel is displayed. If you press the SELECT button again, the display will change its position on the screen.



3 Using the directional buttons, select an icon and then press the (X) button.











Hint









To turn off the Control Panel, press the SELECT button (once or twice), or press the (O) button.

Control Panel item list

You can access the following options in the Control Panel.

Icon		Function
	Menu	Displays the DVD-Video menu
	Top Menu	Displays the DVD-Video menu

Icon		Function
	Return	Returns to the previously selected screen within the DVD's menu
	Audio Options	Displays and changes audio options on DVDs with multiple audio tracks
	Angle Options	Displays and changes viewing angles on DVDs recorded with multi-angle options
	Subtitle Options	Displays and changes subtitle options on DVDs with subtitle options
	Go To	Skips to the selected title, chapter or the specified time, and starts playback (**▶ page 19)
	Setup	Displays and changes options for language, picture quality, Parental Control level, audio, etc. (**▶ page 23)
	Time Display	Displays the current title or chapter number, the elapsed time, etc. (**▶ page 20)
	Help	Displays the direct button functions of the analog controller (DUALSHOCK®2)
0~9	Go to Chapter	Used to enter the number of a chapter you want to play (**▶ page 19)
	Previous/Next	Returns/skips to the beginning of the current, previous or next chapter
	Search	Fast reverses/forwards playback (**▶ page 20)
	Slow	Changes to playback/reverse playback in slow-motion

Icon		Function
	Play	Starts playback
	Pause	Pauses playback
	Stop	Stops playback (**▶ page 19)
A-B	A-B Repeat	Specifies a scene for playback, and starts playback of the scene that has been set (**▶ page 22)
	Shuffle Play	Begins playback of titles or chapters in a random order (**▶ page 22)
	Program Play	Begins playback of titles or chapters in a programmed sequence (**▶ page 21)
	Repeat Play	Selects repeated playback of all the titles on the disc, or one title or one chapter (**▶ page 22)
	Original/Play List	For DVD-RW discs (VR mode), selects Original or Play List content to play (**▶ page 21)
	Clear	Clears selected numbers or playback modes (**▶ page 23)

Hints

- You can use "?" to check the options that can be accessed directly using the buttons of the analog controller. To access the options directly using the controller, you must clear the Control Panel from the screen.
- Depending on the playback mode, some options may not be available or cannot be adjusted.

Playing a DVD

1 Turn on the console and insert a disc (→ page 10).

Follow steps 1 to 4 of "Starting a game". Playback begins.

Hints

- If you turn on the console after inserting a disc, playback will begin automatically.
- You can also start playback from the Browser screen (→ page 30).

Ending DVD playback ■

1 During playback, select ■ in the Control Panel (→ page 17) and then press the (X) button.

Playback stops. Press the  (open) button on the console front, and then remove the disc.

Playing a DVD from the last stopping point (Resume Play)

1 During playback, select ■ in the Control Panel (→ page 17) and then press the (X) button.

2 Select ►, and then press the (X) button.

Playback begins from the point where you stopped the disc in step 1.

To clear Resume Play

After step 1, select ■ and then press the (X) button.

Selecting a specific scene for playback

Selecting a scene by chapter number

1 During playback, select the desired chapter number in the Control Panel (→ page 17) and then press the (X) button.

Playback of the selected chapter begins. If you want to play a chapter with a single digit number (i.e. 1-9), enter a leading zero. For example, enter as "01".

Selecting a scene by title number, chapter number or by specifying the time

1 During playback, select in the Control Panel (→ page 17) and then press the (X) button.

2 Select an item, and then press the (X) button.

Title	Specifies the title number
Chapter	Specifies the chapter number
C XX:XX:XX (or T XX:XX:XX)	Specifies the elapsed time for the chapter (or title)

3 Select the numbers for the desired scene, and then press the (X) button.

Playback of the selected chapter begins.

Finding a particular point on a DVD (Search)



You can search either forwards or backwards to quickly locate a particular point on a DVD.

1 During playback, select or in the Control Panel (→ page 17) and then press and hold the button.

Search speed changes as shown below when you press either the up or down directional button while holding down the button.

- Search 3
- Search 2
- Search 1
- Slow

2 Release the button when you reach the point you are searching for.

Playback returns to normal speed.

Hint

To use the analog controller for Search during playback, press and hold down the L2 or R2 button to begin searching. Use the directional buttons to change speeds. Release the L2 or R2 button when you reach the point you are searching for.

Displaying playback information

You can display information such as the current title number or elapsed time.

1 During playback, select in the Control Panel (→ page 17) and then press the button.

The display changes as shown below each time you press the button.

Title X Chapter X	Title number and chapter number
Title X Chapter X C XX:XX:XX	Elapsed time of current chapter
Title X Chapter X C - XX:XX:XX	Remaining time of current chapter
Title X Chapter X T XX:XX:XX	Elapsed time of current title
Title X Chapter X T - XX:XX:XX	Remaining time of current title
(Off)	

Selecting Original or Play List for DVD-RW playback **PLIST**

When using a DVD-RW disc (VR mode), you can select the type of titles you want to play.

1 With playback stopped, select **PLIST** in the Control Panel (→ page 17) and then press the **X** button.

Original and Play List will be selected in turn each time you press the **X** button.

Original	Plays content in the originally recorded sequence
Play List	Plays edited content. Play List is the default setting.

Hints

- Slow-motion play in reverse is not available for DVD-RW discs (VR mode).
- You cannot use this function with Resume Play. Clear Resume Play (→ page 19) before selecting this feature.

Using the playback modes

Using the various playback modes, you can play titles or chapters in the order you want or repeat playback of a specific scene. There are four playback modes:

- Program Play (→ page 21)
- Shuffle Play (→ page 22)
- Repeat Play (→ page 22)
- A-B Repeat (→ page 22)

The following instructions assume use of the Control Panel (→ page 17) to operate the DVD player.

Hints

- You can play combinations of Program Play, Shuffle Play, and Repeat Play. Note, however, that some Shuffle Play or Repeat Play options may not be available depending on the combination.
- The PlayStation®2 console plays disc content as recorded in the DVD software.

Program Play **PGM**

You can create programs to play titles and chapters in any order.

1 During playback, select **PGM** in the Control Panel (→ page 17) and then press the **X** button.

2 Select a program number, and then press the **X** button.

If no programs have been set, the only option will be "1. Title".

3 Select the title number, and then press the **X** button.

4 Select the chapter number, and then press the button.

To play all the chapters, select "All". Repeat steps 2 to 4 to set other titles or chapters.

5 Press the **START** button.

Program Play begins.

Hint

The setting will not be cleared after Program Play finishes.

Shuffle Play

You can set this option for random playback of all titles or chapters recorded on a disc. Playback order will be different each time Shuffle Play is used.

1 Select in the Control Panel (\rightarrow page 17), and then press the button.

The display changes as shown below each time you press the  button.

Title Shuffle	Plays titles in random order
Chapter Shuffle	Plays chapters in random order
Shuffle Off	Clears Shuffle Play

2 Select , and then press the button.

Repeat Play

You can set this option to play titles or chapters repeatedly.

1 Select in the Control Panel (\rightarrow page 17), and then press the button.

The display changes as shown below each time you press the  button.

Disc Repeat	Repeats playback of all titles
Title Repeat	Repeats playback of one title
Chapter Repeat	Repeats playback of one chapter
Repeat Off	Clears Repeat Play

2 Select , and then press the button.

A-B Repeat A-B

You can set a specific scene to be played repeatedly.

1 During playback, select **A-B** in the Control Panel (\rightarrow page 17) and then press the button at the point you want to start repeated playback.

The starting point (point A) is set.

2 Press the button at the point you want to end repeated playback.

The ending point (point B) is set, and repeated playback of the section from A to B begins.

Clearing playback modes

Clears playback modes to allow normal playback.

- 1 Select  in the Control Panel (→ page 17), and then press the  button.**

A message stating, "Play mode contents cleared", is displayed and the console returns to normal playback.

Hint

If multiple playback modes have been set in a combination, all playback modes are cleared.

Adjusting DVD player settings

You can use the Control Panel to adjust DVD player settings, such as the language for subtitles, audio language, and Parental Control level.

Hints

- Some DVDs do not support all settings. The PlayStation®2 console plays disc content as recorded in the DVD software. If the DVD does not support the features listed, you will not be able to change the settings.
- The following options are not available during playback or Resume Play (→ page 19). Clear Resume Play before changing these settings.
 - "Menu", "Audio" and "Subtitles" in Language Setup
 - "TV Type" and "Progressive" in Screen Setup
 - "Parental Control" in Custom Setup
 - "DTS" and "Audio Track Auto Select Mode" in Audio Setup

You can change DVD player settings using the following procedure:

- 1 Select  in the Control Panel (→ page 17), and then press the  button.**

The Setup icon bar is displayed.

- 2 Select the icon for the setting you want to change, and then press the  button.**

The current setting for each item is displayed.

- 3 Select the desired item, and then press the  button.**

The menu option becomes active and can be selected.

4 Select the desired setting, and then press the **X** button.

The setting of the item is completed. For details, see the instructions for each item (→ pages 24 to 29).

Hints

- The default setting for each menu item is underlined in the explanations below.
- To return to the Control Panel after making settings, press the SELECT button.
- Settings are saved when you do any of the following:
 - Stop playback (including stopping Resume Play)
 - Open the disc cover

Setting language options

In "Language Setup" you can choose the language for the DVD's menu, audio and subtitles. Note that if you select a language that is not recorded on the DVD, one of the recorded languages is selected automatically.

Menu	Selects the language for the DVD's menu
Audio	Selects the language for the DVD's audio track
Subtitles	Selects the language for the DVD's subtitles

Hint



If you select "Audio Follow" for subtitles, the subtitle language will automatically be set to match the language selected for the DVD's audio track.

Setting TV display options

In the Screen Setup menu, you can set the screen size (aspect ratio) and other options that affect picture quality.

TV Type

You can set the aspect ratio to match the screen of the connected TV.

<u>16:9</u> 	Select this option when using a wide screen TV or a standard TV with special 16:9/wide screen functionality.
4:3 Letter Box 	Select this option when using a standard TV. This setting displays a wide picture with margins on the upper and lower portions of the screen.
4:3 PAN SCAN 	Select this option when using a standard TV. This setting displays a picture adjusted to the height of the screen, cutting off portions at left and right that do not fit.

Hint

When you set "Progressive" to "On", "TV Type" is automatically set to "16:9".

DNR (Digital Noise Reduction)

You can use this setting to help reduce roughness in the on-screen image and produce a cleaner picture.

<u>Off</u>	DNR is not used.
DNR1	Increases picture quality
DNR2	Increases picture quality (maximum)

Hints

- "DNR2" is more effective for reducing image roughness than "DNR1", but in some cases an afterimage may appear. If this occurs, select "Off".
- The DNR function may produce limited results on some DVDs.
- When you set "Progressive" to "On", "DNR" is automatically turned off and cannot be turned on.

Outline Sharpening

You can sharpen or soften the outline of the on-screen image. The higher the value, the sharper the outline. Normally, select "0".

• -2	• -1	<u>• 0</u>	• +1	• +2
------	------	------------	------	------

Hint

Depending on the DVD, Outline Sharpening may produce limited results.

Display

During playback, you can display playback status information in the top right corner of the screen for a few seconds.

<u>On</u>	Playback status information is displayed for a few seconds.
Off	Playback status information is not displayed.

Progressive

You can display an image in which the picture updates all the lines in one pass. In most cases, this results in a clearer, flicker-free image. This feature is available only if your TV and AV cable* support progressive scan (480p).

* The component AV cable (sold separately) is compatible with progressive scan.

<u>On</u>	Select this option when the console is connected to a TV that supports progressive scan (480p).
Off	Select this option when the console is connected to a standard TV.

Hints

- If picture quality is reduced or no image is displayed, set "Progressive" to "Off" when the console is connected to a TV without the necessary equipment. If you accidentally set this option to "On" for such a TV, picture quality may be reduced or the picture may not be displayed. To clear the setting, follow these steps:
 - 1 Check that you have a DVD in the console.
 - 2 Press the I/⏻(on/standby)/RESET button on the console front. Then press and hold down the START button of the analog controller (DUALSHOCK®2) in controller port 1 until the DVD picture is displayed. The "Progressive" setting is returned to "Off", allowing the DVD-Video to be displayed as normal. You can also cancel this setting using the "Clear Progressive Setting" (⇨ page 35) option in the Version Information screen.
- DVDs can contain video-based and film-based material, which use different frame rates. When playing video-based material using progressive scan, some images may appear unnatural. If this occurs, set "Progressive" to "Off" and view in standard interlace mode.
- When you set "Progressive" to "On", "TV Type" (⇨ page 24) is automatically set to "16:9".
- DVD-RW disc (VR mode) content can only be viewed in standard interlace format. The "Progressive" option is not available when playing such content.

Setting viewer options

Pause mode

You can use this option to set the picture status when playback is paused.

Auto	A picture with moving elements is displayed without jitter. Normally select this position.
Frame	A picture without moving elements can be displayed at high resolution.

Parental Control

In some regions, the viewing of some DVD content may be restricted based on viewer age or other factors. You can use the Parental Control feature to restrict the level of content that may be viewed through your console.

The lower the value, the stricter the restriction.

Setting Parental Control

1 Select "Parental Control", and then press the **(X)** button.

The screen for registering a password is displayed. If a password has already been registered, the screen for confirming the password is displayed.

2 Select a number, and then press the **(X)** button.

Repeat step 2 to enter a four-digit password. If you want to clear a number, press the **(O)** button. When registering a password, you are required to enter it again for confirmation.

3 Select "Region", and then press the **(X)** button.

The list of region options is displayed.

4 Select the region to base the Parental Control level on, and then press the **(X)** button.

If you select "Other", see "Region code list" (→ page 27).

5 Select "Level", and then press the **(X)** button.

The list of level options is displayed.

6 Select a restriction level, and then press the **(X)** button.

To clear Parental Control

With DVD playback stopped, go to step 6 in "Setting Parental Control" and set "Level" to "Off".

Region code list

To enter a Parental Control region code, select "Other" in step 4 of "Setting Parental Control" (→ page 26). Use the directional buttons to select the first letter, and then press the right directional button. Then select the next letter and press the (X) button.

Region	Code	Region	Code
United Kingdom	GB	China	CN
Italy	IT	Denmark	DK
Indonesia	ID	Germany	DE
Austria	AT	Japan	JP
Netherlands	NL	Norway	NO
Canada	CA	Philippines	PH
Korea	KR	Finland	FI
Singapore	SG	France	FR
Switzerland	CH	Belgium	BE
Sweden	SE	Hong Kong	HK
Spain	ES	Malaysia	MY
Thailand	TH	Russia	RU
Taiwan	TW		

Changing your password

In step 2 of "Setting Parental Control" (→ page 26), complete the following steps:

1 Using the directional buttons, select "Change Password" and then press the (X) button.

The screen for changing the password is displayed.

2 Select a number, and then press the (X) button.

Repeat step 2 to enter a four-digit password. You are required to enter it again for confirmation.

Playing a disc restricted by Parental Control

1 Start playback of the DVD (→ page 19).

You will be prompted to temporarily change the Parental Control level to allow playback. This usually occurs immediately at disc start-up but may also occur at different times depending on the DVD.

2 Using the directional buttons, select "Yes" and then press the (X) button.

The screen for entering the password is displayed.

3 Select a number, and then press the (X) button.

Repeat step 3 to enter the four-digit password. After entering the password, playback will begin again. When DVD playback is stopped, the Parental Control level returns to the original setting.

Hints

- If you forget your password, see the Quick Reference (→ page 2).
- If you do not set a password, you cannot change the Parental Control settings.
- Some DVDs with the Parental Control feature do not allow use of playback modes (→ pages 21 to 23).

Setting sound options

Audio Digital Out

You can switch the method of outputting the audio signal when you connect the following audio devices to the DIGITAL OUT (OPTICAL) connector.

Caution

When the console is connected to an audio device without a Dolby Digital, DTS or MPEG decoder, set "Dolby Digital", "DTS" and "MPEG" to "Off". If you set these options to "On" without the necessary decoder, you may have no sound or an extremely loud noise may be emitted.

Digital Out (Optical)

This option sets the type of output for the DIGITAL OUT (OPTICAL) connector.

<u>On</u>	Select this option when you want sound (audio signal) to be output through the DIGITAL OUT (OPTICAL) connector. Settings for "Dolby Digital", "DTS" and "MPEG" are displayed.
Off	Select this option when you do not want sound to be output through the DIGITAL OUT (OPTICAL) connector. Settings for "Dolby Digital", "DTS" and "MPEG" are not displayed.

Dolby Digital

This option sets Dolby Digital as the output signal for the DIGITAL OUT (OPTICAL) connector.

On	Select this option when the console is connected to an audio device with a built-in Dolby Digital decoder.
<u>Off</u>	Select this option when the console is connected to an audio device without a built-in Dolby Digital decoder.

DTS

This option sets DTS as the output signal for the DIGITAL OUT (OPTICAL) connector.

On	Select this option when the console is connected to an audio device with a built-in DTS decoder.
<u>Off</u>	Select this option when the console is connected to an audio device without a built-in DTS decoder.

MPEG

This option sets MPEG AUDIO as the output signal for the DIGITAL OUT (OPTICAL) connector.

On	Select this option when the console is connected to an audio device with a built-in MPEG decoder.
<u>Off</u>	Select this option when the console is connected to an audio device without a built-in MPEG decoder.

Audio Track Auto Select Mode

This setting gives priority to the audio track that contains the highest number of channels when you play a DVD on which multiple audio formats (PCM, Dolby Digital, DTS or MPEG) are recorded. If PCM, Dolby Digital, DTS and MPEG have the same number of channels, the console selects PCM, Dolby Digital, DTS and MPEG audio tracks in that order.

On	Priority given
<u>Off</u>	No priority given

Hints

- If you set "DTS" to "Off" in "Audio Digital Out" (↔▶ page 28), the DTS audio track is not played.
- Depending on the DVD, the audio channel with priority may be predetermined. In this case, the audio track will be selected based on the DVD's order of priority.

DVD Volume

You can set this option if the audio output level of the DVD is low. You can set this only when "Digital Out (Optical)" is set to "Off" in "Audio Digital Out" (↔▶ page 28).

+2	Turns up the volume (maximum)
+1	Turns up the volume
<u>Standard</u>	Normally select this option.

! Caution

If you set this option to "+1" or "+2", the sound may become distorted. If this happens, change the setting to "Standard". Also note that if you set the volume too high, it may harm your hearing or damage the speakers.

Displaying the main menu

From the main menu, you can access information and change various settings. You can also move to the following screens from the main menu. The main menu is displayed when you turn on the console without a disc inserted.



- Browser screen (→▶ page 30)
- System Configuration menu (→▶ page 31)
- Version Information screen (→▶ page 34)

1 Turn on the console (→▶ page 8).

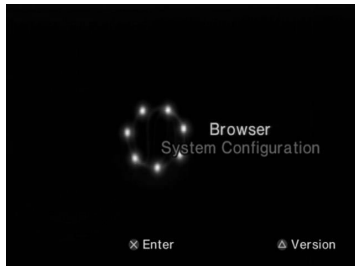
The main menu is displayed. Note that it may take some time for the main menu to be displayed.



Hint

If you turn on the console with a disc inserted, the main menu will not be displayed. To display the main menu, press the  (open) button on the console front and remove the disc. Then press the  (on/standby)/RESET button to reset the console.

Using the Browser screen

You can do the following from the Browser screen:

- Copy or delete game data saved on a memory card
- Start a game
- Start playback of an audio CD
- Start playback of a DVD

1 Display the main menu (→▶ page 30).

2 Using the directional buttons, select "Browser" and then press the button.

The Browser screen is displayed.

3 Insert a disc or memory card.

The icon for the inserted item is displayed in the Browser screen.

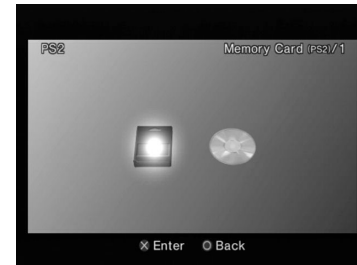

4 Select an icon, and then press the (X) button.

- When you select the memory card icon, icons for data saved on the memory card are displayed. To copy or delete game save data, see "Copying or deleting game data" (→ page 14).
- If you select the icon for a PlayStation®2 or PlayStation® format software disc, the game will start.
- When you select the icon for an audio CD disc, the tracks contained on the CD are displayed. See "Playing an audio CD" (→ page 15).
- If you select the icon for a DVD disc, playback of the DVD will begin.

Hint

The message "There is no data" is displayed on the Browser screen when no memory card or disc is inserted in the console.

Using the System Configuration menu

From the System Configuration menu, you can change settings for numerous options including language or time display, and audio or video output method.

1 Display the main menu (→ page 30).

2 Using the directional buttons, select "System Configuration" and then press the (X) button.

The System Configuration menu is displayed.



3 Select an item, and then press the (X) button.

The menu option becomes active and can be selected.

4 Select the desired setting, and then press the (X) button.

For details, see the instructions for each menu item (→ pages 32 to 33).

Hints

- The default setting for each menu item is underlined in the explanations below.
- Changes to each setting are saved and remain in effect even after you turn off or reset the console.

Clock Adjustment

You can set the date and time. Use the directional buttons to set "Year", "Month", "Day", "Hour", "Minute" and "Second". The setting goes into effect when you press the **(X)** button.

Optional settings

If you press the **(A)** button at the "Clock Adjustment" screen, you can set options such as "Date Format" or "Time Format". Use the directional buttons and the **(X)** button to make each setting.

Time Format	Sets the system clock to either 12-hour or 24-hour clock display
Date Format	Sets the display order of year, month and day
Time Zone	Sets the time zone
Daylight Savings Time	Sets Standard or Daylight Savings (Summer Time). Normally select "Standard".

Screen Size

You can set the display mode for the TV.

<u>4:3</u>	Select this option when using a standard TV with the console.
Full*	Select this option when using a standard TV with the console. The black margins on the upper and lower portions of the screen are cut off.
16:9	Select this option when using a wide screen TV or a standard TV with special 16:9/wide screen functionality.

* "Full" display mode is compatible with the System Configuration menu, Browser screen and audio CD screen.

Digital Out (Optical)

You can set whether to output the signal through the DIGITAL OUT (OPTICAL) connector.

<u>On</u>	Select this option when you want to output signal through the DIGITAL OUT (OPTICAL) connector.
Off	Select this option when you do not want to output signal through the DIGITAL OUT (OPTICAL) connector.

Component Video Out

When using the component AV cable (sold separately), you must set the mode to match the input jacks on your TV.

<u>Y Cb/ Pb Cr/ Pr</u>	Select this option when connecting the console to component video input connectors.
RGB	Select this option when connecting the console to RGB input connectors.

Hint

The "RGB" setting is only for PlayStation®2 and PlayStation® format software. When you watch a DVD, the mode automatically switches to "Y Cb/ Pb Cr/ Pr".

Remote Control

You can set this option when using the DVD remote control (for PlayStation®2) (sold separately).

<u>Gameplay Function On</u>	Select this option when operating PlayStation®2 or PlayStation® format software with the DVD remote control.
Gameplay Function Off	Select this option when not operating PlayStation®2 or PlayStation® format software with the DVD remote control.

Hint

The following limitations apply when using the DVD remote control with the option set to "Gameplay Function On":

- Depending on the software, some remote control buttons may not work properly.
- The buttons of the DVD remote control will not work when two or more buttons are pressed at the same time.
- Some software titles may stop operating properly when a controller is removed from controller port 1. If this happens, set to "Gameplay Function Off".

Language

You can use this option to select the language displayed on the main menu, Browser screen, System Configuration menu, and Version Information screen.

Traditional Chinese	Displays messages in Traditional Chinese (default setting for SCPH-90007)
English	Displays messages in English (default setting for SCPH-90006)

Using the Version Information screen

You can check version information for various console components by selecting this option. You can also change optional settings for some items.

1 At the main menu (→ page 30), press the **△** button.

The Version Information screen is displayed.

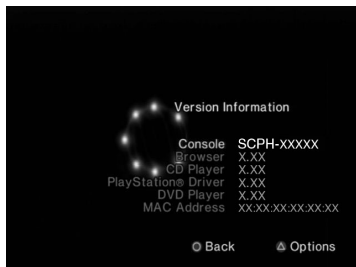

Optional settings

Optional settings are available for "Console", "PlayStation® Driver" and "DVD Player". "DVD Player" can be set only if the DVD player's "Progressive" option is set to "On".

1 Using the directional buttons, select an item and then press the **△** button.

The current setting for the item is displayed.

2 Select an item, and then press the **⊗** button.

The available options are displayed.

3 Select the desired setting, and then press the **⊗** button.

For details, see the instructions for each item (→ pages 34 to 36).

Hint

The default setting for each menu item is underlined in the explanations below.

Console

The PlayStation®2 console automatically adjusts its internal settings for optimal playback. When "Diagnosis" is set to "On", the console makes additional adjustments.

Diagnosis

<u>Off</u>	Diagnosis is turned off.
On	Diagnosis is turned on.

Hint

The "Diagnosis" setting will automatically return to the default setting in the following cases:

- When playback of PlayStation®2 or PlayStation® format software or a DVD begins
- When the console is reset
- When the console is turned off

PlayStation® Driver

You can set the PlayStation® Driver program to optimize performance of PlayStation® format software.

Hint

The settings will automatically return to the default settings in the following case:

- When the console is turned off

Disc Speed

<u>Standard</u>	Loads discs at normal speed
Fast	Loads discs at high speed

Hint

Set to "Standard" in the following cases:

- When fast loading does not produce improved results
- When using software that is not compatible with fast loading

Texture Mapping

<u>Standard</u>	Displays as normal
Smooth	Displays with reduced roughness in on-screen images

Hint

Set to "Standard" in the following cases:

- When smooth texture mapping does not produce improved results
- If the picture does not display properly when set to "Smooth"





DVD Player

If you set "Progressive" to "On" when the console is connected to a TV without the necessary equipment, the picture quality may be reduced or the picture may not be displayed. You can clear the "Progressive" setting by following the procedure below.

Remove the DVD before clearing the setting.

Clear Progressive Setting

<u>No</u>	Leaves the "Progressive" setting on
Yes	Clears the "Progressive" setting

- 1 Display the Version Information screen.**
- 2 Using the directional buttons, select "DVD Player" and then press the  button.**
The "Clear Progressive Setting" option is displayed.
- 3 Press the  button.**
- 4 Select "Yes", and then press the  button.**
- 5 Press the  button twice.**
The display returns to the main menu.
- 6 Press the  (open) button on the console front, and place a DVD in the console.**

7 Close the disc cover.

Playback begins.

Hint

The setting will not be cleared if 1) you do not start a DVD after step 4 or 2) you reset or turn off the console before step 6.

Connecting to a network

You can enjoy online games by connecting the PlayStation®2 console to a network. To play online games, you will need the following:

- A network compatible PlayStation®2 game
- Broadband Internet service
- A commercially available Ethernet cable
- A memory card (8MB) (for PlayStation®2) (sold separately)

Hints

- You cannot play online games with this console using a dial-up or ISDN connection.
- There are two types of Ethernet cables: straight-thru cables and crossover cables. Refer to the instructions supplied with the network device for details.

Connecting with an Ethernet cable

You can connect the console to a network using an Ethernet cable connected to the network connector on the console rear. You can connect to a 100 Base-TX or 10 Base-T network. Refer to the instructions supplied with the network device for details.

Basic network setup

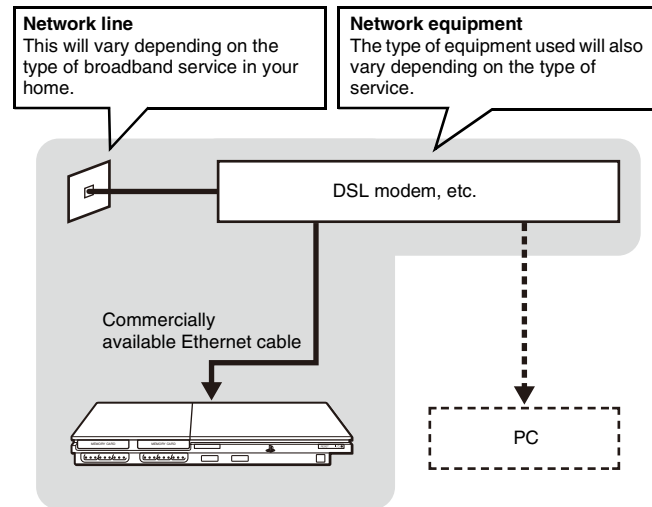

Hint

When connecting the console and a PC to the network, a network device such as a router or a hub may be required. Refer to the instructions supplied with the network device for details.

Connecting the console

Warning

Do not plug the AC power cord for the console into the electrical outlet until you have made all other connections.

1 Connect the Ethernet cable to the network connector on the console rear.

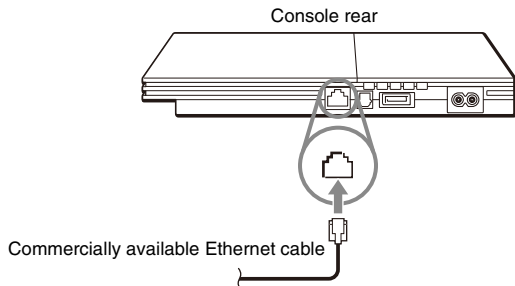

2 Insert the connector on the Ethernet cable to the network device.

The connection method will vary depending on the network device. Refer to the instructions supplied with the network device for details.

Warning

Do not connect Ethernet cables or telephone cords of the following types to the network connector; too much electrical current may pass through the connector, causing a malfunction, excessive heat or fire in the connector:

- Ethernet cables not appropriate for use with a 10Base-T/100Base-TX network
- Standard residential telephone lines
- Any ISDN (digital) compatible phone or data line
- PBX phone lines
- Other "unknown" types of telephone lines

Creating network settings

After you have connected an Ethernet cable to the console, you will need to create and save network settings. Actual network settings may vary depending on the online game being played. Refer to the instructions supplied with the software for details.

Items you will need

To create a network setting, you will need the following items:

- A memory card (8MB) (for PlayStation®2) (sold separately)
- Login and network setup information provided by your Internet service provider

Hint

Depending on the type of Internet service used, you may need to provide your MAC address. You can find the MAC address for your console listed in the Version Information screen (↔▶ page 34).

Specifications

Design and specifications are subject to change without notice.

General

Power requirements	AC220-240V 50Hz (SCPH-90006) AC110V 50/60Hz (SCPH-90007)
Power consumption (approx.)	35 W
Console dimensions (approx.)	230 × 28 × 152 mm / 9 × 1 × 6 in (w/h/d)
Console mass (approx.)	720 g
Signal format	NTSC
Operating temperature	5° C to 35° C / 41° F to 95° F
Inputs/outputs on the console front	Controller port (2) MEMORY CARD slot (2) USB connector (2)
Inputs/outputs on the console rear	NETWORK connector ~AC IN connector AV MULTI OUT connector DIGITAL OUT (OPTICAL) connector

Supplied accessories

See the Quick Reference (→ page 2).

About national export control

This product may fall within the scope of national export control legislation. You must comply fully with the requirements of such legislation and of all other applicable laws of any jurisdiction in relation to this product.

About access control

This product incorporates access control technology. Use of software not specifically designed for this product (excluding DVD-Videos and audio CDs) and copies of software designed for this product are prevented by access control. Unauthorized transfer, delivery, display, export, import, or transmission of programs, devices, or the product modified with programs or devices, to defeat the purpose of this access control feature is or may be prohibited by law.

關於 PlayStation®2 主機文件
PlayStation®2 主機文件包括內容：

• **快捷參考**

本文件隨附在主機外裝箱中，包含有關主機設定和基本操作，以及安全和故障檢修的資訊。

• **用戶指南（本文）**

可通過網路閱覽本文（PDF 格式），其中包含有關主機進階操作的資訊、技術規格及其他資訊。您可透過 Sony Computer Entertainment 的支援頁面 (<http://asia.playstation.com/support/>) 下載此文件。

目錄

準備工作

開始使用之前	43
各部名稱	44
連接至電視機	45
連接搭配數碼端子的音響設備	46
連接控制器	47
連接交流電源線	47
打開和關閉主機電源	48

遊戲

玩遊戲	50
使用 Memory Card（記憶卡）	53

音樂 CD

播放音樂 CD	55
---------------	----

DVD

觀賞 DVD	57
使用播放方式	61
調整 DVD 播放設定	63

主選單

顯示主選單	70
瀏覽器畫面	70
使用系統設定選單	71
版本資訊畫面	74

網路

連接網路	77
新建網路設定	78

其他資訊

規格	79
----------	----

開始使用之前

拆除 3 插針電源插頭轉換器 (僅限 SCPH-90006)

牆壁電源插座形狀依區域而異。若插座形狀與您居住之區域的電源插座不相容時，請鬆開螺絲並拔掉電源插頭轉換器。

3 插針電源插頭轉換器

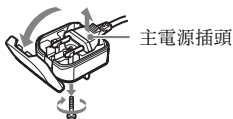

主電源插頭

放置主機

您可以水平或垂直放置主機。

水平放置

水平放置主機。



垂直位置

當垂直放置主機時，請使用 PlayStation®2 專用直立架 SCPH-90110 (選購品)。

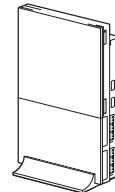

提示

有些 PlayStation®2 專用直立架不能用於本機型 PlayStation®2 主機。詳細請閱覽快捷參考 (▶▶ 第 42 頁)。購買直立架時，請選擇 SCPH-90110 直立架。

! 注意

切勿將主機放置在可能受到以下情況影響的場所：

- 會受到過多香煙煙霧或灰塵影響的地方。殘留在透鏡等內部零件上的香煙煙霧或煙灰可能會導致主機發生故障。
- 受到極端溫度影響的地方、或受日光直接照射、熱源旁或車窗關閉的車內 (特別在夏天)。這些惡劣環境都可能導致主機變形或引起主機發生故障。
- 靠近磁場的地方，如磁鐵或揚聲器產生的磁場。
- 會受到振動的地方。

各部名稱

PlayStation®2 主機前面

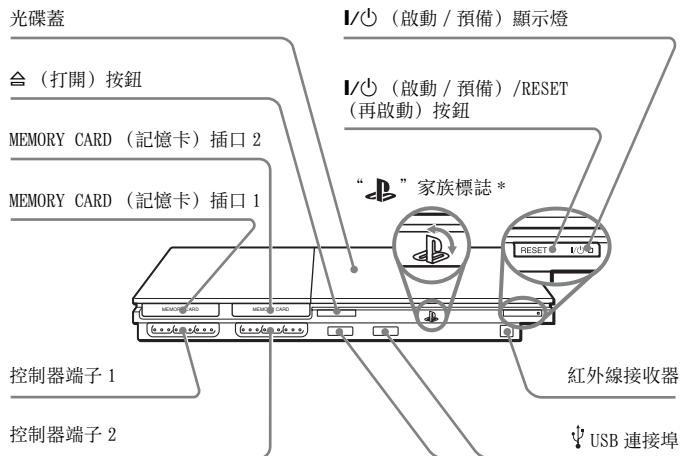

* 您可以配合主機的放置方式，旋轉“PS”家族標誌。

提示

您可以連接與 PlayStation®2 主機相容的 USB 設備。但請注意，並不是所有 USB 相容產品都能與 PlayStation®2 主機配合使用。詳細說明，請參閱所使用之 USB 相容周邊設備的使用說明書。

PlayStation®2 主機背面

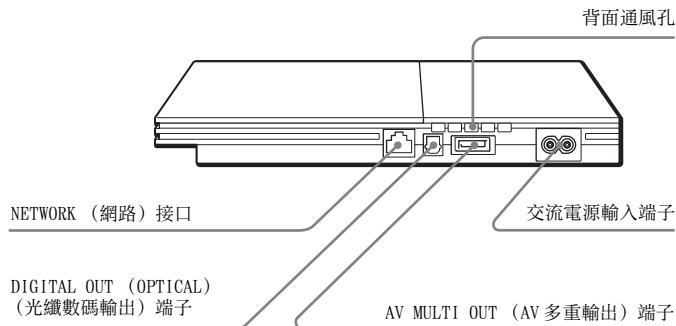

提示

類比控制器（DUALSHOCK®2）的各部名稱，請參閱“使用類比控制器（DUALSHOCK®2）”（▶▶ 第 52 頁）。

連接至電視機

連接之前

- 在完成所有連接之前，請勿將主機交流電源線插頭插入電源插座。
- 確認已關閉電視機的電源。

使用附屬的 AV 連接線連接電視機

如下圖所示將主機連接至電視機。

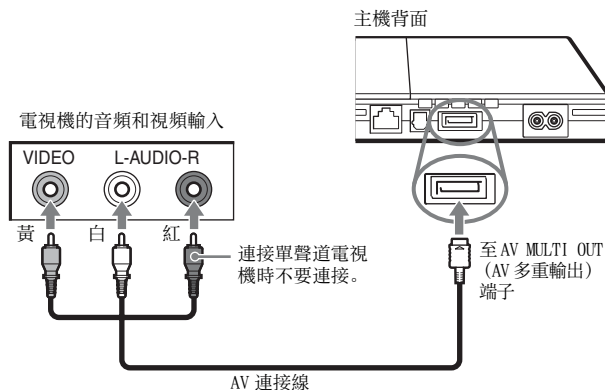

! 注意

如果在“PlayStation®2”連接至電漿電視 (Plasma TV)、液晶方式以外的投影電視機 (Projection TV) 長時間放置，並不斷播放靜止畫面時，可能會出現影像發生失真殘影現象。可能造成這類現象之靜止畫面包括主機的設定選單、DVD 選單，或暫停畫面等。假如時間過久，甚至可能令電視機螢幕造成永久的傷害。詳細說明，請參閱電視機附帶的使用說明書。

* 液晶顯示類型除外

提示

本主機可以連接至錄影機或電視結合錄影機的二合一電器。但在播放被設定了防拷密碼的 DVD 時，可能會出現畫質鮮明度降低的現象，敬請注意。

使用選購連接線時

畫質可能會因您所使用的連接線類型而有所差異。請參閱以下資訊確定最佳的連接方法。

當使用市面上販賣的其他連接線時，請參閱該連接線的使用說明書。

電視機	連接線類型
具備 S 影像輸入端子的電視機	S 視頻連接線 (SCPH-10480)
具備影像色差輸入端子的電視機	影像色差連接線 (SCPH-10490)

畫質等級圖

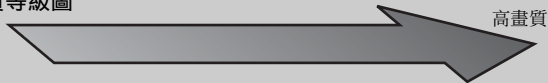

■ AV 連接線（附帶） ■ S 視頻連接線 ■ 影像色差連接線

此等級圖僅作參考。畫質可能會因您所選用的電視機或狀況而改變。

提示

- 若要使用逐行掃描，您必須準備支援逐行掃描（480p）的電視機，並且必須使用機能相容的連接線 * 進行連接。您還必須確認主機設定正確。詳細說明，請參閱“設定電視機顯示選項”中的“Progressive”（逐行掃描）（▶▶ 第 64 頁）。
 - * 影像色差連接線（選購品）相容逐行掃描機能。
- 您不能將本主機連接至帶有 HDTV 專用影像色差輸入（Y Pb Pr）的電視機。詳細說明，請參閱電視機附帶的使用說明書。

連接搭配數碼端子的音響設備

使用市售的光纖數碼連接線，您可以欣賞到有如置身電影院或音樂廳般的臨場效果。當將主機連接至搭配數碼端子的音響設備時，請參閱所連接設備的使用說明書。

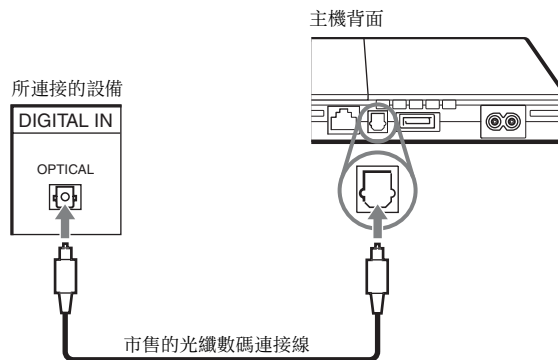

提示

- 使用光纖數碼連接線將主機連接至音響裝置時，某些 PlayStation®2 規格之軟件可能會出現無法播放聲音的異常現象。如果發生此情況，請使用附帶的 AV 連接線，並將其連接至主機的 AV MULTI OUT（AV 多重輸出）端子而不要使用光纖數碼連接線。
- 連接數碼音響裝置後，請選擇系統設定選單，將“DIGITAL OUT（OPTICAL）”（光纖數碼輸出）設定為“開”。詳細說明，請參閱“DIGITAL OUT（OPTICAL）”（光纖數碼輸出）（▶▶ 第 72 頁）。

連接控制器

- 1 將類比控制器 (DUALSHOCK®2) 插入主機的控制器端子。

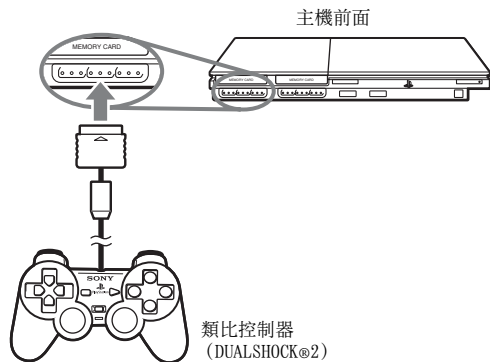

提示

某些軟件可能會指定控制器端子的使用位置。詳細說明，請參閱該軟件附帶的使用說明書。

連接交流電源線

警告

- 請插入接近且容易連接的電源插座。
- 在完成所有連接之前，請勿將主機交流電源線插頭插入電源插座。

- 1 請將交流電源線插入主機後方的交流電源輸入端子。

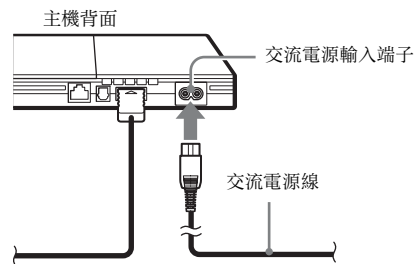

CT

準備工作

2 將交流電源線插頭插入電源插座。

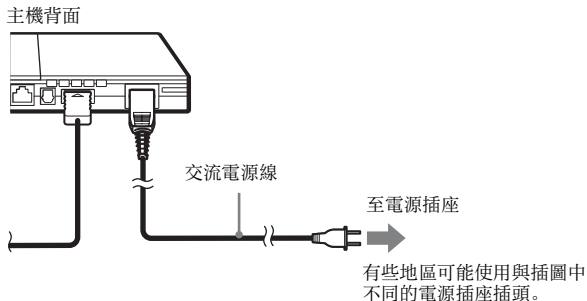

主機前面的 I/O (啟動 / 預備) 顯示燈亮起紅色，代表主機處於預備狀態。

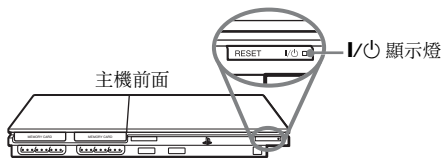

打開和關閉主機電源

打開主機電源之前

在完成這些步驟之前，請勿打開主機電源。詳細說明，請參閱電視機附帶的使用說明書。

- 打開電視機。
- 改變電視機設定，以顯示主機所連接線路的輸出。

打開主機電源

1 確認主機前面的 I/O (啟動 / 預備) 顯示燈亮起紅色。

2 按主機前面的 I/O (啟動 / 預備) / RESET (再啟動) 按鈕。主機前面的 I/O 顯示燈變為綠色，電視機將顯示主機輸出的訊息。

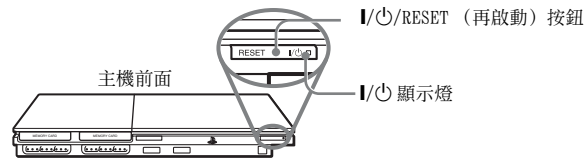

提示

- 購買後第一次打開主機電源時，將顯示“顯示語言”、“時區”和“設定夏令時間”設定畫面。請按照畫面顯示說明完成設定。
- 如果將主機連接至寬螢幕電視機，則選擇系統設定選單，設定“螢幕尺寸” (→ 第 72 頁)。

關閉主機電源

- 1 按住主機前面的 I/⏻/RESET（再啟動）按鈕超過一秒鐘。
I/⏻ 顯示燈將變為紅色，代表主機已經進入預備狀態。

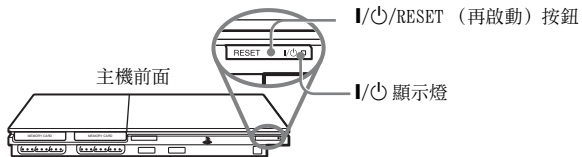

⚠ 警告

當主機處於預備狀態時，電源並未完成關閉。如果您長時間不打算使用主機，請從電源插座中拔掉交流電源線插頭。

玩遊戲

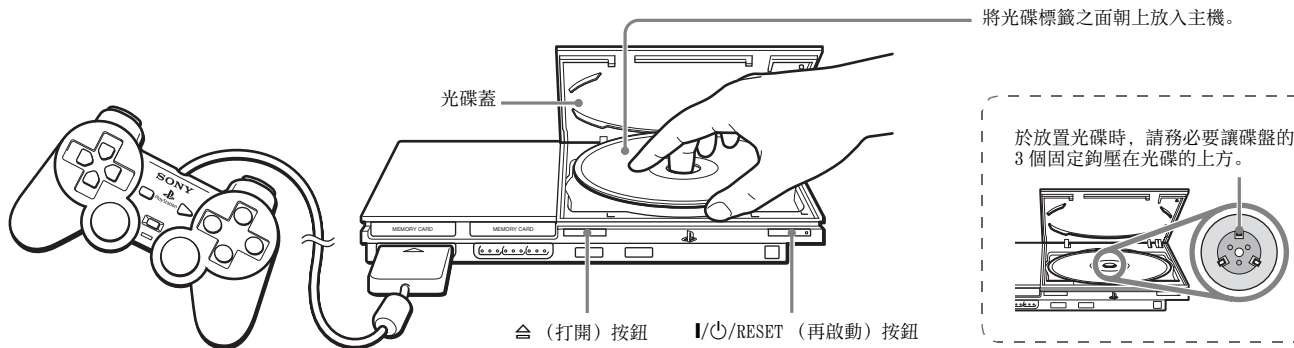

玩遊戲之前

檢查至電視機和音響裝置的連接是否正確，是否符合以下項目中刊載的注意事項。

- “連接至電視機” (→ 第 45 頁)
- “連接控制器” (→ 第 47 頁)
- “連接交流電源線” (→ 第 47 頁)

提示

若要玩線上遊戲，則首先需要連接網路，並進行網路設定。詳細說明，請參見“連接網路” (→ 第 77 頁)。

開始遊戲

- 1 打開主機電源** (→ 第 48 頁)。
顯示主選單 (→ 第 70 頁)。
- 2 按主機前面的 合 (打開) 按鈕。**
光碟蓋打開。
- 3 將光碟放入主機。**
將光碟標籤之面朝上放置入光碟架中。

4 關閉光碟蓋。

關閉光碟蓋後，即可開始遊戲。

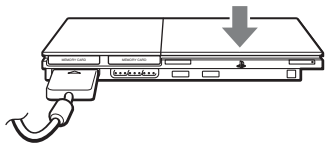

提示

- 您也可以從瀏覽器畫面啟動遊戲（▶▶ 第 70 頁）。
- 如果在插入光碟後打開主機電源，則遊戲將自動開始。

若要重新開始遊戲

按主機前面的 **I/⏻**（啟動 / 預備）/RESET（再啟動）按鈕。在玩遊戲過程中，切勿意外按到 **I/⏻**/RESET（再啟動）按鈕，否則將強制中止遊戲，並重新開始。

結束遊戲

注意

取出光碟時，請確認光碟已經完全停止。如果光碟正在旋轉，則切勿觸摸光碟，否則可能造成受傷、損壞光碟或主機故障。

1 按主機前面的 **⏻** 按鈕。

2 取出光碟。

往下壓動光碟架的黑色中心部位，持拿光碟的邊緣。

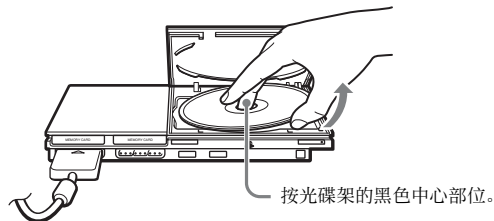

3 關閉光碟蓋。

4 按 **I/⏻**/RESET（再啟動）按鈕。

顯示主選單（▶▶ 第 70 頁）。

更換遊戲光碟

1 打開光碟蓋，取出光碟。

取出光碟時，往下壓動光碟架的黑色中心部位，持拿光碟的邊緣。

2 插入新的光碟。

3 關閉光碟蓋，重新啟動主機。

重新開始遊玩。

提示

當更換遊戲時不需要關閉主機。

使用類比控制器 (DUALSHOCK®2)

類比控制器 (DUALSHOCK®2) 配備了壓力感應按鈕功能。同時還具有振動功能。

各部名稱

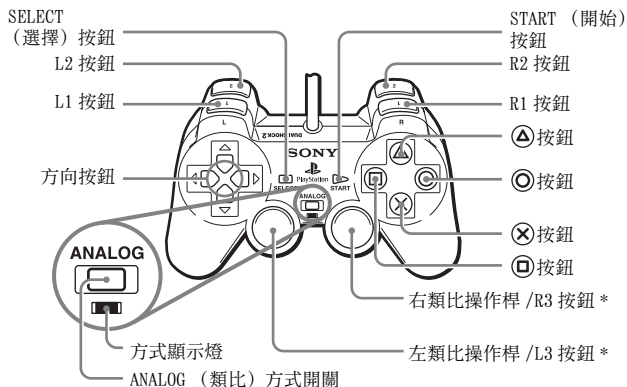

- * 左右類比操作桿或 L3 和 R3 按鈕，僅能於類比模式中 (顯示燈：紅色) 使用。
- * 按下類比操作桿，即代表按下 L3 按鈕或 R3 按鈕。

提示

使用類比控制器 (DUALSHOCK®2) 前，請打開主機，在開始遊戲之前先用拇指轉動一次左類比操作桿和右類比操作桿。請不要扭轉類比操作桿，請按照圖中所示的畫圓方法轉動。

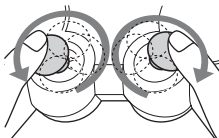

關於方式開關

按下 ANALOG (類比) 方式開關，可更改類比控制器的控制方式，並切換至適宜的控制方式。但請注意，某些軟件會強制要求更改控制方式。

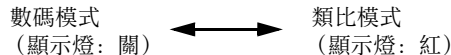

提示

- 當選擇數碼方式使用類比控制器時，無法使用左右類比操作桿。同時亦會關閉壓力感應按鈕功能。
- 某些軟件並不對應 ANALOG (類比) 方式開關按鈕，用戶無法按此按鈕隨意切換控制方式。

關於類比控制

- 當播放 PlayStation®2 規格之軟件標題時，您可以在類比方式中使用除 START (開始)、SELECT (選擇)、L3 和 R3 按鈕以外的全部按鈕。
- 當遊玩 PlayStation® 規格之軟件時，選擇類比模式亦只能使用左右類比操作桿。

提示

某些軟件可能會限制類比方式所對應的按鈕。詳細說明，請參閱該軟件附帶的使用說明書。

關於振動功能

您可開啟軟件的選項設定選單，設定振動功能的有無。

提示

某些軟件可能會預先關閉振動功能，設定為「關」。

關於使用類比控制器 (DUALSHOCK®) (SCPH-110)

您可以在 PlayStation®2 主機上使用類比控制器 (DUALSHOCK®)，但選擇類比模式時的按鈕功能可能會與類比控制器 (DUALSHOCK®2) 有所不同。且只能於切換至類比模式後始可使用左右類比操作桿。

使用 Memory Card (記憶卡)

您可以使用 Memory Card (記憶卡) 保存和載入遊戲資料。您也可以刪除遊戲資料，或從 Memory Card (記憶卡) 將遊戲資料拷貝到另外的記憶卡。

關於 Memory Card (記憶卡) 類型

Memory Card (記憶卡) 分為以下兩種。請配合遊玩的軟件，選擇適當的 Memory Card (記憶卡) 使用。

Memory Card (記憶卡) 類型	相容軟件	記憶體容量
PlayStation®2 專用 Memory Card (記憶卡) (8MB) (SCPH-10020 G)	PlayStation®2 規格之軟件	約 8 MB
Memory Card (記憶卡) (SCPH-1020)* * 本產品不再生產。	PlayStation® 規格之軟件	15 個記憶體區塊 (約 120 KB)

MagicGate™ 是 SONY 公司開發的著作權保護技術之名稱。

插入 Memory Card (記憶卡)

將 Memory Card (記憶卡) 插入主機前面的 MEMORY CARD (記憶卡) 插口。

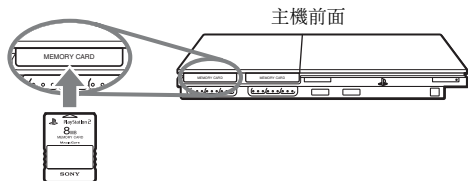

提示

某些軟件可能會指定控制器端子的使用位置。詳細說明，請參閱該軟件附帶的使用說明書。

保存或載入遊戲資料

保存與載入遊戲資料的方法因遊戲而異。詳細說明，請參閱該軟件附帶的使用說明書。

拷貝或刪除遊戲資料

- 1 進入瀏覽器畫面 (↔ 第 70 頁)，使用方向按鈕選擇您想要執行拷貝或刪除的 Memory Card (記憶卡) 之圖示，然後按 ⊗ 按鈕。
- 2 選擇您想要拷貝或刪除的資料之圖示，然後按 ⊗ 按鈕。

- 3 選擇“拷貝”或“刪除”，然後按 ⊗ 按鈕。
當拷貝遊戲資料時，請確認主機中插入了兩個 Memory Card (記憶卡)。如果您選擇了“刪除”，則跳到步驟 5。
- 4 選擇資料的拷貝位置，然後按 ⊗ 按鈕。
- 5 選擇“是”，然後按 ⊗ 按鈕。
在拷貝或刪除資料過程中，請勿取出 Memory Card (記憶卡)。
- 6 拷貝或刪除完成後，按 ○ 按鈕離開。

提示

- 若要觀看遊戲資料的關連資訊，請選擇該資料之圖示，然後按 △ 按鈕確認詳細內容。
- 軟件和 Memory Card (記憶卡) 之間的相容性：
 - 您無法將 PlayStation®2 規格之遊戲資料儲存或拷貝到 Memory Card (記憶卡) (SCPH-1020)。
 - 您無法將 PlayStation® 規格之遊戲資料儲存到 PlayStation®2 專用 Memory Card (記憶卡) (8MB)。但是，出於保存目的，您可以將 PlayStation® 之遊戲資料從 Memory Card (記憶卡) (SCPH-1020) 拷貝到 PlayStation®2 專用 Memory Card (記憶卡) (8MB)，以作為保存之用。請注意，您無法直接從 PlayStation®2 專用 Memory Card (記憶卡) (8MB) 載入的遊戲資料。

播放音樂 CD

播放 CD

- 1 打開主機並插入光碟（➡ 第 50 頁）。
按照“開始遊戲”的步驟 1 至 4 進行操作。
顯示曲目號碼。
- 2 使用方向按鈕，選擇您想要播放的曲目號碼，然後按⊗按鈕。
播放開始。

提示

- 如果在插入光碟後打開主機電源，則會自動顯示曲目號碼。
- 您也可進入瀏覽器畫面，選擇開始播放（➡ 第 70 頁）。

! 注意

若要播放以 DTS 格式錄製的音樂 CD，您必須將帶有 DTS 解碼器的設備連接至 DIGITAL OUT (OPTICAL) (光纖數碼輸出) 端子（➡ 第 46 頁）。請注意，如果此設備不具備 DTS 解碼器，或者如果連接在 AV MULTI OUT (AV 多重輸出) 端子，則可能發出震耳欲聾的噪音。

在播放過程中操作 CD 播放機

使用方向按鈕，選擇所要曲目的圖示，然後按⊗按鈕。

圖示 (按鈕*)	功能
⏮ (L1 按鈕)	進到目前或上一曲目的開頭
⏪ (L2 按鈕)	快退
⏩ (R2 按鈕)	快進
⏭ (R1 按鈕)	進到下一曲目的開頭
▶ (START (開始) 按鈕)	開始播放
⏸ (START (開始) 按鈕)	暫停播放
■ (SELECT (選擇) 按鈕)	停止播放

* 您亦可使用類比控制器 (DUALSHOCK®2) 的按鈕直接進行操作。

提示

您也可以使用 PlayStation®2 專用 DVD 遙控器 (選購品)。

結束音樂 CD 的播放

- 1 使用方向按鈕，選擇 **■**，然後按 **⊗** 按鈕。
播放停止。按主機前面的 **⊞**（打開）按鈕取出光碟。

以各種方式播放

您可以設定“播放模式”和“重複”。

播放模式	標準	按照 CD 上的錄製順序播放曲目
	編序	以特定的順序播放曲目
	隨機	以隨機順序播放曲目
重複	關	不反覆播放 CD
	全曲	反覆播放全部曲目
	單曲	反覆播放一個曲目

- 1 進入瀏覽器畫面（**↔** 第 70 頁），使用方向按鈕選擇音樂 CD 圖示，然後按 **⊕** 按鈕。
顯示播放選項畫面。
- 2 選擇“播放模式”或“重複”，然後按 **⊗** 按鈕。
- 3 選擇想要的設定，然後按 **⊗** 按鈕。
如果選擇“編序”，則將顯示指定曲目順序的畫面。請選擇您想要播放的曲目。
- 4 按 **⊙** 按鈕。
返回瀏覽器畫面。

- 5 選擇音樂 CD 圖示，然後按 **⊗** 按鈕。
顯示曲目號碼，設定選項顯示在畫面的左下方。
- 6 選擇想要的曲目，然後按 **⊗** 按鈕。
播放開始。

提示

- 您也可以通過選擇畫面左上角的音頻 CD 圖示，並按 **⊕** 按鈕，從顯示曲目的畫面中進入播放選項畫面。
- 您可以同時設定“播放模式”和“重複”。

觀賞 DVD

您可以使用以下方法操作 DVD 播放機。

- 使用畫面上顯示的控制面板
- 使用類比控制器 (DUALSHOCK®2) 直接操作
- 使用 PlayStation®2 專用 DVD 遙控器 (選購品)

以下說明為假設使用控制面板操作 DVD 播放機。視所使用的方法而定，有些操作可能不同。

提示

- 有關播放 DVD 的詳細說明，請參閱 DVD 附帶的說明書。
- PlayStation®2 主機會依據 DVD 中設定的內容而進行播放。但部份 DVD 的設定功能可能會出現無法使用的情形，敬請注意。

使用控制面板

1 開始播放 DVD (→ 第 59 頁)。

2 按 SELECT (選擇) 按鈕。

顯示控制面板。如果再按 SELECT (選擇) 按鈕，則將改變畫面上的顯示位置。



3 使用方向按鈕，選擇一個圖示，然後按(×)按鈕。

提示





若要關閉控制面板，則按 SELECT (選擇) 按鈕 (一次或兩次)，或按(○)按鈕。

控制面板項目清單

您可以選擇控制面板中的以下選項。

圖示		功能
	選單	顯示 DVD-Video 選單
	頂部選單	顯示 DVD-Video 選單
	返回	返回至 DVD 選單的前一個選擇畫面

圖示	功能
 聲音選項	顯示和變更錄製多種聲音軌跡（語言）之 DVD 的聲音設定
 角度選項	顯示和變更錄製多種取景角度之 DVD 的角度設定
 字幕選項	顯示和變更錄製字幕之 DVD 的字幕設定
 進入	跳至所選擇的標題、章或指定的時間，並開始播放（●▶ 第 59 頁）
 設定	顯示和變更語言、畫質、視聽年齡限制等級、聲音等選項（●▶ 第 63 頁）
 時間顯示	顯示當前標題或章號碼、已播放時間等（●▶ 第 60 頁）
 說明	顯示類比控制器（DUALSHOCK®2）的按鈕功能
0~9 進入章	進入您想要播放的章號碼（●▶ 第 59 頁）
 後退 / 前進	返回或 / 跳至當前章、上一章或下一章的開頭
 尋找	快退 / 快進播放畫面（●▶ 第 60 頁）
 慢放	以慢動作進行播放 / 倒放
 播放	開始播放
 暫停	暫停播放
 停止	停止播放（●▶ 第 59 頁）

圖示	功能
A-B A-B 重複播放	指定播放場景，並從已經設定的場景開始播放（●▶ 第 62 頁）
 隨機播放	以任意順序開始播放標題或章（●▶ 第 62 頁）
 編序播放	以編排好的順序開始播放標題或章（●▶ 第 61 頁）
 重複播放	選擇重複播放光碟上全部標題，或一個標題或一個章（●▶ 第 62 頁）
 原作品 / 播放目錄	對於 DVD-RW 光碟（VR 模式），請選擇原作品或播放目錄內容進行播放（●▶ 第 61 頁）
 解除	取消已選擇的數字或播放模式（●▶ 第 63 頁）

提示

- 您可以使用“？”來確認能使用類比控制器按鈕直接進入的選項。若要用控制器直接進入選項，您必須從畫面中清除控制面板。
- 視播放方式而定，有些選項可能無效或無法調節。

播放 DVD

- 1 打開主機並插入光碟 (→ 第 50 頁)。
按照“開始遊戲”的步驟 1 至 4 進行操作。播放開始。

提示

- 如果在插入光碟後打開主機電源，則將自動開始播放。
- 您也可以進入瀏覽器畫面，選擇開始播放 (→ 第 70 頁)。

結束 DVD 播放 ■

- 1 在播放過程中，選擇控制面板的 ■ (→ 第 57 頁)，然後按 ⊗ 按鈕。
播放停止。按主機前面的 ⏏ (打開) 按鈕取出光碟。

從停播點恢復播放 (重續播放)

- 1 在播放過程中，選擇控制面板的 ■ (→ 第 57 頁)，然後按 ⊗ 按鈕。
- 2 選擇 ▶，然後按 ⊗ 按鈕。
從步驟 1 的停播點起繼續播放。

若要解除重續播放

在步驟 1 後，選擇 ■，然後按 ⊗ 按鈕。

選擇特定場景進行播放

按章號碼選擇場景

- 1 在播放過程中，選擇控制面板中，需要的章號碼 (→ 第 57 頁)，然後按 ⊗ 按鈕。
開始播放所選擇的章。如果要播放單個數字號碼的章 (例如 1-9)，則需要於輸入章號碼前，先輸入「0」。例如，鍵入“01”。

按標題號碼、章號碼或按指定的時間選擇場景

- 1 在播放過程中，選擇控制面板的 ↶ (→ 第 57 頁)，然後按 ⊗ 按鈕。



- 2 選擇一個項目，然後按 ⊗ 按鈕。

標題	指定標題號碼
章	指定章號碼
C XX:XX:XX (或 T XX:XX:XX)	指定章 (或標題) 的已播放時間

- 3 選擇想要的場景號碼，然後按 ⊗ 按鈕。
開始播放所選擇的章。

尋找 DVD 的特定點 (尋找)

您可以向前或向後尋找，從而快速找到 DVD 上的特定點。

1 在播放過程中，選擇控制面板的  或  (→ 第 57 頁)，然後按住  按鈕不放。

按住  按鈕不放，按方向按鈕之上下，尋找速度將如下所示改變。

- 尋找 3
- 尋找 2
- 尋找 1
- 慢放

2 當到達您所尋找的點，鬆開  按鈕。

播放返回正常速度。

提示

若要在播放過程中使用類比控制器進行尋找，則按住 L2 或 R2 按鈕開始尋找。並使用方向按鈕改變速度。當到達您所尋找的點，鬆開 L2 或 R2 按鈕。

顯示播放資訊

畫面上可顯示當前標題號碼或已播放時間等資訊。

1 在播放時，選擇控制面板的  (→ 第 57 頁)，然後按  按鈕。

每按一次  按鈕，顯示將如下改變。

標題 X 章 X	標題號碼和章號碼
標題 X 章 X C XX:XX:XX	目前章的已播放時間
標題 X 章 X C -XX:XX:XX	目前章的剩餘時間
標題 X 章 X T XX:XX:XX	目前標題的已播放時間
標題 X 章 X T -XX:XX:XX	目前標題的剩餘時間
(關)	

選擇原作品或播放目錄播放 DVD-RW **PLIST**

當使用 DVD-RW 光碟（VR 模式）時，您可以選擇您想要播放標題的類型。

1 在播放停止時，選擇控制面板的 **PLIST**（➡ 第 57 頁），然後按 **⊗** 按鈕。

每按一次 **⊗** 按鈕，將依次選擇原作品和播放目錄。

原作品	按原先錄製的順序播放內容。
播放目錄	播放經編輯的內容。播放目錄為預設設定。

提示

- 播放 DVD-RW 光碟（VR 模式）時，無法使用反向慢動作播放。
- 此功能不能與重續播放一起使用。在選擇此功能之前需要先解除重續播放（➡ 第 59 頁）。

使用播放方式

使用各種播放方式，您可選擇您想要的順序播放標題或章，或重複播放指定的場景。有四種播放方式：

- 編序播放（➡ 第 61 頁）
- 隨機播放（➡ 第 62 頁）
- 重複播放（➡ 第 62 頁）
- A-B 重複播放（➡ 第 62 頁）

以下說明為假設使用控制面板（➡ 第 57 頁）操作 DVD 播放裝置。

提示

- 您可以組合編序播放、隨機播放和重複播放進行播放。但請注意，隨組合的不同，可能會出現無法執行隨機播放或重複播放的情形。
- PlayStation®2 主機按照 DVD 軟件中錄製的內容播放光碟。

編序播放 **PGM**

您可以創建編序，以任意順序播放標題和章。

1 在播放過程中，選擇控制面板的 **PGM**（➡ 第 57 頁），然後按 **⊗** 按鈕。

2 選擇一個編序號碼，然後按 **⊗** 按鈕。
如果尚未設定編序，則只有一個選項“1. 標題”。

3 選擇標題號碼，然後按 **⊗** 按鈕。

4 選擇章號碼，然後按⊗按鈕。

若要播放全部章，則選擇“全部”。之前請重複步驟 2 至 4 設定其他標題或章。

5 按 START（開始）按鈕。

開始編序播放。

提示

編序播放的設定內容，不會於結果播放後自動解除。

隨機播放 SHUF

您可以設定此選項對光碟上錄製的全部標題或章進行任意順序的播放。每使用一次隨機播放，播放順序都將不同。

1 選擇控制面板的SHUF（↔ 第 57 頁），然後按⊗按鈕。

每按一次⊗按鈕，顯示將如下改變。

標題隨機播放	以任意順序播放標題
章隨機播放	以任意順序播放章
解除隨機播放	解除隨機播放

2 選擇▶，然後按⊗按鈕。

重複播放

您可以設定此選項反覆播放標題或章。

1 選擇控制面板的（↔ 第 57 頁），然後按⊗按鈕。

每按一次⊗按鈕，顯示將如下改變。

光碟重複播放	重複播放全部標題
標題重複播放	重複播放一個標題
章重複播放	重複播放一個章
解除重複播放	解除重複播放

2 選擇▶，然後按⊗按鈕。

A-B 重複播放 A-B

您可以設定特定的場景反覆播放。

1 在播放過程中，選擇控制面板的A-B（↔ 第 57 頁），然後在您想要開始重複播放的點按⊗按鈕。

設定開始點（A 點）。

2 在您想要結束重複播放的點按⊗按鈕。

設定結束點（B 點），並開始重複播放 A 至 B 部分。

解除播放方式 CLEAR

解除播放方式以便進行普通播放。

- 1 在控制面板中選擇**CLEAR** (▶ 第 57 頁)，然後按⊗按鈕。

顯示“播放模式已被解除”訊息，主機返回至普通播放。

提示

之前所設定的一個或多個播放設定，都將會被一併解除。

調整 DVD 播放設定

您可以使用控制面板調整 DVD 播放設定，如字幕語言、聲音語言和視聽年齡限制等級。

提示

- 有些DVD不支援全部設定。PlayStation®2主機會依據DVD中設定的內容而進行播放。如果DVD不支援所列出的功能，則您將無法變更設定。
- 在進行播放或重續播放時，無法使用以下選項。播放或重續播放 (▶ 第 59 頁)。在變更這些設定之前解除重續播放。
 - 語言設定中的“選單語言”，“聲音語言”和“字幕語言”
 - 畫面設定中的“電視機形式”和“Progressive”（逐行掃描）
 - 個人設定中的“視聽年齡限制”
 - 聲音設定中的“DTS”和“聲音軌跡自動選擇模式”

您可以使用以下過程更改 DVD 播放裝置設定：

- 1 選擇控制面板的 (▶ 第 57 頁)，然後按⊗按鈕。
顯示設定圖示。
- 2 選擇您想要更改設定的圖示，然後按⊗按鈕。
顯示每個項目的當前設定。
- 3 選擇想要的項目，然後按⊗按鈕。
選單項目變為有效，並能被選擇。
- 4 選擇想要的設定，然後按⊗按鈕。
項目設定完成。詳細說明，請參見每個項目的說明 (▶ 第 64 至 69 頁)。

提示

- 每個選單項目的預設設定在以下說明中用底線表示。
- 設定後若要返回控制面板，則按 SELECT（選擇）按鈕。
- 當進行以下任何一項操作時，設定將被儲存：
 - 停止播放（包括停止重續播放）
 - 關閉光碟蓋

設定語言選項

在“語言設定”中，您可以選擇 DVD 選單、聲音和字幕所使用的語言。請注意，如果您選擇了 DVD 上未錄製的語言，則將自動選擇已經錄製的一種語言。

選單語言	選擇 DVD 選單所使用的語言
聲音語言	選擇 DVD 聲音軌跡所使用的語言
字幕語言	選擇 DVD 字幕所使用的語言

提示



如果字幕語言選擇了“聲音連動”，則字幕語言將自動設定為與 DVD 聲音軌跡所選擇語言一致的語言。

設定電視機顯示選項

在畫面設定選單中，您可以設定螢幕尺寸（縱橫比）和其他影響畫質的選項。

電視機形式

您可以設定縱橫比，以符合所連接電視機的螢幕。

16:9 	當使用寬螢幕電視機或具有特定 16:9/ 寬螢幕功能普通電視機時選擇此選項。
4:3 信箱形式 	當使用普通電視機時選擇此選項。此設定顯示寬螢幕影像，畫面的上下將會出現黑邊。
4:3 全景掃描 	當使用普通電視機時選擇此選項。此設定顯示的影像被調節到螢幕的高度，左右兩邊超出螢幕部分會被切除。

提示

當您將“Progressive”（逐行掃描）設定為“開”，則“電視機形式”自動設定為“16:9”。

DNR (Digital Noise Reduction)

您可以使用此設定來幫助減少畫面中的粗糙程度，並產生更清晰的影像。

<u>關</u>	不使用 DNR。
DNR1	提高畫質
DNR2	提高畫質 (最高)

提示

- “DNR2”比“DNR1”更有效降低影像粗糙程度，但在某些情況下可能會出現殘像。如果出現此種情況，請選擇“關”。
- 在某些 DVD 上，DNR 功能產生的效果可能有限。
- 當您將“Progressive”（逐行掃描）設定為“開”，則“DNR”將自動關閉，且無法打開。

輪廓強調

您可以使畫面影像的輪廓銳利或柔和。數值越高，代表輪廓愈鮮明銳利。通常選擇“0”。

• -2	• -1	• <u>0</u>	• +1	• +2
------	------	------------	------	------

提示

視 DVD 而定，輪廓強調產生的效果可能有限。

情報顯示

在播放過程中，您可以在螢幕的右上角顯示幾秒鐘播放狀態資訊。

<u>開</u>	顯示幾秒鐘播放狀態資訊。
<u>關</u>	不顯示播放狀態資訊。

Progressive (逐行掃描)

您可以通過一次刷新所有行顯示影像。在大多數情況下，此方法能產生更清晰、無閃爍的影像。此功能只有在您的電視機和 AV 連接線 * 支援逐行掃描 (480p) 時才有效。

* 影像色差連接線 (選購品) 與逐行掃描相容。

<u>開</u>	當主機連接至支援逐行掃描 (480p) 電視機時選擇此選項。
<u>關</u>	當主機連接至普通電視機時選擇此選項。

提示

- 當主機連接至無必備裝置的電視機時，如果畫質下降或未顯示影像，請將“Progressive”（逐行掃描）設定為“關”。對於此類電視機，如果您無意中將此選項設定為“開”，則畫質可能下降，或者可能不顯示影像。若要清除此設定，請按照以下步驟操作：

1 確認主機中有 DVD。

2 按主機前面的 **I/⏻** (啟動 / 預備) / RESET (再啟動) 按鈕。

然後按住控制器端子 1 中類比控制器 (DUALSHOCK®2) 的 START (開始) 按鈕不放，直至顯示 DVD 影像。“Progressive”（逐行掃描）設定返回“關”，允許正常顯示 DVD 視頻訊號。您也可以使用版本畫面中的“Progressive 設定” (↔ 第 75 頁) 取消此設定。

- DVD 可以包含使用不同幀速率的基於視頻和基於電影的素材。當使用逐行掃描播放基於視頻的素材時，有些影像可能顯得不自然。出現這種情況時，請將“Progressive”（逐行掃描）設定為“關”，並以標準隔行模式觀看。
- 當您將“Progressive”（逐行掃描）設定為“開”，則“電視機形式” (↔ 第 64 頁) 自動設定為“16:9”。
- DVD-RW 光碟 (VR 模式) 內容只能以標準隔行格式觀看。當播放此類內容時，“Progressive”（逐行掃描）選項無效。

設定個人選項

暫停模式

您可以使用此選項設定播放暫停時的影像狀態。

自動	無抖動顯示含有動態部分的影像。通常選擇此項設定。
幀	能以高解析度顯示不含動態部分的影像。

視聽年齡限制

在某些地區，觀看某些DVD內容可能受到視聽者年齡或其他因素的限制。您可利用視聽年齡限制功能來控制主機的視聽等級。

數值越低，限制越嚴格。

設定視聽年齡限制

1 選擇“視聽年齡限制”，然後按⊗按鈕。

顯示登錄密碼的畫面。如果已經登錄了密碼，則顯示確認密碼的畫面。

2 選擇一個數字，然後按⊗按鈕。

重複步驟 2 輸入一個四位數密碼。如果您想要清除一個數字，則按⊙按鈕。在登錄密碼時，將要求您再次輸入密碼進行確認。

3 選擇“地區”，然後按⊗按鈕。

顯示地區選項一覽表。

4 選擇一個地區作為視聽年齡限制等級的標準，然後按⊗按鈕。

如果您選擇“其他”，請參見“地區代碼一覽表”（→ 第 67 頁）。

5 選擇“等級”，然後按⊗按鈕。

顯示等級選項一覽表。

6 選擇一個限制等級，然後按⊗按鈕。

若要解除視聽年齡限制

在 DVD 播放停止時，進入“設定視聽年齡限制”的步驟 6，並將“等級”設定為“關”。

地區代碼一覽表

若要輸入視聽年齡限制地區代碼，在“設定視聽年齡限制”的步驟 4 中選擇“其他”（▶▶ 第 66 頁）。使用方向按鈕選擇第一個字母，然後按右方向按鈕。選擇下一個字母，然後按⊗按鈕。

地區	代碼	地區	代碼
英國	GB	中國	CN
義大利	IT	丹麥	DK
印度尼西亞	ID	德國	DE
澳大利亞	AT	日本	JP
荷蘭	NL	挪威	NO
加拿大	CA	菲律賓	PH
韓國	KR	芬蘭	FI
新加坡	SG	法國	FR
瑞士	CH	比利時	BE
瑞典	SE	香港	HK
西班牙	ES	馬來西亞	MY
泰國	TH	俄羅斯	RU
臺灣	TW		

變更密碼

在“設定視聽年齡限制”的步驟 2 中（▶▶ 第 66 頁），完成以下步驟操作：

1 使用方向按鈕，選擇“變更密碼”，然後按⊗按鈕。

顯示變更密碼的畫面。

2 選擇一個數字，然後按⊗按鈕。

重複步驟 2 輸入一個四位數密碼。要求您再輸入密碼進行確認。

播放受視聽年齡限制的光碟

1 開始播放 DVD（▶▶ 第 59 頁）。

將提示您是否要臨時變更視聽年齡限制等級，從而能允許播放。視 DVD 而定，此提示通常在光碟起動時立即出現，但也可能出現在其它時間。

2 使用方向按鈕，選擇“是”，然後按⊗按鈕。

顯示輸入密碼的畫面。

3 選擇一個數字，然後按⊗按鈕。

重複步驟 3 輸入四位數密碼。輸入密碼後，播放將重新開始。當 DVD 播放停止時，視聽年齡限制等級將返回至原設定。

提示

- 如果您忘記密碼，請閱覽快捷參考（▶▶ 第 42 頁）。
- 如果您不設定密碼，則您無法變更視聽年齡限制設定。
- 某些帶有視聽年齡限制功能的 DVD 不允許您使用播放方式（▶▶ 第 61 至 63 頁）。

設定聲音選項

聲音數碼輸出

當您將下列音響裝置連接至 DIGITAL OUT (OPTICAL) (光纖數碼輸出) 端子時，您可以切換輸出聲音信號的方法。

注意

當主機連接至無 Dolby Digital、DTS 或 MPEG 解碼器的音響裝置時，請將“Dolby Digital”、“DTS”和“MPEG”設定為“關”。如果您在沒有必要的解碼器的情況下將這些選項設定為“開”，則可能沒有聲音或可能發出非常響的噪音。

DIGITAL OUT (OPTICAL) (光纖數碼輸出)

此選項設定 DIGITAL OUT (OPTICAL) (光纖數碼輸出) 端子的輸出類型。

開	當您想要聲音 (音頻信號) 透過 DIGITAL OUT (OPTICAL) (光纖數碼輸出) 端子輸出時選擇此選項。 顯示“Dolby Digital”、“DTS”和“MPEG”設定。
關	當您不想讓聲音 (音頻信號) 透過 DIGITAL OUT (OPTICAL) (光纖數碼輸出) 端子輸出時選擇此選項。 不顯示“Dolby Digital”、“DTS”和“MPEG”設定。

Dolby Digital

此選項設定 Dolby Digital 作為 DIGITAL OUT (OPTICAL) (光纖數碼輸出) 端子的輸出信號。

開	當主機連接至帶有內建 Dolby Digital 解碼器的音響設備時選擇此選項。
關	當主機連接至沒有內建 Dolby Digital 解碼器的音響設備時選擇此選項。

DTS

此選項設定 DTS 作為 DIGITAL OUT (OPTICAL) (光纖數碼輸出) 端子的輸出信號。

開	當主機連接至帶有內建 DTS 解碼器的音響設備時選擇此選項。
關	當主機連接至沒有內建 DTS 解碼器的音響設備時選擇此選項。

MPEG

此選項設定 MPEG AUDIO 作為 DIGITAL OUT (OPTICAL) (光纖數碼輸出) 端子的輸出信號。

開	當主機連接至帶有內建 MPEG 解碼器的音響設備時選擇此選項。
關	當主機連接至沒有內建 MPEG 解碼器的音響設備時選擇此選項。

聲音軌跡自動選擇模式

當您播放錄製了多種音頻格式 (PCM, Dolby Digital, DTS 或 MPEG) 的 DVD 時, 此設定把優先權給予含有聲道數量最多的音頻軌跡。如果 PCM、Dolby Digital、DTS 和 MPEG 具有相同數量的聲道, 則主機將按照 PCM、Dolby Digital、DTS 和 MPEG 音頻軌跡順序進行選擇。

開	優先選擇
關	不需優先選擇

提示

- 如果在“聲音數碼輸出”中將“DTS”設定為“關”(▶▶ 第 68 頁)則不播放 DTS 音頻軌跡。
- 視 DVD 而定, 具有優先權的音頻聲道可能被預先確定。在此情況下, 將按照 DVD 的優先順序選擇音頻軌跡。

DVD 音量

如果 DVD 的音頻輸出音量較低, 則您可以設定此選項。只有當“聲音數碼輸出”中“DIGITAL OUT (OPTICAL)”(光纖數碼輸出)設定為“關”(▶▶ 第 68 頁)時, 您才可以設定此選項。

+2	調高音量 (最高)
+1	調高音量
標準	通常選擇此選項。

注意

如果您將此選項設定為“+1”或“+2”, 則聲音可能失真。如果發生此情況, 請將設定變更為“標準”。另外請注意, 如果您將音量設定過高, 則可能會傷害您的聽力或損壞揚聲器。

顯示主選單

您可以從主選單訪問資訊和變更各種設定。您可以從主選單進入以下畫面。當打開主機而不插入光碟時將顯示主選單。

- 瀏覽器畫面 (→ 第 70 頁)
- 系統設定選單 (→ 第 71 頁)
- 版本畫面 (→ 第 74 頁)

1 打開主機 (→ 第 48 頁)。

顯示主選單。請注意，顯示主選單可能需要一些時間。

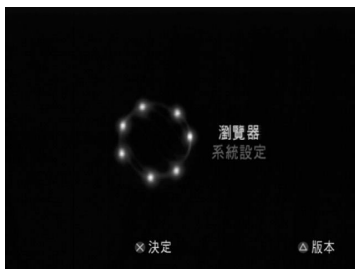

提示

如果打開插有光碟的主機，則將不顯示主選單。若要顯示主選單，則按主機前面的  (打開) 按鈕將光碟取出。然後按 **I/⏻** (啓動 / 預備) / RESET (再啟動) 按鈕重新啟動主機。

瀏覽器畫面

您可以從瀏覽器畫面進行下列操作：

- 拷貝或刪除 Memory Card (記憶卡) 中儲存的遊戲資料
- 開始遊戲
- 開始播放音頻 CD
- 開始 DVD 播放

1 顯示主選單 (→ 第 70 頁)。

2 使用方向按鈕，選擇“瀏覽器”，然後按  按鈕。顯示瀏覽器畫面。

3 插入光碟或 Memory Card (記憶卡)。
瀏覽器畫面中顯示所插入對象的圖示。



4 選擇一個圖示，然後按⊗按鈕。

- 當您選擇 Memory Card (記憶卡) 圖示時，將顯示 Memory Card (記憶卡) 中儲存的資料圖示。如要拷貝或刪除遊戲儲存資料，請參見“拷貝或刪除遊戲資料”(▶▶ 第 54 頁)。
- 如果選擇 PlayStation®2 或 PlayStation® 規格之軟件光碟，則遊戲將開始。
- 當您選擇音頻 CD 光碟圖示，則將顯示 CD 中所包含的曲目。請參見“播放音樂 CD”(▶▶ 第 55 頁)。
- 如果您選擇 DVD 光碟圖示，則將開始播放 DVD。

提示

當主機中未插入 Memory Card (記憶卡) 或光碟，則瀏覽器畫面中將顯示“找不到資料”信息。

使用系統設定選單

您可以從系統設定選單變更許多選項的設定，包括語言或時間顯示，以及音頻或視頻的輸出方法。

1 顯示主選單 (▶▶ 第 70 頁)。

2 使用方向按鈕，選擇“系統設定”，然後按⊗按鈕。 顯示系統設定選單。



3 選擇一個項目，然後按⊗按鈕。

選單項目變為有效，並能被選擇。

4 選擇想要的設定，然後按⊗按鈕。

詳細說明，請參見每個選單項目的說明 (▶▶ 第 72 至 73 頁)。

提示

- 每個選單項目的預設設定在以下說明中用底線表示。
- 對每項設定的變更將被儲存，即使關閉主機或重新啟動主機，設定仍保持有效。

調整時鐘

您可以設定日期和時間。使用方向按鈕設定“年”、“月”、“日”、“小時”、“分鐘”和“秒”。當您按(⊗)按鈕時，設定生效。

可選設定

如果您在“調整時鐘”畫面時按(△)按鈕，則您可以設定“日期顯示方式”或“時間顯示方式”等選項。使用方向按鈕和(⊗)按鈕進行每項設定。

時間顯示方式	將系統時鐘設定為12小時或24小時時鐘顯示方式。
日期顯示方式	設定年、月和日的顯示順序。
時區	設定時區設定。
設定夏令時間	設定標準或夏令時間。通常選擇“標準時間”。

螢幕尺寸

您可以設定電視機的顯示方式。

4:3	當主機配合普通電視機使用時選擇此選項。
全畫面 *	當主機配合普通電視機使用時選擇此選項。螢幕上部和下部的黑邊被切除。
16:9	當使用寬螢幕電視機或具有特定 16:9/ 寬螢幕功能普通電視機時選擇此選項。

* “全畫面”顯示方式與系統設定選單、瀏覽器畫面和音頻 CD 畫面相容。

DIGITAL OUT (OPTICAL) (光纖數碼輸出)

您可以設定是否透過 DIGITAL OUT (OPTICAL) (光纖數碼輸出) 端子輸出信號。

開	當您想要透過 DIGITAL OUT (OPTICAL) (光纖數碼輸出) 端子輸出聲音 (音頻信號) 時選擇此選項。
關	當您不想透過 DIGITAL OUT (OPTICAL) (光纖數碼輸出) 端子輸出聲音 (音頻信號) 時選擇此選項。

影像色差輸出

當使用影像色差連接線（選購品）時，您必須設定方式以適合電視機上的輸入插孔。

Y Cb/Pb Cr/Pr	當主機連接至影像色差輸入端子時選擇此項。
RGB	當主機連接至 RGB 輸入端子時選擇此項。

提示

“RGB”設定僅適合 PlayStation®2 和 PlayStation® 規格之軟件。當您觀看 DVD 時，方式自動切換至“Y Cb/Pb Cr/Pr”。

遙控器

當使用 PlayStation®2 專用 DVD 遙控器（選購品）時選擇此選項。

遊戲操作功能 開	當用 DVD 遙控器操作 PlayStation®2 或 PlayStation® 規格之軟件時選擇此選項。
遊戲操作功能 關	當不使用 DVD 遙控器操作 PlayStation®2 或 PlayStation® 規格之軟件時選擇此選項。

提示

當此選項設定為“遊戲操作功能 開”使用 DVD 遙控器時，將套用以下限制：

- 視軟件而定，某些遙控按鈕可能無法正常工作。
- 當同時按兩個或多個按鈕時，DVD 遙控器的按鈕將不起作用。
- 當從控制器端子 1 拔掉控制器時，某些軟件標題可能停止正常運作。若出現這種情況，請設定至“遊戲操作功能 關”。

顯示語言

您可以使用此選項選擇主選單、瀏覽器畫面、系統設定選單和版本資訊畫面上顯示的語言。

繁體中文	以繁體中文顯示信息（SCPH-90007 的預設設定）
英文	以英文顯示信息（SCPH-90006 的預設設定）

版本資訊畫面

通過選擇此選項，您可以確認各主機部件的版本資訊。您也可以變更某些項目的可選設定。

1 在主選單 (→ 第 70 頁) 畫面上按 **△** 按鈕。

顯示版本資訊畫面。

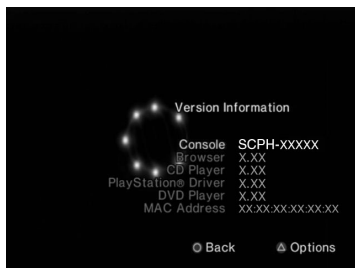

可選設定

可選設定可用於“主機”、“PlayStation® 驅動程式”和“DVD 播放裝置”。只有當 DVD 播放裝置的“Progressive”（逐行掃描）選像設定為“開”時，才能設定“DVD 播放裝置”。

1 使用方向按鈕，選擇一個項目，然後按 **△** 按鈕。

顯示此項目的當前設定。

2 選擇一個項目，然後按 **×** 按鈕。

顯示有效選項。

3 選擇想要的設定，然後按 **×** 按鈕。

詳細說明，請參見每個項目的說明 (→ 第 74 至 76 頁)。

提示

每個選單項目的預設設定在以下說明中用底線表示。

主機

PlayStation®2 主機自動調節其進行最佳播放的內部設定。當“自動診斷”設定為“開”時，主機將進行附加調整。

自動診斷

<u>關</u>	自動診斷被關閉。
開	自動診斷開啓。

提示

在下列情況下，“自動診斷”設定將自動返回預設設定：

- 當開始播放 PlayStation®2 或 PlayStation® 規格之軟件或 DVD 時
- 主機重新啟動時
- 主機關閉時

PlayStation® 驅動程式

您可以將 PlayStation® 驅動程式設定至 PlayStation® 規格之軟件的最佳性能。

提示

在下列情況下，此設定將自動返回預設設定：

- 主機關閉時

光碟讀取速度

標準	以正常速度載入光碟
高速	以高速度載入光碟

提示

在下列情況中設定至“標準”：

- 當高速載入未產生更好的效果時
- 當使用與高速載入不相容的軟件時

材質貼圖

標準	正常顯示
平滑補正	以降低畫面顯示影像的銳利度顯示

提示

在下列情況中設定至“標準”：

- 當平滑補正材質貼圖未產生更好的效果時
- 當設定至“平滑補正”時，如果未正確顯示影像

DVD 播放裝置

當主機連接至無必要裝置的電視機時，如果您將“Progressive”（逐行掃描）設定至“開”，畫質可能將低，或可能不顯示影像。您可以通過以下過程解除“Progressive”（逐行掃描）設定。

解除設定前取出 DVD。

Progressive 設定

不解除	保持“Progressive”（逐行掃描）設定開啓
解除	解除“Progressive”（逐行掃描）設定

- 1 顯示版本資訊畫面。
- 2 使用方向按鈕，選擇“DVD 播放裝置”，然後按△按鈕。
顯示“Progressive 設定”選項。
- 3 按⊗按鈕。
- 4 選擇“解除”，然後按⊗按鈕。
- 5 按兩次⊙按鈕。
顯示返回主選單。
- 6 按主機前面的⊞（打開）按鈕，然後將 DVD 裝入主機。
- 7 關閉光碟蓋。
播放開始。

提示

在以下情況中，設定將不解除：1) 步驟 4 後不開始播放 DVD，2) 步驟 6 之前您重新啟動或關閉主機。

連接網路

通過將 PlayStation®2 主機連接至網路，您可以享受到線上遊戲的樂趣。若要玩線上遊戲，則您需要以下條件：

- 網路相容 PlayStation®2 遊戲
- 寬頻上網服務
- 市售的乙太網路連接線
- PlayStation®2 專用 Memory Card（記憶卡）（8MB）（選購品）

提示

- 在本主機上使用撥號或 ISDN 連接，您無法玩線上遊戲。
- 有兩種類型的乙太網路連接線：直通連接電纜和交叉連接電纜。詳細說明，請參閱網路設備附帶的使用說明書。

用乙太網路連接線連接

您可以使用連接在主機背面 NETWORK（網路）接口上的乙太網路連接線，將主機連接至網路。您可以連接至 100 Base-TX 或 10 Base-T 網路。詳細說明，請參閱網路設備附帶的使用說明書。

基本網路設定

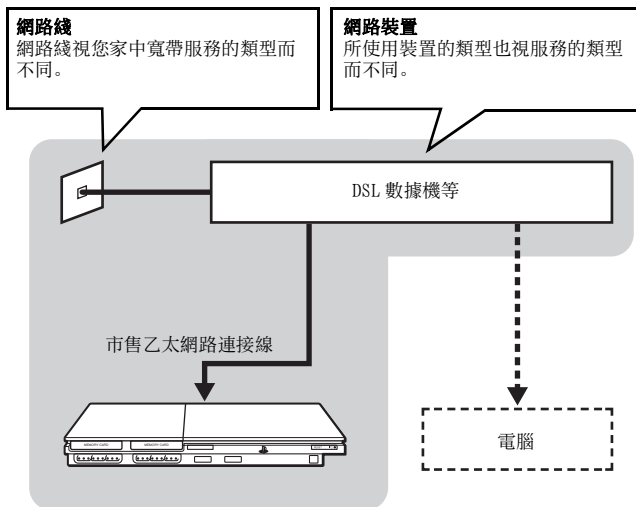

提示

當主機和電腦連接至網路時，可能需要路由器或集線器等設備。詳細說明，請參閱網路設備附帶的使用說明書。

⚠ 警告

在完成所有其它連接之前，切勿將主機交流電源線插頭插入電源插座。

1 將乙太網路連接線連接至主機背面的 NETWORK（網路）接口。

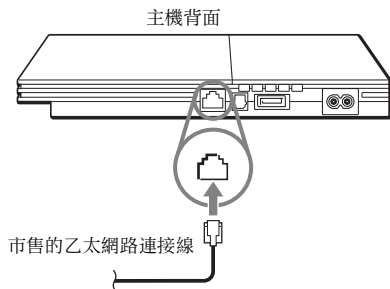

2 將乙太網路連接線上的端子插入網路設備。

連接方法視網路設備而異。詳細說明，請參閱網路設備附帶的使用說明書。

⚠ 警告

切勿將以下類型的乙太網路連接線或電話線連接至網路端子；可能有太大的電流通過連接端子，從而引起故障，連接端子內過熱或起火。

- 不適合與 10Base-T/100Base-TX 網路一起使用的乙太網路連接線
- 標準住宅電話線
- 任何 ISDN（數碼）相容電話或資料線
- PBX 電話線
- 其他“不明”類型的電話線

新建網路設定

在將乙太網路連接線連接至主機後，您將需要創建並儲存網路設定。實際的網路設定可能視正在玩的線上遊戲而變化。詳細說明，請參閱該軟件附帶的使用說明書。

所需物件

若要創建網路設定，您將需要以下物件：

- PlayStation®2 專用 Memory Card（記憶卡）（8MB）（選購品）
- 由網際網路服務供應商提供的登入和網路設定資訊

提示

視您所使用的網際網路服務類型而定，您可能需要提供您的 MAC 位址。您可以在版本資訊畫面中找到您主機的 MAC 位址（▶▶ 第 74 頁）。

本公司保留在不予通知情況下，變更設定或規格之權利。

一般規格

電源要求	AC220-240V 50Hz (SCPH-90006) AC110V 50/60Hz (SCPH-90007)
耗電量 (大約)	35 W
主機尺寸 (大約)	230 × 28 × 152 mm / 9 × 1 × 6 in (寬 / 高 / 深)
主機質量 (大約)	720 g
信號格式	NTSC
操作溫度	5° C 至 35° C / 41° F 至 95° F
主機前面的輸入 / 輸出	控制器端子 (2) MEMORY CARD (記憶卡) 插口 (2) ⚡ USB 連接埠 (2)
主機背面的輸入 / 輸出	NETWORK (網路) 接口 交流電源輸入端子 AV MULTI OUT (AV 多重輸出) 端子 DIGITAL OUT (OPTICAL) (光纖數碼輸出) 端子

附屬品

請參閱快捷參考 (→ 第 42 頁)。

關於國家出口控制

本產品可能因各國立法之規定而被列為限制出口商品。請嚴格遵守相關法條及任何與本產品之管轄權有關之法律規定。



關於存取控制

本產品並入了存取控制技術。對於使用非專為本產品設計的軟件 (DVD-Video 和音頻 CD 除外) 和使用本產品專用軟件的拷貝版將受到存取控制技術的阻止。未經許可的傳遞、轉讓、顯示、出口、進口或程式、設備的傳輸，或用程式或設備修改本產品，以廢除存取控制功能的作用將受到或可能受到法律的禁止。

SONY



COMPUTER
ENTERTAINMENT ©

"", "PlayStation", "PS2", "DUALSHOCK" and "" are registered trademarks of Sony Computer Entertainment Inc.

"SONY" and "" are registered trademarks and "MagicGate" is a trademark of Sony Corporation.

"", "PlayStation", "PS2", "DUALSHOCK" 和 "" 為 Sony Computer Entertainment Inc. 之註冊商標。

"SONY" 和 "" 為 Sony Corporation 之註冊商標。"MagicGate" 亦為該公司之商標。

Free Manuals Download Website

<http://myh66.com>

<http://usermanuals.us>

<http://www.somanuals.com>

<http://www.4manuals.cc>

<http://www.manual-lib.com>

<http://www.404manual.com>

<http://www.luxmanual.com>

<http://aubethermostatmanual.com>

Golf course search by state

<http://golfingnear.com>

Email search by domain

<http://emailbydomain.com>

Auto manuals search

<http://auto.somanuals.com>

TV manuals search

<http://tv.somanuals.com>