



PlayStation®2



Instruction Manual

Thank you for purchasing the PlayStation®2 computer entertainment system.

You can play PlayStation®2 format CD-ROM and DVD-ROM discs, PlayStation® format CD-ROM discs, audio CDs and DVD video discs with this system.

Before operating this console, please read this manual carefully and retain it for future reference.

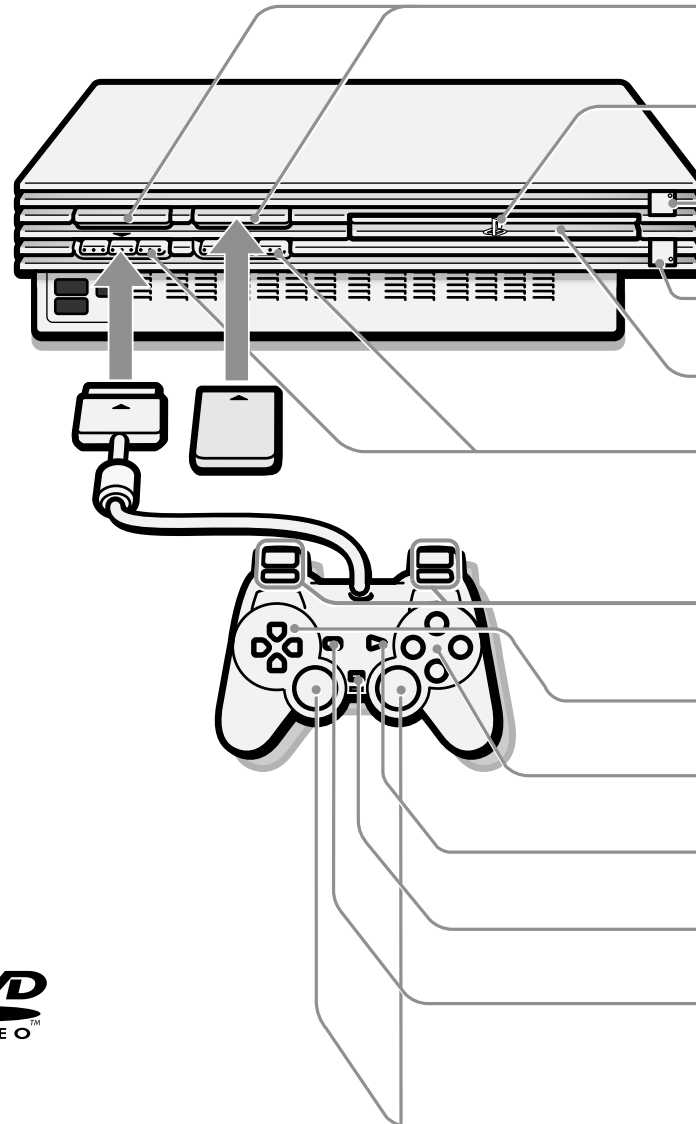

- MEMORY CARD slots
- "PS" product family logo
- (standby) /RESET button and indicator
- (open) button and indicator
- Disc tray
- Controller ports
- L2 button, R2 button, L1 button, R1 button
- Directional buttons
- △, ○, ×, □ buttons
- START button
- ANALOG mode button
- SELECT button
- Left analog stick, right analog stick, L3 button, R3 button



SCPH-39002



WARNING

To prevent fire or shock hazard, do not expose the console to rain or moisture.

To prevent fire or shock hazard, do not place a container filled with liquids on top of the console.

To avoid electrical shock, do not open the cabinet. Refer servicing to qualified personnel only.

Caution

The use of optical instruments with this product will increase eye hazard. As the laser beam used in this unit is harmful to eyes, do not attempt to disassemble the cabinet.

Refer servicing to qualified personnel only.

Read carefully before operating your PlayStation®2 console

A few people may experience epileptic seizures when viewing flashing lights or patterns in our daily environment. These persons may experience seizures while watching TV or playing video games, including DVD videos or games played on the PlayStation®2 console. Players who have not had any seizures may nonetheless have an undetected epileptic condition. Consult your physician before operating the PlayStation®2 console if you have an epileptic condition or experience any of the following symptoms while watching TV programs or playing video games: altered vision, muscle twitching, other involuntary movements, loss of awareness of your surroundings, mental confusion, and/or convulsions.

CLASS 1 LASER PRODUCT
LASER KLASSE 1
LUOKAN 1 LASERLAITE
KLASS 1 LASERAPPARAT

This appliance is classified as a CLASS 1 LASER product.



This label is located on the protective housing of the CD/DVD unit inside the enclosure.

Precautions

Do not expose the console to cigarette smoke or dust

When setting up the console, avoid places subject to excessive cigarette smoke or dust. Cigarette smoke residue or dust build-up on internal components such as the lens, may cause the console to malfunction.

Disc handling

- Do not leave discs near a heat source, in direct sunlight, or in high humidity.
- Store discs in their cases when they are not being used. Stacking discs or standing them at an angle without putting them in their cases can cause the discs to warp.
- Do not touch the disc surface when handling a disc; hold it by the edges.
- Do not stick paper or tape onto the disc.
- Do not write on the disc with a marker, etc.
- Fingerprints or dust on the disc can distort the picture or reduce sound quality. Make sure discs are always clean before use.
- Clean discs using a soft cloth, lightly wiping from the centre outwards.
- Do not use solvents such as benzene, commercially available cleaners not intended for CD use or anti-static spray intended for vinyl LPs since these can damage the disc.

Do not place the console in an unusually hot location

Do not leave the console in a car with its windows closed (particularly in summer) as this may warp the exterior of the console or cause the console to malfunction.

Moisture condensation

If the console or the disc is brought directly from a cold location to a warm one, moisture may condense on the lens inside the console or on the disc. Should this occur, the console may not operate properly. In this case, remove the disc and do not put the disc back in until the moisture evaporates. (This could take several hours.) If the console still does not operate properly, please contact the appropriate PlayStation® customer service helpline which can be found:

- on the customer registration card;
- within every PlayStation® and PlayStation®2 format software manual.

Do not subject the console to violent physical shock

Do not throw or drop the console or its accessories, and do not knock the console or its accessories against other objects. When carrying the console, do not subject it to any type of violent physical shock. This may damage the disc or cause the console to malfunction.

Avoid damaging the exterior of the console

Do not apply any solvents, and do not place any rubber or vinyl materials on the surface of the console for an extended period of time. Doing so may damage the plastic surface or cause the paint to peel off.

Cleaning the exterior of the console

When cleaning the exterior of the console, be sure to turn the power off with the MAIN POWER switch on the back of the console and disconnect the AC power plug from the electrical socket.



- If the exterior of the console becomes dirty, soak a soft cloth in a mild detergent solution diluted with water, tightly squeeze the cloth to remove the excess liquid, wipe the affected area of the exterior and finish by wiping with a dry cloth.
- Do not use benzene or paint thinner to clean the exterior of the console since these may damage the surface or cause the paint to peel off. When using a chemically-treated dust cloth, follow the usage instructions supplied with it.
- Dust can accumulate in both the front and rear vents of the console. Check the vents from time to time and remove any accumulated dust with a handheld or low powered vacuum cleaner.



Never disassemble the console

- Use your PlayStation®2 computer entertainment system according to the instructions in this manual. No authorisation for the analysis or modification of the PlayStation®2 console, nor the analysis and use of its circuit configurations, is given.
- There are no user-serviceable components inside the PlayStation®2 console. Disassembling it will void the guarantee. Additionally, there is a risk of exposure to (laser) radiation as well as to electrical shock hazards.

Notes on safety when using the Analog Controller (DUALSHOCK®2) and Analog Controller (DUALSHOCK®)

- Stop using the console immediately if you begin to feel tired or if you experience an unpleasant sensation or pain in your hands and/or arms while operating the controller. If the condition persists, consult a doctor.
- Do not attempt to operate the controller in any way except with your hands. Do not bring the controller into close contact with your head, face or near the bones of any other part of your body.
- The vibration function of the Analog Controller (DUALSHOCK®2) or the Analog Controller (DUALSHOCK®) can aggravate injuries. Do not use the vibration function of the Analog Controller (DUALSHOCK®2) and Analog Controller (DUALSHOCK®) supported by software if you have any ailment in the bones or joints of your hands or arms.
- Do not use the Analog Controller (DUALSHOCK®2) or the Analog Controller (DUALSHOCK®) with software that supports the vibration function if you have injuries or ailments to the bones or muscles of your fingers, hands, wrists or arms. The vibration of the controller may aggravate such conditions.
- Avoid prolonged use of the Analog Controller (DUALSHOCK®2) and Analog Controller (DUALSHOCK®). Take a break at about 30 minute intervals.

	PlayStation®2 format DVD-ROM	PlayStation®2 format CD-ROM	PlayStation® format CD-ROM
Disc logo	“PS”, PlayStation®2 logo and  designation	“PS”, PlayStation®2 logo and  designation	PlayStation® logo and  designation
Disc colour	Silver	Blue	Black
Contents	Audio and video		
Disc size	12 cm		



	Audio CDs		DVD videos	
Disc logo			 The “DVD VIDEO” logo is a trademark.	
Contents	Audio		Audio and video	
Disc size	12 cm	8 cm ^{*1} (CD single)	12 cm	8 cm ^{*2}
Play time	74 min ^{*3}	20 min ^{*3}	About 4 hrs (single-sided) / about 8 hrs (double-sided)	About 80 min (single-sided) / about 160 min (double-sided)

*1 When you position the console vertically and play an 8 cm audio CD, be sure to use an optional adaptor.

*2 When playing an 8 cm DVD, always place the console in the horizontal position.

*3 Play time varies depending on the audio CD.

DVD video systems and regional restrictions

- This console conforms to the PAL broadcast standard. You cannot play discs recorded for other broadcast standards (such as NTSC) on this console (unless the NTSC disc displays the  label and an NTSC compatible TV is used).
- Some DVD videos are marked with region numbers such as . The number contained within the symbol represents the region number of DVD players on which the disc can be played. DVD videos that do not bear this symbol, or that do not display the number 4 cannot be played on your console.
- DVDs with the  label can also be played on this console.

If you attempt to play any other DVDs, a message stating “This disc cannot be played due to regional restrictions.” will appear on the screen.





- Some DVDs that have no region code markings may still be subject to area restrictions and may not be playable on the console.

Note on playback operations of DVDs

This console plays DVD video as originally designed by the software producers. Some of the playback features of this console may not have been incorporated into the DVD video design. As a result, some playback features may not be available with certain DVD videos. Please refer to the instructions supplied with your DVD video for details.

Specially-shaped discs

Do not use irregularly-shaped CDs (for example, heart- or star-shaped CDs) as they may cause the console to malfunction.

	WARNING	2
	Precautions	2
	Getting started	3
	Discs that can be played on PlayStation®2	3
	Checking the package contents	4
	Positioning the console	4
	Connecting your PlayStation®2 to a TV set	5
	Connecting digital audio equipment	6
	Connecting other digital devices	6
	Using the Main menu	7
	Playing a game	8
	Using the Analog Controller	9
	Using Memory Cards	10
	Playing an audio CD	10
	Playing a DVD video	11
	Using various functions with the Control Panel	12
	Settings and adjustments for the DVD Player	15
	Troubleshooting	19
	Specifications	20
	Glossary	21
	GUARANTEE	21



Check that you have the following items:

- Console

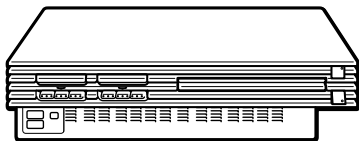

- Analog Controller (DUALSHOCK®2)

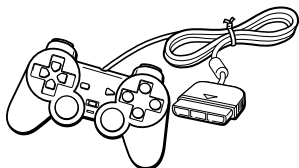

- Instruction manual

- AC power cord

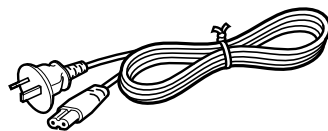

- AV Cable (integrated audio/video)

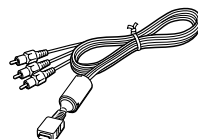

You can position the console either horizontally or vertically.

When positioning the console vertically, use the SCPH-10040 E Vertical Stand (for PlayStation®2) (sold separately).

When positioning the console horizontally, you can use the SCPH-10110 E Horizontal Stand (for PlayStation®2) (sold separately).



Horizontal positioning

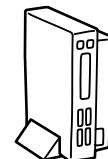

Vertical positioning

Notes

- Do not place the console in a position other than a horizontal or vertical one, as doing so may damage it.
- Do not change the position of the console (from horizontal to vertical or vice versa) while it is in operation. Doing so may damage the disc or cause the console to malfunction.

The "PS" product family logo located on the disc tray

The "PS" product family logo on the disc tray can be rotated to match the horizontal or vertical positioning of the console.

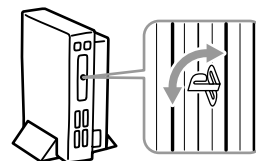

This section explains the connecting method for listening to sound through your TV speakers. If you wish to connect to audio equipment with digital connectors, see "Connecting digital audio equipment" on page 6.

Connecting to a TV with audio/video input

Connect your PlayStation®2 computer entertainment system to the TV using the supplied AV Cable (integrated audio/video).

When connecting the cords, be sure to match the colour-coded cords to the appropriate jacks on the equipment: yellow (video) to yellow, red (right audio) to red and white (left audio) to white.

After connecting

Set your TV to the appropriate video input mode. Refer to the instruction manual for your TV.

When connecting to a wide-screen TV (16:9 aspect ratio)

Set "Screen Size" in the System Configuration menu to "16:9." For details on the System Configuration menu, see page 7.

If your TV is monaural

Do not connect the red plug. If you want to hear both left and right sounds from a monaural TV, use a commercially available dual phono to single phono (stereo to monaural) type audio cable (sold separately).

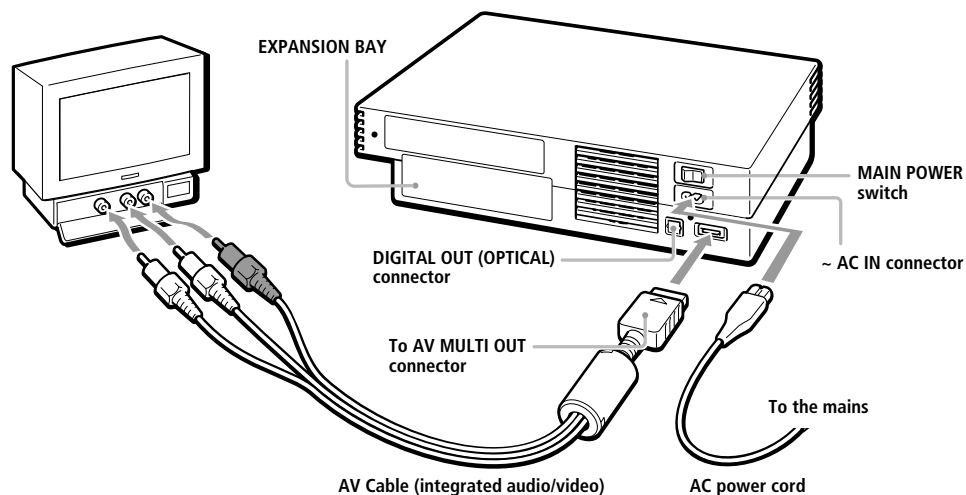

Static image caution

Static, non-moving images, such as DVD menus, configuration displays or paused images may leave a faint image permanently on the TV screen if left on for extended periods of time.

Projection TVs are more susceptible to this than other types of displays. Do not operate the console in such a manner that this could occur.

Note about bouncing effect

Some TVs or monitors may experience a bouncing effect in their pictures when using the PlayStation®2 console. There is nothing wrong with the PlayStation®2 console or the way it is manufactured. The problem technically lies within the television. If you encounter such a problem with your television/monitor, please contact the appropriate PlayStation® customer service helpline which can be found:

- on the customer registration card;
- within every PlayStation® and PlayStation®2 format software manual.

Connecting to a VCR

Connect your PlayStation®2 console to your VCR using the supplied AV Cable (integrated audio/video) matching the plug colours to the jacks on the VCR.

If your VCR is monaural, do not connect the red plug.

However, when playing a DVD video, do not connect the console to a VCR. If you do, picture quality may be reduced. Connect the console directly to the TV.

After connecting

Set your TV and VCR adjustments appropriately. Refer to the instruction manuals for your TV and VCR.

When playing a DVD video

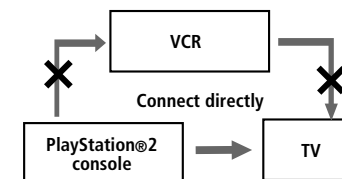

Connecting to a TV with an S VIDEO input connector

Connect your PlayStation®2 console to the S VIDEO input connector on the TV using the SCPH-10060 E S VIDEO Cable (sold separately) for a higher quality picture than that using an AV cable (integrated audio/video).

After connecting

Set your TV to the appropriate video input mode (such as "S VIDEO").

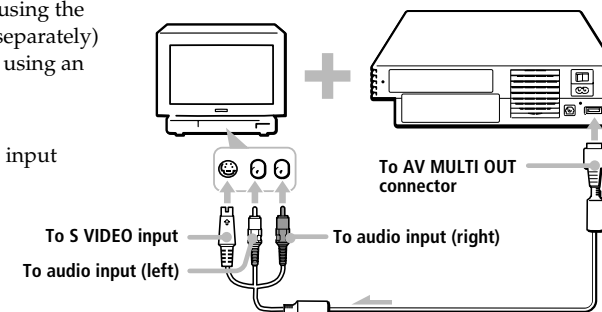

When turning on the console for the first time

The initial setup screen appears.

Set "Language," "Time Zone" and "Daylight Savings Time (Summer Time)" according to the instructions on the screen.

Settings can be adjusted later in the System Configuration menu. For details, see "Using the System Configuration menu" on page 7.

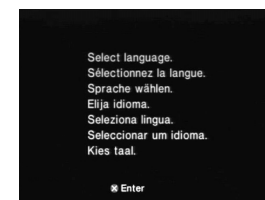

This section explains how to connect your PlayStation®2 console to audio equipment with digital connectors (such as Dolby Digital optical (AC-3) output). Using digital receivers and amplifiers, you can enjoy features such as multi-channel sound and surround sound.

Connecting to a receiver or amplifier, "MD (Minidisc)" deck or "DAT (Digital Audio Tape)" deck with a digital connector

Hook up a commercially available optical digital cable to your audio equipment. In the System Configuration menu, set the "DIGITAL OUT (OPTICAL)" setting to "On." This is the default setting. For details on the System Configuration menu, see page 7.

Rear panel

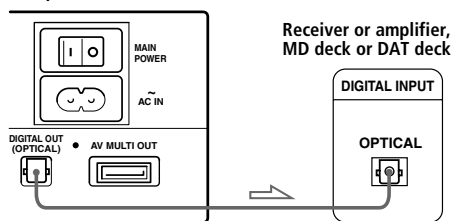

Notes

- Refer also to the instructions supplied with the equipment to be connected.
- You cannot directly make digital audio recordings of discs recorded in Dolby Digital, DTS or MPEG AUDIO format using an MD or a DAT deck.

Connecting to audio equipment with a built-in DTS*, Dolby Digital** or MPEG decoder (DVD video only)

By connecting to audio equipment with a built-in DTS, Dolby Digital or MPEG decoder (sold separately), you can playback sound recorded on your DVD video in Dolby Digital (AC-3), DTS or MPEG AUDIO format to reproduce the effect of listening in a movie theatre or concert hall.

Connect the equipment via the DIGITAL OUT (OPTICAL) connector using an optical digital cable (sold separately).

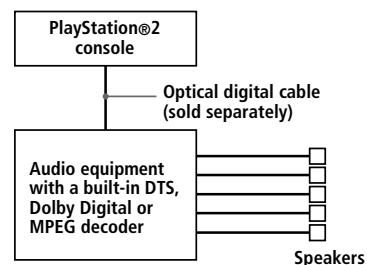

Setups for the DVD player on your PlayStation®2 console

Some setup adjustments are necessary for the DVD player depending on the equipment to be connected.

For details on using the Setup display, see page 15.

- When you connect audio equipment with a built-in DTS decoder**
Set "DIGITAL OUT (OPTICAL)" to "On" and then set "DTS" to "On" in the "Audio Setup" display.
- When you connect audio equipment with a built-in Dolby Digital decoder**
Set "DIGITAL OUT (OPTICAL)" to "On" and then set "Dolby Digital" to "On" in the "Audio Setup" display.
- When you connect audio equipment with a built-in MPEG decoder**
Set "DIGITAL OUT (OPTICAL)" to "On" and then set "MPEG" to "On" in the "Audio Setup" display.

Note

Refer to the operating and setup instructions for the audio equipment to be connected.

* "DTS" and "DTS Digital Out" are trademarks of Digital Theater Systems, Inc.

** Manufactured under license from Dolby Laboratories. "Dolby" and the double-D symbol are trademarks of Dolby Laboratories. Confidential unpublished works. © 1992-1997 Dolby Laboratories. All rights reserved.

Connecting a device using the Universal Serial Bus (USB) interface

The two USB connectors on the front of the console can be used to connect USB-compatible devices. Also refer to the instructions supplied with the device to be connected.

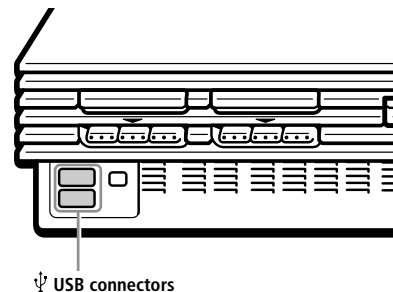

Note

Not all USB-compatible products work with the PlayStation®2 computer entertainment system. See the appropriate USB-compatible product's user manual for more information.

Connecting a device using the i.LINK interface

The S400 i.LINK connector on the front of the console can be used to connect an i.LINK-compatible (IEEE 1394) device. Refer also to the instructions supplied with the device to be connected.

The S400 i.LINK connector does not supply power to external devices. Some external devices that require power from the S400 i.LINK connector will not function properly when connected to your PlayStation®2 console.

The PlayStation®2 S400 i.LINK connector on your console supports transfer rates up to 400 Mbps. However, the transfer rate will vary, depending upon the actual transfer rate of the connected i.LINK-compatible device.

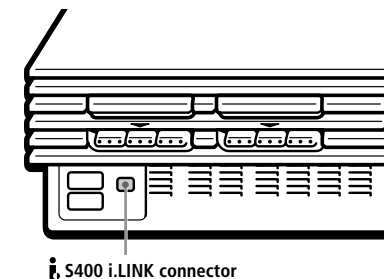

Note

Not all i.LINK products work with the PlayStation®2 computer entertainment system. Refer also to the appropriate i.LINK product's user manual for more information.

i.LINK is a trademarked version of the IEEE 1394-1995 standard and its revisions.

i.LINK and the i.LINK logo "i" are trademarks.

When turning on the console without first inserting a disc, the Main menu appears on the TV screen.

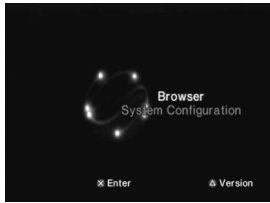

You can move to the System Configuration menu or the browser screen from the Main menu.

Using the System Configuration menu

Using the System Configuration menu, you can access the system setup for your PlayStation®2 console. These settings are saved even if you turn off the console.

- Select "System Configuration" using the up and down directional buttons and press the X button. The System Configuration menu appears on the TV screen.
- Select the item you want using the up and down directional buttons and press the X button.

The default settings are underlined.

■ Clock Adjustment

Sets the clock.

- Use the up and down directional buttons to set the day and then press the right directional button. Use the same method to set the month, year, hour, minute and second. To return to the previous menu, press the left directional button.

- Press the X button in time with an accurate clock.

You can select optional settings for the clock

Select "Clock Adjustment" using the up and down directional buttons and press the Δ button. You can set the optional items.

Time Format

- 24 hour clock
- 12 hour clock

Date Format

- DD/MM/YYYY
- YYYY/MM/DD
- MM/DD/YYYY

Time Zone

Select your country or region to set the time zone.

Daylight Savings Time (Summer Time)

Set this item to "Daylight Savings Time (Summer Time)" when the daylight savings time is in effect.

- Standard (Winter Time)
- Daylight Savings (Summer Time)

■ Screen Size

Selects the display mode according to the TV to be connected.

- 4:3 : select this when you connect a standard TV to the console.
- Full : select this when you connect a standard TV to the console. The black margins on the upper and lower portions of the screen are cut off.
- 16:9 : select this when you connect a wide-screen TV, or a TV that displays in wide mode to the console.

■ DIGITAL OUT (OPTICAL)

Selects whether to output signal via the DIGITAL OUT (OPTICAL) connector.

- On : select this when you connect with an optical digital cable (sold separately). Normally select this option.
- Off : select this when you do not want sound signal to be output via the DIGITAL OUT (OPTICAL) connector.

■ Component Video Out

If your TV, monitor or projector has an RGB input connector or component video input connectors (Y, Cb/Pb, Cr/Pr) that conform to the output signals of the console, set this item. When connecting the console using the supplied AV Cable (integrated audio/video) or S VIDEO Cable (sold separately), you do not need to set this item.

- Y Cb/Pb Cr/Pr : select this when you connect the console to the component video input connectors on your TV.
- RGB : select this when you connect the console to the RGB input connector on your TV.

Note

You can output PlayStation® and PlayStation®2 format software in either RGB or Y Cb/Pb Cr/Pr format. However, the PlayStation®2 console has been designed to override the "Component Video Out" setting in the System Configuration menu and output all DVD video software in Y Cb/Pb Cr/Pr. The colour is disturbed when you set this item to "RGB" and play the DVD.

■ Language

Selects the language for the on-screen display.

- English
- French
- Spanish
- German
- Italian
- Dutch
- Portuguese

Using the browser screen

You can do the following operations using the browser screen.

- Checking/copying/deleting game data on a Memory Card (8MB) (for PlayStation®2) or Memory Card
- Starting PlayStation® or PlayStation®2 format software
- Playing an audio CD
- Playing a DVD video

Select "Browser" using the up and down directional buttons and press the X button. The browser screen appears on the TV screen. The Memory Card (8MB) (for PlayStation®2), Memory Card or discs inserted in the console are displayed as icons.

Checking/copying/deleting game data

You can copy game data from one Memory Card (8MB) (for PlayStation®2) or Memory Card to another or delete data you no longer wish to keep.

You cannot, however, copy game data of the PlayStation®2 format software to the SCPH-1020 E Memory Card.

Insert the Memory Card (8MB) (for PlayStation®2) or Memory Card in advance.

- Select the icon of the Memory Card (8MB) (for PlayStation®2) or Memory Card where the game data you want to check/copy/delete is saved, and then press the X button.
- Check/copy/delete game data according to the instructions on the screen.

Note

While copying or deleting game data, do not remove the Memory Card (8MB) (for PlayStation®2) or Memory Card.

Checking version information

You can check the version of the console, browser, CD player, PlayStation® Driver and DVD player.

Press the Δ button in the Main menu.

Auto-diagnosis function

The PlayStation®2 console automatically adjusts console settings for best possible disc playback. However, you can also manually start the auto-diagnosis feature whenever necessary.

- Select "Console" using the up and down directional buttons and press the Δ button.
- Select "On" using the up and down directional buttons and press the X button.
- Insert a disc. The console automatically starts the diagnosis.

Note

The diagnosis setting automatically returns to "Off" (default setting) when you press the ⏪/RESET button or start playing a PlayStation® format disc, PlayStation®2 format disc or a DVD video disc.

Setting the PlayStation® Driver

The PlayStation® Driver is a programme for loading PlayStation® format software.

- Select "PlayStation® Driver" using the up and down directional buttons and press the Δ button.
- Select the item you want using the up and down directional buttons and press the X button.

Disc Speed

- Standard: normally select this position.
- Fast: loading time for a PlayStation® format software disc can be shortened. Depending on the software, there may be no effect or the software may unexpectedly fail. In this case, select "Standard."

Texture Mapping

- Standard: normally select this position.
- Smooth: you can make the display smoother when playing certain PlayStation® format software titles. Depending on the software, there may be no effect. In this case, select "Standard."

Note

The "PlayStation® Driver" setting automatically returns to "Standard" (default setting) when you press the ⏪/RESET button or turn off the console.



Starting a game

- 1 Turn on the console using the **MAIN POWER** switch on the back of the console.

The $\text{\textcircled{P}}$ (standby) indicator on the front of the console lights up in red to indicate that the console is now in standby mode.

- 2 Press the $\text{\textcircled{P}}$ (standby)/RESET button.

The $\text{\textcircled{P}}$ indicator turns green and the start-up screen appears.

- 3 Plug the Analog Controller (DUALSHOCK®2) or Analog Controller (DUALSHOCK®) into the console.

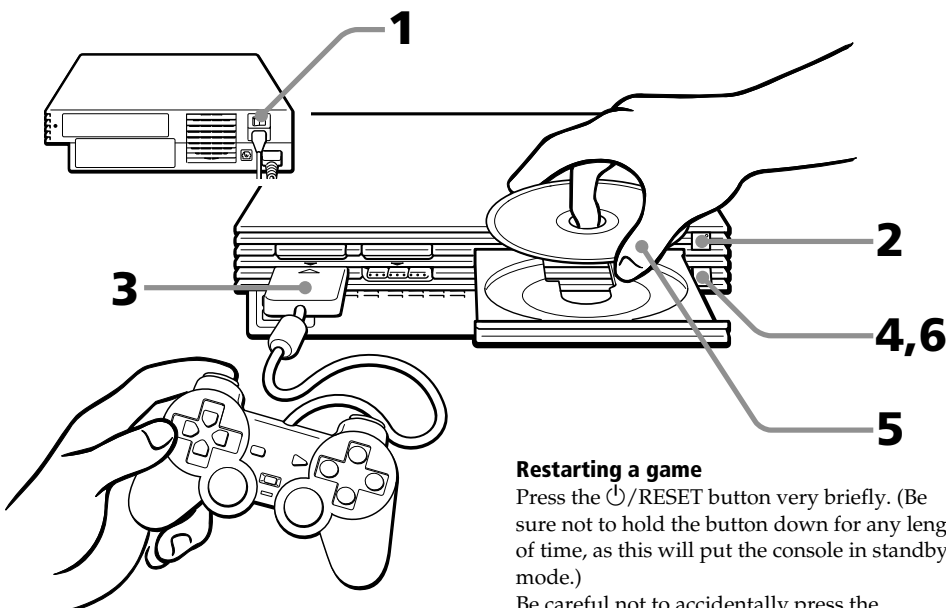

- 4 Press the $\text{\textcircled{O}}$ (open) button.

The disc tray opens.

- 5 Place a disc on the disc tray with the label side facing up.

- 6 Press the $\text{\textcircled{O}}$ button.

The disc tray closes. Screen ② or ③ appears and the game is ready to begin.

Note

Set the Analog Controller (DUALSHOCK®2) or Analog Controller (DUALSHOCK®) to the appropriate mode for the software (page 9). See the appropriate software manual for details.

Restarting a game

Press the $\text{\textcircled{P}}$ /RESET button very briefly. (Be sure not to hold the button down for any length of time, as this will put the console in standby mode.)

Be careful not to accidentally press the $\text{\textcircled{P}}$ /RESET button while playing a game, or the game will restart.

Screens that appear at start-up

When turning on the console without first inserting a disc

Screen ① appears.

- When you insert a PlayStation®2 or PlayStation® format disc after screen ① has appeared, screen ② or ③ will appear and you can start the game.
- You can move to the System Configuration menu or the browser screen from screen ①. (For details, see "Using the Main menu" on page 7.)

When turning on the console with a disc already inserted

Depending on the type of disc inserted, screen ②, ③ or ④ will appear.

If screen ④ appears, it is possible that the inserted disc is not a PlayStation® or PlayStation®2 format disc. Check the disc type (page 3).

- ① No disc is inserted (Main menu).

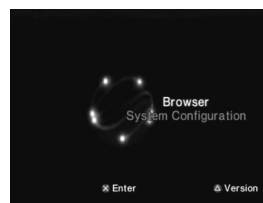

- ② PlayStation®2 format DVD-ROM / CD-ROM is inserted.



- ③ PlayStation® format CD-ROM is inserted.



- ④ A disc that cannot be played with the PlayStation®2 console is inserted.



Ending a game

- 1 Press the $\text{\textcircled{O}}$ button.
The disc tray opens.
- 2 Remove the disc.
- 3 Press the $\text{\textcircled{O}}$ button.
The disc tray closes.
- 4 Press the $\text{\textcircled{P}}$ /RESET button for about two seconds.
The $\text{\textcircled{P}}$ indicator turns red and the console enters standby mode.

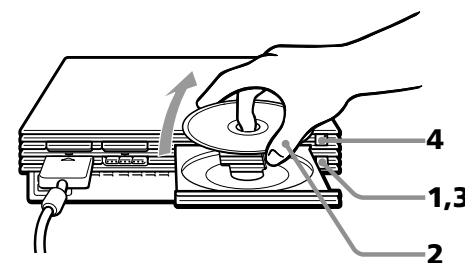

When not intending to play a game for an extended period of time

Turn the power off at the MAIN POWER switch on the back of the console, and disconnect the AC power plug from the electrical socket.

Changing from one game to another

There is no need to turn off the console when you want to change games.

- 1 Press the button.
The disc tray opens.
- 2 Remove the disc.
- 3 Place a new disc in the disc tray.
- 4 Press the button.
The disc tray closes.
- 5 Press the /RESET button briefly to reset.
(Warning: holding the /RESET button down for any length of time may cause the console to go into standby mode.)
After the start-up screen, screen ② or ③ appears and the game begins.

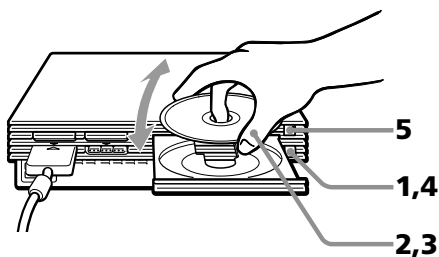

Note
With a multi-disc game, follow steps 1 through 4 to switch discs. Refer to the software manual for details.

Differences between the Analog Controller (DUALSHOCK®2) and Analog Controller (DUALSHOCK®)

- ① **Analog Controller (DUALSHOCK®2)**
(supplied / sold separately)
 - The Analog Controller (DUALSHOCK®2) can be used with PlayStation®2 and PlayStation® format software.
 - You can switch between digital and analog modes. When the controller is in analog mode, the following buttons and sticks may operate in analog fashion depending on the features supported by the software title. Refer to the software manual for details.

PlayStation®2 format software
Directional buttons / Δ , \circ , \times , \square buttons / left analog stick / right analog stick / L1, R1, L2, R2 buttons

PlayStation® format software
Left analog stick / right analog stick

 - You can enjoy the vibration function.
- ② **Analog Controller (DUALSHOCK®)**
(sold separately)
 - The Analog Controller (DUALSHOCK®) can be used with PlayStation®2 and PlayStation® format software.

- You can switch between digital and analog modes. When in analog mode, you can enjoy the analog operation of the left analog stick and right analog stick.

- PlayStation®2 format software**
Left analog stick / right analog stick
- PlayStation® format software**
Left analog stick / right analog stick
- You can enjoy the vibration function.

Mode switching and the mode indicator

The Analog Controller (DUALSHOCK®2) and Analog Controller (DUALSHOCK®) can be switched between digital mode and analog mode by pressing the ANALOG mode button. Each time the ANALOG mode button is pressed, the mode changes as follows:

Digital mode (indicator: off)
↕
Analog mode (indicator: red)

Note
Switch to the appropriate mode for use. Note however, that some software will make this adjustment automatically. In such cases, the ANALOG mode button is overridden by the software. For details, refer to the software manual.

Vibration function

The Analog Controller (DUALSHOCK®2) and Analog Controller (DUALSHOCK®) both feature a vibration function when the function is supported by the software title. The vibration function can be set to ON or OFF on the software option screen.

- Notes**
- When the Analog Controller (DUALSHOCK®2) and Analog Controller (DUALSHOCK®) is not being used, turn the console off or unplug the controller from the console.
 - Before using the vibration function, please read "Notes on safety when using the Analog Controller (DUALSHOCK®2) and Analog Controller (DUALSHOCK®)" on page 2.

Before using the Analog Controller (DUALSHOCK®2) and Analog Controller (DUALSHOCK®)

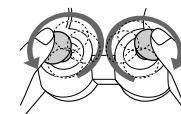

After turning the console on, rotate the analog sticks once with your thumbs before starting a game. Do not twist the analog sticks but rotate as if drawing a circle (see diagram above.)

Digital mode (indicator: off)

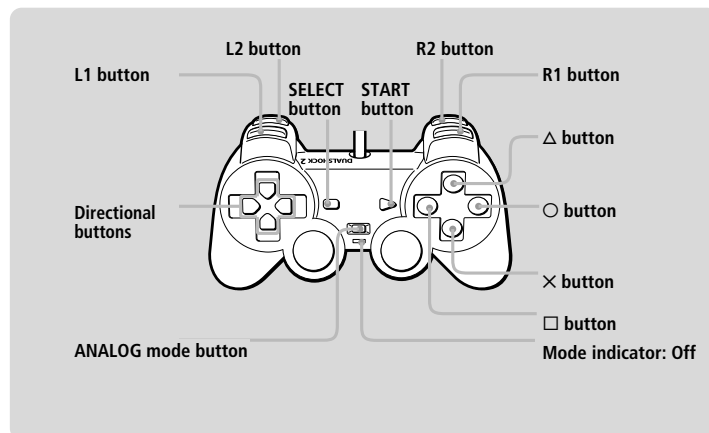

Analog mode (indicator: red)

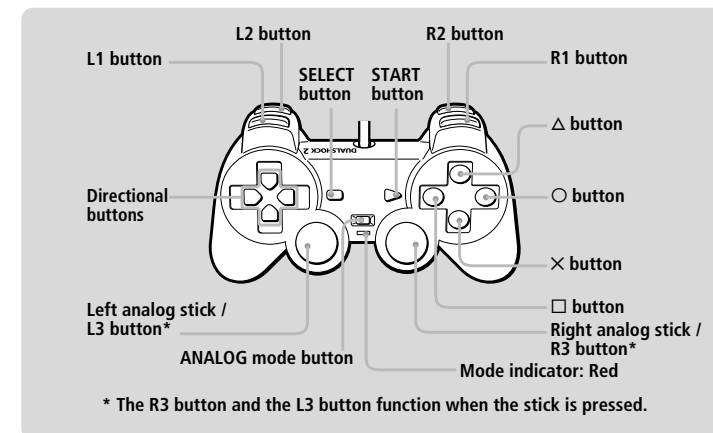

You can save and load game or other data using the Memory Card (8MB) (for PlayStation®2) or Memory Card (each sold separately).

Differences between the Memory Card (8MB) (for PlayStation®2) and Memory Card

When playing PlayStation®2 format software, use the Memory Card (8MB*) (for PlayStation®2) (①).
When playing PlayStation® format software, use the Memory Card (②).

For the PlayStation® video game console, units of game data are described as “memory blocks,” however for the PlayStation®2 computer entertainment system, they are described as “KB” (kilobytes).

*8 MB = 8,000 KB

① Memory Card (8MB) (for PlayStation®2) (sold separately)

The Memory Card (8MB) (for PlayStation®2) can save and load PlayStation®2 format software game data. Each Memory Card (8MB) (for PlayStation®2) can save about 8 MB of game data, but some of this may be used as file control information.

The Memory Card (8MB) (for PlayStation®2) is equipped with **MAGICGATE**, a technology that protects copyrighted data by data encryption and by two-way authentication of devices.

MAGICGATE is a copyrighted anti-copying technology created by Sony Corp. This **MAGICGATE** mark does not necessarily imply compatibility with other products bearing the “MAGICGATE” trademark.

② Memory Card (sold separately)

The Memory Card can save and load PlayStation® format software game data. Each Memory Card can save 120 KB (15 memory blocks) of game data.

Note

You cannot copy data to a Memory Card (8MB) (for PlayStation®2) or Memory Card that does not have enough memory available. Before playing, check how much space is needed to save the game and how much space is available on the Memory Card (8MB) (for PlayStation®2) or Memory Card. Check the appropriate software manual to determine the amount of space needed to save the data for a given game.

Inserting Memory Card (8MB) (for PlayStation®2) and Memory Card

Insert the Memory Card (8MB) (for PlayStation®2) or Memory Card into the MEMORY CARD slot, with the arrow side up.

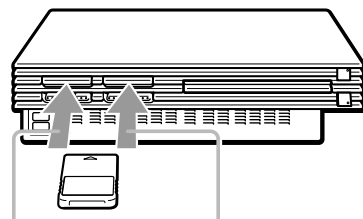

MEMORY CARD slot 1 MEMORY CARD slot 2

Notes on using Memory Card (8MB) (for PlayStation®2) or Memory Card with a Multitap

- When using PlayStation®2 format software, use the SCPH-10090 E Multitap (for PlayStation®2).
- When using PlayStation® format software, use the SCPH-1070 E Multitap.
- **When you insert the SCPH-1070 E Multitap into controller port 1, do not insert the Memory Card (8MB) (for PlayStation®2) or Memory Card into MEMORY CARD slot 1 of the PlayStation®2 console. This also applies when you insert the Multitap into controller port 2. If you do so, the data may be lost.**

Copying/deleting game data

You can copy game data from one Memory Card (8MB) (for PlayStation®2) or Memory Card to another or delete data you no longer wish to keep.

You cannot, however, copy game data of PlayStation®2 format software to the Memory Card.

You can check, copy and delete game data in the browser screen. For details on the browser, see “Checking/copying/deleting game data” on page 7.

Note

You cannot save or load game data in the browser screen. For details on game data saving or loading, refer to the software manual.

Playing an audio CD

- 1 Press the \triangle (open) button.**
The disc tray opens.
- 2 Place a disc on the disc tray with the playback side facing down.**
- 3 Press the \triangle button.**
The disc tray closes.
- 4 Select the audio CD icon in the browser screen (page 7), then press the \times button.**
The “Audio CD” screen appears.
- 5 Select the icon number using the directional buttons, then press the \times button.**
The CD operation screen appears and playback starts.

Operating the CD player

While a disc is playing, select the button in the CD operation screen using the right and left directional buttons. Then press the \times button.

- \blacktriangleright :Start playing.
- \parallel :Pause.
- \blacksquare :Stop playing.
- \blacktriangleleft :Find the beginning of the current or previous track.
- \blacktriangleright :Fast Forward.
- \blacktriangleleft :Fast Reverse.
- \blacktriangleright :Find the beginning of the next track.

Music discs encoded with copyright protection technologies

The audio CD playback feature of this product is designed to conform to the Compact Disc (CD) standard. Recently, some record companies have started marketing music discs encoded with copyright protection technologies. Some of these music discs do not conform to the CD standard and may not be playable on this product.

Playing in various modes

You can change between various play modes. As a default setting, “Normal” is selected for “Play Mode,” and “Off” is selected for “Repeat.”

Select the audio CD icon in the browser screen, then press the \triangle button to change the settings.

To play the desired tracks in a specified order

- Select “Play Mode” using the up and down directional buttons and press the \times button.
- Select “Program” using the right and left directional buttons and press the \times button.
- Select the number of the specific track using the directional buttons then press the \times button.
Repeat this step until you have selected all the tracks you want to play.
- Press the \circ button to return to the browser screen.

To play the tracks in random order

- Select “Play Mode” using the up and down directional buttons and press the \times button.
- Select “Shuffle” using the right and left directional buttons and press the \times button.
- Press the \circ button to return to the browser screen.

To play all tracks repeatedly

- Select “Repeat” using the up and down directional buttons and press the \times button.
- Select “All” using the right and left directional buttons and press the \times button.
- Press the \circ button to return to the browser screen.

To play a track repeatedly

- Select “Repeat” using the up and down directional buttons and press the \times button.
- Select “1” using the right and left directional buttons and press the \times button.
- Press the \circ button to return to the browser screen.



Playing a DVD video

Depending on the DVD video, some operations may be different or restricted. Refer to the instructions supplied with your disc.

1 Turn on the console using the MAIN POWER switch on the back of the console.

The (standby) indicator on the front of the console lights up in red to indicate that the console is now in standby mode.

2 Press the (standby)/RESET button.

The indicator turns green and the start-up screen appears.

3 Press the button.

The disc tray opens.

4 Place a disc on the disc tray with the playback side facing down.

5 Press the button.

The disc tray closes and the console starts playback.

Notes

- Depending on the DVD, a DVD menu or Title menu may appear on the TV screen (see page 13).
- If you press the button after playback, the browser screen appears.
- When playing a DVD video, do not connect the console to a VCR. If you do, picture quality may be reduced. Connect the console directly to the TV.

Operating the DVD player directly with a controller

You can operate the DVD player directly with the buttons on a controller when the Control Panel (page 12) is not displayed. You can also operate the DVD player using the DVD Remote Control (for PlayStation®2) (sold separately). For detailed instructions, refer to the instruction manual supplied with the SCPH-10173 DVD Remote Control (for PlayStation®2) with IR Receiver Unit.

This console is equipped with DVD Player software that is compatible with the DVD Remote Control (for PlayStation®2). You can use the DVD Remote Control (for PlayStation®2) simply by inserting the IR receiver unit (supplied with the DVD Remote Control) into a controller port of the console. No Memory Card (8MB) (for PlayStation®2) is required when using the DVD Remote Control (for PlayStation®2) with this console.

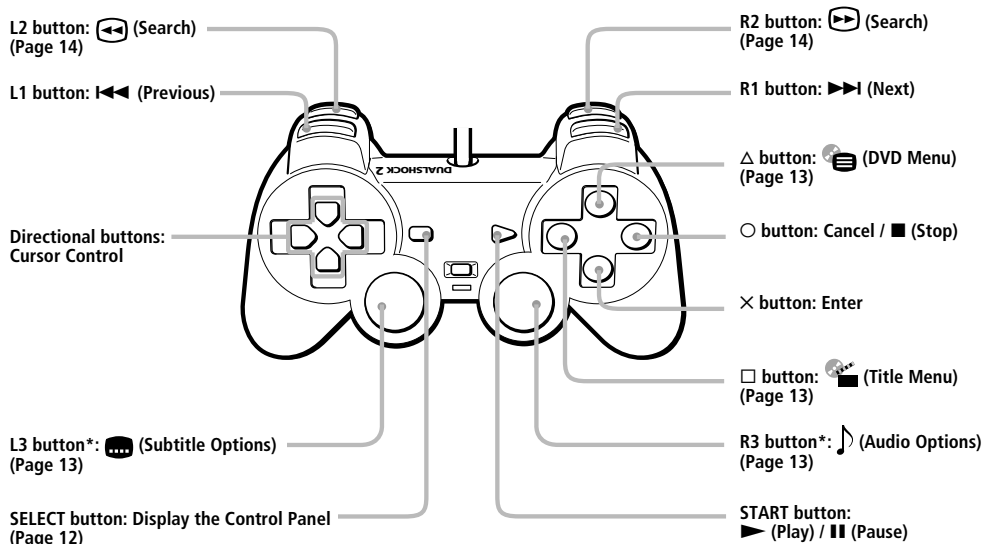

* When using a controller without the L3 or R3 button, you can select the (Subtitle Options) function or the (Audio Options) function using the Control Panel (see page 12).

To	Operation
Stop	Press the ○ button.
Pause	Press the START button.
Resume play after pause	Press the START button.
Go to the next chapter in continuous play mode	Press the R1 button.
Go back to the preceding chapter in continuous play mode	Press the L1 button twice.

You can enjoy various functions using the on-screen menu (Control Panel). For Control Panel operations, see page 12.

Resuming playback from the point where you stopped the disc (Resume Play)

The player remembers the point where you stopped the disc, and you can resume playback from that point.

1 While playing a disc, press the ○ button to stop playback.

“Press [Play] to resume viewing. To start from the beginning, press [Stop] and then [Play].” appears, and then the Control Panel (page 12) is displayed on the TV screen.

If the message “Resume function cannot be used here. Play will restart from the beginning.” appears, Resume Play is not available.

2 Select (Play) using the directional buttons and press the × button.

The player starts playback from the point where you stopped the disc in step 1.

To play from the beginning of the disc

After step 1, select (Stop) and press the × button. The point where you stopped playing is cleared.

Select (Play) and press the × button.

Notes

- Resume Play may not be available on some DVDs.
- Depending on where you stopped the disc, the console may resume playback from a slightly different point.
- The point where you stopped playing is cleared when:
 - you open the disc tray;
 - you shift to standby mode by pressing and holding down the (standby)/RESET button on the front of the console;
 - you turn the power off using the MAIN POWER switch on the back of the console;
 - you start playback after selecting a title or chapter.

Using the Control Panel

You can enjoy various functions using the on-screen menu (Control Panel). The possible functions are different depending on the disc.

1 Press the SELECT button.

The Control Panel appears on the TV screen.



2 Select the item you want using the directional buttons.

3 Press the X button.

For details on each Control Panel display item, see pages 13 – 18.

You can select some items directly with the controller

See page 11.

Control Panel item list



1 DVD Menu (page 13)

Some DVDs allow you to select the disc contents using a menu. When you play these DVDs, you can select the language for the subtitles, the language for the sound, etc., using the DVD menu.

2 Title Menu (page 13)

A DVD is divided into long sections of a movie or a music feature called "titles." When you play a DVD which contains several titles, you can select the title you want using the Title menu.

3 Return (page 13)

You can return to the previous screen in the DVD menu or Title menu.

4 Audio Options (page 13)

If the DVD is recorded with multilingual tracks, you can select the language you want to hear while playing the DVD.

5 Angle Options (page 13)

With DVDs on which various angles (multi-angles) for a scene are recorded, you can select among the various angles available.

6 Subtitle Options (page 13)

With DVDs on which subtitles are recorded, you can change the language whenever you want while playing the DVD, and turn it on and off whenever you want.

7 Go to Title (page 14)

You can select the number of the title you want to search for.

8 Setup (page 15)

Using the Setup display, you can do the initial setup, adjust the picture and sound and set the various outputs. You can also set a language for the subtitles and the Setup display, limit playback by children, and so on.

9 Chapter Display (page 14)

While playing a disc, you can check the current title number and current chapter number on the TV screen.

10 Help (page 14)

The list of the direct buttons on the controller is displayed on the TV screen.

11 Go to Chapter (page 14) / Number buttons

You can select the number of the chapter you want to search for.

12 Previous

You can go back to the preceding chapter in continuous play mode.

13 Search (page 14)

You can locate a particular point on the DVD quickly by monitoring the picture.

14 Next

You can go to the next chapter in continuous play mode.

15 Play

16 Pause

17 Stop

18 Slow (page 14)

You can locate a point on the DVD slowly by watching the screen.

Using the DVD menu

Some DVDs allow you to select the disc contents using a menu. When you play these DVDs, you can select the language for the subtitles, the language for the sound, etc., using the DVD menu.

- 1 Select  (DVD Menu) using the directional buttons and press the X button.
The DVD menu appears on the TV screen. The contents of the menu vary from disc to disc.
- 2 Press the directional buttons to select the item you want to change.
- 3 To change other items, repeat step 2.
- 4 Press the X button.

You can display the DVD menu directly

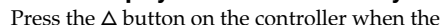
Press the  button on the controller when the Control Panel is not displayed.

If you want to select the language for the DVD menu

You can change this setting by choosing "Language Setup" and then "DVD Menu." For details, see page 16.

To return to the previous screen in the DVD menu

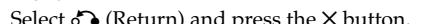
Select  (Return) and press the X button. This function may not be available on some DVDs.

Notes

- A DVD menu may not be available on some DVDs.
- Depending on the DVD, the "DVD menu" may be referred to as a "menu" in the instructions supplied with the disc.

Using the Title menu

A DVD is divided into long sections of a film or a music feature called "titles." When you play a DVD which contains several titles, you can select the title you want using the Title menu.

- 1 Select  (Title Menu) using the directional buttons and press the X button.
The Title menu appears on the TV screen. The contents of the menu vary from disc to disc.
- 2 Press the directional buttons to select the title you want to play.
- 3 Press the X button.
The console starts playing the selected title.

You can display the Title menu directly

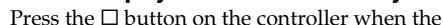
Press the  button on the controller when the Control Panel is not displayed.

To return to the previous screen in the Title menu

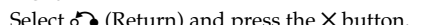
Select  (Return) and press the X button. This function may not be available on some DVDs.

Notes

- On some DVDs, you may not be able to select the title.
- On some DVDs, the "Title menu" may be referred to as a "menu" or "title" in the instructions supplied with the disc. "Press ENTER." may also be expressed as "Press SELECT."

Changing the audio language

If the DVD is recorded with multilingual tracks, you can select the language you want to hear when playing a DVD video. The languages you can select are different depending on the DVD.

Select  (Audio Options) using the directional buttons and press the X button.

Each time you press the X button, the language changes.

You can select "Audio Options" directly

Press the R3 button on the controller when the Control Panel is not displayed. Each time you press the button, the language changes.

Notes

- Due to the programming on some DVDs, you may not be able to change the languages even if multilingual tracks are recorded on the DVD.
- While playing the DVD, the sound may be changed when you change the title.

Changing the angles

With DVDs on which various angles (multi-angles) for a scene are recorded, you can change the angles. For example, while playing a scene of a train in motion, you can display the view from either the front of the train, the left window of the train or from the right window without having the train's movement interrupted.

Select  (Angle Options) using the directional buttons and press the X button.

Each time you press the X button, the angle changes.

Notes

- The number of angles varies from disc to disc or from scene to scene. The number of angles that can be changed on a scene is equal to the number of angles recorded for that scene.
- Due to the programming on some DVDs, you may not be able to change the angles even if multiple angles are recorded on the DVD.

Displaying subtitles

With DVDs on which subtitles are recorded, you can turn the subtitles on and off whenever you want while playing the DVD. With DVDs on which multilingual subtitles are recorded, you can also change the subtitle language whenever you want while playing the DVD. For example, you can select the language you want to practise and turn the subtitles on for better understanding.

Select  (Subtitle Options) using the directional buttons and press the X button.

You can select the subtitle language, and turn it on or off.

The languages you can select are different depending on the DVD.

You can select "Subtitle Options" directly

Press the L3 button on the controller when the Control Panel is not displayed. You can select the subtitle language, and turn it on or off.

Notes

- When playing a DVD on which no subtitles are recorded, no subtitles appear.
- Due to the programming on some DVDs, you may not be able to turn the subtitles on even if they are recorded on the DVD.
- Depending on the DVD, you may not be able to turn the subtitles off.
- The type and number of languages for subtitles vary from disc to disc.
- Due to the programming on some DVDs, you may not be able to change the subtitles even if multilingual subtitles are recorded on it.
- While playing the DVD, the subtitle may change when you change the title.

Searching for a title

You can select the number of the title you want to search for using the number buttons.

1 Select  (Go to Title) using the directional buttons and press the X button.
"Go to Title - -" appears on the TV screen.

2 Use the number buttons to enter a 2 digit title number.

The player starts playback at the selected title.

Displaying information while playing a disc

While playing a disc, you can check the current title number and current chapter number on the TV screen.

Select  (Chapter Display) using the directional buttons and press the X button.

Each time you press the X button, you can turn the display on and off.

Displaying the list of the direct buttons

The list of the direct buttons on the controller can be displayed on the TV screen.

Select  (Help) using the directional buttons and press the X button.

To turn off the list

Press the X button.

Searching for a chapter

You can select the number of the chapter you want to search for using the number buttons.

Use the number buttons to enter a 2 digit chapter number.

The player starts playback at the selected chapter.



Searching for a particular point on a disc

You can locate a particular point on a disc quickly by monitoring the picture or playing back slowly.

Note

Depending on the DVD, you may not be able to do some of the operations described.

Locating a point quickly (Search)

1 While a disc is playing, select  (Search forward) or  (Search backward) using the directional buttons.

2 Keep the X button pressed until you locate the point you are looking for.

When you find the point you want, release the button to return to normal playback speed.

You can also use the direct buttons

Press the R2 (forward) or L2 (backward) buttons on the controller when the Control Panel is not displayed.

Locating a point slowly by watching the screen (Slow-motion play)

1 While a disc is playing, select  (Slow) using the directional buttons.

2 Press the X button.

Slow-motion playback starts.

When you find the point you want, select  (Play) and press the X button to return to the normal speed.

You can also resume playback by pressing the START button.

Using the Setup display

Using the Setup display, you can change the initial settings, adjust the picture and sound and set various other output options. You can also choose a language for subtitles, limit playback by children, and so on.

1 Press the SELECT button to show the Control Panel on the TV screen.

2 Select  (Setup) using the directional buttons and press the X button.

The Setup display appears on the TV screen.

3 Select the category you want using the directional buttons.

4 Press the X button.

The selected category is highlighted.

5 Select the item you want using the directional buttons.

6 Press the X button.

After changing DVD settings

To save your changes, be sure to eject the DVD before pressing the /RESET button or turning off the unit with the MAIN POWER switch. Please note that changes will not be saved if you reset or turn off the console without first ejecting the DVD.

Setup display item list

The default settings are underlined.

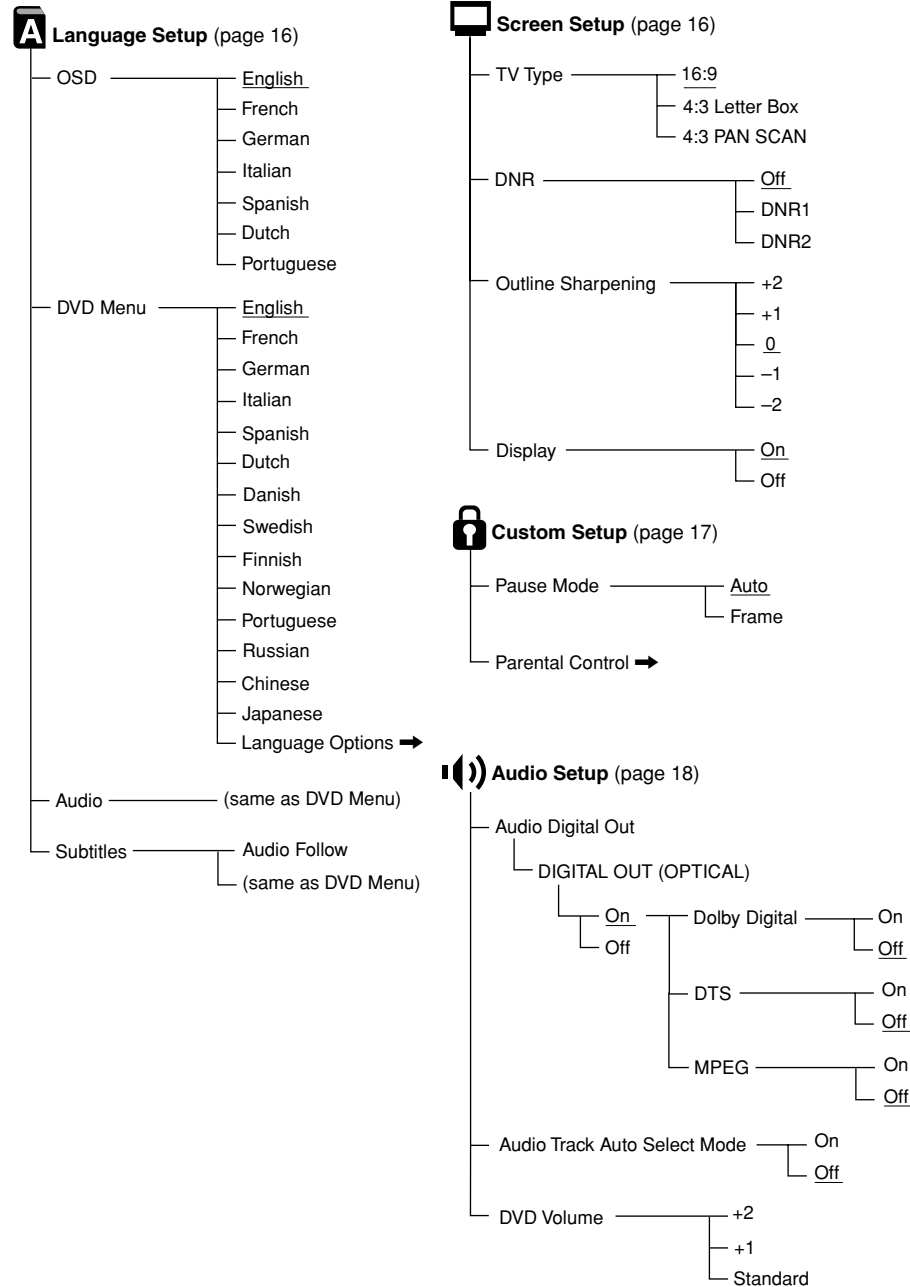

Setting the display language or sound track (Language Setup)

"Language Setup" allows you to choose among various languages for the on-screen display or sound track.

The default settings are underlined.

Select "Language Setup" in the Setup display.

Notes

- When you select a language that is not recorded on the DVD, one of the recorded languages is automatically selected for the "DVD Menu," "Audio" and "Subtitles" settings.
- Depending on the DVD, the console may not start playing the language you have selected in the "DVD Menu," "Audio" or "Subtitles."

OSD

Selects the language for the on-screen display.

- English
- French
- German
- Italian
- Spanish
- Dutch
- Portuguese

DVD Menu

Selects the language for the DVD menu.

- English
 - French
 - German
 - Italian
 - Spanish
 - Dutch
 - Danish
 - Swedish
 - Finnish
 - Norwegian
 - Portuguese
 - Russian
 - Chinese
 - Japanese
 - Language Options
- When you select "Language Options," the language list is displayed. Select the language from the list.

Audio

Selects the language for the sound track.

- English
 - French
 - German
 - Italian
 - Spanish
 - Dutch
 - Danish
 - Swedish
 - Finnish
 - Norwegian
 - Portuguese
 - Russian
 - Chinese
 - Japanese
 - Language Options
- When you select "Language Options," the language list is displayed. Select the language from the list.

Subtitles

Selects the language for the subtitles.

- Audio Follow*
 - English
 - French
 - German
 - Italian
 - Spanish
 - Dutch
 - Danish
 - Swedish
 - Finnish
 - Norwegian
 - Portuguese
 - Russian
 - Chinese
 - Japanese
 - Language Options
- When you select "Language Options," the language list is displayed. Select the language from the list.

* When you select "Audio Follow," the language for the subtitles changes according to the language you selected for the sound track.

After changing DVD settings

To save your changes, be sure to eject the DVD before pressing the /RESET button or turning off the unit with the MAIN POWER switch. Please note that changes will not be saved if you reset or turn off the console without first ejecting the DVD.

Setting your TV display mode (Screen Setup)

"Screen Setup" allows you to set various options for your TV display.

The default settings are underlined.

Select "Screen Setup" in the Setup display.

TV Type

Selects the aspect ratio of the TV to be connected.

You can change this setting only when the DVD is stopped.

- 16:9: select this when you connect a wide-screen TV, or a TV that displays in wide mode to the console.
- 4:3 Letter Box: select this when you connect a standard TV to the console. Displays a wide picture with margins on the upper and lower portions of the screen.
- 4:3 PAN SCAN: select this when you connect a standard TV to the console. Displays the wide picture on the whole screen automatically and cuts off the portions that do not fit.

16:9



4:3 Letter Box



4:3 PAN SCAN

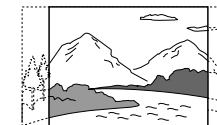

Note

With most DVDs, the picture is automatically output in a predetermined aspect ratio.

DNR (Digital Noise Reduction)

If the playback picture has noise or interference, set this item to "DNR1" or "DNR2."

- Off: normally select this position.
- DNR1: makes the picture clear by reducing noise.
- DNR2: makes the picture even clearer by reducing noise.

Notes

- When you select "DNR2," an afterimage may appear. In this case, select "Off."
- Depending on the DVD, the DNR function may produce limited results.

Outline Sharpening

Makes the outline of the picture sharpened or softened. The higher the value, the sharper the outline.

- +2
- +1
- 0: normally select this position.
- 1
- 2

Display

Displays or turns off the playing status information on the TV screen.

- On: when you operate the DVD player, the playing status appears for a few seconds on the TV screen.
- Off: the playing status is not displayed.

After changing DVD settings

To save your changes, be sure to eject the DVD before pressing the /RESET button or turning off the unit with the MAIN POWER switch. Please note that changes will not be saved if you reset or turn off the console without first ejecting the DVD.

Custom settings (Custom Setup)

“Custom Setup” allows you to set the playback conditions.

The default settings are underlined.

Select “Custom Setup” in the Setup display.

■ Pause Mode

Selects the picture in pause mode.

- **Auto**: a picture, including subjects that move dynamically, is output without any jitter. Normally select this position.
- **Frame**: a picture including subjects that do not move dynamically is output with high resolution.

■ Parental Control

Playback of some DVDs can be limited depending on the age of the users.

The “Parental Control” function allows you to set a playback limitation level.

Sets a password and playback limitation level which prevent children from viewing certain content on the DVD.

Select “Custom Setup” in the Setup display.

- 1 Select “Parental Control” using the directional buttons, then press the X button.

■ When you have not entered a password

The display for entering a password appears.

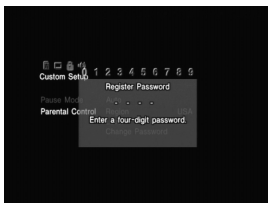

■ When you have already registered a password

The display for confirming the password appears. Skip step 2.

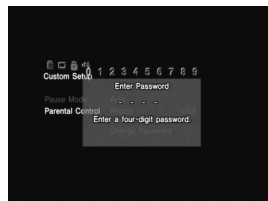

- 2 Enter a password in 4 digits using the number buttons.

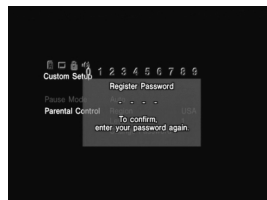

- 3 To confirm your password, enter it again using the number buttons.

You can set the Parental Control level and change the password.

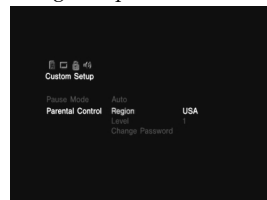

- 4 Select “Region” using the directional buttons, then press the X button.

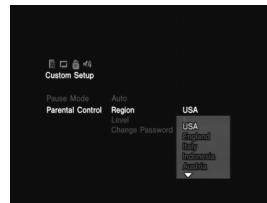

- 5 Select a geographic region to set the standard Parental Control level for that region using the directional buttons, then press the X button.

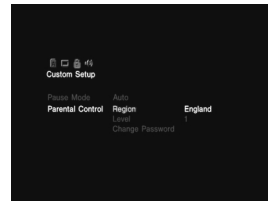

- 6 Select “Level” using the directional buttons, then press the X button.

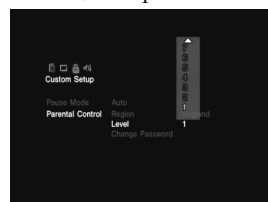

- 7 Select the level you want using the directional buttons, then press the X button.

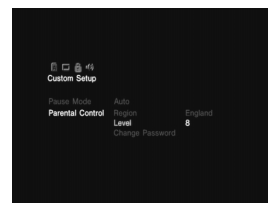

The lower the value, the stricter the limitation.

To turn off the Parental Control function and play the DVD after entering your password

Set “Level” to “Off” in step 7, then press the X button.

To change the password

- 1 After step 3, select “Change Password” using the directional buttons, then press the X button.

The display for changing the password appears.

- 2 Follow steps 2 and 3 to enter a new password.

Playing a disc which is protected by Parental Control

- 1 Insert the disc and press the START button.

The Parental Control display appears.

- 2 Enter your four-digit password using the number buttons.

The player starts playback.

When you stop playing the DVD, the Parental Control level returns to the original setting.

If you forget your password

Press the SELECT button and enter the four-digit number “7444” whenever the Parental Control display asks you for your password. The old password is deleted.

Notes

- When you play DVDs which do not have the Parental Control function, playback cannot be limited on this player.
- If you do not set a password, you cannot change the settings for Parental Control.
- Depending on the DVD, you may be asked to change the Parental Control level while playing the disc. In this case, enter your password, then change the level. When you stop playing the DVD, the Parental Control level returns to the original setting.

After changing DVD settings

To save your changes, be sure to eject the DVD before pressing the ⏻/RESET button or turning off the unit with the MAIN POWER switch. Please note that changes will not be saved if you reset or turn off the console without first ejecting the DVD.

Audio Settings (Audio Setup)

"Audio Setup" allows you to adjust your audio settings according to the playback conditions. The default settings are underlined.

Select "Audio Setup" in the Setup display.

■ Audio Digital Out

Switches the methods of outputting audio signals when you connect with equipment like the following.

- Digital equipment such as a receiver (amplifier) with a digital connector
- Audio equipment with a built-in decoder (Dolby Digital, DTS or MPEG)
- A DAT or MD player, via the DIGITAL OUT (OPTICAL) connector using an optical digital cable.

For connection details, see page 6. You cannot adjust "Dolby Digital," "DTS" and "MPEG" if you set "DIGITAL OUT (OPTICAL)" to "Off."

■ DIGITAL OUT (OPTICAL)

Selects whether to output signal via the DIGITAL OUT (OPTICAL) connector.

- On : select this when you connect with an optical digital cable (sold separately). Normally select this option. When you select "On," you can set "Dolby Digital," "DTS" and "MPEG."
- Off : select this when you do not want sound signal to be output via the DIGITAL OUT (OPTICAL) connector.

Note

When you select "Off," you cannot set "Dolby Digital," "DTS" and "MPEG."

■ Dolby Digital

Selects the Dolby Digital signals to be output via the DIGITAL OUT (OPTICAL) connector.

- On : when the console is connected to audio equipment with a built-in Dolby Digital decoder. If the console is connected to audio equipment without a built-in Dolby Digital decoder, do not turn this option on. Otherwise, when you play the Dolby Digital sound track, a loud noise (or no sound) will come out from the speakers, possibly hurting your ears or damaging the speakers.
- Off : when the console is connected to audio equipment without a built-in Dolby Digital decoder.

■ DTS

Selects the DTS signals to be output via the DIGITAL OUT (OPTICAL) connector.

- On : when the console is connected to audio equipment with a built-in DTS decoder. If the console is connected to audio equipment without a built-in DTS decoder, do not turn this option on. Otherwise, when you play the DTS sound track, a loud noise (or no sound) will come out from the speakers, possibly hurting your ears or damaging the speakers.
- Off : when the console is connected to audio equipment without a built-in DTS decoder.

■ MPEG

Selects the MPEG AUDIO signals to be output via the DIGITAL OUT (OPTICAL) connector.

- On : when the console is connected to audio equipment with a built-in MPEG decoder. If the console is connected to audio equipment without a built-in MPEG decoder, do not turn this option on. Otherwise, when you play the MPEG sound track, a loud noise (or no sound) will come out from the speakers, possibly hurting your ears or damaging the speakers.
- Off : when the console is connected to audio equipment without a built-in MPEG decoder.

■ Audio Track Auto Select Mode

Gives the sound track which contains the highest number of channels priority when you play a DVD on which multiple audio formats (PCM, DTS, Dolby Digital or MPEG AUDIO format) are recorded.

- On : priority given.
- Off : no priority given.

Notes

- When you set this item to "On," the language may change depending on the "Audio" settings in "Language Setup." The "Audio Track Auto Select Mode" setting has higher priority than the "Audio" settings in "Language Setup" (page 16).
- If you set "DIGITAL OUT (OPTICAL)" to "On" and "DTS" to "Off" in "Audio Setup," the DTS sound track is not played even if you set this item to "On" and the highest-numbered audio channel is recorded in DTS format.
- If PCM, DTS, Dolby Digital and MPEG AUDIO sound tracks have the same number of channels, the console selects PCM, Dolby Digital, DTS and MPEG AUDIO sound tracks in this order.
- Depending on the DVD, the audio channel with priority may be predetermined. In this case, you cannot give priority to the DTS, Dolby Digital or MPEG AUDIO format by selecting "On."

■ DVD Volume

If the audio output level of the DVD is low, you can turn up the volume of the DVD. (Note: DIGITAL OUT (OPTICAL) must be set to "Off" to access this function).

- +2 : you can turn up the volume.
- +1 : you can turn up the volume.
- Standard : original audio volume. Normally select this position.

Note

Depending on the DVD, the sound may be distorted if you select "+1" or "+2."

After changing DVD settings

To save your changes, be sure to eject the DVD before pressing the /RESET button or turning off the unit with the MAIN POWER switch. Please note that changes will not be saved if you reset or turn off the console without first ejecting the DVD.

This product incorporates copyright protection technology that is protected by method claims of certain U.S. patents and other intellectual property rights owned by Macrovision Corporation and other rights owners. Use of this copyright protection technology must be authorized by Macrovision Corporation, and is intended for home and other limited viewing uses only unless otherwise authorized by Macrovision Corporation. Reverse engineering or disassembly is prohibited.



Please double check

- **If you experience any of the following difficulties while using the console, use this troubleshooting guide to help remedy the problem. Should any problem persist, please contact the appropriate PlayStation® customer service helpline which can be found: - on the customer registration card; - within every PlayStation® and PlayStation®2 format software manual.**
- **Make sure the AC power cord is connected to the console and the mains, and the TV (or VCR) or the supplied accessories are connected to the console correctly.**
- **In rare instances, certain DVD videos may not operate properly with PlayStation®2. This is primarily due to variations in the manufacturing process or software encoding of the DVD video software. If you experience problems, try restarting your DVD video. If problems persist, for more information call the publisher of the DVD video or contact the appropriate PlayStation® customer service helpline which can be found on the customer registration card.**

Power

The power is not turned on.

- ➔ Make sure the AC power cord is connected securely.
- ➔ The console is not turned on. Turn on the console using the MAIN POWER switch on the back of the console.

Picture

There is no picture.

- ➔ Make sure the console is connected to the TV (or VCR) with the AV Cable (integrated audio/video).
- ➔ Make sure the console and the TV (or VCR) are turned on.
- ➔ Make sure you have selected the video input on the TV (or VCR).
- ➔ Make sure the AV Cable (integrated audio/video) is connected securely.
- ➔ Make sure the inserted disc can be played with this console. (see page 3)
- ➔ Make sure the disc is placed with the label side facing up. (when using a disc with a label)
- ➔ The disc is not inserted correctly.
- ➔ The console is in pause mode.
- ➔ Try another set of AV Cables.

Picture noise appears.

- ➔ The console is placed on an unstable surface. Place the console on a stable and flat surface. Do not shake or vibrate the console.
- ➔ Clean the disc.
- ➔ Moisture has condensed inside the console. (see page 2)
- ➔ If the video signal from the console has to go through the VCR to get to the TV, the copy protection applied to some DVD videos could affect picture quality. When playing a DVD video, connect the console to the TV directly. (see page 5)

The aspect ratio cannot be changed according to the TV when playing wide screen DVD videos.

- ➔ Depending on the disc, the aspect ratio is fixed.
- ➔ Make sure the console is connected to the TV directly. (The selector or receiver (amplifier) may be connected between the console and the TV.)
- ➔ Depending on the TV, the aspect ratio is fixed.

Sound

There is no sound.

- ➔ Make sure the console is connected to the TV (or VCR) with the AV Cable (integrated audio/video).
- ➔ Make sure the console and the TV (or VCR) are turned on.
- ➔ Make sure you have selected the video input on the TV (or VCR).
- ➔ Make sure the TV volume is set properly or "mute" is not selected on the TV.
- ➔ Make sure the AV Cable (integrated audio/video) is connected securely.
- ➔ Make sure the inserted disc can be played with this console. (see page 3)
- ➔ Make sure the disc is placed with the label side facing up. (when using a disc with a label)
- ➔ Make sure you have connected the console to the audio input connectors on the receiver (amplifier) correctly. Refer also to the instructions supplied with your amplifier.
- ➔ Try another set of AV Cables.
- ➔ Check the speaker connections and settings. Refer to the operating manual of your receiver (amplifier).
- ➔ Make sure you select the appropriate input on the receiver (amplifier) so that you can listen to sound from the console. Refer also to the instructions supplied with your amplifier.
- ➔ The console is in pause mode.
- ➔ The console is in search/slow-motion mode (when playing a DVD video).
- ➔ The system setting is not correct for when the console is connected to audio equipment with DIGITAL OUT (OPTICAL) connectors. (see page 6)

Poor sound quality.

- ➔ The console is placed on an unstable surface. Place the console on a stable and flat surface. Do not shake or vibrate the console.
- ➔ Clean the disc.
- ➔ Moisture has condensed on the disc. (see page 2)

- ➔ You are playing an audio CD or a DVD with DTS sound tracks. You can play an audio CD or a DVD with DTS sound tracks only when the console is connected to audio equipment with a DTS decoder.

The surround effect is difficult to hear when you are playing a DVD video with a Dolby Digital sound track.

- ➔ Check the speaker connections and settings. Refer to the operating manual of your receiver (amplifier).
- ➔ Depending on the DVD, the output signal may not comprise of the entire 5.1 channel range. It may be monaural or stereo even if the sound track is recorded in Dolby Digital.

The sound comes from the centre speaker only.

- ➔ Depending on the disc, the sound may come from the centre speaker only.

Operation

The controller does not function.

- ➔ Make sure the controller is connected to the console.
- ➔ Make sure the Analog Controller (DUALSHOCK®2) or the Analog Controller (DUALSHOCK®) is set to the appropriate mode for the software. (see page 9)
- ➔ Try another set of controllers.

The software title does not start.

- ➔ Make sure the inserted disc can be played with this console. (see page 3)
- ➔ Make sure the disc is placed with the label side facing up. (when using a disc with a label)
- ➔ Make sure the disc is inserted correctly.
- ➔ Clean the disc
- ➔ Moisture has condensed on the disc. (see page 2)
- ➔ Try another copy of the disc.

You cannot save data on the Memory Card (8MB) (for PlayStation®2) or Memory Card.

- ➔ Make sure the Memory Card (8MB) (for PlayStation®2) or Memory Card is inserted securely.

- ➔ Make sure you are playing the game correctly. Refer to the appropriate software manual.
- ➔ Make sure there are empty blocks on the Memory Card (8MB) (for PlayStation®2) or Memory Card.
- ➔ Try another Memory Card (8MB) (for PlayStation®2) or Memory Card.

The console does not function properly.

- ➔ Static electricity, etc. may affect the console's operation.
Turn off the MAIN POWER switch and then turn it back on.

⏻ indicator flashes in red and the console does not work.

- ➔ A flashing red light indicates a console "fault" condition and the unit will not operate. Remove any obstructions from the vents to allow the console to cool down. Resume play after the console returns to standby mode.

The disc tray does not open.

- ➔ Make sure the AC power cord is connected securely.
- ➔ Make sure the console is turned on.
Turn on the console using the MAIN POWER switch on the back of the console.

DVD video operation

The console does not play from the beginning when playing a disc.

- ➔ Resume Play has been selected.
Press the Stop button before you start playing (see page 11).
- ➔ Depending on the disc, a Title menu or a DVD menu automatically appears.

The disc does not play even if the DVD title is selected.

- ➔ A Parental Control limit has been set on the disc (see page 17).

Playback stops automatically.

- ➔ The disc may contain an auto pause signal. While playing such a disc, the console stops playback at the signal.

You cannot perform some functions such as Stop, Search or Slow-motion Play.

- ➔ Depending on the disc, you may not be able to do some of the operations above.

The language for the sound track cannot be changed.

- ➔ Multilingual tracks are not recorded on the DVD.
- ➔ Changing the language for the track is prohibited on the DVD.

The subtitle language cannot be changed.

- ➔ Multilingual subtitles are not recorded on the DVD.
- ➔ Changing the language for the subtitles is prohibited on the DVD.

The subtitles cannot be turned off.

- ➔ Depending on the DVD, you may not be able to turn the subtitles off.

The angles cannot be changed when you play a DVD.

- ➔ Multi-angles are not recorded on the DVD.
- ➔ Changing the angles is prohibited on the DVD.

General

- Power requirements
220-240 V AC, 50/60 Hz
- Power consumption
50 W
- Dimensions (approx.)
301 × 78 × 182 mm (w/h/d)
- Mass (approx.)
2.2 kg
- Operating Temperature
5°C-35°C
- Laser diode properties
 - Material: GaAlAs
 - Wavelength: λ=650/780 nm

Inputs/outputs on the console front

- Controller port (2)
- MEMORY CARD slot (2)
- USB connector (2)
- S400 i.LINK connector (1)

Inputs/outputs on the console rear

- AV MULTI OUT connector (1)
- DIGITAL OUT (OPTICAL) connector (1)
- EXPANSION BAY (1)

Supplied accessories

- See page 4.

Optional accessories

- | | |
|--------------|--|
| SCPH-110 E | Analog Controller (DUALSHOCK®) |
| SCPH-1020 E | Memory Card |
| SCPH-1090 E | Mouse |
| SCPH-10010 E | Analog Controller (DUALSHOCK®2) |
| SCPH-10020 E | Memory Card (8MB) (for PlayStation®2) |
| SCPH-10030 E | AV Cable (integrated audio/video) |
| SCPH-10040 E | Vertical Stand (for PlayStation®2) |
| SCPH-10060 E | S VIDEO Cable |
| SCPH-10072 C | RFU Adaptor |
| SCPH-10090 E | Multitap (for PlayStation®2) |
| SCPH-10100 E | Component AV Cable (for PlayStation®2) |
| SCPH-10110 E | Horizontal Stand (for PlayStation®2) |
| SCPH-10130 E | AV Adaptor (with S VIDEO OUT connector) |
| SCPH-10173 | DVD Remote Control (for PlayStation®2) with IR Receiver Unit |

Design and specifications are subject to change without notice.

Chapter (page 14)

Sections of a movie or a music piece on a DVD that are smaller than titles. A title is composed of several chapters. Each chapter is assigned a chapter number enabling you to locate the chapter you want.

Dolby Digital (page 18)

Digital audio compression technology developed by Dolby Laboratories. This technology conforms to 5.1-channel surround sound. The rear channel is stereo and there is a discrete subwoofer channel in this format. Dolby Digital provides the same 5.1 discrete channels of high quality digital audio found in Dolby Digital cinema audio systems. Good channel separation is realised because all of the channel data is recorded discretely and processed in digital.

DTS (page 18)

Digital audio compression technology that Digital Theater Systems, Inc. developed. This technology conforms to 5.1-channel surround sound. The rear channel is stereo and there is a discrete subwoofer channel in this format. DTS provides the same 5.1 discrete channels of high quality digital audio. Good channel separation is realised because all of the channel data is recorded discretely and processed in digital.

DVD (page 3)

A disc that contains up to 8 hours of moving pictures even though its diameter is the same as a CD.

The data capacity of a single-layer and single-sided DVD is 4.7 GB which is 7 times that of a CD. The data capacity of a dual-layer and single-sided DVD is 8.5 GB, a single-layer and double-sided DVD is 9.4 GB, and a dual-layer and double-sided DVD is 17 GB. The picture data uses the MPEG 2 format, one of the worldwide standards of digital compression technology. The picture data is compressed to about 1/40 of its original size. The DVD also uses a variable rate coding technology that changes the data to be allocated according to the status of the picture. Audio data is recorded in Dolby Digital as well

as in PCM, allowing you to enjoy a more real audio presence.

Furthermore, various advanced functions such as the multi-angle, multilingual, and Parental Control functions are provided with the DVD.

MPEG AUDIO (page 18)

International standard coding system to compress audio digital signals authorised by ISO/IEO.

Multi-angle function (page 13)

Various angles for the scene (viewpoints of the video camera) are recorded on some DVDs.

Multilingual function (page 13)

Several languages for the audio track or subtitles in a picture are recorded on some DVDs.

Parental Control (page 17)

A function of the DVD used to limit playback of the disc according to the age of the user and the limitation level in each country. The limitation varies from disc to disc; when it is activated, playback can be completely prohibited, violent scenes are skipped or replaced with other scenes, and so on.

Title (page 13)

The longest section of a movie or a music piece on a DVD; a movie, etc., for a picture piece on video software; or an album, etc., for a music piece on audio software. Each title is assigned a title number enabling you to locate the title you want.

GUARANTEE

Thank you for buying this Product.

Sony Computer Entertainment Europe ("SCEE") will, for a period of 1 (one) year from the date of original purchase, repair or (at SCEE's option) replace any component part of this Product, free of charge, where it is faulty due to defective materials or workmanship. Replacement will be with a new or refurbished component or unit, at SCEE's option.

The benefits conferred by this Guarantee are in addition to other rights and remedies which the consumer has in law in Australia in respect of this Product, including rights and remedies available under the Trade Practices Act 1974 and State and Territory legislation.

IMPORTANT

1. If you need to claim under this Guarantee, please call your local Customer Service Helpline (listed on the Customer Registration Card and in a current software manual) for return instructions and other guidance.
2. This Guarantee is only valid:
 - (i) in Australia and New Zealand;
 - (ii) when the original sales receipt or invoice (indicating the date of purchase and retailer's name) is presented together with the faulty Product (and has not been altered or defaced since the date of original purchase);
 - (iii) when the Guarantee seal on the Product has not been damaged or removed.
3. You may not claim under this Guarantee when the Product is damaged as a result of:
 - (i) commercial use, accident, fair wear and tear or misuse (including, without limitation, failure to use this Product for its normal purpose and/or in accordance with instructions on proper use and maintenance, or installation or use in a manner inconsistent with applicable local technical or safety standards);
 - (ii) use in conjunction with any unauthorised peripheral (including, without limitation, game enhancement devices, adaptors and power supply devices);
 - (iii) any adaptation or adjustment to, or alteration of, this Product carried out for any reason, and whether properly carried out or not;
 - (iv) maintenance or repairs carried out other than by an authorised service facility.

4. Where permitted under applicable law, this Guarantee will be your sole and exclusive remedy for breach of any warranty, guarantee or condition, express or implied, in respect of this Product and neither SCEE nor any other Sony entity, or their suppliers or authorised service facilities, will be liable for any incidental or consequential loss or damage.

If this Product needs any repair which is not covered by this Guarantee, please call your local Customer Service Helpline for advice. If your home country is not one of those listed, please contact your retailer.

Please complete and return the enclosed (Freepost) Customer Registration Card.



A limited number of PlayStation® format software titles may not play or play differently on the PlayStation®2 computer entertainment system. This is primarily due to design variations in PlayStation® format software. For further information on individual software titles, please contact the appropriate PlayStation® customer service helpline which can be found:

- on the customer registration card;
- within every PlayStation® and PlayStation®2 format software manual.

"PS", "PlayStation", "PSS", "DUALSHOCK" and "△○×□" are registered trademarks of Sony Computer Entertainment Inc.

"SONY" and "SONY" are registered trademarks and **MAGICGATE** is a trademark of Sony Corporation.

Printed in China

www.playstation.com

Free Manuals Download Website

<http://myh66.com>

<http://usermanuals.us>

<http://www.somanuals.com>

<http://www.4manuals.cc>

<http://www.manual-lib.com>

<http://www.404manual.com>

<http://www.luxmanual.com>

<http://aubethermostatmanual.com>

Golf course search by state

<http://golfingnear.com>

Email search by domain

<http://emailbydomain.com>

Auto manuals search

<http://auto.somanuals.com>

TV manuals search

<http://tv.somanuals.com>