

**SONY®**

# User Guide

Personal Computer  
VPCP11 Series



# Contents

|  |    |   |     |
|--|----|---|-----|
| Before Use.....                                  | 4  | Using the Wireless LAN.....                         | 61  |
| Finding More about Your VAIO Computer .....      | 5  | Using the Wireless WAN .....                        | 66  |
| Ergonomic Considerations .....                   | 8  | Using the Bluetooth Function .....                  | 70  |
| Getting Started.....                             | 10 | Using the GPS Function .....                        | 76  |
| Locating Controls and Ports.....                 | 11 | Using Various Functions with Built-in Sensors ..... | 77  |
| About the Indicator Lights .....                 | 16 | Using Peripheral Devices.....                       | 84  |
| Holding Your Computer.....                       | 17 | Using the Noise Canceling Headphones.....           | 85  |
| Connecting a Power Source .....                  | 19 | Connecting a Display/LAN Adapter .....              | 92  |
| Using the Battery Pack.....                      | 21 | Connecting an Optical Disc Drive .....              | 94  |
| Shutting Down Your Computer Safely .....         | 29 | Connecting External Speakers or Headphones .....    | 96  |
| Using the Power Saving Modes .....               | 30 | Connecting an External Display .....                | 97  |
| Keeping Your Computer in Optimum Condition ..... | 32 | Selecting Display Modes .....                       | 99  |
| Using Your VAIO Computer.....                    | 34 | Using the Multiple Monitors Function .....          | 100 |
| Using the Keyboard.....                          | 35 | Connecting a USB Device .....                       | 102 |
| Using the Pointing Device .....                  | 37 | Customizing Your VAIO Computer.....                 | 104 |
| Using Special-function Buttons .....             | 41 | Setting the Password.....                           | 105 |
| Using the Quick Web Access Function .....        | 43 | Using Intel(R) VT .....                             | 112 |
| Using the Built-in Camera .....                  | 45 | Using the VAIO Control Center .....                 | 113 |
| Using "Memory Stick".....                        | 46 | Using the VAIO Power Management.....                | 114 |
| Using Other Modules / Memory Cards.....          | 54 |   |     |
| Using the Internet.....                          | 59 |   |     |
| Using the Network (LAN) .....                    | 60 |   |     |

|  |     |                      |     |
|--|-----|----------------------|-----|
| Precautions.....                           | 115 | Printing .....       | 165 |
| Safety Information.....                    | 116 | Microphone.....      | 166 |
| Care and Maintenance Information.....      | 120 | Speakers .....       | 167 |
| Handling Your Computer.....                | 121 | Pointing Device..... | 169 |
| Handling the LCD Screen .....              | 124 | Keyboard .....       | 170 |
| Using the Power Source .....               | 125 | Floppy Disks .....   | 171 |
| Handling the Built-in Camera .....         | 126 | Audio/Video .....    | 172 |
| Handling Discs .....                       | 127 | "Memory Stick" ..... | 174 |
| Using the Battery Pack.....                | 128 | Peripherals .....    | 175 |
| Handling "Memory Stick".....               | 129 | Trademarks .....     | 176 |
| Handling the Built-in Storage Device ..... | 130 | Notice .....         | 178 |
| Handling the Display/LAN Adapter.....      | 131 |                      |     |
| Troubleshooting .....                      | 132 |                      |     |
| Computer Operations.....                   | 134 |                      |     |
| System Update / Security.....              | 142 |                      |     |
| Recovery .....                             | 144 |                      |     |
| Battery Pack.....                          | 147 |                      |     |
| Built-in Camera .....                      | 149 |                      |     |
| Networking (LAN/Wireless LAN) .....        | 151 |                      |     |
| Wireless WAN .....                         | 155 |                      |     |
| Bluetooth Technology .....                 | 156 |                      |     |
| Optical Discs .....                        | 160 |                      |     |
| GPS.....                                   | 161 |                      |     |
| Display .....                              | 162 |                      |     |

# Before Use

Congratulations on your purchase of this Sony VAIO® computer and welcome to the on-screen **User Guide**. Sony has combined leading-edge technology in audio, video, computing, and communications to provide you with a state-of-the-art computing experience.



External views illustrated in this manual may look slightly different from those of your computer.



## How to find specifications

Some features, options, and supplied items may not be available on your computer.

To find out about the configuration of your computer, visit the VAIO Link web site at <http://support.vaio.sony.eu/>.

# Finding More about Your VAIO Computer

This section provides support information about your VAIO computer.

## 1. Printed Documentation

- ❑ **Quick Start Guide** — An overview of components connection, set-up information, etc.
- ❑ **Recovery, Backup and Troubleshooting Guide**
- ❑ **Regulations, Guarantee and Service Support**



Before activating the wireless functions such as the wireless LAN and Bluetooth technology, read the **Regulations, Guarantee and Service Support** carefully.

## 2. On-screen Documentation

- ❑ **User Guide** (This manual) — Features of your computer and information about solving common problems.

To view this on-screen guide:

- 1 Click **Start** , **All Programs**, and **VAIO Documentation**.
- 2 Open the folder for your language.
- 3 Select the guide you want to read.



You can manually browse to the user guides by going to **Computer > VAIO (C:) (your C drive) > Documentation > Documentation** and opening the folder for your language.

- ❑ **Windows Help and Support** — A comprehensive resource for practical advice, tutorials, and demonstrations to help you learn to use your computer.

To access **Windows Help and Support**, click **Start** and **Help and Support**, or press and hold the Microsoft Windows key and press the **F1** key.

### 3. Support Web Sites

If you have any problem with the computer, visit the VAIO-Link web site at <http://support.vaio.sony.eu/> for troubleshooting guidance.

Some other information resources are also available:

- ❑ The Club VAIO community at <http://club-vaio.com> provides the possibility to ask questions to other VAIO users.
- ❑ For product information, you can visit our products web site at <http://www.vaio.eu/>, or our online store at <http://www.sonystyle-europe.com>.

In case you need to contact VAIO-Link, have the serial number of your VAIO computer ready at hand. The serial number is located on the bottom, the back panel, or inside the battery compartment of your VAIO computer. If you have problems locating your serial number, more guidance can be found on the VAIO-Link web site.

## Ergonomic Considerations

You will be using your computer as a portable device in a variety of environments. Whenever possible, you should attempt to take account of the following ergonomic considerations for both stationary and portable environments:

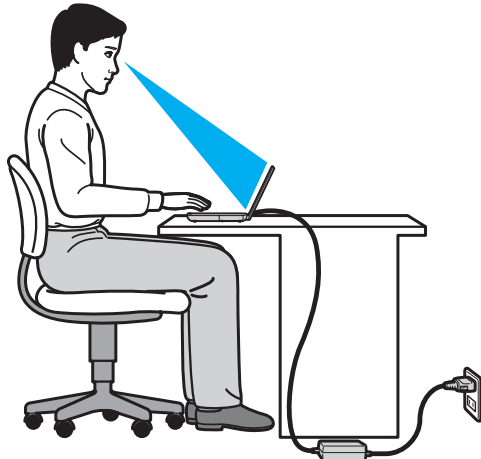

- ❑ **Position of your computer** – Place the computer directly in front of you. Keep your forearms horizontal, with your wrists in a neutral, comfortable position while using the keyboard or the pointing device. Let your upper arms hang naturally at your sides. Take frequent breaks while using your computer. Excessive use of the computer may strain eyes, muscles, or tendons.
- ❑ **Furniture and posture** – Sit in a chair with good back support. Adjust the level of the chair so your feet are flat on the floor. A footrest may make you more comfortable. Sit in a relaxed, upright posture and avoid slouching forward or leaning far backwards.



- ❑ **Viewing angle of the computer display** – Use the display tilting feature to find the best position. You can reduce eye strain and muscle fatigue by adjusting the tilt of the display to the proper position. Adjust the brightness level of the display as well.
- ❑ **Lighting** – Choose a location where windows and lights do not cause glare and reflection on the display. Use indirect lighting to avoid bright spots on the display. Proper lighting adds to your comfort and work efficiency.
- ❑ **Positioning an external display** – When using an external display, set the display at a comfortable viewing distance. Make sure the display screen is at or slightly below eye level when you are sitting in front of the monitor.

# Getting Started

This section describes how to get started using your VAIO computer.

- ❑ **Locating Controls and Ports** ([page 11](#))
- ❑ **About the Indicator Lights** ([page 16](#))
- ❑ **Holding Your Computer** ([page 17](#))
- ❑ **Connecting a Power Source** ([page 19](#))
- ❑ **Using the Battery Pack** ([page 21](#))
- ❑ **Shutting Down Your Computer Safely** ([page 29](#))
- ❑ **Using the Power Saving Modes** ([page 30](#))
- ❑ **Keeping Your Computer in Optimum Condition** ([page 32](#))

## Locating Controls and Ports

Take a moment to identify the controls and ports shown on the following pages.

! The appearance of your computer may be different from those illustrated in this manual due to variations in specifications.

### Front

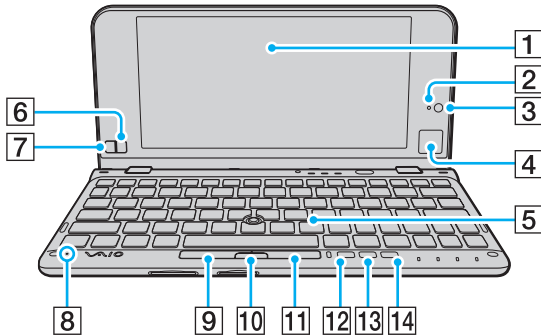

- 1 LCD screen ([page 124](#))
- 2 Built-in MOTION EYE camera indicator ([page 16](#))
- 3 Built-in MOTION EYE camera ([page 45](#))
- 4 Touch pad ([page 40](#))
- 5 Keyboard ([page 35](#))
- 6 Right button ([page 40](#))
- 7 Left button ([page 40](#))
- 8 Built-in microphone (monaural)
- 9 Left button ([page 38](#))
- 10 Center button ([page 38](#))
- 11 Right button ([page 38](#))
- 12 **ASSIST** button ([page 41](#))
- 13 Resolution Change button ([page 41](#))
- 14 **WEB** button ([page 41](#))

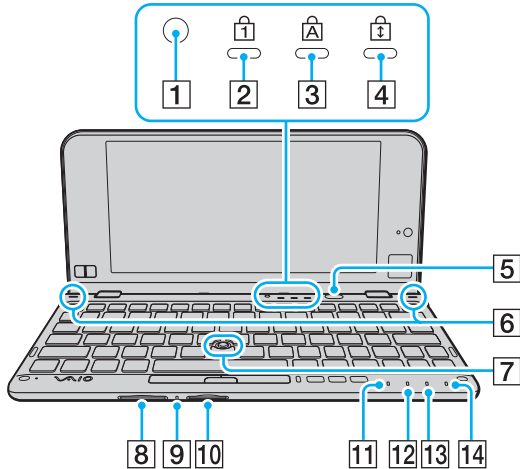

- 1** Ambient light sensor (page 164)  
Measures ambient light intensity for automatically adjusting the LCD brightness to an optimum level.
- 2** Num lock indicator (page 16)
- 3** Caps lock indicator (page 16)
- 4** Scroll lock indicator (page 16)
- 5** Power button
- 6** Built-in speakers (stereo)
- 7** Pointing stick (page 37)
- 8** SD memory card slot (page 54)
- 9** Media Access indicator (page 16)
- 10** "Memory Stick Duo" slot\* (page 46)
- 11** Power indicator (page 16)
- 12** Charge indicator (page 16)
- 13** Disc drive indicator (page 16)
- 14** **WIRELESS** indicator (page 16)

\* Your computer supports only Duo-size "Memory Stick".

## Right

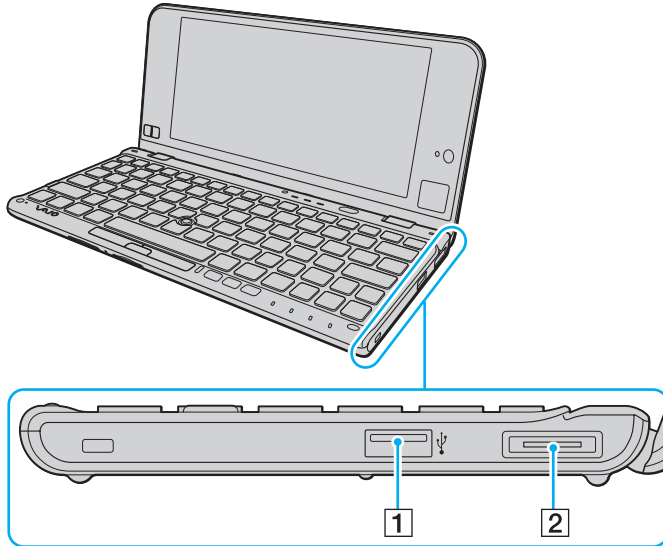

1 USB port\* ([page 102](#))

2 I/O port ([page 93](#))

\* Compliant with the USB 2.0 standard and supports high-/full-/low- speeds.

## Left

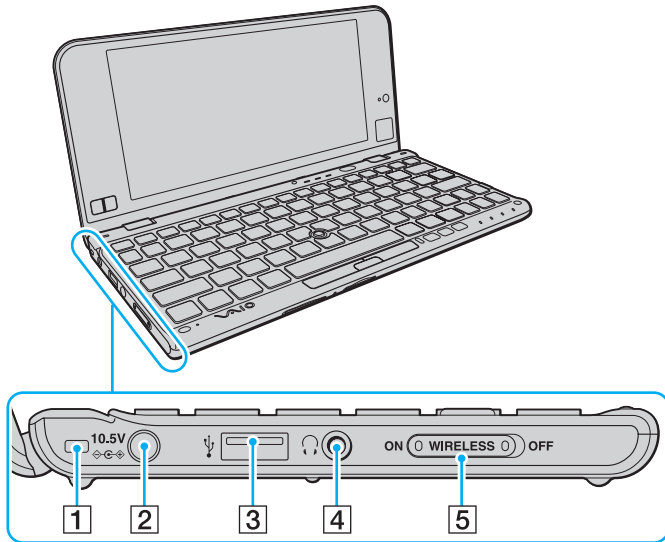

- 1 Strap hole (page 18)
- 2 DC IN port (page 19)
- 3 USB port\* (page 102)
- 4 Headphones jack (page 85), (page 96)
- 5 **WIRELESS** switch (page 61), (page 66), (page 70), (page 76)

\* Compliant with the USB 2.0 standard and supports high-/full-/low- speeds.

## Back

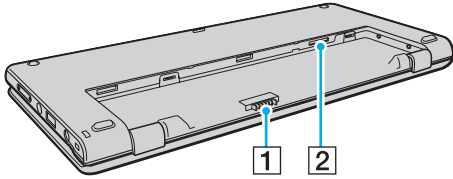







1 Battery connector ([page 21](#))

2 SIM card slot\* ([page 66](#))

\* On models with the wireless WAN function.

## About the Indicator Lights

Your computer is equipped with the following indicator lights:

| Indicator   | Functions   |
|---|---|
| Power        | Illuminates in green while the computer is in Normal mode, blinks slowly in orange while the computer is in Sleep mode, and turns off when the computer is turned off or enters Hibernate mode.   |
| Charge       | Illuminates while the battery pack is charging. See <b>Charging the Battery Pack</b> ( <a href="#">page 25</a> ) for more information.  |
| Built-in MOTION EYE camera  | Illuminates while the built-in camera is in use.  |
| Media Access  | Illuminates while data access to a memory card, such as "Memory Stick" and an SD memory card, is in progress. (Do not place the computer into Sleep mode or turn it off while this indicator light is lit.) When the indicator light is unlit, the memory card is not in use.                     |
| Disc drive   | Illuminates while data access to the built-in storage device is in progress. Do not place the computer into Sleep mode or turn it off while this indicator light is lit.  |
| Num lock     | Press the <b>Num Lk</b> key to activate the numeric keypad. Press it a second time to deactivate the numeric keypad. The numeric keypad is not active when the indicator light is unlit.  |
| Caps lock    | Press the <b>Caps Lock</b> key to type letters in uppercase. Letters appear in lowercase if you press the <b>Shift</b> key while the indicator light is lit. Press the key a second time to turn off the indicator light. Normal typing resumes when the Caps lock indicator light is turned off. |
| Scroll lock  | Press the <b>Fn+Scr Lk</b> keys to change how you scroll the display. Normal scrolling resumes when the Scroll lock indicator light is turned off. The <b>Scr Lk</b> key functions differently depending on the program you are using and does not work with all programs.                        |
| <b>WIRELESS</b>   | Illuminates while one or more wireless options are enabled.   |



## Holding Your Computer

You can hold your computer in both hands and operate it as illustrated below.



Be sure to use the supplied hand strap to prevent accidental dropping of the computer.



For information on how to use the touch pad and the buttons, see **Using the Touch Pad** ([page 40](#)).

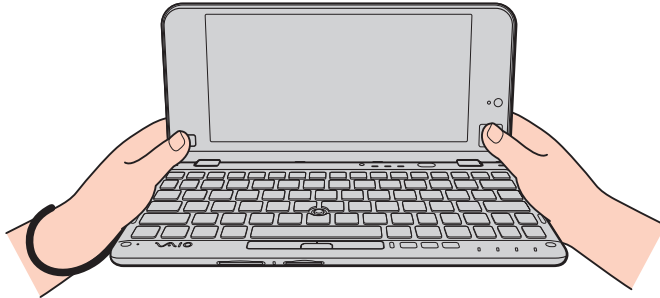

## Attaching the Hand Strap

To prevent accidental dropping, be sure to fasten the supplied hand strap to your computer through the strap hole ([page 14](#)) and use the hand strap whenever you operate the computer while holding it in both hands.

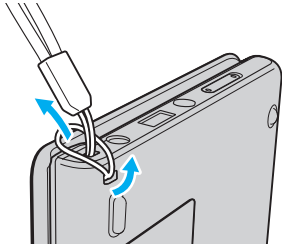

! Do not wear the hand strap around your neck.

Do not grasp the hand strap to carry your computer around as it may cause the computer to hit against surrounding objects, resulting in damage to the computer.

## Connecting a Power Source

You can use either an AC adapter or a rechargeable battery pack for supplying power to your computer. Before using the computer for the first time, you need to connect an AC adapter to your computer.

! Do not use your computer without installing the battery pack as it may cause the computer to malfunction.

### Using the AC Adapter

While your computer is directly connected to an AC power source and has a battery pack installed, it uses power from the AC outlet.



Use only the supplied AC adapter for your computer.

#### To use the AC adapter

- 1 Plug one end of the power cord (1) into the AC adapter (3).
- 2 Plug the other end of the power cord into an AC outlet (2).
- 3 Plug the cable from the AC adapter (3) into the DC IN port (4) on the computer.

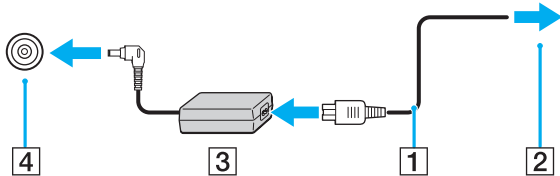

! The shape of the DC In plug varies depending on the AC adapter.



To disconnect your computer completely from an AC power source, unplug the AC adapter from the AC outlet.

Make sure that an AC outlet is easily accessible.

If you do not intend to use your computer for an extended period of time, place the computer into Hibernate mode. See **Using Hibernate Mode (page 31)**.

## Using the Battery Pack

The battery pack is already installed on your computer at the time of delivery but is not fully charged.

! Do not use your computer without installing the battery pack as it may cause the computer to malfunction.

### Installing/Removing the Battery Pack

To install the battery pack

- 1 Turn off the computer and close the LCD screen lid.
- 2 Slide the battery **LOCK** switch (1) inward.

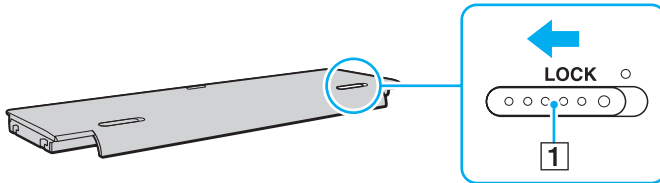

- 3 Fit the battery pack into the battery compartment.  
The battery pack should be level with the bottom of the computer.

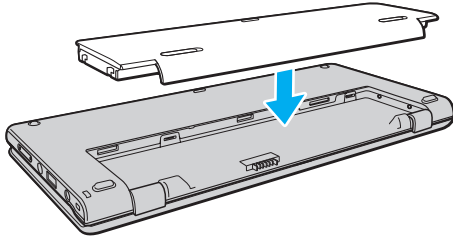

- 4 Slide the battery pack toward the front of the computer until it clicks into place.

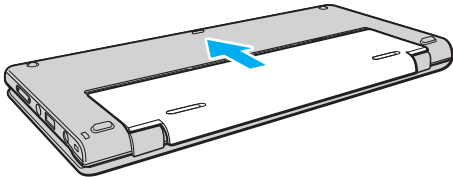

- 5 Slide the battery **LOCK** switch outward to secure the battery pack on the computer.

## To remove the battery pack

! You will lose all unsaved data if you remove the battery pack while your computer is on and not connected to the AC adapter.

- 1 Turn off the computer and close the LCD screen lid.
- 2 Slide the battery **LOCK** switch (1) inward.
- 3 Slide and hold the battery **RELEASE** latch (2) inward and slightly slide the battery pack toward the back of the computer.

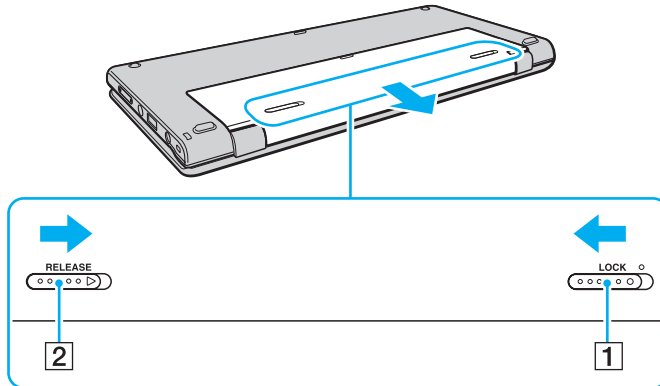

- 4 Hold the battery pack with your fingertips as illustrated below, lift it in the direction of the arrow, and then take it out of the battery compartment.

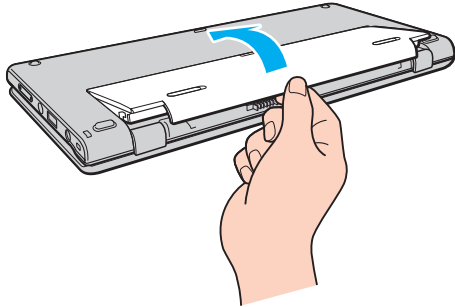

**!** For your safety, it is highly recommended that you use genuine Sony rechargeable battery packs and AC adapters that meet the quality assurance standard, supplied by Sony for your VAIO computer. Some VAIO computers may only function with a genuine Sony battery pack.



## Charging the Battery Pack

The battery pack supplied with your computer is not fully charged at the time of delivery.

To charge the battery pack

- 1 Install the battery pack.
- 2 Connect the computer to a power source with the AC adapter.  
The charge indicator light is on while the battery pack is charging. When the battery pack charges close to the maximum charge level you selected, the charge indicator turns off.

| Charge indicator status                      | Meaning  |
|--|--|
| Lit in orange                                | The battery pack is charging.  |
| Blinks along with the green power indicator  | The battery pack is running out of power. (Normal mode)                                |
| Blinks along with the orange power indicator | The battery pack is running out of power. (Sleep mode)                                 |
| Blinks fast in orange                        | A battery error has occurred due to a failed battery pack or an unlocked battery pack. |

**!** Charge the battery pack as described in this manual from your first battery charge.



Keep the battery pack in your computer while it is directly connected to an AC power source. The battery pack continues to charge while you are using the computer.

When the battery pack is running out of power and both the charge and power indicator lights blink, you should either connect the AC adapter to recharge the battery pack or shut down your computer and install a fully charged battery pack.

Your computer is supplied with a lithium ion battery pack and can be recharged any time. Charging a partially discharged battery pack does not affect the life of battery.

While some software applications or peripheral devices are in use, your computer may not enter Hibernate mode even when the remaining battery life becomes short. To avoid loss of data while the computer is running on the battery, you should save your data frequently and manually activate a power management mode, such as Sleep or Hibernate.

If the battery pack runs out of power while the computer is in Sleep mode, you will lose all unsaved data. Going back to the previous work state is impossible. To avoid loss of data, you should save your data frequently.

## Checking the Battery Charge Capacity

The battery charge capacity gradually decreases as the number of battery charging increases or the duration of use of the battery pack extends. To get the most out of the battery pack, check the battery charge capacity and change the battery settings.

To check the battery charge capacity

- 1 Click **Start**, **All Programs**, and **VAIO Control Center**.
- 2 Click **Power Management** and **Battery**.



Additionally, you can enable the battery care function to extend the life of the battery pack.

## Extending the Battery Life

When your computer is running on battery power, you can extend the battery life using the following methods.

- ❑ Decrease the LCD brightness of your computer screen.
- ❑ Use the power saving mode. See **Using the Power Saving Modes (page 30)** for more information.
- ❑ Change the power saving settings on the **Power Options**. See **Using the VAIO Power Management (page 114)** for more information.
- ❑ Set the wallpaper in **Long Battery Life Wallpaper Setting** as your desktop background with the **VAIO Control Center**.

## Shutting Down Your Computer Safely

To avoid losing unsaved data, be sure to shut down your computer properly, as described below.

To shut down your computer

- 1 Turn off any peripherals connected to the computer.
- 2 Click **Start** and the **Shut down** button.
- 3 Respond to any prompts warning you to save documents or to consider other users and wait for the computer to turn off automatically.  
The power indicator light turns off.

## Using the Power Saving Modes

You can take advantage of the power management settings to conserve battery life. In addition to the normal operating mode, your computer has two distinct power saving modes to suit your preference: Sleep and Hibernate.

! If you do not intend to use your computer for an extended period of time while it is disconnected from an AC power source, place the computer into Hibernate mode or turn it off.

If the battery pack runs out of power while your computer is in Sleep mode, you will lose all unsaved data. Going back to the previous work state is impossible. To avoid loss of data, you should save your data frequently.

| Mode           | Description   |
|----------------|---|
| Normal mode    | This is the normal state of your computer while it is in use. The green power indicator light is lit while the computer is in this mode.  |
| Sleep mode     | Sleep mode turns off the LCD screen and places the built-in storage device(s) and the CPU into a low power consumption mode. The orange power indicator light blinks slowly while your computer is in this mode. Your computer comes out of Sleep mode quicker than out of Hibernate mode. However, Sleep mode uses more power than Hibernate mode. |
| Hibernate mode | While your computer is in Hibernate mode, the state of the system is saved on the built-in storage device(s) and power is turned off. Even when the battery pack runs out of power, no data will be lost. The power indicator light is unlit while your computer is in this mode.   |

## Using Sleep Mode

To activate Sleep mode

Click **Start**, the arrow  next to the **Shut down** button, and **Sleep**.

To return to Normal mode

- Press any key.
- Press the power button on your computer.

! If you press and hold the power button for more than four seconds, your computer will turn off automatically. You will lose all unsaved data.

## Using Hibernate Mode

To activate Hibernate mode

Press the **Fn+F12** keys.

Alternatively, you can click **Start**, the arrow next to the **Shut down** button, and **Hibernate**.

! Do not move your computer before its power indicator light turns off.

To return to Normal mode

Press the power button.

! If you press and hold the power button for more than four seconds, your computer will turn off automatically.

# Keeping Your Computer in Optimum Condition

## Updating Your Computer

Be sure to update your VAIO computer with the following software applications for enhancing your computer's efficiency, security, and functionality.

The **VAIO Update** automatically notifies you of new updates available on the Internet, and downloads and installs them on the computer.

**Windows Update**

Click **Start, All Programs, and Windows Update** and then follow the on-screen instructions.

**VAIO Update 5**

Click **Start, All Programs, and VAIO Update 5** and then follow the on-screen instructions.



Your computer must be connected to the Internet to download the updates.



## Using the VAIO Care

With the **VAIO Care**, you can regularly conduct performance checks and tune-ups on your computer to keep it running at an optimum level. Launch the **VAIO Care** whenever a problem is found on your computer. The **VAIO Care** will provide appropriate measures to solve the problem.

### To launch the VAIO Care

- ❑ On models with the **ASSIST** button  
Press the **ASSIST** button while your computer is on.
- ❑ On models without the **ASSIST** button  
Click **Start, All Programs, VAIO Care, and VAIO Care.**



Do not press the **ASSIST** button while the computer is in Hibernate mode.



See the help file included with the **VAIO Care** for more information.

On models with the **ASSIST** button, pressing the **ASSIST** button while the computer is off launches the **VAIO Care Rescue**. The **VAIO Care Rescue** can be used to recover your computer in case of emergency, for example, when the Windows does not start.

# Using Your VAIO Computer

This section describes how to get the most out of using your VAIO computer.

- ❑ **Using the Keyboard** ([page 35](#))
- ❑ **Using the Pointing Device** ([page 37](#))
- ❑ **Using Special-function Buttons** ([page 41](#))
- ❑ **Using the Quick Web Access Function** ([page 43](#))
- ❑ **Using the Built-in Camera** ([page 45](#))
- ❑ **Using "Memory Stick"** ([page 46](#))
- ❑ **Using Other Modules / Memory Cards** ([page 54](#))
- ❑ **Using the Internet** ([page 59](#))
- ❑ **Using the Network (LAN)** ([page 60](#))
- ❑ **Using the Wireless LAN** ([page 61](#))
- ❑ **Using the Wireless WAN** ([page 66](#))
- ❑ **Using the Bluetooth Function** ([page 70](#))
- ❑ **Using the GPS Function** ([page 76](#))
- ❑ **Using Various Functions with Built-in Sensors** ([page 77](#))





## Using the Keyboard



Your keyboard has additional keys that perform model-specific tasks.

### Combinations and Functions with the Fn Key



Some keyboard functions can be used only after the operating system is finished launching.

| Combination/Feature  | Function   |
|--|--|
| <b>Fn +  (F2): muting</b>   | Turns on and off the built-in speakers or the headphones.  |
| <b>Fn +  (F3/F4): volume control</b>  | Changes the volume level.<br>To increase the volume, keep pressing the <b>Fn+F4</b> keys or press the <b>Fn+F4</b> keys and then the <b>↑</b> or <b>→</b> key.<br>To decrease the volume, keep pressing the <b>Fn+F3</b> keys or press the <b>Fn+F3</b> keys and then the <b>↓</b> or <b>←</b> key.  |
| <b>Fn +  (F5/F6): brightness control</b>  | Changes the LCD brightness of your computer screen.<br>To increase lighting intensity, keep pressing the <b>Fn+F6</b> keys or press the <b>Fn+F6</b> keys and then the <b>↑</b> or <b>→</b> key.<br>To decrease lighting intensity, keep pressing the <b>Fn+F5</b> keys or press the <b>Fn+F5</b> keys and then the <b>↓</b> or <b>←</b> key.  |
| <b>Fn +  /  (F7): display output</b> | Switches the display output between your computer screen and an external display. Press the <b>Enter</b> key to select the display output.<br><br><b>!</b><br>If you disconnect a display cable from your computer while an external display is selected as the display output destination, the computer screen goes blank. In such a case, press the <b>F7</b> key twice while holding down the <b>Fn</b> key, and then press the <b>Enter</b> key to switch the display output to the computer screen.<br><br>Use of multiple monitors may not be supported depending on the connected external display. |

| Combination/Feature  | Function   |
|--|--|
| Fn +  /  (F9/F10): zooming | <p>Changes the size of an image or a document displayed on some software.</p> <p>To make the view look smaller and further away (zoom out), press the <b>Fn+F9</b> keys.</p> <p>To make the view look bigger and closer (zoom in), press the <b>Fn+F10</b> keys.</p> <p>See the help file included with the <b>VAIO Control Center</b> for more information.</p>   |
| Fn +  (F12): hibernation  | <p>Provides the lowest level of power consumption. When you execute this command, the states of the system and the connected peripheral devices are saved to the built-in storage device and the system power is turned off. To return the system to its original state, use the power button to turn on the power.</p> <p>For details on power management, see <b>Using the Power Saving Modes</b> (<a href="#">page 30</a>).</p> |

## Using the Pointing Device

Your computer is equipped with two types of cursor-pointing devices: the pointing stick and the touch pad.



You can disable/enable the pointing devices. To change the pointing device settings, use the **VAIO Control Center**.



Be sure to connect a mouse before disabling both pointing devices (the pointing stick and the touch pad). If you disable both devices before connecting a mouse, you will be able to use only the keyboard for pointer operations.

Simultaneous use of the two pointing devices is not possible. If you attempt to use the pointing stick and the touch pad simultaneously, the pointing device you touched later may not work for several seconds. In this case, take your fingers off the pointing devices and wait for several seconds.

## Using the Pointing Stick

The keyboard contains the pointing stick (1). You can point to, select, drag, and scroll objects on the screen using the pointing stick in combination with the buttons located below the space bar.

The pointer (2) moves in the direction that you push the pointing stick. The stronger you push the pointing stick, the faster the pointer moves.

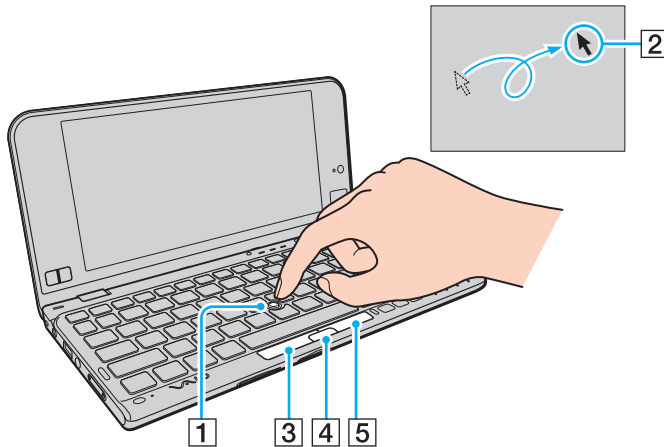

| Action       | Description  |
|--------------|--|
| Point        | Push the pointing stick to place the pointer on an item or object.   |
| Click        | Press the left button (3) or tap on the pointing stick once.   |
| Double-click | Press the left button or tap on the pointing stick twice in a row.   |
| Right-click  | Press the right button (5) once. With many applications, this action displays a context-sensitive shortcut menu (if any).  |
| Drag         | Push the pointing stick in your desired direction while pressing the left button. Alternatively, you can tap on the pointing stick twice in a row and, without taking your finger off the pointing stick on the second tap, push it in your desired direction. To drop the dragging object, take your finger off the pointing stick. |
| Scroll       | Push the pointing stick up and down or sideways while pressing the center button (4). (The scroll function is available only with applications that support a pointing stick scroll feature.)  |



The pointer may move on its own on rare occasions, which does not indicate a malfunction. Leave the pointing stick untouched for a while. The pointer will behave normally.

The tip on the pointing stick is a consumable. You can replace it with the supplied spare cap when necessary.

## Using the Touch Pad

The touch pad (1) is located at the lower-right corner of the LCD screen. You can point to, select, drag, and scroll objects on the screen using the touch pad in combination with the buttons located at the lower-left corner of the LCD screen.

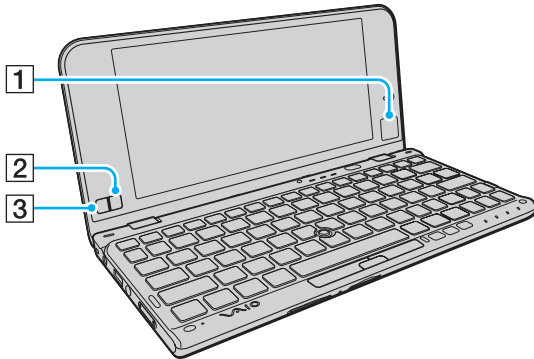



| Action       | Description  |
|--------------|--|
| Point        | Slide your fingertip on the touch pad (1) to place the pointer on an item or object.   |
| Click        | Press the left button (3) or tap on the touch pad once.  |
| Double-click | Press the left button or tap on the touch pad twice in a row.  |
| Right-click  | Press the right button (2) once. With many applications, this action displays a context-sensitive shortcut menu (if any).  |
| Drag         | Slide your fingertip on the touch pad while pressing the left button. Alternatively, you can tap on the touch pad twice in a row and, without taking your fingertip off the touch pad on the second tap, slide it in your desired direction. To drop the dragging object, take your fingertip off the touch pad. |
| Scroll       | Press and hold the right button and the left button simultaneously and slide your fingertip up to scroll up or down to scroll down. (The scroll function is available only with applications that support a touch pad scroll feature.)   |



## Using Special-function Buttons

Your computer is equipped with special buttons to help you use specific functions of the computer.

| Special-function button  | Functions   |
|--|---|
| ASSIST button             | <p>Launches the <b>VAIO Care</b> while the computer is on.<br/>While the computer is off, the <b>ASSIST</b> button launches the <b>VAIO Care Rescue</b>.</p> <p>!</p> <p>Do not press the <b>ASSIST</b> button while the computer is in Hibernate mode.</p>   |
| Resolution Change button  | <p>Changes your screen resolution.<br/>Standard view: 1600 x 768 pixels<br/>Magnified view: 1280 x 600 pixels</p> <p>!</p> <p>The button is disabled during video playback. Be sure to exit video playback software before pressing the button.</p> <p>The button may not work with graphic images as it magnifies the screen view by changing the screen resolution.</p> <p>The location and size of software window may change when the screen resolution is magnified or the standard view is restored.</p> <p>While your computer screen resolution is magnified, the entire screen may not be visible completely.</p> <p>The magnified view is not as clear as the standard view, as it is implemented by applying a lower resolution to the computer screen with a higher resolution.</p> <p>The button works only when the computer is selected as the display output destination.</p> |

| Special-function button   | Functions  |
|---|--|
| <b>WEB</b> button  | <p>While the computer is in Normal mode, the <b>WEB</b> button launches the web browser assigned to the button by default.</p> <p>While the computer is off, the <b>WEB</b> button activates the Quick Web Access function and launches the web browser used with this function. See <b>Using the Quick Web Access Function (page 43)</b> for more information.</p> <p>!</p> <p>The <b>WEB</b> button is not functional while the computer is in Sleep mode or Hibernate mode.</p> |

## Using the Quick Web Access Function

The Quick Web Access function enables you immediately to access the Internet without launching the Windows operating system.

### Activating the Quick Web Access Function

To activate the Quick Web Access function, your computer must be off.

To activate the Quick Web Access function

- 1 Press the **WEB** button on the computer.
- 2 Follow the instructions in the initial setup wizard.  
Once you have completed the initial setup, the web browser used with the Quick Web Access function launches just by pressing the **WEB** button from the next time.

### Exiting the Quick Web Access Function

! To launch the Windows operating system, you first need to exit the Quick Web Access function.

To exit the Quick Web Access function, do any of the following:

- Click the  icon located at the lower left corner of the screen.
- Press the **WEB** button.
- Press the power button on the computer.

For detailed information on how to use or restrictions on the Quick Web Access function, click the  icon located at the lower right corner of the screen.

## Notes on Using the Quick Web Access Function

While the Quick Web Access function is activated, you cannot use:

- ❑ the **Scr Lk** key in combination with the **Fn** key for a shortcut.
- ❑ any port and jack except the DC IN port, the network (LAN) port, the USB ports, and the headphones jack.
- ❑ the "Memory Stick Duo" slot, the **SD** memory card slot, and the ExpressCard slot.

## Using the Built-in Camera

Your computer is equipped with a built-in MOTION EYE camera.

With the communication software, such as the **Skype**, you can make a video call through the Internet.



Turning on the computer activates the built-in camera.

Video calls are possible with the appropriate software.



Launching or exiting your instant messaging or video editing software does not activate or deactivate the built-in camera.

Do not place your computer into Sleep or Hibernate mode while you are using the built-in camera.

## Using "Memory Stick"

"Memory Stick" is a compact, portable, and versatile IC recording media especially designed for exchanging and sharing digital data with compatible products, such as digital cameras, mobile phones, and other devices. Because it is removable, it can be used for external data storage.

### Before You Use "Memory Stick"

The "Memory Stick Duo" slot on your computer can accommodate the following sizes and types of media:

- "Memory Stick Duo"
- "Memory Stick PRO Duo"
- "Memory Stick PRO-HG Duo"

!

Your computer supports only Duo-size "Memory stick", and does not support standard-size "Memory Stick".

For the latest information about "Memory Stick", visit [memorystick.com] at <http://www.memorystick.com/en/>.

## Inserting and Removing "Memory Stick"

### To insert "Memory Stick"

**!** Your computer is supplied with a slot protector in the "Memory Stick Duo" slot. Remove the slot protector before you use the slot.

- 1** Locate the "Memory Stick Duo" slot.
- 2** Push the "Memory Stick Duo" slot protector so that the protector pops out.
- 3** Gently take hold of the "Memory Stick Duo" slot protector and pull it out of the slot.
- 4** Hold "Memory Stick" with the arrow pointing toward the slot.

- 5 Carefully slide "Memory Stick" into the slot until it clicks into place.  
Do not force the media into the slot.



If "Memory Stick" does not go into the slot easily, remove it gently and verify you are inserting it in the proper direction.

When you insert "Memory Stick" into the slot for the first time, you may be prompted to install driver software. If prompted, follow the on-screen instructions to install the software.

"Memory Stick" is automatically detected by your system and the contents of "Memory Stick" are displayed. If nothing appears on the desktop, click **Start, Computer**, and double-click the "Memory Stick" icon.

The "Memory Stick" icon will appear in the **Computer** window after you insert "Memory Stick" into the slot.

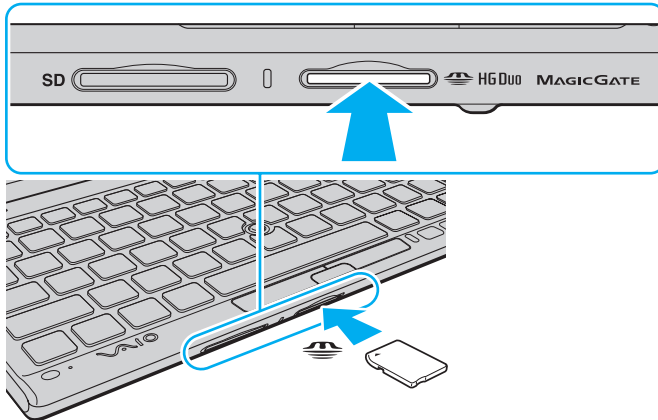



**!** Before using "Memory Stick Micro" ("M2"), be sure to insert it into an "M2" Duo adaptor. If you insert the media directly into the "Memory Stick Duo" slot without the adaptor, you may not be able to remove it from the slot.

## To remove "Memory Stick"

**!** Do not remove "Memory Stick" while the Media Access indicator light is lit. If you do, you may lose data. Large volumes of data may take time to load, so make sure the indicator light is unlit before removing "Memory Stick".

Insert the "Memory Stick Duo" slot protector to block any particles from entering the slot when not using "Memory Stick". Before moving your computer, be sure to insert the "Memory Stick Duo" slot protector into the slot.

- 1** Locate the "Memory Stick Duo" slot.
- 2** Check that the Media Access indicator light is unlit.
- 3** Push in "Memory Stick" toward the computer and release. "Memory Stick" ejects.
- 4** Pull "Memory Stick" out of the slot.

**!** Be sure to remove "Memory Stick" gently, or it may pop out unexpectedly.

## Formatting "Memory Stick"

To format "Memory Stick"

"Memory Stick" is formatted by default and is ready for use.

If you want to reformat the media with your computer, follow these steps.

! Be sure to use the device that is designed to format the media and supports "Memory Stick" when formatting the media.

Formatting "Memory Stick" erases the entire data stored on the media. Before formatting the media, make sure that it does not contain your valuable data.

Do not remove "Memory Stick" from the slot while formatting. This could cause a malfunction.

- 1 Locate the "Memory Stick Duo" slot.
- 2 Carefully slide "Memory Stick" into the slot until it clicks into place.
- 3 Click **Start** and **Computer**.
- 4 Right-click the "Memory Stick" icon and select **Format**.
- 5 Click **Restore device defaults**.

! The size of the allocation unit and file system may change.

Do not select **NTFS** from the **File system** drop-down list as it may cause a malfunction.



The formatting process will be completed more quickly if you select **Quick Format** in **Format options**.

- 6 Click **Start**.
- 7 Follow the on-screen instructions.

! It may take time to format "Memory Stick" depending on the media type.

## Notes on Using "Memory Stick"

- ❑ Your computer has been tested and found compatible with Sony branded "Memory Stick" with capacity of up to 32 GB that are available as of January 2010. However, not all "Memory Stick" are guaranteed of compatibility.
- ❑ Be sure to hold "Memory Stick" with the arrow pointing in the correct direction as you insert it into the slot. To avoid damaging your computer or the media, do not force "Memory Stick" into the slot if you cannot insert it smoothly.
- ❑ Use care when inserting or removing "Memory Stick" from the slot. Do not force it in or out of the slot.
- ❑ Inserting "Memory Stick" with multiple conversion adaptors is not guaranteed of compatibility.
- ❑ "MagicGate" is the general name of the copyright protection technology developed by Sony. Use "Memory Stick" with the "MagicGate" logo to take advantage of this technology.
- ❑ Except for your personal use, it is against the copyright law to use any audio and/or image data you recorded without prior consent from the respective copyright holders. Accordingly, "Memory Stick" with such copyrighted data can be used only within the law.
- ❑ Do not insert more than one "Memory Stick" into the slot. Improper insertion of the media may damage both your computer and the media.

## Using Other Modules / Memory Cards

### Using the SD Memory Card

Your computer is equipped with an **SD** memory card slot. You can use this slot to transfer data among digital cameras, camcorders, music players, and other audio/video devices.

Before you use the SD memory card

The **SD** memory card slot on your computer can accommodate the following memory cards:

- SD memory card
- SDHC memory card

For the latest information on compatible memory cards, see **Finding More about Your VAIO Computer** ([page 5](#)) to visit the appropriate support web site.

## To insert an SD memory card

! Your computer is supplied with a slot protector in the **SD** memory card slot. Remove the slot protector before you use the slot.

- 1 Locate the **SD** memory card slot.
- 2 Push the **SD** memory card slot protector so that the protector pops out.
- 3 Gently take hold of the **SD** memory card slot protector and pull it out of the slot.
- 4 Hold the SD memory card with the arrow pointing toward the slot.
- 5 Carefully slide the SD memory card into the slot until it clicks into place.  
Do not force the card into the slot.

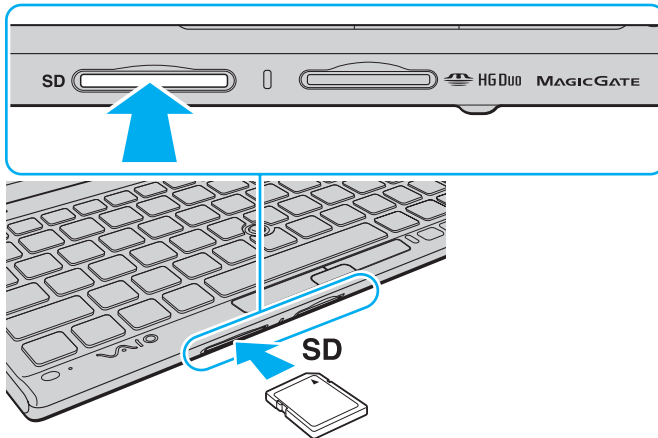



When you insert the SD memory card into the slot for the first time, you may be prompted to install driver software. If prompted, follow the on-screen instructions to install the software.

The SD memory card icon will appear in the **Computer** window after you insert the card into the slot.



## To remove an SD memory card

! Insert the **SD** memory card slot protector to block any particles from entering the slot when not using the SD memory card. Before moving your computer, be sure to insert the **SD** memory card slot protector into the slot.

- 1 Locate the **SD** memory card slot.
- 2 Check that the Media Access indicator light is unlit.
- 3 Push in the SD memory card toward the computer and release.  
The SD memory card ejects.
- 4 Pull the SD memory card out of the slot.

## Notes on Using Memory Cards

### General notes on using the memory card

- ❑ Be sure to use memory cards that are compliant with the standards supported by your computer.
- ❑ Be sure to hold the memory card with the arrow pointing in the correct direction as you insert it into the slot. To avoid damaging your computer or the media, do not force the memory card into the slot if you cannot insert it smoothly.
- ❑ Use care when inserting or removing the memory card from the slot. Do not force it in or out of the slot.
- ❑ Do not remove the memory card while the media access indicator light is lit. If you do, you may lose data.
- ❑ Do not attempt to insert a memory card or memory card adaptor of a different type into the memory card slot. An incompatible memory card or memory card adaptor may cause difficulty in removing from the slot and can cause damage to your computer.

### Notes on using the SD memory card

- ❑ Your computer has been tested and found compatible only with major memory cards available as of January 2010. However, not all memory cards are guaranteed of compatibility.
- ❑ SD memory cards with capacity of up to 2 GB and SDHC memory cards with capacity of up to 32 GB have been tested and found compatible with your computer.

## Using the Internet

Before using the Internet, you need to sign up with an Internet Service Provider (ISP) and set up devices required for connecting your computer to the Internet.

The following types of Internet connection services may be available from your ISP:

- Fiber to the Home (FTTH)
- Digital Subscriber Line (DSL)
- Cable modem
- Satellite
- Dial-up

For detailed information on devices required for Internet access and how to connect your computer to the Internet, ask your ISP.



To connect your computer to the Internet using the wireless LAN function, you need to set up the wireless LAN network. See **Using the Wireless LAN (page 61)** for more information.



When you connect your computer to the Internet, be sure to take appropriate security measures to protect the computer against online threats.

Depending on the service contract with your ISP, you may need to connect an external modem device, for example a USB telephone modem, a DSL modem, or a cable modem, to your computer to connect to the Internet. For detailed instructions on connection setups and modem configuration, see the manual that came with your modem.

## Using the Network (LAN)

You need the display/LAN adapter to connect your computer to 1000BASE-T/100BASE-TX/10BASE-T type networks with a LAN cable. Connect one end of a LAN cable (not supplied) to the network (LAN) port on the display/LAN adapter and the other end to your network. For detailed settings and devices required for LAN access, ask your network administrator.

! You cannot configure your network before connecting the display/LAN adapter to your computer. See **Connecting a Display/LAN Adapter (page 92)** for more information on the display/LAN adapter.

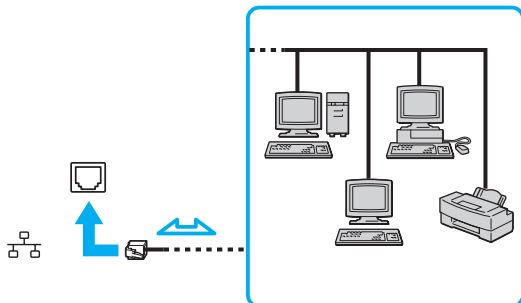

You can connect your computer to any network without changing the default settings.

! Do not plug a telephone cable into the network (LAN) port on the display/LAN adapter. If the network (LAN) port is connected to one of the telephone lines mentioned below, high electric current to the port may cause damage, overheating, or fire.

- Home (intercom speakerphone) or business-use telephone lines (multi-line business telephone)
- Public telephone subscriber line
- Private branch exchange (PBX)

## Using the Wireless LAN

The Wireless LAN (WLAN) allows your computer to connect to a network through a wireless connection.



The WLAN uses the following IEEE 802.11a/b/g/n standard, which specifies the type of technology used. See the specifications to find out about the configuration of your computer.

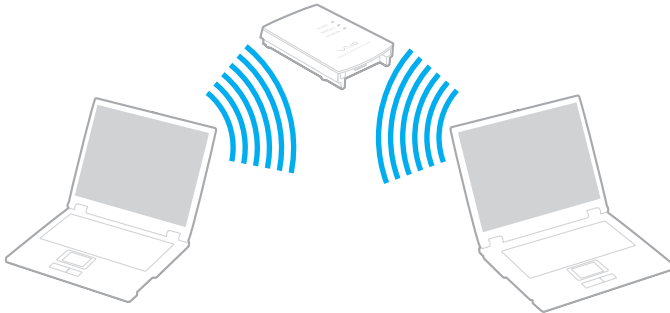

| WLAN standard  | Frequency band | Remarks  |
|----------------|----------------|--|
| IEEE 802.11a   | 5 GHz          | -  |
| IEEE 802.11b/g | 2.4 GHz        | The IEEE 802.11g standard provides higher-speed communications than the IEEE 802.11b standard. |
| IEEE 802.11n   | 5 GHz/2.4 GHz  | On models compliant with the IEEE 802.11b/g/n standard, only the 2.4 GHz band can be used.     |

## Notes on Using the Wireless LAN Function

### General notes on using the wireless LAN function

- ❑ In some countries or regions, using WLAN products may be restricted by the local regulations (e.g. limited number of channels).
- ❑ The IEEE 802.11a standard and the IEEE 802.11n standard are not available on ad-hoc networks.
- ❑ The 2.4 GHz band, with which wireless LAN devices work, is used by various devices. Although the wireless LAN devices use the technology to minimize radio interference from other devices that use the same band, such radio interference may cause slower communication speeds and narrower communication ranges or communication failures.
- ❑ The communication speed and range may vary depending on the following conditions:
  - ❑ Distance between communication devices
  - ❑ Existence of obstacles between devices
  - ❑ Device configuration
  - ❑ Radio conditions
  - ❑ Ambient environment that includes existence of walls and materials of such walls
  - ❑ Software in use
- ❑ Communications may be cut off depending on radio conditions.
- ❑ Actual communication speed may not be as fast as the one displayed on your computer.
- ❑ Deploying WLAN products compliant with different standards that use the same band on the same wireless network may reduce the communication speed due to radio interference. Taking this into consideration, WLAN products are designed to reduce the communication speed to ensure communications with another WLAN product if it is compliant with a different standard that uses the same band. When the communication speed is not as fast as expected, changing the wireless channel on the access point may increase the communication speed.

## Note on the data encryption

The WLAN standard includes the encryption methods: Wired Equivalent Privacy (WEP), which is a security protocol, Wi-Fi Protected Access 2 (WPA2), and Wi-Fi Protected Access (WPA). Proposed jointly by the IEEE and Wi-Fi Alliance, both WPA2 and WPA are specifications of standards based on interoperable security enhancements that increase the level of data protection and access control for existing Wi-Fi networks. WPA is designed to be forward compatible with the IEEE 802.11i specification. It utilizes the enhanced data encryption Temporal Key Integrity Protocol (TKIP) in addition to user authentication using 802.1X and Extensible Authentication Protocol (EAP). Data encryption protects the vulnerable wireless link between clients and access points. Besides that, there are other typical LAN security mechanisms to ensure privacy, such as: password protection, end-to-end encryption, virtual private networks, and authentication. WPA2, the second generation of WPA, provides stronger data protection and network access control and is also designed to secure all versions of 802.11 devices, including 802.11b, 802.11a, 802.11g, and 802.11n standards, multi-band and multi-mode. In addition, based on the ratified IEEE 802.11i standard, WPA2 provides government grade security by implementing the National Institute of Standards and Technology (NIST) FIPS 140-2 compliant AES encryption algorithm and 802.1X-based authentication. WPA2 is backward compatible with WPA.

## Starting Wireless LAN Communications



You first need to establish wireless LAN communications between your computer and an access point (not supplied). See **Windows Help and Support** for more information.

! For details on how to select the channel that will be used by the access point, see the manual that came with your access point.

### To start wireless LAN communications

- 1 Make sure an access point is set up.  
See the manual that came with your access point for more information.
- 2 Turn on the **WIRELESS** switch.
- 3 Click the **VAIO Smart Network** icon on the taskbar.
- 4 Click the switch next to your desired wireless option(s) to toggle it to **On** in the **VAIO Smart Network** window.  
Make sure the **WIRELESS** indicator light turns on.

! 5 GHz band wireless LAN communications, available on selected models only, are disabled by default. To enable 5 GHz band communication, you need to select the option to use the 5 GHz band or both the 2.4 GHz and 5 GHz bands from the drop-down list for **Wireless LAN Settings** in the **VAIO Smart Network** settings window.

- 5 Click  or  on the taskbar.
- 6 Select the desired access point and click **Connect**.

 For WPA-PSK or WPA2-PSK authentication, you must enter a passphrase. The passphrase is case sensitive and must be a text string between 8 and 63 characters in length or a hexadecimal string of 64 characters.



## Stopping Wireless LAN Communications

To stop wireless LAN communications

Click the switch next to **Wireless LAN** to toggle it to **Off** in the **VAIO Smart Network** window.

! Turning off the wireless LAN function while accessing remote documents, files, or resources may result in data loss.

## Using the Wireless WAN

Using the wireless WAN (WWAN) allows your computer to connect to the Internet through the wireless network wherever there is the mobile phone coverage.

The WWAN may not be available in some countries or regions.



Some features and options in this section may not be available on your computer.  
See the specifications to find out about the configuration of your computer.

## Inserting a SIM Card

To use the wireless WAN function, you first need to insert a SIM card into the SIM card slot on your computer. Your SIM card is contained within a base plate, about the size of a credit card.



Depending on your country and model, you might receive an offer from the VAIO selected telecom operator. In that case the SIM card is either in the operator SIM pack inside the carton box or already inserted in the SIM card slot. If the SIM card is not provided with your computer, you can purchase one from your preferred telecom operator.

### To insert a SIM card

- 1 Turn off your computer.
- 2 Remove the battery pack from the computer.



For detailed instructions, see **To remove the battery pack** ([page 23](#)).

- 3 Remove the SIM card (1) by pushing it out from the base plate.

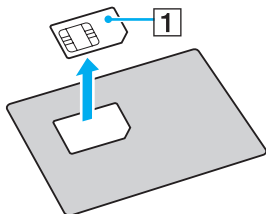

- 4 Insert the SIM card into the SIM card slot with its printed circuit side up.

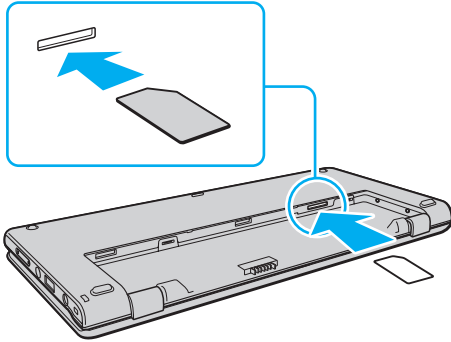

**!** Do not touch the printed circuit on the SIM card. Be sure to hold your computer firmly before inserting or removing the card.  
Do not damage the SIM card in any way, either by bending or exerting pressure on the card.

- 5 Reinstall the battery pack.

**!** Make sure the battery pack is installed properly.

## Starting the Wireless WAN Communications

To start the wireless WAN communications

- 1 Turn on the **WIRELESS** switch.
- 2 Click the **VAIO Smart Network** icon on the taskbar.
- 3 In the **VAIO Smart Network** window, make sure that the switch next to **Wireless WAN** is **On**.
- 4 Click the down arrow button next to the **Wireless WAN** switch and the **Connect** button to launch your connection manager software or the preinstalled software from a telecom operator depending on your model or country.
- 5 Enter your PIN code when prompted.
- 6 Click **Connect**.

For more information on how to use the wireless WAN function, see the help file included with the **VAIO Smart Network** or your telecom operator's documentation.

## Using the Bluetooth Function

You can establish wireless communications between your computer and other Bluetooth® devices such as another computer or a mobile phone. You can transfer data between these devices without cables at a range of up to 10 meters in an open area.

### Bluetooth Security

The Bluetooth wireless technology has an authentication function, which allows you to determine with whom you choose to communicate. With the authentication function, you can prevent any anonymous Bluetooth devices from accessing your computer.

The first time two Bluetooth devices communicate, a common passkey (a password required for authentication) should be determined for both devices to be registered. Once a device is registered, there is no need to re-enter the passkey.



The passkey can be different each time, but must be the same at both ends.

For certain devices, such as a mouse, no passkey can be entered.

## Communicating with Another Bluetooth Device

You can connect your computer to a Bluetooth device such as another computer, a mobile phone, a PDA, a headset, a mouse, or a digital camera without the use of any cables.



## To communicate with another Bluetooth device

To communicate with another Bluetooth device, you first need to set up the Bluetooth function. For setting up and using the Bluetooth function, search **Windows Help and Support** for Bluetooth information.

- 1 Turn on the **WIRELESS** switch.
- 2 Click the **VAIO Smart Network** icon on the taskbar.
- 3 Click the switch next to **Bluetooth** to toggle it to **On** in the **VAIO Smart Network** window.  
Make sure the **WIRELESS** indicator light turns on.



## Stopping Bluetooth Communications

To stop Bluetooth communications

- 1 Turn off the Bluetooth device that is communicating with your computer.
- 2 Click the switch next to **Bluetooth** to toggle it to **Off** in the **VAIO Smart Network** window.

## Notes on Using the Bluetooth Function

- ❑ The data transfer rate varies, depending on the following conditions:
  - ❑ Obstacles, such as walls, located between devices
  - ❑ Distance between devices
  - ❑ Material used in walls
  - ❑ Proximity to microwaves and cordless telephones
  - ❑ Radio frequency interference and other environmental conditions
  - ❑ Device configuration
  - ❑ Type of software application
  - ❑ Type of operating system
  - ❑ Use of both wireless LAN and Bluetooth functions at the same time on your computer
  - ❑ Size of file being exchanged
- ❑ Large files may occasionally be corrupted during continuous transfer due to limitations of the Bluetooth standard and electromagnetic interference in the environment.
- ❑ All Bluetooth devices must be certified to make sure that the applicable standard requirements are maintained. Even if standards are met, individual device performance, specifications, and operation procedures can vary. Data exchange may not be possible in all situations.
- ❑ Video and audio may not be synchronized if you play videos on your computer with audio output from a connected Bluetooth device. This is a frequent occurrence with Bluetooth technology and does not indicate a malfunction.
- ❑ The 2.4 GHz band, with which Bluetooth devices or wireless LAN devices work, is used by various devices. Although Bluetooth devices use the technology to minimize radio interference from other devices that use the same band, such radio interference may cause slower communication speeds and shorter distances or communication failures.

- ❑ The Bluetooth function may not work with other devices, depending on the manufacturer or the software version employed by the manufacturer.
- ❑ Connecting multiple Bluetooth devices to your computer may cause channel congestion, resulting in poor performance of the devices. This is normal with Bluetooth technology and does not indicate a malfunction.

## Using the GPS Function

You can get the location information by using GPS (Global Positioning System) with location software.



Some features and options in this section may not be available on your computer.  
See the specifications to find out about the configuration of your computer.

### To use the GPS function

- 1 Turn on the **WIRELESS** switch.
- 2 Click the **VAIO Smart Network** icon on the taskbar.
- 3 Click the switch next to **GPS** to toggle it to **On** in the **VAIO Smart Network** window.



Driver software will be installed when you first activate the GPS function on the **VAIO Smart Network**.

## Using Various Functions with Built-in Sensors

With a built-in accelerometer and digital compass (geomagnetic sensor), you can use the following functions.

! Be sure to use the supplied hand strap whenever you operate the computer while holding it in both hands to prevent accidental dropping of the computer. For information on how to attach the hand strap to the computer, see **Attaching the Hand Strap** (page 18).

Do not hold the bottom of your computer for an extended period of time, as it may cause low-temperature burns.

## Using Viewing Functions with a Built-in Accelerometer

To use the rotation function

With the rotation function, you can view the computer screen in horizontal or vertical orientation. To use the rotation function, rotate your computer by 90 degrees. The built-in accelerometer automatically detects the movement and orients the screen view depending on the direction in which you rotate the computer. When you are viewing the computer screen in vertical orientation, for example, rotating the computer 90 degrees switches the screen view to horizontal orientation.

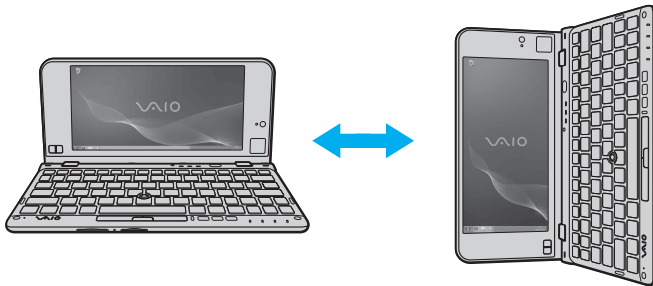

## To use the flick function

With the flick function, you can go backward or forward among pages or skip to the previous or next photo on the **Windows Photo Viewer**, the **Adobe Reader**, or some Internet browsing software. To use the flick function, slightly tilt your computer rightward or leftward.

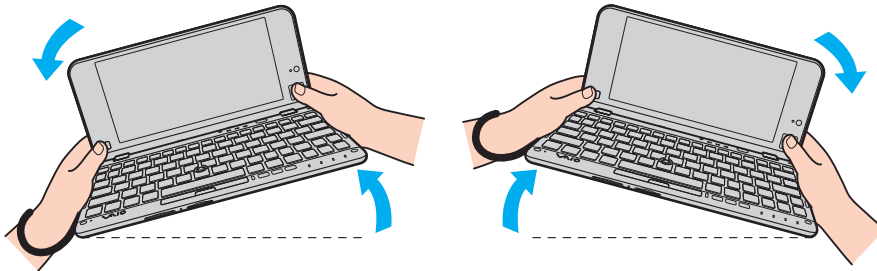

To use the flick function while you are using the computer in vertical orientation, fully open the LCD screen lid and slightly rotate the computer on the dotted line to the left or right as illustrated below.

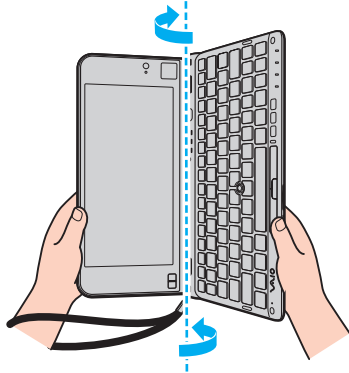

You can disable/enable the rotation function and the flick function or adjust the tilt sensitivity with the **VAIO Control Center**.

Calibrate the built-in accelerometer with the **VAIO Control Center** when the above functions do not work right after you perform the corresponding actions.



## Obtaining Location Information with a Built-in Digital Compass

With a built-in digital compass, you can obtain location information on the following software applications.

❑ **VAIO Location Search**

For information on how to use the **VAIO Location Search**, see the help file included with the software.

❑ **Digital Compass**

You first need to install the **Digital Compass** to use the software. Follow these steps to install the software:

- 1 Right-click on the desktop and select **Gadgets**.
- 2 Double-click **Digital Compass**.



Calibrate the built-in digital compass with the **VAIO Control Center** when the digital compass does not display the correct direction.

## Notes on the Built-in Sensors

### Notes on using the built-in accelerometer

- ❑ You may lose all the unsaved data if you use the rotation function without exiting running software, such as video playback software.
- ❑ The rotation function is disabled when an external display is connected to the computer. If you connect an external display while you are using the computer in vertical orientation, the screen view automatically switches to horizontal orientation.
- ❑ The computer screen may show some noise when you use the rotation function with a screen saver activated.
- ❑ Be sure to fully open the LCD screen lid when using the flick function with the computer in vertical orientation.
- ❑ Some software applications do not support the vertical orientation view and therefore not work correctly. In such a case, use the computer in horizontal orientation.

## Notes on using the built-in digital compass

- ❑ The digital compass on the desktop displays the direction in which you are currently facing by detecting ambient geomagnetism. Because geomagnetism is affected by ambient environment, the digital compass may not display the correct direction at the following locations:
  - ❑ Inside an elevator or a room surrounded by ferroconcrete or steel-frame walls
  - ❑ Locations surrounded by ferroconcrete structures, such as a footbridge or a concourse
  - ❑ Locations near or inside a train or a car
  - ❑ Locations near a transformer on the ground or high-voltage power lines
  - ❑ Locations near metallic products, such as a metallic desk or metallic furniture
  - ❑ Locations near magnets or magnetized products, such as speakers
- ❑ A direction displayed by the digital compass on the desktop may change after you adjust the viewing angle of the computer screen. This is normal and does not indicate a malfunction. In such a case, calibrate the digital compass with the **VAIO Control Center**.

## Notes on holding your computer

- ❑ Be sure to use the supplied hand strap whenever you operate the computer while holding it in both hands to prevent accidental dropping of the computer. For information on how to attach the hand strap to the computer, see **Attaching the Hand Strap (page 18)**.
- ❑ Do not wear the hand strap around your neck.
- ❑ Do not grasp the hand strap to carry your computer around as it may cause the computer to hit against surrounding objects, resulting in damage to the computer.
- ❑ Do not hold the bottom of your computer for an extended period of time, as it may cause low-temperature burns.

# Using Peripheral Devices

You can add functionality to your VAIO computer by using the various ports on the computer.

- Using the Noise Canceling Headphones** ([page 85](#))
- Connecting a Display/LAN Adapter** ([page 92](#))
- Connecting an Optical Disc Drive** ([page 94](#))
- Connecting External Speakers or Headphones** ([page 96](#))
- Connecting an External Display** ([page 97](#))
- Selecting Display Modes** ([page 99](#))
- Using the Multiple Monitors Function** ([page 100](#))
- Connecting a USB Device** ([page 102](#))

## Using the Noise Canceling Headphones

A pair of noise canceling headphones may be supplied with your computer.



Some features and options in this section may not be available on your computer.  
See the specifications to find out about the configuration of your computer.

The noise canceling headphones are equipped with a built-in microphone that picks up ambient noises and outputs an antiphase sound to reduce the noises.

## Before You Use the Noise Canceling Headphones

- ❑ You can enable the noise canceling function only when the supplied noise canceling headphones are connected to the headphones jack that supports this function.
- ❑ The noise canceling function does not work on sound output with the following devices:
  - ❑ External speakers
  - ❑ Headphones without the noise canceling function
  - ❑ Sound output devices connected to your computer via a Bluetooth connection
- ❑ The noise canceling function cannot be fully in effect unless you properly wear the headphones. Be sure to fit earpieces of the headphones tightly into your ears.

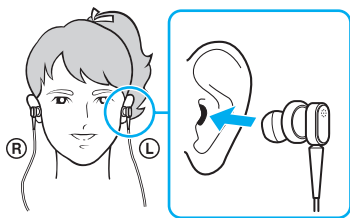

If you feel that the noise canceling function has little effect, adjust the earbud position in the earpieces of the noise canceling headphones or replace the earbuds with a pair in another size. A pair of medium-size earbuds is attached to the earpieces by default and there should be an extra pair in each small and large sizes supplied with the headphones.

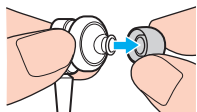

- ❑ The noise canceling function is to reduce low-frequency noise in the ambient environment but not high-frequency noise. Nor is it to implement a 100% noise-free audio environment.

- ❑ When the noise canceling function does not seem to be working, unplug the supplied noise canceling headphones completely and then plug them back again.
- ❑ Keep the built-in microphone (1) of the noise canceling headphones unblocked to ensure that the noise canceling function can be fully in effect.

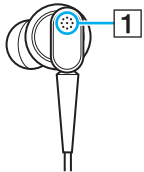

- ❑ You may hear a soft hissing noise while the noise canceling function is enabled. This is just operational noise that the function generates and does not indicate a malfunction.
- ❑ You may feel that the noise canceling function has little effect or ambient noises seem even louder, depending on the type of noise or the degree of quietness in your environment. In such a case, disable the noise canceling function.
- ❑ Use of a mobile phone may cause radio interference with the noise canceling headphones. When using the headphones, keep mobile phones away from the headphones.
- ❑ Plugging or unplugging the noise canceling headphones generates noise. This is normal and does not indicate a malfunction. Be sure to take off the headphones from your ears before plugging or unplugging the headphones.
- ❑ Enabling/disabling the noise canceling function or enabling/disabling sound with the Windows volume controls generates noise. This is caused by switching the noise canceling circuit and does not indicate a malfunction.
- ❑ Be sure to use the supplied noise canceling headphones. You can plug the headphones supplied with a Walkman® to your computer but the noise canceling function of the computer will not work well with such headphones.
- ❑ If you configure your noise canceling headphones to pick up sounds from its built-in microphone and output them through the earpieces, the sounds will be amplified. Be careful about the volume when you change the configuration.

## Connecting the Noise Canceling Headphones

To connect the noise canceling headphones

Plug the headphones cable into the headphones jack .

The  icon appears on the taskbar to indicate that the noise canceling function is enabled and a balloon message pops up from the icon.



When the  icon is on the taskbar, the noise canceling function is disabled. Right-click the icon and select **Enable Noise Canceling Function** from the menu.

If no icon is on the taskbar, see **What to do if the icon and the balloon do not appear** ([page 91](#)) to change the settings.



## Adjusting the Effect of the Noise Canceling Function

The noise canceling headphones supplied with your computer is configured to yield the optimum effect by default.

If you feel that the noise canceling function is not fully in effect, you may be able to adjust the effect with the **Noise Canceling Control** slider on the **Noise Canceling Headphones** window.

To adjust the effect of the noise canceling function

- 1 Right-click the  icon on the taskbar and select **Settings**.



If no icon is on the taskbar, see **What to do if the icon and the balloon do not appear** ([page 91](#)) to change the settings.

- 2 Drag the **Noise Canceling Control** slider toward **Mic+** or **Mic-** to select your desired noise canceling level.



The slider should be at the center of the range to yield the optimum level. Dragging the slider all the way to **Mic+** does not bring the noise canceling function fully into effect.

- 3 Click **Apply**.
- 4 Confirm that the noise canceling effect is satisfactory and then click **OK**.

## Using the microphone directivity function

Just like an ordinary microphone, the built-in microphone of the noise canceling headphones picks up ambient sounds coming from all directions. The microphone directivity (beamforming) function, however, can reduce ambient noises and pick up mainly your voice and sounds coming from your front and rear.

The microphone directivity function comes in handy when you want your voice to sound clearly while chatting or when you want to use the headphones as a microphone to record your own voice or sounds coming from your front.

### To enable the microphone directivity function

- 1 Right-click the  icon on the taskbar and select **Settings**.





If no icon is on the taskbar, see **What to do if the icon and the balloon do not appear** ([page 91](#)) to change the settings.

- 2 Click the **Microphone directivity** tab and select the **Enable the microphone directivity function** check box.
- 3 Click **OK**.



When ambient noises are extremely loud, the microphone directivity function may not become fully in effect or the volume level of the noises may fluctuate at short intervals.

## What to do if the icon and the balloon do not appear

When the noise canceling function icon (/) is not on the taskbar and the balloon message does not pop up from the icon, change the noise canceling function settings.

To display the balloon message and the icon

- 1 Click **Start** and **Control Panel**.
- 2 Click **Hardware and Sound**.
- 3 Click **Manage audio devices** under **Sound**.
- 4 On the **Playback** tab, double-click the speakers or headphones icon.
- 5 Click the **Enhancements** tab.
- 6 Click to select the **Noise Canceling Function** check box and click **Modify Settings**.



If the **Disable all enhancements** check box is selected, click to cancel the check box.

- 7 Click to select the **Display an icon for the noise canceling headphones in the task tray** or **Display a message when noise canceling headphones are connected** check box.
- 8 Click **OK**.

## Connecting a Display/LAN Adapter

A display/LAN adapter may be supplied with your computer to expand connectivity.



Some features and options in this section may not be available on your computer.  
See the specifications to find out about the configuration of your computer.

### Locating Ports on the Display/LAN Adapter

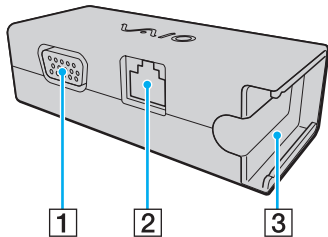

- 1 Monitor port ([page 97](#))
- 2 Network (LAN) port ([page 60](#))
- 3 Socket for attaching to the AC adapter ([page 131](#))

## Connecting the Display/LAN adapter to Your Computer

To connect the display/LAN adapter to your computer

**!** Do not move your computer while the display/LAN adapter is connected, as it may disconnect the display/LAN adapter and cause damage to both units.

- 1 Slide out the I/O plug (1) in the direction of the arrow and route the I/O plug cable (2) to the right of the tab (3).

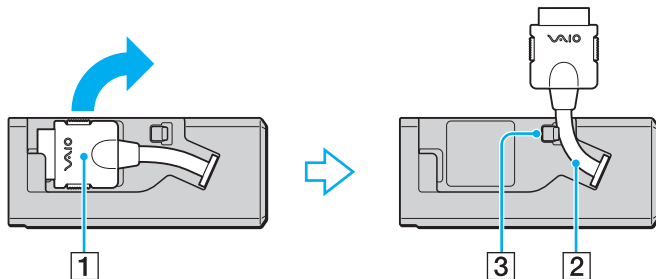

- 2 Connect the I/O plug (4) to the I/O port (5) on the computer.

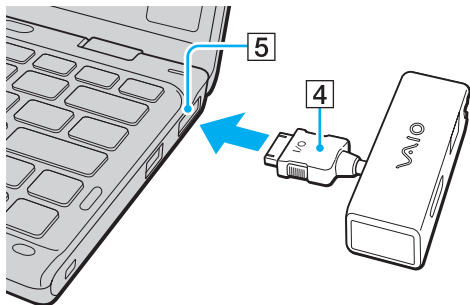

## Connecting an Optical Disc Drive

To use optical disc media with your computer, connect an external optical disc drive (not supplied) to your computer.

### Connecting an Optical Disc Drive

! Be sure to connect an external optical disc drive to your computer before launching any preinstalled disc operation program.

Be sure to connect an external optical disc drive to an AC power source before using the drive. Your computer only supports optical disc drives that run on the power directly supplied from an AC power source.

## To connect an optical disc drive

- 1 Connect your external optical disc drive to an AC outlet (1).
- 2 Choose the USB port (2)  you prefer to use.
- 3 Plug one end of a USB cable (3) into the USB port, and the other end to the optical disc drive.

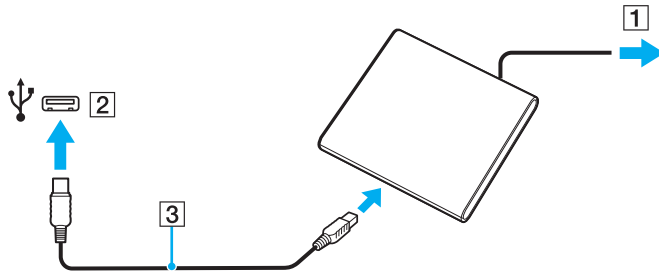

See the manual that came with your external optical disc drive for detailed instructions on connecting the USB cable to the drive.

Disconnecting the drive while the computer is in a power saving mode (Sleep or Hibernate) may cause the computer to malfunction.

## Connecting External Speakers or Headphones

You can connect external sound output devices (not supplied), such as speakers or headphones, to your computer.

To connect external speakers



Make sure your speakers are designed for computer use.



Turn down the volume of the speakers before you turn them on.

The noise canceling function does not work on sound output through external speakers.

Connect external speakers (1) to the headphones jack (2) with a speaker cable (3) (not supplied).

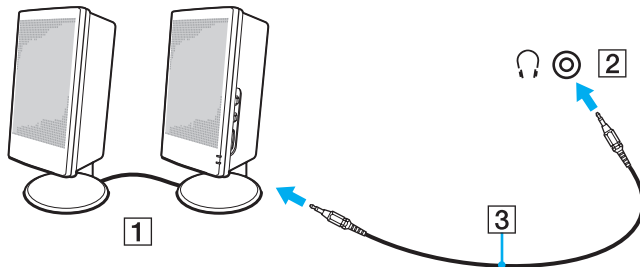



## Connecting an External Display

You can connect an external display (not supplied) to your computer. For example, you can use the computer with a computer display or a projector.



Some features and options in this section may not be available on your computer.

## Connecting a Computer Display or a Projector

You need a display/LAN adapter to connect an external display, such as a computer display or a projector, to your computer.

To connect a computer display or a projector

- 1 Plug the power cord (1) of your external display or the projector into an AC outlet.
- 2 Connect the external display or the projector to the monitor port (2) on the display/LAN adapter with a display cable.

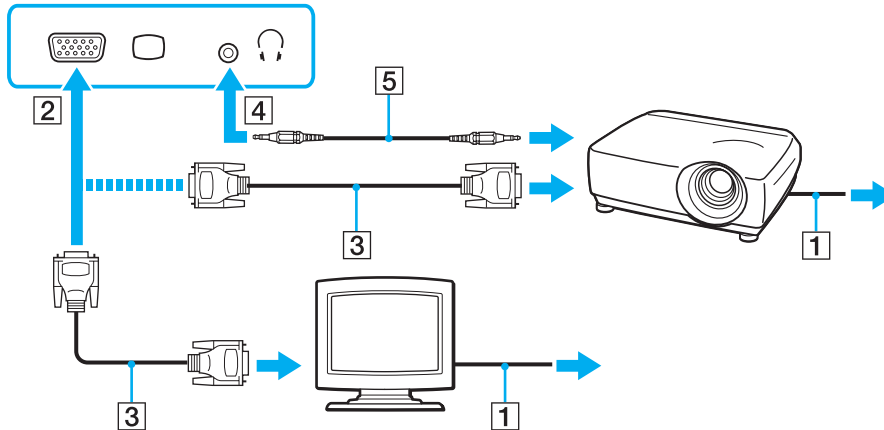

If necessary, connect the headphones jack on the projector and the headphones jack (4) on the computer with a speaker cable (5).

## Selecting Display Modes

When an external display is connected, you can select either your computer screen or the connected display to use as the primary monitor.



You may not be able to display the same content on your computer screen and the external display or projector at the same time, depending on the type of your external display or projector.

Turn on the external display before turning on your computer.

### To select a display mode with the Fn+F7 keys

You can select a display mode with the **Fn+F7** keys. See **Combinations and Functions with the Fn Key (page 35)** for more information.

### To select a display mode from the display settings

- 1 Right-click on the desktop and select **Screen resolution**.
- 2 Click the drop-down list next to **Multiple Displays**, select your desired setting, and then click **OK**.

## Using the Multiple Monitors Function

The Multiple Monitors function allows you to distribute portions of your desktop across separate displays. For example, if you have an external display connected to the monitor port, your computer screen and the external display can function as a single desktop.

You can move the cursor from one display to the other. This allows you to drag objects, such as an open application window or a toolbar, from one display to the other.

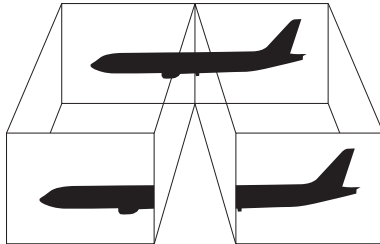

## To use the Multiple Monitors function



Your external display may not support the Multiple Monitors function.

Certain software applications may not be compatible with Multiple Monitors settings.

Make sure that your computer does not enter Sleep or Hibernate mode while you are using the Multiple Monitors function, or the computer may not return to Normal mode.

If you set different colors on each display, do not expand a single window across two displays, or your software may not work properly.

- 1 Right-click on the desktop and select **Screen resolution**.
- 2 Click the drop-down list next to **Multiple Displays**, select **Extend these displays**, and then click **OK**.



You can set the display colors and resolution for each display and customize the Multiple Monitors function.

Set fewer colors or a lower resolution for each display.

## Connecting a USB Device

You can connect a Universal Serial Bus (USB) device, such as a mouse, a floppy disk drive, a speaker, or a printer, to your computer.

To connect a USB device

- 1 Choose the USB port (1) you prefer to use.
- 2 Plug the USB device cable (2) into the USB port.

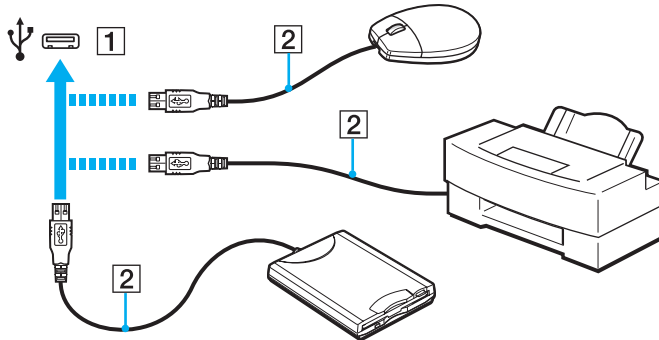

## Notes on connecting a USB device

- ❑ You may need to install the driver software supplied with your USB device before use. See the manual that came with the USB device for more information.
- ❑ Be sure to use a USB printer compatible with your version of Windows to print documents.
- ❑ For information on how to remove a USB device, see the manual that came with the device.
- ❑ To protect your computer and/or USB devices from damage, observe the following:
  - ❑ When moving the computer with USB devices connected, avoid exposing the USB ports to shock or impact.
  - ❑ Do not put the computer into a bag or carrying case when it has USB devices connected.

# Customizing Your VAIO Computer

This section briefly describes how to change the main settings of your VAIO computer. Among other things, you will learn how to use and customize the look of your Sony software and utilities.



- ❑ **Setting the Password** ([page 105](#))
- ❑ **Using Intel VT** ([page 112](#))
- ❑ **Using the VAIO Control Center** ([page 113](#))
- ❑ **Using the VAIO Power Management** ([page 114](#))



## Setting the Password

Setting the password allows you to protect your computer from unauthorized access by making the user enter the password when the computer is turned on or returns to Normal mode from Sleep mode or Hibernate mode.

**!**  
Do not to forget your password. Write down the password and keep it in a secure place.

| Type of Password  | Description  |
|-------------------|--|
| Power-on password | <p>You can use BIOS functions to set two types of passwords:</p> <ul style="list-style-type: none"><li>- Machine password: Allows users with administrative rights to change all the setup options in the BIOS setup screen, as well as to start the computer.</li><li>- User password: Allows the standard users to change some of the BIOS setup options, as well as to start the computer. To set the user password, you must first set the machine password.</li></ul> <p> Entry of the power-on password will be prompted after the VAIO logo appears to start your computer.</p> <p><b>!</b><br/>If you forget the machine password, the password needs to be reset and a fee will be charged. To reset the password, contact an authorized Sony service/support center. To find the nearest center or agent, see <b>Finding More about Your VAIO Computer (page 5)</b>.<br/>You can reset the user password at the BIOS setup screen by entering the machine password.</p> |
| Windows password  | <p>Allows users to log onto your computer and protect each user account with its own password.</p> <p> Entry of the Windows password will be prompted after you select your user account.</p>   |

## Setting the Power-on Password

To add the power-on password (machine password)

- 1 Turn on the computer and press the **F2** key repeatedly until the VAIO logo disappears.  
The BIOS setup screen appears. If the screen does not appear, restart the computer and try again.
- 2 Press the **←** or **→** key to select **Security** to display the **Security** tab, select **Set Machine Password**, and then press the **Enter** key.
- 3 On the password entry screen, enter the password twice and press the **Enter** key.  
The password can be up to 32 alphanumeric characters long (including spaces).
- 4 Select **Password when Power On** under **Security** and press the **Enter** key.
- 5 Change the setting from **Disabled** to **Enabled**.
- 6 Press the **←** or **→** key to select **Exit**, select **Exit Setup**, and then press the **Enter** key.  
At the confirmation prompt, press the **Enter** key.

## To add the power-on password (user password)

! Make sure you set the machine password before setting the user password.

- 1 Turn on the computer and press the **F2** key repeatedly until the VAIO logo disappears. The BIOS setup screen appears. If the screen does not appear, restart the computer and try again.
- 2 Enter the machine password and press the **Enter** key.
- 3 Press the **←** or **→** key to select **Security** to display the **Security** tab, select **Set User Password**, and then press the **Enter** key.
- 4 On the password entry screen, enter the password twice and press the **Enter** key. The password can be up to 32 alphanumeric characters long (including spaces).
- 5 Press the **←** or **→** key to select **Exit**, select **Exit Setup**, and then press the **Enter** key. At the confirmation prompt, press the **Enter** key.

## To change or remove the power-on password (machine password)

- 1 Turn on the computer and press the **F2** key repeatedly until the VAIO logo disappears.  
The BIOS setup screen appears. If the screen does not appear, restart the computer and try again.
- 2 Enter the machine password and press the **Enter** key.
- 3 Press the **←** or **→** key to select **Security** to display the **Security** tab, select **Set Machine Password**, and then press the **Enter** key.
- 4 On the password entry screen, enter the current password once and a new password twice, and then press the **Enter** key.  
To remove the password, leave the **Enter New Password** and **Confirm New Password** fields blank and press the **Enter** key.
- 5 Press the **←** or **→** key to select **Exit**, select **Exit Setup**, and then press the **Enter** key.  
At the confirmation prompt, press the **Enter** key.

### To change or remove the power-on password (user password)

- 1 Turn on the computer and press the **F2** key repeatedly until the VAIO logo disappears.  
The BIOS setup screen appears. If the screen does not appear, restart the computer and try again.
- 2 Enter the user password and press the **Enter** key.
- 3 Press the **←** or **→** key to select **Security** to display the **Security** tab, select **Set User Password**, and then press the **Enter** key.
- 4 On the password entry screen, enter the current password once and a new password twice, and then press the **Enter** key.  
To remove the password, leave the **Enter New Password** and **Confirm New Password** fields blank and press the **Enter** key.
- 5 Press the **←** or **→** key to select **Exit**, select **Exit Setup**, and then press the **Enter** key.  
At the confirmation prompt, press the **Enter** key.

## Setting the Windows Password

To add the Windows password

- 1 Click **Start** and **Control Panel**.
- 2 Click **User Accounts and Family Safety** or **User Accounts**.
- 3 Click **User Accounts**.
- 4 Click **Create a password for your account** under **Make changes to your user account**.
- 5 In the **New password** and **Confirm new password** fields, enter the password for your account.
- 6 Click **Create password**.



See **Windows Help and Support** for more information on the Windows password.

To change the Windows password

- 1 Click **Start** and **Control Panel**.
- 2 Click **User Accounts and Family Safety** or **User Accounts**.
- 3 Click **User Accounts**.
- 4 Click **Change your password**.
- 5 In the **Current password** field, enter your current password.
- 6 In the **New password** and **Confirm new password** fields, enter a new password.
- 7 Click **Change password**.

To remove the Windows password

- 1 Click **Start** and **Control Panel**.
- 2 Click **User Accounts and Family Safety** or **User Accounts**.
- 3 Click **User Accounts**.
- 4 Click **Remove your password**.
- 5 In the **Current password** field, enter the current password that you want to remove.
- 6 Click **Remove password**.

## Using Intel(R) VT

Intel(R) Virtualization Technology (VT) allows you to use hardware virtualization software for enhancing your computer's performance.

! Intel VT may not be available depending on the CPU installed on your computer.

For information on virtualization and how to use hardware virtualization software, contact the software publisher.

### To enable Intel VT

- 1 Turn on the computer and press the **F2** key repeatedly until the VAIO logo disappears. The BIOS setup screen appears. If the screen does not appear, restart the computer and try again.
- 2 Press the **←** or **→** key to select **Advanced**.
- 3 Press the **↑** or **↓** key to select **Intel(R) Virtualization Technology** or **Intel(R) VT**, press the **Enter** key, select **Enabled**, and press the **Enter** key.

! If the **Advanced** tab is not displayed in the BIOS setup window or you cannot select **Intel(R) Virtualization Technology**, Intel VT is not available on the computer.

- 4 Press the **←** or **→** key to select **Exit**, select **Exit Setup**, and then press the **Enter** key. At the confirmation prompt, press the **Enter** key.



## Using the VAIO Control Center

The **VAIO Control Center** utility allows you to access system information and to specify preferences for system behavior.

To use the VAIO Control Center

- 1 Click **Start**, **All Programs**, and **VAIO Control Center**.
- 2 Select your desired control item and change the settings.
- 3 Once finished, click **OK**.  
The setting of the desired item is changed.



For more information about each option, see the help file included with the **VAIO Control Center**.

Some of the control items will not be visible if you open the **VAIO Control Center** as a standard user.

## Using the VAIO Power Management

Power management helps you set up power plans for running on AC or battery power to suit your requirements for power consumption.

The **VAIO Power Management** function is added to the Windows **Power Options**. With this software application, you can enhance the Windows power management functions to ensure better operation of your computer and longer battery life.

### Selecting a Power Plan

When you start the computer, a power status icon appears on the taskbar. This icon indicates what kind of power source you are currently using. Click this icon to display the window that shows your power status.

To select a power plan

- 1 Right-click the power status icon on the taskbar and select **Power Options**.
- 2 Select your desired power plan.

To change the power plan settings

- 1 Click **Change plan settings** on the right of your desired power plan in the **Power Options** window. Change the Sleep mode and display settings as needed.
- 2 If you need to change the advanced settings, click **Change advanced power settings** and go to step 3. Otherwise, click **Save changes**.
- 3 Click the **VAIO Power Management** tab. Change the settings for each item.
- 4 Click **OK**.



You can check the current power plan settings with the **VAIO Power Management Viewer** in the **VAIO Control Center**.

# Precautions

This section describes safety guidelines and precautions to help you protect your VAIO computer from potential damage.

- ❑ **Safety Information** ([page 116](#))
- ❑ **Care and Maintenance Information** ([page 120](#))
- ❑ **Handling Your Computer** ([page 121](#))
- ❑ **Handling the LCD Screen** ([page 124](#))
- ❑ **Using the Power Source** ([page 125](#))
- ❑ **Handling the Built-in Camera** ([page 126](#))
- ❑ **Handling Discs** ([page 127](#))
- ❑ **Using the Battery Pack** ([page 128](#))
- ❑ **Handling "Memory Stick"** ([page 129](#))
- ❑ **Handling the Built-in Storage Device** ([page 130](#))
- ❑ **Handling the Display/LAN Adapter** ([page 131](#))

## Safety Information

### Computer

- ❑ Use your computer on a solid, stable surface.
- ❑ Provide adequate air circulation to prevent internal overheating. Do not place your computer on porous surfaces such as rugs, blankets, couches, beds, or near draperies that may block its air vents.
- ❑ It is recommended that you do not use your computer directly on your lap. The temperature of the base of the unit may rise during normal operation and over time could result in discomfort or burns.
- ❑ Use only specified peripheral equipment and interface cables.
- ❑ The temperature of the surface and the bottom of your computer, the AC adapter, and the battery pack may rise due to the CPU load or an electric current generated while the battery pack is being charged. This is normal and does not indicate a malfunction. The amount of heat generation varies depending on external devices or software in use.
- ❑ High precision devices are installed at the center of the base unit. If tasks which cause heavy loads to such devices are continued for a long time, the temperature at the bottom center of your computer may rise. In such a case, do not hold the bottom of the computer for an extended period of time, as it may cause low-temperature burns.
- ❑ When the temperature of the CPU rises due to heavy loads on your computer system, the CPU speed decreases. This is normal and does not indicate a malfunction. Because the computer is designed to cool down itself without using heat-reducing fans, it automatically decreases the CPU speed or the voltage or turns off unused devices for decreasing the amount of heat generation.

- ❑ If your computer becomes hot, do any of the following:
  - ❑ Change the power option. To change the power option, right-click the power status icon on the taskbar, select **Power Options**, select **Performance Mode** under **Thermal Control Strategy**, and click **OK**.
  - ❑ Disconnect all connected USB devices (if any).
  - ❑ Remove unused "Memory Stick" or memory cards (if any).
  - ❑ Turn off the **WIRELESS** switch.
  - ❑ Place the computer into Sleep mode or Hibernate mode if you do not use the computer. For information on how to use the power saving modes, see **Using the Power Saving Modes** ([page 30](#)).
- ❑ If your computer or the AC adapter becomes extraordinarily hot, turn off the computer, unplug the AC adapter, remove the battery pack, and then contact an authorized Sony service/support center.

## Power Source

- Do not place the AC adapter in contact with your skin. Remove the AC adapter away from your body if it becomes warm and causes discomfort.
- Do not place heavy objects on the power cord, or this could cause a fire.
- To disconnect the power cord, pull it out by holding the plug. Never pull the cord itself.
- Unplug your computer from the AC outlet if you are not planning to use the computer for an extended period of time.
- When the AC adapter is not used, unplug it from the AC outlet.
- Make sure that an AC outlet is easily accessible.

## Battery Pack

- Do not leave battery packs in temperatures above 60°C, such as in a car parked in the sun or under direct sunlight.
- For your safety, it is highly recommended that you use genuine Sony rechargeable battery packs and AC adapters that meet the quality assurance standard, supplied by Sony for your VAIO computer. Some VAIO computers may only function with a genuine Sony battery pack.
- Keep the battery pack away from all sources of heat.
- Keep the battery pack dry.
- Do not open or try to disassemble the battery pack.
- Do not expose the battery pack to any mechanical shock, such as caused by dropping it on a hard surface.
- If you are not using your computer for an extended period of time, remove the battery pack from the computer to prevent damage to the battery pack.
- If you have not used the battery pack for a considerable amount of time, the remaining battery life may become short. This is normal and does not indicate a malfunction. The battery pack will gradually discharge over time even while not in use. Connect the AC adapter to your computer and recharge the battery pack before using the computer again.

## Headphones

- ❑ **Road safety** – Do not use headphones while driving, cycling, or operating any motorized vehicle. It may create a traffic hazard and is illegal in some areas. It can also be potentially dangerous to play loud music while walking, especially at pedestrian crossings.
- ❑ **Preventing hearing damage** – Avoid using headphones at high volume. Hearing experts advise against continuous, loud and extended play. If you experience a ringing in your ears, reduce the volume or discontinue use.

## "Memory Stick"

Keep "Memory Stick" and "Memory Stick" adaptors out of reach of children. There is a risk of swallowing them.

## Care and Maintenance Information

### Computer

- ❑ Clean the cabinet and the LCD panel with a soft, dry or lightly moistened cloth with a mild detergent solution. Do not use an abrasive pad, scouring powder, or solvent such as alcohol or benzine, as these may damage the finish of your computer.
- ❑ Make sure you unplug the AC adapter and remove the battery pack before cleaning your computer.

### LCD Screen

- ❑ Use a soft, dry cloth to wipe the surface of the LCD screen. Rubbing the surface could damage the screen.
- ❑ To protect the LCD screen and keyboard from damage, for example in the case of carrying the computer, spread out the cleaning cloth with no wrinkles on the keyboard before closing the LCD screen lid.

### Built-in Camera

Clean the lens protection cover of the built-in camera with a blower brush or a soft brush. If the cover is extremely dirty, wipe it off with a soft dry cloth. Do not rub the cover, as it is sensitive to pressure.

### Discs

- ❑ Proper care of the disc is essential to its continuous reliability. Do not use solvents (such as benzine, thinner, alcohol, commercially available cleaners, or anti-static spray) which may cause damage to the disc.
- ❑ For normal cleaning, hold the disc by its edges and use a soft cloth to wipe the surface from the center out.
- ❑ If the disc is badly soiled, moisten a soft cloth with water, wring it out well, and use it to wipe the surface of the disc from the center out. Wipe off any remaining moisture with a dry soft cloth.



## Handling Your Computer

- ❑ If you drop a solid object or any liquid onto your computer, shut down the computer, unplug it, and remove the battery pack. You may want to have the computer checked by qualified personnel before operating it again.
- ❑ Do not drop your computer or place any objects on top of the computer.
- ❑ Do not place your computer in a location subject to:
  - ❑ Heat sources, such as radiators or air ducts
  - ❑ Direct sunlight
  - ❑ Excessive dust
  - ❑ Moisture or rain
  - ❑ Mechanical vibration or shock
  - ❑ Strong magnets or speakers that are not magnetically shielded
  - ❑ Ambient temperature of more than 35°C or less than 5°C
  - ❑ High humidity
- ❑ Do not place electronic equipment near your computer. The electromagnetic field of the equipment may cause the computer to malfunction.
- ❑ Do not use your computer without installing the battery pack as it may cause the computer to malfunction.
- ❑ Your computer uses high-frequency radio signals and may cause interference to radio or TV reception. If this occurs, move the computer a suitable distance away from the radio or TV.
- ❑ Do not use cut or damaged connection cables.

- ❑ If your computer is brought directly from a cold location to a warm one, moisture may condense inside the computer. In such a case, allow at least one hour before turning on the computer. If any problems occur, unplug the computer and contact an authorized Sony service/support center. To find the nearest center or agent, see **Finding More about Your VAIO Computer (page 5)**.
- ❑ To avoid losing data when your computer is damaged, back up your data regularly.

- ❑ Do not exert pressure on the LCD screen or its edges when opening the LCD screen lid or lifting your computer. The LCD screen may be sensitive to pressure or added stress, and exerting pressure may damage the screen or cause it to malfunction.
  - ❑ To open the computer, grasp the LCD screen lid on the center with one hand and gently lift the lid.

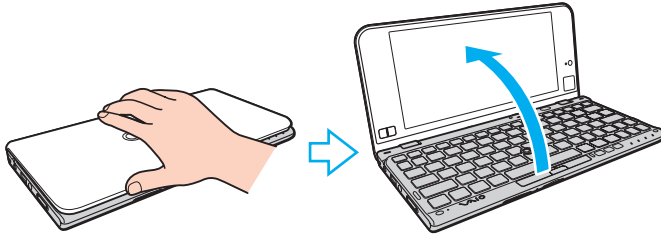

- ❑ To carry the computer with the lid open, be sure to hold the computer with both hands.



- ❑ Use a carrying case specially designed to carry your computer.

## Handling the LCD Screen

- ❑ Do not leave the LCD screen facing the sun. This could damage the LCD screen. Be sure to block direct sunlight when using your computer near a window.
- ❑ Do not scratch the surface of the LCD screen or exert pressure on it. This could cause a damage.
- ❑ Using your computer in low temperature conditions may produce a residual image on the LCD screen. This does not indicate a malfunction. When the computer returns to normal temperature, the screen returns to normal.
- ❑ A residual image may appear on the LCD screen if the same image is displayed for an extended period of time. The residual image disappears after a while. You can use a screen saver to prevent residual images.
- ❑ The LCD screen becomes warm during operation. This is normal and does not indicate a malfunction.
- ❑ The LCD screen is manufactured using high-precision technology. You may, however, see tiny black points and/or bright points (red, blue, or green) that continuously appear on the LCD screen. This is a normal result of the manufacturing process and does not indicate a malfunction.
- ❑ Do not change the LCD screen orientation setting in the **Tablet PC Settings** window even when there are change options available for selection, as this may make your computer unstable. Sony assumes no liability for any malfunctions arising from changes to the settings.
- ❑ Do not exert pressure on the LCD screen lid with the lid closed as it may scratch the LCD screen or soil it.

## Using the Power Source



See the specifications to find out about the configuration of your computer.

- ❑ Do not share an AC outlet with other power-consuming equipment, such as a photocopier or a shredder.
- ❑ You can purchase a power strip with a surge protector. This device helps prevent damage to your computer caused by sudden power surges, in an electrical storm, for example.
- ❑ Use the AC adapter supplied with your computer or genuine Sony products. Do not use any other AC adapter as it may cause a malfunction.

## Handling the Built-in Camera

- ❑ Do not touch the lens protection cover of the built-in camera, as it may cause scratches on the cover and such scratches will appear on the captured images.
- ❑ Do not let the direct sunlight get into the lens of the built-in camera regardless of your computer's power state, as it may cause the camera to malfunction.

## Handling Discs

- ❑ Fingerprints and dust on the surface of a disc may cause read errors. Be sure to hold the disc by its edges and central hole, as shown below:

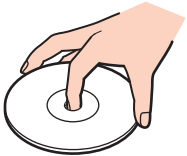

- ❑ Never affix an adhesive label to a disc. This will affect the use of the disc and may result in irreparable damage.

## Using the Battery Pack

- ❑ Battery life is shorter in a cold environment. This is due to decreased battery efficiency at low temperatures.
- ❑ Charge battery packs at temperatures between 10°C to 30°C. Lower temperatures require longer charging time.
- ❑ For safety reasons, battery charging may be suspended at higher or lower temperatures.
- ❑ While the battery pack is in use or being charged, heat builds up in the battery pack. This is normal and is not cause for concern.
- ❑ You do not need to discharge the battery pack before recharging.
- ❑ If the battery pack quickly runs out of power after being fully charged, it may be reaching the end of its life and should be replaced.



## Handling "Memory Stick"

- Do not touch the "Memory Stick" connector with your finger or metallic objects.
- Use only the adhesive label supplied with "Memory Stick".
- Do not bend, drop, or expose "Memory Stick".
- Do not disassemble or modify "Memory Stick".
- Keep "Memory Stick" dry.
- Do not use or store "Memory Stick" in a location subject to:
  - Static electricity
  - Electrical noise
  - Extremely high temperatures, such as in a car parked in the sun
  - Direct sunlight
  - High humidity
  - Corrosive substances
- Use the storage case supplied with "Memory Stick".
- Be sure to make a backup copy of your valuable data.
- When using "Memory Stick Duo", do not use a fine-tipped pen to write on the label adhered to "Memory Stick Duo". Exerting pressure on the media may damage internal components.

## Handling the Built-in Storage Device

The built-in storage device (hard disk drive or solid state drive) has a high storage density and reads or writes data in a short time. However, it can be easily damaged if improperly used. If the built-in storage device is damaged, the data cannot be restored. To prevent losing data, you should be careful when handling your computer.



Some features and options in this section may not be available on your computer.

See the specifications to find out about the configuration of your computer.

### To avoid damaging your built-in storage device

- Do not subject your computer to sudden movements.
- Keep your computer away from magnets.
- Do not place your computer in a location subject to mechanical vibration or in an unstable position.
- Do not turn off the power or restart your computer while reading or writing data to the storage device.
- Do not use your computer in a place subject to extreme changes in temperature.
- Do not remove the storage device from your computer.

## Handling the Display/LAN Adapter

To help you keep the display/LAN adapter at hand, the display/LAN adapter is designed to be attached to the AC adapter.

To attach the display/LAN adapter to the AC adapter

! The appearance of your AC adapter may be different from those illustrated below in some countries or regions.

- 1 Fit the socket on the display/LAN adapter onto the attachment projection on the side of the AC adapter with the cable.

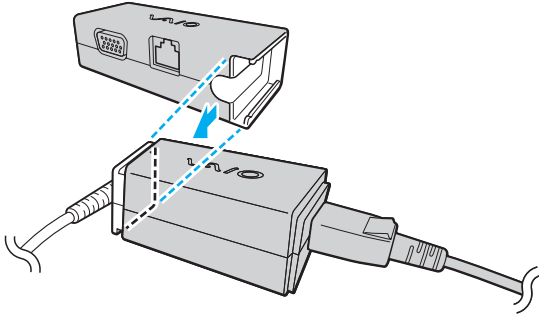

- 2 Slide the display/LAN adapter toward the AC adapter until it clicks into place.

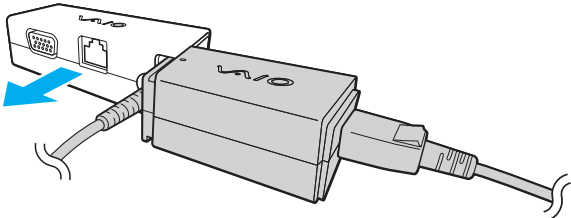

# Troubleshooting

This section describes how to solve common problems you might encounter when using your VAIO computer. Many problems have simple solutions. If these suggestions fail to solve your problems, use the **VAIO Care**. To launch the software, see **Using the VAIO Care (page 33)**.

If the problems still cannot be solved and you need assistance, contact an authorized Sony service/support center.



Some features and options in this section may not be available on your computer.

- Computer Operations (page 134)**
- System Update / Security (page 142)**
- Recovery (page 144)**
- Battery Pack (page 147)**
- Built-in Camera (page 149)**
- Networking (LAN/Wireless LAN) (page 151)**
- Wireless WAN (page 155)**
- Bluetooth Technology (page 156)**
- Optical Discs (page 160)**
- GPS (page 161)**
- Display (page 162)**
- Printing (page 165)**
- Microphone (page 166)**



- ❑ **Speakers** ([page 167](#))
- ❑ **Pointing Device** ([page 169](#))
- ❑ **Keyboard** ([page 170](#))
- ❑ **Floppy Disks** ([page 171](#))
- ❑ **Audio/Video** ([page 172](#))
- ❑ **"Memory Stick"** ([page 174](#))
- ❑ **Peripherals** ([page 175](#))

## Computer Operations

### What should I do if my computer does not start?

- ❑ Make sure your computer is securely plugged into a power source and turned on and the power indicator light is lit.
- ❑ Make sure the battery pack is installed properly and charged.
- ❑ Disconnect all connected USB devices (if any), and then restart your computer.
- ❑ If your computer is plugged into a power strip or an uninterruptible power supply (UPS), make sure the power strip or UPS is plugged into a power source and turned on.
- ❑ If you are using an external display, make sure it is plugged into a power source and turned on. Make sure the brightness and contrast controls are adjusted correctly. See the manual that came with your display for more information.
- ❑ Unplug the AC adapter and remove the battery pack. Wait three to five minutes. Reinstall the battery pack, plug the AC adapter, and then press the power button to turn on your computer.
- ❑ Condensation may cause your computer to malfunction. If this occurs, do not use the computer for at least one hour.
- ❑ Check that you are using the supplied Sony AC adapter. For your safety, use only the genuine Sony rechargeable battery pack and AC adapter, which are supplied by Sony for your VAIO computer.

## What should I do if the green power indicator light turns on but my screen remains blank?

- ❑ Press the **Alt+F4** keys several times to close the application window. An application error may have occurred.
- ❑ If the **Alt+F4** keys do not work, click **Start**, the arrow next to the **Shut down** button, and **Restart** to restart your computer.
- ❑ If your computer does not restart, press the **Ctrl+Alt+Delete** keys and click the arrow  next to the **Shut down**  button and **Restart**.  
If the **Windows Security** window appears, click **Restart**.
- ❑ If this procedure does not work, press and hold the power button for more than four seconds to shut down your computer. Unplug the AC adapter and leave the computer for about five minutes. Then plug the AC adapter and turn on the computer again.

**!** Turning off your computer with the **Ctrl+Alt+Delete** keys or the power button may cause loss of unsaved data.

## What should I do if my computer or software stops responding?

- ❑ If your computer stops responding while a software application is running, press the **Alt+F4** keys to close the application window.
  - ❑ If the **Alt+F4** keys do not work, click **Start** and the **Shut down** button to turn off your computer.
  - ❑ If your computer does not turn off, press the **Ctrl+Alt+Delete** keys and click the **Shut down** button. If the **Windows Security** window appears, click **Shut Down**.
  - ❑ If this procedure does not work, press and hold the power button until the computer turns off.
- !
- Turning off your computer with the **Ctrl+Alt+Delete** keys or the power button may cause loss of unsaved data.
- ❑ Unplug the AC adapter and remove the battery pack. Wait three to five minutes. Reinstall the battery pack, plug the AC adapter, and then press the power button to turn on your computer.
  - ❑ Try reinstalling the software.
  - ❑ Contact the software publisher or designated provider for technical support.



## Why doesn't my computer enter Sleep or Hibernate mode?

Your computer may become unstable if the operating mode is changed before the computer completely enters Sleep or Hibernate mode.

To restore your computer to Normal mode

- 1 Close all open programs.
- 2 Click **Start**, the arrow next to the **Shut down** button, and **Restart**.
- 3 If your computer does not restart, press the **Ctrl+Alt+Delete** keys and click the arrow next to the **Shut down** button and **Restart**.  
If the **Windows Security** window appears, click **Restart**.
- 4 If this procedure does not work, press and hold the power button until the computer turns off.

! Turning off your computer with the **Ctrl+Alt+Delete** keys or the power button may cause loss of unsaved data.

## What should I do if the charge indicator light is blinking fast and my computer does not start?

- ❑ This problem could be due to the battery pack not being installed properly. To solve this problem, turn off your computer and remove the battery pack. Then reinstall the battery pack to the computer. For details, see **Installing/Removing the Battery Pack (page 21)**.
- ❑ If the problem persists, it means the installed battery pack is not compatible. Remove the battery pack and contact an authorized Sony service/support center. To find the nearest center or agent, see **Finding More about Your VAIO Computer (page 5)**.

## Why does the System Properties window display a slower CPU speed than the maximum?

This is normal. Because your computer's CPU utilizes a type of CPU speed controlling technology for power conservation purposes, System Properties may display the current CPU speed instead of the maximum speed.

## What should I do if my computer does not accept my password and returns a message, Enter Onetime Password?

If you enter a wrong power-on password three times consecutively, the **Enter Onetime Password** message appears and Windows will not start. Press and hold the power button for more than four seconds to check that the power indicator light turns off. Wait for 10 to 15 seconds, then restart your computer and enter the correct password. The password is case sensitive, so be sure to check letters for the current case before you enter the password.

## What should I do if my game software does not work or it keeps crashing?

- Check the web site of the game if there are any patches or updates to download.
- Make sure you have installed the latest video driver software.
- On some VAIO models, the graphics memory is shared with the system. The optimal graphic performance in such a case is not guaranteed.

## Why doesn't my screen turn off after the automatic turn-off time has passed?

Some software applications or screen savers are designed to temporarily disable the feature of your operating system that turns off the computer screen or places the computer into Sleep mode after a certain period of inactivity. To solve this problem, exit the running software application(s) or change the current screen saver.

## How can I change the boot device order?

You can use one of the BIOS functions to change the boot device order. Follow these steps:

- 1 Turn on the computer and press the **F2** key repeatedly until the VAIO logo disappears.  
The BIOS setup screen appears. If the screen does not appear, restart the computer and try again.
- 2 Press the **←** or **→** key to select **Boot**.
- 3 Press the **↑** or **↓** key to select the drive whose boot device order you want to change.
- 4 Press the **F5** or **F6** key to change the boot device order.
- 5 Press the **←** or **→** key to select **Exit**, select **Exit Setup**, and then press the **Enter** key.  
At the confirmation prompt, press the **Enter** key.

## What should I do if I cannot boot my computer from the external device connected to the computer?

To boot your computer from an external device, for example a USB floppy disk drive or a USB optical disc drive, you need to change the boot device. To change the boot device, turn on your computer and press the **F11** key repeatedly until the VAIO logo disappears.

**!** When using an external device, be sure to connect it to an AC power source in advance.

## Why doesn't my computer respond fast enough while Windows Aero is running?

Performance of your computer is not guaranteed while Windows Aero is running. It is recommended you disable Windows Aero to ensure optimum performance.

To disable Windows Aero, follow these steps:

- 1 Right-click on the desktop and select **Personalize**.
- 2 Select themes other than **Aero Themes**.

## Why doesn't the digital compass on my desktop display the correct direction?

- The digital compass on the desktop displays the direction in which you are currently facing by detecting ambient geomagnetism. Because geomagnetism is affected by ambient environment, the digital compass may not display the correct direction at the following locations:
  - Inside an elevator or a room surrounded by ferroconcrete or steel-frame walls
  - Locations surrounded by ferroconcrete structures, such as a footbridge or a concourse
  - Locations near or inside a train or a car
  - Locations near a transformer on the ground or high-voltage power lines
  - Locations near metallic products, such as a metallic desk or metallic furniture
  - Locations near magnets or magnetized products, such as speakers
- The direction may be displayed correctly by calibrating the built-in digital compass. To calibrate the digital compass, follow these steps:
  - 1 Click **Start, All Programs, and VAIO Control Center**.
  - 2 Click **Location Info/GPS** and **Adjust Digital Compass**.
  - 3 Follow the on-screen instructions.

## Why doesn't the rotation function work?

- ❑ The rotation function may be disabled. In such a case, enable the rotation function with the **VAIO Control Center**.
- ❑ The rotation function is disabled when an external display is connected to the computer. In addition, if you connect an external display while you are using the computer in vertical orientation, the screen view switches to horizontal orientation.

## Why doesn't the flick function work?

- ❑ The flick function may be disabled. In such a case, enable the flick function with the **VAIO Control Center**.
- ❑ The software in use may not support the flick function. Use the **Windows Photo Viewer** or the **Adobe Reader** that supports the function.
- ❑ Bring the window of the software that supports the flick function to the front. Click anywhere on the window or press the **Alt+Tab** keys and select the window.

## System Update / Security

### How can I find important updates for my computer?

You can find and install the latest updates on your computer with the software applications: the **Windows Update** and the **VAIO Update**. See **Updating Your Computer (page 32)** for more information.

### How can I protect my computer against security threats, such as viruses?

The Microsoft Windows operating system is preinstalled on your computer. The best way to protect your computer against security threats, such as viruses, is to download and install the latest Windows updates regularly.

You can get important Windows updates by doing the following:



Your computer must be connected to the Internet to download the updates.

- 1 Click **Start** and **Control Panel**.
- 2 Click **System and Security**.
- 3 Click **Action Center**.
- 4 Follow the on-screen instructions to set up automatic or scheduled updates.

## How do I keep my antivirus software updated?

You can keep the Internet security software programs current with the latest updates by downloading and installing the updates from the web site of the manufacturer.



Your computer must be connected to the Internet to download the updates.

When using the **McAfee**:

- 1 Click **Start, All Programs, McAfee, and McAfee SecurityCenter**.
- 2 Click the button located at the upper left corner of the window to update the software.
- 3 Follow the on-screen instructions to complete the updates.

When using the **Norton Internet Security**:

- 1 Click **Start, All Programs, Norton Internet Security, and LiveUpdate or Norton Internet Security**.
- 2 Follow the on-screen instructions to complete the updates.



See the help file included with your software program for more information.



The actual procedure may be different from the above depending on updates installed on your computer. In such a case, follow the on-screen instructions.

## Recovery

### How can I create Recovery Media?

You can create Recovery Media using the **VAIO Care**. The media are used to restore your computer system to its factory default settings. To create the media, launch the **VAIO Care** ([page 33](#)) and then click **Recovery & restore**, **Recovery**, and **Create Recovery Media**.

! If your computer is not equipped with a built-in optical disc drive, you need to connect an external optical disc drive (not supplied).

See the **Recovery, Backup and Troubleshooting Guide** for more information.

### How can I restore my computer system to its factory default settings?

There are two ways to recover your computer system: from Recovery Media and from the recovery area. See the **Recovery, Backup and Troubleshooting Guide** for more information.

### How can I reinstall the original software and drivers?

You can restore the preinstalled software and drivers using the **VAIO Care**. To restore them, launch the **VAIO Care** ([page 33](#)) and then click **Recovery & restore**, **Recovery**, and **Reinstall Applications and Drivers**.

See the help file included with the **VAIO Care** for more information.



## How do I check the volume of the recovery area?

Your built-in storage device contains the recovery area where the data for the system recovery is stored. To check the volume of the recovery area, follow these steps:

**1** Click **Start**, right-click **Computer**, and select **Manage**.

**2** Click **Disk Management** under **Storage** in the left pane.

The volume of the recovery area and the total volume of the C drive are displayed in the **Disk 0** row in the center pane.

## How do I reduce the volume of the recovery area?

Your built-in storage device contains the recovery area where the data for system recovery is stored. If your computer includes a solid state drive, you might want to minimize the recovery area by removing such data.

- 1 Insert a Recovery Media into the optical disc drive while your computer is in Normal mode, turn off the computer, and then turn it on once again.



Use Recovery Media you created upon delivery of your computer.



If you are using an external optical disc drive (not supplied), restart the computer and press the **F11** key repeatedly until the VAIO logo disappears.

- 2 Press the **↑** or **↓** key to select **VAIO Care Rescue** and press the **Enter** key.
- 3 Click **Tools** and **Start advanced recovery wizard**.



When the **Do you need to rescue data?** message appears, make a backup copy of your data, if needed.

- 4 Follow the on-screen instructions until the **Select recovery type** window appears.
- 5 Select **Custom recovery - Remove recovery contents**.
- 6 Follow the on-screen instructions.



The above procedure involves system recovery. The applications and data you added on the storage device before removing the data for system recovery will all be lost.

Once you have removed the data for system recovery, you need the Recovery Media for later system recovery.

## Battery Pack

### How do I find the battery charging status?

You can check the charge indicator for the battery charging status. See **Charging the Battery Pack (page 25)** for more information.

### When is my computer using AC power?

When your computer is connected to an AC outlet with the AC adapter, it uses AC power, even if the battery pack is installed.

### When should I recharge the battery pack?

Recharge the battery pack when:

- The battery pack is running out of power and both the charge and power indicator lights blink.
- You have not used the battery pack for an extended period of time.

### When should I replace the battery pack?

A message prompting you to replace the battery pack appears when the battery pack reaches the end of its life. You can check the battery charge capacity with the **Battery** function on the **VAIO Control Center**.

### Should I be concerned that the installed battery pack is warm?

No, it is normal for the battery pack to be warm while it is powering your computer.

## Can my computer enter Hibernate mode while running on battery power?

Your computer can enter Hibernate mode while running on battery power, but some software programs and peripheral devices prevent the system from entering Hibernate mode. If you are using a program that prevents the system from entering Hibernate mode, save your data frequently to avoid losing data. See **Using Hibernate Mode (page 31)** for information on how you can manually activate Hibernate mode.

## Why can't I fully charge my battery pack?

The battery care function is enabled to extend the life of your battery pack on the **VAIO Control Center**. Check the settings on the **VAIO Control Center**.

## What should I do if a message appears notifying of either incompatibility or the improper installation of the battery pack and my computer then enters Hibernate mode?

- ❑ This problem could be due to the battery pack not being installed properly. To solve this problem, turn off your computer and remove the battery pack. Then reinstall the battery pack to the computer. For details, see **Installing/Removing the Battery Pack (page 21)**.
- ❑ If the problem persists, it means the installed battery pack is not compatible. Remove the battery pack and contact an authorized Sony service/support center. To find the nearest center or agent, see **Finding More about Your VAIO Computer (page 5)**.

## Built-in Camera

### Why does the viewfinder show no images or poor-quality images?

- The built-in camera cannot be shared by more than one software application. Exit the current application before launching another.
- The viewfinder may show some noise, for example horizontal streaks, when you are viewing a rapid-moving object. This is normal and does not indicate a malfunction.
- If the problem persists, restart your computer.

### Why are captured images poor in quality?

- The images captured under the fluorescent light may show reflections of light.
- A dark portion in captured images may appear as a noise.
- If the lens protection cover is dirty, you cannot take a clear shot. Clean the cover. See **Built-in Camera (page 120)**.

### Why is the video input from the built-in camera suspended for a few seconds?

The video input may be suspended for a few seconds if:

- a shortcut key with the **Fn** key is used.
- the CPU load increases.

This is normal and does not indicate a malfunction.

## What should I do if my computer becomes unstable when it enters a power saving mode while the built-in camera is in use?

If your computer automatically enters Sleep or Hibernate mode, change the corresponding power saving mode setting. To change the setting, see **Using the Power Saving Modes** ([page 30](#)).

## Networking (LAN/Wireless LAN)

### What should I do if my computer cannot connect to a wireless LAN access point?

- You need to connect the display/LAN adapter to your computer before configuring or accessing your network.
- Connection capability is affected by distance and obstructions. You may need to move your computer away from obstructions or closer to any access point you may be using.
- Make sure the **WIRELESS** switch is on and the **WIRELESS** indicator light is lit on your computer.
- Make sure power to the access point is on.
- If you want to connect your computer to a wireless LAN access point using the 5 GHz band, make sure the option to use the 5 GHz band or both the 2.4 GHz and 5 GHz bands is selected for **Wireless LAN Settings** in the **VAIO Smart Network** settings window. Wireless LAN communication (IEEE 802.11a standard) using only the 5 GHz band, available on selected models only, is disabled by default.
- Follow these steps to check the settings:
  - 1 Click **Start** and **Control Panel**.
  - 2 Click **View network status and tasks** under **Network and Internet**.
  - 3 Click **Connect to a network** to confirm that your access point is selected.
- Make sure the encryption key is correct.

- ❑ Make sure **Maximum Performance** is selected for **Wireless Adapter Settings** in the **Power Options** window. Selecting any other option may result in a communication failure. To change the settings, follow these steps:
  - 1 Right-click the power status icon on the taskbar and select **Power Options**.
  - 2 Click **Change plan settings**.
  - 3 Click **Change advanced power settings**.
  - 4 Select the **Advanced settings** tab.
  - 5 Double-click **Wireless Adapter Settings** and **Power Saving Mode**.
  - 6 Select **Maximum Performance** from the drop-down list both for **On battery** and **Plugged in**.



## What should I do if I cannot access the Internet?

- ❑ Check the access point settings. See the manual that came with your access point for more information.
- ❑ Make sure your computer and the access point are connected to one another.
- ❑ Move your computer away from obstacles or closer to any access point you may be using.
- ❑ Make sure your computer is properly configured for Internet access.
- ❑ Make sure **Maximum Performance** is selected for **Wireless Adapter Settings** in the **Power Options** window. Selecting any other option may result in a communication failure. Follow the steps in **What should I do if my computer cannot connect to a wireless LAN access point? (page 151)** to change the settings.

## Why is the data transfer speed slow?

- ❑ The wireless LAN data transfer speed is affected by distance and obstructions between devices and access points. Other factors include device configurations, radio conditions, and software compatibility. To maximize the data transfer speed, move your computer away from obstacles or closer to any access point you may be using.
- ❑ If you are using a wireless LAN access point, the device may be temporarily overloaded depending on how many other devices are communicating via the access point.
- ❑ If your access point interferes with other access points, change the access point channel. See the manual that came with your access point for more information.
- ❑ Make sure **Maximum Performance** is selected for **Wireless Adapter Settings** in the **Power Options** window. Selecting any other option may result in a communication failure. Follow the steps in **What should I do if my computer cannot connect to a wireless LAN access point? (page 151)** to change the settings.

## How do I avoid data transfer interruptions?

- ❑ While your computer is connected to an access point, data transfer interruptions may occur if a large file is exchanged or the computer is placed in close proximity to microwaves and cordless telephones.
- ❑ Move your computer closer to the access point.
- ❑ Make sure the access point connection is intact.
- ❑ Change the access point channel. See the manual that came with your access point for more information.
- ❑ Make sure **Maximum Performance** is selected for **Wireless Adapter Settings** in the **Power Options** window. Selecting any other option may result in a communication failure. Follow the steps in **What should I do if my computer cannot connect to a wireless LAN access point? (page 151)** to change the settings.

## What are channels?

- ❑ Wireless LAN communication uses divided frequency bands known as channels. Third-party wireless LAN access point channels may be preset to different channels from Sony devices.
- ❑ If you are using a wireless LAN access point, see connectivity information contained in the manual that came with your access point.

## Why does the network connection stop when I change the encryption key?

Two computers with the wireless LAN function may lose a peer-to-peer network connection if the encryption key is changed. You can either change the encryption key back to the original profile or re-enter the key on both computers so the key matches.

## Wireless WAN

### What should I do if my computer cannot connect to the wireless WAN?

- ❑ Make sure the battery pack is installed properly and charged.
- ❑ Make sure the SIM card is 3G data enabled and activated by your telecom operator. When inserting the SIM card, be sure to follow the procedure in **Inserting a SIM Card (page 67)**.
- ❑ Your mobile phone network needs to cover your area. Contact your network provider for information on the network coverage.
- ❑ Make sure the **WIRELESS** switch is on and the **WIRELESS** indicator light is lit on your computer.
- ❑ Make sure the switch next to **Wireless WAN** is set to **On** in the **VAIO Smart Network** window.
- ❑ Make sure that the Access Point Name (APN) is properly configured in your connection manager software. If not, contact your telecom operator to get the correct APN to use. See the help file included with the connection manager software for more information about the APN configuration.
- ❑ Check that your connection manager software has detected the wireless WAN modem successfully. It may take some time for the software to detect the wireless WAN modem.



For further information on the wireless WAN function, visit the VAIO support web site.

## Bluetooth Technology

### What should I do if other Bluetooth devices cannot find my computer?

- ❑ Make sure both devices have the Bluetooth function enabled.
- ❑ Make sure the **WIRELESS** switch is on and the **WIRELESS** indicator light is lit on your computer.
- ❑ You cannot use the Bluetooth function while your computer is in a power saving mode. Bring the computer back to Normal mode, then turn on the **WIRELESS** switch.
- ❑ Your computer and the device may be too far apart. Wireless Bluetooth technology works best when the devices are within 10 meters of each other.

### What should I do if I cannot find the Bluetooth device I want to communicate with?

- ❑ Check that the Bluetooth function of the device you want to communicate with is on. See the other device's manual for more information.
- ❑ If the device you want to communicate with is already communicating with another Bluetooth device, it may not be found or it may not be able to communicate with your computer.
- ❑ To allow other Bluetooth devices to communicate with your computer, follow these steps:
  - 1 Click **Start** and **Devices and Printers**.
  - 2 Right-click the Bluetooth device icon and click **Bluetooth settings**.
  - 3 Click the **Options** tab and select the **Allow Bluetooth devices to find this computer** check box.

## What should I do if other Bluetooth devices cannot connect to my computer?

- ❑ Check the suggestions in **What should I do if I cannot find the Bluetooth device I want to communicate with?** ([page 156](#)).
- ❑ Make sure the other devices are authenticated.
- ❑ The data transfer distance can be shorter than 10 meters depending on existing obstacles between the two devices, on radio wave quality, and on the operating system or the software in use. Move your computer and Bluetooth devices closer to each other.

## Why is my Bluetooth connection slow?

- ❑ The data transfer speed depends on the obstructions and/or the distance between the two devices, on the radio wave quality, and on the operating system or the software in use. Move your computer and Bluetooth devices closer to each other.
- ❑ The 2.4 GHz band, with which Bluetooth devices or wireless LAN devices work, is used by various devices. Although Bluetooth devices use the technology to minimize radio interference from other devices that use the same band, such radio interference may cause slower communication speeds and shorter distances or communication failures.
- ❑ If a version of a Bluetooth standard employed on the Bluetooth device with which you want to communicate is not the same version as the one employed on your computer, the communication speed becomes slower.

## Why can't I use the services supported by the connected Bluetooth device?

Connection is only possible for services also supported by the computer with the Bluetooth function. For more details, search **Windows Help and Support** for Bluetooth information.

## Can I use a device with Bluetooth technology on airplanes?

With Bluetooth technology, your computer transmits a radio frequency of 2.4 GHz. Sensitive locations, such as hospitals and airplanes, may have restrictions on use of Bluetooth devices to avoid radio interference. Check with facility staff to see if use of the Bluetooth function on the computer is permitted.

## Why can't I use the Bluetooth function when I log onto my computer as a user with a standard user account?

The Bluetooth function may not be available to a user with a standard user account on your computer. Log onto the computer as a user with administrative rights.

## Why can't I use the Bluetooth devices when I switch users?

If you switch users without logging off your system, the Bluetooth devices will not work. Be sure to log off before switching users. To log off your system, click **Start**, the arrow next to the **Shut down** button, and **Log off**.

## Why can't I exchange business card data with a mobile phone?

The business card exchange function is not supported.

## What should I do if I do not hear sound from my headphones or audio/video controller?

Check whether your headphones or audio/video controller supports the SCMS-T content protection. If not, you need to change the SCMS-T settings to connect the device using the Advanced Audio Distribution Profile (A2DP). To change the SCMS-T settings, follow these steps:



Some VAIO models detect support of the SCMS-T content protection on a destination device for automatic reconfiguration of the SCMS-T settings. On such models, **SCMS-T Settings** in step 3 is not displayed because there is no need to manually change the settings.

- 1 Click **Start** and **Devices and Printers**.
- 2 Right-click the icon for the device that you want to connect using the A2DP and select **Control**.
- 3 Click **SCMS-T Settings**.
- 4 Click **No** when the **Connect to a device only if it supports SCMS-T content protection** message appears.

## What should I do if the Bluetooth icon is not displayed on the taskbar?

- Make sure that the switch next to **Bluetooth** is set to **On** in the **VAIO Smart Network** window.
- To display the Bluetooth icon on the taskbar, follow these steps:
  - 1 Click **Start** and **Devices and Printers**.
  - 2 Right-click the Bluetooth device icon and click **Bluetooth settings**.
  - 3 Click the **Options** tab and select the **Show the Bluetooth icon in the notification area** check box.

## Optical Discs

### What should I do if my external optical disc drive does not work properly?

Make sure that your external optical disc drive is connected to an AC power source and the USB port on your computer. If it is not connected, the external optical disc drive may not work properly.



## GPS

### What should I do if I cannot use the GPS function?

- Make sure the **WIRELESS** switch is on.
- Make sure the switch next to **GPS** is set to **On** in the **VAIO Smart Network** window.

### What should I do if I cannot obtain location information or if the current location obtained is incorrect?

- Make sure the **WIRELESS** switch is on.
- Make sure the switch next to **GPS** or **Wireless LAN** is set to **On** in the **VAIO Smart Network** window.
- To successfully obtain location information, your current location must be free of obstacles. Move around to find an optimum location for receiving GPS information.

## Display

### Why did my screen go blank?

- ❑ Your computer screen may go blank if the computer loses power or enters a power saving mode (Sleep or Hibernate). If the computer is in LCD (Video) Sleep mode, press any key to bring the computer back into Normal mode. See **Using the Power Saving Modes (page 30)** for more information.
- ❑ Make sure your computer is securely plugged into a power source and turned on and the power indicator light is lit.
- ❑ If your computer is running on battery power, make sure the battery pack is installed properly and is charged. See **Using the Battery Pack (page 21)** for more information.
- ❑ If the display output is directed to the external display, press the **Fn+F7** keys. See **Combinations and Functions with the Fn Key (page 35)** for more information.

## What should I do if I do not see proper images or videos?

- ❑ Be sure to select **True Color (32 bit)** for the display colors before using video/image software or starting DVD playback. Selecting any other option may prevent such software from displaying images successfully. To change the display colors, follow these steps:
  - 1 Right-click on the desktop and select **Screen resolution**.
  - 2 Click **Advanced settings**.
  - 3 Click the **Monitor** tab.
  - 4 Select **True Color (32 bit)** under **Colors**.
- ❑ Do not change the display resolution or colors while using video/image software or playing DVDs, as it may cause unsuccessful playback/display or unstable system operations. Additionally, it is recommended you disable your screen saver before starting DVD playback. If the screen saver is enabled, it may be activated during DVD playback and prevent the playback from running successfully. Some screen savers have been found to even change the display resolution and colors.

## Why doesn't my screen display a video?

- ❑ If the display output is directed to the external display and the external display is disconnected, you cannot display a video on your computer screen. Stop video playback, change the display output to the computer screen, and then restart video playback. See **Selecting Display Modes (page 99)** for changing the display output. Alternatively, you can press the **Fn+F7** keys to change the display output. See **Combinations and Functions with the Fn Key (page 35)** for more information.
- ❑ The video memory of your computer may be insufficient for displaying high resolution videos. In such a case, lower the resolution of the LCD screen.

To change the screen resolution, follow these steps:

- 1 Right-click on the desktop and select **Screen resolution**.
- 2 Click the drop-down list next to **Resolution**.
- 3 Move the slider up to increase or down to decrease the screen resolution.



You can check the total amount of the graphics and video memory available. Right-click on the desktop, select **Screen resolution**, and click **Advanced Settings** and the **Adapter** tab. The displayed value may be different from the actual amount of memory on your computer.

## What should I do if my screen is dark?

- ❑ Press the **Fn+F6** keys to brighten your computer screen.
- ❑ Blocking the ambient light sensor turns your screen dark. Make sure that the sensor is unblocked.

## What should I do if the external display remains blank?

Press the **Fn+F7** keys to change the display output. See **Combinations and Functions with the Fn Key (page 35)** for more information.

# Printing

## What should I do if I cannot print a document?

- ❑ Make sure your printer is on, and the printer cable is securely connected to the ports on the printer and your computer.
- ❑ Make sure your printer is compatible with the Windows operating system installed on your computer.
- ❑ You may need to install the printer driver software before you use your printer. See the manual that came with your printer for more information.
- ❑ If your printer is not functioning after your computer resumes from a power saving mode (Sleep or Hibernate), then restart the computer.
- ❑ If the bidirectional communication functions are provided with your printer, disabling the functions on your computer may enable printing. Follow these steps:
  - 1 Click **Start** and **Devices and Printers**.
  - 2 Right-click the printer icon and select **Properties**.
  - 3 Click the **Ports** tab.
  - 4 Click to cancel the **Enable bidirectional support** check box.
  - 5 Click **OK**.

This disables the bidirectional communication functions of the printer, such as data transfer, status monitoring, and remote panel.

# Microphone

## What should I do if my microphone does not work?

- ❑ Your computer is not equipped with the microphone jack. You cannot use an external microphone.
- ❑ Your sound input device may have been incorrectly configured. To configure the sound input device, follow these steps:
  - 1 Close all open programs.
  - 2 Click **Start** and **Control Panel**.
  - 3 Click **Hardware and Sound**.
  - 4 Click **Manage audio devices** under **Sound**.
  - 5 On the **Recording** tab, select your desired device for sound input and click **Set Default**.

## How can I prevent microphone feedback?

Microphone feedback occurs when the microphone receives the sound from a sound output device, such as a speaker.

To prevent this problem:

- ❑ Keep the microphone away from a sound output device.
- ❑ Turn down the volume of the speakers and the microphone.

## Speakers

### What should I do if I do not hear sound from the built-in speakers?

- ❑ If you are using a program that has its own volume control, make sure the volume control is properly set. See the program's help file for more information.
- ❑ The volume may have been turned off by the **Fn+F2** keys. Press them once again.
- ❑ The volume may have been minimized by the **Fn+F3** keys. Keep pressing the **Fn+F4** keys to turn up the volume loud enough to hear sound.
- ❑ Check the Windows volume controls by clicking the volume icon on the taskbar.
- ❑ Your sound output device may have been incorrectly configured. To change the sound output device, see **How do I change the sound output device? (page 172)**.

## What should I do if my external speakers do not work?

- ❑ Check the suggestions in **What should I do if I do not hear sound from the built-in speakers? (page 167)**.
- ❑ If you are using a program that has its own volume control, make sure the volume control is properly set. See the program's help file for more information.
- ❑ Make sure your speakers are properly connected and the volume is turned up loud enough to hear sound.
- ❑ Make sure your speakers are designed for computer use.
- ❑ If your speakers have a muting button, set the button to off.
- ❑ If your speakers require external power, make sure the speakers are connected to a power source. See the manual that came with your speakers for more information.
- ❑ Check the Windows volume controls by clicking the volume icon on the taskbar.
- ❑ Your sound output device may have been incorrectly configured. To change the sound output device, see **How do I change the sound output device? (page 172)**.



## Pointing Device

### What should I do if my pointing device does not work?

- ❑ You may have disabled the pointing device(s) before connecting a mouse to your computer. See the tip in **Using the Pointing Device (page 37)**.
- ❑ Make sure that a mouse is not connected to your computer.
- ❑ If the pointer does not move while a software application is running, press the **Alt+F4** keys to close the application window.
- ❑ If the **Alt+F4** keys do not work, press the Windows key once and then the **→** key several times, select **Restart** with the **↑** or **↓** key, and press the **Enter** key to restart your computer.
- ❑ If your computer does not restart, press the **Ctrl+Alt+Delete** keys, select the arrow next to the **Shut down** button with the **↓** and **→** keys, press the **Enter** key, select **Restart** with the **↑** or **↓** key, and press the **Enter** key to restart your computer.
- ❑ If this procedure does not work, press and hold the power button until the computer turns off.

**!** Turning off your computer with the **Ctrl+Alt+Delete** keys or the power button may cause loss of unsaved data.

## Keyboard

### What should I do if the keyboard configuration is wrong?

The language layout of your computer's keyboard is labeled on the packaging box. If you choose a different regional keyboard when you complete the Windows setup, the key configuration will be mismatched.

To change the keyboard configuration, follow these steps:

- 1 Click **Start** and **Control Panel**.
- 2 Click **Clock, Language, and Region**, and then **Change keyboards or other input methods** under **Region and Language**.
- 3 Click **Change keyboards** on the **Keyboards and Languages** tab.
- 4 Change the settings as desired.

### What should I do if I cannot enter certain characters with the keyboard?

If you cannot enter **U, I, O, P, J, K, L, M**, and so on, the **Num Lk** key may be activated. Check that the Num lock indicator light is unlit. If the Num lock indicator is lit, press the **Num Lk** key to turn it off before entering these characters.

## Floppy Disks

### Why doesn't the Safely Remove Hardware and Eject Media icon appear on the taskbar when the drive is connected?

Your computer does not recognize the floppy disk drive. First, make sure the USB cable is properly connected to the USB port. If you need to secure the connection, wait a few moments for the computer to recognize the drive. If the icon still does not appear, follow these steps:

- 1 Close all programs that are accessing the floppy disk drive.
- 2 Wait until the indicator light on the floppy disk drive turns off.
- 3 Push the eject button to remove the disk, and unplug the USB floppy disk drive from your computer.
- 4 Reconnect the floppy disk drive by plugging the USB cable into the USB port.
- 5 Restart the computer by clicking **Start**, the arrow next to the **Shut down** button, and **Restart**.

### What should I do if I cannot write data to a floppy disk?

- Make sure the floppy disk is properly inserted in the drive.
- If the disk is inserted properly and you are still unable to write data to it, the disk may be full or write-protected. You can either use a floppy disk that is not write-protected or disable the write-protect feature.

## Audio/Video

### How do I turn off the Windows startup sound?

To turn off the Windows startup sound, follow these steps:

- 1 Click **Start** and **Control Panel**.
- 2 Click **Hardware and Sound**.
- 3 Click **Manage audio devices** under **Sound**.
- 4 On the **Sounds** tab, click to cancel the **Play Windows Startup sound** check box.
- 5 Click **OK**.

### How do I change the sound output device?

If you do not hear sound from the device connected to a port, such as the USB port, HDMI output port, optical output port, or headphones jack, you need to change the device for sound output.

- 1 Close all open programs.
- 2 Click **Start** and **Control Panel**.
- 3 Click **Hardware and Sound**.
- 4 Click **Manage audio devices** under **Sound**.
- 5 On the **Playback** tab, select your desired device for sound output and click **Set Default**.

### What should I do if I find dropped frames during video playback?

If the video playback window is overlaid with another window, you may encounter dropped frames or find playback performance degraded. Move the video playback window to where it will be unlikely to be overlaid with another window or maximize the video playback window.

## What should I do if I do not hear the sound from the sound output device connected to the HDMI output port, optical output port, or headphones jack?

You need to change the sound output device if you want to hear sound from the device connected to a port, such as the HDMI output port, optical output port, or headphones jack. For the detailed procedure, see **How do I change the sound output device?** ([page 172](#)).

## Why do sound interruptions and/or dropped frames occur when I play high-definition videos, such as those recorded with the AVCHD digital video camcorder?

Playing high-definition videos requires substantial hardware resources, such as CPU, GPU, or system memory performance on your computer. During the video playback, some operations and/or functions may become unavailable, and sound interruptions, dropped frames, and playback failure may occur depending on the configuration of your computer.

## "Memory Stick"

### What should I do if I cannot use "Memory Stick" that was formatted on a VAIO computer on other devices?

You may need to reformat your "Memory Stick".

Formatting "Memory Stick" erases all data, including music data previously saved on it. Before you reformat "Memory Stick", back up important data and confirm that "Memory Stick" does not contain files you want to keep.

- 1 Copy the data from "Memory Stick" onto your built-in storage device to save data or images.
- 2 Format "Memory Stick" by following the steps in **Formatting "Memory Stick" (page 51)**.

### Can I copy images from a digital camera using "Memory Stick"?

Yes, and you can view video clips that you have recorded with digital cameras that are compatible with "Memory Stick".

### Why can't I write data to "Memory Stick"?

Some versions of "Memory Stick" are equipped with an erasure prevention switch to protect data from unintentional erasure or overwriting. Make sure the erasure prevention switch is off.

## Peripherals

### What should I do if I cannot connect a USB device?

- ❑ If applicable, check the USB device is turned on and using its own power supply. For example, if you are using a digital camera, check if the battery is charged. If you are using a printer, check if the power cable is connected properly to an AC outlet.
- ❑ Try using another USB port on your computer. The driver software could be installed to the specific port you used the first time you connected the device.
- ❑ See the manual that came with your USB device for more information. You may need to install software before you connect the device.
- ❑ Try connecting a simple, low-powered device such as a mouse to test if the port is working at all.
- ❑ USB hubs may prevent a device from working because of a power distribution failure. We recommend you connect the device directly to your computer without a hub.

# Trademarks

SONY, the SONY logo, VAIO and the VAIO logo are registered trademarks of Sony Corporation.

"BRAVIA" is a trademark of Sony Corporation.



and "Memory Stick", "Memory Stick Duo", "MagicGate", "OpenMG", "Memory Stick PRO", "Memory Stick PRO Duo", "Memory Stick PRO-HG Duo", "Memory Stick Micro", "M2", and the "Memory Stick" logo are trademarks or registered trademarks of Sony Corporation.

Walkman is a registered trademark of Sony Corporation.

i.LINK is a name to denote IEEE 1394. i.LINK and i.LINK logo "i" are the trademarks of Sony Corporation.

Intel, Pentium, Intel SpeedStep, and Atom are trademarks or registered trademarks of Intel Corporation.

Microsoft, MS-DOS, Windows, Windows Vista, BitLocker, Aero, and the Windows logo are trademarks of Microsoft group of companies.

Blu-ray Disc™ and the Blu-ray Disc logo are trademarks of the Blu-ray Disc Association.

The Bluetooth word mark and logos are registered trademarks owned by Bluetooth SIG, Inc. and any use of such marks by Sony Corporation is under license. Other trademarks and trade names are those of their respective owners.

Roxio Easy Media Creator is a trademark of Sonic Solutions.

WinDVD for VAIO and WinDVD BD are trademarks of InterVideo, Inc.

ArcSoft and the ArcSoft logo are registered trademarks of ArcSoft, Inc. ArcSoft WebCam Companion is a trademark of ArcSoft, Inc.

ATI and ATI Catalyst are trademarks of Advanced Micro Devices, Inc.



SD Logo is a trademark. 

SDHC Logo is a trademark. 

The ExpressCard word mark and logos are owned by the PCMCIA and any use of such marks by Sony Corporation is under license. Other trademarks and trade names are those of their respective owners.

HDMI, the HDMI Logo, and High-Definition Multimedia Interface are trademarks or registered trademarks of HDMI Licensing LLC in the United States and other countries.

CompactFlash<sup>®</sup> is a trademark of SanDisk Corporation.

, "XMB," and "xross media bar" are trademarks of Sony Corporation and Sony Computer Entertainment Inc.

"PlaceEngine" is a registered trademark of Koozyt, Inc.

"PlaceEngine" was developed by Sony Computer Science Laboratories, Inc. and is licensed by Koozyt, Inc.

"AVCHD" is a trademark of Panasonic Corporation and Sony Corporation.

All other names of systems, products, and services are trademarks of their respective owners. In the manual, the <sup>™</sup> or <sup>®</sup> marks are not specified.

Features and specifications are subject to change without notice.

All other trademarks are trademarks of their respective owners.

Not all the software listed above may be delivered with your model.

# Notice

© 2010 Sony Corporation. All rights reserved.

This manual and the software described herein, in whole or in part, may not be reproduced, translated, or reduced to any machine-readable form without prior written approval.

Sony Corporation provides no warranty with regard to this manual, the software, or other information contained herein and hereby expressly disclaims any implied warranties or merchantability or fitness for any particular purpose with regard to this manual, the software, or such other information. In no event shall Sony Corporation be liable for any incidental, consequential, or special damages, whether based on tort, contract, or otherwise, arising out of or in connection with this manual, the software, or other information contained herein or the use thereof.

In the manual, the ™ or ® marks are not specified.

Sony Corporation reserves the right to make any modification to this manual or the information contained herein at any time without notice. The software described herein is governed by the terms of a separate user license agreement.

Sony Corporation is not liable and will not compensate for any lost recordings made to your computer, external recording media, or recording devices or any relevant losses, including when recordings are not made due to reasons including your computer failure, or when the contents of a recording are lost or damaged as a result of your computer failure or repair undertaken to your computer. Sony Corporation will not restore, recover, or replicate the recorded contents made to your computer, external recording media, or recording devices under any circumstances.



## Free Manuals Download Website

<http://myh66.com>

<http://usermanuals.us>

<http://www.somanuals.com>

<http://www.4manuals.cc>

<http://www.manual-lib.com>

<http://www.404manual.com>

<http://www.luxmanual.com>

<http://aubethermostatmanual.com>

Golf course search by state

<http://golfingnear.com>

Email search by domain

<http://emailbydomain.com>

Auto manuals search

<http://auto.somanuals.com>

TV manuals search

<http://tv.somanuals.com>