

## SERIES AND PARALLEL WIRING

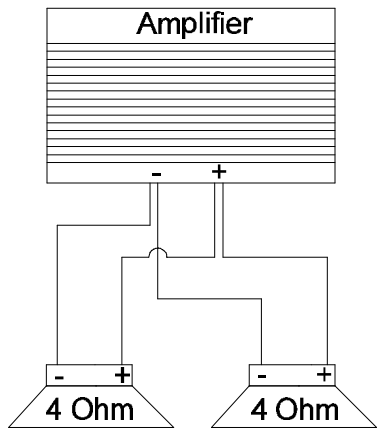

*2-4 ohm drivers in parallel  
= 2 ohms*

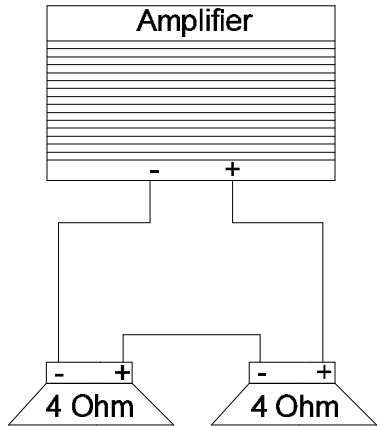

*2-4 ohm drivers in series  
= 8 ohms*

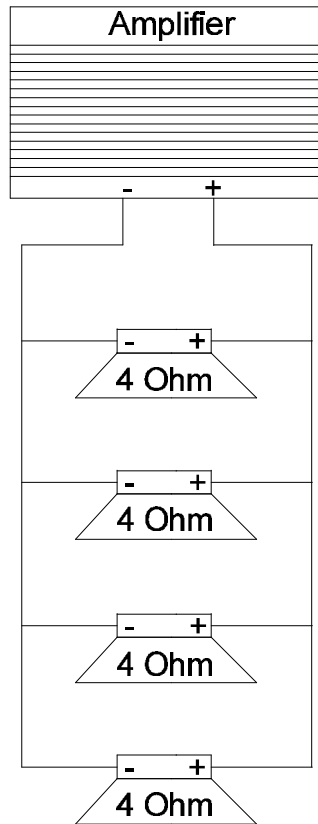

*4-4 ohm drivers in parallel  
= 1 ohm*

# REFERENCE

## Class A

### 5.0 & 10.0

## Power Amplifiers

## OWNERS MANUAL AND INSTALLATION GUIDE

SOUNDSTREAM TECHNOLOGIES

120 Blue Ravine Road Folsom California 95630 USA  
ph 916.351.1288 fax 916.351.0414

rev B - 4.17.96

**SOUNDSTREAM**<sup>®</sup>  
T E C H N O L O G I E S

## CONGRATULATIONS!

You now own **the REFERENCE Class A Amplifier**, the product of an uncompromising design and engineering philosophy. Your Soundstream REFERENCE Class A amplifier will outperform any other amplifier in the world.

To maximize the performance of your system, we recommend that you thoroughly acquaint yourself with its capabilities and features. Please retain this manual and your sales and installation receipts for future reference.

Soundstream amplifiers are the result of American craftsmanship and the highest quality control standards, and when properly installed, will provide you with many years of listening pleasure. Should your amplifier ever need service or replacement due to theft, please record the following information, which will help protect your investment.

Model and Serial # \_\_\_\_\_

Dealer's Name \_\_\_\_\_

Date of Purchase \_\_\_\_\_

Installation Shop \_\_\_\_\_

Installation Date \_\_\_\_\_

### **CAUTION!**

*Prolonged listening at high levels may result in hearing loss. Even though your new Soundstream REFERENCE Class A amplifier sounds better than anything you've ever heard, exercise caution to prevent hearing damage.*

## **SERVICE**

Your Soundstream REFERENCE Class A amplifier is protected by a limited

## **SPECIFICATIONS**

<b>POWER</b>	<b>4 Ω Stereo (8 Ω Bridged) (12 Vdc)</b>	<b>2 Ω Stereo (4 Ω Mono)</b>	<b>1 Ω Stereo (2 Ω Mono)</b>	<b>1/2 Ω Stereo (1 Ω Mono)</b>	<b>1/4 Ω Stereo (1/2 Ω Mono)</b>
<i>REFERENCE Class A 5.0</i>					
<b>Watts</b>	12.5 x 2 (25 x 1)	50 x 2 (100 x 1)	100 x 2 (200 x 1)	250 x 2 (500 x 1)	250 x 2 (500 x 1)
<i>REFERENCE Class A 10.0</i>					
<b>Watts</b>	25 x 2 (50 x 1)	100 x 2 (200 x 1)	250 x 2 (500 x 1)	500 x 2 (1000 x 1)	500 x 2 (1000 x 1)

**THD** <0.1%

**Signal to Noise** >100 dB

**Frequency Response** 20 Hz to 20 kHz ± 0.5 dB

**Stereo Separation** >90 dB

**Damping** >200

**Input Sensitivity** 200mV - 2.0V, or 500mV to 5.0V

**Input Impedance** 10K ohms

### ***LSE.Q (Reference CA 10.0)***

0.7 - 2.8 Q (0 to +9 dB), adjustment from 30 to 60 Hz

### ***Dimensions (W x D x H)***

**REFERENCE CLASS A 5.0:** 12.25" x 9.8" x 2.25"

**REFERENCE CLASS A 10.0:** 15.0" x 9.8" x 2.25"

## PROTECTION CIRCUITRY

Your REFERENCE Class A amplifier is protected against both overheating and short circuits by means of the following circuits:

- Main power supply fuses
- Smart Power Supply Thermal Rollback activating at 85°C.
- A fail-safe thermal protection circuit activating at 95°C.

Your amplifier also incorporates an innovative Fault Diagnosis system that

**NOTE:** If you experience blown main power supply fuses, DO NOT increase values beyond the original fuse value! Doing so will void your warranty and may damage your amplifier. If you blow fuses with the REFERENCE Class A amplifiers, it is likely that the amplifier is seeing a dead short, either in the speaker

## TROUBLESHOOTING

<b>PROBLEM</b>	<b>CAUSE</b>
No sound and power LED <u>is not lit</u>	<ul style="list-style-type: none"> <li>• No power or ground at amp</li> <li>• No remote turn-on signal</li> <li>• Blown fuse near battery</li> </ul>
No sound, a power LED <u>is lit</u> , and the <b>AIRBASS™</b> option has not been added.	<ul style="list-style-type: none"> <li>• No signal input</li> <li>• The <b>AIRBASS™</b> switch is in the "IN" position. Move it to the "OUT" position</li> </ul>
Fault LED is lit	<ul style="list-style-type: none"> <li>• Amp power supply fuse is blown or missing</li> </ul>
Repeatedly blown amp fuse, frequent activation of Smart Power Supply Circuit	<ul style="list-style-type: none"> <li>• Speaker or leads may be shorted</li> <li>• Verify adequate amplifier ventilation</li> </ul>
Not enough input sensitivity while using Balanced input	<ul style="list-style-type: none"> <li>• Be sure both Left and Right Input Signal Switches are set to the "BAL" position</li> </ul>
Left and Right Input Over-load indicators lighting	<ul style="list-style-type: none"> <li>• Input signal level is too high - readjust input gains, or select the 0.5-5V input signal level range</li> </ul>
Alternator whine while using Unbalanced RCA inputs	<ul style="list-style-type: none"> <li>• Make sure the Right Input Signal Switch is in the "UNBAL" position.</li> <li>• Try the Left Input Signal Switch in the "BAL" and "UNBAL" position: leave the switch in the quietest position. This will not effect the performance of the amplifier.</li> </ul>

## TABLE OF CONTENTS

Design Features.....	4 - 5
<b>AIRBASS™</b> .....	5
Reference Class A 5.0 Diagram.....	6 - 7
Reference Class A 10.0 Diagram.....	8 - 9
Selecting Input Modes.....	10
Balanced / Unbalanced Input.....	11
Wiring & Wiring Diagram.....	12 - 13
Installation and Mounting .....	14
Level Setting .....	15
LSE.Q Theory and Use.....	16 - 17
Protection Circuitry & Troubleshooting.....	18
Service .....	19
Specifications.....	19

## DESIGN FEATURES

- **Pure Class A Output Topology** for the utmost in musicality and definitive power output. Soundstream's unique design allows the Class A amplifiers to deliver incomparable sonics or, when operated at lower impedances, to provide phenomenal amounts of power.
- **Uncompromising Design and Construction** including mil-spec glass epoxy circuit boards and high current custom gold-plated solid brass connections that will accept up to 4 gauge power/ground wire.
- **Quad Factor™ Circuitry** - Soundstream's newest power supply design allows the Class A amplifiers to make four times the power when going from a 4 ohm stereo load to a 2 ohm stereo load, and again when going from a 2 ohm stereo to a 1/2 ohm stereo load!
- **Coherent Stereo™/Mixed Mono** selection for either "pure" stereo operation or mixed mono for simultaneous stereo and mono.
- **Chassisink™ Darlington Power Array** - Soundstream's "overbuilding" of the output section incorporates multiple output transistors instead of a few for faster, stronger power delivery. The transistors are sandwiched between the circuit board and the heatsink in a design called Chassisink™ to ensure cool, efficient amplifier operation.
- **PowerGrid Power Supply Design** - All power supply components are located near one another, connected by thick, wide PCB traces, which ensures rapid, high current delivery. The entire power supply is isolated on one side of the circuit board while the audio stage is located opposite it, guaranteeing minimal noise.
- **Ultra-Low ESR Capacitance Bank** - Multiple small input power capacitors are used to provide a lower ESR (Equivalent Series Resistance), which means more power in and out faster.
- **Smart Thermal Rollback** - Most amplifiers shut off when they get too hot. In the unlikely event the REFERENCE Class A amplifier reaches 85° C, it will gradually roll back its average power (without affecting the dynamics). Once the amplifier has cooled off, it returns to full power output. If overheating should continue, a second thermal sensing protection circuit will shut off the amplifier if the heatsink reaches 95° C.
- **Fault Monitor LED** on the top panel notifies you of blown power supply fuses.
- **1/4 ohm Drive Ability** - The REFERENCE Class A amplifiers are designed to drive virtually any load—all the way down to 1/4 ohm stereo (1/2 ohm mono).
- **Dual Discrete Class A Drive Stages** - Over six times the drive current of

## LSE.Q THEORY AND USE (continued)

This is due to the loss of any appreciable resistive air mass. At frequencies below resonance, the woofer starts to behave as if it were mounted in "free-air". If we wish to improve the performance of a vented system, we should remove these unwanted signals from our system. These can be removed by adding a subsonic filter. Figure 5 shows the effectiveness of LSE.Q on woofer excursion. Woofer travel is 7.5 mm at 10 Hz, with LSE.Q properly adjusted, this excursion can be reduced to less than 1 mm. This is of great benefit to lowering woofer distortion and increasing output.

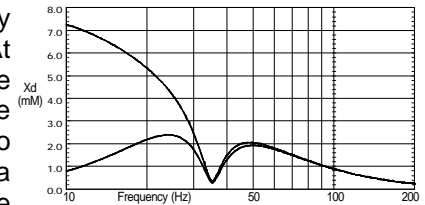

FIG. 5 Limited Excursion

### Adjustment

An easy method of optimizing your existing subwoofer enclosure with LSE.Q's "Hz" control is as follows.

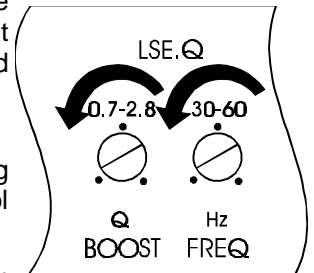

FIG. 6 LSE.Q Setting

1 Adjust frequency and boost control to full CCW position. (See figure 6)

2 While listening to music with strong bass content at a moderate level, slowly adjust frequency control clockwise. Listen for a reduction of bass response. Now, rotate frequency control slightly backwards. This serves the purpose of removing the "subsonic" bass energy.

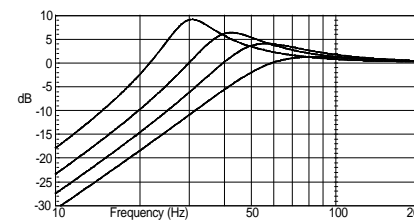

FIG. 7 Various Settings

Soundstream's LSE.Q contains the same type of circuit with the added benefit of infinite adjustability. Our "Q" and "Hz" control can provide virtually any combination of boost

**NOTE:** The LSE.Q circuit on the Class A 10.0 can be defeated for flat operation down to 20 Hz by placing the LSE.Q switch in the "OUT" position. You may wish to use this option to achieve a higher S/N Ratio when using ultra-high efficiency speakers, such as compression

## LSE.Q THEORY AND USE (Class A 10.0)

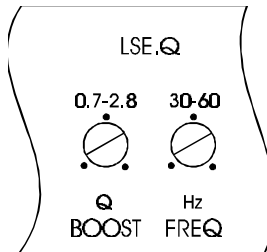

FIG. 1 LSE.Q

**LSE.Q** is a unique subwoofer control circuit included with the SOUNDSTREAM REFERENCE Class A 10.0 amplifier. It is capable of removing subsonic energy in program material. The circuit consists of two controls. One adjusts the frequency of operation and the other adjusts the range of boost. With both controls adjusted fully counter-clockwise, no boost is applied and the amplifier is flat in response down to 30 Hz.

The **frequency control (Hz)** adjusts the starting point of the subsonic filter. This high pass filter can be adjusted from 30 Hz up to a maximum of 60 Hz. This control is useful for setting the lowest frequency that your subwoofer will see. (See figure 1)

The **Q control** adjusts the amount of boost applied at the set frequency. This is adjustable from .707 (flat) to 2.8 (+9 dB). (See figure 2)

When the Q is set to .707 (Butterworth), LSE.Q acts as a sub-sonic filter only. (See figure 3)

The simple act of removing the signal below the vented tuning frequency can improve system output by as much as 3 dB. With

Q values greater than .707, boost is added to the sub-sonic filter. (see figure 4)

### Application

Woofers in vented enclosures have good power handling characteristics above the tuning frequency, but below the tuning frequency, power handling drops off considerably.

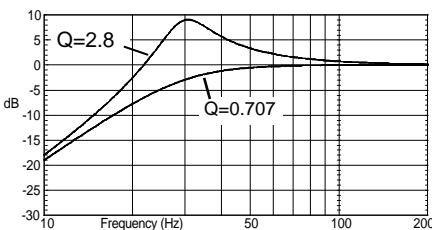

FIG. 2 Variable "Q"

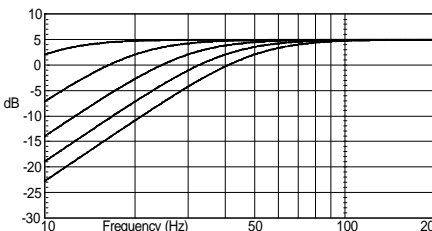

FIG. 3 Variable High Pass

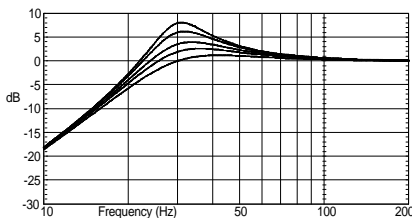

FIG. 4 Variable "Q"

most amplifiers in the Class A 5.0, and over twelve times in the Class A 10.0! More drive current maintains the amplifiers' performance into low impedance loads.

- **Drive Delay™ Muted Turn-on/off Circuit** - A unique circuit which completely eliminates any amplifier-related turn-on/off noises.
- **Flexible Dual Input Level Sensitivity** accepts 2 voltage ranges; from 200 mV to 2.0 V and from 500 mV to 5.0 V, permitting maximum output from the amplifier with virtually any source unit.
- **Differential Balanced Input Design** for added immunity to noise caused by component and vehicle electrical system interaction when using Unbalanced RCA inputs.
- **True Balanced Input** for professional-quality performance and noise cancellation. The 6-pin din plug carries (+) and (-) Signal information for Left and Right channels, audio ground, and  $\pm 15$  Vdc to operate the Soundstream BLT Balanced Line Transmitter.

## AIRBASS™ ACCESSORY OPTION

Soundstream's new AIRBASS™ feature can be added to the REFERENCE Class A amplifiers. This feature allows wireless RF remote control level adjustment of the amplifier.

**NOTE:** The AIRBASS™ accessory is intended to be used only while the REFERENCE Class A amplifiers are driving subwoofers. When the AIRBASS™ accessory is added to a REFERENCE Class A amplifier, it automatically configures the amplifier into Bridged Mono mode. (The Coherent Stereo / Mixed Mono / Bridged Mono switch is bypassed.) Therefore, when using AIRBASS™, follow the Bridged Mono input and output wiring

Installing AIRBASS™ involves removing the bottom plate of the amplifier, adding the AIRBASS™ circuit board, and flipping a switch. The switch is labeled on the amplifier's main circuit board. DO NOT set the AIRBASS™ switch to the "IN" position unless the AIRBASS™ module has been added. DO NOT move the AIRBASS™ switch while the amplifier is "ON". Doing so may damage your speakers. (Please refer to the AIRBASS™ owner's / installation manual for more details.)

## LEVEL SETTING

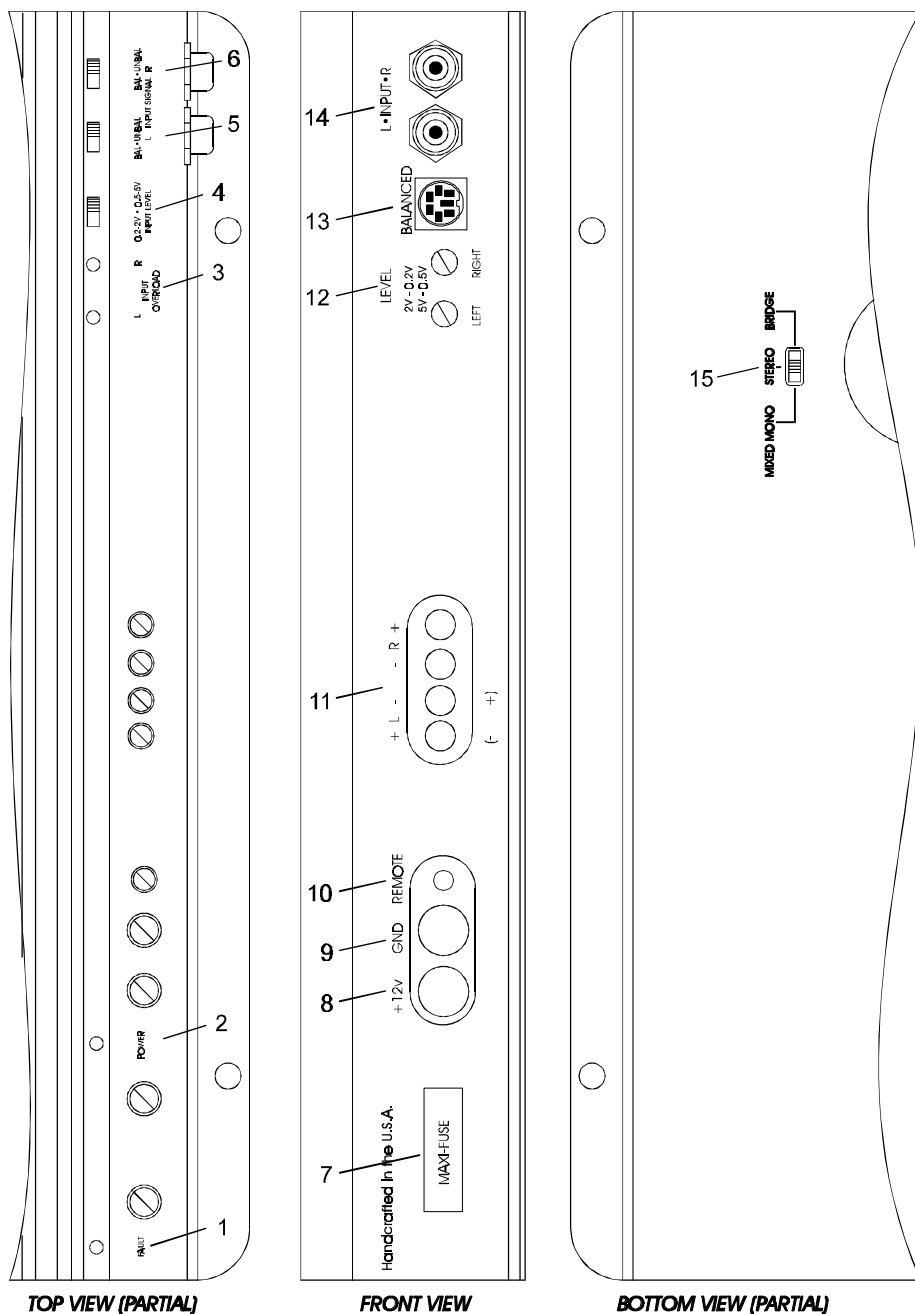

The input levels are adjusted by means of the individual channel input level controls located on the front of the amplifier. This is a unique dual-stage circuit that adjusts both level and gain. This topology maintains better Signal to Noise ratios even when using sources with minimal output.

In the ideal situation, all components in the audio system reach maximum undistorted output at the same time. The reason is because an amplifier will only make what comes into it bigger. So, if you send it a distorted signal from the head unit, the amplifier is going to amplify distorted information. The same thing holds true if an outboard processor or crossover begins to distort before you have maximum output from the amplifier. By setting all components to reach clipping at the same time, you can maximize the output of your system. For the REFERENCE Class A amplifiers, follow the following steps for the quickest, easiest means of setting the levels.

1. Turn the amp's input levels to minimum position (fully counter-clockwise).
2. Begin with the input level switch in the 0.5 - 5.0 Volt position.
3. Set source unit volume to approximately 3/4 of full volume.
4. While playing dynamic source material, slowly increase the amplifier's input level until a near maximum undistorted level is heard in the system.

If your preamplifier / source unit has an extremely high output level, be sure to pay attention to the clipping indicators located on the top of the amplifier. These indicators will notify you if you are clipping the *PREAMPLIFIER* stage of the amplifier. If the amplifier's output is distorted and the clipping lights are not blinking, you are most likely clipping the *OUTPUTS* of the amplifier, or driving the speaker to distortion.

# INSTALLATION STEP 4

## INSTALLATION AND MOUNTING

### 1. AMPLIFIER LOCATION

The REFERENCE Class A amplifiers employ highly efficient circuitry and a unique Chassisink™ design to maintain lower operating temperatures. Additional cooling may be required if the amplifier is located in a tightly confined area or when driving especially low impedance loads at extremely high levels.

When mounting the amplifier, it should be securely mounted to either a panel in the vehicle or an amp board or rack that is securely mounted to the vehicle. The mounting location should be either in the passenger compartment or in the trunk of the vehicle, away from moisture, stray or moving objects, and major electrical components. To provide adequate ventilation, mount the amplifier so that there are at least two inches of freely circulating air above and to the sides of it.

### 2. SWITCHES

Set the Coherent Stereo™/Mixed-Mono/Bridged Mono and Amplifier crossover switches on the bottom of the amplifier to the appropriate positions before bolting down the amplifier (see pages 13 - 16). Be sure to replace the hole plugs.

### 3. MOUNTING THE AMPLIFIER

- Using the amplifier as a template, mark the mounting surface.
- Remove the amplifier and drill the holes.
- Mount the amplifier to the surface using the provided hardware.

### 4. WIRING

- Run and connect the audio signal and remote turn-on cables to the amplifier from the source unit.
- Carefully run the positive cable from the amplifier to a fuse or circuit breaker within 18" of the battery.
- Connect the fuse or circuit breaker to the battery. Leave the circuit breaker off or the fuse out until everything is bolted down.

**NOTE:** *There may be a sizable spark when connecting the power and ground lead to the amplifier for the first time. Please see the comment on the previous*

- Secure the ground cable to a solid chassis ground on the vehicle. It may be necessary to sand paint down to raw metal for a good connection.
- Double check each and every connection!

## Key to Callouts

- Fault LED** - Indicates a blown fuse.
- Power LED** - Indicates amplifier power on.
- Input Overload Indicators** - Indicates the signal input level or input gain level is too high.
- Input Level Selector Switch** - Selectable input sensitivity range from 0.2-2 Volts RMS, or from 0.5-5 Volts RMS.
- Left Channel Balanced / Unbalanced Input Selector Switch** - Select "Balanced" to use the 6 pin Balanced signal Input. Select "Unbalanced" to use the RCA signal inputs.
- Right Channel Balanced / Unbalanced Input Selector Switch** - Select "Balanced" to use the 6 pin Balanced signal Input. Select "Unbalanced" to use the RCA signal inputs.
- Main Fuse** - Main power supply fuse. Replace only with the same value fuse.
- +12V** - Connected to a fuse or circuit breaker, then to the battery's positive post.
- GND** - Main ground connection. Bolt to a clean chassis ground in the vehicle.
- REM** - Remote turn-on input from the head unit. Accepts +12V.
- Speaker Output Connections** - Left and right channels.
- Input Level** - Independent Left and Right channel input level controls.
- Balanced Signal Input Connector** - 6-pin Balanced signal input connector for use with the Soundstream BLT Balanced Line Transmitter.
- Inputs** - Right and left channel RCA (Unbalanced ) inputs; only right channel input is used in "Mono" mode.
- Coherent Stereo/Bridge/Mixed Mono switch** - Select "Bridge" for bridged mono operation (use right channel input). Select "Stereo" for coherent stereo operation. Select "Mixed Mono" for simultaneous stereo / bridged mono operation.

# Class A

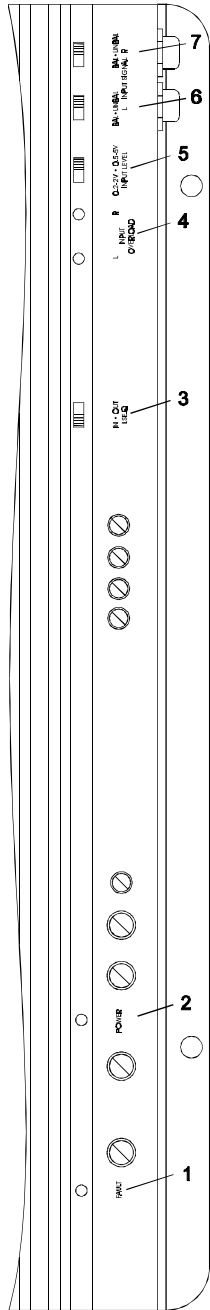

TOP VIEW (PARTIAL)

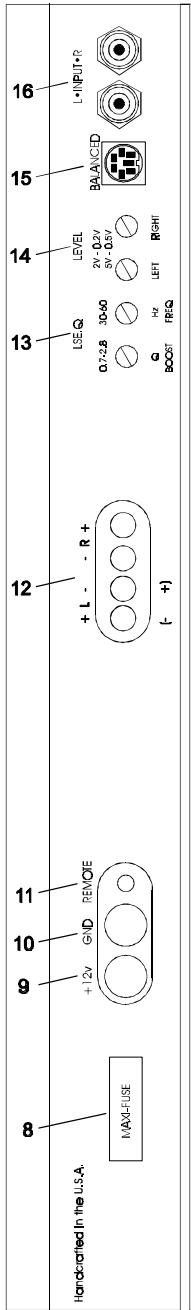

FRONT VIEW

8

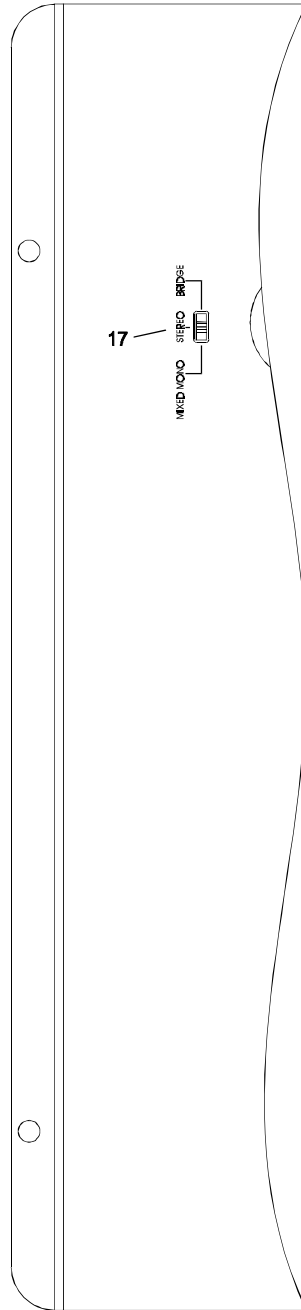

BOTTOM VIEW (PARTIAL)

(Continued from page 12)

of blown power supply fuse, the "Fault" indicator on the top panel will light. The fuse is accessible from the front panel of the amplifier. See the chart below to determine the fuse value. **Never replace the fuses with a higher value than what is supplied. This may result in amplifier damage and will**

## REFERENCE Class A Amplifier Fuse Values

Amplifier	Amplifier Fuse	Battery Fuse / Circuit Breaker
Class A 5.0	40 amp Maxi-Fuse	60 amp
Class A 10.0	80 amp Maxi-Fuse	100 amp

## REMOTE TURN-ON

Connect the "Remote" to the turn-on lead from the source unit. When +12 volts is received, the amplifier will turn on.

## SIGNAL CABLE

Use a high-quality cable that will be easy to install and has minimal signal loss to guarantee optimum performance. Soundstream's DL 1 and SL 1 are ideal when using the Unbalanced RCA inputs. While using the Balanced DIN input, use the cable supplied with the BLT.

## SPEAKER CABLE

The REFERENCE Class A amps will accept up to 8 gauge speaker cable. Use a high quality, flexible, multi-strand cable for best performance and longevity. Soundstream Speaker120 & 160 (12 and 16 gauge) are ideal.

## WIRING DIAGRAM

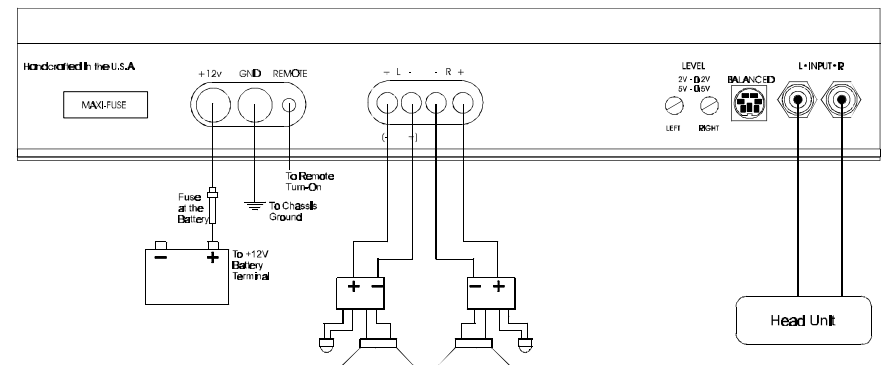

13



# INSTALLATION STEP 3

## WIRING

### **POWER AND GROUND**

To ensure maximum output from your REFERENCE Class A amplifier, use high quality, low-loss power and ground cables. The REFERENCE Class A amplifiers will accept up to 4 gauge power and ground cables. Determine

	<i>up to 10'</i>	<i>up to 20'</i>
<b>Class A 5.0</b>	Soundstream Power40 or Power80	Soundstream Power40 only (4 ga.)
<b>Class A 10.0</b>	Soundstream Power40 only (4 ga.)	Soundstream Power40 only (4 ga.)

### ***Read this, or sparks will fly!***

The Soundstream REFERENCE Class A amplifiers have extensive internal power supply capacitance, called the **Ultra-Low ESR Capacitance Bank**. Multiple small input power capacitors act as an internal "stiffening capacitor". Because of the large amount of internal capacitance, there may be a sizable spark when connecting the power and ground lead to the amplifier for the first time. In order to charge the capacitor bank without a spark, we suggest you do the following:

1. Connect the +12 volt cable to the amplifier and to the battery.
2. Connect one end of the ground cable to the chassis of the vehicle.
3. We have supplied a 150 ohm, 2 watt resistor with the amplifier. One leg of the resistor has been connected to the ground terminal of the amplifier.
4. To charge the capacitor bank, touch the loose end of the ground cable to the open leg of the resistor for at least 45 seconds.

### **CIRCUIT BREAKERS/FUSES**

#### **EXTERNAL**

Like all audio components, the REFERENCE Class A amplifiers must be fused near the battery. A fuse or circuit breaker must be located within 18" of the battery. This will prevent a fire in the event of a shorted cable. See the chart below to determine the correct fuse value.

#### **INTERNAL**

The REFERENCE Class A amplifiers are fused with Maxi-fuses. In the event

*(Continued on page 13)*

## Key to Callouts

1. **Fault LED** - Indicates a blown fuse.
2. **Power LED** - Indicates amplifier power on.
3. **LSE.Q Bypass Switch** - Turns the LSE.Q on ("IN") or off ("OUT").
4. **Input Overload Indicators** - Indicates the signal input level or input gain level is too high.
5. **Input Level Selector Switch** - Selectable input sensitivity range from 0.2-2 Volts RMS, or from 0.5-5 Volts RMS.
6. **Left Channel Balanced / Unbalanced Input Selector Switch** - Select "Balanced" to use the 6 pin Balanced signal Input. Select "Unbalanced" to use the RCA signal inputs.
7. **Right Channel Balanced / Unbalanced Input Selector Switch** - Select "Balanced" to use the 6 pin Balanced signal Input. Select "Unbalanced" to use the RCA signal inputs.
8. **Main Fuse** - Main power supply fuse. Replace only with the same value fuse.
9. **+12V** - Connected to a fuse or circuit breaker, then to the battery's positive post.
10. **GND** - Main ground connection. Bolt to a clean chassis ground in the vehicle.
11. **REM** - Remote turn-on input from the head unit. Accepts +12V.
12. **Speaker Output Connections** - Left and right channels.
13. **LSE.Q** - Frequency and Q adjustments.
14. **Input Level** - Independent Left and Right channel input level controls.
15. **Balanced Signal Input Connector** - 6-pin Balanced signal input connector for use with the Soundstream BLT Balanced Line Transmitter.
15. **Inputs** - Right and left channel RCA (Unbalanced ) inputs; only right channel input is used in "Mono" mode.
16. **Coherent Stereo/Bridge/Mixed Mono switch** - Select "Bridge" for bridged mono operation (use right channel input). Select "Stereo" for coherent stereo operation. Select "Mixed Mono" for simultaneous stereo / bridged mono operation.

# INSTALLATION STEP 1

## COHERENT STEREO™ / MIXED-MONO / BRIDGED MONO

The REFERENCE Class A amplifiers have the ability to operate in any one of the following modes:

**Coherent Stereo™** with identical left and right stereo channels for maximum fidelity. Best choice for satellite speakers. Use this mode unless Mixed-Mono is necessary.

**Mixed-Mono** in order to drive stereo and mono simultaneously; works well for center channels. It can be used anytime you need a summed mono channel. Somewhat sacrifices sonic accuracy as additional circuitry is introduced to one channel. **In Mixed-Mono, the left channel is inverted, see diagram below or on the bottom of the amplifier.**

**Bridged Mono** for dedicated single channel operation; ideal for driving subwoofers. It is also used when large amounts of power are necessary for single speakers. **In bridged mono, only the right channel input is active.**

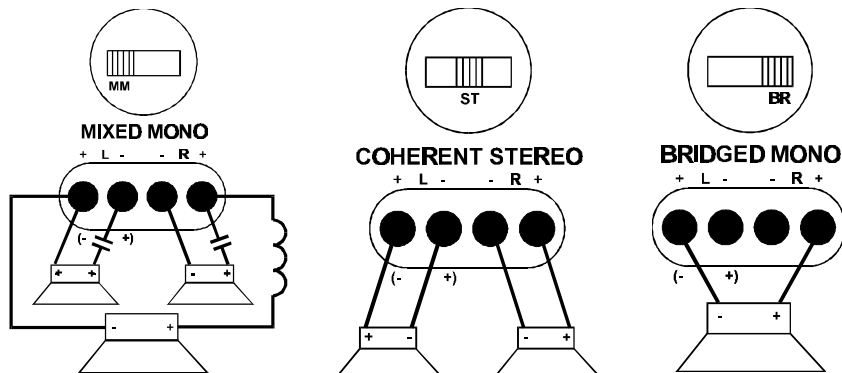

**In bridged mono, only the right channel input is active.**

**NOTE:** If you intend to drive a REFERENCE Class A amplifier in Mono but have stereo outputs from your crossover or source unit, you can put the switch in

# INSTALLATION STEP 2

## BALANCED / UNBALANCED INPUT

The REFERENCE Class A amplifiers have the ability to accept either a standard Unbalanced RCA signal inputs, or a Balanced "Pro Audio" inputs with the use of the Soundstream **BLT** Balanced Line Transmitter or some other balanced line audio source. Before installing your system, you should decide

	<b>UNBALANCED INPUT</b>	<b>BALANCED INPUT</b>
<b>ADVANTAGES</b>	<ol style="list-style-type: none"> <li>1. Most preamplifier / source units have "UNBAL" RCA outputs. (Industry standard)</li> <li>2. No Interface module is necessary</li> </ol>	<ol style="list-style-type: none"> <li>1. Improved Signal to Noise Ratio. (S/N Ratio)</li> <li>2. Excellent noise cancellation characteristics.</li> <li>3. Immune to noise radiated in the car audio environment.</li> </ol>

The REFERENCE Class A amplifiers' signal inputs accept two ranges of input signal levels: 0.2 - 2.0 Vrms, or 0.5 - 5.0 Vrms for both Balanced and Unbalanced inputs. The input range switch position and level settings are dependent upon the preamplifier / source unit output signal level. For the best system Signal to Noise Ratio, we recommend that the input level controls be set as far down as possible (rotated counter-clockwise), while maintaining an acceptable level of output.

### Using the "Unbalanced" RCA input

When using the Unbalanced RCA input, the **RIGHT** channel input signal switch **MUST** be in the "UNBAL" position. Also, when first installing the amplifier using this input configuration, we suggest that the left channel input signal switch be in the "UNBAL" position as well. **If you experience alternator wane or other installation noise with both switches in the "UNBAL" position, try moving the LEFT channel input signal switch to the "BAL" position.** This should remove any system noise due to installation.

### Using the "Balanced" RCA input

When using the Balanced 6-pin DIN input, both switches **MUST** be in the "BAL" position. Also, we recommend that when using this input configuration, the "INPUT LEVEL" switch be in the "0.5 - 5V" position, and the gains on the

**NOTE:** The pin configuration shown in the diagram is the view looking into the Balanced input jack on the amplifier.

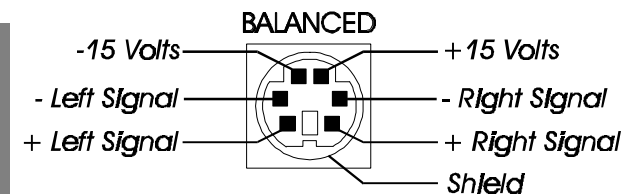

## Free Manuals Download Website

<http://myh66.com>

<http://usermanuals.us>

<http://www.somanuals.com>

<http://www.4manuals.cc>

<http://www.manual-lib.com>

<http://www.404manual.com>

<http://www.luxmanual.com>

<http://aubethermostatmanual.com>

Golf course search by state

<http://golfingnear.com>

Email search by domain

<http://emailbydomain.com>

Auto manuals search

<http://auto.somanuals.com>

TV manuals search

<http://tv.somanuals.com>