SOUNDSTREAM

T E C H N O L O G I E S

Owner's Manual and Installation Guide

LW1.1100D

LW1.1700D

LW1.2600D

Lil wonder **III** *Generation*

CONGRATULATIONS!

You now own a Limited Edition LIL'WONDER Amplifier, the product of an uncompromising design and engineering philosophy.

To maximize the performance of your system, we recommend that you thoroughly acquaint yourself with its capabilities and features. Please retain this manual and your sales receipt for future reference.

Soundstream amplifiers are the result of American innovation and the highest quality control standards. When properly installed, they will provide you with many years of listening pleasure. Should your amplifier ever need service or replacement due to theft, please record the following information which will help protect your investment.

Serial # _____

Dealer's Name _____

Date of Purchase _____

Installation Shop _____

Installation Date _____

CAUTION!

Prolonged listening at extremely high levels may result in hearing loss. Even though your new Soundstream **Limited Edition LIL'WONDER Amplifier**, sounds better than anything you've heard, exercise caution to prevent hearing damage.

FEATURES

- ▶ Mono-Block Class D Amplifier
- ▶ Total Harmonic Distortion:0.5%
- ▶ Frequency Response: 15-150Hz
- ▶ Signal to Noise Ratio: 105dB
- ▶ Damping Factor: >250
- ▶ Input Sensitivity 100mV - 8V
- ▶ 50-150Hz,12dB Low Pass Fiter
- ▶ 45Hz, 0-18dB Bass Boost
- ▶ 180° Phase Switch
- ▶ Midnight Black Finish w/ Brushed Accents
- ▶ Remote Gain Control
- ▶ Master/Slave Operation
- ▶ Pre-amp Outputs

SPECIFICATIONS

Signal/Noise Ratio	>105dB
Frequency Response	15Hz-150Hz
THD	0.50%
LPF	50Hz -150Hz,12dB
Input Voltage Range	11-16 Volts DC
High Impedance RCA/LINE Level Input Impedance	30K Ohms

POWER RATINGS & FUSE

MODEL	4 ohm	2 ohm	1 ohm	FUSE
LW1.1100D	600W	900W	1100W	35A X 3
LW1.1700D	700W	1200W	1700W	40A X 4
LW1.2600D	1000W	1800W	2600W	250A

DIMENSIONS

MODEL	Length	Width	Height
LW1.1100D	390mm	205mm	60mm
LW1.1700D	450mm	205mm	60mm
LW1.2600D	580mm	205mm	60mm

TOOLS/PARTS FOR INSTALLATION

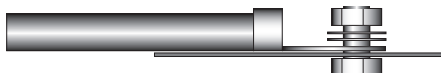

NOTE: TOOLS ARE NOT SUPPLIED

Small flat blade screwdriver phillips screwdriver (#2 or medium sized),
Wire cutters, Wire strippers, - #6 round head screws, and 1 - #8 sheet metal
screw (or nut, bolt flat washer, start washer) (see detail) 2 Ring connectors
(large enough to accommodate your method of grounding) In-line fuse or
Grommets (Sized to work with the power wire you plan to use in your
installation) Tube of silicone seal.

Protection Circuitry

The amplifier protection circuitry will disable the amplifier if the inputs are overloaded, short-circuited or extremely high temperature conditions are detected. When the protection mode is in operation, the LED indicator on the front panel will be illuminated , indicating the amplifier has gone into a self-preservation mode.

If you observe that the protection LED is lit, please check the system carefully to determine what has caused the protection circuit to engage. The amplifier can be reset by turning the remote power off and then on again. If the amplifier shuts down due to a thermal overload condition, please allow it to cool down before powering up. If the amplifier shuts down because of an input overload or short circuit, be sure to repair these conditions before attempting to power up the amplifier again.

Electrical Wiring

All **LIL'WONDER Amplifiers** are equipped with easy top access screw terminals . These terminals are nickel-plated in order to ensure excellent electrical contact and to resist corrosion.

When making electrical connections to the amplifier, please observe the following :

- Use at least 4 gauge or heavier wire for power and ground connections.
- Wire the amplifier directly to the car battery. Make sure there is circuit protection (Such as a fuse) on the positive power lead, within 18 inches of the battery.
- For the ground connection, use the shortest possible wire to a good chassis ground point.
- Wire the Remote connection to the remote turn-on lead of your equalizer or head unit. In some cases this may be the power antenna lead of the head unit.

Remote Subwoofer Level Control

The **LIL'WONDER Amplifiers** are equipped with a dashboard mount remote subwoofer level control. Run the supplied dashboard remote control from the front panel of your amplifier. By turning the level knob clockwise, you will increase the output of low frequencies.

Fuses

Fuses protect both the amplifier and the electrical system of your vehicle from faulty conditions . If you must replace the fuse in your **LIL'WONDER Amplifier**, use a fuse of exactly the same type and rating. A different type or rating may result in damage or cause a fire.

Mounting the Amplifier

Mark the location for the mounting screw holes by positioning the amplifier where you wish to install it and use a scribe (or one of the mounting screws) inserted in each mounting hole to mark the mounting surface. If the mounting surface is carpeted, measure the hole centers and mark with a felt tip pen.

Drill pilot holes in the mounting surface for the mounting screws and insert the mounting screws into these holes. Tighten them securely.

Note: Before beginning your installation, be sure to take note of any wires, lines or other devices in your vehicle which may be located behind any mounting surface.

PANEL LAYOUT

LW1.1100D

LEFT VIEW

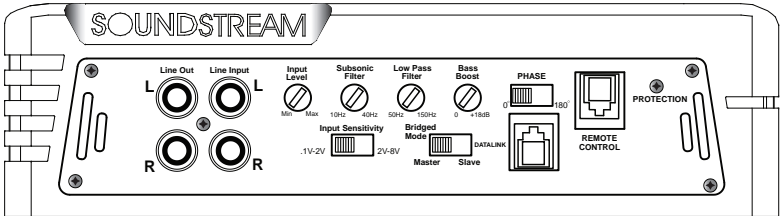

RIGHT VIEW

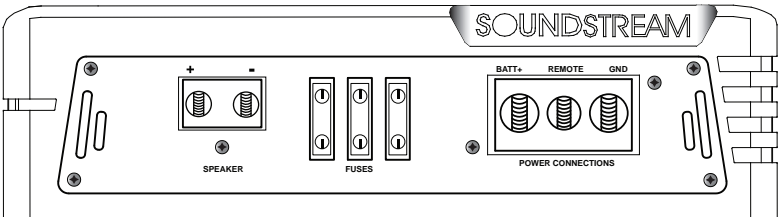

LW1.1700D

LEFT VIEW

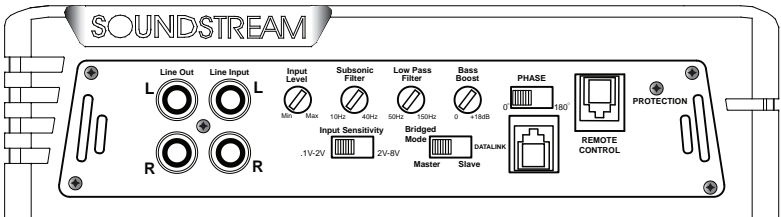

RIGHT VIEW

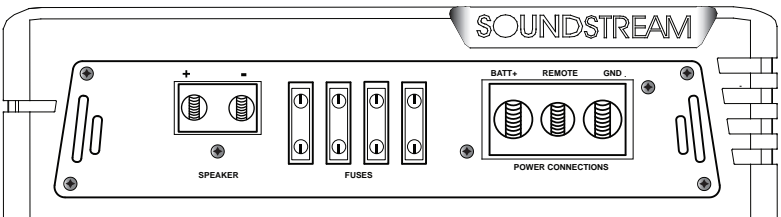

PANEL LAYOUT

LW1.2600D

LEFT VIEW

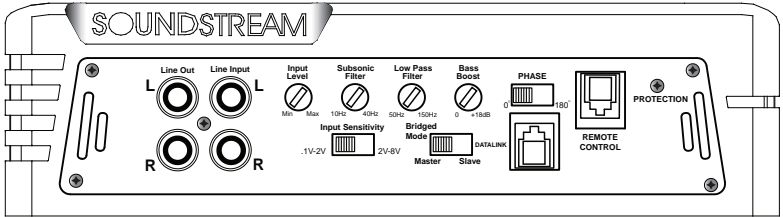

RIGHT VIEW

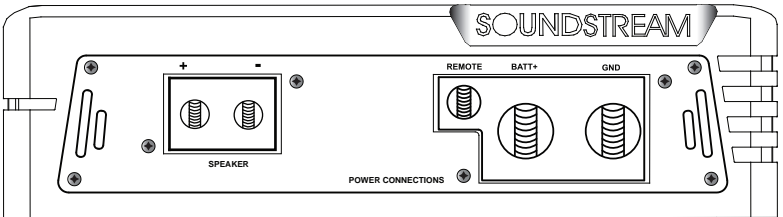

Class D Monoblock Amplifier Installation Wiring

LW1.1100D/LW1.1700D/LW1.2600D

Low Level Inputs

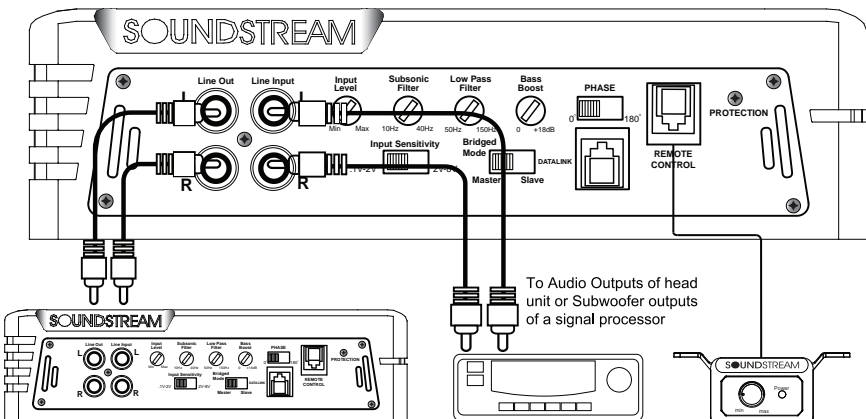

Class D Monoblock Amplifier Installation Wiring

LW1.1100D/LW1.1700D

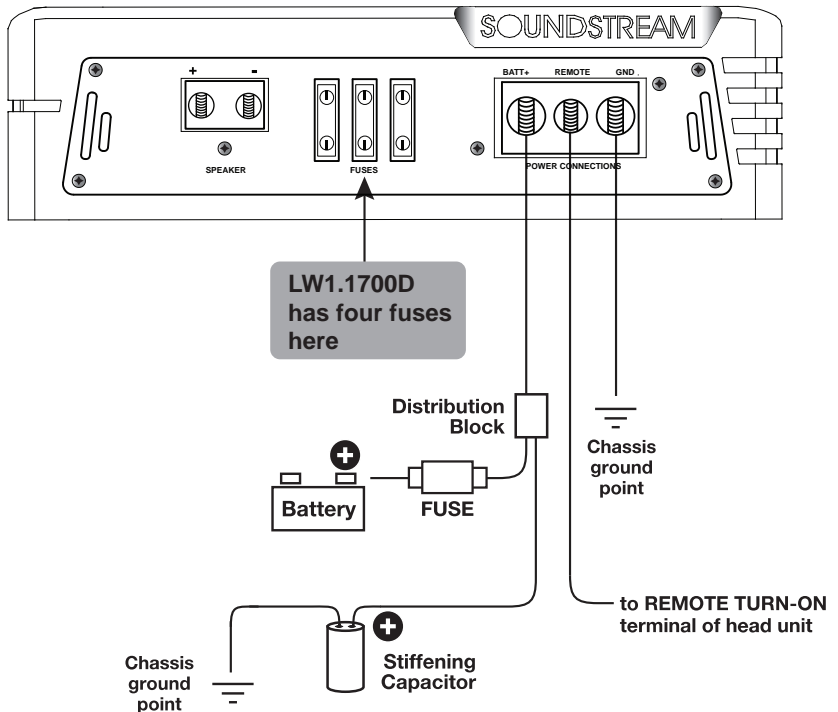
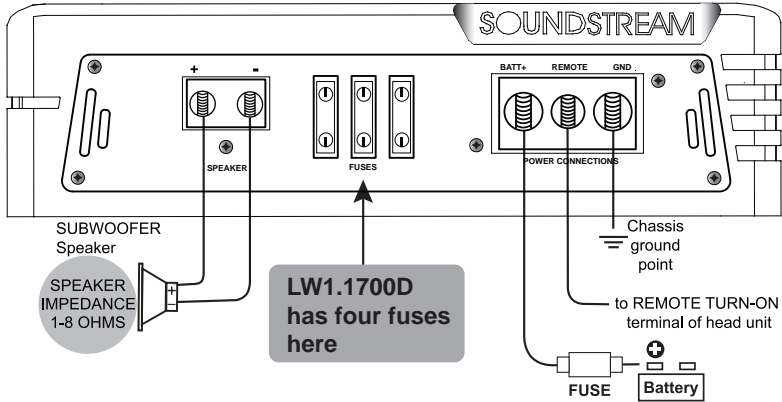

Class D Monoblock Amplifier Installation Wiring

LW1.2600D

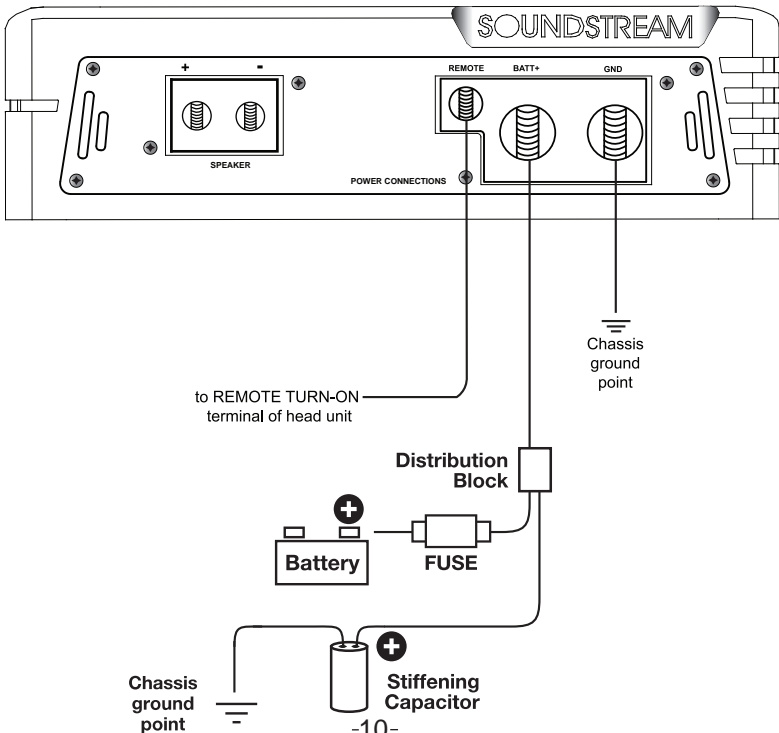
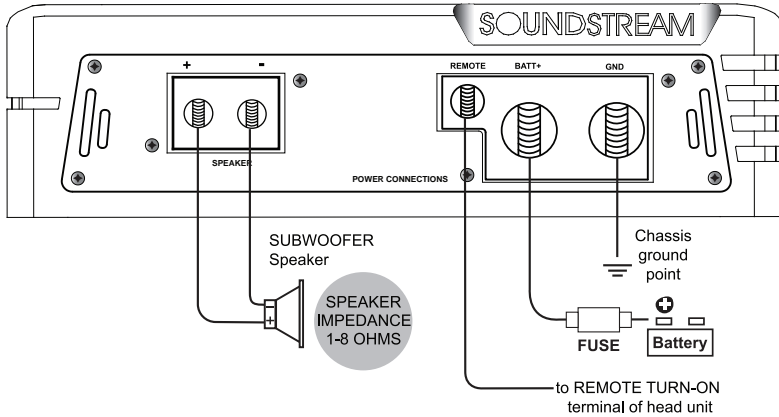

Bridging Two LW1.1100D/LW1.1700D/LW1.2600D Amplifiers

INPUT AND DATALINK CONNECTIONS

(SEE NEXT PAGE FOR POWER AND SPEAKER CONNECTIONS)

MASTER AMPLIFIER Front Panel

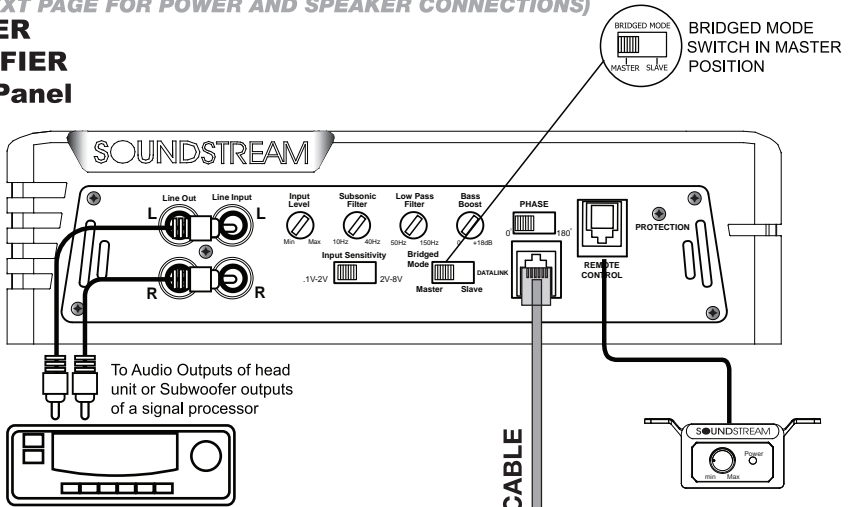

SLAVE AMPLIFIER Front Panel

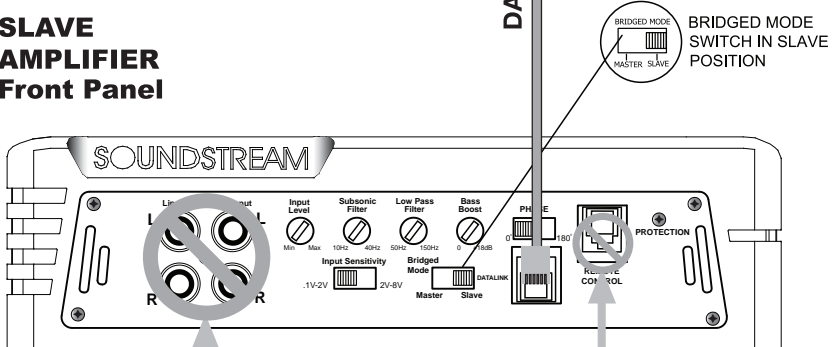

PLEASE NOTE:
In this MASTER AMP/SLAVE AMP configuration, the Slave amp receives its audio signal from the Master Amp. Therefore, DO NOT USE THE INPUTS ON THE SLAVE AMP!

PLEASE NOTE:
In this MASTER AMP/SLAVE AMP configuration, the Slave amp receives its audio signal from the Master Amp. Therefore, DO NOT USE THE SUBWOOFER LEVEL CONTROL ON THE SLAVE AMP!

Bridging Two LW1.1100D/LW1.1700D Amplifiers

POWER AND SPEAKER CONNECTIONS

(SEE PREVIOUS PAGE FOR INPUT AND DATALINK CONNECTIONS)

MASTER AMPLIFIER Rear panel

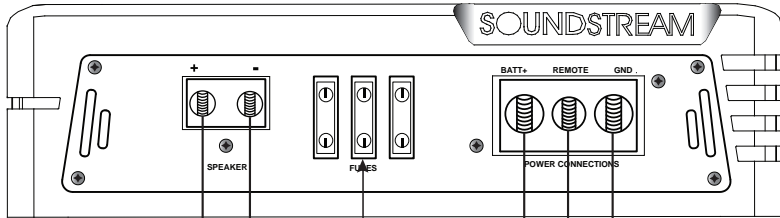

SUBWOOFER speaker

SPEAKER IMPEDANCE
2-8 OHMS

LW1.1700D
has four fuses
here

Chassis
ground
point

SLAVE AMPLIFIER Rear Panel

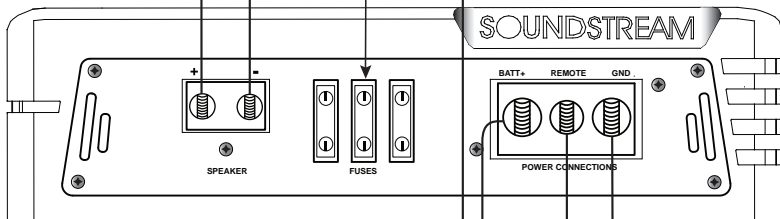

Distribution
Block

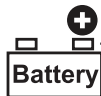

FUSE

Chassis
ground
point



Chassis
ground
point

Stiffening
Capacitor

to REMOTE TURN-ON
terminal of head unit

Bridging Two LW1.2600D Amplifiers

POWER AND SPEAKER CONNECTIONS

(SEE PREVIOUS PAGE FOR INPUT AND DATALINK CONNECTIONS)

MASTER AMPLIFIER Rear panel

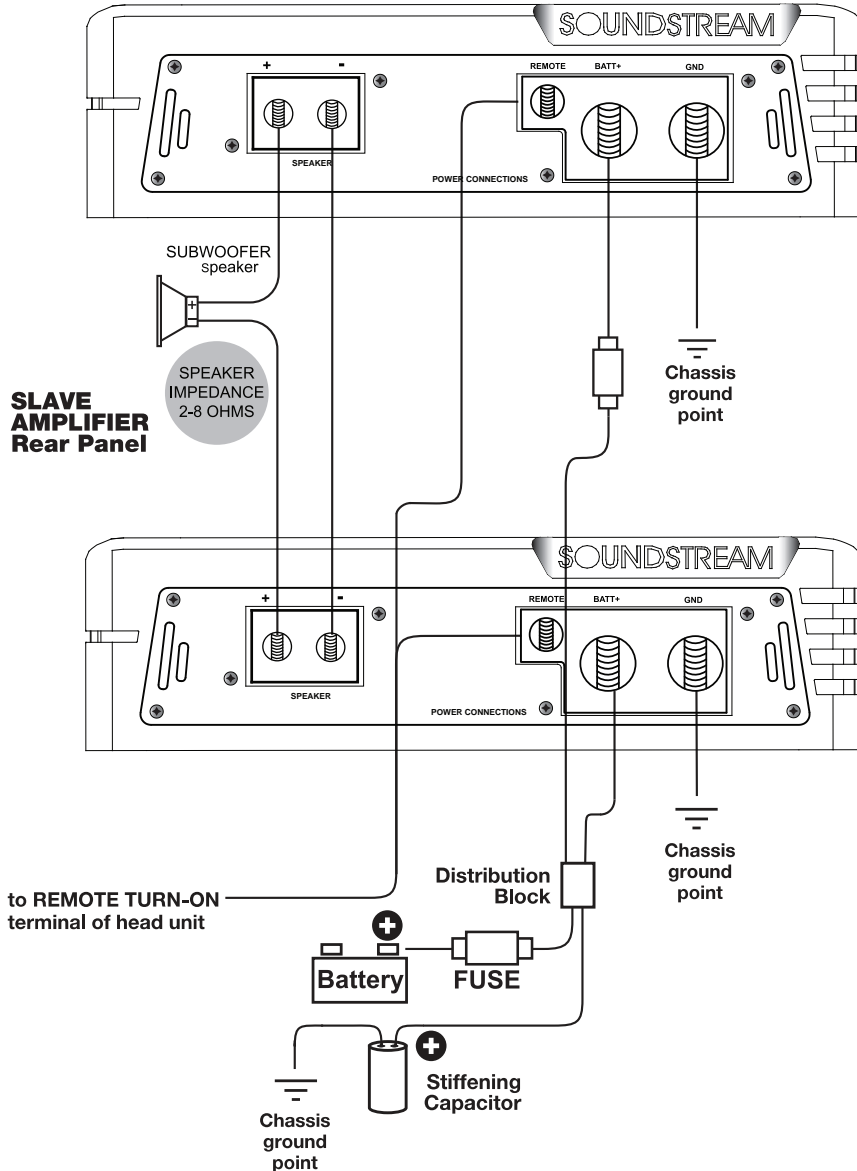

TROUBLE SHOOTING

NO SOUND

Is the LED lit?

YES

NO

Check Power and Remote turn-on wire for voltage. Make sure Ground wire is secure.

STILL NO SOUND

See your Authorize Sound Stream Dealer.

SOUND IN ONE CHANNEL ONLY

Reverse left and right speakers by unplugging the speaker connector, turning it over and plugging it back in.

SOUND IS NOW IN

OPPOSITE CHANNEL

Reverse RCA inputs

SAME CHANNEL

Problem is in the speaker of speaker wire of the silent channel

SOUND IS NOW IN

OPPOSITE CHANNEL

Reverse RCAs at head unit

SAME CHANNEL

Problem is in the Amplifier, See your local Authorized Dealer

SOUND IS NOW IN

OPPOSITE CHANNEL

Problem is in the head unit or before the amplifier

SAME CHANNEL

Problem is in the RCA cables

PROTECTION CIRCUIT

Short Circuit Protection engaged: The amplifier will turn off and try to come back on immediately. The amplifier will cycle like this indefinitely, with “blips” of sound each time. If this is the case, check your speakers and wiring for low impedance and short circuits.

Thermal Protection engaged: The amplifier will turn off and several minutes later will come back on. In this case, ensure that there is nothing blocking the normal convective airflow of the amplifier. No obstruction should be within 2.4” of the amplifier on all sides.

NOTE: Low battery voltage will cause the amplifier to run warmer and possibly damage the amplifier.

Caution:

Please do not plug in or unplug RCA Plugs to the amplifier inputs while the amplifier is turned on. Doing so is potentially harmful to the amplifier by allowing RF(radio frequencies) into the amplifier, causing instability, during the brief period while the RCA shield is not connected, and the hot is connected. Only plug in or unplug RCA plugs with the amplifier off as Standard practice with all audio equipment.

Free Manuals Download Website

<http://myh66.com>

<http://usermanuals.us>

<http://www.somanuals.com>

<http://www.4manuals.cc>

<http://www.manual-lib.com>

<http://www.404manual.com>

<http://www.luxmanual.com>

<http://aubethermostatmanual.com>

Golf course search by state

<http://golfingnear.com>

Email search by domain

<http://emailbydomain.com>

Auto manuals search

<http://auto.somanuals.com>

TV manuals search

<http://tv.somanuals.com>