SOUNDSTREAM[®]

SA•120

SA•244

SA• 245

Power Amplifiers

OWNERS MANUAL AND
INSTALLATION GUIDE

SOUNDSTREAM[®]
T E C H N O L O G I E S

TABLE OF CONTENTS

SA•120 Diagram.....	4 - 5
SA•244 Diagram.....	6 - 7
SA•245 Diagram	8 - 9
Features10
Crossover Modes and Adjustments.....	11 - 12
Selecting Input Modes.....	.13
Wiring & Wiring Diagram.....	14 - 15
Installation and Mounting.....	.16
Level Setting17
Sample Systems	18 - 21
Protection Circuitry & Troubleshooting22
Service23
Specifications.....	.23

CONGRATULATIONS!

You now own a Soundstream Amplifier, the result of a unique design and engineering philosophy.

To maximize the performance of your system, we recommend that you thoroughly acquaint yourself with its capabilities and features. Please retain this manual and your sales and installation receipts for future reference.

Soundstream amplifiers are the result of American craftsmanship and the highest quality control standards, and when properly installed, will provide you with many years of listening pleasure. Please record the following information which will help protect your investment should your amplifier ever need replacement or service..

Serial # _____

Dealer's Name _____

Date of Purchase _____

Installation Shop _____

Installation Date _____

CAUTION!

Prolonged listening at high levels may result in hearing loss. Even though your new Soundstream amplifier sounds better than anything you've ever heard, exercise caution to prevent hearing damage.

SA-120

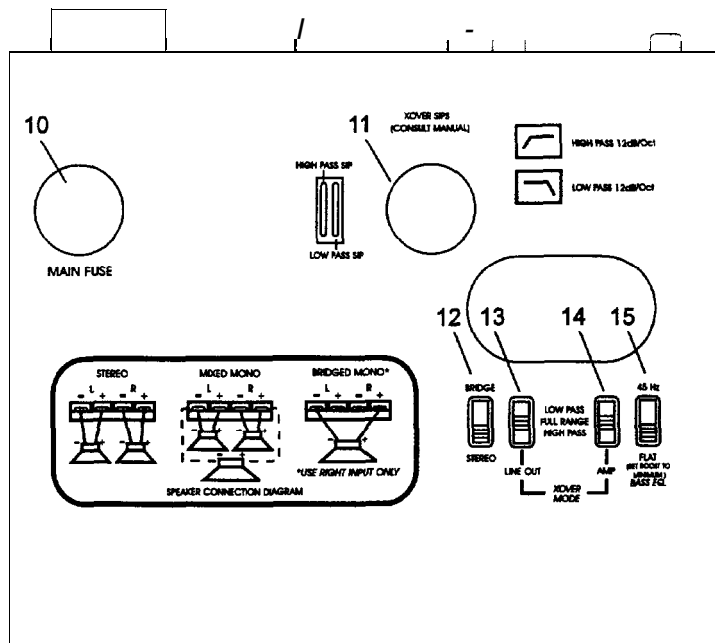
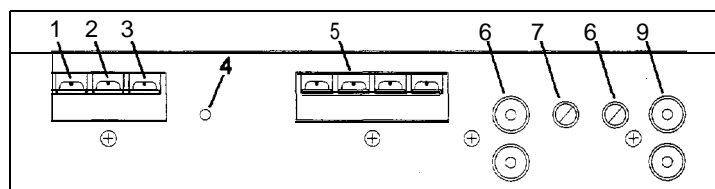
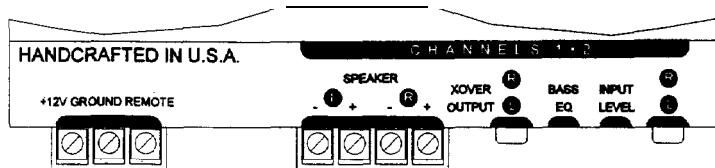

Key to Callouts

- +12V** - Connected to fuse or circuit breaker, then battery's positive post.
- Ground** - Main ground connection. Bolt to a clean **chassis** ground in the vehicle.
- Remote** - Remote turn-on input from the head unit. Accepts **+12V**.
- LED** - Indicates amplifier power on.
- Speaker Output Connections** - Channels 1 & 2
- Crossover Output** - Low level output to auxiliary amplifier for high or low pass.
- Bass EQ** - Adjustable bass equalization circuit, CI to **+9 dB** boost at 45 Hz.
- Input Level** - Variable from **100mV** to **2.5V**.
- Inputs** - Right and left channel inputs; only right channel input used in "Mono" mode.
- [underside] **Main Fuse** - Main power supply fuse. Replace only with same fuse value.
- [underside] **Crossover S.I.P.s** - Crossover frequency settings for amplifier and crossover line outputs.
- [underside] **Stereo/Bridged Mono Switch** - Select "Mono" for bridged operation (use only right channel input) or "Stereo" for **2-channel** Stereo or Mixed Mono operation; See crossover section for more details.
- [underside] **Line Out Crossover Switch** - Select high pass, low pass, or full range operation of crossover outputs.
- [underside] **Amplifier Crossover Switch** - Select high pass, low pass, or full range operation of amplifier.
- [underside] **Bass EQ Switch** - On/Off switch for bass equalization circuit.

SA-244

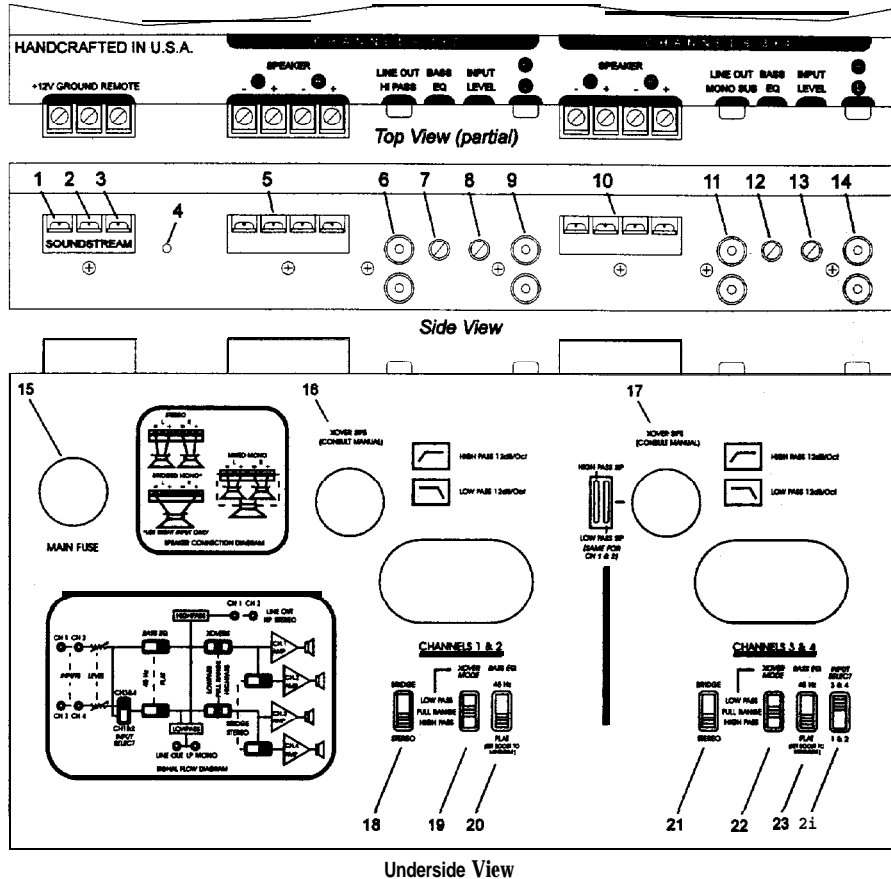

Key to Callouts

- +12V** - Connected to fuse or circuit breaker, then battery's positive post.
- Ground - Main ground connection. Bolt to a clean chassis ground in the vehicle.
- Remote** - Remote turn-on input from the head unit. Accepts **+12V**.
- LED - Indicates amplifier power on.
- Speaker Output Connections - Channels 1 & 2
- High **Pass** Crossover Output - Low level high pass outputs to auxiliary amplifier.
- Bass EQ** - Adjustable bass equalization circuit, 0 to **+9 dB** boost at 45 Hz-Channels 1 & 2.
- Input Level - Variable from 100mV to 2.5V—Channels 1 & 2.
- Inputs - Right and left channel inputs; only right channel input used in "Mono" mode-Channels 1 & 2.
- Speaker Output Connections - Channels 3 & 4
- Low **Pass Crossover Output** - Low level low pass output to auxiliary amplifier.
- Bass EQ - Adjustable bass equalization circuit, 0 to **+9 dB** boost at 45 Hz-Channels 3 & 4 & low pass output.
- Input Level - Variable from 100mV to 2.5V—Channels 3 & 4.
- Inputs - Right and left channel inputs; only right channel input used in "Mono" mode-Channels 3 & 4.
- [underside] **Main Fuse** - Main power supply fuse. Replace only with same fuse value.
- [underside] Xover **S.I.P.s** - Crossover frequency settings for amplifier and outputs-channels 1 & 2 high pass and low pass outputs.
- [underside] Xover **S.I.P.s** - Crossover frequency settings for amplifier and outputs-Channels 3 & 4 & low pass outputs.
- [underside] Stereo/Bridged Mono Switch - Select "Mono" for bridged operation (use only right channel input) or "Stereo" for 2-channel Stereo or Mixed Mono operation; See crossover section for more details-Channels 1 & 2.
- [underside] Amplifier Crossover Switch - Select high pass, low pass, or full range operation-Channels 1 & 2.
- [underside] Bass EQ Switch - On/Off switch for bass equalization circuit-Channels 1 & 2.
- [underside] Stereo/Bridged Mono Switch - Select "Mono" for bridged operation (use only right channel input) or "Stereo" for 2-channel Stereo or Mixed Mono operation; See crossover section for more details.
- [underside] **Amplifier Crossover Switch** - Select high pass, low pass, or full range operation-Channels 3 & 4.
- [underside] **Bass EQ Switch** - On/Off switch for bass equalization circuit-Channels 3 & 4.
- [underside] **Input Select** - Selectable inputs from internal (from channels 1 & 2) or external.

SA-245

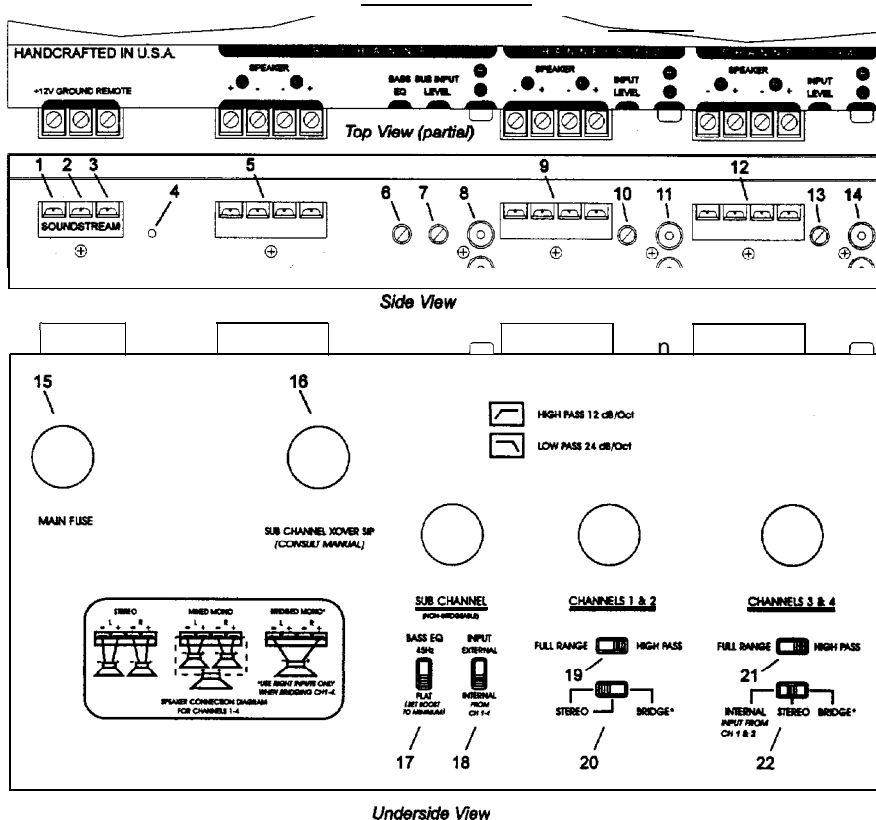

Key to Callouts

1. **+12V** - Connected to fuse or circuit breaker, then battery's positive post.
2. **Ground** - Main ground connection. Bolt to a clean chassis ground in the vehicle.
3. **Remote** - Remote turn-on input from the head unit. Accepts +12V.
4. **LED** - indicates amplifier power on.
5. **Speaker Output Connections** - Sub Channels.
6. **Bass EQ** - Adjustable bass equalization circuit, 0 to +9 dB boost at 45 Hz-Sub Channel only.
7. **Input Level** - Variable from 40mV to 2.5V—**Subwoofer** Channel.
8. **Inputs** - Right and left channel inputs; Subwoofer Channel.
9. **Speaker Output Connections** - Channels 1 & 2
10. **Input Level** - Variable from 100mV to 2.5V—**Channels 1 & 2**.
11. **Inputs** - Right and left channel inputs; only right channel input used in "Mono" mode-Channels 1 & 2.
12. **Speaker Output Connections** - Channels 3 & 4
13. **input Level** - Variable from 100mV to 2.5V—**Channels 3 & 4**.
14. **Inputs** - Right and left channel inputs; only right channel input used in "Mono" mode-Channels 3 & 4.
15. **[underside] Main Fuse** - Main power supply fuse. Replace only with same fuse value.
16. **[underside] Xover S.I.P.** - Crossover frequency setting for subwoofer channel.
17. **[underside] Bass EQ Switch** - On/Off switch for bass equalization circuit-Subwoofer Channel.
18. **[underside] Subwoofer Input Select** - Selects sub channel input from internal (Channels 1-4) or external.
19. **[underside] Amplifier Crossover Switch** - Select high pass or full range operation-Channels 1 & 2.
20. **[underside] Stereo/Bridged Mono Switch** - "Mono" for bridged operation (use only right channel input) or "Stereo" for 2-channel Stereo or Mixed Mono operation; See crossover section for more details-Channels 1 & 2.
21. **[underside] Amplifier Crossover Switch** - Select high pass or full range operation-Channels 3 & 4.
22. **[underside] Input/Stereo/Bridged Mono Select** - Selectable inputs from internal (from channels 1 & 2) or external and stereo or mono-Channels 3 & 4. "Mono" for bridged operation (use only right channel input) or "Stereo" for 2-channel Stereo or Mixed Mono operation.

INSTALLATION STEP 1

SETTING THE CROSSOVER MODES

The Soundstream SA•120, 244, & 245 incorporate a replaceable S.I.P. electronic crossover for each of their pairs of channels (sub channel only on SA•245), as well as the outputs (SA•120 & SA•244). The SA•120, 244, & 245 amplifiers can drive a complete system without need of an outboard electronic crossover.

Before installing the amplifier, make certain the switches on the bottom are set to the correct positions and hole plugs are installed on the bottom of the amplifier.

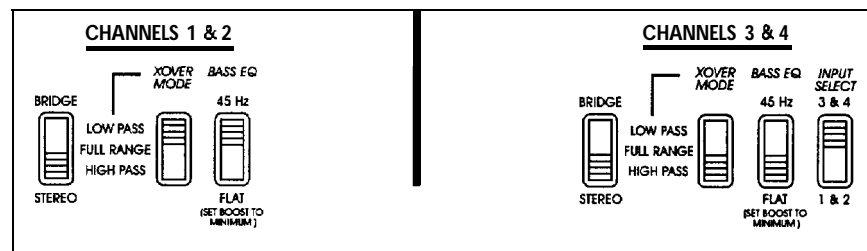

LOW PASS

The low pass crossover is used for sending only low frequency information to particular speakers (or crossover outputs). Activate the low pass crossover if you intend to drive subwoofers.

HIGH PASS

The high pass crossover is used for sending only midrange and high frequency information to particular speakers (or crossover outputs). Activate the high pass crossover if you intend to drive satellite or coaxial speakers in the system along with subwoofers. Even if your system does not include subwoofers, it may be helpful to activate the high pass crossover with smaller speakers to protect them from low frequency information.

NOTES on the SA•244 crossover:

- ◆ High Pass RCA signal output is derived from Channels 1 & 2 inputs. To adjust the crossover frequency, change the Channels 1 & 2 High Pass S.I.P.
- ◆ Low Pass RCA signal output is derived from Channels 1,2,3 & 4 inputs. To adjust the crossover frequency, change both Channels 1 & 2 and Channels 3 & 4 Low Pass S.I.P.'s. Both Low Pass S.I.P.'s must be identical when using the Low Pass RCA outputs!

DESIGN FEATURES

Handcrafted in the U.S.A. with mil-spec glass epoxy circuit boards, low-loss connections, gold plated input connectors, and metal film resistors.

- ◆ **Darlington High Current Discrete Output Topology** - Soundstream's "overbuilding" of the output section incorporates Darlington output devices sandwiched between the circuit board and the heat sink in a design called Chassisink™ to ensure cool, efficient amplifier operation.
- ◆ **Mixed Mono Capable so you can simultaneously drive a stereo and mono load** (satellites and subwoofer).
- ◆ **2 Ohm Drive Ability** - Soundstream SA Series amplifiers are designed to drive loads down to 2 Ohms stereo and 4 Ohms bridged.
- ◆ **Built-in Staggered Asymmetrical Crossover** - Built in 2-way electronic crossover is designed to send either high or low pass information to the amplifier. Outputs are included to drive another amplifier with either high or low pass information (SA•120 & SA•244).
- ◆ **Bass EQ** - Adjustable bass equalization circuit allows you to boost bass by as much as +9dB at 45 Hz. A built in subsonic filter protects speakers.
- ◆ **Drive Delay™ Muted Turn-on/off Circuit** - A unique circuit which completely eliminates any amplifier-related turn-on/off noises.
- ◆ **Flexible Input Sensitivity** - Accepts input voltages from 100 mV to 2.5 V (from 40 mV to 2.5 V on the SA•245 subwoofer channel), which permits maximum output from amplifier with virtually any source unit.
- ◆ **"Balancing Act" Input Topology** for added immunity to ground loops caused by component and vehicle electrical system interaction.

	Power 4 ohms	Power 2 ohms	Bridged Power 4 ohms
SA•120	60w x 2	90w x 2	180w x 1
SA•244	60w x 4	90w x 4	180w x 2
SA•245	35w x 4 + 100w x 1	50w x 4 + 150w x 1	100w x 2 n/a

INSTALLATION STEP 2

CROSSOVER ADJUSTMENTS

In most car audio installations, there is a tendency for a "midbass boom." Because of their interior dimensions, most cars will resonate or ring at these midbass frequencies. If we design the system so there is less musical information in this region, the final response is very smooth and natural sounding.

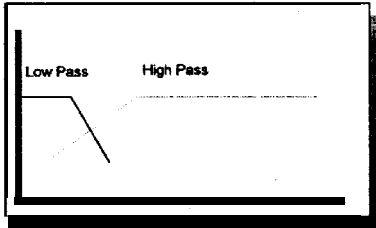

The SA•120, 244, & 245 incorporate a staggered electronic crossover. The high and low pass portions of the crossover can be set independent of one another.

Staggered Asymmetrical Crossover 24 dB/octave low pass, 12 dB/octave high pass (as on SA•245)

Below is a chart of S.I.P. values which can be used for changing the factory preset crossover points (low pass only on SA-245).

FREQUENCY	RESISTOR VALUE	COLOR CODE
53 Hz	30 K Ω	Green-Green
73 Hz	22 K Ω	Green-White
99 Hz	18 K Ω	
107 Hz	15 K Ω	Violet-Green
145 Hz	11 K Ω	Violet-White
195 Hz	2.2 K Ω	
288 Hz	5.6 K Ω	
485 Hz	3.3 K Ω	
800 Hz	2.0 K Ω	

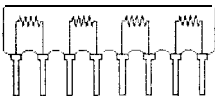

NOTE: The following formula may be used to determine values in creating "custom" resistor packs. The frequency is equal to 1600 divided by the individual resistor value, or $1600000/R \text{ k ohms} = x \text{ Hz}$. To make a custom S.I.P., use 4 identically valued resistors of 296 or tighter tolerance. See the drawing of the S.I. P. for more information.

SELECTING INPUT MODES

Your multi-channel Soundstream amplifier (SA•244 & 245) can be driven with either one or two pairs of stereo inputs (three with the SA•245). If your source unit has front and rear outputs, you can take advantage of its fading capability by driving the multi-channel amplifiers with two pairs of input. In addition, if you have another amplifier, you can drive it with the outputs of the SA•120 or 244. When operating a pair of amplifier channels in mono, only one input is necessary.

On Soundstream amplifiers, pairs of channels may be bridged for mono operation. To do so, simply put the stereo switch into the "mono" position and follow the mono wiring (Right Positive goes to speaker's positive; Left Negative goes to speaker negative).

Stereo for normal operation.

Mixed-Mono in order to drive stereo and mono simultaneously; works well for center channels. It can be used anytime you need a summed mono channel. It also makes for a cost-effective means of driving an entire system with only 2 channels of amplification.

Bridged Mono for dedicated single channel operation; ideal for driving subwoofers. It is also used when large amounts of power are necessary for single speakers. **In bridged mono, only the right channel input (per pair of channels) is active.**

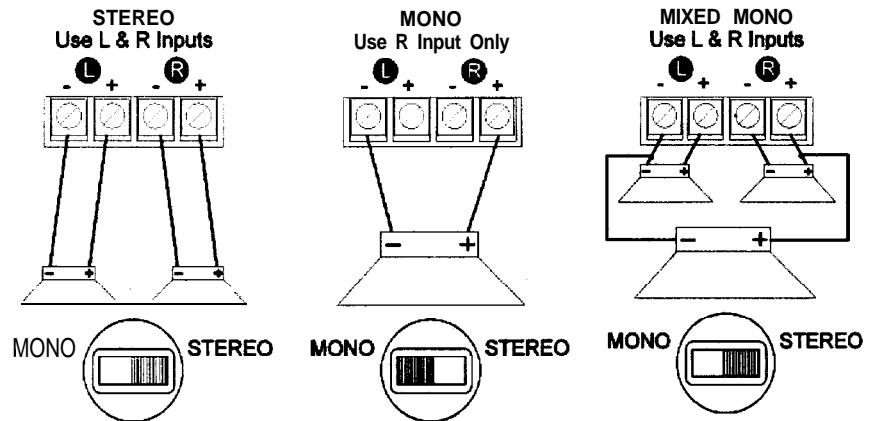

In bridged mono, only the right channel input is active.

For system examples and diagrams, see pages 18 - 21.

INSTALLATION STEP 3

WIRING

POWER AND GROUND

To assure maximum output from your amplifier, use high quality, low-loss power and ground cables. Soundstream SA amplifiers incorporate gold-plated barrier strips for maximum power transfer and protection from corrosion. The screw terminals back out for use with spade & ring terminals, as well as bare wire. Determine from the chart below the minimum gauge power and ground wire for your application.

	up to 10'	up to 20'
SA•120	Soundstream Power80 or Power100 (or 8 or 10 ga.)	Soundstream Power80 (8 ga.)
SA•244	Soundstream Power80 or Power100 (or 8 or 10 ga.)	Soundstream Power80 (8 ga.)
SA•245	Soundstream Power80 or Power100 (or 8 or 10 ga.)	Soundstream Power80 (8 ga.)

CIRCUIT BREAKERS/FUSES

EXTERNAL

Like all other amplifiers, the Soundstream amplifiers must be fused near the battery. A fuse or circuit breaker must be located within 18" of the battery. This will prevent a fire in the event of a shorted cable. See the chart below to determine the value of your battery fuse/circuit breaker.

Model	Amplifier Fuse	Battery Fuse/ Circuit Breaker
SA•120	25 amp automotive	30 amp
SA•244	30 amp automotive	40 amp
SA•245	30 amp automotive	40 amp

(Continued on page 15)

(Continued from page 14)

INTERNAL

The Soundstream amplifiers are fused internally with automotive-type fuses. The fuses are accessible via a plastic plug on the bottom of the amplifier. Never replace the fuses with a higher value than what is supplied. This may result in amplifier damage and will void the warranty!

REMOTE TURN-ON

Connect the 'Remote' to the turn-on lead from the source unit. When +12 volts is received, the amplifier will turn on.

SIGNAL CABLE

Depending on your application and amplifier (SA•120, 244, or 245), you may use one, two, or three pairs of signal cables to drive your amplifier. To guarantee optimum performance, use a high-quality cable that will be easy to install and has minimal signal loss.

SPEAKER CABLE

Use a high quality, flexible, multi-strand cable for best performance and longevity. Soundstream Speaker120 & 160 (12 & 16 gauge) are ideal.

WIRING DIAGRAM

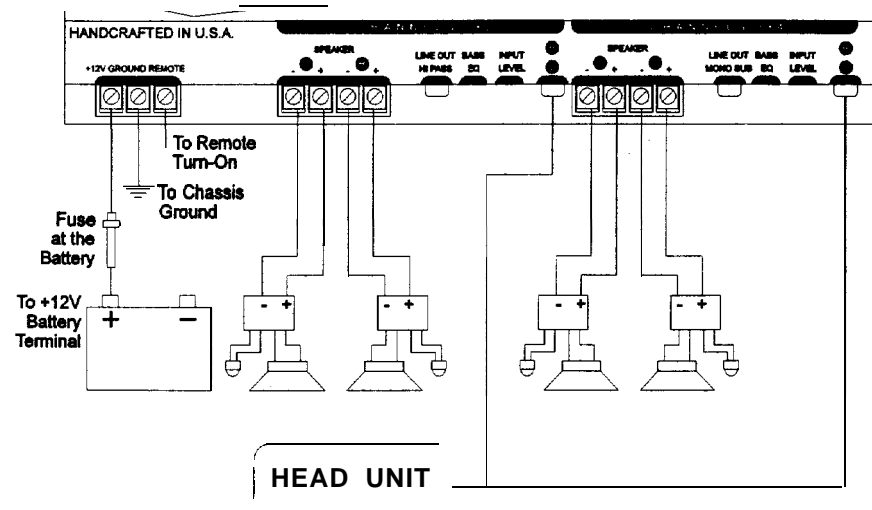

INSTALLATION STEP 4

INSTALLATION AND MOUNTING

1. **AMPLIFIER LOCATION**

The SA amplifiers employ highly efficient circuitry and a unique **Chassisink™** design to maintain lower operating temperatures. Additional cooling may be required if the amplifier is located in a tightly confined area, or when driving especially low impedance loads at extremely high levels.

When mounting the amplifier, it should be securely mounted to either a panel in the vehicle or an amp board or rack that is securely mounted to the vehicle. The mounting location should be either in the passenger compartment or in the trunk of the vehicle, away from moisture, stray or moving objects, and major electrical components. To provide adequate ventilation, mount the amplifier so that there are at least two inches of freely circulating air above and to the sides of it.

2. **SWITCHES**

Set Input and Crossover switches to the appropriate positions (see pages 18 - 21). Be sure to re-install the plugs included with the amplifier.

3. **MOUNTING THE AMPLIFIER**

- a. Using the amplifier as a template, mark the mounting surface.
- b. Remove the amplifier and drill the holes.
- c. Mount the amplifier to the surface using the provided hardware.

4. **WIRING**

- a. Route and connect the audio signal and remote turn-on cables to the amplifier from the source unit.
- b. Carefully run **the positive cable from the amplifier to a fuse or circuit breaker within 18 inches of the battery.**
- c. Then connect the fuse or circuit breaker to the battery. Leave the circuit breaker off or the fuse out until everything is bolted down.
- d. Secure the ground cable to a solid chassis ground on the vehicle. It may be necessary to sand paint down to raw metal for a good connection.
- e. Double check each and every connection!
- f. Re-connect the fuse or circuit breaker.

5. **POWER UP**

Power up the system and look at the LED and it should be lit. There may be a 2 - 3 second delay from the time the source unit is turned on to the time the LED on the amp turns on, which is normal. Once the amplifier power LED is on and the source unit is playing, you should have sound coming from the speakers.

INSTALLATION STEP 6

LEVEL SETTING

The input levels are adjusted by means of the input level controls located on the front of the amplifier.

In the ideal situation, all components in the audio system reach maximum undistorted output at the same time. The reason is because an amplifier will only make what comes into it bigger. So, if you send it a distorted signal from the head unit, it is going to amplify distorted information. The same thing holds true if an outboard processor or crossover begins to distort before you have maximum output from the amplifier. By setting all components to reach clipping at the same time, you can maximize the output of your system.

Follow the below procedure for the quickest, easiest means of setting the levels:

1. Turn the amp's input levels to minimum position (fully counter-clockwise).
2. Set source unit volume to approximately 3/4 of full volume.
3. While playing dynamic source material, slowly increase the amplifier's input level until a near maximum undistorted level is heard in the system.

NOTE: Your best combination of output and Signal to Noise ratio will be **achieved** when the input levels **are** set between **500 mV** and **2.5 V**.

SA•120

SA•120

Bridged mono amp in low pass; high pass outputs to an auxiliary amplifier

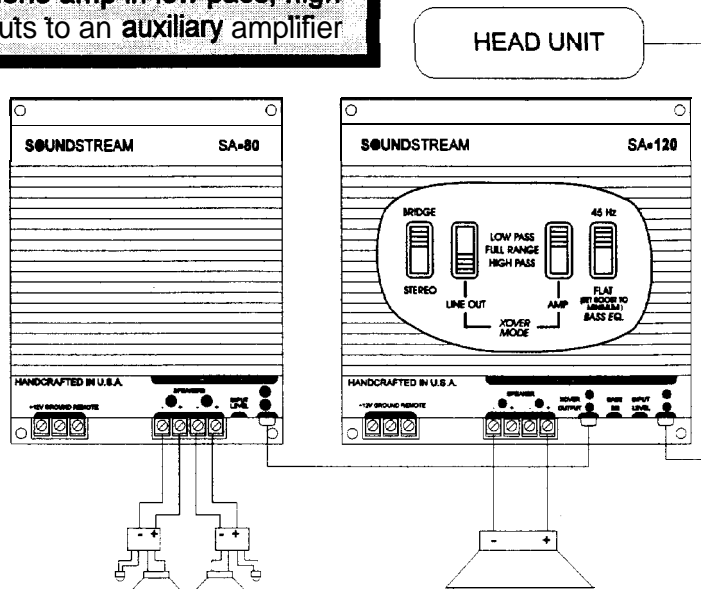

SA•244

SA•244

4 channels of input with 2 channels in high pass, 2 channels in low pass

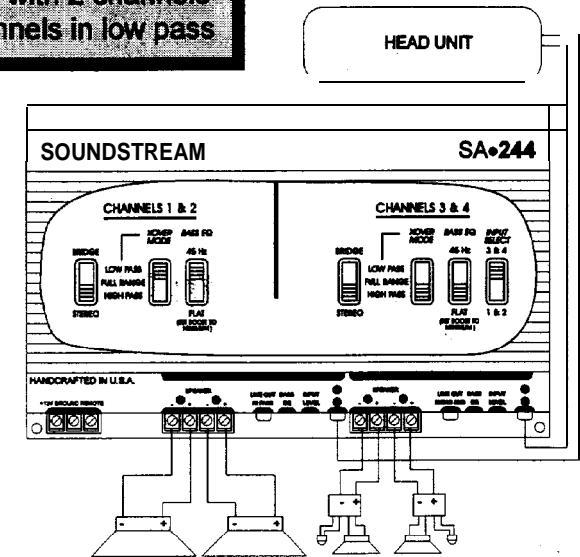

SA•120

Stereo amplifier in high pass; low pass output to an auxiliary amplifier

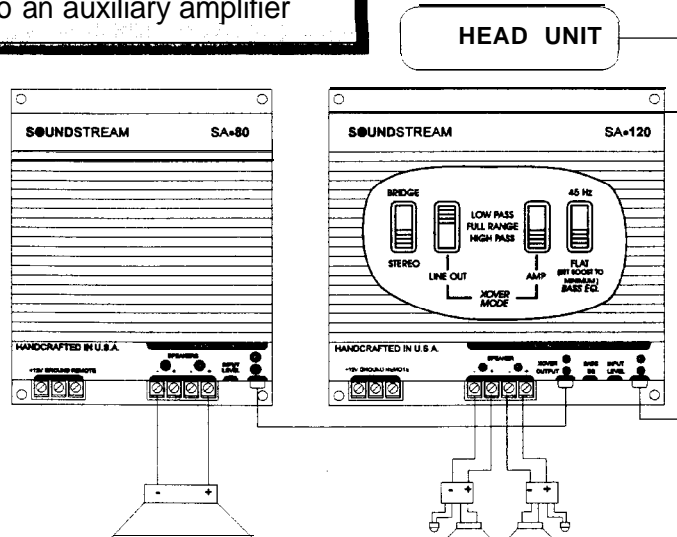

SA•244

2 channels of input with 2 channels in high pass, 2 channels in low pass

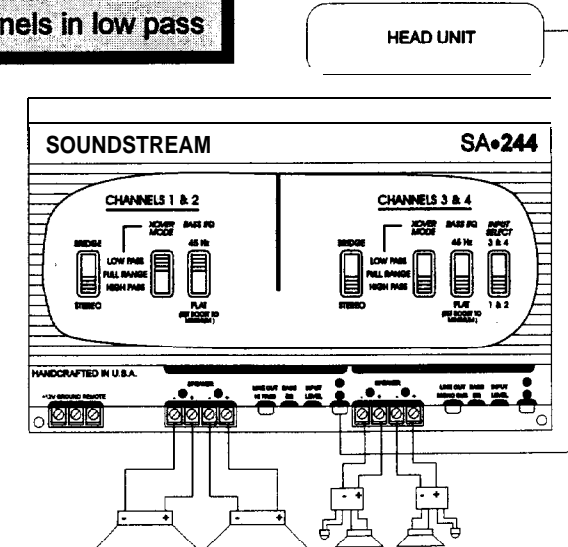

SA•244

SA•244

4 channels of input with 4 channels in high pass; low pass output to an auxiliary amplifier

HEAD UNIT

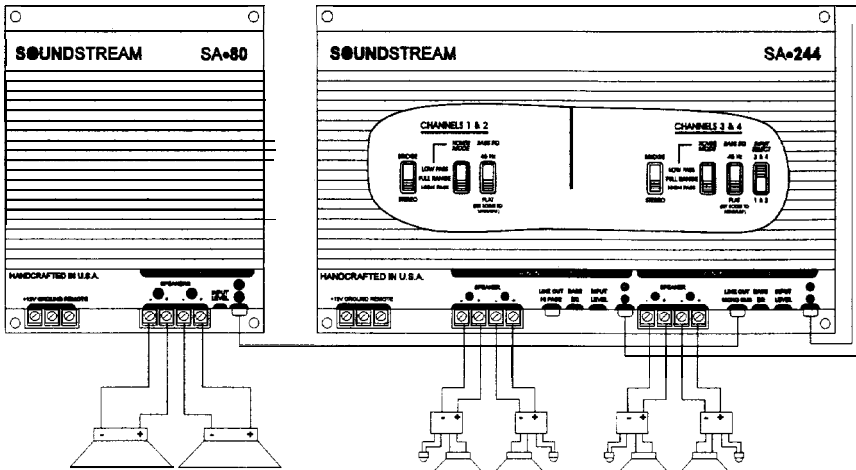

SA•244

2 channels of input; 2 bridged channels in low pass, high pass output to an auxiliary amplifier

HEAD UNIT

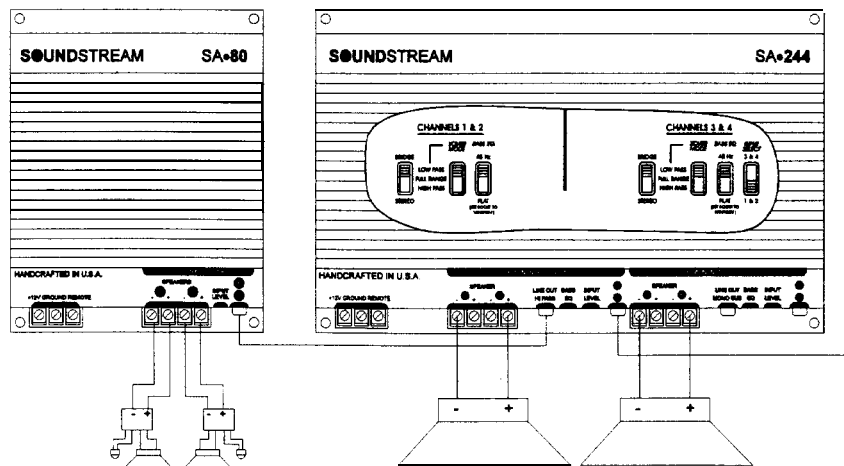

20

SA•245

SA•245

4 channels of input with 4 channels in high pass, mono channel in low pass

HEAD UNIT

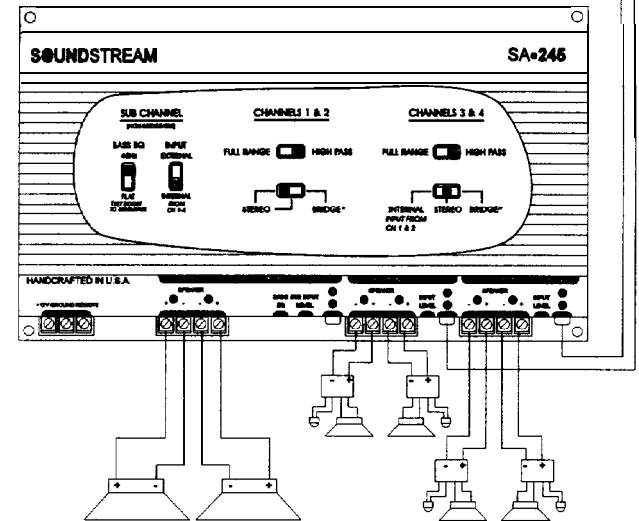

SA•245

2 channels of input with 2 channels in high pass, mono channel in low pass

HEAD UNIT

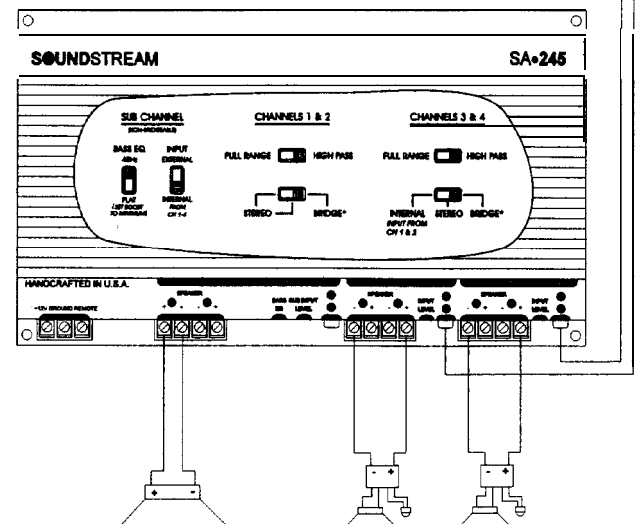

21

PROTECTION CIRCUITRY

Your SA amplifier is protected against both overheating and short circuits by means of the following circuits:

- Main power supply fuses.
- A fail-safe thermal protection circuit activating at 95°C.
- Self-resetting circuit breakers to protect against short circuits.

NOTE: If you experience blown main power supply fuses, DO NOT increase values beyond the original values! Doing so will void your warranty and may damage your amplifier.

TROUBLESHOOTING

PROBLEM	CAUSE
No sound and LED is not lit	<ul style="list-style-type: none"> • no power or ground at amp • no remote turn-on signal • blown fuse near battery
Repeatedly blown amp fuse, frequent activation of Thermal Protection Circuit	<ul style="list-style-type: none"> • check speaker configuration—impedance may be less than 2 ohms stereo or 4 ohms mono • speaker or leads may be shorted • verify adequate amplifier ventilation
No sound from channels 3 & 4 with 2 channels of input	<ul style="list-style-type: none"> • check input settings on bottom of amplifier-switch should be set to inputs "1 & 2"
Channels cut in and out	<ul style="list-style-type: none"> • circuit breakers are activating. Check for a possible short in the speaker wire or in the speaker itself • verify that the impedance of the load is at or above the minimum rated impedance

SERVICE

Your Soundstream amplifier is protected by a limited warranty. Please read the enclosed warranty card.

SPECIFICATIONS

POWER OUTPUT

	4 Ω Stereo	2 Ω Stereo	4 Ω Bridged
SA•120	60w x 2	90w x 2	180w x 1
SA•244	60w x 4	90w x 4	180w x 2
SA•245	35w x 4 + 100w x 1	50w x 4 + 150w x 1	100w x 2 n/a

THD	< 0.1%
Signal to Noise	> 90 dB
Frequency Response	20 Hz to 20 kHz +/- 0.5 dB
Damping	> 200
Input Sensitivity	100 mV - 2.5 V (40 mV - 2.5 V on the SA•245 subwoofer channel)
Input Impedance	12 k ohms
Crossover Output	400 mV out w/ 100 mV input at 1 kHz

CROSSOVER SPECIFICATIONS

High Pass: 12 dB/octave, shipped with 160 Hz S.I.P. (fixed on SA•245)
 Low Pass: 12 dB/octave, shipped with 80 Hz S.I.P. (SA•120 & 244)
 24 dB/octave, shipped with 80 Hz S.I.P. (SA•245)

DIMENSIONS

SA•120: 8-1/2" W x 8-3/16" D x 2-3/16" H
 SA•244: 13-1/4" W x 8-3/16" D x 2-3/16" H
 SA•245: 14-1/4" W x 8-3/16" D x 2-3/16" H

PARALLEL/SERIES WIRING DIAGRAMS

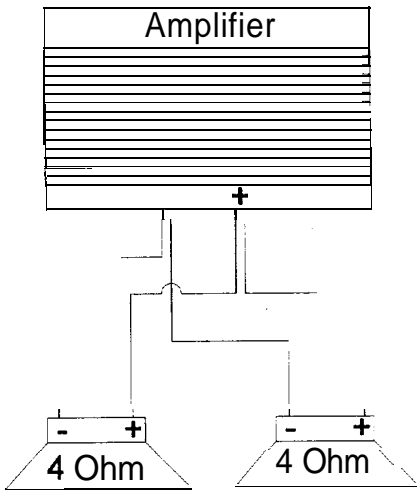

*two 4 ohm woofers
in parallel = **2 ohms***

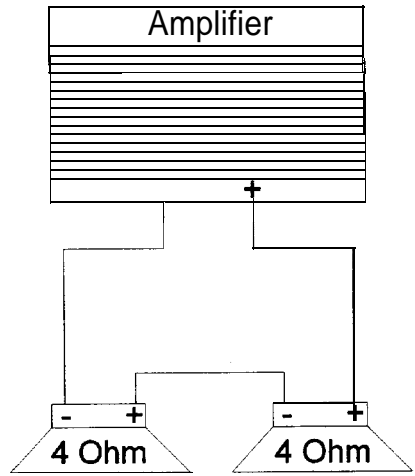

*two 4 ohm woofers
in series = **8 ohms***

SOUNDSTREAM[®]

T E C H N O L O G I E S

SOUNDSTREAM TECHNOLOGIES

120 Blue Ravine Road Folsom California 95630 USA
ph 916.351.1288 fax 916.351.0414 ver. 022495a

Free Manuals Download Website

<http://myh66.com>

<http://usermanuals.us>

<http://www.somanuals.com>

<http://www.4manuals.cc>

<http://www.manual-lib.com>

<http://www.404manual.com>

<http://www.luxmanual.com>

<http://aubethermostatmanual.com>

Golf course search by state

<http://golfingnear.com>

Email search by domain

<http://emailbydomain.com>

Auto manuals search

<http://auto.somanuals.com>

TV manuals search

<http://tv.somanuals.com>