



Instruction Manual
for
Monochrome Video Monitors

VM-901B	VM-1501B
VM-1201B	VM1701B
VM-1201W	VM-2005B
VM-1205B	VM-2001B

Dear Customer,

Thank you for your patronage. Please read the following instructions before using the monitor in order to take full advantage of all of its quality features.

Sincerely,

Speco Technologies

WARNING-To Prevent Fire or Shock Hazard, Do Not Expose This Monitor To Rain or Moisture.

PRECAUTION

CAUTION
RISK OF ELECTRICAL SHOCK
DO NOT OPEN CABINET
NOT USER SERVICEABLE

Graphic Symbol Explanation

The lightning flash with arrowhead symbol, within an equilateral triangle, is intended to alert the user to the presence of uninsulated 'dangerous voltage' within the product's enclosure that may be of sufficient magnitude to constitute a risk of electric shock to users.



The exclamation point within an equilateral triangle is intended to alert the user to the presence of important operating and maintenance (servicing) instructions in the literature accompanying the appliance.



SCOPE

The information in this instruction manual covers the installation and operation of monochrome video monitors. This unit should be installed with approved materials and wiring practices in accordance with the National Electrical Code and applicable local wiring ordinances.

INTRODUCTION

The monochrome video monitor features high resolution both at corner & center, which produces crisp and high-quality video images for any installation purpose. For industrial applications, the monitor accepts a standard EIA or CCIR (upon requirement) monochrome input signal. Loop-through connectors are included with a switchable 75 ohm termination. Operating controls for H-hold, V-hold, brightness, contrast and volume (optional) are located in the front panel for easy access. Furthermore, a regulated power supply maintains excellent performance during fluctuation in line voltage. This monitor is suitable for specialized and industrial CCTV surveillance applications where clear, high quality pictures and proven system reliability are required.

IMPORTANT SAFEGUARDS

All the safety and operating instructions should be read before this appliance is operated.

1. **Retain Instructions:** The safety and operating instructions should be retained for future reference.
2. **Heed Warnings:** All warnings displayed on the monitor and in the operating instructions should be adhered to.
3. **Follow Instructions:** All operating and use instructions should be followed.
4. **Cleaning:** Unplug the monitor from the wall outlet before cleaning. Do not use liquid cleaners or aerosol cleaners. Use a damp cloth for cleaning.
5. **Attachments:** Only use attachments or accessories recommended by the manufacturer as failure to do so may be hazardous.
6. **Water and Moisture:** Do not use this monitor near water - for example, a bathtub, wash bowl, kitchen sink, laundry tub, wet basement, or a swimming pool, etc.
7. **Accessories:** Do not place this monitor on an unstable cart, stand, tripod, bracket, or table. If placed on an unstable accessory, monitor may fall, causing serious injury, and serious damage to the appliance. Use only with a cart, stand, tripod, bracket, or table recommended by the manufacturer, or sold with the monitor. Mounting of the monitor should follow the manufacturer's instructions.
8. **Ventilation:** Slots and openings in the cabinet are provided for ventilation to ensure reliable operation of the monitor and to protect it from overheating. These openings should never be blocked by a bed, sofa, rug, or other similar items. This monitor should never be placed near or over a radiator or heat register. It also should not be placed in a built-in installation such as a bookcase or rack unless proper ventilation is provided or the manufacturer's instructions have been adhered to.
9. **Power Sources:** This monitor should be operated by the power source indicated by the manufacturer's label. If you are not sure which power supply to use, consult your dealer or local power company.
10. **Grounding or Polarization:** This plug will only fit into a grounding-type power outlet. This is a safety feature. If you are unable to insert the plug into the outlet, contact your electrician to replace the obsolete outlet. Do not defeat the safety purpose of the grounding-type plug.
11. **Power Cord Protection:** Power supply cords should be routed so that they are not likely to be walked on or pinched by items placed upon or against them. Pay particular attention to power cords at plugs, convenience receptacles, as well as where they exit from the monitor.

12. **Power Line Surges:** For added protection for this monitor during a lightning storm, or when it is left unattended and unused for long periods of time, unplug it from the wall outlet and disconnect the cable system. This will prevent lightning and power-line surge monitor damage.
13. **Overloading:** Do not overload wall outlets and extension cords. Overloading can result in a risk of fire or electric shock.
14. **Object and Liquid Entry:** Do not insert objects of any kind into this monitor through openings which may result in a fire or electric shock. Avoid spilling liquids on this monitor.
15. **Servicing:** Do not attempt to service this monitor yourself as opening or removing covers may expose you to dangerous voltage or other hazards. Refer all servicing to qualified service personnel.
16. **Damage Requiring Service:** Unplug this monitor from the wall outlet and refer servicing to qualified service personnel under the following conditions.
 - a. When the power-supply cord or plug is damaged.
 - b. If liquid has been spilled, or objects have fallen into the monitor.
 - c. If the monitor has been exposed to rain or water.
 - d. If the monitor does not operate normally by following the operating instructions, adjust only those controls that are covered by the operating instructions as an improper adjustment of other controls may result in damage and will often require extensive work by a qualified technician to restore the monitor to its normal operation.
 - e. If the monitor has been dropped or the cabinet has been damaged.
 - f. When the monitor exhibits a distinct change in performance - this indicates a need for service.
17. **Replacement Parts:** When replacement parts are required, be sure the service technician has used replacement parts specified by the manufacturer or parts that have the same characteristics as the original parts. Unauthorized substitutions may result in fire, electric shock or other hazards.
18. **Safety Check:** Upon completion of any service or repairs to this monitor, ask the service technician to perform safety checks to determine that the monitor is in proper operating condition.

FEATURES

- High resolution
- Steel cabinet with plastic front panel
- Convenient front panel controls
- Carrying handle at top or both sides
- 75Ω or high-impedance termination switch on rear panel
- For application with CCTV type cameras
- Optional audio function (VM-1205B, VM-2005B)

VM-901B

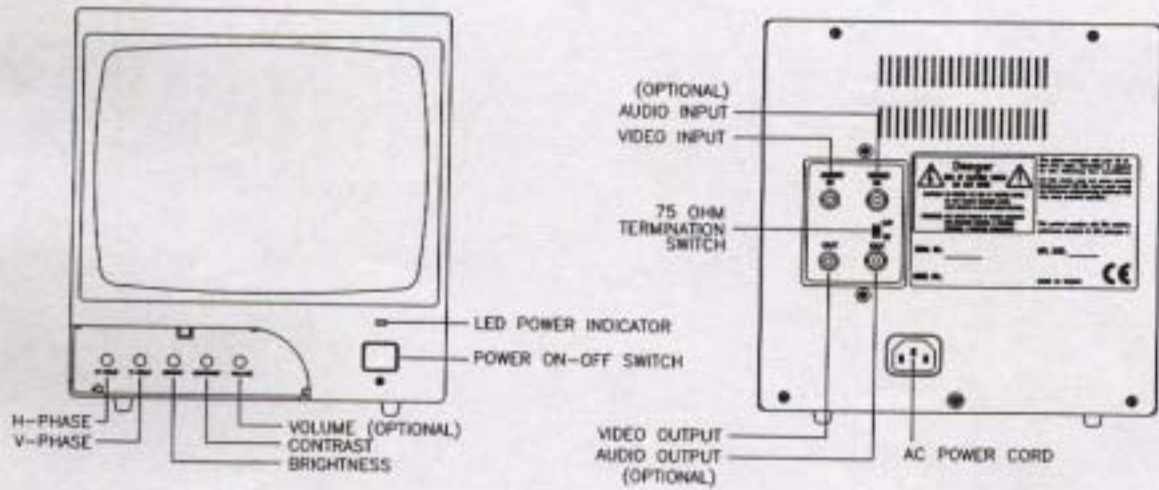

VM-1201B/VM-1201W/VM-1205B

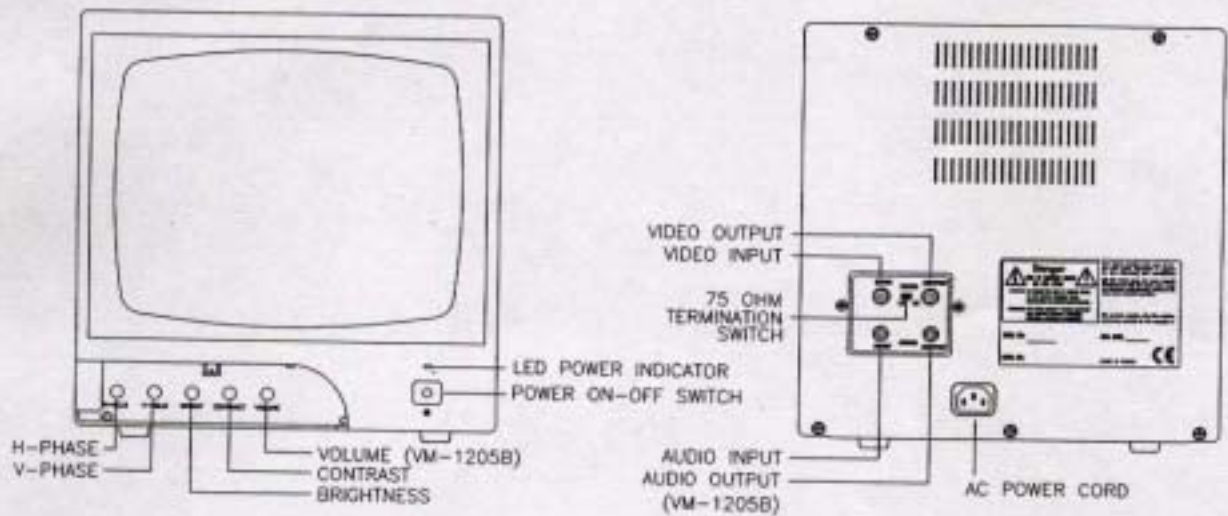

VM-1501B

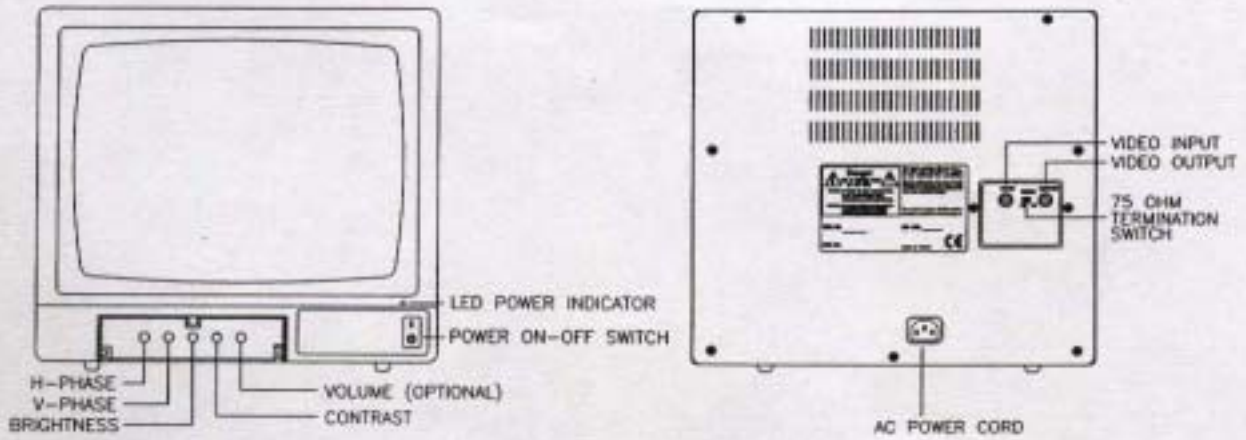

VM-1701B

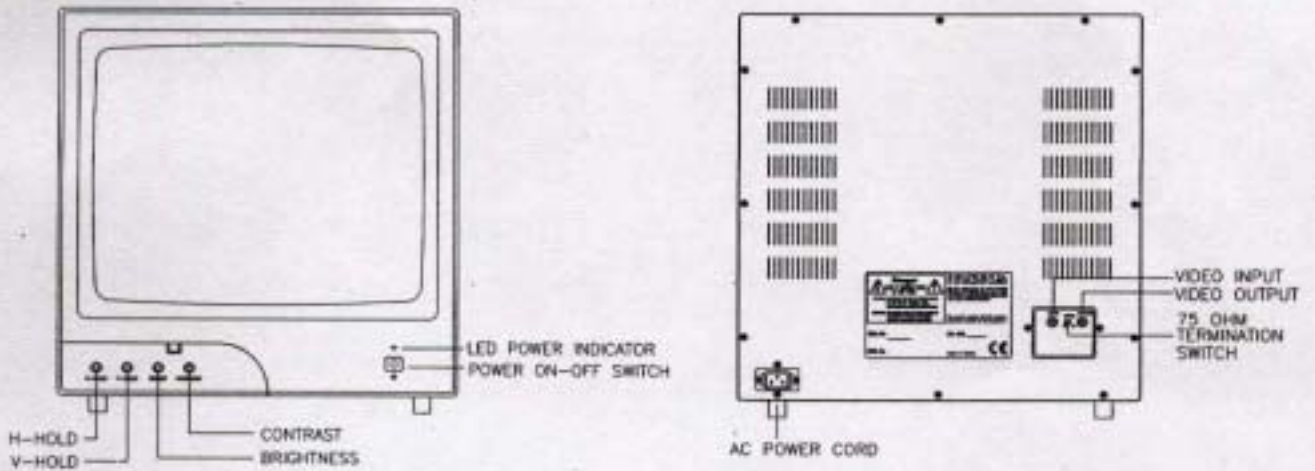

VM-2005B

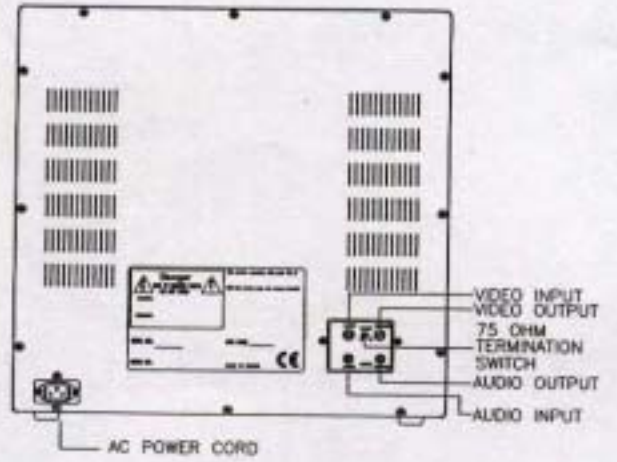
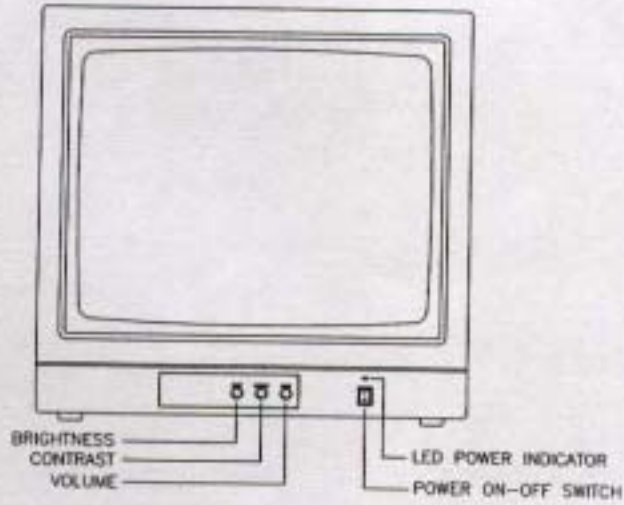

VM-2001B

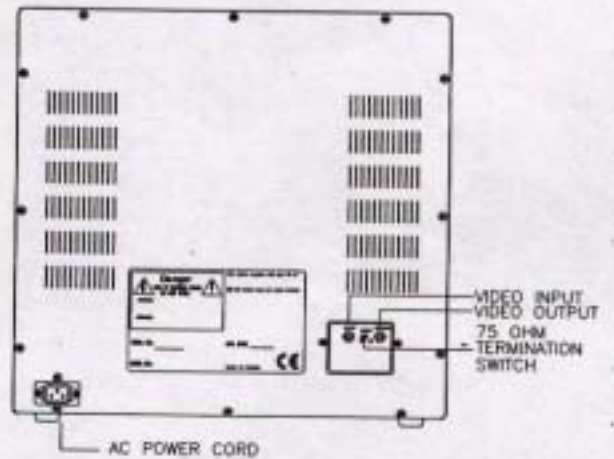
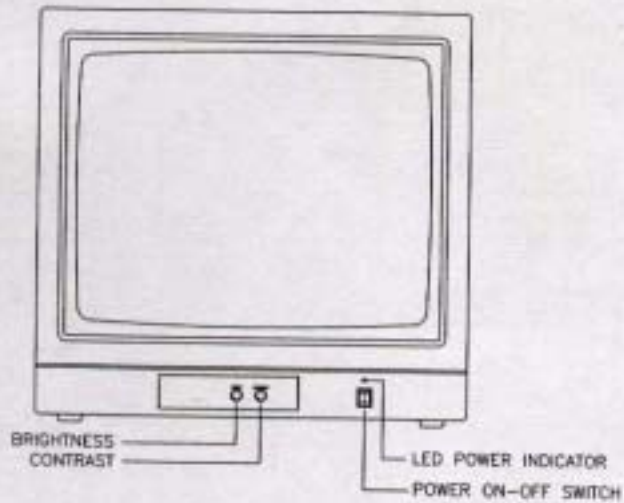

IDENTIFYING MONITOR CONTROLS

POWER ON-OFF SWITCH

This switch provides on-off control.

LED POWER INDICATOR

Illuminates to indicate that power is "ON".

BRIGHTNESS CONTROL

This control permits the adjustment of overall picture brightness and is used to compensate for differences in room lighting.

CONTRAST CONTROL

This control permits the adjustment of contrast between the black and white portions of the picture. When properly adjusted, it is possible to observe a fine distinction between blacks, grays and whites.

VERTICAL PHASE CONTROL

This control permits the adjustment of vertical stability. In the event the picture "rolls" upward or downward as shown in Fig.1, turn the VERTICAL PHASE control clockwise or counterclockwise until the picture stabilizes.

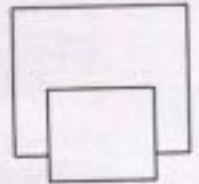

Fig.1

HORIZONTAL PHASE CONTROL

This control permits the adjustment of vertical stability. In the event the picture "tears" right or left as shown in Fig.2, turn the HORIZONTAL PHASE control clockwise or counterclockwise until the picture stabilizes.

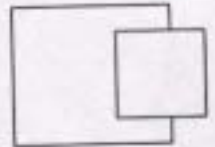

Fig.2

VOLUME CONTROL (VM-1205B, VM-2005B)

This control permits the audio volume control. Turn clockwise to increase the volume and counterclockwise to decrease.

VIDEO INPUT TERMINAL (BNC Connector)

Connect with the output terminal of the related video equipment (i.e. camera).

VIDEO OUTPUT TERMINAL (BNC Connector)

Connect with the input terminal of the related video equipment.

AUDIO INPUT TERMINAL (RCA Connector- VM-1205B/ VM2005B Only)

Connect with the output terminal of the related audio equipment.

AUDIO OUTPUT TERMINAL (RCA Connector- VM-1205B/ VM2005B Only)

Connect with the input terminal of the related audio equipment.

75 OHM TERMINATION SWITCH

This switch provides convenient selection of "HIGH" or "75 OHM" video input impedance. The switch should be set to the "HIGH" position when the loop-through configuration is used and to "75 OHM" when the video signal is to be terminated at the monitor as shown in below installation.

Installation with one monitor

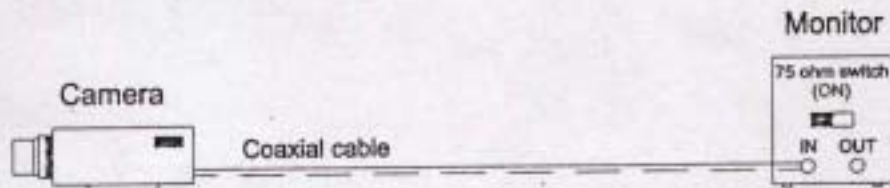

If there is only one monitor in the system, set to the 75 Ohm position.

Installation with two or more monitors

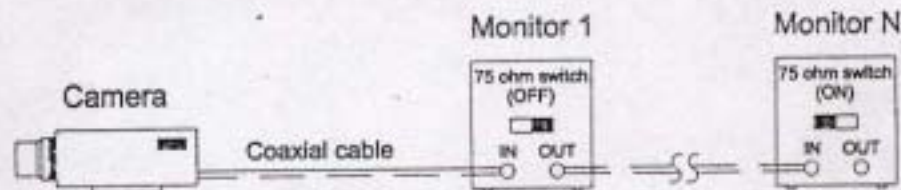

If there are several monitors in the system, set to the 75 Ohm position only at the last monitor (N).

Troubleshooting section

Failure description	Possible cause / Remedy
The power LED is not lighted	<ul style="list-style-type: none"> - the main A/C plug is not connected - the power switch is set to "OFF" - the power LED is defective
No picture with power LED lighted	<ul style="list-style-type: none"> - the coaxial cable from the camera is not connected to the monitor - the camera provides no signal
The picture is too bright / dark	<ul style="list-style-type: none"> - brightness is not adjusted correctly - contrast is not adjusted correctly
The contrast is too low	<ul style="list-style-type: none"> - contrast is not adjusted correctly - check the correct 75 Ohm switch position when using more than one monitor - sunlight interferes with the picture
The contrast is too high	<ul style="list-style-type: none"> - contrast is not adjusted correctly - 75 Ohm switch position of the last monitor is not set properly
Ghost image	<ul style="list-style-type: none"> - 75 Ohm switch position of the last monitor is not set properly
Picture distorted with hum	<ul style="list-style-type: none"> - bad video connections - improper coaxial cable used - different ground potential between camera and monitor (use isolation transformer)
The picture rolls vertically	<ul style="list-style-type: none"> - V-hold is not properly adjusted
Geometric distortion of the picture left or right	<ul style="list-style-type: none"> - H-hold is not properly adjusted

If the above remedies do not solve your problem, please contact your dealer or **Speco Technologies** with an exact failure description.

OPERATION

1. To install the monitor as outlined in the section of installation. Be sure that the termination switch is set to "75 OHM" or "HIGH" position as required, and that a standard 1.0 Vp-p video signal applied to the monitor's VIDEO INPUT.
2. To turn the monitor on, press the "POWER" switch. Observe that the LED power indicator illuminates.
3. To adjust the brightness and contrast controls to obtain optimum picture quality.
4. The monitor should now display a bright, clear picture. Should poor picture quality be observed, check the camera or other video source for proper adjustment.

TECHNICAL SPECIFICATIONS

GENERAL	SPECIFICATION
Screen size	9", 12", 15", 17" or 20"
Power source: Automatic switching power supply (auto sensing)	VM-901B, VM-1201B, VM-1201W, VM-1205B, VM-1501B: 100V~240 Vac, 50-60Hz VM-1701B, VM-2005B, VM-2001B : 100V~240 Vac, 50/60Hz
Input signal	0.5~2.0 Vp-p composite video
Input impedance	75Ω switchable - 75Ω or HIGH
Resolution	1000 lines center, 800 lines corner
Video gain	30dB
Linearity	Horizontal: 15% maximum Vertical: 10% maximum
Scanning system: Compatible with EIA or CCIR system	EIA, 525 lines, 60 field/sec. CCIR, 625 lines, 50 field/sec.
Audio input signal	10~150m Vp-p (VM-1205B, VM-2005B Only)
Audio amplifier	1W/8Ω (VM-1205B, VM-2005B Only)
Speaker	Included (VM-1205B, VM-2005B Only)
Operation temperature	-10~50°C (14~122°F)
Power consumption	19.5W / 20.5W / 18.8W / 18.5W / 28W

Please note: Always use discretion when installing video and/or audio surveillance equipment especially when there is perceived or an anticipation of privacy. Inquire with applicable federal, state and/or local regulations applicable to the lawful installation of video and audio recording or surveillance. Party consent and notification may be required.

For technical assistance please call:



200 New Highway, Amityville, NY 11701
TOLL FREE: 1 800 645 5516
In Metro New York 631 957 8700

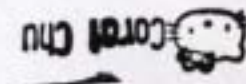



LIMITED WARRANTY

THIS WARRANTY IS VALID ONLY ON PRODUCTS PURCHASED AND USED IN THE UNITED STATES OF AMERICA. THIS WARRANTY APPLIES ONLY TO THE ORIGINAL USER.

SUBJECT TO CONDITIONS AND EXCLUSIONS FOUND BELOW, THIS PRODUCT IS WARRANTED AGAINST MANUFACTURING DEFECTS IN MATERIAL AND WORKMANSHIP FOR THE FOLLOWING PERIOD FOR PARTS AND LABOR:

PRO-VIDEO CAMERAS:	2 YEARS
PRO-VIDEO MONITORS:	1 YEAR
BALANCE OF PRO-VIDEO LINE:	1 YEAR*
*Time lapse VCR Drum Assemblies and Heads:	90-DAYS

WE WILL REPAIR OR REPLACE (AT OUR OPTION) ANY PARTS FOUND TO BE DEFECTIVE FOR THE WARRANTY PERIOD SPECIFIED. WE WILL PROVIDE A REPLACEMENT FOR ANY DEFECTIVE PART.

CONDITIONS

1. THIS WARRANTY WILL BE HONORED ONLY UPON PRESENTATION OF THE ORIGINAL DATED BILL OF SALE OR SALES SLIP.
2. TRANSPORTATION OF THE PRODUCT TO OUR SERVICE STATION IS THE RESPONSIBILITY OF THE USER. REPAIRED OR REPLACED PRODUCT WILL BE RETURNED PREPAID DURING THE WARRANTY PERIOD.

EXCLUSIONS

1. THIS WARRANTY SHALL NOT COVER ADJUSTMENT OF CUSTOMER OPERATED CONTROLS AS EXPLAINED IN THE APPROPRIATE MODEL'S INSTRUCTION MANUAL OR PRODUCTS WHICH HAVE BEEN ALTERED, ABUSED, OR HAVE MISSING OR ALTERED SERIAL NUMBERS.
2. THIS WARRANTY SHALL NOT APPLY TO UNCRATING, SETUP, INSTALLATION, OR THE REMOVAL AND REINSTALLATION OF PRODUCTS AFTER REPAIR.
3. THIS WARRANTY SHALL NOT APPLY TO REPAIRS OR REPLACEMENTS NECESSITATED BY ANY CAUSE BEYOND THE RESULT OF MANUFACTURE INCLUDING, BUT NOT LIMITED TO, ANY MALFUNCTION, DEFECTS OR FAILURE CAUSED BY OR RESULTING FROM UNAUTHORIZED SERVICE OR PARTS, IMPROPER MAINTENANCE, MODIFICATION OR REPAIR BY THE USER, ABUSE, MISUSE, NEGLIGENCE, ACCIDENT, FIRE, FLOOD OR OTHER ACTS OF GOD, INCORRECT LINE VOLTAGE, DAMAGE OR IMAGE BURNS TO TELEVISION PICTURE TUBES CAUSED BY OR ATTRIBUTABLE TO THE USE OF ANY ACCESSORY, ELECTRONICS GAME OR DEVICE, OR DAMAGE CAUSED TO IMAGE PICKUP DEVICES BY EXCESSIVE LIGHT.

THE FOREGOING IS IN LIEU OF ALL OTHER EXPRESSED WARRANTIES AND WE DO NOT AUTHORIZE ANY PARTY TO ASSUME FOR US ANY OTHER OBLIGATION OR LIABILITY. IN NO EVENT SHALL WE BE LIABLE FOR INCIDENTAL OR CONSEQUENTIAL DAMAGES ARISING FROM THE USE OF THIS PRODUCT, OR FOR ANY DELAY IN THE USE OF THIS PRODUCT DUE TO CAUSES BEYOND OUR CONTROL.

SOME STATES DO NOT ALLOW LIMITATIONS OF HOW LONG AN IMPLIED WARRANTY LASTS AND/OR DO NOT ALLOW THE EXCLUSION OR LIMITATION OF CONSEQUENTIAL DAMAGES. THE ABOVE LIMITATIONS ON IMPLIED WARRANTY AND CONSEQUENTIAL DAMAGES MAY NOT APPLY TO YOU.

THIS WARRANTY GIVES YOU SPECIFIC LEGAL RIGHTS. YOU MAY HAVE OTHER RIGHTS WHICH VARY FROM STATE TO STATE.

NOTE: FOR YOUR PROTECTION IN THE EVENT OF THEFT OR LOSS OF THIS PRODUCT, PLEASE FILL IN THE INFORMATION REQUESTED BELOW AND RETAIN WITH YOUR SALES RECEIPT.

MODEL NO.: _____

SERIAL NO.: _____
(LOCATED ON BACK OR BOTTOM SIDE OF UNIT)

DATE OF PURCHASE: _____

WHERE PURCHASED: _____

PURCHASE PRICE: _____

PRO-VIDEO by CSISPECO
200 NEW HIGHWAY
AMITYVILLE, NY 11701

FOR MORE INFORMATION REGARDING
SERVICE OR RETURN, CALL US AT
TOLLFREE: 1-800-645-5516 IN METRO NY: 631-957-8700

ALWAYS USE DISCRETION WHEN INSTALLING VIDEO AND/OR AUDIO SURVEILLANCE EQUIPMENT ESPECIALLY WHEN THERE IS AN EXPECTATION OF PRIVACY. INQUIRE REGARDING FEDERAL, STATE AND/OR LOCAL REGULATIONS APPLICABLE TO THE LAWFUL INSTALLATION OF VIDEO AND/OR AUDIO RECORDING OR SURVEILLANCE EQUIPMENT. PARTY CONSENT MAY BE REQUIRED.

Free Manuals Download Website

<http://myh66.com>

<http://usermanuals.us>

<http://www.somanuals.com>

<http://www.4manuals.cc>

<http://www.manual-lib.com>

<http://www.404manual.com>

<http://www.luxmanual.com>

<http://aubethermostatmanual.com>

Golf course search by state

<http://golfingnear.com>

Email search by domain

<http://emailbydomain.com>

Auto manuals search

<http://auto.somanuals.com>

TV manuals search

<http://tv.somanuals.com>