



DVR-4TL/8TL/16TL

Version 1.1

Caution and Preventive Tips

- Handle with care, do not drop the unit
- Mount the unit in an equipment rack or place it on a solid, stable surface
- Indoor use only. Do not place the unit in a humid, dusty, oily, or smoky site
- Do not place it in an area with poor ventilation or in an area close to fire or other sources of heat. Doing so may damage the unit as well as cause fire or an electric shock
- When cleaning is necessary, shut down the system and unplug the unit from the outlet before uncovering the top cover. Do not use liquid cleaners or aerosol cleaners. Use only a damp cloth for cleaning
- Always shut down the system prior connecting or disconnecting accessories, with the exception of USB devices

CE FC

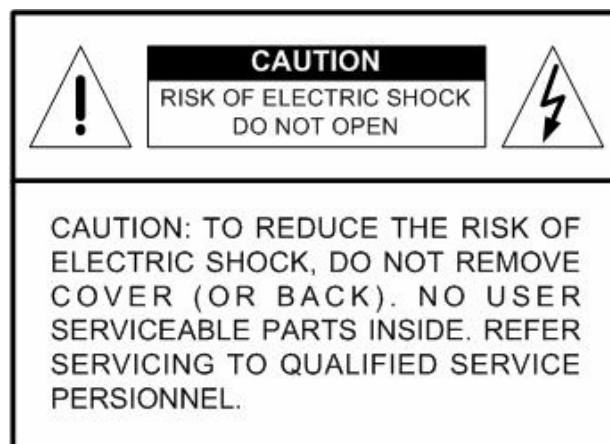

This symbol intends to alert the user to the presence of important operating and maintenance (servicing) instructions in the literature accompanying the appliance.



This symbol intends to alert the user to the presence of unprotected “Dangerous Voltage” within the product’s enclosure that may be strong enough to cause a risk of electric shock.

Important Information

Before proceeding, please read and observe all instructions and warnings in this manual. Retain this manual with the original bill of sale for future reference and, if necessary, warranty service. When unpacking your unit, check for missing or damaged items. If any item is missing, or if damage is evident, **DO NOT INSTALL OR OPERATE THIS PRODUCT**. Contact your dealer for assistance.

Rack Mounting

Consult with the supplier or manufacturer of your equipment rack for the proper hardware and procedure of mounting this product in a safe fashion. Avoid uneven loading or mechanical instability when rack-mounting units. Make sure that units are installed to get enough airflow for safe operation. The maximum temperature for rack-mounted units is 40 °C. Check product label for power supply requirements to assure that no overloading of supply circuits or over current protection occurs. Mains grounding must be reliable and uncompromised by any connections.

Table of Content

1. Overview	10
2. System Setup.....	11
2.1 Position the DVR	11
2.2 Select Video Format	11
2.3 Connect Devices to the DVR	12
2.4 Rear Panel Connections	12
3. General System Setup	14
3.1 Front Panel Introduction	14
3.1.1 LED Definition	14
3.1.2 Function Keys.....	15
3.2 Entering OSD Setup Menu	17
3.2.1 User Management.....	18
3.3 Power Up / Shutdown the DVR.....	19
3.4 System Date / Time Setting	20
3.4.1 Set Date / Time.....	20
3.4.2 Daylight Saving Time.....	21
3.4.3 Network Time Protocol Setup	22
3.5 Record Schedule / Quality Setting.....	23
3.5.1 Schedule Setup	23
3.5.2 Preset Record Configuration	24
3.5.3 Per Camera Configuration.....	24
3.5.4 Record Event Video Only	25
4. Basic Operation.....	26
4.1 View Live / Playback Video.....	26
4.1.1 Viewing Modes	26
4.1.2 Digital Zoom	27
4.1.3 View Live Cameras	27
4.1.4 View Recorded Video	27
4.2 Sequence.....	29
4.2.1 Sequence with Main Monitor	29
4.2.2 Sequence with Call Monitor	29
4.3 Search Recorded Video.....	30
4.3.1 Search by Time	30
4.3.2 Calendar Search	31
4.3.3 Search by Event	32
4.4 Video Export	33
4.4.1 ezBurn Introduction	33
4.4.2 Export Normal Video	34

4.4.3	Export Event Video.....	35
4.5	Dome Control.....	35
4.5.1	Dome Connection.....	35
4.5.2	Dome Protocol Setup	36
4.5.3	RS485 Setup	36
4.5.4	Dome Controlling Keys.....	37
4.5.5	Setting Preset Points.....	38
4.5.6	Calling Preset Points	39
5.	Advanced System Configuration	40
	Username and Password	40
	Key Usage in OSD setup menu	41
	Key Usage in Virtual Keyboard.....	41
5.1	System Setup	42
5.1.1	System/Version Info	42
	5.1.1.1 System and Version Information	43
	5.1.1.2 Software Upgrade via Local Device	43
5.1.2	Language	44
5.1.3	Date / Time	44
	5.1.3.1 Date / Time.....	44
	5.1.3.2 Time Zone.....	45
	5.1.3.3 Date / Time Display.....	45
	5.1.3.4 Date Display Mode.....	45
	5.1.3.5 Time Display Mode	45
	5.1.3.6 Date/Time Order	45
	5.1.3.7 Daylight Saving Time Setup	46
	Daylight Saving Time	46
	DST Start / End.....	46
	DST Bias.....	46
	5.1.3.8 Network Time Protocol Setup Setup	46
	NTP Server	47
	Automatically Time Sync.....	47
	Manually Time Sync.....	47
5.1.4	Unit Name	47
5.1.5	User Management.....	48
	5.1.5.1 Password Protection	48
	5.1.5.2 Account Setup.....	48
	5.1.5.3 Authority Setup	49
	5.1.5.4 Load Default Setting	49
5.1.6	Network Setup.....	49
	5.1.6.1 LAN Select.....	50

5.1.6.2	LAN Setup.....	50
	DHCP	50
	IP	51
	Netmask.....	51
	Gateway.....	51
	DNS	51
	PPPoE Account.....	51
	PPPoE Password.....	52
	PPPoE Max Idle.....	52
	Connect At Booting	52
	Network Restart	52
5.1.6.3	Trigger Port	53
5.1.6.4	Email Address	53
5.1.6.5	SMTP Setup.....	53
	Email via SMTP	53
	SMTP Server	54
	SMTP Port	54
	SMTP Account	54
	SMTP Password	55
5.1.6.6	DDNS Setup	55
	Enable DDNS.....	55
	Host Name.....	56
	DDNS Port.....	56
	Submit/ Update	56
	ezDDNS	57
5.1.7	RS485 Setup	57
	5.1.7.1 Unit ID.....	57
	5.1.7.2 Baud Rate	57
	5.1.7.3 Bits.....	57
	5.1.7.4 Stop.....	58
	5.1.7.5 Parity.....	58
5.1.8	Audio Output/Key Beep	58
	5.1.8.1 Audio Output	58
	5.1.8.2 Key Beep.....	58
5.2	Monitor Setup	59
	5.2.1 Show Camera Title	59
	5.2.2 Screen Center Adjust	59
	5.2.3 VGA Resolution	59
	5.2.4 Show Color Bar	60
5.3	Camera Setup.....	60

5.3.1	Analog Camera Select	60
5.3.2	Dome Protocol.....	60
5.3.3	Dome ID	60
5.3.4	Camera Title	61
5.3.5	Covert.....	61
5.3.6	Brightness	61
5.3.7	Contrast.....	61
5.3.8	Saturation	62
5.3.9	Hue.....	62
5.4	Record Setup.....	62
5.4.1	Record Mode Setting.....	63
5.4.1.1	Record Resolution.....	63
5.4.1.2	Record Format	63
5.4.1.3	Max Rec. PPS.....	63
5.4.2	Schedule Setup	64
5.4.2.1	Day / Night Time Start / End.....	64
5.4.2.2	Weekend Schedule	64
5.4.2.3	Weekend Start / End	64
5.4.3	Preset Record Configuration	65
5.4.4	Per Camera Configuration.....	66
5.4.4.1	Camera Select	66
5.4.4.2	Normal PPS	66
5.4.4.3	Normal Qty	66
5.4.4.4	Event Max PPS.....	66
5.4.4.5	Event Qty	67
5.4.4.6	Event Active	67
5.4.5	ezRecord Setup.....	67
5.4.6	Data Lifetime	68
5.4.7	Circular Recording.....	68
5.4.8	Audio Recording.....	69
5.4.9	Purge Data	69
5.4.7.1	Purge All Data	69
5.4.7.2	Purge All Event Data	69
5.4.7.3	Purge Event Before.....	69
5.4.7.4	Start to Purge	69
5.5	Sequence Setup	70
5.5.1	Main / Call Monitor Dwell.....	70
5.5.2	Main / Call Monitor Schedule.....	70
5.6	Event Setup	71
5.6.1	Internal Buzzer	71

5.6.2	Event Icon	71
5.6.3	Email Notice	71
5.6.4	Email Notice	72
5.6.5	Email Full Screen	72
5.6.6	Event Duration.....	72
5.6.7	Per Channel Config.....	73
	5.6.7.1 Channel Select.....	73
	5.6.7.2 Video Loss Detect.....	73
	5.6.7.3 Motion Detect.....	73
	5.6.7.4 Motion Detect Indicator	73
	5.6.7.5 Detection Config	74
	Sensitivity.....	74
	Block Threshold	74
	5.6.7.6 Alarm In.....	75
	5.6.7.7 Alarm Out.....	75
5.7	Database Setup	75
	5.7.1 Total / Free Size of HDD.....	75
	5.7.2 Available Recording Time.....	75
	5.7.3 Internal Disks.....	76
5.8	Configuration	76
	5.8.1 Load Factory Default.....	77
	5.8.2 Import Configuration.....	77
	5.8.3 Export Configuration.....	78
	5.8.3.1 Copy Destination.....	78
	5.8.3.2 Configuration Name	78
	5.8.3.3 Begin Export	78
5.9	Video Export	79
	5.9.1 Select Device	79
	5.9.2 Select Channel.....	80
	5.9.3 From / To Time	80
	5.9.4 Select Events	80
	5.9.5 Data Type	81
	5.9.6 Export Format.....	81
	5.9.7 Digital Signature	81
	5.9.8 Erase Disc.....	82
	5.9.9 Begin Export.....	82
5.10	Shutdown.....	82
	5.10.1 Power Off	82
	5.10.2 Reboot.....	82
6.	Remote Monitoring Software.....	83

6.1	System Requirements.....	83
6.2	Installation of Software.....	84
6.2.1	Change Internet Settings.....	84
6.2.2	Install SpecoRemote	86
6.2.2.1	Login / Logout	87
6.2.2.2	Software Upgrades	88
6.3	Basic Operation	88
6.3.1	View Live Video	88
6.3.1.1	Select Display Mode	89
6.3.1.2	Operating Cameras with Dome Control	89
6.3.2	Instant Recording	90
6.3.2.1	Record Video Instantly	90
6.3.2.2	Playback Instant Recorded Video	90
6.3.3	Playback Video.....	91
6.3.3.1	Playback Remote Video.....	91
6.3.3.2	Playback Local *.drv Files.....	92
6.3.3.3	Playback Controls	92
6.3.4	Verify Digital Signature	93
6.3.5	Search from Event List	93
6.3.6	Take a Snapshot.....	94
6.3.7	Health Status	94
6.3.8	Remote Monitoring Software Trouble Shooting Guide	95
Appendix A: Recommended HDDs		96
Appendix B: Remote Controller		97
Appendix C: Setting up a DVR behind a Router.....		99

1. Overview

DVR-4TL/8TL/16TL is an integrated digital video recorder that combines the features of a time-lapse audio / video recorder, a multiplexer, and a video server to create a single security solution.

Its outstanding variable operation enables users to view live video, search and playback any recorded video by date/time or event, and remotely monitor the unit via internet on PC, MEANWHILE the recording of the DVR unit is ongoing simultaneously.

DVR-4TL/8TL/16TL is enhanced to provide H.264 compression mode. Moreover, a marvelous implementation is the brand-new experience of Graphical User Interface (GUI) that optimizes the monitoring controls of the unit.

DVR-4TL/8TL/16TL is pre-installed with remote viewing and configuration software **SpecoRemote**, which is a Web-browser plug-in allowing users to view live or recorded video images, and enables remote configuration. **SpecoRemote** is stored in **DVR-4TL/8TL/16TL** and deployed over a LAN, WAN or Internet connection to remote Windows-based computers. This simplifies the installation and maintenance of the software components so all remote users are using the same software coming from the unit.

2. System Setup

The notices and introduction on system installation will be described particularly in this chapter. Please follow the description to operate the unit.

In order to prevent the unit from data loss and system damage that caused by a sudden power fluctuation, use of an Uninterruptible Power Supply (UPS) is highly recommended

2.1 Position the DVR

First, note to position / mount the DVR in a proper place and be sure to power off the unit before making any connections. The placed location should avoid hindering or blocking the unit from airflow. Enough airflow is needed to protect the unit from overheating. The maximum allowable temperature of operating environment is 40°C.

The unit utilizes heat-conducting techniques to transfer internal heat to the case, especially to the bottom side of the unit.



NOTE: Be sure the rubber feet are not removed, and always leave a space for air ventilation on the unit's bottom side.

2.2 Select Video Format

The DVR is designed to operate under either NTSC or PAL video formats. The switch is on the rear panel.



2.3 Connect Devices to the DVR

This section lists some important notices that should be read before making any connection to the DVR.

Connecting Required Devices

Before power up the unit, cameras and a monitor should be connected to the unit for basic operation. If needed, connect a call monitor for displaying full screen video of all installed cameras in sequence.

Connecting Short-term Device

If any short-term devices shall be installed to the DVR as parts of the unit system, such as USB ThumbDrive® or any USB devices, etc, make sure those devices are connected only after the unit is powered up. The reason is because the DVR can recognize the external devices only after the power-up process is done completely.

2.4 Rear Panel Connections

There are various connectors on the rear panel for the DVR installations. The following shows the detailed description of each connector.

Main Monitor (BNC/ VGA)

BNC and VGA output connectors are offered for connecting to a main monitor. The main monitor displays live image and playback recorded video in either full-screen or split-window format.

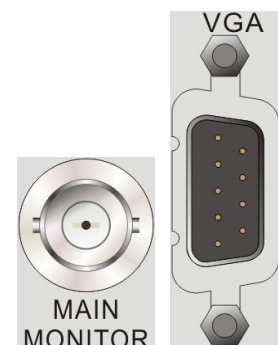

Call Monitor

The call monitor is used to display full screen video of all installed cameras in sequence. The BNC call monitor connector allows users to connect the DVR with an optional call monitor.



Video In

A group of BNC connectors is offered for video input streams from installed cameras. The number of connectors is equal to the number of channels.

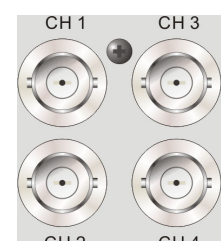

Alarm I/O & RS485

A D-Sub connector is provided to offer users the flexibility to connect the DVR to Alarm I/O and RS-485 devices. Refer to **Setup Guide** for detailed pin definitions.



LAN Connector (RJ-45)

The DVR is capable of networking. Once the unit is connected to the LAN network, users can remotely access the unit through **SpecoRemote** on a PC.

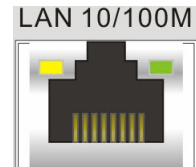

USB Connector (x1)

There is one USB port provided to allow users to connect a PS/2 mouse via a USB converter.



Power Jack

The DVR has a free voltage DC power connection jack. Please connect the power adapter shipped with the unit.

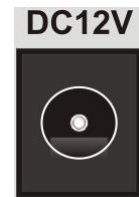

Audio In

Audio In connectors are offered for connecting audio source devices to the unit. **DVR-4TL** offer RCA connectors while **DVR-8TL** and **DVR-16TL** offer a D-Sub connector.



Audio Out – Main & Call

Main & Call Audio Out RCA connectors are provided for connecting the DVR to audio output devices (e.g. amplified speakers). “Main” will output audio from the main monitor, whereas “Call” will output audio from the call monitor.

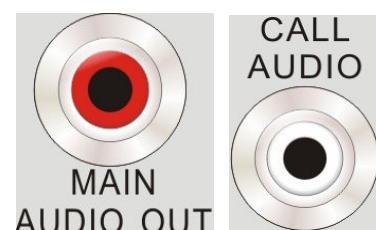

3. General System Setup

Before operating the DVR, some general configuration should be setup first. The following subsections will introduce function keys on the front panel and general configuration of the DVR.

The regular displayed OSD information and its displayed positions are shown as following figure. Title of the channel will be displayed on the top-left corner of the window, either in full screen mode or in multiple channel mode. The current operating mode, including Call mode, Dome Control mode, Playback mode, Freeze mode and Sequence mode, will be displayed on the bottom-left corner of the screen. The date/ time information will be display on the bottom-right corner of the screen. On the upper-right corner will show the authority level of login account. Under logout condition, the icon will show "N".



3.1 Front Panel Introduction

The front panel controls enable users to control the unit and preset the programmable functions.

3.1.1 LED Definition

The LEDs on the front panel of the DVR are described as follow.



Power LED

The LED lights up when the correct power is connected to the unit.



Alarm LED

The LED lights up when an alarm is triggered.



Network LED

The LED lights up when the DVR is connected to a network and blinks when the data is being transferred.



REC LED

The LED blinks while the DVR is recording.

3.1.2 Function Keys

This section describes the functional keys on the front panel of the DVR. Refer to the **Setup Guide** for the graphical illustration of functional keys.

CHANNEL

- In both Live and Playback modes, press the CHANNEL key to view the corresponding video in full screen. The number of the CHANNEL keys corresponds to the number of cameras supported by the unit.
- In Dome Control mode, the key "1" is used to access the Set/Go preset menu; the key "2" is used to hide or display the hint screen.
- In OSD virtual keyboard, press keys 1~9 to input number 1~9, and press key 10 to input number 0.

COPY

In Playback mode, press COPY to select the start and end time of the export video. Refer to section **Video Export** for detailed information.

CALL

- In Live mode, press this button to enter call monitor control mode.
- In Dome Control mode, press CALL in association with ENTER to enter the OSD setup menu of the dome camera.
- In OSD virtual keyboard, press this key to input a period mark ".".

Direction Keys

- In Zoom mode, these keys function as Direction keys.
- In the OSD setup menu, the LEFT/ RIGHT keys are used to move the cursor to previous or next fields. To change the value in the selected field, press UP/ DOWN.

ENTER / ZOOM

- In OSD setup menu or selection interface, press this key to make the selection or save settings.
- In live full screen view mode, press this key to view a 2x zoom image; press it again to exit Zoom mode.

HOME

- Press the key to enter dome control mode. Please refer to section **Dome Control** for detailed controlling operation.
- In OSD virtual keyboard, press this key to go backspace.

ESC

- Press to cancel or exit from certain mode or OSD setup menu without changing the settings made previously.
- If password protection has been enabled, press ESC for five seconds to lock up functions of certain keys, including **PLAY**, **MENU**, **SEARCH**, **DOME** and **CALL**. Once users lock up the functions of these keys, enter proper username and password to unlock.



NOTE: Please go to the <System Setup> → <User Management> menu to enable or disable the password protection.

MODE

Press repeatedly to select for wanted monitor display format. The available view modes includes: full-screen, 4-window (2×2), 9-window (3×3) and 16-window (4×4). Refer to section **Viewing Modes** for detailed information.

PLAY/STOP

Press this key to switch between live image and playback video.



NOTE: According to record setting, part of the latest video cannot be played back because the video is still saved in the buffer.

FREEZE

- Press FREEZE while viewing live image, the live video will be frozen. The date / time information shown on the monitor will continue updating. Press FREEZE again to return to live mode.
- Press FREEZE while playing the recorded video, the playback video will be paused. Press LEFT / RIGHT to move the recorded video reverse / forward by single step. Press FREEZE again to continue playing video.

SEQ (Sequence)

Press to start automatic sequence display of video from all installed cameras.

SEARCH

In both Playback and Live mode, press SEARCH to enter the Search menu for searching and playing back recorded video by date and time or events.

MENU

Press this key to enter the OSD setup menu.

3.2 Entering OSD Setup Menu

The configuration of the DVR can be customized by entering the intuitive Graphical User Interface (GUI) OSD setup menu. Collaborating with a USB mouse, setting up the DVR can be easy as operating on a PC. Press MENU and input a valid username. There are two preset accounts: "admin" and "user". "admin" can be inputted via pressing the hot key MENU, while "user" can be inputted via pressing the hot key SEARCH. Move to <OK> and press ENTER to proceed.

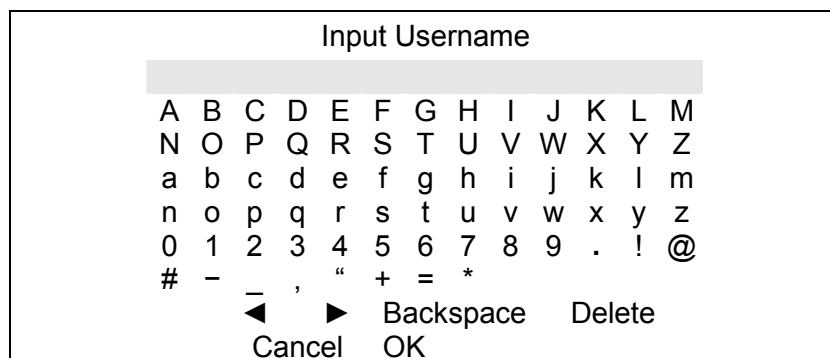

The next step is to enter a corresponding password. The preset password for "admin" is "1234", and the password "4321" is for "user".

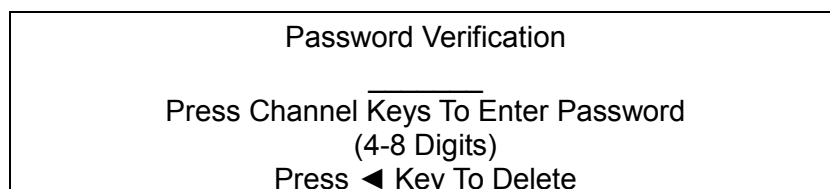

NOTE: It is strongly suggested to change the preset password to prevent unauthorized access to the unit.

An icon displayed at the upper-right corner of the screen will show the authority level of the account. Under logout condition, the icon will show "N". When an account is logged in, its authority level number (1~8) will be shown.

Before completely logout, other functions can also be accessed without having to login again. There are two ways to logout: manually logout by pressing ESC key at Live mode, or auto logout when keys are not pressed for 5 minutes at Live/ Menu mode.

3.2.1 User Management

The DVR provides the option to create up to seven sets of usernames and passwords with customized authority, excluding the preset “admin” account. From the Main Menu, select <System Setup> → <User Management> and the menu is as the following:

User Management	
1. Password Protection	ON
2. Account Setup	
3. Authority Setup	
4. Load Default Setting	No

Password Protection

Select <ON> to request for username and password for accessing functions listed in Authority Setup menu, or select <OFF> to allow free access.

Account Setup

Setup customized username, password, and authority level in this menu. The username is case sensitive. The authority level is ranked from level 1~8, and level 8 has highest authority. Alternatively, select <Disable> to suspend the account.



NOTE: The username and authority level of the preset “admin” account cannot be changed.

Authority Setup

Setup the allowed authority level for accessing the functions listed in this menu. The functions include: Playback/Search, Dome Control, Call Control, Export Data, Menu Access, System Setup, Monitor Setup, Camera Setup, Record Setup, Sequence Setup, Event Setup, Database Setup, Configuration and Shutdown. The authority level is ranked from level 1~8, and level 8 has highest authority. Alternatively, select <Disable> to allow free access.



NOTE: The “Menu Access” cannot be set to <Disable>.

When the account does not have authority to access certain functions, an error message will be displayed on the screen.

Load Default Setting

Select <Yes> to load the default setting.

3.3 Power Up / Shutdown the DVR

If the DVR must be shutdown for any reason, please use the proper shut down and power up procedures to avoid damaging the DVR.

Power Up the Unit

Simply plug in the power adapter that came with the package and the DVR will start to boot.

The color bar and system checking information will be shown on the monitor and then disappear when the unit has been completely powered up.

Restart / Shutdown the Unit

Press MENU and input the username and password that has sufficient authority to access the OSD setup menu. Select <Shutdown> in Main Menu and press ENTER to enter the Shutdown menu, which displays as follows.

Shutdown	
1. Power Off	Execute
2. Reboot	Execute

<Power Off>

Select this item to shut down the unit. Do not remove the power during shut down until the message "You can safely turn off DVR now!" displays.

<Reboot>

Select this item to reboot the unit. The color bar and system checking information are displayed on the monitor until the unit is completely restarted.

3.4 System Date / Time Setting

Users can set the current date, time and other OSD parameters in Date/Time menu (under System Setup menu). The login account should have authority to access the System Setup menu. In OSD setup menu, select <System Setup> and press ENTER, then select <Date/Time> to access the Date/Time menu; the menu displays as follows.

Date/Time	
1. Date	2008/02/21
2. Time	PM10:39:26
3. Time Zone	OFF
4. Date/Time Display	1 Row
5. Date Display Mode	Y/M/D
6. Time Display Mode	12 HR
7. Date/Time Order	Date First
8. Daylight Saving Time Setup	
9. Network Time Protocol Setup	

3.4.1 Set Date / Time

Set Date / Time

Select <Date> / <Time> and press ENTER to adjust the settings. LEFT / RIGHT keys are used to move the cursor to previous or next field, ENTER is for selecting, and UP / DOWN are used to change the value in the selected field.



NOTE: The new date / time setting applies to record new video. The date and time of previously recorded video will not be changed.



NOTE: If time settings have to be changed in any case, it is strongly recommended to format the HDDs to avoid database corruption.

Date / Time Display

Users are allowed to set the time OSD displays in 1 or 2 rows. Use the UP / DOWN keys to change the setting.

Date Display Mode

This function allows users to set the OSD display type of the date. There are three options to select from: <Y/M/D>, <M/D/Y> or <D/M/Y>. “Y” represents “Year”, “M” represents “Month” and “D” represents “Day”.

Move to the item and press ENTER, the option starts blinking. Use UP / DOWN keys to change the setting.

Time Display Mode

Users can set the time format to <12 hour> or <24 hour>. Use the UP / DOWN keys to change the format.

Date / Time Order

The item is used to set the order of date / time display to <Date First> or <Time First>. Use UP / DOWN keys to change the setting.

3.4.2 Daylight Saving Time

Daylight Saving Time

The item is for those people who live in certain regions to observe Daylight Saving Time. Select <ON> to enable, or <OFF> to disable the function.

If the function is disabled, the DST Start / End time and DST Bias will be grayed out and cannot be accessed.



NOTE: If this function is enabled, the date/ time information will be shown on the screen with a DST icon when playing back recorded video or searching video in the event list. “S” indicates summer time and “W” indicates wintertime.

DST Start / End

The items are used to program the daylight saving duration. Use LEFT / RIGHT keys to move the cursor to the next or previous field, UP / DOWN to change the settings in the selected field.

DST Bias

The item allows users to set the amount of time to move forward from the standard time for daylight saving time. The available options are in minutes.

3.4.3 Network Time Protocol Setup

Time Zone

Select **<Time Zone>** to enter the time zone. To find out the correct local time zone, please visit www.greenwichmeantime.com or refer to the following figure.

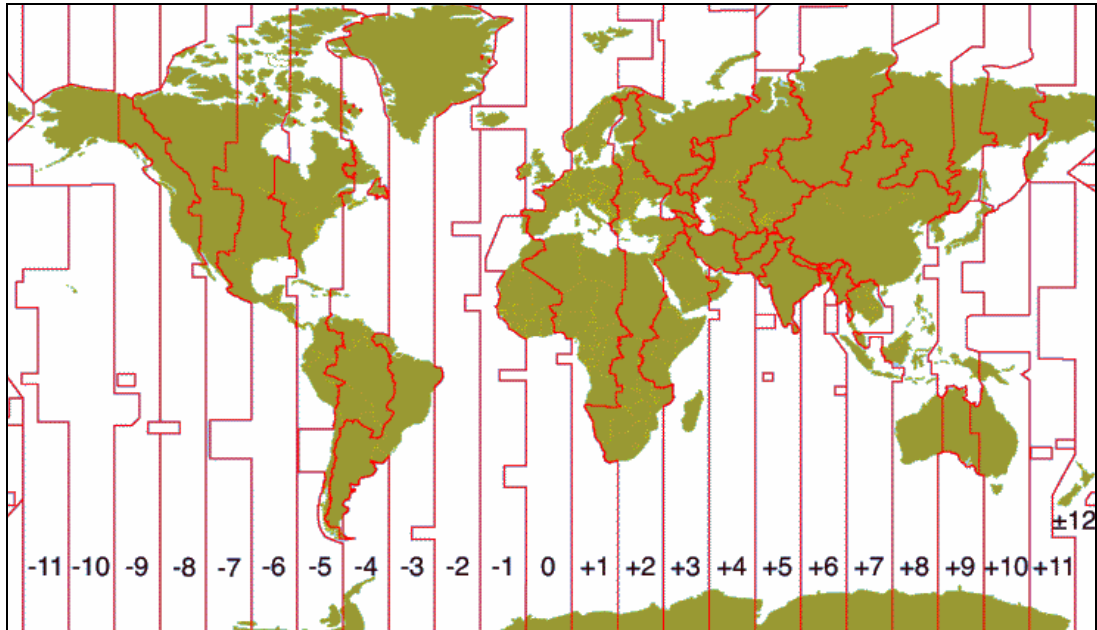

NOTE: The **<Time Zone>** must be set to the correct local time zone or the **<Network Time Protocol Setup>** will not be accessible.

Network Time Protocol Setup

After entering the time zone, the **<Network Time Protocol Setup>** option will appear. Select the **<Network Time Protocol Setup>** to set the time server. The default time server is time.nist.gov, but the user can change it to other time servers when desired. A list of IP addresses of the time servers is listed below.

129.6.15.28	129.6.15.29	132.163.4.101
132.163.4.102	132.163.4.103	128.138.140.44
192.43.244.18	131.107.1.10	69.25.96.13
206.246.118.250	208.184.49.9	64.125.78.85
207.200.81.113	64.236.96.53	68.216.79.113

After the time server is set, set **<Manually Time Sync>** to **<Yes>** to sync the time immediately. The time sync can also be updated periodically. Set **<Automatically Time Sync>** to **<ON>**, and the time will be automatically synced once an hour.

3.5 Record Schedule / Quality Setting

The Record Setup menu allows users to set recording quality, recording schedules, and other recording parameters. Login with a proper account to access Record Setup menu. In the Main menu, move the cursor to <Record Setup> and press ENTER; the following menu is displayed.

Record Setup	
1. Record Mode Setup	
2. Schedule Setup	
3. Preset Config	Best Quality
4. Per Camera Config	
5. ezRecord Setup	
6. Data Lifetime	0 Days
7. Circular Recording	ON
8. Audio Recording	ON
9. Purge Data	

3.5.1 Schedule Setup

The Schedule Setup is used to set the day and night time, or weekend recording schedule. Select <Schedule Setup> from the Record Setup menu and press ENTER; the following menu is displayed.

Schedule Setup	
1. Day Time Start	AM 06:00
2. Day Time End	PM 06:00
3. Night Time Start	PM 06:00
4. Night Time End	AM 06:00
5. Weekend Schedule	ON
6. Weekend Start	Fri 18:00
7. Weekend End	Mon 06:00

- Make appropriate changes of the start time of Day and Night Time using Direction keys.
- Press ENTER to confirm the settings or ESC to cancel.
- If a weekend record is required, select <ON> to enable the Weekend Schedule in advance and then set the Weekend Start/End time.
- Press ESC to return to previous page.

3.5.2 Preset Record Configuration

The <Preset Config> is used to select the preset recording quality and frame rate. In normal circumstances, it is strongly recommended to set the preset configuration as <Best Quality>. Below table shows the PPS and picture size under <Best Quality> in Half-D1 mode for **DVR-16TL**. Please refer to the section **Preset Record Configuration** under **Advanced System Configuration** for more detailed information.

Half-D1 mode (NTSC: 720x240@120PPS; PAL: 720x288@100PPS)			
Normal PPS	Normal Size	Event PPS	Event Size
7.5 NTSC (6.25 PAL)	12 KB / PIC	30 NTSC (25 PAL)	12 KB / PIC

3.5.3 Per Camera Configuration

This function is used to set the Day / Night / Weekend PPS (Picture per Second) and Quality for each channel. The Preset Configuration must be set to <OFF> for accessing these schedules. The menu is displayed as below (Record Mode: 720x240@120PPS in NTSC / 720x288@100PPS in PAL for **DVR-16TL**).

Per Camera Config			
Camera Select	Day	Night	CH1 Weekend
Normal PPS	7.5	7.5	7.5
Normal Size	Mid	Mid	Mid
Event Max PPS	30	30	30
Event Size	Best	Best	Best
Event Active	Both	Both	Both

- First, select a Camera for setting its record configuration. The image and recording settings from the selected camera will be displayed on the screen.
- Move the cursor using Direction keys and press ENTER to select an item.
- Change the value using UP / DOWN keys.
- Press ENTER to confirm the settings or ESC to abort.
- Press ESC to return to Record Setup menu.

Please note that the total normal PPS for all channels (for **DVR-16TL**) cannot exceed 120 NTSC (720×240@120PPS) / 100 PAL (720×288@100PPS). To increase one channel's PPS, you may have to reduce others' first. Event PPS is not restricted to this rule, since a smart event scheduler will handle the total PPS with a correct weighting.

3.5.4 Record Event Video Only

If the DVR shall start recording only when alarms are triggered, follow the steps below:

- Enter the OSD setup menu with correct password.
- In the OSD setup menu, select <Record Setup> menu. Move the cursor to the item <Preset Config>, and select <Event only>.

Refer to the section **Preset Record Configuration** under **Advanced System Configuration** for more detailed information.

4. Basic Operation

The DVR allows users to access some general operations through the front panel easily. The following sections introduce the general operations of the unit.

4.1 View Live / Playback Video

The general functions in live and playback mode are described in the following sections.

4.1.1 Viewing Modes

The DVR provides users versatile ways of viewing both live and recorded video. Following presents these view formats.

Viewing in Full Screen

Press any CHANNEL key directly to view the corresponding camera image in full screen format.

Viewing in Multi-window

Various multi-window view formats are offered for selection. To switch between available viewing formats, press MODE repeatedly.

The available view formats are illustrated as the following figure.

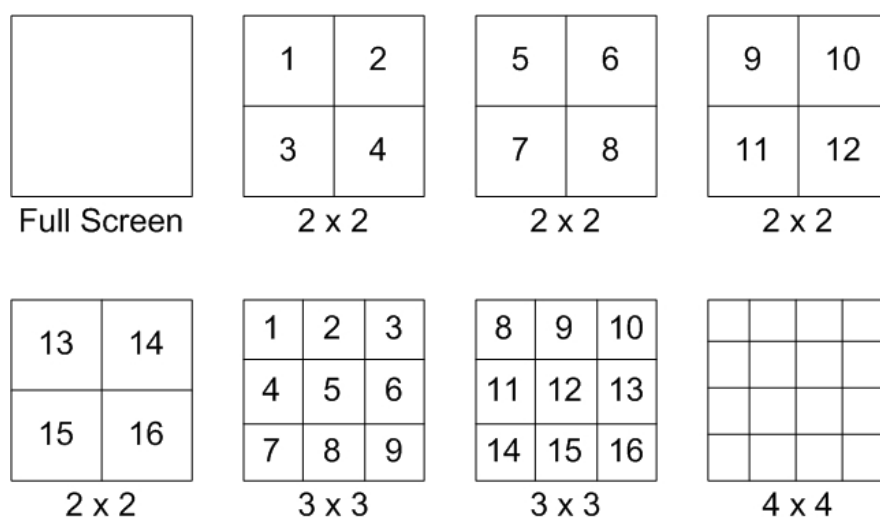

NOTE: 3x3 viewing mode is only available in **DVR-8TL** and **DVR-16TL**, whereas 4x4 viewing mode is only available in **DVR-16TL**.

4.1.2 Digital Zoom

Users are able to view a 2x full screen in live mode. To view the 2x full screen, follow the steps.

- Press any CHANNEL key to view the corresponding camera in full screen.
- Press ENTER to view 2x zoomed screen of the selected camera.
- To view a specific area in 2x zoomed screen, use Direction keys to pan / tilt the zoomed screen.
- Either press ENTER again or ESC to leave the Zoom mode.

4.1.3 View Live Cameras

Users are allowed to view live camera in versatile viewing modes, including full-screen, 2x2, 3x3 and 4x4. The general operation under live mode is described as follows.

Freeze Live Image

Press FREEZE while viewing live image, the image pauses but the date / time information does not, and the system clock continues running.

Press FREEZE to pause the live image; press FREEZE again to resume the live camera view.

4.1.4 View Recorded Video

To view recorded video, users can press PLAY key directly. When press the PLAY key, the unit starts to continue playing back the recorded video from the suspended point of record. If it is the first time to use the PLAY key, the unit will playback from the very beginning of the record. Alternatively, users can select records from the Search menu to play specific video. Refer to section **Search Recorded Video** for more information.



NOTE: When playing back videos with mass motion recorded in D1 mode (resolution=720x480), press SEQ key to switch on “deflicker function” to avoid gleaming of images. Press SEQ again to switch “deflicker off” and the image will return to real D1 resolution.

The Forward or Reverse speed indicator will be shown on the bottom-left corner of the screen, when in the playback mode.

The general operations in playback mode are described as follows.

Key Usage in Playback

The key usage is slightly different in playback mode. Following is the key usage found in playback mode.

- **LEFT** (Reverse Playback)
The key is used to reverse the recorded video while the unit is playing back. Press the key repeatedly to increase the speed of reverse playback by 1×, 2×, 4×, 8×, 16×, or 32×.
- **RIGHT** (Forward Playback)
The key is used to play the recorded video fast forward. Press the key repeatedly to increase the speed of forward playback by 1×, 2×, 4×, 8×, 16×, or 32×.
- **FREEZE**
Press FREEZE to pause the playback video. When the recorded video is paused, press LEFT / RIGHT to resume playback video single step reverse / forward, respectively. Press FREEZE again to continue playing video.
- **PLAY**
Press it to start playing back video, exit current mode, or stop playing back video and return to live mode.

Pause Playback and Single Step Forward

To pause and resume recorded video, follow these steps.

- Press any CHANNEL key to view the corresponding camera in full screen.
- Press FREEZE to pause the current playback image.
- Press LEFT / RIGHT Direction keys to move the video single step reverse / forward. Press and hold LEFT / RIGHT keys to repeatedly reverse / forward the video single step.
- Press FREEZE again to resume the playback operation.

4.2 Sequence

This section introduces the way to view sequence mode with both Main Monitor and Call Monitor, if connected. Sequence function can avoid manual backtracking and provides more flexibility while monitoring surveillance.

4.2.1 Sequence with Main Monitor

Automatic sequence function can be observed in any view mode. Select certain view format and press SEQ to toggle the automatic sequence; press ESC to stop sequencing. The figure below displays the 4-camera and 9-camera sequencing view modes.

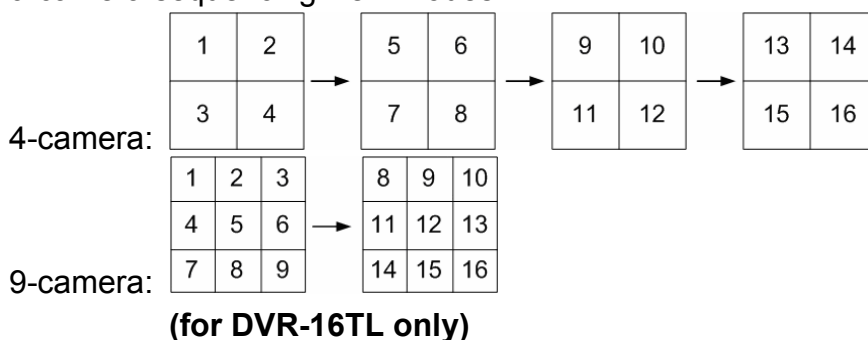

4.2.2 Sequence with Call Monitor

Users are allowed to use the DVR front panel to control a call monitor display without having to access the Main menu. Two viewing modes can be displayed on call monitor: Sequence display and Single camera display. To program the call monitor sequence, see section **Sequence Setup** under **Advance System Configuration**.

Follow the steps to control the call monitor.

- Press the CALL key on the front panel to enter Call Monitor Control mode. The message "Call Mode" will be shown on the bottom-left of the screen.

Press 1-16 Key To Select Channel
Press SEQ To Enable Sequence
Call Mode

- Press CHANNEL key to display the associated camera on call monitor.
- Alternatively, press SEQ repeatedly to display the sequence of cameras previously programmed in Call Monitor Schedule menu.
- Press ESC to return the front panel to Main Monitor Control mode.

4.3 Search Recorded Video

The DVR is capable of searching and playing back recorded video by time or by events. To search by time, select a specific date and time of the wanted video or enter Calendar Search. To search by event, select channels to display the event list.

In live or playback mode, press SEARCH to enter the Search menu, shown as below.

Search				
-----Search By Time-----				
From:	2008/01/01	00:00:00		
End:	2008/05/01	00:00:00		
Select:	2008/01/01	00:00:00		
			Begin Playback	
			Calendar Search	
-----Search By Event-----				
Select Channel:	CH1	CH2	CH3	CH4
				Event List

4.3.1 Search by Time

Follow the steps to search video by date and time.

- Press SEARCH to enter the Search menu.
- Move the cursor to “From” and press ENTER will start playing recorded video from the specified “From” time.
- Move the cursor to “End” and press ENTER will start playing recorded video from the specified “End” time.
- Move the cursor to “Select” and press LEFT/RIGHT keys to choose date/time. Press ENTER and adjust the values by UP/DOWN keys.
- Press ENTER to confirm the settings or ESC to abort.
- Move the cursor to <Begin Playback> and press ENTER to start playing back the selected video.
- Press PLAY again to return to live video.



NOTE: If there is no available recorded video that matches the specified time and date, the unit starts playback from the next available video.



NOTE: The date/time information will be shown on the screen with a DST icon if the Daylight Saving Time function is enabled. “S” indicates summer time and “W” indicates winter time.

4.3.2 Calendar Search

Follow the steps below to search recorded video via Calendar Search.

- Press SEARCH button to enter the Search menu.
- Move the cursor to <Calendar Search> and press ENTER. A calendar will be shown as below.

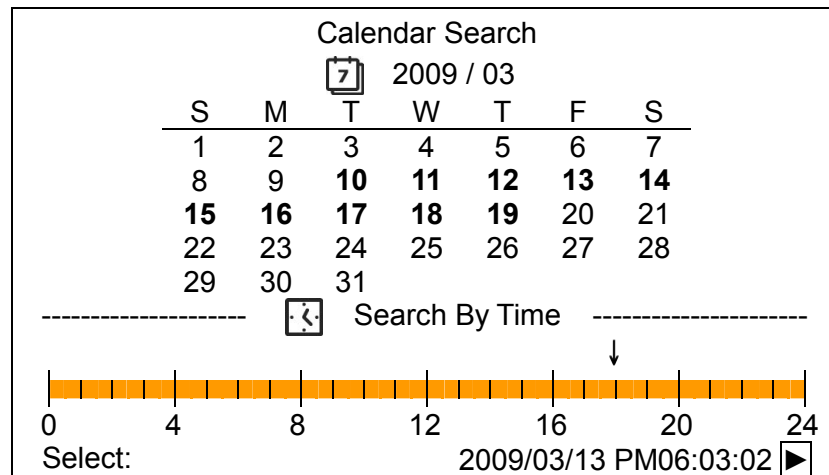

- Move the cursor to year/ month and press ENTER. Then press UP/DOWN keys to adjust the value and press ENTER again to confirm.
- Move the cursor to select any day shown in bold font, and a time ruler will be displayed.
- Press ENTER and an arrow will show up above the time ruler. Press LEFT/RIGHT keys to select a desired time. Alternatively, move the cursor to the time shown at the bottom. Press ENTER and adjust the values of hour/ minute/ second via UP/DOWN keys.
- Note that the time blocks highlighted in red represent events occurred.
- Move the cursor to the playback icon (▶) and press ENTER to start playing back the video.

4.3.3 Search by Event

“Event List” allows users to search wanted video by event. The Event List is displayed as below figure:

Event List				
First Page				
Date	Time	Ch.	Type	
2008/03/17	11:26:50	2	Motion	
2008/03/17	09:53:03	5	Alarm	
2008/03/16	16:14:42	3	Alarm	
2008/03/15	03:45:31	1	Motion	
2008/03/12	22:27:56	1	Alarm	
2008/03/12	10:09:29	7	Motion	
2008/03/11	12:18:20	6	Motion	
2008/03/10	05:16:00	4	Alarm	
2008/03/08	17:11:37	2	Motion	
2008/03/08	16:29:10	8	Motion	
2008/03/08	03:22:17	2	Alarm	

The list displays events by date, time, triggered camera and alarm type. As some events are deleted, others are displayed. The latest recorded event video will be listed on the top.

Follow these steps to search event video through Event List:

- Press SEARCH to enter the Search menu.
- To search event video that has been recorded on a specific camera, use LEFT / RIGHT to move the cursor and press ENTER to select or de-select a channel.
- Move the cursor to <Event List> and press ENTER to list the event video of the selected channels. The Event List displays.
- To exit the event list, press ESC.

Follow the steps to playback video from Event List.

- Press and hold UP / DOWN to scroll through the Event List.
- Press ENTER to play back the selected event record.
- Press PLAY to return to live mode.

4.4 Video Export

The unit allows users to export wanted video to the built-in DVD+RW or an external device, such as a USB ThumbDrive, and the exported video will be saved as *.drv file.

If the video is to be exported to an external device, make sure the device is connected to the DVR unit and the port has been set appropriately for video export.



NOTE: Once an external device is connected to the DVR unit, the device has priority over the built-in DVD+RW. That means the video will be exported to the external device instead of the built-in DVD+RW.

According to the size of video, the export may take about 10 minutes to 1 hour.



NOTE: The **Central Management System (CMS)** software can also remotely execute video export function. Please refer to the CMS user's manual for more details.

4.4.1 ezBurn Introduction

Built with the ezBurn technology, ezBurn function provides users the easier way to export desired video with built-in DVD+RW or to an external device, such as an USB ThumbDrive.

TWO keys (SEARCH and COPY) and THREE touches are all what's needed for completing the export. The entire exporting process will be done through the front panel, without needing to enter the OSD setup menu.

The ezBurn exporting process is illustrated as below figure:

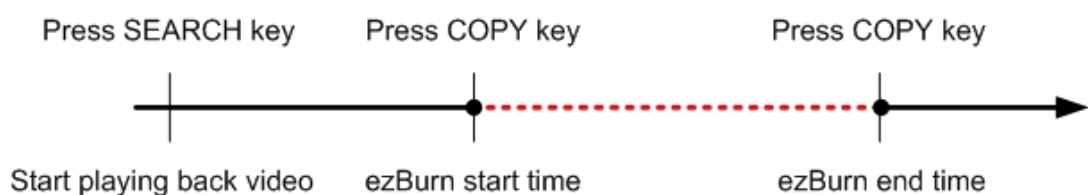

The entire process is described step by step in the following sections.



NOTE: The file exported using ezBurn will be in .drv file format, and it can only be played using the player software, Speco**Player**.

4.4.2 Export Normal Video

To Export normal video to external device, follow these step:

- Press SEARCH and play wanted normal video by entering date and time, or via calendar search .
- After entering playback mode, play the video and press COPY once to mark the starting point of the export video. The playback continues.
- Press COPY again to mark the ending point of the export video. Then the “ezBurn” window will display as below figure. The information shown on the window is “read only”.

```
ezBurn confirmation
Selected Device: Built-in DVD+RW
All data on the disc will be erased.
Exported Required Size = 11 MB
Real Export Range:
From: 2008/06/07 AM10:41:13
To: 2008/06/07 AM10:41:21
Enter: YES ESC: NO
```

- Press ENTER to start the export; or, press ESC to abort.
- If there is no any exportable device connected to the DVR unit, then a warning message will be shown on the screen, as below figure:

```
No exportable device detected.
Please install the target device/media
to the DVR.
Enter: Retry ESC: Exit
```

4.4.3 Export Event Video

To export event video, follow these steps:

- Press SEARCH and play wanted event video. To play event video, refer to section **Search Recorded Video**.
- After entering the playback mode, press COPY. The “ezBurn” window will display as below figure. The information shown is “read only”.

ezBurn confirmation			
Selected Device: Built-in-DVD+RW			
All data on the disc will be erased.			
Exported Required Size = 11 MB			
Export Event Info:			
Data	Time	Ch	Type
2008/06/07	AM10:42:35	13	Motion
Enter: YES		ESC: NO	

- If there is no any exportable device connected to the DVR unit, a warning message will be shown on the screen
- Press ENTER to start the export the whole event video to the connected device; or, press ESC to abort.

4.5 Dome Control

The DVR allows users to control a dome camera by the front panel. In Live mode, users can press CHANNEL key to display the desired dome camera in full screen. To enter Dome Control mode, press the DOME key and press channel key 2 to display the hint screen. To exit the Dome Control mode and return to live mode, press ESC or DOME.

In dome control mode, press CALL + ENTER to open the OSD setup menu of the dome camera. To traverse the menu, press CALL + UP/DOWN keys to move up/down, CALL + RIGHT/LEFT to change value or to move left/right, and CALL + ENTER to select or enter submenu.

4.5.1 Dome Connection

Follow the steps to install dome cameras.

- See **Setup Guide** for RS-485 port pin definition.
- Connect the R+, R- terminals on the dome camera to the D+, D- terminals on the RS-485 port by RS-485 cable respectively. Refer to the connection figure illustrated in **Setup Guide**.

4.5.2 Dome Protocol Setup

The Dome Protocol item lists the available dome protocols for communicating with dome cameras connected to the DVR. From the Main menu, select <Camera Setup> and press ENTER. The following menu is displayed.

Analog Camera	
1. Analog Camera Select	CH1
2. Dome Protocol	None
3. Dome ID	0
4. Camera Title	
5. Covert	No
6. Brightness	0
7. Contrast	0
8. Saturation	0
9. Hue	0
10. Audio Association	Yes

To configure dome protocol, select a camera first and set the communications protocol associated with dome camera using the Direction keys and ENTER.



NOTE: The settings become effective after saving the changes and exiting from the menu.

4.5.3 RS485 Setup

The DVR controls the domes via RS-485 communication protocol. The RS-485 parameters in the DVR must be set to the same parameters set in dome camera.

Users are allowed to change the RS-485 settings of the DVR. Select <System Setup> in Main menu, then select <RS485 Setup> from the System Setup menu and press ENTER. The following menu is displayed.

RS485 Setup	
1. Unit ID	224
2. Baud Rate	9600
3. Bits	8
4. Stop	1
5. Parity	None

The ID number must match the ID address set by the dome. The Unit ID is in the range of 1 to 255. Note that there cannot be any two devices on the same bus given the same ID address, or a conflict may occur.



NOTE: The settings become effective after saving the changes and exiting from the menu.

4.5.4 Dome Controlling Keys

The functions of some keys in Dome Control mode are totally different from normal status function. Please refer to **Setup Guide** for the graphical illustration of functional keys.

Set / Go Preset

This key is used to enter the Dome Preset menu to set up certain position as a preset and go to the predetermined preset positions for viewing.

Toggle Hint Screen

This function is used to avoid viewing the dome parameter information while controlling dome cameras. Press this key to hide the screen. Press it again to redisplay the screen.

Iris Open

Use to open the Iris on the dome camera.

Focus Near

Use to focus the dome camera near.

Zoom In

Use to zoom in the dome camera. This function enables users to enlarge a certain area.

ESC

Use to leave Dome Control mode and return to live and full-screen viewing mode.

Auto / Enter

- In OSD setup menu interface, the key is used to make selection.
- In Dome Control mode, this key is used to activate automatic focus and iris function.

Iris Close

Use to close the Iris on the dome camera.

Focus Far

Use to focus the selected dome camera far.

Zoom Out

Use to zoom out the dome camera. This function enables users to shrink the current image and view a larger area.

Pan / Tilt

Use to pan and tilt dome camera.

4.5.5 Setting Preset Points

The DVR allows users to set preset positions. The amount of preset points depends on the dome manufacturer.

Follow the steps to set preset points.

- Press a Channel key to view the corresponding camera in full screen.
- Then press DOME to enter Dome Control mode. A Hint Screen shown as below figure displays on the screen.
- Press 2 to hide the Dome Control Hint Screen; press 2 again to toggle the Hint Screen.
- Use Direction keys to position the dome camera to desired position.

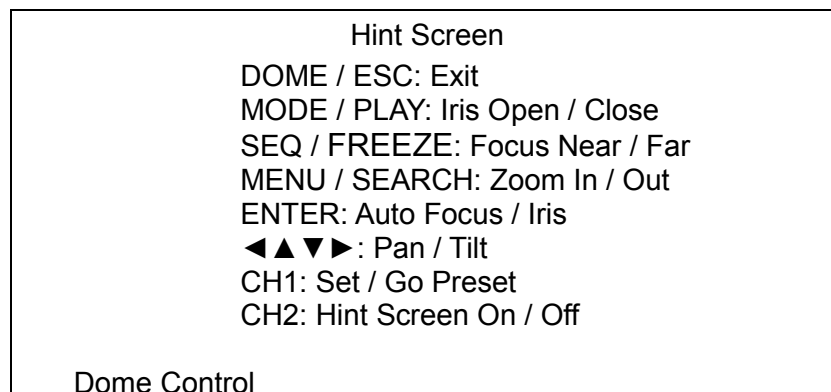

- Press 1 to access the Set/Go Preset function. The Dome Preset menu is displayed.

Dome Preset			
First Page			
	Index	Set Preset	Go Preset
	1	No	No
	2	No	No
	3	No	No
	4	No	No
	5	No	No
	6	No	No
	7	No	No

- Use UP / DOWN keys to select the desired preset number from the menu.
- Set the <Set Preset> of the selected preset number to <Yes>, and press ENTER to save the position. Now the preset is set and ready to be called.

4.5.6 Calling Preset Points

Follow the steps to call preset points.

- Press a Channel key to view the corresponding camera in full screen.
- Then press DOME to enter dome control mode. A Hint Screen shown as below figure will be displayed on the screen.
- Press 2 to hide the Dome Control Hint Screen; press 2 again to toggle the Hint Screen.
- Press 1 to access the Set/Go Preset function.

Dome Preset			
First Page			
	Index	Set Preset	Go Preset
	1	No	No
	2	No	No
	3	No	No
	4	No	No
	5	No	No
	6	No	No
	7	No	No

- Use UP / DOWN keys to select the desired preset number from the menu.
- Set the <Go Preset> of the selected preset number to <Yes>, and press ENTER to call the preset point.
- Now the selected dome camera rotates to the preset position automatically.

5. Advanced System Configuration

The detailed functions and settings of **DVR-4TL/8TL/16TL** can be set by entering the intuitive Graphical User Interface (GUI) OSD setup menu. Collaborating with a USB mouse, setting up the DVR can be easy as operating on a PC. This chapter particularizes the items and options in the OSD setup menu.

Username and Password

Press MENU and input a valid username. There are two preset accounts: "admin" and "user". The default username "admin" can be inputted via pressing the hot key MENU, while "user" can be inputted via pressing the hot key SEARCH. Move to <OK> and press ENTER to proceed.

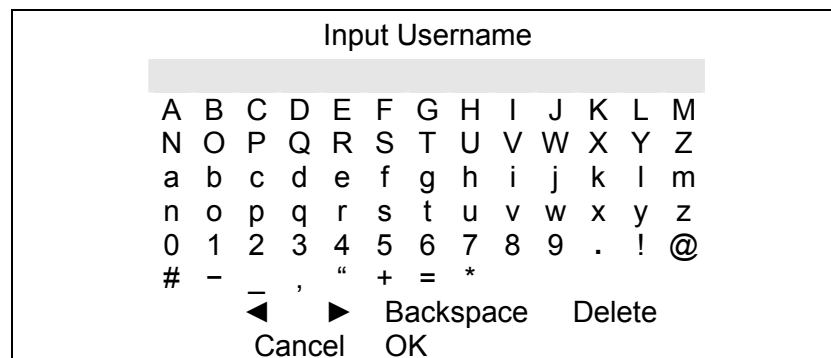

The next step is to enter a corresponding password. The preset password for "admin" is "1234", and the password "4321" is for "user".

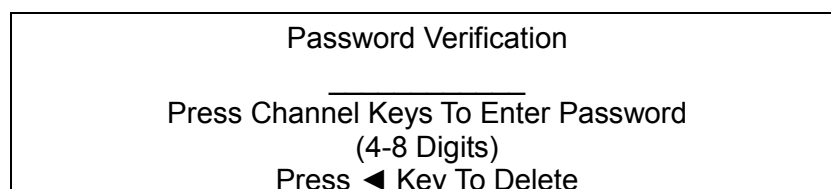

NOTE: It is strongly suggested to change the preset password to prevent unauthorized access to the DVR.

An icon displayed at the upper-right corner of the screen will show the authority level of the account. Under logout condition, the icon will show "N". When an account is logged in, its authority level number (1~8) will be shown.

Before completely logout, other functions can also be accessed without having to login again. There are two ways to logout: manually logout by pressing ESC key at Live mode, or auto logout after 5 minutes idle time at Live/ Menu mode.

Key Usage in OSD setup menu

<Direction Keys>

In the OSD setup menu, Direction keys are used to move the cursor to select menu items. UP / DOWN are used to change the value in the selected field.

<ENTER>

In OSD setup menu or selection interface, press this key to select or save settings.

<ESC>

Press to cancel or exit from certain OSD setup menu without saving any changes.

Key Usage in Virtual Keyboard

A virtual keyboard shows is some setting items, such as camera title, e-mail address, etc. The virtual keyboard displays as follows.

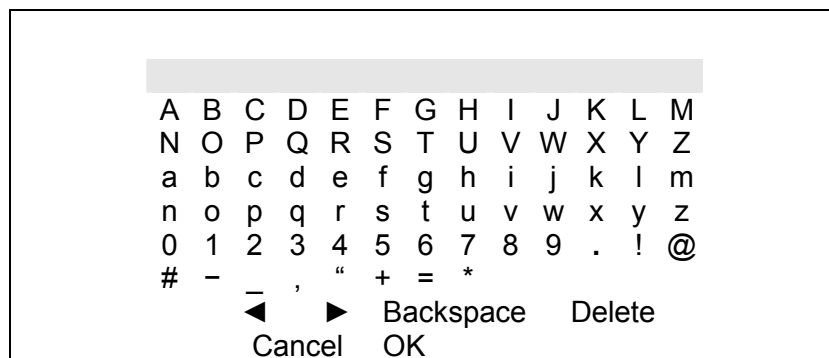

<To input characters>

Move the cursor by pressing Direction keys and press ENTER to select characters. Alternatively, press channel keys 1~9 to directly enter number 1~9, press channel key 10 to directly enter number 0, or press "CALL" key to directly enter a period mark ".". The hot keys are for speeding up inputs of IP addresses or etc.

<To move the cursor in title entry>

Select <<> / <>> and press ENTER, or press MODE and <<> / <>> simultaneously to move the cursor to left / right in the title entry field.

<To delete previous character>

Select <Backspace> and press ENTER, or press DOME.

<To delete current character>

Select <Delete> and press ENTER.

<To exit the virtual keyboard>

Select <OK> and press ENTER to save the settings and exit, or press ESC to exit without saving changes.



NOTE: If a USB keyboard is connected and when any key on the keyboard is pressed, the cursor on the virtual keyboard will be automatically moved to "OK".

5.1 System Setup

Select <System Setup> from the Main Menu and press ENTER to enter the System Setup menu. The items in the System Setup menu are described in the following sections.

System Setup	
1. System/Version Info	
2. Language	English
3. Date/Time	
4. Unit Name	DVR
5. User Management	
6. Network Setup	
7. RS485 Setup	
8. Audio Output/Key Beep	

5.1.1 System/Version Info

The System/Version Info menu allows users to view system information such as hardware and software version. From the System Setup menu, select <System/Version Info> and press ENTER. The following menu is displayed. The first five items are "read only", thus CANNOT be changed. The items in this menu are described in the following subsections.

System/Version Info	
Model Name	****
Video System	NTSC
Hardware	**_**_**
Software	****_****_****_****
MAC Address 1	*****.*****.*****
Software Upgrade via Local Device	

5.1.1.1 System and Version Information

The first five items show the model name, video system, MAC Address1, and identify the hardware and software version for this unit.

5.1.1.2 Software Upgrade via Local Device

This item is used for updating software of **DVR-4TL/8TL/16TL** via local device. The menu is displayed as follows.

Software Upgrade via Local Device	
Upgrade Version xxxx-xxxx-xxxx-xxxx	Select No

Connect an USB storage device containing upgrade software to the DVR; the available upgrade files will be listed in the menu. To update the system, select a file and use UP / DOWN keys to choose <Yes>. Press ENTER to confirm the selection and start the upgrade process. **DVR-4TL/8TL/16TL** will download the software, update the system files, and reboot automatically.

The upgrade may take several minutes to save the changes in the memory of the system. After the DVR is rebooted, please check the software version again.



NOTE: Power interruption is **NOT** allowed during the software update. Ensure that no power interruption can occur until the DVR is completely rebooted.



NOTE: Do not remove the external USB ThumbDrive / DVD+RW before the DVR has completely shutdown (hard drive and fan are off). Removing the external USB ThumbDrive / DVD+RW before shutdown can cause the system to update improperly.

5.1.2 Language

The Language item allows users to select the language for the OSD menu and screen messages. Language selection takes effect immediately when the selection is made. Press UP / DOWN to select from listed languages and press ENTER to confirm.

5.1.3 Date / Time

Users can set the current date, time and other OSD parameters in this menu. Login using account with proper privilege to enter the submenu. In System Setup menu, select <Date/Time> and press ENTER. The Date/Time menu displays as follows.

Date/Time	
1. Date	2008/02/21
2. Time	PM10:39:26
3. Time Zone	OFF
4. Date/Time Display	1 Row
5. Date Display Mode	Y/M/D
6. Time Display Mode	12 HR
7. Date/Time Order	Date First
8. Daylight Saving Time Setup	
9. Network Time Protocol Setup	



NOTE: The reset of date / time setting only applies to new video. The date and time of previously recorded video will not be changed.



NOTE: To avoid database corruption, formation of the database must be done after changing Date/Time setting.

5.1.3.1 Date / Time

Select <Date> or <Time> and press ENTER to adjust the settings. LEFT / RIGHT keys are used to move the cursor to previous or next field, ENTER is for selecting, and UP / DOWN are used to change the value in the selected field.

5.1.3.2 Time Zone

Press ENTER to set users' local time zone. Please refer to the following figure or visit www.greenwichmeantime.com to find out users' local time zone.

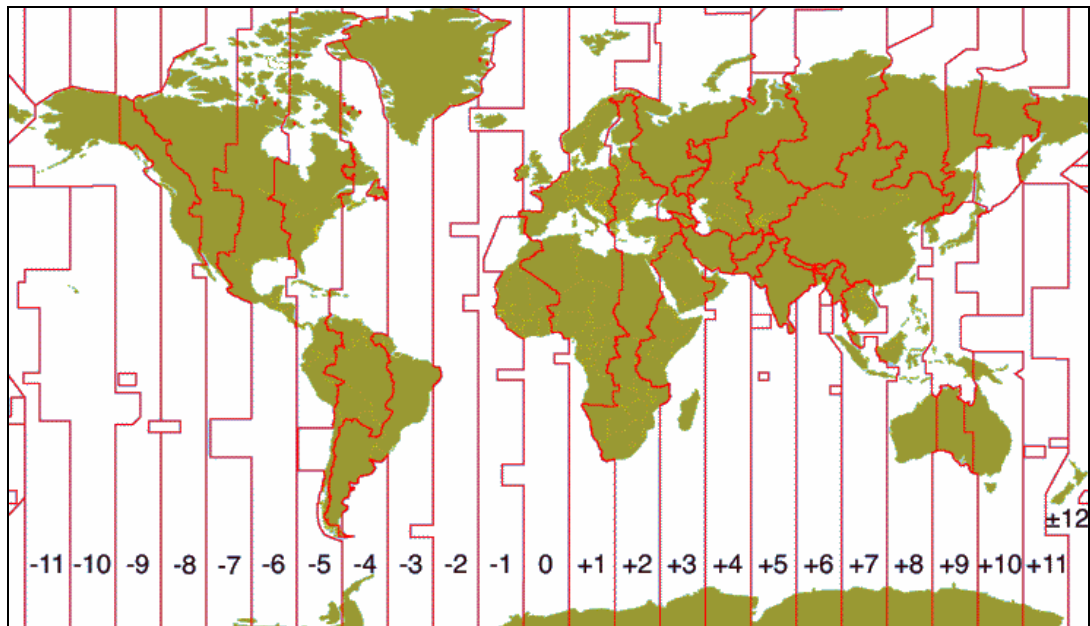

NOTE: <Time Zone> must be set to users' local time zone or the <Network Time Protocol Setup> will not be accessible.

5.1.3.3 Date / Time Display

The date/time display can be set to be shown in 1 row, 2 rows, or not shown. Use the UP / DOWN keys to change the setting.

5.1.3.4 Date Display Mode

This menu allows users to set the display type of the date. Three options are provided: <Y/M/D>, <M/D/Y> or <D/M/Y>. "Y" represents "Year", "M" represents "Month" and "D" represents "Day". Use UP / DOWN keys to change the setting.

5.1.3.5 Time Display Mode

Users can set the time format to <12 hour> or <24 hour>. Use the UP / DOWN keys to change the format.

5.1.3.6 Date/Time Order

This item is used to set the order of Date/Time display to <Date First> or <Time First>. Select this item and press UP / DOWN keys to change the setting.

5.1.3.7 Daylight Saving Time Setup

This function is for people who live in certain regions to observe Daylight Saving Time. The menu displays as follows:

Daylight Saving Time Setup	
1. Daylight Saving Time	OFF
2. DST Start	Apr. 1 st Sun, 02:00
3. DST End	Oct. Last Sun, 02:00
4. DST Bias	60 Min

Daylight Saving Time

Select <ON> to enable, or <OFF> to disable the function. If the function is disabled, the DST Start / End time and DST Bias will be grayed out and cannot be accessed. If this function is enabled, the date/time information will be shown on the screen with a DST icon when playing back recorded video or searching video in the event list. "S" indicates summer time and "W" indicates winter time.

DST Start / End

These items are used to set duration of daylight saving time. Use LEFT / RIGHT to move the cursor to the previous or next field, UP / DOWN to change the settings.

DST Bias

This item allows users to set the amount of time to move forward from the standard time for daylight saving time. Available options are <30>, <60>, <90> and <120> minutes.

5.1.3.8 Network Time Protocol Setup Setup

After time zone is set, the <Network Time Protocol Setup> option will be available.

Network Time Protocol Setup	
1. NTP Server	time.nist.gov
2. Automatically Time Sync	ON
3. Manually Time Sync	No

NTP Server

Enter this item to setup a feasible time server. The default time server is time.nist.gov. Users can change it to any other time server if desired. IP addresses of other time servers are listed below for reference.

129.6.15.28	129.6.15.29	132.163.4.101
132.163.4.102	132.163.4.103	128.138.140.44
192.43.244.18	131.107.1.10	69.25.96.13
206.246.118.250	208.184.49.9	64.125.78.85
207.200.81.113	64.236.96.53	68.216.79.113

Automatically Time Sync

Select <ON> and the time will be synced once an hour.



NOTE: If users want the unit to automatically synchronize the local time, the <Time Zone> item **MUST NOT** be set to <OFF>, or the function cannot be activated.

Manually Time Sync

Select <Yes> to sync the time immediately.

5.1.4 Unit Name

Users are allowed to assign a unit name, up to 11 characters, to **DVR-4TL/8TL/16TL**.

Follow the steps below to edit the unit name.

- Select <Unit Name> from System Setup menu and press ENTER. A virtual keyboard displays as below.

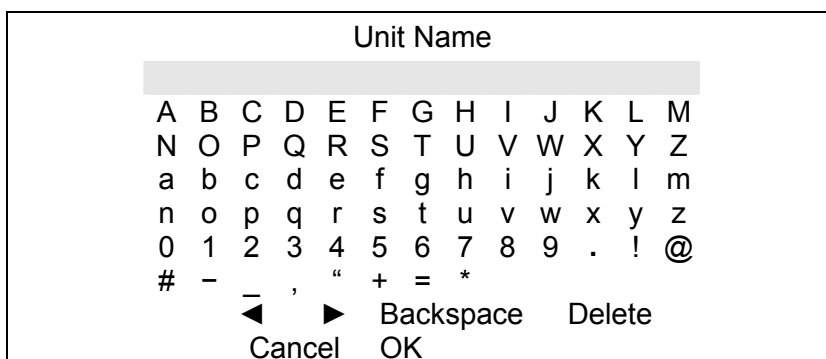

- Use Direction keys to move the cursor to the wanted character.
- Press ENTER to add the character to the entry field (up to 11 characters).
- When the unit name is entered, move the cursor to <OK> and press ENTER to save the settings and exit.

5.1.5 User Management

The DVR provides the option to create up to seven sets of usernames and passwords with customized authority, excluding the preset “admin” account. The menu is as the following.

User Management	
1. Password Protection	ON
2. Account Setup	
3. Authority Setup	
4. Load Default Setting	No

5.1.5.1 Password Protection

Select <ON> to request for username and password for accessing functions listed in Authority Setup menu, or select <OFF> to allow free access.

5.1.5.2 Account Setup

Setup customized username, password, and authority level in this menu. Press Direction keys and ENTER to select items. The username(ID) is case sensitive. The authority level ranks from level 1~8, and level 8 has highest authority. Alternatively, select <Disable> to stop using the account.

Account Setup			
Account	ID	PWD	Authority
admin	Edit	Edit	Level 8
user	Edit	Edit	Level 4
user1	Edit	Edit	Level 4
user2	Edit	Edit	Level 4
user3	Edit	Edit	Level 4
user4	Edit	Edit	Level 4
user5	Edit	Edit	Level 4
user6	Edit	Edit	Level 4
user7	Edit	Edit	Level 4



NOTE: The username and authority level of the preset “admin” account cannot be changed.

5.1.5.3 Authority Setup

Setup permitted authority level for accessing the functions listed in this menu. The functions include: Playback/Search, Dome Control, Call Control, Export Data, Menu Access, System Setup, Monitor Setup, Camera Setup, Record Setup, Sequence Setup, Event Setup, Database Setup, Configuration and Shutdown. Press Direction keys and ENTER to select from items. The authority level ranks from level 1~8, and level 8 has highest authority. Alternatively, select <Disable> to allow free access.

Authority Setup	
FIRST PAGE	
Item	Authority
Playback/Search	Level 4
Dome Control	Level 4
Call Control	Level 4
Export Data	Level 4
Menu Access	Level 4
System Setup	Level 4
Monitor Setup	Level 4
Camera Setup	Level 4
Record Setup	Level 4



NOTE: The “Menu Access” cannot be set to <Disable>.

When the account does not have authority to access certain functions, an error message will be displayed on the screen.

5.1.5.4 Load Default Setting

This item is for restoring the default settings. Select <Yes> to load default setting or select <No> to exit.

5.1.6 Network Setup

The Network Setup menu allows users with proper privilege to configure the network by specifying the network related settings, such as IP address and Netmask, etc. Check with the network administrator and/or network service provider for more specific information.

Network Setup	
1. LAN Select	LAN
2. LAN Setup	
3. Trigger Port	100
4. Email Address	
5. SMTP Setup	
6. DDNS Setup	

5.1.6.1 LAN Select

This item allows users to select the network type among <LAN>, <PPPoE>, and <None>. If the internet connection is a local area network communication, please select <LAN>. If the internet connection is a broadband medium, such as DSL Line or cable modem, please select <PPPoE>.

PPPoE stands for Point-to-Point Protocol over Ethernet. It is a specification for connecting the users on an Ethernet to the Internet through a common broadband medium.

If <None> is selected, then there is no need to set further LAN or PPPoE settings. Therefore, the second item <LAN Setup> will be inaccessible.

5.1.6.2 LAN Setup

The network related settings in the LAN Setup menu should be associated with the network service type. Select <LAN Setup> in Network Setup menu and press ENTER to set the parameters. The menu displays as follows.

LAN Setup		
1. DHCP		OFF
2. IP		192.168.1.1
3. Netmask		255.255.255.0
4. Gateway		192.168.1.1
5. DNS		0.0.0.0
6. PPPoE Account		
7. PPPoE Password		
8. PPPoE Max Idle		35min
9. Connect At Booting		Yes
10. Network Restart		No

DHCP

This item allows users to obtain a dynamic IP address from DHCP (Dynamic Host Configuration Protocol) server when the DVR boots up. When using DHCP, the settings are dynamic and will change every time the DVR power on or off, depending on the network's setup.

If the item is enabled (ON), a dynamic IP will be assigned to **DVR-4TL/8TL/16TL**. In this case, users do not need to set a static IP and the Ethernet settings, including IP address, Netmask, Gateway, and DNS settings will be read-only.

If the DVR is using a permanent address, disable DHCP (OFF) to manually set IP Address, Netmask, Gateway, and DNS. See the network system administrators or IT personnel for appropriate values.

IP

This item is used to configure the IP (Internet Protocol) address of the DVR. The IP address is the identifier for the DVR on a TCP/IP LAN. Please note that to set a static IP address, DHCP must be set to <OFF>.

Netmask

A netmask is a 32-bit mask used to divide an IP address into subnets and specify the networks available hosts. Its value is defined by the network administrator. It takes the form as `***.***.***.***`, for example, 255.255.255.0.

This item allows users to enter the value of the Netmask for the DVR. Please note that to configure this item, DHCP must be set to <OFF>.

Gateway

Gateway is a node on a network that serves as an entrance to another network. Users are allowed to specify the IP address of the gateway or router associated with this DVR. To configure this item, DHCP must be set to <OFF>.

DNS

DNS is the abbreviation for "Domain Name Server", which is an Internet service that translates domain names into IP addresses. The advantage of using DNS is that domain names are easier to remember.

This item allows users to specify the IP address of the Domain Name System associated with the DVR. To configure this item, DHCP must be set to <OFF>.

If the server is unavailable when using DHCP, the DVR will search for the network server and boots up more slowly. This network search continues until it times out.

PPPoE Account

The item allows users to setup the PPPoE login username.



NOTE: For accessing the PPPoE settings, select <PPPoE> as the Network Type in Network Setup menu.

To setup the login username, follow the steps:

- Select <PPPoE Account> from LAN Setup menu and press ENTER. A virtual keyboard displays.

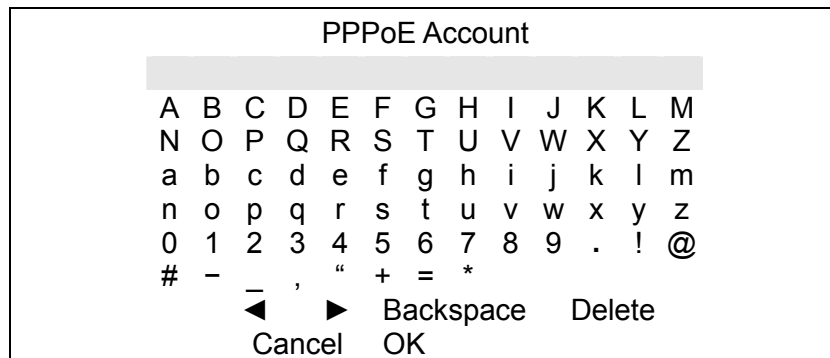

- Use Direction keys to move the cursor to the desired character.
- Press ENTER to add the character to the entry field.
- When it's done, move the cursor to <OK> and press ENTER to save the setting and exit.

PPPoE Password

The item allows users to setup the PPPoE password. Follow these steps to setup the login password.

- Select <PPPoE Password> from LAN Setup menu and press ENTER. A virtual keyboard displays.
- Use Direction keys to select from characters.
- Press ENTER to add the selected character to the entry field.
- When it's done, move the cursor to <OK> and press ENTER to save the setting and exit.

PPPoE Max Idle

The item indicates the duration that the modem connection remains active if there is no acknowledgement from the remote PC. Users can select the idle time from 0 to 600 minutes.

Connect At Booting

The DVR is allowed to automatically connect to the internet when booting up. Select <Yes> to connect at booting, otherwise select <No>.

Network Restart

Network restart is required after network settings are changed. Select <Yes> to restart the network connection.

5.1.6.3 Trigger Port

To avoid the possibility of the default service port (port 100) being blocked, this item enables the user to change port 100 into another port. To change the trigger port, move the cursor over <Trigger Port> and press ENTER, then adjust the setting by UP / DOWN keys.

5.1.6.4 Email Address

This item is used to edit the e-mail address where alarm event information will be sent. Follow these steps to setup the e-mail address.

- Select <Email Address> from Network Setup menu and press ENTER. A virtual keyboard displays.
- Use Direction keys to move the cursor for selecting from characters.
- Press ENTER to add the selected character to the entry field.
- When it's done, move the cursor to <OK> and press ENTER to save the settings and exit.

5.1.6.5 SMTP Setup

Simple Mail Transfer Protocol (SMTP), a protocol for sending e-mail messages between servers. SMTP is a relatively simple, text-based protocol that one or more recipients of a message are specified and the message text is transferred.

Select < SMTP Setup> from Network Setup menu and press ENTER; the menu displays as follows.

SMTP Setup	
1. Email via SMTP	ON
2. SMTP Server	
3. SMTP Port	25
4. SMTP Account	
5. SMTP Password	

Email via SMTP

The item enables users to determine if the DVR sends e-mail via SMTP. Select <ON> to send e-mail via SMTP using direction keys; if not, select <OFF>.

SMTP Server

This item enables users to set the SMTP server. Contact the network service provider for more specific information.

Follow these steps to setup the SMTP Server.

- Select <SMTP Server> from SMTP Setup menu and press ENTER. A virtual keyboard displays.

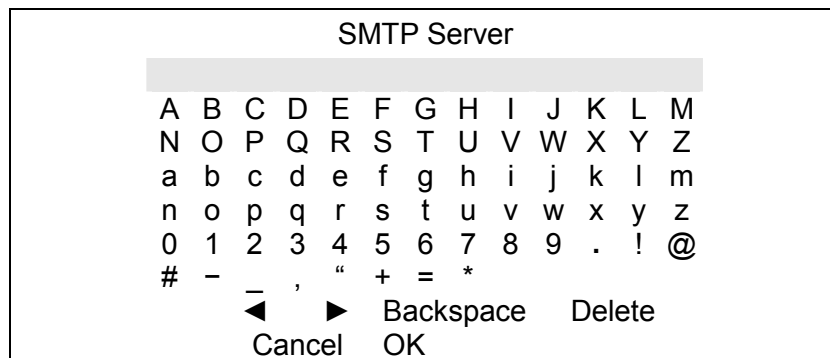

- Use Direction keys to move the cursor to the desired character.
- Press ENTER to add the selected character to the entry field.
- When it's done, move the cursor to <OK> and press ENTER to save the settings and exit.

SMTP Port

The item is used to change SMTP port to another port, if necessary. SMTP usually is implemented to operate over Internet port 25.

To change the SMTP port, move the cursor to <SMTP Port> in SMTP Setup menu and press ENTER. Use UP / DOWN keys to change the values.

SMTP Account

The item allows users to setup the SMTP username. Follow these steps to setup the login username.

- Select <SMTP Account> from SMTP Setup menu and press ENTER. A virtual keyboard displays.
- Use Direction keys to move the cursor for selecting from characters.
- Press ENTER to add the selected character to the entry field.
- When it's done, move the cursor to <OK> and press ENTER to save the settings and exit.

SMTP Password

The item allows users to setup the SMTP password. Follow these steps to setup the password.

- Select <SMTP password> from SMTP Setup menu and press ENTER. A virtual keyboard displays.
- Use Direction keys to move the cursor for selecting from characters.
- Press ENTER to add the selected character to the entry field.
- When it's done, move the cursor to <OK> and press ENTER to save the settings and exit.

5.1.6.6 DDNS Setup

Dynamic Domain Name System (DDNS) allows a DNS name to be constantly synchronized with a dynamic IP address. In other words, it allows those using a dynamic IP address to be associated to a static domain name so others can connect to it by the domain name.

Once the setting is completed, the DDNS address will be:

<http://hostname.ddns.specoddns.net>

Fore example, if the chosen Host name is “**SPECO**”, then the address will be:

<http://speco.ddns.specoddns.net>

Select <DDNS Setup> from Network Setup and press ENTER. The menu displays as below.

DDNS Setup		
1. Enable DDNS		ON
2. Host Name	XXXX_XXXXXX	
3. DDNS Port		80
4. Submit/Update		No
5. ezDDNS		No

Enable DDNS

The item is used to enable or disable the Dynamic Domain Name Service. Select <ON> to enable the service, or <OFF> to disable.

Host Name

The item allows users to setup a domain name, which is used for entering **DVR-4TL/8TL/16TL** through internet on the remote PC.

To setup the host name of the DVR, follow the steps.

- Select <Host Name> from DDNS Setup menu and press ENTER. A virtual keyboard displays as below.

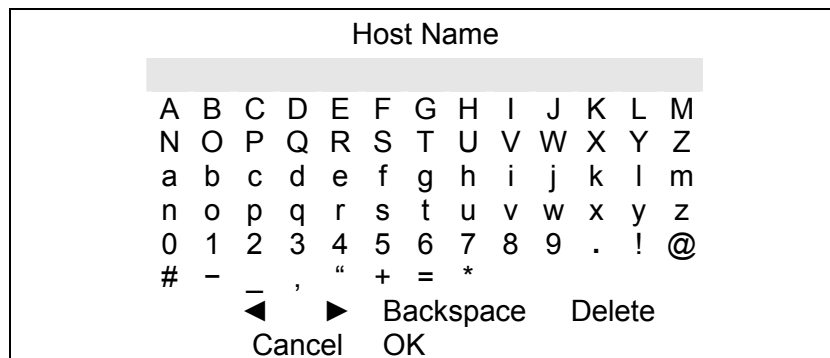

- Use Direction keys to select character.
- Press ENTER to add the selected character to the entry field
- When it's done, move the cursor to <OK> and press ENTER to save the settings and exit.



NOTE: Each **DVR-4TL/8TL/16TL** should have a unique host name.

DDNS Port

The item allows users to setup the port for DDNS. Press UP / DOWN Direction keys to change the port.

Submit/ Update

When the settings are finished, move the cursor to this item and select <Yes> to submit the settings.



NOTE: If more than one **DVR-4TL/8TL/16TL** has the same domain name, only the first one will be submitted successfully.

ezDDNS

ezDDNS enables the users to register for host name automatically. Press ENTER and select <Yes>. The following screen will be displayed:

```
ezDDNS Submit/update ok!
Host name is XXXX_XXXXXX
Press any key to return
```



NOTE: The DVR must be connected to the *Real IP address, or be assigned a specific port using **Port Forwarding technique.

*A "**Real IP**" is the IP address that is assigned by users' ISP.

A "Virtual IP**" is the IP address assigned either manually or through DHCP. When the user is assigned a Virtual IP, the user must use **Port Forwarding** technique to assign a specific port to the DVR.

5.1.7 RS485 Setup

This menu allows the user to setup the parameters of the unit's RS-485 communications port. From the System Setup menu, select <RS485 Setup> and press ENTER. The following menu is displayed.

RS485 Setup	
1. Unit ID	224
2. Baud Rate	9600
3. Bits	8
4. Stop	1
5. Parity	None

5.1.7.1 Unit ID

This item is used to change the RS-485 ID address of the DVR. The ID is in the range of <1> to <255>.

5.1.7.2 Baud Rate

The Baud rate options for associated with the protocol are <2400>, <4800>, <9600>, <19200>, <38400>, and <57600>..

5.1.7.3 Bits

Users can specify the bits in a word associated with this protocol. The available options are <6>, <7> and <8> bits.

5.1.7.4 Stop

Users can specify the stop bit associated with this protocol. Options are <1> and <2> stop bits.

5.1.7.5 Parity

This item is used to specify the parity associated with this protocol. Options are <ODD>, <EVEN> and <None>.

5.1.8 Audio Output/Key Beep

Enter this menu to setup the audio output or key beep.

Audio Output/Key Beep	
1. Audio Output	Live/PB
2. Key Beep	ON

5.1.8.1 Audio Output

This item is used to set the audio output mode. The available options are as below.

<Live/PB>

Select this to play the recording sounds of live image in live mode, and sounds of recorded video in playback mode respectively.

<Always Live>

Select this to play live sounds in both live mode and playback mode.

<OFF>

Select this to disable the audio output function.

5.1.8.2 Key Beep

This item is used to enable or disable the key tone. Select <ON> to enable the key tone, or <OFF> to disable.

5.2 Monitor Setup

The Monitor Setup menu allows users to adjust the quality of the displayed image. Select <Monitor Setup> from the Main menu and press ENTER. The following menu is displayed.

Monitor Setup	
1. Show Camera Title	Yes
2. Screen Center Adjust	
3. VGA Resolution	800x600
4. Show Color Bar	Execute

5.2.1 Show Camera Title

This item allows users to choose whether to display the camera title on the screen or not. The default is <Yes>, which displays the camera titles with the video.

5.2.2 Screen Center Adjust

This item is used to adjust the screen center of the main monitor display area. Follow the steps to set the center point.

- Select <Screen Center Adjust> from the Monitor Setup menu and press ENTER. The adjusting screen is as follows.

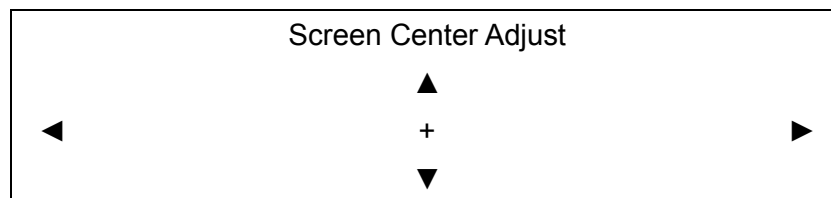

- Position the screen center position using the Direction keys.
- Press ENTER to exit when finished.

5.2.3 VGA Resolution

This item allows users to select appropriate VGA resolution for the VGA monitor connected to the DVR. The options are <800×600> (default), <1024×768> and <1280×1024>.



NOTE: If the selected VGA resolution is too high that the monitor cannot support, the message “No Signal” will be displayed. Then please press ESC on the front panel to restore the original setting.

5.2.4 Show Color Bar

Choose this item to display color bar pattern on the screen. The color bar helps to adjust the monitor hue, saturation, text color, and display options. Press ESC to exit the color bar pattern display and return to the OSD menu.

5.3 Camera Setup

The items in the Camera Setup menu enable users to set camera parameters, including camera title, dome protocol and ID for each connected camera.

Analog Camera	
1. Analog Camera Select	CH1
2. Dome Protocol	None
3. Dome ID	0
4. Camera Title	CH1
5. Covert	No
6. Brightness	0
7. Contrast	0
8. Saturation	0
9. Hue	0

5.3.1 Analog Camera Select

This item is used to select a camera for setting the parameters. The related settings will follow the selected camera, such as dome protocol and camera title. Move the cursor to <Analog Camera Select> and press ENTER, then select a channel using UP / DOWN keys.

5.3.2 Dome Protocol

If the connected camera is a dome camera, select the communication protocol associated with the dome camera using ENTER and Direction keys. The available protocol includes <Speco>, <DSCP>, <AD422>, <Pelco D>, <Pelco P>, <Fastrax 2>, <JVC>, <Panasonic_C> and <Panasonic_N>. The default is set to <None>.

5.3.3 Dome ID

This item is used to assign an ID number to the selected dome camera. Note that ID number must match the ID address set by the dome camera.

5.3.4 Camera Title

This item allows the users to change the title of each connected camera. By default, the titles of cameras are numbered from 1 through 16 respectively. The title will be displayed on screen after the changes of the titles are set.

Follow these steps to enter a new title for a camera.

- Move the cursor to <Camera Title> and press ENTER. A virtual keyboard with alphanumeric characters is displayed as below.

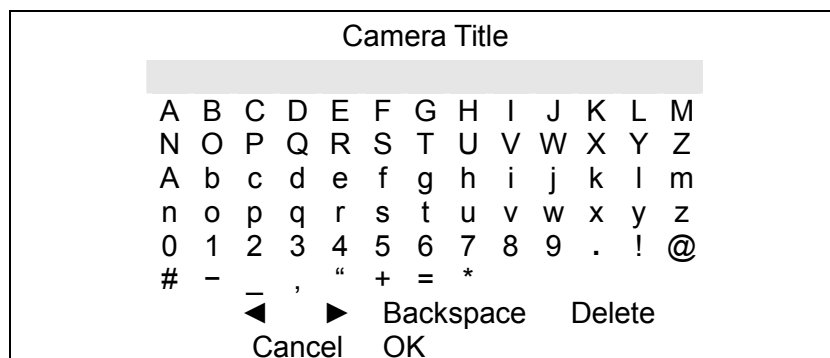

- Use Direction keys to select character.
- Press ENTER to add the selected character to the entry field.
- When it's done, move the cursor to <OK> and press ENTER to save the settings and exit.

5.3.5 Covert

This function allows users to set the specific camera to be covert while the DVR continues to record video. Choosing <Yes> means to cover the selected camera; and <No> to remain the specific camera non-covert.

5.3.6 Brightness

Select this item to adjust the brightness of the camera. Use UP / DOWN keys to adjust the numeric value. The range of brightness values is from <-128> to <127>.

5.3.7 Contrast

Select this item to adjust the contrast of the camera. Use UP / DOWN keys to adjust the value. The range of contrast values is from <-128> to <127>.

5.3.8 Saturation

Select this item to adjust the color saturation of the camera using UP / DOWN keys. This value will be ignored on monochrome monitors. The range of saturation values is <-128> to <127>.

5.3.9 Hue

Select this item to adjust the hue of the camera. Use UP / DOWN keys to adjust the value. The range of hue values is from <-128> to <127>.

5.4 Record Setup

The total record time of **DVR-4TL/8TL/16TL** will be effected by ***HDD capacity, recording rate (Picture per Second), image quality settings, and event settings.***

The greater the recording rate and the higher the quality setting, the shorter the recording time. Most of the related factors can be set here in this submenu.

The Record Setup menu allows user to set recording quality, recording schedules, and other recording parameters. Administrator's password is required to access Record Setup menu. In the Main menu, move the cursor to <Record Setup> and press ENTER. The following menu is displayed.

Record Setup	
1. Record Mode Setup	
2. Schedule Setup	
3. Preset Config	Best Quality
4. Per Camera Config	
5. ezRecord Setup	
6. Data Lifetime	0 Days
7. Circular Recording	ON
8. Audio Recording	ON
9. Purge Data	

5.4.1 Record Mode Setting

Enter this menu to setup record resolution. The relative record settings, such as preset configuration, will follow the record mode setting. The menu is displayed as the following.

Record Mode Setup	
1. Record Resolution	720*240
2. Record Format	H264
3. Max Rec. PPS	120

5.4.1.1 Record Resolution

Select resolution of the recorded video. If the recording is set to NTSC system, the selections are 720*480, 720*240, and 352*240. If the recording is set to PAL system, the selections are 720*576, 720*288, and 352*288.

5.4.1.2 Record Format

The record format will be H.264 compression.

5.4.1.3 Max Rec. PPS

This item will be automatically changed according to record resolution.

After the Record Mode settings are changed and the ESC is pressed to return to the previous menu, a warning message will be shown as below. Press ENTER to confirm the selection, or press ESC to abort.

!!Warning!!	
System will reboot	
Because of different record mode	
ENTER: Yes	ESC: No



NOTE: It is strongly recommended to backup the programmed configuration before making any changes on Record Mode settings.

5.4.2 Schedule Setup

This submenu is used to set the day and night time, or weekend recording schedule. The Day and Night schedules are for defining day time and night time; the Weekend schedule can be modified for weekends and holidays.

Select <Schedule Setup> from the Record Setup menu and press ENTER; the following menu is displayed.

Schedule Setup	
1. Day Time Start	AM 06:00
2. Day Time End	PM 18:00
3. Night Time Start	AM 06:00
4. Night Time End	PM 18:00
5. Weekend Schedule	ON
6. Weekend Start	Fri 18:00
7. Weekend End	Mon 06:00

5.4.2.1 Day / Night Time Start / End

The Day / Night Start / End Time determines the duration of day / night recording time. The time is indicated in 1-minute increments. The time display format in this menu is based on the setting of Time Display Mode in Date/Time menu.

5.4.2.2 Weekend Schedule

<Weekend Schedule> determines whether a weekend schedule is in effect. Choose <ON> to take effect the related weekend settings.

5.4.2.3 Weekend Start / End

<Weekend Start> indicates the specific day and time when weekend schedule should begin, for example, FRI 18:00. <Weekend End> indicates the specific day and time when weekend schedule should end, for example, MON 06:00. Time is indicated in 1-minute increments.

Note that the value users have set indicates when the regular Day and Night scheduling ends, and Weekend recording begins.

5.4.3 Preset Record Configuration

The <Preset Config> is used to select the preset recording quality and frame rate. Different preset recording quality levels are offered for users to choose: <Best Quality>, <Standard>, <Extended Record>, <Event Only>, <ezRecord >, <512Kbps DSL>, <256Kbps DSL>, <128Kbps DSL>, and <OFF>. According to various Record modes, the preset configuration options for normal and event status are described in terms of relative recording rate PPS (Picture Per Second) and recording size for each channel in the table below.

These preset conditions <Best Quality>, <Standard>, <Extended Record>, <Event Only>, <ezRecord >, <512Kbps DSL>, <256Kbps DSL>, and < selected, the channels not connected to cameras will not be recorded. In128Kbps DSL> override any other quality and rate settings. Refer to the table below for file sizes of different preset conditions for **DVR-16TL**. Note that <Event Only> and <ezRecord> are not included in the table because there are further details for these two settings. <Event Only> will be described in <Event Setup> section. <ezRecord> will be explained in <ezRecord Setup> section.

NTSC	720 X 480 @ 60PPS	720 X 240 @ 120PPS	360 X 240 @ 240PPS
PAL	720 X 576 @ 50PPS	720 X 288 @ 100PPS	360 X 288 @ 200PPS
Best	22 KB/Pic	12 KB/Pic	6 KB/Pic
Standard	14 KB/Pic	8 KB/Pic	4 KB/Pic
Extended	6 KB/Pic	4 KB/Pic	2 KB/Pic
512Kbps DSL		4 KB/Pic	
256Kbps DSL		3 KB/Pic	
128Kbps DSL		2 KB/Pic	



NOTE: The total PPS is equally shared by all channels, which means, even if one channel has not been connected with a camera, the channel still reserves its share of PPS. However, if <ezRecord> is other words, the total PPS will be shared by channels with cameras connected only.

5.4.4 Per Camera Configuration

This sub-menu is used to set the Day / Night / Weekend PPS and recording quality for each individual channel. <Preset Configuration> must be set to <OFF> in order to access these related settings. The menu is displayed as below in Record mode: 720×240@120PPS in NTSC / 720×288@100PPS in PAL (for **DVR-16TL**).

Per Camera Config			
Cameral Select	CH1		
	Day	Night	Weekend
Normal PPS	7.5	7.5	7.5
Normal Qlty	Mid	Mid	Mid
Event Max PPS	30	30	30
Event Qlty	Best	Best	Best
Event Act	Both	Both	Both

5.4.4.1 Camera Select

The item is used to select a desired channel for setting the parameters. Move the cursor to <Camera Select> and press ENTER, then select a channel using UP / DOWN keys. Press ENTER again to confirm the selection.

5.4.4.2 Normal PPS

Normal PPS is used to set the recording rate for normal status.

Please note that the total normal PPS of all channels cannot exceed the maximum PPS of each Record mode. To increase one channel's PPS, others' may have to be reduced first. Event PPS is not restricted to this rule, since a smart event scheduler will handle to the total PPS with a correct weighting. For example, if channel 1 is set to event mode with 30PPS, the remaining 30 PPS will be equally distributed to other 15 channels, which means each channel will be set to 2 PPS.

5.4.4.3 Normal Qlty

This item is used to set the picture size for normal status recording. The available options are: <Low>, <Fair>, <Mid>, <High> and <Best>.

5.4.4.4 Event Max PPS

<Event Max PPS> is used to set the event recording rate for Event status. Usually, the Event PPS is set equal to or greater than the Normal PPS. The setting is depending on users' application. If the Event PPS is set to <0>, **DVR-4TL/8TL/16TL** will not record event video when alarms triggered.

5.4.4.5 Event Qlty

This item is used to set the picture size for event status recording. The available options are: <Low>, <Fair>, <Mid>, <High> and <Best>.

5.4.4.6 Event Active

Users are allowed to choose which alarm type needs to be recorded. The available options are <Alarm> (alarm events only), <Motion> (motion detection events only) and <Both> (alarm event + motion detection), and <None>. The default setting is <Both>, which includes Alarm and Motion events recording.

5.4.5 ezRecord Setup

This item aims to ease the complicated record settings, and to make the setup much easier. Note that this item can be accessed only when <ezRecord> is selected as the option for <Preset Config>.

Select <ezRecord Setup> from <Record Setup> and press ENTER, the menu is displayed as below:

ezRecord Setup	
How Many Days To Record	2 Days
Daytime Record	Yes
Night Record	Yes
Weekend Record	Yes
Record Info	
Average Normal PPS	7.5
Average Normal Quality	Best

Follow these steps to Setup ezRecord:

- Select <How Many Days To Record> and press ENTER, then press UP/DOWN to select a desired number of days. The average normal PPS & quality will be adjusted automatically. The maximum recording days depends on the storage size of the HDD. In other words, the larger the storage size, the more days the DVR can record.
- Move to <Daytime Record> and press ENTER. This item is for users to select whether the DVR will record during daytime. If yes, use UP/DOWN to select <Yes> to enable daytime recording; or select <No> to disable.
- Repeat the same procedures for <Night Record> and <Weekend Record>, respectively. Note that <Weekend Record> will be inaccessible if <Weekend Schedule> in <Schedule Setup> is set to <OFF>.

- Select <Average Normal PPS> and press ENTER, then press UP/DOWN to choose a desired number of PPS. The <How Many Days To Record> will be computed automatically.
- Select <Average Normal Quality> and press ENTER, then press UP/DOWN to select a desired quality. The <How Many Days To Record> will be computed automatically.



NOTE: The current number of connected cameras will affect the recording quality automatically calculated by the <ezRecord Setup>. Therefore, when there are cameras disconnected or connected, the <ezRecord Setup> should be reset.

5.4.6 Data Lifetime

Data Lifetime indicates the duration that a video is saved and recallable in the HDD. Only those video recorded during Data Lifetime can be retrieved for playback. The video exceeded Data Lifetime will be hidden and cannot be retrieved for playback. Press ENTER to select this item in Record Setup menu, and then use UP / DOWN keys to set the data lifetime. The value ranges from <1> to <365> days, or select <0> to disable the function.



NOTE: If users want to playback a video which is beyond the data lifetime, please extend the duration till the recording data/time of the video is included.

5.4.7 Circular Recording

Users can choose to record video in circular mode or in linear mode. If circular mode (set to <ON>) is selected, the DVR will store new video data to overwrite the oldest recorded video. If linear mode (set to <OFF>) is selected instead, the DVR will stop recording when HDD capacity is full, and the internal buzzer will start beeping.

From the Record Setup menu, move the cursor to <Circular Recording> and press ENTER, then select <ON> / <OFF> using UP / DOWN keys.

5.4.8 Audio Recording

This item allows users to enable / disable Audio recording function of the DVR. When it's set to <ON>, audio input is recorded and saved with the video. When it's set to <OFF>, audio is ignored.

5.4.9 Purge Data

This item is used to delete the Normal or Event videos. In <Record Setup> menu, move the cursor to <Purge Data> and press ENTER. The <Purge Data> menu is shown as below.

Purge Data		
1. Purge All Data		No
2. Purge All Event Data		No
3. Purge Event Before	2008/01/01	
4. Start to Purge		No

5.4.7.1 Purge All Data

This item is used to delete all videos from the database. Use UP / DOWN keys to select <Yes> and start the deletion by setting <Start to Purge> to <Yes>.

5.4.7.2 Purge All Event Data

This item is used to delete all event videos from the database. Use UP / DOWN keys to select <Yes> and start the deletion by setting <Start to Purge> to <Yes>.

5.4.7.3 Purge Event Before

This item is used to delete event video before a specific date. Use LEFT / RIGHT keys to move the cursor to next or previous field, ENTER to select the item and UP / DOWN to adjust the value. Start the deletion by setting <Start to Purge> to <Yes>.

5.4.7.4 Start to Purge

After selected the videos to be deleted or chosen the date for deletion, set this item to <Yes> to start the deletion, or select <No> to cancel.

5.5 Sequence Setup

The Sequence Setup menu allows the user to set the camera sequence schedule and dwell time for main and call monitor. Select <Sequence Setup> in Main menu and press ENTER; the menu displays as follows.

Sequence Setup	
1. Main Monitor Dwell	5 Sec
2. Main Monitor Schedule	
3. Call Monitor Dwell	5 Sec
4. Call Monitor Schedule	

5.5.1 Main / Call Monitor Dwell

The main/ call monitor can be set to display full screen video of all installed cameras in sequence. This item is used to set the Main/ Call Monitor dwell time, which is the duration of time elapsed before switching to the next channel. The dwell time is in the range of 1 to 120 seconds.

5.5.2 Main / Call Monitor Schedule

This item is used to set displaying sequence of connected cameras to be displayed on the main/ call monitor in full-screen format. Move the cursor to <Main Monitor Schedule> and press ENTER. The menu is displayed as follows.

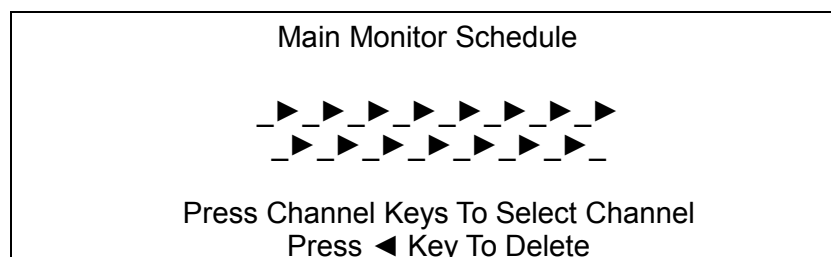

Follow these steps to set a sequence:

- Press LEFT direction key to delete the original setting.
- Press the desired Channel keys to assign the camera to the position where the cursor stops.
- Continue the steps until the sequence is completed.

The maximum number of entries in a sequence equals to the number of channels. Users can select fewer than the maximum entries for camera sequence and leave the remaining entries blank. The sequence can include a specific camera or cameras multiple times.

5.6 Event Setup

This menu allows users to determine **DVR-4TL/8TL/16TL** behavior in response to alarm events. In the Main menu, move the cursor to <Event Setup> and press ENTER. The following menu is displayed. Items in the Event Setup menu are described in the following subsections.

Event Setup	
1. Internal Buzzer	ON
2. Event Icon	ON
3. Email Notice	OFF
4. Email Attachment	OFF
5. Event Full Screen	None
6. Event Duration	20 Sec
7. Per Channel Config	

5.6.1 Internal Buzzer

This item allows users to enable / disable internal buzzer of **DVR-4TL/8TL/16TL**. If <ON> is selected, the buzzer is activated in response to alarm events. If <OFF> is selected, the buzzer is not activated.

5.6.2 Event Icon

This item enables (ON) / disables (OFF) the display of event icons on the monitor when alarm events occur. The event icons are represented by a character according to the event types respectively. Refer to the following table for association of event icons and event types.

Event Icon	Event Type
A	Alarm in event
M	Motion detection event
L	Video loss event

5.6.3 Email Notice

The item enables (ON) / disables (OFF) the Email notification of an event. When an alarm event is triggered and <Email Notice> is enabled, an e-mail concerning the alarm event will be sent.



NOTE: In order to send an event notification e-mail successfully, ensure that the DVR is connecting to the internet.

5.6.4 Email Notice

The function allows the DVR to send out a brief AVI video regarding the event. The number of the attached AVI video will be equivalent to the number of cameras connected to the DVR. For example, if the DVR has been connected with 8 cameras, then 8 videos will be attached to the notice email. The total size of the video will be about 2 MB.

Select <ON> to enable this function; or <OFF> to disable it.



NOTE: The video clips of the Email Attachment will ONLY be in *.avi format. Please download the Divx Player from www.divx.com to play the *.avi files.

5.6.5 Email Full Screen

This function allows the DVR to display the alarm channel in full screen size when an alarm is triggered.

Select <None> to disable this function; select <Main> to display the alarm channel on Main Monitor when an alarm is triggered; select <Call> to display the alarm channel on Call Monitor; and select <Both> to display the alarm channel on both Main Monitor and Call Monitor.

5.6.6 Event Duration

This item determines the duration of the buzzer and Alarm Out relay function after an alarm is triggered. The available event duration range is from 5 second to 999 seconds.

5.6.7 Per Channel Config

This menu is used to set the Video Loss Detect, Motion Detect and Alarm In / Out function for each channel. The menu is displayed as below.

Per Channel Config	
1. Channel Select	CH1
2. Video Loss Detect	OFF
3. Motion Detect	OFF
4. Motion Detect Indicator	ON
5. Detection Config	
6. Alarm In	OFF
7. Alarm Out	None

5.6.7.1 Channel Select

The item is used to select a desired channel for setting the parameters. Move the cursor to <Channel Select> and press ENTER, then select a channel using UP / DOWN keys. Press ENTER again to confirm the selection.

5.6.7.2 Video Loss Detect

This item allows users to enable or disable Video Loss as an alarm event. Select <ON> to enable Video Loss alarm events, or <OFF> to disable.

5.6.7.3 Motion Detect

This item allows users to enable or disable motion detection function of **DVR-4TL/8TL/16TL**. Select <ON> to enable Motion Detect alarm events, or <OFF> to disable. If motion detection function is enabled, it is required to define motion detection parameters such as detection area and sensitivity settings in <Detection Config>.

5.6.7.4 Motion Detect Indicator

This item allows users to display/ hide the motion detection indicators. Select <ON> to display the indicators, or <OFF> to hide them.

5.6.7.5 Detection Config

If motion detection function is enabled, it is required to define the motion detection parameters such as detection area and sensitivity settings. Select a channel for setting the parameters, move the cursor to <Detection Config> and press ENTER. The Detection Configuration menu displays as follows.

Detection Config	
1. Detected Area Setup	
2. Sensitivity	88%
3. Block Threshold	4

Detected Area Setup

After selected this item, the detected area is displayed as follows. The detection area consists of 192 (16×12) detection grids.

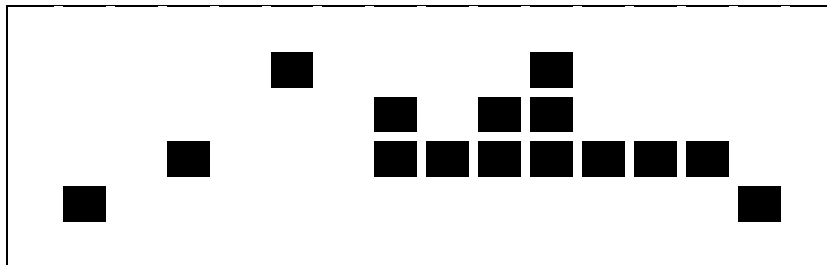

Use the Direction keys to move the cursor and press ENTER to select or de-select a grid. Press MODE to select all of the grids for detection; press MODE again to de-select all of the grids.

Sensitivity

This item is used to set the sensitivity of detection grids for the camera. A greater value indicates more sensitive motion detection. A motion alarm will be triggered once the amount of motion detected exceeds the Threshold value.

Move the cursor to <Sensitivity> and press ENTER, and then use UP/ DOWN keys to adjust the value. The value is increased by 4% increment.

Block Threshold

<Block Threshold> indicates the motion alarm triggered level; select from <1> to <16>. Selecting <1> means the DVR will trigger the alarm when one grid is detected; and selecting <16> means the DVR will trigger the alarm when 16 grids are detected. Move the cursor to <Block Threshold> and press ENTER, and then use UP / DOWN keys to adjust the value.

5.6.7.6 Alarm In

This item allows users to enable/ disable alarm input detection. According to users' application, select <N/O> (Normal Open) or <N/C> (Normal Close) to enable the alarm input detection, or select <OFF> to disable the detection.

If <N/C> is selected without installing any device, an alarm will be triggered and the Event Icon will always display on the monitor until the selection is changed to <N/O> or <OFF>, or when a device is installed.

5.6.7.7 Alarm Out

This item allows users to enable/ disable the alarm output on the selected channel to activate the relay. The signal can be a light or siren to caution an alarm event. Select <ON> to enable the alarm output, or <OFF> to disable.

5.7 Database Setup

The menu displays information of internal and external HDDs. In the main menu, select <Database Setup> and press ENTER. The following menu is displayed.

Database Setup	
1. Total Size	xxx GB
2. Free Size	(Circular)
3. Avail. Rec Time	(Circular)
4. Internal Disks	



NOTE: If the detection of HDDs fails, the message "HDD fail" will be displayed.

5.7.1 Total / Free Size of HDD

Total Size shows the total storage capacity of HDDs that have been added to the database. Free Size indicates free storage space available for recording in the database, or "Circular" will be shown if the DVR is set to record in circular mode. Both of them are "read only".

5.7.2 Available Recording Time

The Avail Rec. Time indicates the available time duration for recording. If the DVR is set to record in circular mode, the item will show "Circular". The information is "read only".

5.7.3 Internal Disks

Select <Internal Disks> to see information of the built-in HDDs. The menu is displayed as below.

Internal Disks		
Device Name	Active	Action
xxx xxxxxxxx-xxxxxx	Yes	None

The information of the built-in HDDs will be listed by model name and status. If no storage device is connected to the DVR, the message "No Available Items!" will be displayed.



NOTE: If the file system of the internal HDDs is not compatible for the DVR, the system will format the internal HDDs automatically without notice.

<Active>

This item indicates if the HDD is added to the database. <Yes> means the HDD has been added to the database.

<Action>

This item allows users to add the HDD to the database or remove it from the database. The options are <None> (no action), <Add> (add the selected HDD to the database), <Remove> (remove the selected HDD from the database), <Format> (format the selected HDD).



NOTE: Before disconnecting an external HDD from the DVR, **ALWAYS** remember to remove it from the database first.

5.8 Configuration

Users can restore factory default setting, import/ export configuration in the Configuration menu. Select <Configuration> from the main menu and press ENTER. The following menu is displayed. Items in this menu are described in the following subsections.

Configuration	
1. Load Factory Default	No
2. Import Config	
3. Export Config	

5.8.1 Load Factory Default

This item is used to load the factory default setting. Select <Yes> to restore the factory default setting from the read-only memory, or select <No> to cancel.

5.8.2 Import Configuration

This item allows users to load a DVR configuration that was saved in an external drive. To import a configuration that was previously exported, make sure the device with the saved configuration is connected to the DVR. Select <Import Config> from the Configuration menu and press ENTER. The following menu is displayed.

Import Config	
Config Name	Select
xxxx-xxxx	No
xxx-xx	No

Press UP/ DOWN to select one of the available configuration files, and choose <Yes> to start importing the configuration.



NOTE: If the record mode and/or number of IP cameras of the imported configuration are different from the DVR's configuration, the following message will be displayed.

Warning!! System will reboot if record mode and/or IP camera number differ.	
ENTER: Yes	ESC: No



NOTE: DO NOT remove the external device before the DVR completely reboots, otherwise it will be formatted.

5.8.3 Export Configuration

Users are allowed to save a DVR configuration by exporting it to an external drive, such as an USB Flash Drive. Before exporting the configuration, make sure the device in which the configuration will be saved is attached to the DVR appropriately. Select <Export Config> from the Configuration menu and press ENTER. The following menu is displayed. Items in this menu are described in the following sections.

Export Config	
1. Copy Destination	
2. Config Name	
3. Begin Export	No

5.8.3.1 Copy Destination

Enter this item to list available destinations (external storage devices) where the configuration can be exported. Press UP/ DOWN to select a destination. Please note that saving a different configuration to the same destination with the same file name will overwrite the previous configuration file without warning.

Copy Destination	
Device Name	Select
xxxx-xxxx	No



NOTE: It is not allowed to select the built-in DVD+RW as a copy destination.

5.8.3.2 Configuration Name

This item allows users to assign a name to the exported configuration file. Use the virtual keyboard to enter the configuration file name. Note that the file name can only contain up to 15 characters, with no spaces.

5.8.3.3 Begin Export

Select <Yes> to begin exporting the configuration file, or select <No> to exit.



NOTE: It is strongly recommended to export configuration before upgrading the DVR system. Also, backup the configuration routinely is recommended as well, just in case for unexpected situation.

5.9 Video Export

The Video Export menu enables the user to export recorded video with or without digital signature to a USB ThumbDrive, or to a DVD+RW drive. Make sure an external storage device is available and connected to the appropriate port for video export.

If the <Pre-Alarm Recording> function is enabled, the event video will be exported into two files, including pre-alarm video and video recorded after the alarm is triggered.

When recorded video is exported with digital signature, the output will be four files, including *.gpg, *.avi (*.drv), *.sig and readme.txt. Exporting a file whose size is 1GB with digital signature may take about 30 minutes.

From the Main menu, select <Video Export> and press ENTER. The following menu is displayed. Items in the menu will be described in the following section



NOTE: The inserted CD/DVD will be ejected when its capacity is 99% full.

Video Export			
1. Select Device			
2. Select Ch:		CH1 CH2 CH3 CH4	
3. From		2008/03/19 AM 07:50:05	
4. To		2008/03/28 PM 03:09:18	
5. Select Events			
6. Data Type			Normal
7. Export Format			DRV
8. Digital Signature			No
9. Erase Disc			No
10. Begin Export			No

5.9.1 Select Device

The available external devices for exporting video will be listed by name and free size in Select Device menu. The Select Device menu displays as follows.

Select Device		
Device Name	Available	Sel
xxx-xxx-x-x-xx	256 MB	No
xx-xxx-xx-xxxx	1.5 GB	No

DVR-4TL/8TL/16TL only supports EXT3 file system. Make sure the HDD format is EXT3 before connecting it with the unit. If not, please format the HDD to EXT3 format first.

<Device Name>

The item shows the name of the available device.

<Available>

The item shows the free space of the available device.

<Sel>

Set the item to <Yes> to set it as an exporting destination; or <No> to cancel.



NOTE: The item <Erase Disk> from Video Export menu will be grayed out when the selected device is not a DVD+RW or when the device is not selected yet.

5.9.2 Select Channel

The item is used to select channels for export. Move the cursor to the desired channel using LEFT / RIGHT keys, select or de-select a channel by pressing ENTER.

5.9.3 From / To Time

These items are used to set the time which data export begins and ends. Move the cursor using Direction keys, and press ENTER to select the date / time items; adjust the selected date and time value by UP / DOWN keys.



NOTE: When the Start / End Time are set, remember to select the exporting Data Type.

5.9.4 Select Events

Select the item to display the event list for exporting event video. Move the cursor to scroll the event list and press ENTER to select the events users want to export.

5.9.5 Data Type

The item is used to select exporting video type. The options are <Normal> (export normal video only), <Event> (export event video only) and <Both> (export both normal and event video).



NOTE: If users want to export selected event video using the item <Select Event>, users have to set <From> and <To> to the same day and time; otherwise, not only the selected event video will be exported to the selected destination, but also other event video recorded during the period between <From> and <To>.



NOTE: Users will not be allowed to access the <Select Events> if the Data Type is set to <Normal>.

5.9.6 Export Format

This item is for selecting exporting video format. The options are <DRV> and <AVI>.

The *.drv file can only be played back with Speco**Remote** and Speco**Player**, and multiple camera video can be played from one file. The *.avi file can be played back with Windows Media Player. Note that if multiple channels are exported, each channel is exported to a separate file.

5.9.7 Digital Signature

The Digital Signature function enables users to export video clip with the unit's unique signature key. It aims to authenticate that a video clip was exported from the unit and it has not been modified. Users can export video clip with or without a digital signature file (*.sig). Set the item to <Yes> to export with the signature file, or <No> to export without it.

Make sure there is an external storage device, such as a USB Hard Drive or USB ThumbDrive, available and connected to the appropriate port for export.

For more information on verifying digital signature, see section **Verify Digital Signature**.

5.9.8 Erase Disc

This function is used to remove information found on a DVD+RW disk prior to exporting new information to the drive. Select <Yes> and press ENTER to start deleting data.



NOTE: This item will be grayed out when the selected device is not a DVD recorder or when the device is not selected yet.

5.9.9 Begin Export

Select <Yes> and press ENTER to start exporting.

5.10 Shutdown

This item is used to shut down or reboot the unit. If users must shut down **DVR-4TL/8TL/16TL** for any reason, please follow the proper shut down and power on procedures to avoid any potential damages to the unit.

Select <Shutdown> in Main menu and press ENTER to access the Shutdown menu, which displays as follows.

Shutdown	
1. Power Off	Execute
2. Reboot	Execute

5.10.1 Power Off

Press ENTER on this item to shut down the unit. **Do not remove the power** during shut down until the message "You can safely turn off DVR now!" displays.

5.10.2 Reboot

Press ENTER on this item to reboot the unit. The color bar and system checking information are displayed on the monitor until the unit is completely restarted.

6. Remote Monitoring Software

The remote monitoring software **SpecoRemote** is a remote browser-based software application designed to operate with the DVR products. Using the software, users are allowed to view live and recorded video, and configure the DVRs remotely via a LAN, WAN or Internet on a personal computer.

The connected PC will automatically download **SpecoRemote** plug-ins from the DVR when the DVR is connected by entering its IP address in the address bar on the browser.

Due to the setting items are similar to those listed in the DVR's OSD setup menu, please refer to the chapter **Advanced System Configuration** for setting configuration of **SpecoRemote**.

The tasks can be performed with **SpecoRemote** are listed below:

- Remote viewing of live/ recorded video
- Remote setup of the DVR
- Remote control of dome cameras
- Alarm notification from the DVR
- Up to five connections to one DVR using **SpecoRemote**, including the preset "admin" and four other accounts

6.1 System Requirements

Items	Minimum Requirements
Personal Computer	Minimum: Intel® Pentium® M CPU 1.40GHz RAM 512 MB
	Recommended: Intel® Core™2 Quad CPU Q6600 @ 2.4GHZ RAM 2 GB
Hard Disk Drive	Requires 20 MB for software installation
Operating System	Windows XP, Windows Vista
Web Browser	Microsoft Internet Explorer version 6.0 or above
Monitor Resolution	Minimum 1024 x 768 with 16-bit color
Network Card	10Base-T (10 Mbps) or 100Base-TX (100 Mbps) operation; must match the network configuration

6.2 Installation of Software

Refer to the following description to install SpecoRemote.

6.2.1 Change Internet Settings

The PC operating with SpecoRemote should be set to accept ActiveX plug-ins. Please follow the steps to set the Internet security settings appropriately.

- Before operating SpecoRemote, please check the IP address of the DVR. To check the IP address, press MENU key on the unit and enter password to access OSD setup menu. Select <System Setup>, <Network Setup>, then <LAN Setup> to check the IP.
- Start the IE; it can be started either by clicking on the desktop icon, or by using the Start menu to access it.



NOTE: Windows IE provides the ActiveX component that is required when using SpecoRemote.

- Select <Tools> from the main menu of the browser, then <Internet Options>, and then click the <Security> tab.
- Select <Trusted sites> and click <Sites> to specify its security setting.

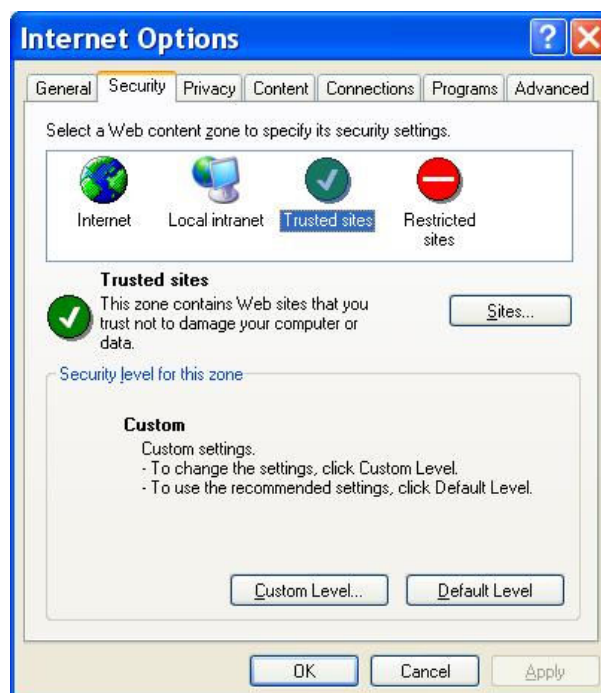

- Uncheck “Require server verification (https:) for all sites in this zone”. Type the IP address of the unit in field and click <Add> to add this web site to the zone.

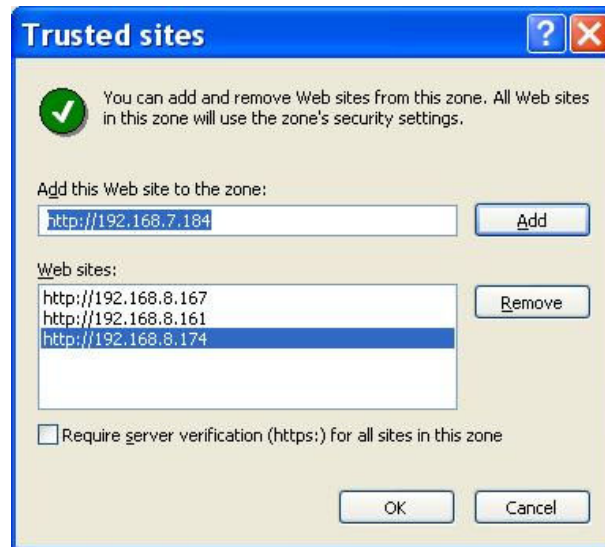

- Click <OK> to confirm the setting and close Trusted sites dialog.
- In the Security Level area, click <Custom Level>. The Security Settings screen is displayed.

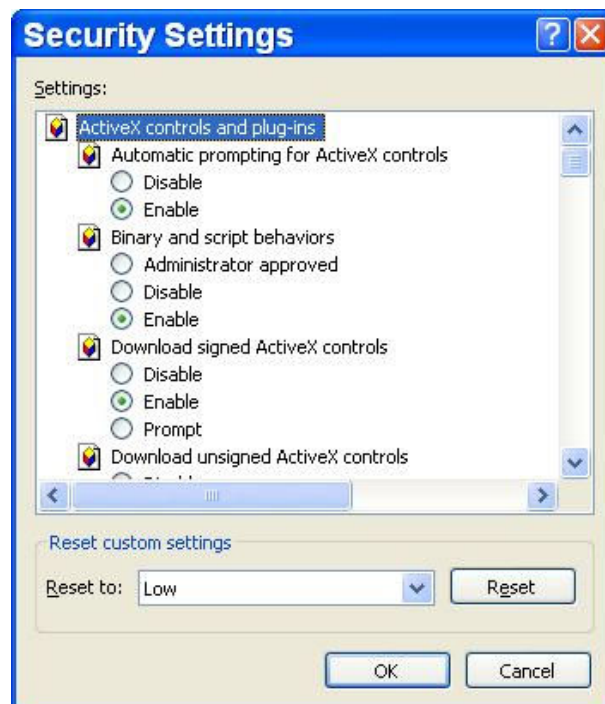

- Under <ActiveX controls and plug-ins>, set all items to <Enable> or <Prompt>.
- Click <OK> to apply the setting and close the <Security Settings> screen.
- Click <OK> to close Internet Options dialog.

Now the installation can continue to the next step.

6.2.2 Install SpecoRemote

Start the browser to initiate the installation of Speco**Remote** on the PC. The IP address of the DVR can be saved as a Favorites item in the web browser to enable easy access in the future.

- Start the IE; it can be started either by clicking on the desktop icon, or by using the Start menu to access it.
- Enter the IP address of the DVR in the address bar at the top of the browser.
- The ActiveX controls and plug-ins dialog will show twice for confirmation; click <Yes> to accept ActiveX plug-ins. Speco**Remote** plug-ins will be downloaded and installed on the PC automatically when the connection is successfully made.



NOTE: Do not enter any leading “0” characters in the address, for example, “192.068.080.006” should be entered as “192.68.80.6”. If the default trigger port 80 is changed into another one, take port 81 for example, the IP address should be entered as “192.68.80.6:81”.



- A version check starts to verify whether Speco**Remote** was installed already, and also check if the version is the same as that stored in that particular DVR. This process may take up to 30 seconds.
- When the software is completely downloaded and installed, the Login Screen is now displayed.



6.2.2.1 Login / Logout

Login using the same accounts setup in the DVR. The authority is also the same as setup in the DVR.

One preset account “admin” and up to four other accounts can access a DVR at the same time. Nevertheless, if the “admin” account is currently accessing the unit’s OSD setup menu via front panel of the unit, then the “admin” account at the remote monitoring site cannot change the settings at the same time. The “admin” account of the DVR has priority.



The following steps demonstrate procedures to view video from remote unit:

- Start Speco**Remote** by entering the IP Address of the DVR in the Address bar of the browser. Alternatively, click on the Favorite entry for the unit (if the IP address of the unit has been set).
- Enter the Username and password. The login username and password can be saved to ease future login. The default username and password is **admin / 1234**.
- Click <OK> to login to the DVR. The process may take a few seconds.
- If the connection is made successfully, the main window will display live video of the attached cameras.

If the IE browser is closed, the remote system is logout and disconnected from the DVR at the same time.

6.2.2.2 Software Upgrades

If a new version of Speco**Remote** is available on the DVR, upgrade will be prompted while accessing the unit. Follow the steps to upgrade the software.



- The message as the above figure will be prompted. Click <Yes> to accept version upgrade.
- Start the IE again and enter the IP address of the DVR in the Address bar of the browser; or if the unit address is set as a Favorite site, click the Favorites entry for the unit.
- When the software is completely downloaded and installed, the Login Screen will be displayed.

6.3 Basic Operation

When a DVR is successfully connected, the main window of Speco**Remote** will be displayed. Please refer to the **Setup Guide** for the graphical illustration of functional items.

The functions on Speco**Remote** will be described in the following sections.

6.3.1 View Live Video

View live video from the cameras attached to the DVR by clicking <Live> button on the main window toolbar. Choose desired display mode – full-screen, 2x2 windows, 3x3 windows, and 4x4 windows – after the live images of the DVR are displayed on the main window. When a dome camera is connected and viewed in single channel full-screen mode, the dome camera control operation can be accessed. To choose desired display mode and to operate dome camera control, refer to the following sections.

6.3.1.1 **Select Display Mode**

Choose the number of windows to be displayed on the main window. Click one of the display buttons in MODE section. Available selections are 4, 9 and 16 camera displays. To view certain window in full screen, either double-click on the wanted window, or click on the corresponding CAMERA button.

6.3.1.2 **Operating Cameras with Dome Control**

Speco**Remote** allows users to control and configure a dome camera remotely.

Click on any CAMERA button displayed with a dome icon to view the camera in full screen. The Dome Control Panel will be displayed on the main window. The items on the dome control panel are described as follows.

Set Preset (•)

Set Preset is used to set up preset positions. Speco**Remote** allows its user to set up to 255 preset positions with Speco, DSCP, American Dynamics, Fastrax, JVC, Panasonic (C & N), and Pelco (Pelco P & Pelco D) domes.

Use Direction buttons to move dome camera to an appropriate position, and then click the button and choose wanted number from the pull-down list. The preset position is named as the selected number.

Go Preset (•←)

Go Preset is used to call the camera preset point, which was set up with the set preset point function. Click and choose a number to call the preset point for viewing.

Auto Focus (A.F.)

Click on it and the focus of the camera will be automatically adjusted to show a clearer image.

Dome ID (ID)

Click for changing the dome ID and protocol. Proper authority is required to access this function.

Focus +/-

Use to adjust the camera lens to focus on objects for a clear view. Click on <Focus +> to focus near or <Focus -> to focus far.

Iris +/-

This item is used to open and close the iris to let more or less light into the camera. Click on <Iris +> to open iris or <Iris -> to close iris.

Zoom +/-

Users are allowed to zoom-in or zoom-out using the adjusting buttons. Zoom-in to enlarge a certain area and zoom-out to view more area.

Direction Button

This button is used to pan and/or tilt the dome camera. Click the arrows in the directions to be viewed.

6.3.2 Instant Recording

The Instant Recording function allows users to record video quickly to the PC.



NOTE: The Audio function is set to OFF as the default setting.

6.3.2.1 Record Video Instantly

Follow the steps to start recording instantly:

- Click on the <Instant Recording> button.
- Select the destination folder to save the video.
- Click on the button again to stop recording.



NOTE: The instant recording video will be saved as *.drv file.

6.3.2.2 Playback Instant Recorded Video

Follow the steps to playback a video recorded by “Instant Recording”.

- Click <Play> on main window toolbar and click <Local Playback> tab.
- Click <Open> to choose a recorded file.
- Click <OK> to start playing the recorded video.

6.3.3 Playback Video

Speco**Remote** allows users to view recorded video either from the DVR, or from the hard disk drive of the PC

To access the Playback screen, click <Play> button on the main window toolbar. There are three tabs in the Playback screen: <Remote Playback>, <Local Playback>, and <Verify> tabs. <Remote Playback> allows users to play back from the DVR. <Local Playback> enables users to playback a recorded video file stored on the hard disk drive of the PC. <Verify> is provided for users to authenticate if the exported video is altered.

The DVR continues recording while playing back recorded video on the PC, either remote playback or local playback.

6.3.3.1 Playback Remote Video

To view remote video, click <Play> on the main window toolbar, and then <Remote Playback> tab. The <Remote Playback> screen will be displayed.

The <From> and <To> in the <Available Record Video> display the date and time from which recorded video is available for playback.

To playback remote video segments, follow these steps:

- Choose <Playback> in <Select> field for playback recorded video.
- In <Start> field, users can change the date and time either by typing desired numbers directly or using the arrow buttons.

To type directly:

Click on day, month and year of date field respectively, and type the desired numbers directly. Follow above steps to adjust the hour, minute and second of time field.

To use the arrow buttons:

Click on the arrow button next to the date field to display the calendar; then click the left and right arrow at the top of the calendar to change the date. Use up and down arrow next to the time field to change to the wanted time.

- The other way to select date and time is by moving the blue sliding bar.
- Click <OK> to start the playback, or click <Close> to abort.

- The other option <Download (.DRV)> in <Select> field enables users to download the video segment of selected date and time to the PC. The selection of time duration is the same as described above. Files downloaded will be in *.drv format.

6.3.3.2 Playback Local *.drv Files



The <Local Playback> tab allows users to playback *.drv video files stored in the PC's hard drive.

Follow below steps to playback a downloaded *.drv file with Speco**Remote**.

- Click <Open> and the file selection screen is displayed.
- Select the *.drv video file for playback and click <OK>.
- Click <OK> in the <Local Playback> Screen to start the playback, or click <Cancel> to abort.
- View the video playback using the Playback controls.
- To end the playback, click <Live> to return to live video.

6.3.3.3 Playback Controls

When the local or remote video is being played, Speco**Remote** is in Playback Mode. The playback controls toolbar will emerge on the main window toolbar. The Playback controls and indicators are described as below.

Icon	Name	Description
	Fast Backward / Step Backward	<ol style="list-style-type: none"> 1. Click to play the recorded video in backward direction. Click repeatedly to select the backward playback speed: 1x, 2x, 4x, 8x, 16x, or 32x. 2. When playback is paused, click repeatedly to move backward step-by-step.
	Play / Pause	<ol style="list-style-type: none"> 1. While playing, click to pause the playback. 2. When paused, click to resume the playback.
	Fast Forward / Step Forward	<ol style="list-style-type: none"> 1. Click to play the recorded video in forward direction. Click repeatedly to select the forward playback speed: 1x, 2x, 4x, 8x, 16x, or 32x. 2. When playback is paused, click repeatedly to move forward step-by-step.

6.3.4 Verify Digital Signature

The digital signature aims to authenticate a video file exported from the unit. Follow the description to verify the digital signature.

- Click <Play> on the main window toolbar.
- Click <Verify> tab to display the Verify window.
- Click <Browse> to select the *.gpg, *.avi, *.sig files respectively, which belong to the exported video to be authenticated.
- Click <Verify> to start verifying digital signature.
- The result of verify shows in the <Status Log> field. It returns a GOOD or BAD signature result. A GOOD signature indicates the exported clip has not been altered.

6.3.5 Search from Event List

Click SEARCH, the Event List appears. The List contains information about the alarm events that the unit recorded and saved. Up to 1024 events can be listed in the Event List.

The Event List displays each event by its number, the date and time of the event, the type of the event (including Alarm In, Motion Detection, Video Loss, and Over Speed), and the camera channel where the event occurred.

To view an event video, follow these steps:

- Click SEARCH button positioned in the main window toolbar. The Event List appears.
- Scroll through the Event List and highlight the interested events.
- Double-click on the desired event to view the event video.

6.3.6 Take a Snapshot

Snapshot is a simple screen capture tool. When users click on the SNAPSHOT button, it will capture the screenshot of the window that is currently showing on the screen. Each click captures one screenshot to be saved as a JPEG file on the desktop. The snapshot file will be named as "Snapshot-*".

6.3.7 Health Status

This function verifies the HDD status of the DVR. The information items in the status chart are described as below.

Device Name

This item shows the model name of the HDD.

Int./Ext.

This item indicates whether the HDD is an internal or external device.

Total Size

This item indicates the total size of the HDD.

State

This item indicates whether the HDD is active or non-active.

Temperature

This item indicates the current temperature of the HDD in Celsius degree.

6.3.8 Remote Monitoring Software Trouble Shooting Guide

What happened if the server requests to upgrade the software every time the DVR is connected? If the following screen displays repeatedly, please follow the steps to delete the temporary internet files.



- Select <Tools> from the main menu of the web browser, then <Internet Options>, and then click the <General> tab.



- Click the <Delete Files> button in the <Temporary Internet Files> field; the <Delete Files> screen displays as below.



- Check the <Delete all offline content> box and click <OK>.
- Now, enter the IP address of the DVR to make the connection again.

Appendix A: Recommended HDDs

Refer to the following list for some recommended HDDs to be used in the DVR.

Brand	Model Name	Model Number	Size
Seagate	Barracuda ES.2	ST3500320NS	500G
	Barracuda 7200.11	ST3500320AS	500G
	Barracuda 7200.11	ST3750330AS	750G
	Barracuda 7200.11	ST31000340AS	1000G
HITACHI	DeskStar	HDP725032GLA360	320G
	DeskStar	HDP725050GLA360	500G
Maxtor	DiamondMax 22	STM3500320AS	500G
Western Digital	WD AV	WD1600AVJS	160G
	WD AV	WD2500AVJS	250G
	WD AV	WD3200AVJS	320G
	WD AV	WD5000AVJS	500G
	WD AV	WD7500AVVS	750G

Appendix B: Remote Controller

The operational function keys on the remote control are listed as below figure:

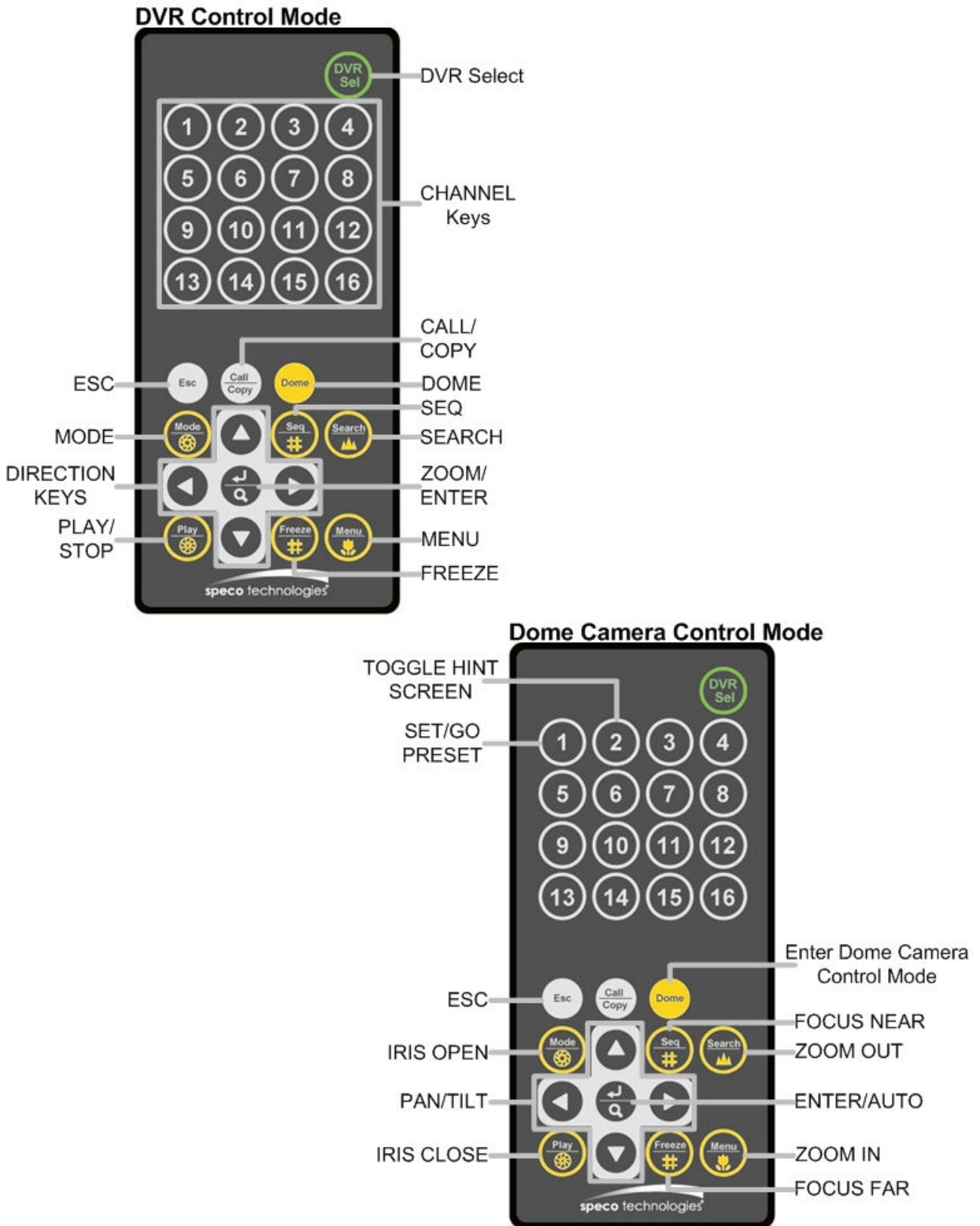

The keys of the remote control function as the keys of the front panel of the DVR. The only difference between the remote control and the front panel keys is the "DVR SEL" key. The DVR Selection key is used to switch control between each DVR.

The remote control can be used to control up to 16 DVRs. To setup the remote control, the first thing is to assign a unique DVR Unit ID to each DVR.

Use the front panel of the DVR, and follow this path to change the DVR Unit ID, <Main Menu> → <System Setup> → <RS485 Setup> → <Unit ID>. Change the DVR Unit ID to any number between 224 and 239, and exit the menu.

The ID Table is listed below for reference.

DVR Unit ID	224	225	226	227	228	229	230	231
Remote Control #	1	2	3	4	5	6	7	8

DVR Unit ID	232	233	234	235	236	237	238	239
Remote Control #	9	10	11	12	13	14	15	16

After the DVR Unit ID is changed, setup the "DVR SEL" of the remote control. Press "DVR SEL", and then press the Remote Control # immediately to select the DVR. For example, assuming the DVR Unit ID is set to 225, press "DVR SEL" and then press "2" immediately. Now, the remote control will only be able to control the specified DVR. Press "DVR SEL", and then press the Remote control # to switch between DVRs.

To exit the single DVR Control mode, press "DVR SEL", and then press "ESC" to do so.

Appendix C: Setting up a DVR behind a Router

This appendix describes how to set up a router if the DVR connects to the internet via a router.

To properly operate a web server, e.g. a DVR, users have to set up both the IP and port of the DVR, which are essential for data and command transmission. The port setting is adjustable in OSD setup menu of the DVR and only one port is needed to do remote operation. Typically and by the default, the DVR operates on port 80, which is well known as the http port. Please make sure that port 80 is not blocked by the ISP. Otherwise, a different available port shall be reset and the setting of the DVR shall be changed.



In case a router or sometimes a DSL modem is in place, the real IP is now assigned to the router instead of the DVR. The DVR is located behind the wall (router) and operates on virtual IP. In most cases, virtual IP starts with 192.168.x.x. The router has two IP: one is real IP (WAN IP); the other is virtual IP (LAN IP). The virtual IP would be 192.168.x.1. When the remote users want to operate the DVR, they will have to send command to the real IP, i.e. the router. Then the router has to map (forward) the command to the DVR. Thus, it is required to set up the router for port mapping (forwarding) before images from the DVR can be remotely viewed on a PC.

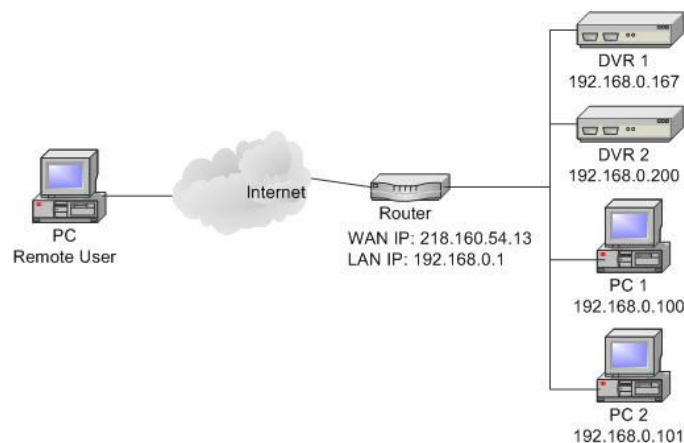

See the router manufacturer's websites for more instructions on port mapping.

Following is an example of how the router should be set.

Router	PC	DVR 1	DVR 2
(D-Link DI-724P+) WAN IP: 218.160.54.13 LAN IP: 192.168.0.1	IP: 192.168.0.100	IP: 192.168.0.167 Trigger port: 80	IP: 192.168.0.200 Trigger port: 81

- To change the setting of the router, a PC with web browser is required.
- Connect to D-Link DI-724P+ from PC via IE. The setup screen will be shown after entering the correct username and password.

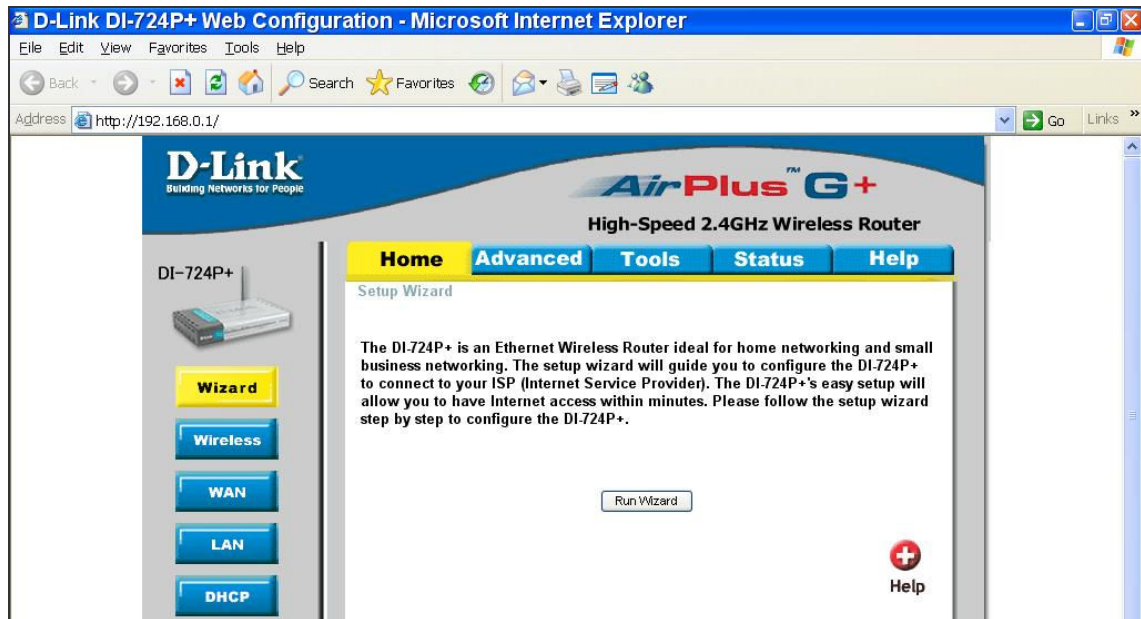

- Click the <Advanced> tab and follow the steps to set up web port forward to DVR 1.

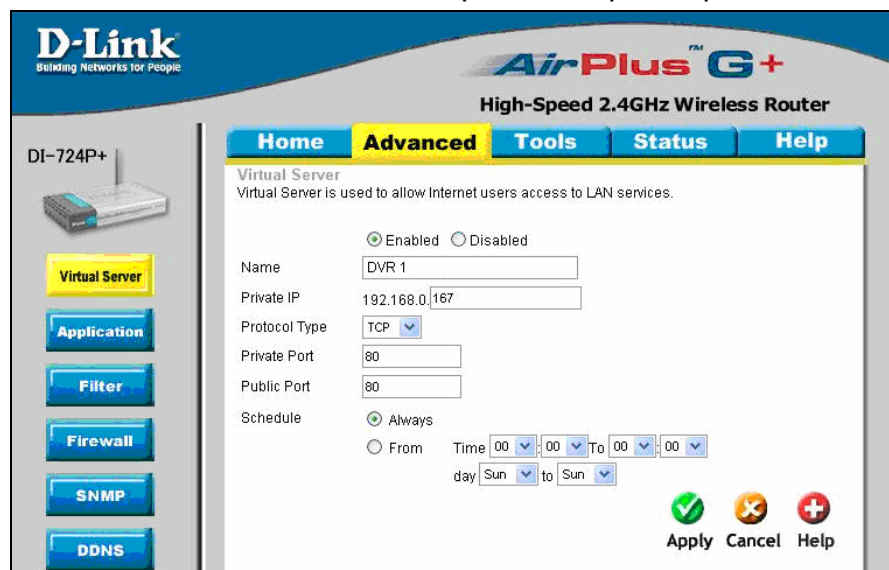

- A. Select <Enabled> to set up the service.
 - B. Enter the name of the setting in the Name field: DVR 1.
 - C. Enter Private IP: 167
 - D. Choose <TCP> as the Protocol Type.
 - E. Enter Private Port: 80.
 - F. Enter Public Port: 80.
 - G. Click <Always> for the Schedule setting.
 - H. Click <Apply>.
- Click <Continue> to go on when the following screen displays.

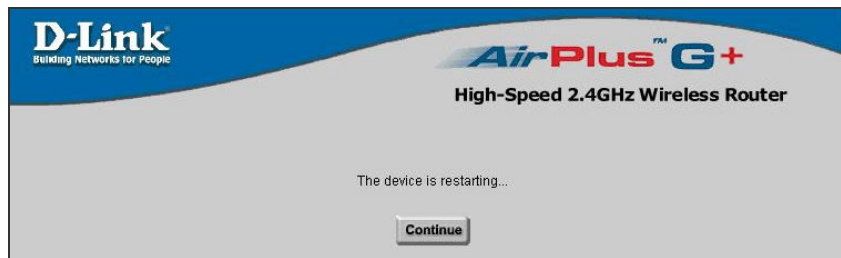

- Follow the steps to set up web port forward to DVR 2.
 - A. Click <Enabled> to set up the service.
 - B. Enter the name of the setting in the Name field: DVR 2.
 - C. Enter Private IP: 200
 - D. Choose <TCP> as the Protocol Type.
 - E. Enter Private Port: 81.
 - F. Enter Public Port: 81.
 - G. Click <Always> for the Schedule setting.
 - H. Click <Apply>.
- Now DVR 1 can be connected via <http://218.160.54.13:80> and DVR 2 can be connected via <http://218.160.54.13:81>.
- If there are more than one DVR behind the router, repeat the steps for port mapping setting.

Free Manuals Download Website

<http://myh66.com>

<http://usermanuals.us>

<http://www.somanuals.com>

<http://www.4manuals.cc>

<http://www.manual-lib.com>

<http://www.404manual.com>

<http://www.luxmanual.com>

<http://aubethermostatmanual.com>

Golf course search by state

<http://golfingnear.com>

Email search by domain

<http://emailbydomain.com>

Auto manuals search

<http://auto.somanuals.com>

TV manuals search

<http://tv.somanuals.com>