



# **EZVR4/8 DVR**

**SATA HDD**

---

## **User's Manual**

**Speco Technologies**  
**200 New Highway**  
**Amityville, NY 11701**  
**800-645-5516**  
***www.specotech.com***





## Safety Precautions

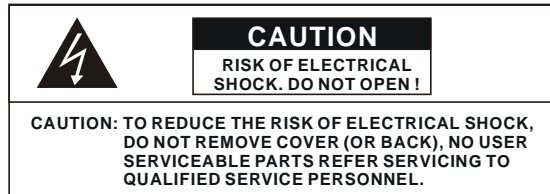

The lightning flash with arrowhead symbol, within an equilateral triangle, is intended to alert the user to the presence of insulated dangerous Voltage within the product's enclosure that may be of sufficient magnitude to constitute risk of electrical shock to persons.



The exclamation point within an equilateral triangle is intended to alert the user to the presence of important operational and maintenance (servicing) instructions in the literature accompanying the appliance.

**WARNING: TO PREVENT FIRE OR SHOCK HAZARD, DO NOT EXPOSE UNITS NOT SPECIFICALLY DESIGNED FOR OUTDOOR USE TO RAIN OR MOISTURE.**



Attention: Installation should be performed by qualified service Personnel only in accordance with the National Electrical Code or applicable local codes.



Power Disconnect. Units with or without ON-OFF switches have power supplied to the unit whenever the power cord is inserted into the power source, however, the unit is operational only when the ON-OFF switch is the ON position. The power cord is the main power disconnect for all units.

Warranty  
and Service

There are no user serviceable parts for this unit, call the factory for service details.

## About this document

Before installing the unit, be sure to thoroughly review and follow the instructions in this User's Manual. Pay particular attention to the parts that are marked **NOTICE**.

When connecting with external application, first turn the power OFF and follow manual instructions for appropriate installation.

## Before reading this document

1. This manual contains information for configuring, managing and using the EZVR DVR.
2. To prevent fire or electrical shock, do not expose the product to heat or moisture
4. Be sure to read this manual before operating the unit.
5. For questions and technical assistance of this product contact your local dealer.

► Strong recommendation on installation of the unit

1. Confirm that electricity at the place you want to install the EZVR DVR is stable and meets the electrical requirements. Unstable electricity can cause malfunctions of the unit or give critical damage to the unit.
2. Several chips on the main board of the unit and hard disk drive inside the unit generate heat which must be properly discharged. Do not place any objects adjacent to the ventilation openings on the sides of the unit.
3. Put the EZVR DVR in a well-ventilated place and do not put heat-generating objects on the unit.

**FCC Statement:**

**WARNING**

This device complies with Part 15 of the FCC Rules. Operation is subject to the following two conditions: (1) This device may not cause harmful interference. (2) This device must accept any interference received including interference that may cause undesired operation."

**\* Federal Communications Commission (FCC) Statement**

**WARNING**

This Equipment has been tested and found to comply with the limits for a Class B digital device, pursuant to Part 15 of the FCC rules. These limits are designed to provide reasonable protection against harmful interference in a residential installation. This equipment generates, uses and can radiate radio frequency energy and, if not installed and used in accordance with the instructions, may cause harmful interference to radio communications. However, there is no guarantee that interference will not occur in a particular installation. If this equipment does cause harmful interference to radio or television reception, which can be determined by turning the equipment off and on, the user is encouraged to try to correct the interference by one or more of the following measures:

- Reorient or relocate the receiving antenna.
- Increase the separation between the equipment and receiver.
- Connect the equipment into an outlet on a circuit different from that to which the receiver is connected.
- Consult the dealer or an experienced radio/TV technician for help.

\* You are cautioned that changes or modifications not expressly approved by the party responsible for compliance could void your authority to operate the equipment.

## INSTALLATION

### 1. The package

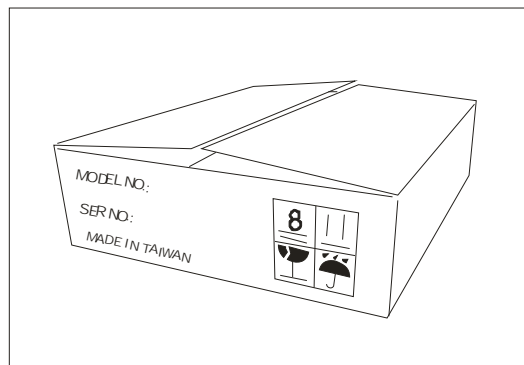

### 2. Un-packed

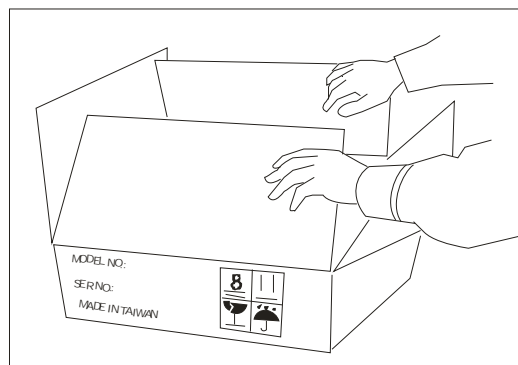

### 3. Take the unit out from the package

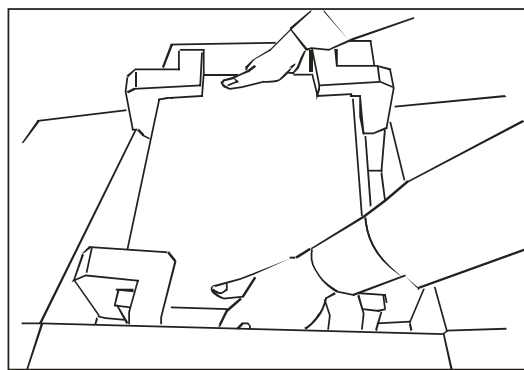

### 4. Put on a flat desk

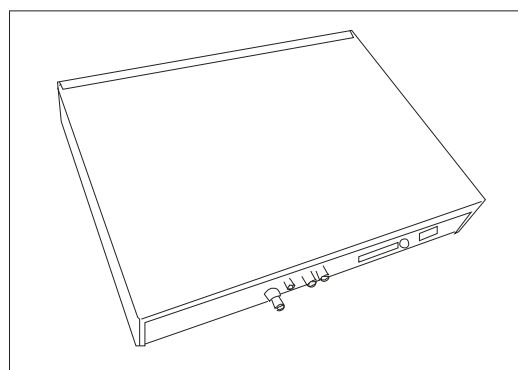

### 5. Connect your camera cables to the BNC connectors on the rear.

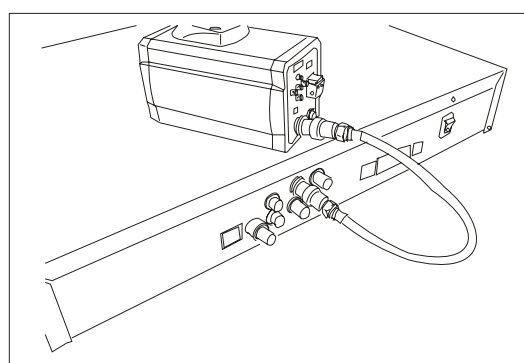

### 6. Connect your monitor cable to the BNC connector labeled "Monitor" on the rear.

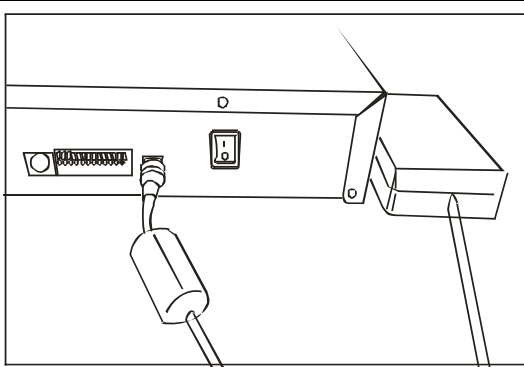
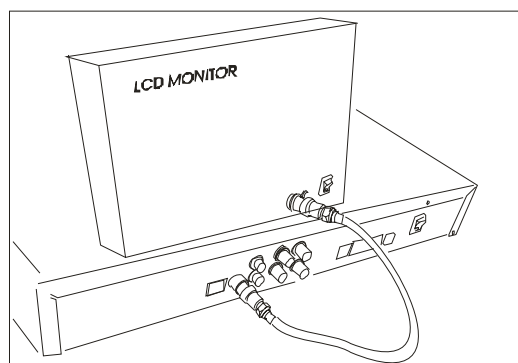

### 7. Connect the power adaptor.

### 8. Turn on the "Power" switch after the cameras are installed. The EZVR will then "boot" up and begin recording.

## FRONT PANEL KEYPAD

Please operate the keypad function according to the DVR model that you purchased

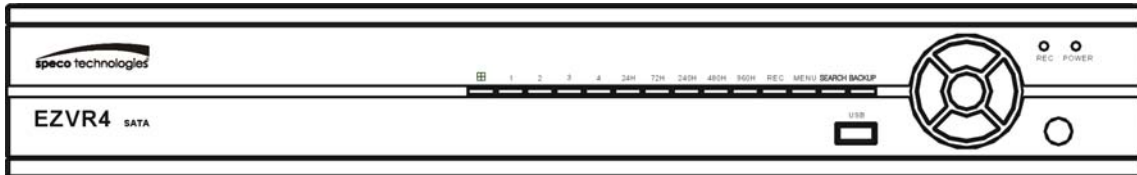

### Screen mode

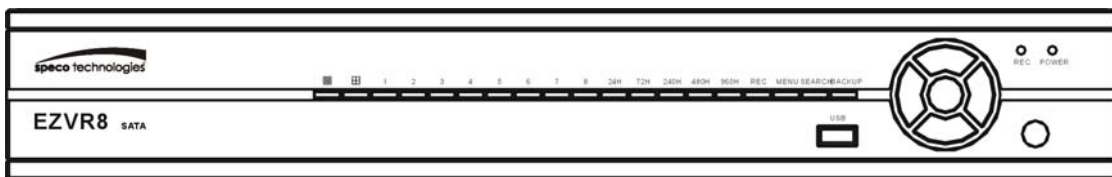

#### EZVR4

1.  : Quad screen mode button
2. **CHANNEL 1** : Channel 1 full screen button
3. **CHANNEL 2** : Channel 2 full screen button
4. **CHANNEL 3** : Channel 3 full screen button
5. **CHANNEL 4** : Channel 4 full screen button



### Screen mode

#### EZVR8

1.  /  : Split screen mode button
2. **CHANNEL 1** : Channel 1 full screen button
3. **CHANNEL 2** : Channel 2 full screen button
4. **CHANNEL 3** : Channel 3 full screen button
5. **CHANNEL 4** : Channel 4 full screen button
6. **CHANNEL 5** : Channel 5 full screen button
7. **CHANNEL 6** : Channel 6 full screen button
8. **CHANNEL 7** : Channel 7 full screen button
9. **CHANNEL 8** : Channel 8 full screen button

## Record mode

---

### EZVR4 / EZVR8

1. **24H** : 24 hour recording mode
2. **72H** : 72 hour recording mode
3. **240H** : 240 hour recording mode
4. **480H** : 480 hour recording mode
5. **960H** : 960 hour recording mode
6. **REC** : Press this button to start recording. Press again to stop.

## Miscellaneous

---

### EZVR4 / EZVR8

1. **MENU** : Press this button to display the menu setup
2. **SEARCH** : Press this button to search for a specific playback time
3. **BACKUP** : Copies Playback video onto a USB device
4. **UP / STOP** : Move cursor UP - Stop button in Playback ▲ / ■  
Also: In live mode Press the UP button for 5 seconds to lock the front panel buttons. Repeat to unlock.
5. **DOWN / PAUSE** : Move Cursor down - Pause in Playback ▼ / ■■
6. **REW** : Reverse playback – Playback speed – Frame by frame ◀ / ◀◀
7. **FF** : Forward playback – Playback speed – Frame by frame ▶ / ▶▶
8. **ENTER** : Enter button - Value change in menus



## REAR PANEL CONNECTOR

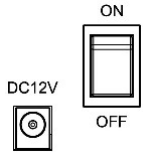
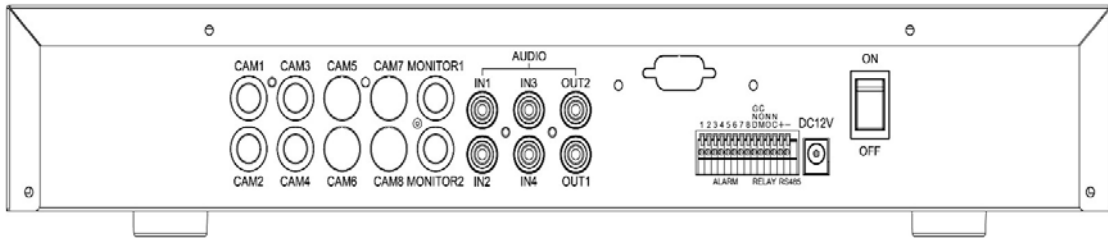

Power cord in 12VDC / 5A, Power Switch (ON / OFF)

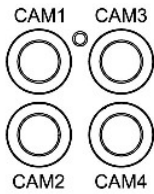

EZVR4: Camera 1 ~ 4 input BNC type

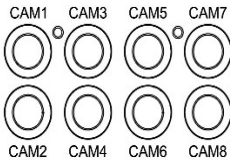

EZVR8: Camera 1 ~ 8 input BNC type

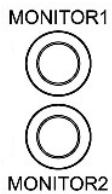

Main monitor output x 2

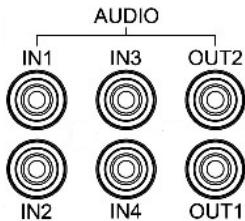

Audio channel input x 4 and output x 2 – RCA Type

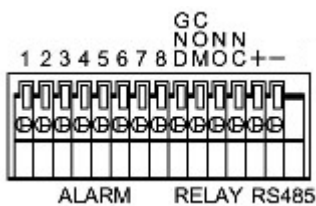

Alarm / Relay / RS485 connector

## Booting Up



## Detecting the hard disk

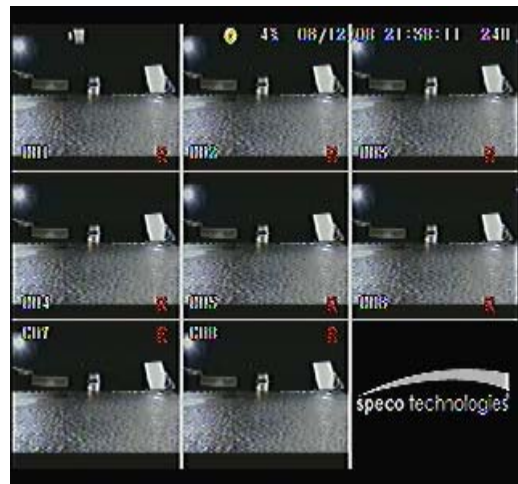

Live screen

## Indicator:

---

### Live:



HDD installed



Recording



Overwrite



Live mode



Video loss



Key lock



Alarm Input



Alarm Output

### Playback:



Forward



Reverse



Pause

## Remote controller

The keys on the remote control have the same functions as the front keyboard of the unit.

User please operate according to the DVR model that you purchased



4CH



8CH

## Main MENU – Time Setup

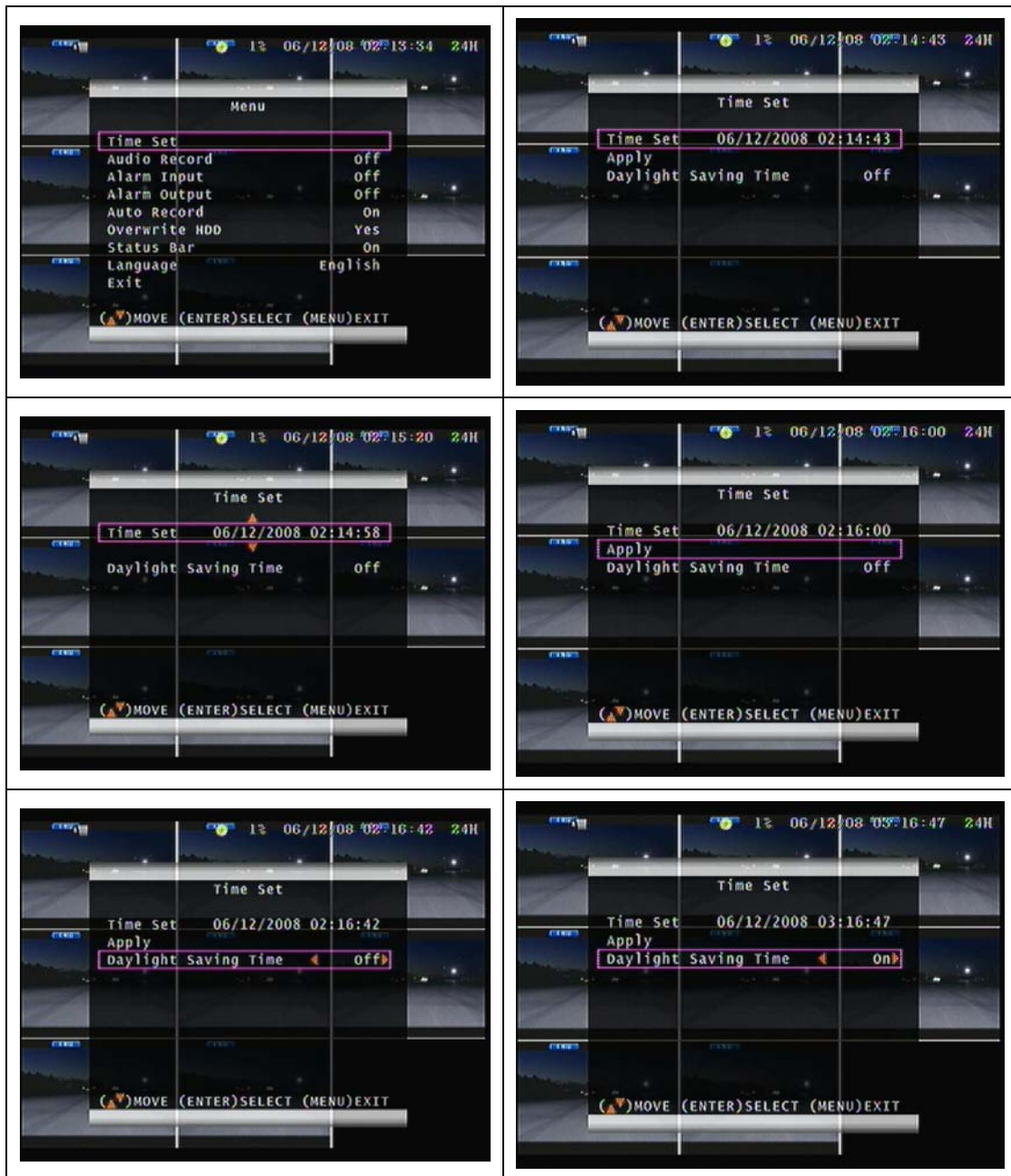

1. Press ENTER to select Time Set. Press ENTER again to display the cursor.
2. Use the left or right buttons to select the item you wish to adjust, then press ENTER to change the value.
3. Press MENU to return to the previous screen and move the cursor to Apply.
4. Press ENTER to confirm.
5. Select On or Off for Daylight Savings Time. Once the time is initially set, changing the DST mode will adjust the time appropriately.

## Main MENU – Audio Record

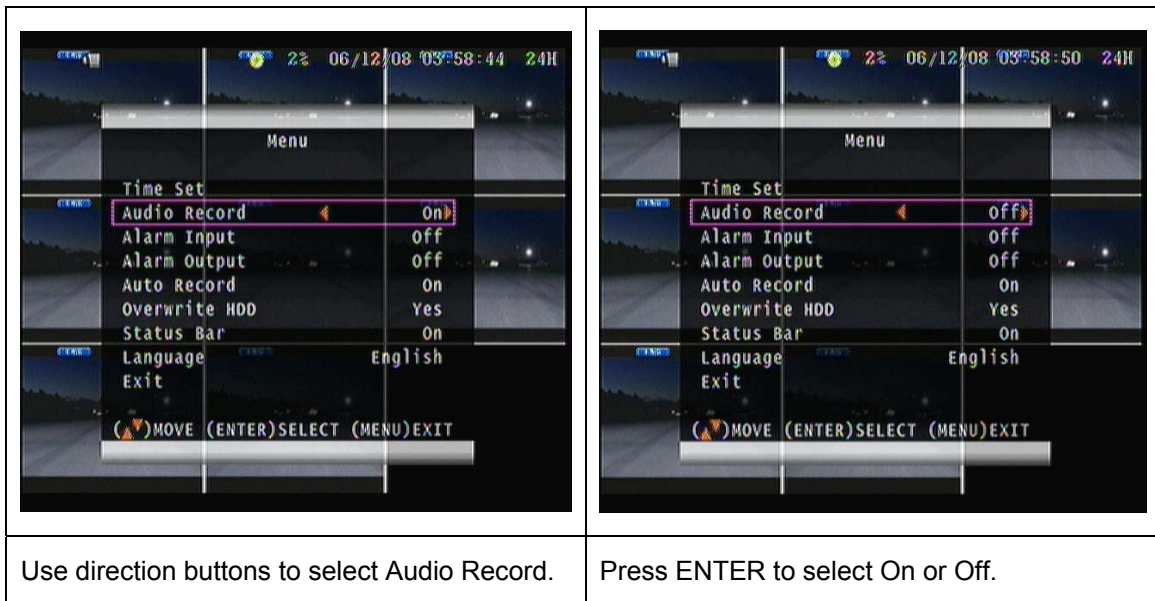

## Diagram

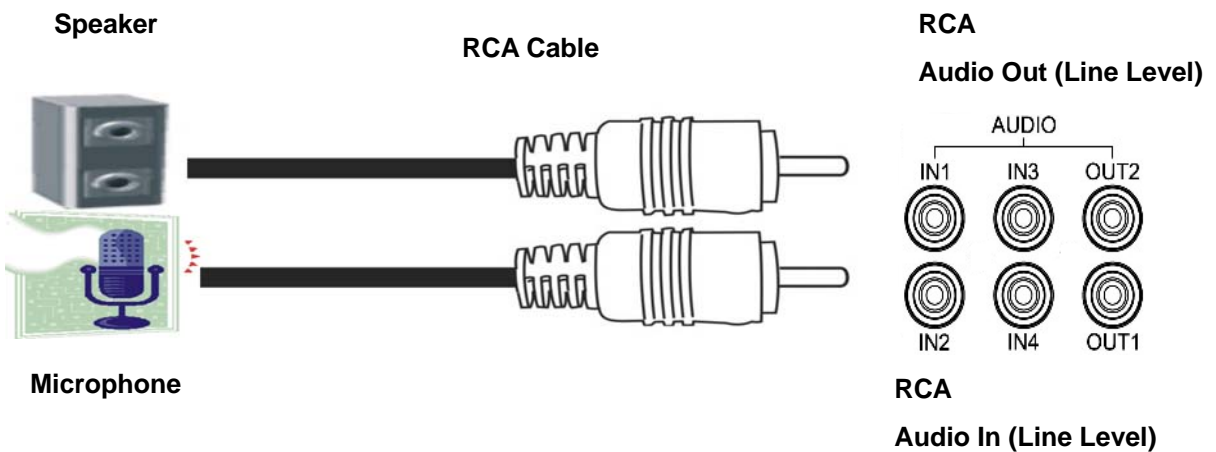

### Notice:

1. Audio channel input x 4 and output x 2
2. Audio is always on input 1 when DVR is on QUAD screen of live/playback mode
3. To hear audio input 1 ~ 4, please select full screen 1 ~ 4 on live/playback mode
4. When 960H is selected in the 8CH(EZVR8), the Audio Record will automatically shut down

## Main MENU – Alarm Input

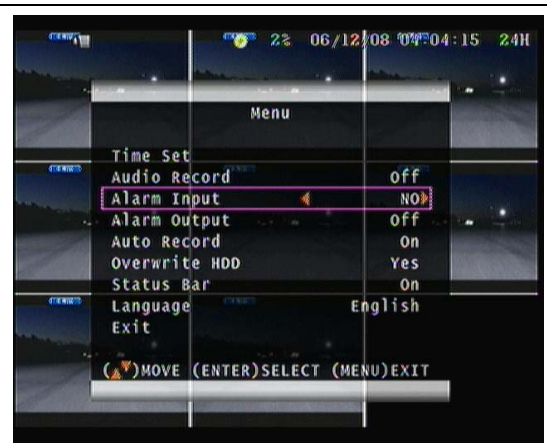
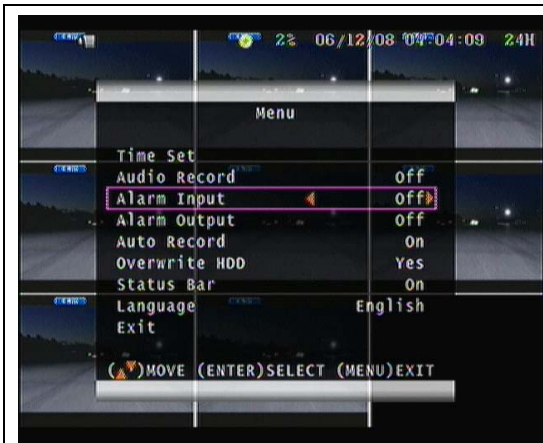

Use direction buttons to select Alarm Input.

Press the Enter button to choose the type of sensor input (Normally Open - NO or Normally Closed - NC).

To disable the alarm mode switch to the Off position..

## Main MENU – Alarm Output

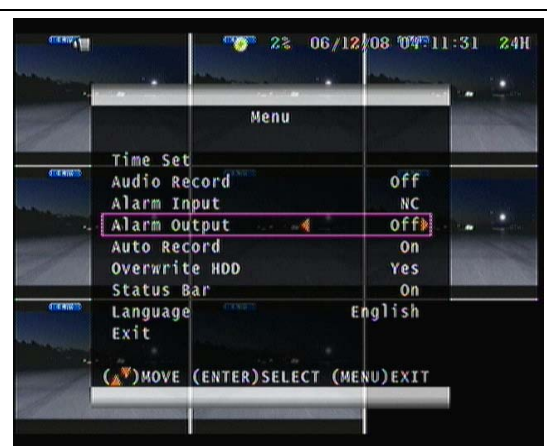
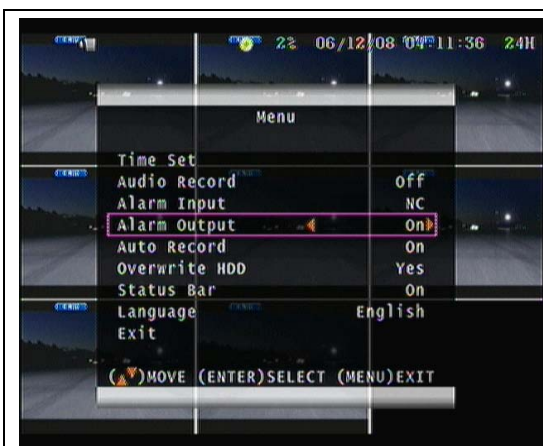

Use direction buttons to select Alarm Output.

Press the Enter button to turn the output relay on or off.

When switched to Off the alarm output is disabled.

## Alarm Input

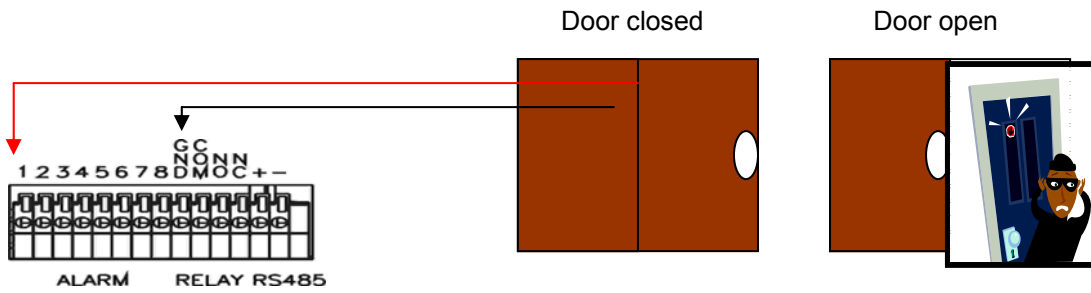

The Alarm Signal type depends upon the Alarm Sensor polarity defined as NO (Normal Open) or NC (Normal Close).

## Alarm Output:

Relay: NO + COM or NC + COM

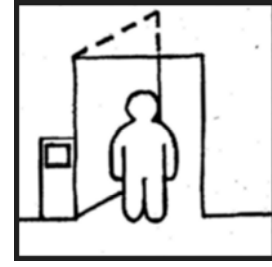
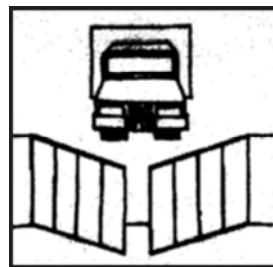
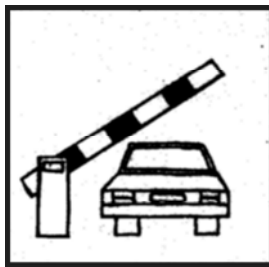

Relay: NO (Normal open)

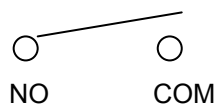

Alarm trigger

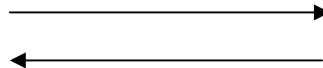

Relay: NC (Normal Close)



## Main MENU – Auto Record

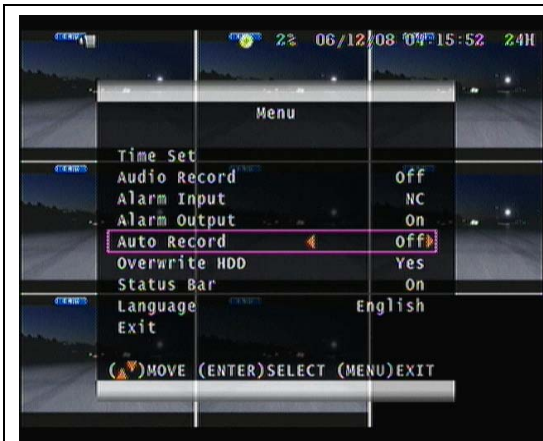

Use direction buttons to select Auto Record. Press the Enter button to choose On or Off. If switched to OFF then Auto Record is disabled.

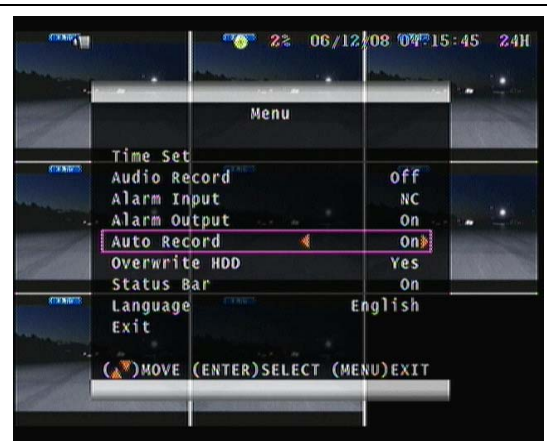

When Auto Record is set to On, the EZVR4/8 will start recording again after 2 minutes of inactivity after being manually stopped.

## Main MENU – Overwrite HDD



Use direction buttons to select Overwrite Enable. Press the Enter button to choose Yes or No.



YES – Recording continues to overwrite the oldest information after the Hard Disk is full

NO - Recording stops when the Hard Disk is full



## Main MENU – Status Bar

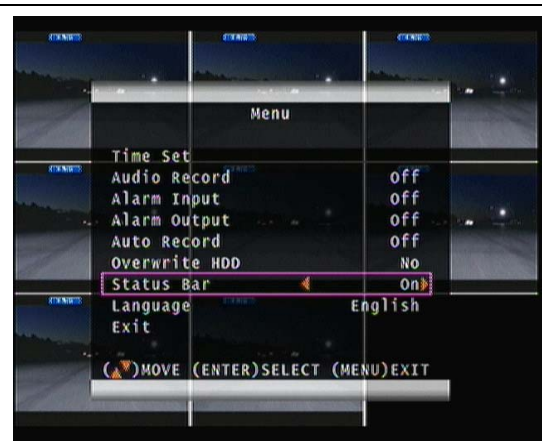

Use direction buttons to select Status Bar .  
Then press ENTER to select ON or Off .

If set ON, the status bar will show date-time and status icons .

If set Off the status bar will hide date-time and status icons .

## Main MENU – Language

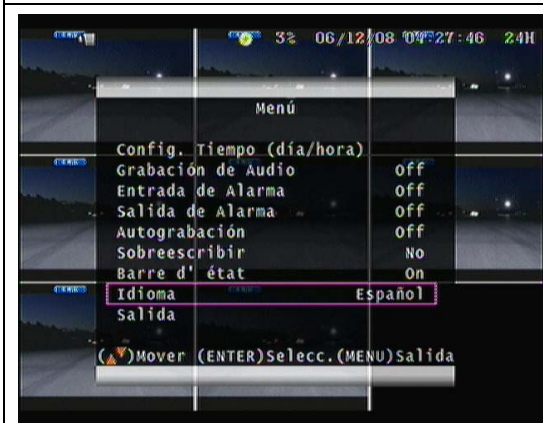

Use direction buttons to select Language.  
Press Enter button to choose a language.

Supported Languages:

English / French / Spanish

## Main MENU – Exit



Use direction buttons to select Exit.  
Press Enter button to leave the menu.

## Playback mode – Note: Instructions appear on the screen after selecting “Search”

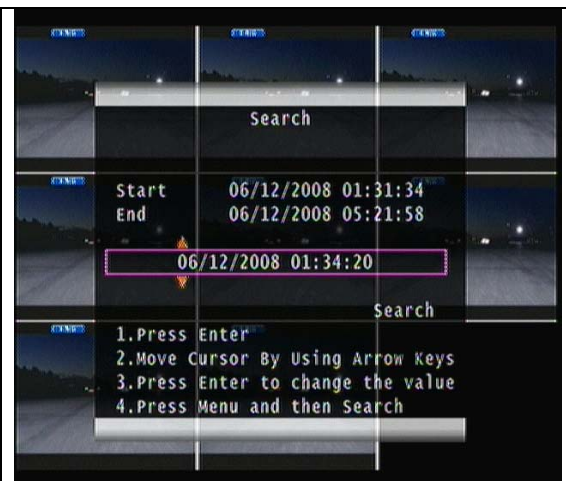
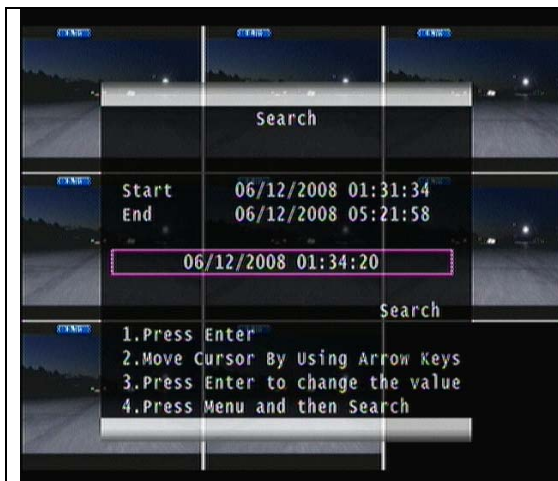

Press SEARCH to enter the playback mode.

Press ENTER to select a date and time.

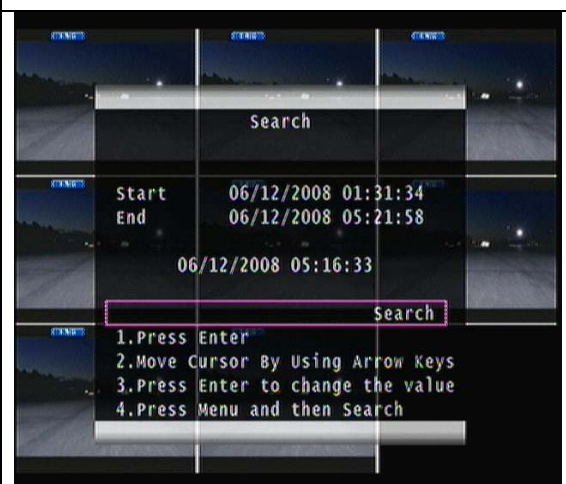
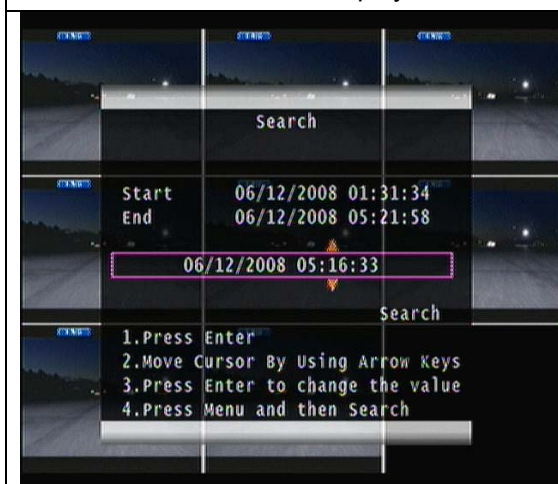

Use the left or right arrows to select the item you wish to change, then press ENTER to change the value

Press MENU to return to the previous screen and move cursor to Search.

<p>Press ENTER to start the searching.</p>	<p>Wait until the unit starts to playback.</p>

### Backup mode

Note: Plug in a USB device before starting the backup

<p>You must first playback an event using instructions from the previous page.</p>	<p>When the event you wish to backup appears on the screen, press the BACKUP button to select the start time.</p>
	<p>Press the BACKUP button a second time to select the end of the copy. The unit will detect the USB drive and copy the data to the USB device. After the backup procedure is completed you will be returned to the live screen. The viewer and .avi conversion software will be saved to the USB driver at the same time.</p>

## Player Software Main Screen

Please operate the player software according to the DVR model that you purchased



Click icon to select the file to play. It will be in .vtf format

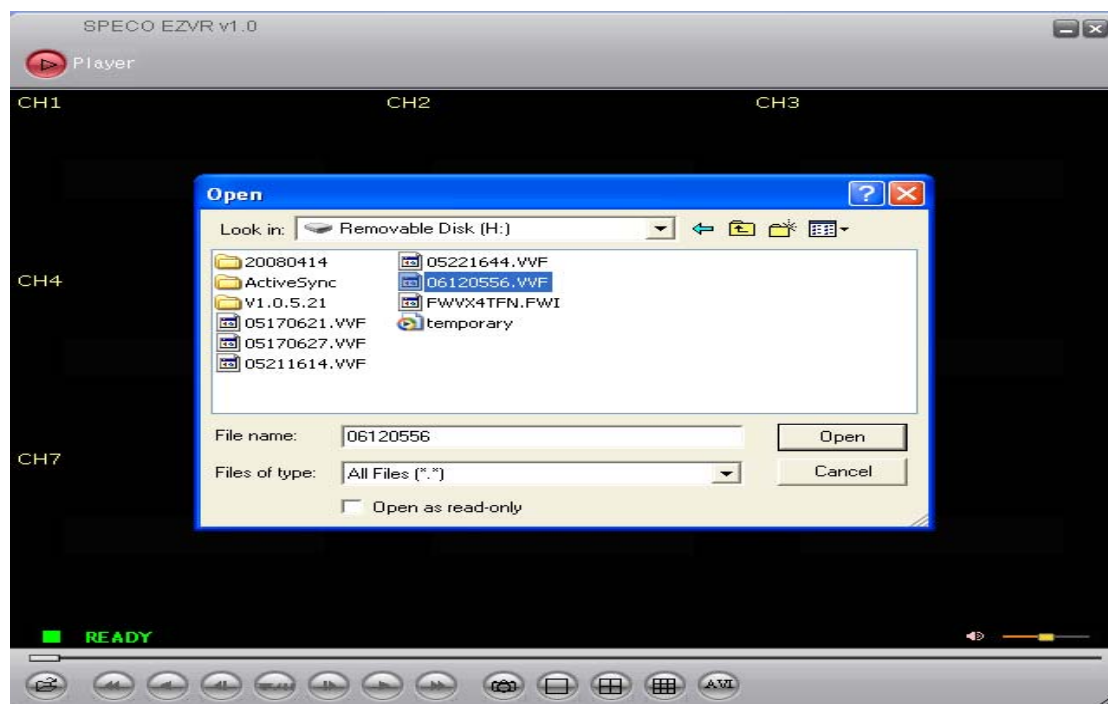

Starts to play;



1 2 3 4 5 6 7 8 9 10 11 12 13

1	Open File	8	Fast Forward
2	Fast Reverse	9	Capture (Save to C:\ Capture & Clipboard)
3	Play Reverse	10	Full Screen mode
4	Previous Frame	11	Quad Screen mode
5	Pause	12	Split Screen mode (Only EZVR8 included)
6	Next Frame	13	Export to AVI format
7	Play		

AVI Button: .vof file export to .avi format

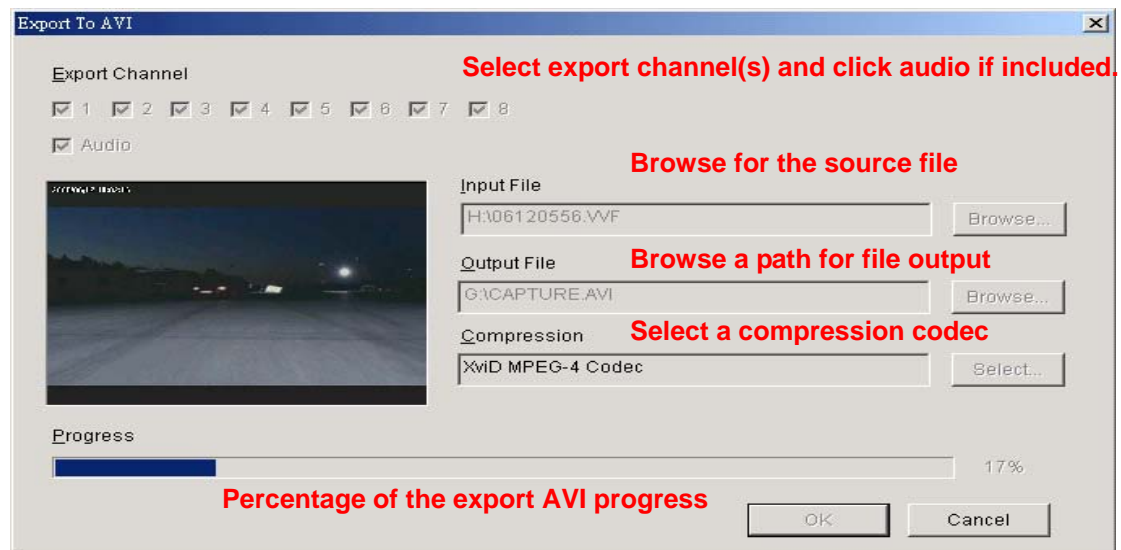

## Specifications

<b>Model</b>	EZVR4	EZVR8
Input	4 CH Inputs 1.0Vp-p, 75ohm (BNC Type)	8 CH Inputs 1.0Vp-p, 75ohm (BNC Type)
Output	Main monitor composite video (BNC type) x 2	
S/N Ratio	More than 40dB	
Color	6.7 Million	
<b>Monitoring Method</b>		
Channel Display	1 / 4 channel display	1 / 4 / 8 channel display
Live Screen Resolution	720(H) x 448(V) Active Pixels(NTSC); 720(H) x 544(V) Active Pixels (PAL)	
Display Rate	120 fps (NTSC) / 100 fps (PAL)	240 fps (NTSC) / 200 fps (PAL)
<b>Recording/ Play Function</b>		
Compressed Picture	M - JPEG	
Recording Control	Auto / manual	
Playback Mode	Date & Time search	
<b>Miscellaneous</b>		
Operation Mode	Record / Playback / Backup	
Alarm	Alarm in x 4 / Relay out x 1	Alarm in x 8 / Relay out x 1
Back-Up	USB 1.1/2.0 Flash drive or HDD	
Storage	HDD x 1 , SATA	
Audio Input	RCA x 4 Line Level	
Audio Output	RCA x 2 Line Level	
HDD Record Mode	Full stop / overwrite	
Front Panel Keylock	Yes	
Power Supply	DC 12V / 5A Included	
Weight	N.W./G.W. 6.75 pounds / 8.25 pounds	
Dimension	16.75"(W) x 13"(D) x 2.6"(H)	
Operating Temperature	41 °F~104 °F	
Operating Humidity	Less than 90%	



**85-DM4063-A004G B**



## Free Manuals Download Website

<http://myh66.com>

<http://usermanuals.us>

<http://www.somanuals.com>

<http://www.4manuals.cc>

<http://www.manual-lib.com>

<http://www.404manual.com>

<http://www.luxmanual.com>

<http://aubethermostatmanual.com>

Golf course search by state

<http://golfingnear.com>

Email search by domain

<http://emailbydomain.com>

Auto manuals search

<http://auto.somanuals.com>

TV manuals search

<http://tv.somanuals.com>