

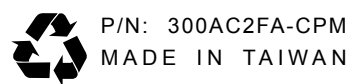

PC Pro Series

User Manual





P/N: 300AC2FA-CPM
MADE IN TAIWAN

FCC NOTICE (Class A)

This device complies with Part 15 of the FCC Rules. Operation is subject to the following two conditions: (1) this device may not cause harmful interference, and (2) this device must accept any interference received, including interference that may cause undesired operation.

Federal Communications Commission Statement

NOTE- This equipment has been tested and found to comply with the limits for a Class A digital device, pursuant to Part 15 of the FCC Rules. These limits are designed to provide reasonable protection against harmful interference in a residential installation. This equipment generates uses and can radiate radio frequency energy and, if not installed and used in accordance with the instructions, may cause harmful interference to radio communications. However, there is no guarantee that interference will not occur in a particular installation. If this equipment does cause harmful interference to radio or television reception, which can be determined by tuning the equipment off and on, the user is encouraged to try to correct the interference by one or more of the following measures:

- Reorient or relocate the receiving antenna.
- Increase the separation between the equipment and receiver.
- Connect the equipment into an outlet on a circuit different from that to which the receiver is connected.
- Consult the dealer or an experienced radio/television technician for help.

European Community Compliance Statement (Class A)

This product is herewith confirmed to comply with the requirements set out in the Council Directives on the Approximation of the laws of the Member States relating to Electromagnetic Compatibility Directive 2004/108/EEC.

Warning - This is a Class A product. In a domestic environment this product may cause radio interference in which case the user may be required to take adequate measures to correct this interference.

DISCLAIMER

No warranty or representation, either expressed or implied, is made with respect to the contents of this documentation, its quality, performance, merchantability, or fitness for a particular purpose. Information presented in this documentation has been carefully checked for reliability; however, no responsibility is assumed for inaccuracies. The information contained in this documentation is subject to change without notice.

In no event will the manufacturer be liable for direct, indirect, special, incidental, or consequential damages arising out of the use or inability to use this product or documentation, even if advised of the possibility of such damages.

TRADEMARKS

All other products or corporate names mentioned in this documentation are for identification and explanation purposes only, and may be trademarks or registered trademarks of their respective owners.

COPYRIGHT

All rights reserved. No part of this publication may be reproduced, transmitted, transcribed, stored in a retrieval system, or translated into any language in any form by any means without the written permission of the manufacturer.



THE MARK OF CROSSED-OUT WHEELED BIN INDICATES THAT THIS PRODUCT MUST NOT BE DISPOSED OF WITH YOUR OTHER HOUSEHOLD WASTE. INSTEAD, YOU NEED TO DISPOSE OF THE WASTE EQUIPMENT BY HANDING IT OVER TO A DESIGNATED COLLECTION POINT FOR THE RECYCLING OF WASTE ELECTRICAL AND ELECTRONIC EQUIPMENT. FOR MORE INFORMATION ABOUT WHERE TO DROP OFF YOUR WASTE EQUIPMENT FOR RECYCLING, PLEASE CONTACT YOUR HOUSEHOLD WASTE DISPOSAL SERVICE OR THE SHOP WHERE YOU PURCHASED THE PRODUCT.

Battery Safety Information

- Store the batteries in a cool dry place.
- Do not dispose of used batteries in domestic waste. Dispose of batteries at special collection points or return to point of sale if applies.
- Remove the batteries during long periods of non-use. Always remove exhausted batteries from the remote control. Battery leakage and corrosion can damage this remote control, dispose of batteries safely.
- Do not mix old and new batteries.
- Do not mix different types of batteries: alkaline, standard (carbon-zinc) or rechargeable (nickel-cadmium).
- Do not dispose of batteries in a fire. The batteries may explode or leak.
- Never short circuit the battery terminals.

**WARNING**

TO REDUCE RISK OF FIRE OR ELECTRIC SHOCK, DO NOT EXPOSE THIS APPLIANCE TO RAIN OR MOISTURE.

**CAUTION**

IF THERE IS ANY DAMAGE, SHORTAGE OR INAPPROPRIATE ITEM IN THE PACKAGE, PLEASE CONTACT WITH YOUR LOCAL DEALER. WARRANTY VOID FOR ANY UNAUTHORIZED PRODUCT MODIFICATION.

Manual Conventions

The following conventions are used throughout this manual



Caution symbol is intended to alert the user of the important installation and operating instructions. Fail to comply may damage the system.



Information symbol is intended to provide additional information for the purpose of clarification.

TABLE OF CONTENTS

Chapter 1	Introduction.....	1
1.1	Package Contents.....	1
1.2	Specification.....	2
1.3	Software Features.....	3
1.4	Front Panel.....	5
1.4.1	The Front Panel Control Buttons in Guest Mode.....	9
1.5	Back Panel.....	10
1.5.1	8 Channels.....	10
1.5.2	16 Channels.....	11
Chapter 2	Hardware Installation.....	12
2.1	Connecting Device.....	12
2.2	Remote Controller Buttons.....	13
2.2.1	The Remote Controller Buttons in Guest Mode.....	17
2.3	Sensor/Relay Interface pinhole allocation.....	18
2.4	Audio In Interface pinhole allocation.....	19
Chapter 3	Using the DVR Software.....	20
3.1	Running the Unit for the First Time.....	20
3.2	Function buttons in Advanced/Preview Mode.....	20
3.2.1	Using Event Log Viewer.....	23
3.3	Function Buttons in Playback Mode.....	26
3.4	Function Buttons in Compact Mode.....	29
3.5	Function Buttons in PTZ Camera Controller.....	30
3.6	Setting Up and Using the EMAP.....	31
3.6.1	To Set Up the EMAP.....	31
3.6.2	To Use the EMAP.....	32
3.7	To Cut and Save the Wanted Portion of the Recorded Video.....	32
3.8	To Bookmark a Section of the Video.....	33
3.9	To Search Using the Visual Search.....	33
3.10	To Search Using the Event Search.....	34
3.12	To Setup the PTZ/IP PTZ Camera.....	36
3.12.1	Setup the PTZ Camera.....	36
3.12.2	Setup the IP PTZ Camera.....	37
Chapter 4	Customizing the DVR System.....	38
4.1.1	To Set the POS Setting.....	45
4.2.1	Setup the Object Counting.....	51
4.3	Recording Setting.....	52
4.3.1	To Mask/Shield an area on the screen.....	54
4.3.2	To show and change the color of the Mask.....	54
4.3.3	To Playback Encrypted Video.....	54
4.4	Network Setting.....	55
4.5	Schedule Setting.....	58

4.5.1	Set schedule at specific portion of time	59
4.6	Backup Setting	59
4.6.1	To Backup file.....	59
4.6.2	Setup Quick Backup.....	60
4.7	Sensor Setting.....	61
4.7.1	To Setup External I/O Box.....	62
4.8	Relay Setting	64
4.9	Alarm Setting.....	65
4.9.1	To Setup Alarm Relay:	69
4.9.2	To Setup the Alarm Sound Setting:	69
4.9.3	To Setup Call Out List:	70
4.9.4	To Setup Send E-mail Setting:	70
4.9.5	To Setup FTP Setting:	71
4.9.6	To Setup Alarm Recording Setting:	71
4.9.7	To Setup SMS/MMS Setting:	72
4.9.8	To Setup PTZ Preset Point:	73
4.9.9	To Setup Alarm SOP:	73
4.9.10	To Setup CMS Setting.....	73
4.9.11	To Setup POS Keyword Setting	74
4.9.12	Missing, Suspicious Object, and Scene Change Detected.....	74
4.10	User Setting	77
Chapter 5	Backup Video Players	79
5.1	Familiarizing QLogViewer Buttons.....	80
5.2	Familiarizing the Player Buttons	81
Chapter 6	Using Functional Keys.....	83
Chapter 7	Using the Remote Programs	84
7.1	Familiarizing the WebViewer Buttons	85
7.1.1	To Setup Remote System Setting	87
7.2	Familiarizing the WebViewer PTZ Buttons	89
7.3	Familiarizing the Remote Console Buttons.....	90
7.3.1	To Setup Remote Console Setting.....	91
7.4	Using the Remote Playback.....	92
7.4.1	Familiarizing the Local Playback Buttons	94
7.4.2	Familiarizing the RealTime Playback Buttons.....	96
7.4.3	Familiarizing the Download and Playback Buttons.....	98
7.5	Using HandyViewer to Access DVR server	99
7.6	Using PDAViewer to Access DVR Server	99
7.6.1	To install PDAViewer thru ActiveSync	99
7.6.2	To install PDAViewer from the Internet	100
7.6.3	To Use the PDAViewer.....	101
7.6.4	Using JavaViewer to Access DVR Server.....	102
7.6.5	To Use the JAVAViewer.....	103

Chapter 8	Image Verification	105
8.1	To Run the ImageVerification program.....	105
Chapter 9	iEnhance	106
9.1	To Use iStable	108
Chapter 10	Web Tools	109
10.1	Dispatch Server.....	109
10.2	Remote Setup	110
10.2.1	To Add DVR server.....	110
10.2.2	To Setup Remote DVR Server	111
10.3	Remote Backup.....	123
Chapter 11	Using the Remote Control Server	126
APPENDIX A	Network Service Port	127
APPENDIX B	Install PTZ through RS-232 Interface	128

Chapter 1 Introduction

The SPECO PC Pro is a professional series of standalone DVR units that provide up to 16 channels of hybrid and real-time monitoring and digital recording of surveillance video. It can connect to 4 sensors and relays and also provide up to 16 audio inputs. No software and hardware installation required. Simply connect the cables and start the video surveillance process. Through the USB port, user can backup the recording video and playback within the bundled software on personal computer.

1.1 Package Contents

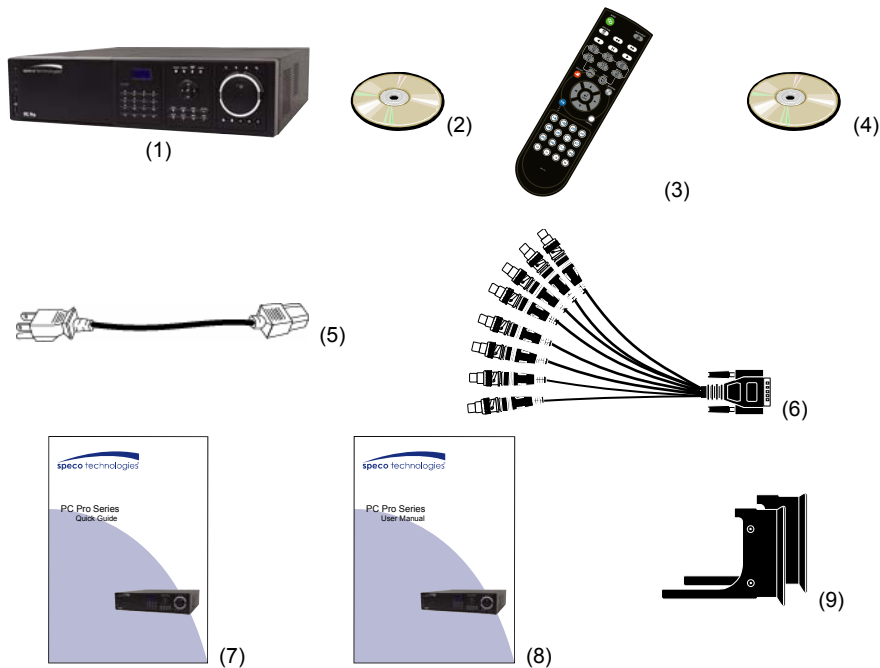

- (1) PC Pro unit
- (2) Utility Software CD (Manual included)
- (3) Remote control(batteries included)
- (4) Recovery DVD
- (5) Power Cord
- (6) DVI Camera Loop Out Cables
- (7) Quick Install Guide
- (8) Users Manuals
- (9) Rack Ears x 2



The package contents may vary according to your model.

1.2 Specification

	PC Pro Series	
<i>Model</i>	<i>PC Pro 16</i>	<i>PC Pro 8</i>
Operating system	WinXP embedded	
Video input	16	8
Video loop output	16	8
Display rate(NTSC/PAL)	480/400 fps	240/200 fps
Recording frame rate(CIF)	480 (FPS@352*240)	240 (FPS@352*240)
Audio input	16	8
Sensor/Relay	4/4	4/4
DVD-RW	Yes	Yes
Removable HDD tray	1 HDD tray(support up to 4 HDD)	
DOM	2 GB	
H/W accesorry	Remote controller	
Ethernet	RJ-45, 10/100/1000 Mbps	
USB 2.0	Front 2 ports, Rear 4 ports	
LCD Display	Temperature/ System status/ HDD left size/ Alarm status	
Operation via front panel	PTZ control/ channel select/ split select/ playback control/ mode select	
Dimensions (W x H x D)	430*110*410 mm	
Power Supply Unit	270 Watt	
Dual-monitor output	Yes	

1.3 Software Features

Recording Modes	Continuous Recording Smart Recording Motion Recording Voice detection Recording Alarm Recording Manual Recording <hr/>  All modes can be triggered by schedule <hr/>
De-interlace Options	Optimize for dynamic or static camera scenes
Dual-monitor output	Support Dual Monitor environment for independent preview and playback or EMAP
Operation via front panel	PTZ control/ channel select/ split select/ playback control/ mode select
Motion Detection	Detects all video motion within the camera focus
Privacy Protection	Editable shield preventing private areas from monitoring and recording
Object Detection	Missing Object/ Suspicious Object/ Scene Change
E-map Function	Show the positions of cameras, sensors, relays and triggered status in a real map image that is configurable within the GUI
Attention	A utility that monitors the operators response time to alarm messages
Powerful Search	By date, time, camera, area, event, Visual search, and log file
Bookmark	Easily save links to particular locations of recorded data and play them directly from the saved links
POS Integration	Compatible with most commonly used POS system Easy to add POS protocol Confidential Word Filter Change location of POS text on camera display image
Advanced Event Log Viewer	Details complete event logs according to your selection on event, operation, POS, system and network events
Alarm Triggered Mode	Single event or multiple events as alarm trigger conditions
Smart Alert Functions	Launch E-map Cam icon display Digital Deterrent Email



	<p>Make a phone call</p> <p>Send files to FTP</p> <p>SMS and MMS</p> <p>PTZ preset point tracking</p> <p>Alarm SOP wizard</p> <p>Enlarge camera view (Full screen)</p>
Central Management	Central Management System(CMS)
Remote Access	<p>IE browser</p> <p>Remote Console</p> <p>Smart phone viewer</p> <p>PDA viewer</p>
Dispatch Server	Share transmission loading; enable more clients remote access and high-speed data transmission
PDA Viewer	4-cam view, full screen and live audio
Smart phone viewer	Supports Symbian and Windows smart phone system/ support PTZ cameras control on smart phones with JAVA2.0
DDNS	Support for dynamic IP addressing
iEnhance	Enhance video quality such as Brightness, Contrast, Hue, Saturation, Sharpness, Noise Reduction, De-interlace and Gray Scale of recorded data
iStable	Fix shaking and jolts impact on video with just one click

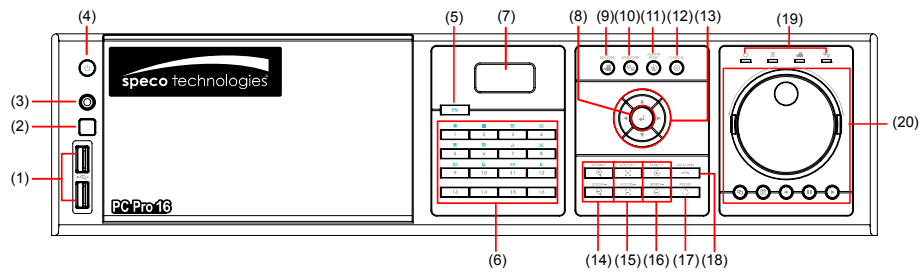

1.4 Front Panel





Name	Function
(1) USB 2.0 port	2 x USB 2.0 ports for connecting any USB interface devices, ex: USB pen drive, external hard disk, keyboard, mouse...and so on.
(2) IR Sensor	Receive signal from the remote control to operate the unit
(3) IR Sensor	To connect extended IR sensor cable
(4) 	System power button



A functional key for multiple system control



- Press  to enable multiple function modes and the  button will light up blue.
- To exit multiple function modes, press  again.



 +  : Switch to single screen display mode



 +  : Switch to QUAD display mode



 +  : Switch to 9 spilt screen display mode

 +  : Switch to 16 spilt screen display mode



















 +  : Switch to one single and 8 spilt screen display mode



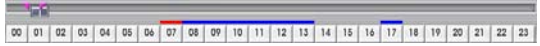













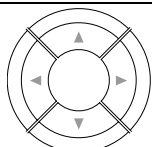

 +  : Switch to one single and 13spilt screen display mode













 +  : To enable auto scan function

 +  : Switch to full screen display mode

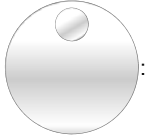
(5) 

Name	Function
	 +  : To freeze the live preview video screen. To unfreeze press  again. User can snapshot the freeze screen while freezing.
	 +  : To backup recorded video file to pen drive(see Chapter 4.6.2)
	 +  : Allow user to set a video segment from A to B point and play on the surveillance screen until user stop.
(5) 	<ol style="list-style-type: none"> Switch to Playback mode Press  to enter multiple function mode During the playback, press  to set the A point of video segment. User will see a triangle mark on play progress bar.
	
	<ol style="list-style-type: none"> And then, press  again to set the B point of video segment. User will see another triangle mark on play progress bar. To cancel AB repeat segment, press  again.
	
	<ol style="list-style-type: none"> The AB point segment can be saved by click Output button on Playback GUI
	<ol style="list-style-type: none"> In the Save As dialog box, locate on where you want to save the file, type the filename, and select the video format
	 +  : To lock panel and remote control all function buttons. To unlock, press  and the system will require user to enter the password(default system password is admin/admin)
(6) Number button	 ~  <ul style="list-style-type: none"> - As a number key for entering password in playback and preview mode - Channel camera selection number in playback and preview mode - As a preset position with  in PTZ control mode

Name	Function
(6) Number button	 ~ - With  button can switch to different screen display modes and enable auto scan function - To call out 1~ 8 map figures in E-map mode
(7) LCD Display	Display DVR system status such as temperature and operate status
(8) 	Confirm or make a selection
(9) 	To start recording video
(10) 	To enable network connection
(11) 	To reset alarm status
(12) 	Cancel a selection
(13) 	PTZ control button To move PTZ camera lens to left, right, up and down
(14) Zoom + / Zoom -	 To zoom in view of PTZ camera lens  To zoom out view of PTZ camera lens
(15) Focus + / Focus -	 To focus in PTZ camera lens  To focus out PTZ camera lens
(16) Speed + / Speed -	 To speed up movement of PTZ camera lens  To speed down movement of PTZ camera lens
	 To move the PTZ camera to the preset poison. Press  + number button.
(17) Preset	 - Please setup the preset poison before using  button function. To setup the preset poison, please refer to Chapter 3.11.1 . - Without setup preset poison, the preset button () will not be functional when user presses.

Name	Function
(18) Auto Pan	 To enable auto pan function
system status indicators:	
(19) Status LEDs	 : System power indicator. Indicate running state of system. Lights when the system is running.  : Removable hard disk indicator. Indicate running state of the hard disk. Lights when the HDD is running  : Recording status indicator. Lights when the system is recording.  : Network status indicator. Lights when the system network connection is enabled.
Playback control button in playback mode	
(20) Playback button	 Speed shuttle for adjusting reversed and forward (2x, 4x, 8x, 16x or 32x) speed during playback. Turn left is reversed and turn right is forwarded.  To move to next or previous frame during playback. Turning left is to go back to one previous frame and turning right is to go forward one frame..
(20) Playback button	 : Switch to playback mode, preview mode or E-map mode  : To select the playback date and time  : To temporary stop playback  : To reverse playback  : To play the recorded video

1.4.1 The Front Panel Control Buttons in Guest Mode

When user uses Guest account to operate DVR server, the front panel control buttons of DVR are limited to preview and playback function only. The following table lists the control buttons that are available while in Guest mode.



In the Guest mode, user only can use remote controller and front panel control buttons to operate DVR server.

Mode	Function
	<p>A functional key for multiple system control</p> <ul style="list-style-type: none"> - Press to enable multiple function modes and the button will turn to blue light. - To exit multiple function modes, press again.
Preview Mode	+ : Switch to single screen display mode
	+ : Switch to QUAD display mode
	+ : Switch to 9 split screen display mode
	+ : Switch to 16 split screen display mode
	+ : Switch to one single and 8 split screen display mode
	+ : Switch to one single and 13split screen display mode
	+ : To enable auto scan function
	+ : Switch to full screen display mode
Preview Mode	+ : To freeze the live preview video screen. To unfreeze press again. User can snapshot the freeze screen while freezing.
	+ : To backup recorded video file to pen drive(see Chapter 4.6.2)
Playback Mode	: Switch to playback mode, preview mode or E-map mode
	: To select the playback date and time

1.5 Back Panel

1.5.1 8 Channels

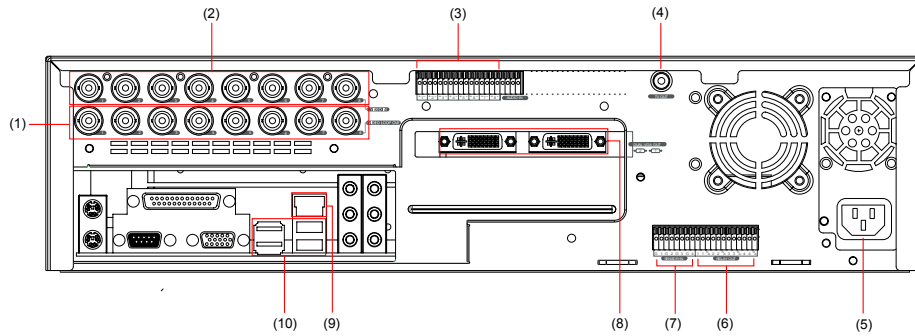

Name	Function
(1) Video Loop Out	Output the video signal to a CCTV monitor. Only output one channel signal at a time.
(2) CH1~8	Input the video camera signal and display it on channel 1~ 8
(3) Audio In	Input the audio signal from a microphone or audio output device. System supports up to 8 audio input devices. The audio is embedded with channel 1~ 8
	<p>i The audio input device needs to be powered by external power.</p>
(4) Call Out	Output the video signal to a Call monitor
(5) Power plug	Connect the power cord into this port
(6) Relay Out	Support 4 relay devices
(7) Sensor In	Support up to 4 sensor devices
(8) VGA Out	Output the video signal to a CRT or LCD monitor
(9) LAN Port	For Ethernet connection
(10) USB Port	4 USB ports for connecting any USB interface devices.

1.5.2 16 Channels

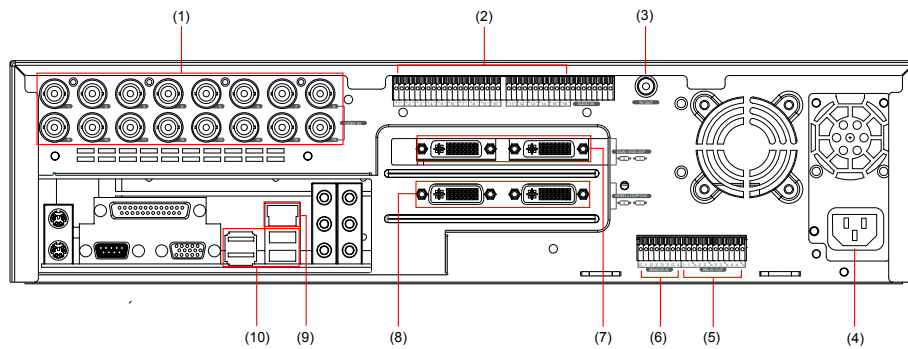

Name	Function
(1) CH1~16	Input the video camera signal and display it on channel 1~ 16
(2) Audio In	Input the audio signal from a microphone or audio output device. System supports up to 16 audio input devices. The audio is embedded with channel 1~ 16
<p>i The audio input device needs to be powered by external power.</p>	
(3) Call Out	Output the video signal to a Call monitor
(4) Power plug	Connect the power cord into this port
(5) Relay Out	Support 4 relay devices
(6) Sensor In	Support up to 4 sensor devices
(7) VGA Out	Output the video signal to a CRT or LCD monitor
(8) Video Loop Out	Output the video signal to a CCTV monitor. Only output one channel signal at a time.
(9) LAN Port	For Ethernet connection
(10) USB Port	4 USB ports for connecting any USB interface devices.

Chapter 2 Hardware Installation

2.1 Connecting Device





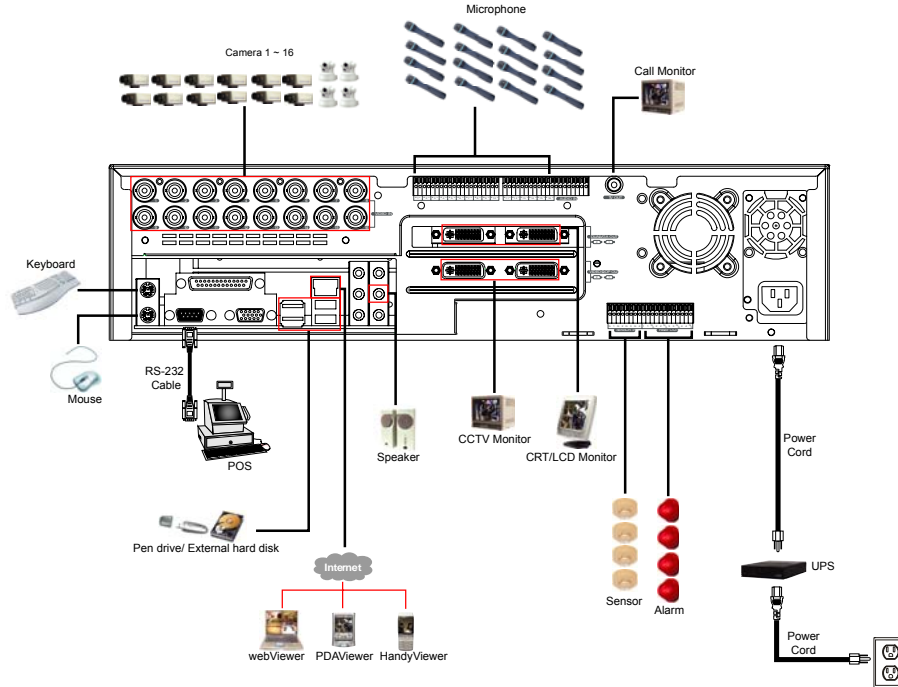

The DVR unit can connect up to 16 video cameras, 4 sensor devices, 4 relay devices and output video to a TV or CRT/LCD monitor. Connecting the unit to a DVD-RW/ external hard disk through USB connection, the bundled software enables you to transfer and back up the recorded video. Also, the bundled software can playback and segment the backup recorded video.

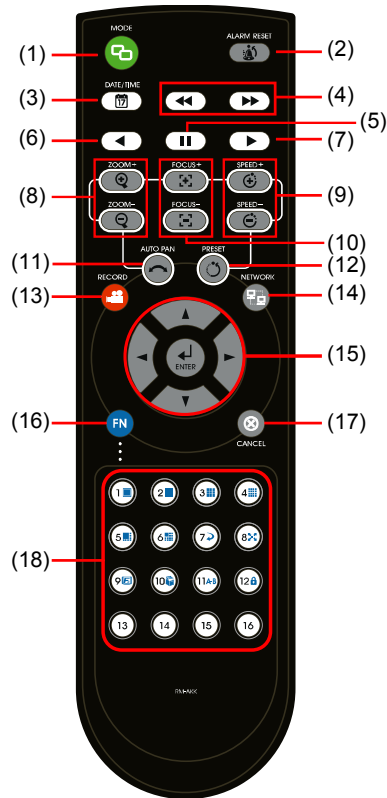



















Follow the illustration below to make the connection:



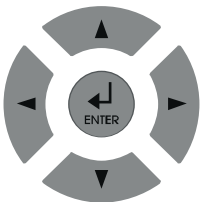





















































2.2 Remote Controller Buttons



Name	Function
(1) 	Switch to playback mode, preview mode or E-map mode
(2) 	To reset alarm status
(3) 	To select the time and date of playback file
(4) 	Fast play the video playback at the speed of 2x, 4x, 8x, 16x or 32x Decrease the video playback at the speed of 1/2x, 1/4x, or 1/8x
(5) 	To pause playing
(6) 	To move the selection to the left To move the PTZ camera lens to the left

Name	Function
(7) 	To move the selection to the right To move the PTZ camera lens to the right
(8)  	To zoom out view of PTZ camera To zoom in view of PTZ camera
(9)  	To speed up movement of PTZ camera lens To speed down movement of PTZ camera lens
(10)  	To focus in PTZ camera lens To focus out PTZ camera lens
(11) 	To enable auto pan function
(12) 	To move the PTZ camera to the preset position. Press  + number button ( ~ )
(13) 	Start recording video
(14) 	To enable network connection
(15) 	 To move PTZ camera to left  To move PTZ camera to right  To move PTZ camera to up  To move PTZ camera to down  Confirm or make a selection

























Name	Function
(16) 	<p data-bbox="727 170 866 208"> ~ </p> <p data-bbox="727 226 1129 248">A functional key for multiple system control</p> <ul data-bbox="727 264 1174 327" style="list-style-type: none"> - Press  and function button to enable functions <p data-bbox="727 338 1235 371"> +  : Switch to single screen display mode</p> <p data-bbox="727 394 1174 427"> +  : Switch to QUAD display mode</p> <p data-bbox="727 450 1241 483"> +  : Switch to 9 split screen display mode</p> <p data-bbox="727 506 1241 568"> +  : Switch to 16 split screen display mode</p> <p data-bbox="727 586 1241 649"> +  : Switch to one single and 7 split screen display mode</p> <p data-bbox="727 667 1241 730"> +  : Switch to one single and 12 split screen display mode</p> <p data-bbox="727 748 1161 781"> +  : To enable auto scan function</p> <p data-bbox="727 804 1214 837"> +  : To switch full screen display mode</p> <p data-bbox="727 855 1241 999"> +  : To freeze the live play video screen. User can snapshot the freeze screen view while freezing. Press  again to unfreeze</p> <p data-bbox="727 1016 1241 1079"> +  : To backup the recorded video file to pen drive(See Chapter 4.6.2)</p> <p data-bbox="727 1097 1241 1272"> +  : To lock the panel buttons and remote controller function buttons. To unlock, press  and user will be required to enter the system password (default is admin/admin)</p>

Name	Function
(16) 	<p> +  : Allow user to set a video segment from A to B point and play on the surveillance screen until user stop.</p> <ol style="list-style-type: none"> 1. Switch to Playback mode 2. Press  to enter multiple function mode 3. During the playback, press  to set the A point of video segment. User will see a triangle mark on play progress bar.  <ol style="list-style-type: none"> 4. And then, press  again to set the B point of video segment. User will see another triangle mark on play progress bar. To cancel AB repeat segment, press  again.  <ol style="list-style-type: none"> 5. The AB point segment can be saved by click Output button on Playback GUI 6. In the Save As dialog box, locate on where you want to save the file, type the filename, and select the video format
(17) 	Cancel a selection
(18)	     <ul style="list-style-type: none"> - As a number key for entering password in playback and preview mode - Channel camera selection number in playback and preview mode     <ul style="list-style-type: none"> - As a preset position with  in PTZ control mode      <ul style="list-style-type: none"> - With  button can switch to different screen display modes and enable auto scan and full screen function (also see Chapter 1.6 #16) - To call out 1~ 8 map figures in E-map

2.2.1 The Remote Controller Buttons in Guest Mode

When user uses Guest account to operate DVR server, the front panel control buttons of DVR are limited to preview and playback function only. The following table lists the control buttons that are available while in Guest mode.

 In the Guest mode, user only can use remote controller and front panel control buttons to operate DVR server.

Name	Function
	Switch to playback mode, preview mode or E-map mode
	To select the time and date of playback file
 +  ~ 	Press  and function button to enable functions
	 +  : Switch to single screen display mode
	 +  : Switch to QUAD display mode
	 +  : Switch to 9 spilt screen display mode
	 +  : Switch to 16 spilt screen display mode
	 +  : Switch to one single and 7 spilt screen display mode
	 +  : Switch to one single and 12 spilt screen display mode
	 +  : To enable auto scan function
	 +  : To switch full screen display mode
	 +  : To freeze the live play video screen. User can snapshot the freeze screen view while freezing. Press  again to unfreeze.

2.3 Sensor/Relay Interface pinhole allocation

The I/O interface enables you to connect (4) sensor inputs and (4) relay outputs. Just connect the external sensor and relay pin directly to the I/O interface pinhole. Check the table below and locate which pinhole is assigned to sensor input and relay output.

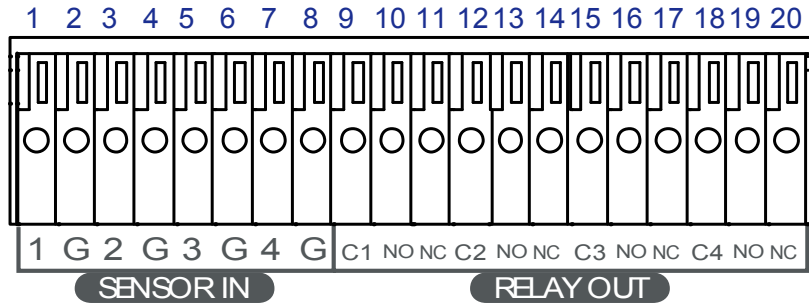

The signal from the sensor (i.e., infrared sensors, smoke detectors, proximity sensors, door sensors, etc.) is being transmitted to the I/O card and this triggers the system to respond and send signal to relay device (i.e., alarm, telephone etc).

Pin #	Definition	Pin #	Definition
1	Sensor output signal 1-(GND)	11	Relay Normal Close 1
2	Sensor input signal 1+	12	Relay Common 2
3	Sensor output signal 2-(GND)	13	Relay Normal Open 2
4	Sensor input signal 2+	14	Relay Normal Close 2
5	Sensor output signal 3-(GND)	15	Relay Common 3
6	Sensor input signal 3+	16	Relay Normal Open 3
7	Sensor output signal 4-(GND)	17	Relay Normal Close 3
8	Sensor input signal 4+	18	Relay Common 4
9	Relay Common 1	19	Relay Normal Open 4
10	Relay Normal Open 1	20	Relay Normal Close 4

2.4 Audio In Interface pinhole allocation

The audio in interface enables you to connect 16 audio in devices such as microphone. Just connect the external audio in device pin directly to the audio in pinhole. Check the figure below and locate which pinhole is assigned.

8 Channels

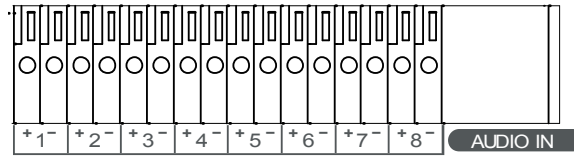

16 Channels

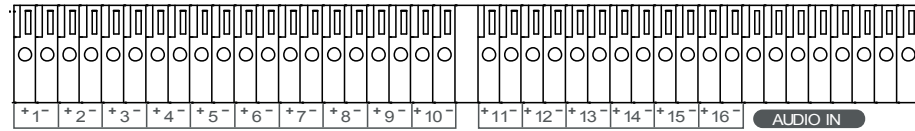

Chapter 3 Using the DVR Software

3.1 Running the Unit for the First Time

When the unit is turned on for the first time, the system will prompt you to enter the CD Key. The CD Key is a label on rear of the unit.

- i** For the using DVR application every time, user only has the guest authority. The guest authority only can operate the partial functions of preview and playback via front panel and remote controller. For advanced authority to operate all functions, please login as an administrator.(see also [Chapter 3.2](#))





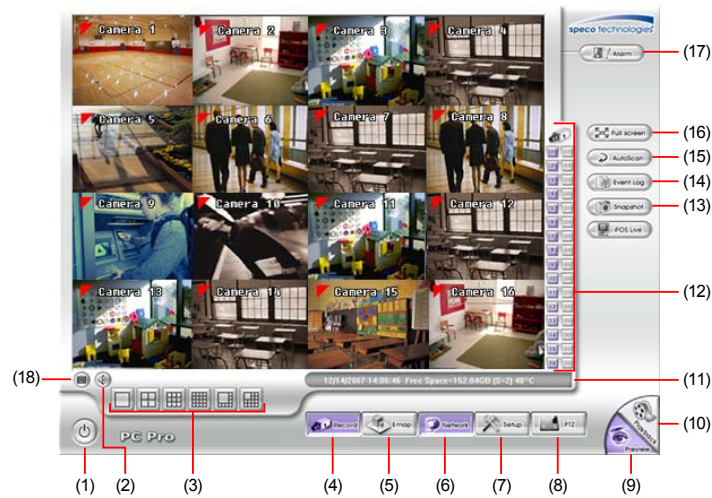





CD-Key :



3.2 Function buttons in Advanced/Preview Mode



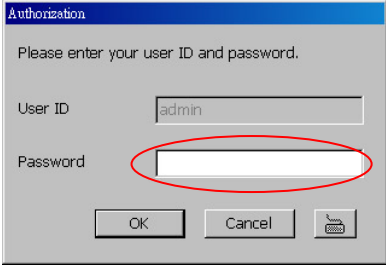

Name	Function
(1) Exit	Call up the Logout dialog box. In the logout dialog box, you may do the following:

- **Exit:** To close the DVR program.
- **Login:** To sign-in in different account.
- **Compact:** To switch to compact mode(see also [Chapter 3.4](#))

Name	Function
(1) Exit	<ul style="list-style-type: none"> - Guest: Switch to the guest mode. In guest mode, user only can control DVR by using the remote controller (see also Chapter 2.2.1) and the control panel of DVR (see also Chapter 1.4.1). The functions are limited to preview and playback function only. For complete functions of DVR, please login as an administrator. - Cancel: To exit Logout dialog box - About: To update patch or find about the software info.
(2) Volume	Adjust the audio volume to a proper volume.
(3) Split Screen Mode	<p>It provides 7 kinds of split display modes for your selection. You can select one of the split display modes by clicking the following icon.</p> <ul style="list-style-type: none">  1-Cam display  4-Cam split display  9-Cam split display  16-Cam split display  8-Cam split display  13-Cam split display
	<ul style="list-style-type: none"> - If there are only 4 cameras, you won't be able to switch to 9, 13, and 16 split screen mode. - The DVR system will save the current operating mode (split screen mode, sequence, full screen, and compact mode status) when shutdown DVR application and apply the mode for next login. - When you are in single screen mode, Right click and Drag a square on the area you want to enlarge. - When you are in multiple-screen mode, Right click the video screen of the camera and Drag on where you want to relocate it. To only display one of the video screens in the multiple-screen mode, Left click on the video screen you only want to display.
(4) Record	Click  to allow recording. The button turns violet when it is in recording mode. Click it again to stop record mode.
(5) E-Map	Click  to load up to 8 desired E-Maps in BMP or JPG image format, and locate cameras, sensors, and relays to desired positions.
(6) Network	Click  to allow inbound connections. When this function is enabled, the button turns violet. Click it again to disable all inbound connections.

Name	Function
(7) Setup	<p>When setting up the system for the first time, type the word “admin” in the Password text box to access.</p>
	 <p>Click  button to configure settings for cameras, recording, network, scheduler, backup, sensors, relays, alarms and user authentication.</p>
(8) PTZ	<p>Click  to pop-up a PTZ setup dialog to configure an appointed PTZ camera.</p>
(9) Preview	<p>Switch to Preview/Advanced mode. This allows you to view live camera display. Press ctrl + F can freeze the live preview video screen. And then, click Snapshot can save the freeze video screen.</p>
(10) Playback	<p>Switch to Playback mode. This allows you to view the recorded video file. (see Chapter 3.3)</p>
(11) Status Bar	<p>It shows the current time, and the hard disk's free space.</p>
(12) Camera ID	<p>Click a desired icon to play the desired channel. After you click the icon, it turns yellow. If you assign a split display mode and appoint a camera number, the icon group of the cameras will turn yellow altogether.</p>
(13) Snapshot	<p>Catch a static recording image and save it as a BMP or a JPG file.</p>
(14) Event log	<p>Click it to pop-up the Event Log Viewer dialog to check Event, Operation, POS (Point of Sales), System and Network logs. You can select a desired date and a log item to show all logs data in the table.</p>
(15) Sequence	<p>Click it to start Sequence.</p>

Name	Function
(16) Full screen	<p>Use the entire area of the screen to only display the video. To return, press the right button of the mouse or ESC on the keyboard or click the arrow icon.</p>  <p>When you switch to full screen in multiple-screen mode, Left click to toggle to only display one of the video screens in the multiple-screen mode or all.</p>
(17) Alarm	Click  to view the status of advanced alarm information.
(18) On Screen Keyboard	If the keyboard is not available, you may use the Virtual Keyboard.

3.2.1 Using Event Log Viewer

Show the record of activities that take place in the system.

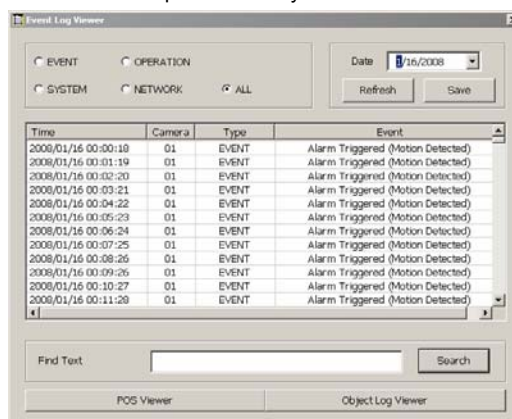





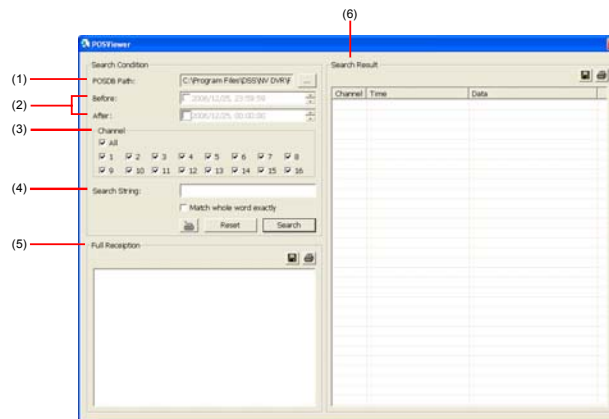

1. Click the Event Log button on DVR system main interface. The Event log viewer window will show up.
2. Select the Date to view or search certain event log by key word. Enter the key word in **Find Text** column and click **Search** button.
3. To filter the records, select and click the radio button to display Event, System, Operation, Network or All.

- The events list which display on the screen can be saved as text file format. To save the events list, click **Save** button.

Using the POS Viewer

To view POS event log, click **POS Viewer** bar to call out the POS event log window.



Name	Function
(1) POSDB Path	The storage path for POS event log. Click  to change the storage path.
(2) Before/After	Set a time period before and after of POS event log.
(3) Channel	Select the POS event log of channel
(4) Search String	Enter specific key word or word string to search the POS event log. Mark the " Match whole word exactly " box if wants to find exactly key word or word string of POS event log.
(5) Full Reception	Display the POS event log detail that user selected from Search Result window. Click  to save the POS event log. Click  to print out the POS event log.
(6) Search Result	Display the POS event log of search result. Click  to save the search result. Click  to print out the search result.

Using the Object Viewer

Click Object Viewer bar to view and search FaceFinder event log.



Name	Function
(1) Close	Click to close Object Log Viewer windows
(2) Search Mode	Switch to face object log search mode
(3) Select Camera	Select the camera to view or select all to view all cameras
(4) Clear	To clear all object log in Object Log list
(5) Close up	Click to close up the Object Log List
(6) Object Log List	Display the face object logs. It can display 32 object logs and when the list is full, the first row of object log will be replace.

3.3 Function Buttons in Playback Mode

To switch to Playback mode, click **Playback** button at the lower right corner of Advanced/Preview mode user interface

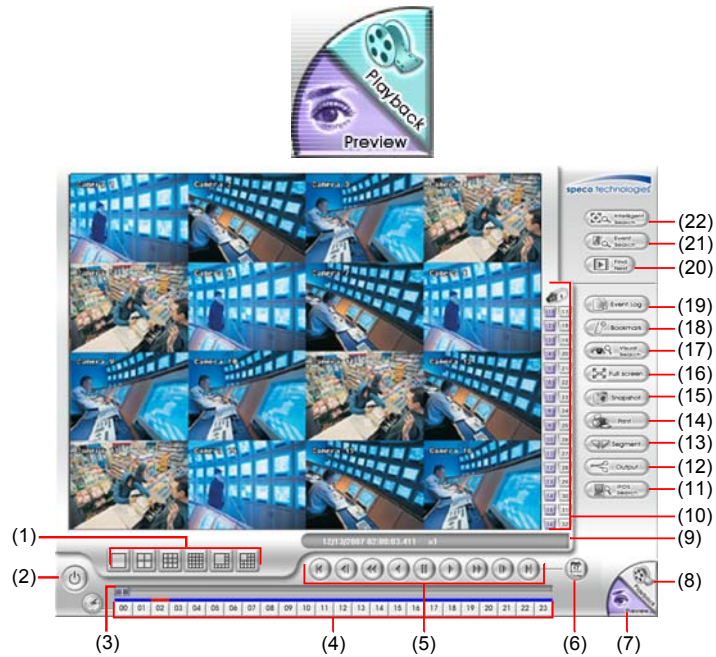

Name	Function
(1) Split Screen Mode	Select from 6 kinds of split screen type to playback the recorded video file of all the camera, or one camera over the other or alongside on a single screen.
i	<ul style="list-style-type: none"> - If there are only 4 cameras, you won't be able to switch to 9, 13, and 16 split screen mode. - To zoom in an area on the screen, Right click and Drag a square on the area you want to enlarge.
(2) Exit	Click to exit playback mode
(3) Progress bar	Show the progress of the file being played. You may move the bar to seek at any location of the track.
(4) Hour Buttons	Select and click to playback the recorded video file on the specific time frame.
i	The Hour buttons represent the time in 24-hour clock. The blue bar on top of the hour button indicates that there is a recorded video file on that period of time. While the red bar indicates that you are currently viewing the recorded video file.

Name	Function
(5) Playback Control Buttons	<p>Begin: Move at the beginning of the recorded video file.</p> <p>Previous: Go back to the previous frame.</p> <p>Slower: Play the recorded video file at the speed of 1/2x, 1/4x, or 1/8x.</p> <p>Rewind: Wind back the recorded video file.</p> <p>Pause: Briefly stop playing the recorded video file.</p> <p>Play: Play the recorded video file.</p> <p>Faster: Play the recorded video file at the speed of 2x, 4x, 8x, 16x or 32x.</p> <p>Next: Go to the next frame.</p> <p>End: Go to the end of the recorded video file.</p>
(6) Date	Select the date on the calendar and the time from 00 to 23 to where to start playing the recorded video file.
	<p>The numbers from 00 to 23 represent the time in 24-hour clock. The numbers from 01 to 16 represent the camera ID. The blue colored column indicates that there is a recorded video file on that period of time. While the red colored column indicates on where to start playing the recorded video file.</p>
(7) Preview	Switch to Preview/Playback mode.
(8) Playback	Switch to Playback mode. This allows you to view the recorded video file.
(9) Status bar	Display the recorded date, time and play speed.
(10) Camera ID	Show the number of cameras that are being viewed. When you are in single screen mode, click the camera ID number to switch and view other camera.
(11) iPOS Search	To search iPOS event
(12) Output	Save the segmented file in *.mpg, *.avi, or *.dvr format (see also Chapter 3.7).
(13) Segment	Keep a portion of the recorded video (see also Chapter 3.7).
(14) Print	Print the screen shot.
(15) Snapshot	Capture and save the screen shot either in *.jpg or *.bmp format.

Name	Function
(16) Full screen	<p>Use the entire area of the screen to only display the video. To return, press the right button of the mouse or ESC on the keyboard or click the arrow icon.</p>  <p>Click the arrow icon to leave from full screen display mode</p> <p>When you switch to full screen in multiple-screen mode, Left click to toggle to only display one of the video in the multiple-screen mode or all.</p>
(17) Event log	Show the record of activities that take place in the system. To filter the records, select and click the option button to only display Event, System, Operation, Network or POS.
(18) Bookmark	Mark a reference point when previewing the recorded video file to which you may return for later reference. You may also set it to protect the file. (See also Chapter 3.8)
(19) Visual Search	Search from a specific camera by Date, Hour, Minute, 10 Seconds and Second. (See also Chapter 3.9)
(20) Find Next	Search for the next event or changes in the motion detector frame. You can use this when you are using Intelligent Search or Event Search function.
(21) Event Search	Search from the recorded activities that take place in the system (i.e., Sensor, Motion , Video Loss, POS) . (See also Chapter 3.10)
(22) Intelligent Search	Search the changes in the motion detector frame (See also Chapter 3.11).

3.4 Function Buttons in Compact Mode

To view in Compact mode, click **Exit** button. In the logout dialog box, click **Compact**.

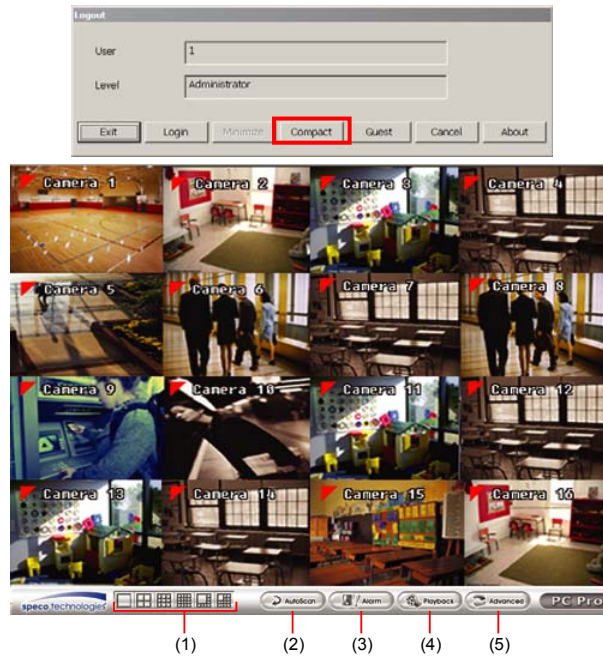

Name	Function	
(1) Split Screen Mode	Select from 7 kinds of split screen type to view all the camera, or one camera over the other or alongside on a single screen.	
 <ul style="list-style-type: none"> - If there are only 4 cameras, you won't be able to switch to 9, 16, and 13 split screen mode. - When you are in single screen mode, Right click and Drag a square on the area you want to enlarge. - When you are in multiple-screen mode, Right click the video screen of the camera and Drag on where you want to locate it. To only display one of the video in the multiple-screen mode, Left click the video screen you want to display. 		
	(2) Sequence	Start/Stop video screen cycle switch
	(3) Alarm	Alert and display warning info.
(4) Playback	Switch to Playback mode. This allows you to view the recorded video file. (see Chapter 3.3)	
(5) Advanced	Switch to Preview/Advanced mode.	

3.5 Function Buttons in PTZ Camera Controller

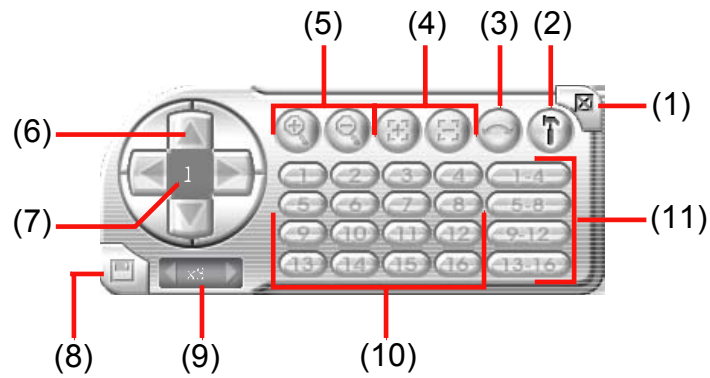

Name	Function
(1) Close	Exit PTZ camera controller.
(2) Setup	Configure PTZ cameras.(see Chapter 3.11)
(3) AutoPan	Operate the PTZ cameras automatically based on the selected camera group preset position number.
(4) Focus +/-	Adjust the focus manually to produce clear image.
(5) Zoom +/-	Zoom in and out the image.
(6) Direction buttons	Adjust and position the focal point of the PTZ camera.
(7) Camera ID pane	Display the PTZ camera number that is being operated.
(8) Save Camera preset position	Save the PTZ camera preset position number. Select the camera and click the preset position number and save it.
(9) Camera lens speed controller	Adjust the moving speed of the PTZ camera lens.
(10) Camera preset position number	Move the PTZ camera to the preset point.
(11) Group AutoPan	Select to automatically operate PTZ camera in group.

3.6 Setting Up and Using the EMAP

EMAP can hold up to 8 maps in *.bmp/*.jpg format. You may locate the camera, sensor and relay on the map.

3.6.1 To Set Up the EMAP

1. Click **EMAP**.
2. When the EMAP screen appears, click the area number (1 to 8 buttons) on where you want to insert the map.
3. Click **Load Map** to insert the map. When the open dialog box appears, locate and select the map and click **Open**.

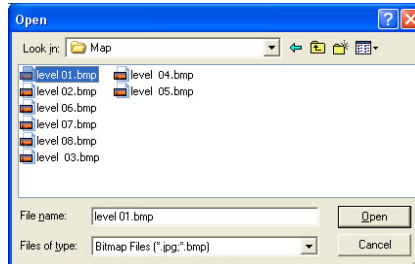

4. When the inserted map appears on the EMAP screen, click **Edit**. You may now drag the camera, sensor, and relay icons to its place on the map. Icons on the map can be relocated anywhere. If you are going to locate the icon on the map to other area, you need to drag the icon to the black pane at the bottom of the EMAP screen and then switch to the area on where you want to locate the icon. To bring all the icons back to the black pane at the bottom of the EMAP screen, click **Reset Icon**.

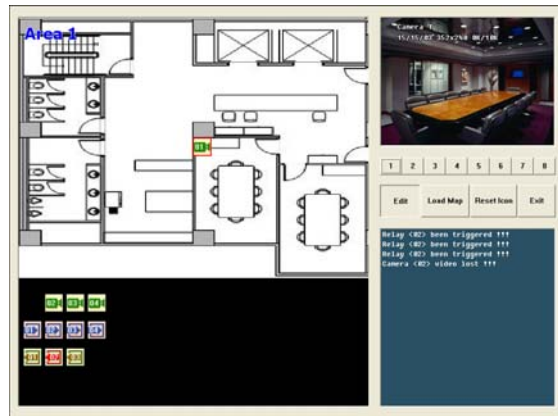

5. When you are done, click **Edit** button to save the new setting. To close EMAP screen, click **Exit**.

3.6.2 To Use the EMAP

To use the EMAP:

1. Click **EMAP**.
2. In the EMAP screen, click the camera icon to switch on the area where the camera is located on the map and to display the video at the upper right corner of the EMAP screen. At the lower right corner of the EMAP screen, it lists all the warning message.

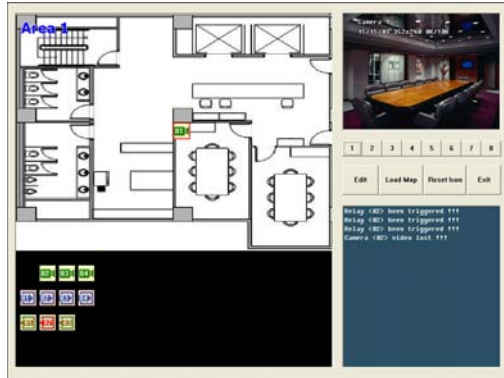

3. Click **Exit** to close EMAP screen.

3.7 To Cut and Save the Wanted Portion of the Recorded Video

1. Use the Playback Control buttons or drag the bar on the playback progress bar and pause on where you want to start the cut. Then, click **Segment** to set the begin mark.



2. Use the Playback Control buttons or drag the bar on the playback progress bar and pause on where you want to end the cut. Then, click **Segment** to set the end mark. To cancel segmentation or set the segment marks from the start, click **Segment** button again.



3. Click **Output** button to save the wanted clip.
4. In the **Save As** dialog box, locate on where you want to save the file, type the filename, and select the video format.

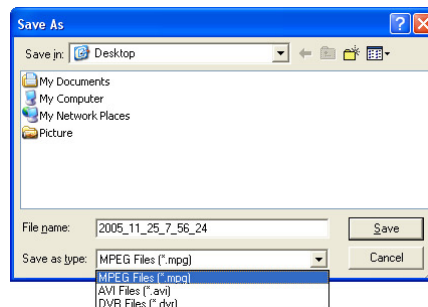

3.8 To Bookmark a Section of the Video

1. Click **Bookmark**. The video playback stops when the bookmark button is executed.
2. In the Bookmark dialog box, you may do the following:
 - **Add** to include the new reference mark in the bookmark list. You may select to enable/disable file protection.
 - **Edit** to change the mark description or enable/disable file protection.
 - **Delete** to remove the selected reference mark in the list.
 - **Delete All** to remove all the reference marks in the list.
 - **Exit** to close Bookmark dialog box.



- When the bookmark is protected, the file won't be overwritten.
- The protected bookmark file will be deleted when the **Delete the recorded data** is enable in the **System setting**. (also refer to [4.1 System setting](#))

3. Select and click one in the bookmark list to preview the file.

3.9 To Search Using the Visual Search

1. Click Visual Search.
2. In the Visual Search Setting dialog box, select the Camera number and the date. Then click **OK**.

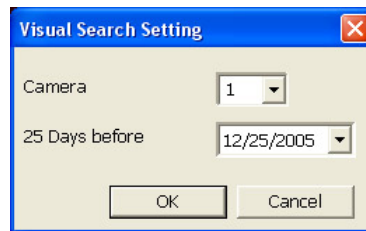

3. When a series of frames appear by date, click on the frame to display another series of frames and search by every Hour of that date, every Minute of that hour, every 10 Seconds of that minute, every Second of that 10 seconds. To go back, click . To view from the selected frame and close event search, click .



3.10 To Search Using the Event Search

Click on the video screen on where you want to search.

1. Click **Event Search**. The Event Search text (red) would appear at the lower left corner of the screen.
2. In the Event Search Setting dialog box, check the type of condition you want to search. If you select POS, in the Find Text box, type the word. Then, click **OK** to start searching. The video search would stop at the frame that matches the condition. To keep on searching click .
3. You may also set to search and list all the result. Just check the **Output Event List** box. In the Search Duration section, set the **Begin Time**, **End Time** and **Searching Interval**. Then, click **OK** to start searching.

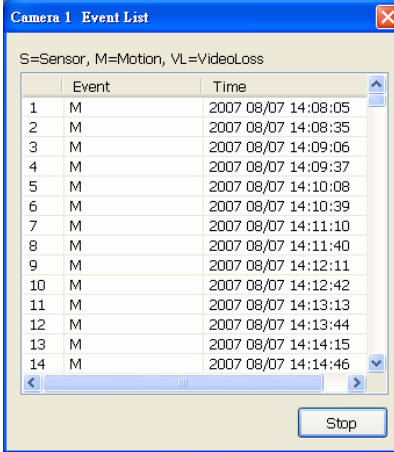

Camera 1 Event List

S=Sensor, M=Motion, VL=VideoLoss

	Event	Time
1	M	2007 08/07 14:08:05
2	M	2007 08/07 14:08:35
3	M	2007 08/07 14:09:06
4	M	2007 08/07 14:09:37
5	M	2007 08/07 14:10:08
6	M	2007 08/07 14:10:39
7	M	2007 08/07 14:11:10
8	M	2007 08/07 14:11:40
9	M	2007 08/07 14:12:11
10	M	2007 08/07 14:12:42
11	M	2007 08/07 14:13:13
12	M	2007 08/07 14:13:44
13	M	2007 08/07 14:14:15
14	M	2007 08/07 14:14:46

Stop

4. When the Event list appear, click and select the item you want to view.

3.11 To Search Using the Intelligent Search

Click on the video screen on where you want to search.

1. Click **Intelligent Search**. The Intelligent Search text (red) would appear at the lower left corner of the screen.
2. When the Intelligent Search Setting dialog box and motion detector frame appear, you may adjust the sensitivity bar and the motion detector frame size and location. To set motion detector frame size and location, left click and drag on the screen. Then, click **OK** to start searching. The video search would stop at the frame that matches the condition. To keep on searching click .
3. You may also set to search and list all the result. Just check the **List** box. In the Search Duration section, set the **Begin Time**, **End Time** and **Searching Interval**. Then, click **OK** to start searching.

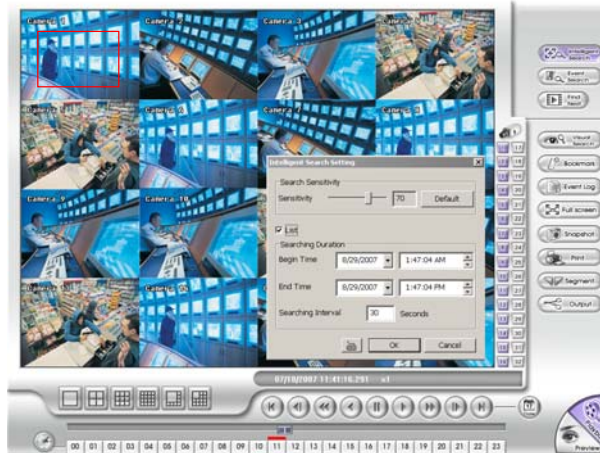

3.12 To Setup the PTZ/IP PTZ Camera

3.12.1 Setup the PTZ Camera

1. In the PTZ control panel, click **Setup**.
2. When the PTZ Setup dialog box appears, select the camera number and check the **Use PTZ** box.

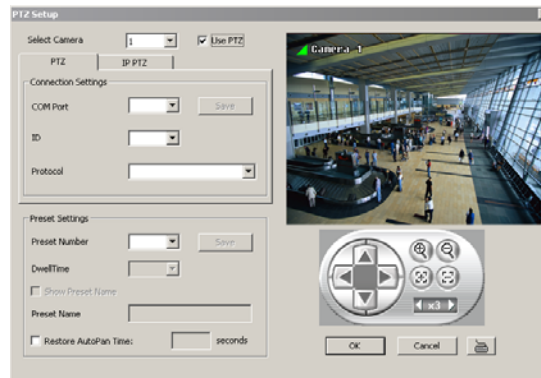

3. In the Connection Settings section, select the **COMPort** where the PTZ camera is connected, PTZ ID number and PTZ camera protocol. Then, click **Save** to keep the settings.
4. Use the PTZ control panel and adjust the position of the PTZ camera.
5. In the **Preset Setting** section, select the preset number to assign a number for the PTZ camera current position. Set the **DwellTime** (1-60 sec) for how long the PTZ camera stays in that position before it moves to the next one. If you want to add description, check the **Show Preset Name** box and in the **Preset Name** text box, type the word. When done, click **Save** to keep the settings.
6. Repeat step 4 & 5, if you want to save another PTZ camera position.
7. **Restore AutoPan Time:** set a time period for restoring auto path function after the PTZ camera has been moved. Mark the check box and set the time period in second.
8. When done, click **OK** to save the setting or Click **Cancel**, to leave without saving the new setting.

3.12.2 Setup the IP PTZ Camera

1. In the PTZ control panel, click **Setup**.
2. When the PTZ Setup dialog box appears, click **IP PTZ** tab.
3. Select the camera number and check the **Use PTZ** box.

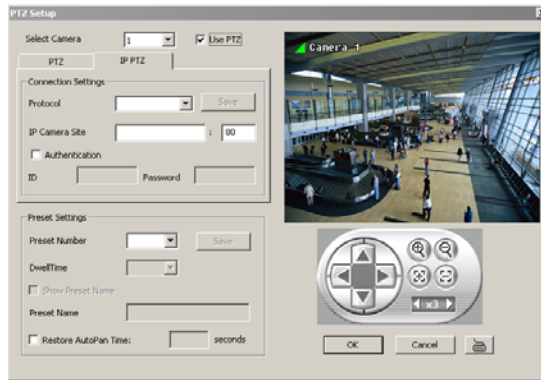

4. In the Connection Settings section, select the **Protocol** where the PTZ camera is connected and IP Camera Site that IP or URL of IP camera. Then, click **Save** to keep the settings.
5. Use the IP PTZ control panel and adjust the position of the IP PTZ camera.
6. In the **Preset Setting** section, select the preset number to assign a number for the IP PTZ camera current position. Set the **DwellTime** (1-60 sec) for how long the IP PTZ camera stays in that position before it moves to the next one. If you want to add description, check the **Show Preset Name** box and in the **Preset Name** text box, type the word. When done, click **Save** to keep the settings.
7. Repeat step 4 & 5, if you want to save another PTZ camera position.
8. **Restore AutoPan Time:** set a time period for restoring auto path function after the IP PTZ camera has been moved. Mark the check box and set the time period in second.
9. When done, click **OK** to save the setting or Click **Cancel**, to leave without saving the new setting.

Chapter 4 Customizing the DVR System

In the Preview/Advanced screen mode, click  button to customize your DVR. When the DVR configuration setup selection appears, select and click the buttons you want to change the setting.

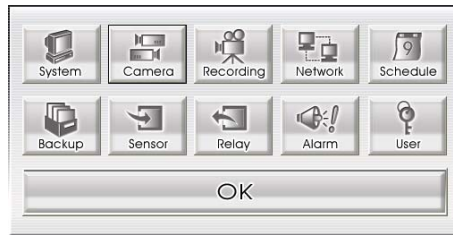

4.1 System Setting

In the System Setting dialog box, click **OK** to accept the new settings, click **Cancel** to exit without saving, and click **Default** to revert back to original factory setting for.

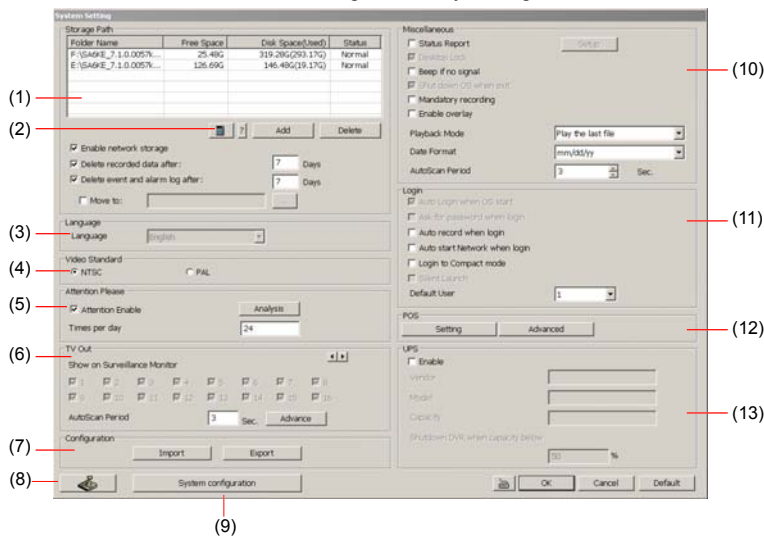

(1) Storage Path

Set the directory on where to save the data. When there is not enough free space to record one hour data, the system automatically replaces the oldest data. In case you have more than one storage path, the system automatically saves the data to the next storage path. You may also add additional network-attached storage (NAS) for extremely high storage capacity. Select the **Enable network storage** check box to send the recorded video in network-attached storage. To add network storage, the Internet storage drive/folder must be mapped as Network Drive in DVR server. Enable network storage first, and then, click **Add**. In **Browse For Folder** windows, select drive C and right click mouse button, select **Map Network Drive** option.

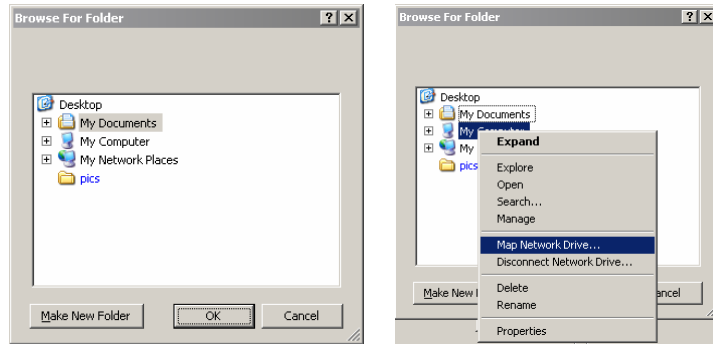

In the **Map Network Drive** windows, select the **Drive** and fill in the network drive direction in **Folder** column if you know. Or click **Browse** to find the folder direction. Click **Finish** to complete the network drive mapping. After the network drive has been added, user needs to create a folder for network storage. In **Browse For Folder** windows, select the network drive and right click mouse button to add a new folder. And then, click **OK**. User should see a new storage folder display in Storage path list.

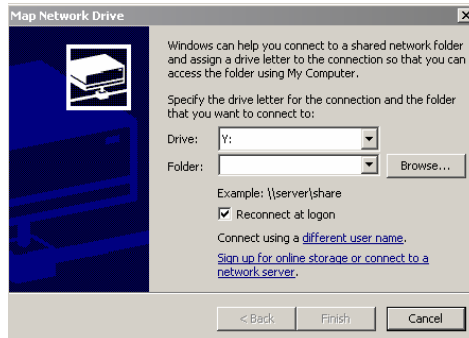

By default the data is stored in C:\Data, to insert another storage path, click **Add**. To remove the selected path, click **Delete**. If you want the system to automatically erase the data after a certain days, enable the **Delete recorded data after** check box and enter the numbers of days in **Days** text box. If you want the system to automatically erase the event and alarm log after a certain days, enable the **Delete event and alarm log after** check box and enter the numbers of days in **Days** text box. To change logs save direction, enable **Move to** and select the new save direction.

(2) Hard Disk Calculator

Estimate the hard disk recording capacity. The result of calculation is a rough value which only for reference. The hard disk record capacity will be varied by the real record quality and complexity of video scene.

Click , the hard disk calculator windows will show up. **Total Recording time** is the current hard disk recording capacity. Enter the expect hard disk size or expect recording time in **Expected HD Size** or **Expected Record time**, and then click **Calculate** button. Click **OK** to exit the hard disk calculator windows. The hard disk calculation will be based on the recording setup and current hard disk setup.

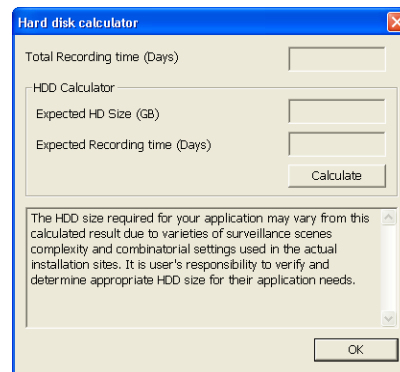

(3)Language

Customize the system to display the tool tips and dialogs based on the selected language. By default the language is in English.

(4) Video Standard

Change and select the proper video system according to your camera video system. If the video system setting is wrong, the video would appear abnormal.

(5) Attention Please

Check the attentiveness of the person who is monitoring the system. You may set the number of times the Attention dialog box is to appear in a day in **Times per day** text box. To check the graph on how fast the persons response is click **Analysis**.

When this feature is enabled, the Attention dialog box would appear. The person who is monitoring the system must enter the same number that appears from the left box at the right text box and then click **OK**.

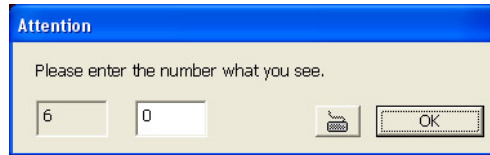

(6) Call Monitor Out

Select the camera you want to appear on the Call Monitor and set the time gap from 3 to 10 sec. before it switches to the next camera.

- Advance button

Select the View mode and cameras the user wants to display on the Call monitor.

In Advance mode, the user has two types of display selections –Sequence and Fixed layout.

- Sequence

(1) Select the display mode as Sequence.

(2) **Preview screen:** Live camera video would be displayed here.

(3) **Video Mode:** Select the video mode user wants to display on screen. The system will sequence to display the next channels..

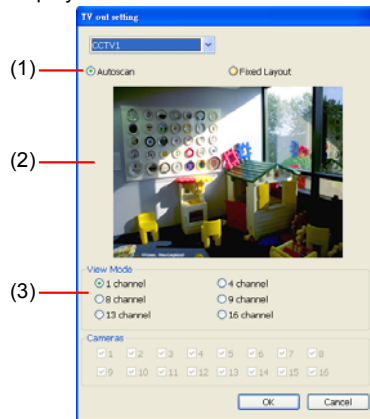

Fixed Layout

(1) Select the display mode as **FixedLayout**.

(2) **Preview screen:** the selected camera video will preview in here.

(3) **Video Mode:** Select the split mode of TV out display.

(4) **Cameras:** User can select the cameras that user wants to display on the screen. Only those selected channels would be displayed on the screen. Also, the camera will be displayed by the selecting order.

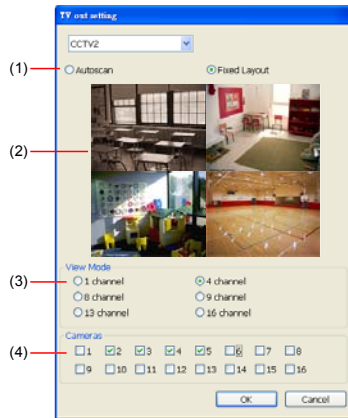

(7) Configuration

Backup a copy of all the settings and allows you to regain the same settings back. To save the current settings, click **Export**. To replace the settings with the one you have saved, click **Import**.

(8) System Controller Setup

To configure the parameters that is for communicating with the System Controller (an optional accessory). Also please refer to user manual of the System Controller.

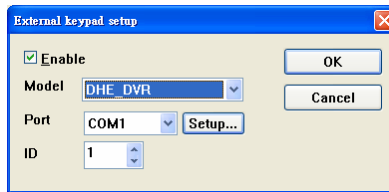

Enable – Mark the check box to enable the System Controller function.

Model – Select model of the System Controller.

Port – Select the com port that is connected with the System Controller. Click **Setup** to configure com port value. The com port value is shown in below table:

Baud rate	9600
Data bits	8
Parity	No
Stop bit	1
Flow control	No

ID – Set an ID for DVR server (0~99). This ID is a key for communicating between the System Controller and the DVR server.

i When the DVR server ID is X, the DVR server can be controlled by System Controller irrespective of the DVR ID that is selected in System Controller.

(9) System Configuration

To configure the DVR system date, time and IP address.

Date/Time Setup

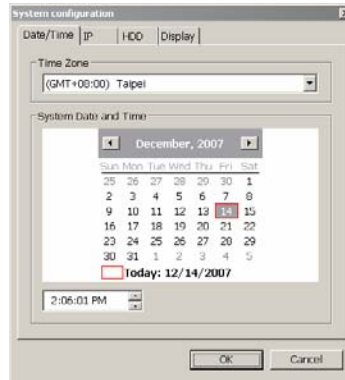

1. Select the **Time Zone** of DVR server located
2. Select the **Month** and **Date**. Click arrow button can switch to different month.
3. Adjust the **Time** by click spin box arrow button.
4. Click **OK** to save the configuration.

IP Setup



- **Obtain an IP automatically (DHCP):** To use DHCP server assigning DVR server a IP address.
- **Using the following IP address:** Assign a fixed IP address for DVR server
- **IP ADDRESS:** Assign a constant IP address which a real IP addresses give from ISP to DVR system.



Do Not assign the DVR to 1.0.0.0 network segment. It will cause the DVR can not access to Internet due to the un-recognize to 1.0.0.0 IP segment.

- **Mask:** It is a bitmask used to identify the sub network and how many bits provide room for host addresses. Enter the subnet mask of the IP address which user has assigned to DVR system.
- **GATEWAY:** A network device act as a passageway to internet. Enter the network gateway IP address
- **DNS:** Domain Name Server translates domain names (such as www.abb.com.tw) to IP addresses. Enter the IP address of DNS if it is available.

HDD Format

Select automatic or manual to format hard disk.



- Automatically

1. Select **Automatic**
2. Click **Format** to format the hard disk list in below table.

- Manual

1. Select **Manual**
2. Select the **Hard Disk, Partition**(maximum is 4), and fill in the **Size** of partition
3. Click **Format**
4. To reset the selection, click **Reset All**



Display

Select the screen display resolution – 1024 x768 or 1280 x 1024



(10) Miscellaneous

Enable the conditions in **Miscellaneous** section you want the system to perform.

- **Status Report**
Send a daily system event and attention analysis report. To change the e-mail settings, click **Setup**.
- **Beep if no signal**
Make sound when the video signal is lost.
- **Playback Mode**
Select the mode of playback the video.
Select date and time: Select the date and time which user wants to playback.
Play the last file: Automatically playback the video from the last hour
Instant Playback: Automatically playback the video which has just recorded
- **Date Format**
Select the date format which wants to display in **Select date and time** playback mode
- **Sequence Period**
Set the time gap of the Sequence function from 3 to 10 seconds. This automatically switches to the next video in cycle depending on the set time gap.
- **Enable Overlay**
Through the overlay function of VGA to display out video image which it enhance video signal for better video quality.

(9) Login

Enable the conditions in Login section you want the system to automatically carry out.

- **Auto record when login**
Automatically start video recording when the DVR system is executed.
- **Login to compact mode**
Switch to compact mode directly when the DVR system is executed.
- **Default user**
Automatically log in to the selected default user when the DVR system is executed.

(10) POS

Set from which camera screen to display the data from the POS equipment. Click **Setting**, to set the POS Console Setting. To set the text flow and color format, click **Advanced**. (see also [Chapter 4.1.1](#))

(11) UPS (Uninterruptible Power Supply)

Protect the system from damaging, such as power surges or brownouts. This automatically gives time to close the DVR system properly when the battery backup power has reached the Shutdown when capacity below percentage level setting. The UPS device must be connected to your DVR unit.



The DVR system default supports SPECO UPS.

4.1.1 To Set the POS Setting

In the **System Setting** dialog box, POS section, click **Setting**. To set the text flow and color format, click **Advance**.

1. In the POS Console Setting dialog box, click **Add** to set a new POS setting, **Modify** to change the POS setting, and **Delete** to remove the selected POS setting. Click **OK** to save and close POS Console Setting.

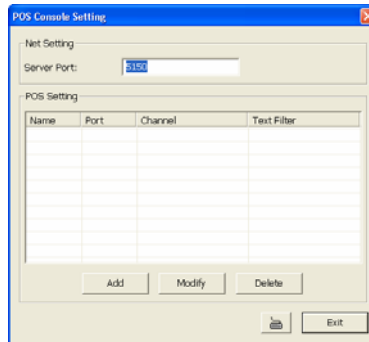

2. In the POS Mapping dialog box, click **OK** to accept the settings and **Cancel** to exit without saving the new setting.

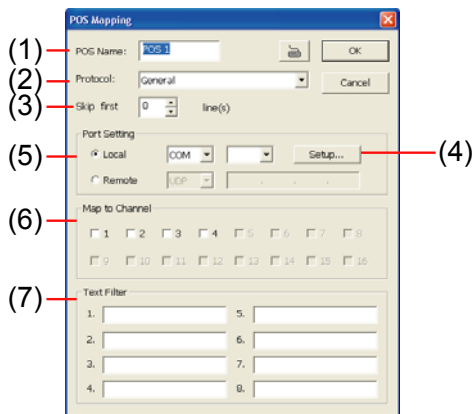

- (1) **POS Name:** Enter a name to identify the POS
- (2) **Protocol:** Select General for Epson compatible printer or for TP_3688
- (3) **Skip first:** Set the number of lines you want to be removed
- (4) **Setup...:** Set the COM Properties. If you are not sure, please contact your POS service provider

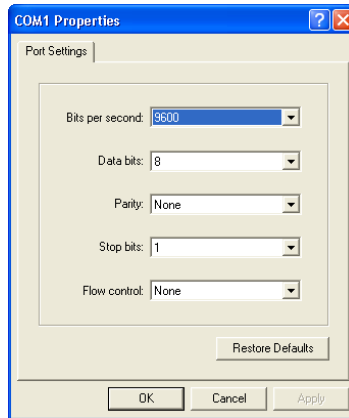

- (5) Port Setting:** Select the Local or Remote port to where it is connected
Local - select the COM port number which is connected.
Remote – Use the UDP protocol for remote connection if POS system can broadcast to Internet. Enter the IP address of the remote station.
- (6) Map to Channel:** Select to which camera number to display the transaction text
- (7) Text Filter:** Enter the word you want to be removed

4.2 Camera Setting

In the Camera Setting dialog box, click **OK** to accept the new settings, click **Cancel** to exit without saving, and click **Default1/ Default2** to revert back to original factory setting.

- i** Default 1 value is Bright 50, Contrast 50, Hue 50, and Saturation 50
Default 2 value is Bright 55, Contrast 53, Hue 50, and Saturation 80

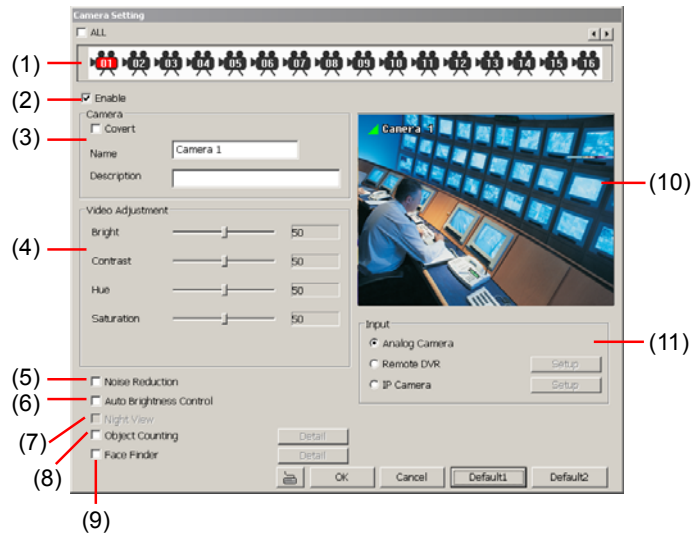

(1) Camera Icons

Select the camera number you want to adjust the video setting. To select all the cameras, enable the **ALL** check box. To select more than one camera, **Right click** on the camera icon. To select one camera only, **Left click** on the camera icon. The camera icon turns red when it is selected.

(2) Enable

Set to enable/disable the selected camera. When there is no video source on the camera, we suggest disabling it so that the system won't detect it as video loss error.

(3) Camera

- **Covert**
Enable/disable to show the video. Even if the video of the selected camera is hidden you can still record the video and preview it in playback mode
- **Name**
Change the camera name
- **Description**
Add a short comment

(4) Video Adjustment

Adjust the Brightness, Contrast, Hue and Saturation of the selected camera.

(5) Noise Reduction

Reduce undesirable video signal and improve the quality of the video.

- i** Noise Reduction uses lots of CPU resource. Please use this feature only if it is really necessary.

(6) Auto Brightness Control

Automatically adjust the brightness

(7) Night View

Automatically adjust the exposure to make the image more visible especially when the site is dark. You can only use this function when the Auto Brightness Control is enabled

(8) Object Counting

Select the two regions on the screen and the system will count the objects that appear from one selected region and move to another selected region. (See also [Chapter 4.2.1](#))

(9) Face Finder

To setup the human face detection and capturing from live and recorded video for security issue. Click **Detail** to enter the Face Finder setup window. To set the value back to default, click **Default** button.

-  - The face detection angle is around 30 ~ 45 degrees for both side of face and 25 ~ 30 degrees for look up and down of face.
- It is to recommend that user install the camera in the position of light comes in for better face detection result.

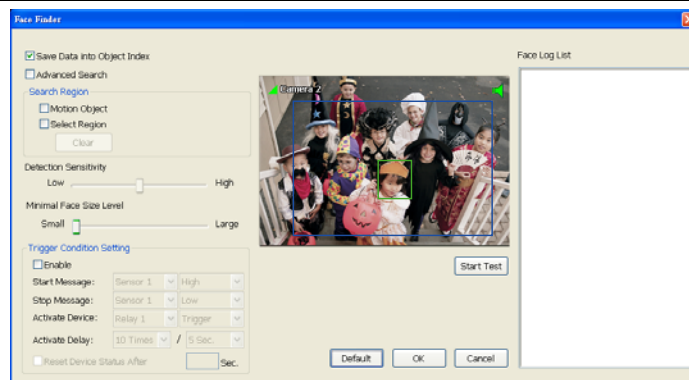

- **Save Data into Object index:** Mark to enable face detecting and capturing face image to display on face object log. The default is enabled when the Face Finder is enabled.
- **Advanced Search:** Beside face recognition, the system will also focus the detection on eyes of face.
- **Search Region:** Select condition of face detection and setup face detects area.
 - **Motion Object:** Only when the human face is moved, the system will detect and the face will be captured.
 - **Select Region:** Setup the face detects area. The system will only detect the face in the selected area. On the preview screen, use mouse to drag the area that user wants to search. User should see the blue frame on the preview screen of Face Finder setup window. User can select multiple areas for detection. To clear the selected area, right click the mouse button and drag the selected area to clear. Or, click **Clear** to clear all selected areas.

- **Detection Sensitivity:** To set the sensitivity level of face detection. More higher is more easily to detect the difference of the face.
- **Minimal Face Size Level:** To set the face detection of minimal size. The system will only detect the face size is equal or greater than the minimal face size. User should see a green frame on the preview screen of Face Finder setup window.
- **Trigger Condition Setting:** Set the conditions of the face detection that is trigger by outside device such as sensor, relay device.
 - **Enable:** Mark to enable **Trigger Condition Setting**.
 - **Start Message:** Set the sensor level that will trigger the face detection. The default is high.
 - **Stop Message:** Set the sensor level that will reset the condition of face detection. The default is low.
 - **Activate Device:** Set the activate level of relay device. When the face detects condition meets the condition in **Activate Delay**, the relay will send out the signal and the system will send out the face object log. The log can be viewed in Face Object Log.
 - **Activate Delay:** Set the condition for activating relay device to send out the log to DVR system. Select the time (second) and times (the number of face has been detected) from drag down list.
 - **Reset Device Status after seconds:** Set the time period to reset activate device back to normal status. It works only when the activate status is set to trigger.

After set up, click **Start Test** to test the configure result. When the system is detecting face, the red frame will show up on the screen. The test result will display in Face log List windows as below figure shown:

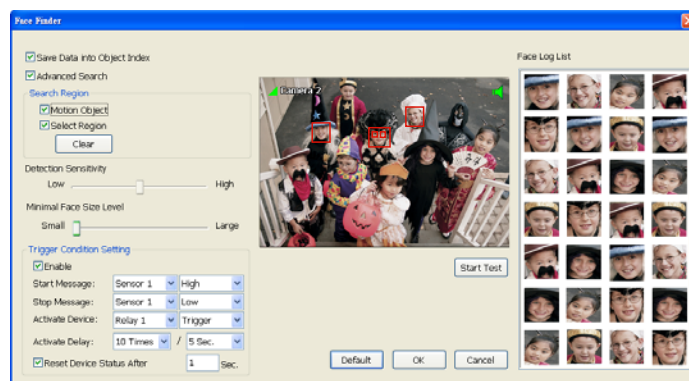

(10) Video Screen

Display the video of the selected camera

(10) Input

Select the type of video camera input you are using

- **Analog Camera**

The video source is coming directly from camera that is connected to the SA Series PCI card DVR.

- **Remote DVR**

The video source is coming from another DVR server. In the Remote DVR dialog box, enter the server IP, port number, user ID, password and select the camera number.

If you are not sure of the server IP and port, please check the DVR server IP address in Network setting.

- **IP Camera**

The video source is coming from Network camera or IP camera. In the IP Camera Settings dialog box, select to connect using Protocol or URL and then enter the required info. If it requires user identification of IP camera, enable **Authentication** check box and enter User ID and Password. If you are not sure of the Protocol or URL info, please refer to the IP camera manual or contact your IP camera local distributor.



To setup advance camera audio setting, click **Detail** button. User can adjust IP camera's video size, frame rate, quality, bright, contrast, hue, and saturation.

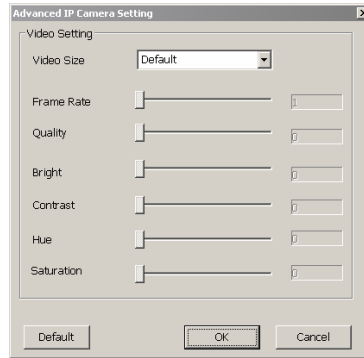

4.2.1 Setup the Object Counting

1. Click **Detail** to enter the object counting setup window.

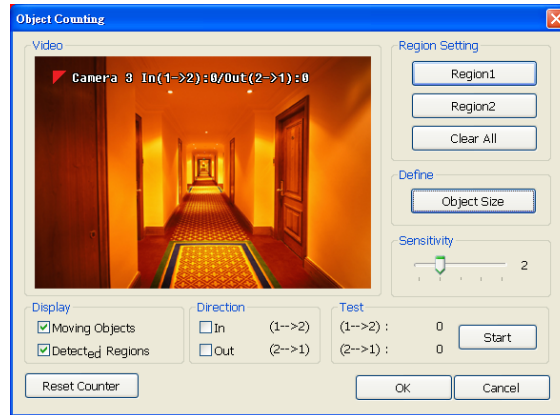

2. Enable **Detected Regions** in **Display** section. This enables the object counting information show on the screen. **Moving Object** will enable the object size frame to show on the screen.
3. Click **Region1** and press left button of mouse and drag the area that user wants the object to be counted. And then, click **Region2** and drag another area that user wants the object to be counted, too. Those selected regions will mark in different color. The system will count the objects that move between the selected regions.
4. Click **Object size** to define the detected object dimensions. Press left button of mouse and drag on the screen. To see the object size frame on screen, enable **Moving Object** in Display section.
5. Adjust the sensitive of object detecting.
6. To test the setting, mark the **Directions (In/Out)** that you want to be tested want to be test and click **Start**. The testing result will show in Test section.
7. Click **OK** to save the setting. Click **Cancel** to leave the setup window without saving.
8. The object counting information will be displayed on the video screen of upper part..

Object counting information display

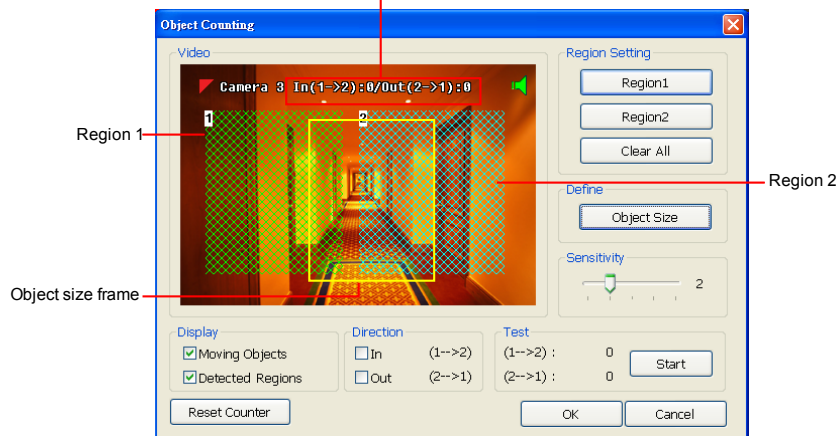

4.3 Recording Setting

In the Recording dialog box, click **OK** to accept the new settings, click **Cancel** to exit without saving, and click **Default** to revert back to original factory setting.



(1) Camera Icons

Select the camera number you want to set the recording setting for. To select all the cameras, enable the **ALL** check box. To select more than one camera, **Right click** on the camera icon. To select one camera only, **Left click** on the camera icon. The camera icon turns red when it is selected.

(2) Recording Mode

The blocks from 00 to 23 represent the time in 24-hour clock. To record in full 24 hours, select the recording mode and click the **⊙** button. If you want to only record at a particular time, click the colored block beside the recording mode then click on the time blocks. When the system starts recording a red triangle mark would appear at the upper left corner of the screen. The recording modes are listed below:

- **Always Recording**
Record the video from the selected camera and save it to the designated storage path (see also [Chapter 4.1 #1](#)).
- **Motion Recording**
Start recording the video from the selected camera only when the system detects movement. Once a motion is detected, the system automatically saves the previous frames and stop based on the **Start Record Prior** and **Stop Record After settings**.
- **Smart Recording**
Automatically switch to record at the maximum frame rate setting once a motion is detected and if there is no motion, it records at the minimum frame rate setting Set the maximum and minimum frame rate setting in [\(7\) Frame Rate](#) section.
- **Voice Detecting Recording**
DVR system will record the sound when the voice exceeds the intensity value in Voice Detection setting.

- **No Recording**

The system won't do any recording.

(3) Enable Audio

Select to assign the audio channel of the selected camera. You can only assign one audio channel to one camera source. This way you can record both audio and video.

(4) Motion Detection

Adjust the sensitivity of the motion detector. The higher the value, the finer the sensitivity is detected. When it detects motion, a green triangle mark would appear at the upper left corner of the screen.

(5) Voice Detection

Adjust the intensity of the audio detector. The system detects sound when it exceeds the intensity value.

(6) Quality

Adjust the video quality. The higher the value, the lower the compression level and uses more hard disk space.

(7) Frame Rate

Set the maximum and minimum number of frames to be recorded during motion and motionless state. The frame rate ranges from 1 to 30 for NTSC and 1 to 25 for PAL. The higher the frame rate, it uses more hard disk space.

(8) Video Size

Select the size of the video and click the  button. The higher the size, the larger the file it create. You can also activate the **Enable Deinterlace** to enhance the video quality. Set the **Enable Deinterlace** mode to #1, if you are capturing motionless picture and #2, if it captures lots of movement.

(9) Video Screen

Display the video of the selected camera

(10) Mask/Shield Edit

Mask, mark an area on the screen to disregard the motion in the marked area and to only monitor outside the marked area. As for the Shield, it covers an area on the screen and the covered area would not be visible on the screen and recorded. (see also [Chapter 4.3.1 and 4.3.2](#))

(11) Compression Type

You can encrypt the recorded video that way only the person who knows the password can clearly view the video playback. The file size would become 10 to 30% more. Enabling the Video Encryption check box, you will be prompted to enter the password and retype the password for confirmation. Make sure not to forget the password for you would not be able to decrypt the video without it.

The  symbol would appear on the upper right of the encrypted video screen. You may see the video during live recording (see also [Chapter 4.3.3](#)).





4.3.1 To Mask/Shield an area on the screen

1. In the Mask/Shield Edit section, activate the **Enable Mask/Enable Shield** check box.
2. In the Edit section, select between Mask or Shield and click the ⊙ button.
3. Click and drag a frame on the **(9) Video Screen** to create Mask or Shield area.

4.3.2 To show and change the color of the Mask

1. Enable the **Show Mask** check box.
2. In the Color section, select the color and click ⊙ button.

4.3.3 To Playback Encrypted Video

On Playback, Webcam, and Remote Console video screen, just click  and enter the correct password to decrypt and playback the video.

To encrypt the recorded video back, click  and enter a **WRONG** password.



It is important to encrypt the video again, to avoid unauthorized user viewing the video.

4.4 Network Setting

In the Network Setting dialog box, click **OK** to accept the new settings, click **Cancel** to exit without saving, and click **Default** to revert back to original factory setting.

The screenshot shows the 'Network Setting' dialog box with the following sections and callouts:

- (1) Server Name: A text input field.
- (2) Transmitting Cameras: A section with a 'All' checkbox and 16 numbered checkboxes (1-16).
- (3) Main Configuration: Includes 'Server IP' (dropdown menu showing 192.168.153.125) and 'Remote Console PORT' (text input field showing 5550).
- (4) Dynamic DNS: Includes 'Domain Name' and 'Password' text input fields.
- (5) Remote Control Server: Includes 'Enable' checkbox (checked) and 'PORT' text input field (showing 5551).
- (6) Network Video Configuration: Includes 'Quality Level' and 'Frame Rate Level' sliders, both set to 3.
- (7) WebViewer Configuration: Includes 'Enable Anonymous Login' checkbox (unchecked) and 'WebViewer PORT' text input field (showing 80).
- (8) Voice Phone: Includes 'Talk to Web-Client' checkbox (checked) and 'PORT' text input field (showing 5552).
- (9) Network Time Synchronization: Includes 'Time Server' text input field (showing time.nist.gov), 'Automatic synchronize at' dropdown menu (showing 09:00), and a 'Synchronize Time Right Now' button.
- (10) Other Configuration: Includes 'Enable U2FP', 'Enable White List', 'Enable HandyViewer', and 'Network Bandwidth Limit' checkboxes (all unchecked), each with a 'Default' button.

At the bottom of the dialog box are 'OK', 'Cancel', and 'Default' buttons.

(1) Server Name

Assign a name for the DVR unit. Letters of the alphabet and numbers only.

(2) Transmitting Cameras

Select and click on the camera number(s) in the Transmitting Camera section you want to make accessible via internet using WebViewer, Remote Console, PDA Viewer and HandyViewer (still image). To select all the cameras, enable the **ALL** check box.

(3) Server IP

Set the Server IP and Remote Console Port number. The system will automatically detect your Server IP address. You need this when accessing DVR server from the remote location via internet.

(4) Dynamic DNS (Domain Name System)

Enter the Domain Name and Password. To use this feature, first register your domain name on the following Web site <http://ddns.dss.com.tw>

1. User Login

Browse the website ddns.dss.com.tw with Microsoft IE or Netscape Navigator to access the following dialog. You will be prompted to enter CD key number, product name, password, and user information. Use this service if the IP address changes each time when you connect to internet.

The 'User Login' dialog box has a blue header and a light blue background. It contains:

- 'CD-Key No.' text input field.
- 'Product' dropdown menu.
- 'OK' and 'Reset' buttons at the bottom.

- First input CD-Key number (serial number) and select the product name.
- Then click **OK** to login or **Reset** to clear the previous input.

2. User Information

Please provide the following user information, **Host Name** (user can choose any name he/she likes except the one violence with other users), **Password**, **E-mail**, **Company**, and **Country**. And then, click **OK** to complete the domain name registration.



The screenshot shows a web form titled "User Information" with a blue header. The form contains the following fields and controls:

- Host Name:** A text input field with a red asterisk to its right.
- Domain Name:** A text input field containing the value "avers.com.tw".
- Password:** A text input field with a red asterisk to its right.
- Confirm Password:** A text input field with a red asterisk to its right.
- E_mail:** A text input field with a red asterisk to its right.
- Company:** A text input field.
- Country:** A dropdown menu currently showing "United States".
- Buttons:** "OK" and "Reset" buttons at the bottom.

(5) Remote Control Server

Enable/disable remote control from remote application (ex. CMS). Enter the remote accessing port in **Port** column.

(6) Network Video Configuration

Set up the video quality and frame rate for viewing and transmitting to the remote program. Scrolling adjust bar to set the **Quality level** and **FrameRate level**.

(7) WebViewer Configuration

Activate **Enable Anonymous Login** to remotely access the DVR server without the need of password and **Talk to Web-Client** to use the 2-Way Talk feature that allows the client and server to talk via internet using microphone. Make sure both microphone and speakers work before using this feature.

If the **Talk to Web-Client** is disabled, the person in the DVR server side can only hear the voice from the client side that is when the WebCam 2-Way Talk button is activated. (see also [Chapter 7.1 #6](#)).



Make sure that your Webcam Digital Signature is updated yearly; else you won't be able to access the DVR server from the DVR WebViewer. To update/download your WebViewer Digital Signature, click **Update WebViewer Digital Signature**. Make sure your PC is connected to internet.

(8) Voice Phone

The **Talk to Web-Client** is to use the 2-Way Talk feature that allows the client and server to talk via internet using microphone. Make sure both microphone and speakers work before using this feature. If the **Talk to Web-Client** is disabled, the person in the DVR server side can only hear the voice from the client side that is when the WebCam 2-Way Talk button is activated. (see also [Chapter 7.1 #6](#)).



Make sure that your Webcam Digital Signature is updated yearly; else you won't be able to access the DVR server from the DVR WebViewer. To update/download your WebViewer Digital Signature, click **Update WebViewer Digital Signature**. Make sure your PC is connected to internet.

(9) Network Time Synchronization

Adjust the DVR system time same as network time server. Fill in the **Time Server** IP address or domain name. Select **Automatic Synchronize** time to set automatic synchronize time on a daily

basis. Or, user can click **Synchronize Time Right Now** to adjust time right away.

(10) Other Configuration

- UPnP

Enable UPnP function to automatically configure the port setting on the local network. This function is available when there is UPnP device in the same network. It will write the DVR port information into the router or other network device

- Enable White List

An access permit list for the remote accessing of DVR server. Enter the IP address and click **Add**. Or, enter a range of IP address and click **Add**. To delete the IP from the list, select the IP and click **Delete** button. To reset the input, click **Clear** button.

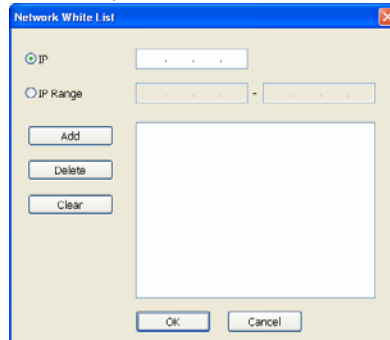

- Enable HandyView

Enable remote users to use a PDA or a mobile phone to access DVR server and select the video size and quality. (See also [Chapter 7.5](#) and [7.6](#))

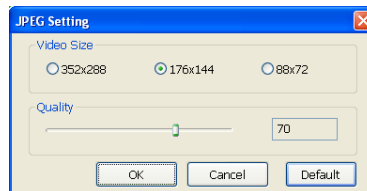

- Network Bandwidth Limit

By Channel: Set the network bandwidth by each channel.

All: Set the total network bandwidth consumption limit.

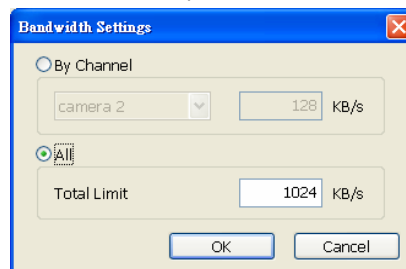

4.5 Schedule Setting

Schedule to record, backup, enable network, reboot and disable alarm of all the cameras either weekly or one time. The number from 00 to 23 represent the time in 24-hour clock. The left most column display the days in a week.

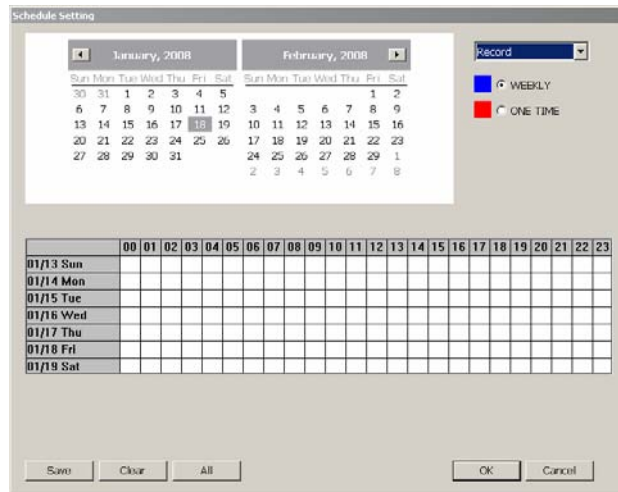

To Set the Schedule Setting:

1. Select the date in the calendar. Use and buttons to shift the calendar to the left or right.
2. Select the condition you want to schedule in the drop down list.
 - **Record**
Activate all the cameras to allow video recording at the set time based on the Recording setting (see also [Chapter 4.3](#)).
 - **Backup**
Save another copy of all the data at the set time and specified backup path. DVR automatically updates and will only backup the data that is not yet included in the archive. To assign backup path, click .



Make sure the backup folder and storage folder are not on the same drive.

- **Enable Network**
Activate DVR remote system to allow access at the set time. After the appointed time, the Network function will be disabled. If the Network function is already enabled, the Network function will not be disabled when the appointed time has ended.
- **Reboot**
Restart the PC at the appointed time.



Make sure the Windows operating system is set **NOT** to require you to login user name and password.

- **Disable Alarm**
Deactivate the alarm at the set time temporarily.

- **Turn on Relay #**

Active the Relay at the set time. If there are no Relays connected, Turn on Relay # function will not display in drag down list. The Relay number will depend on how many Relays are connected.

3. Specify to either schedule it weekly or one time. Click ☉ to make a selection.
4. Click on the blocks to set the schedule (see also [Chapter 4.5.1](#)). Or click All to select all. To store the setting, click Save. To remove the settings, click Clear.
5. To end Schedule Setting, click OK to exit and accept the setting and Cancel to exit without saving the setting.

4.5.1 Set schedule at specific portion of time

1. **Right click** the colored blocks.
2. In the Select time dialog box, click to enable or disable the portion you want to set.
3. Click **OK** to accept the setting and **Cancel** to exit without saving the setting.

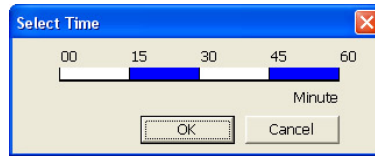

4.6 Backup Setting

In the Backup Setting dialog box, the number from 00 to 23 represent the time in 24-hour clock. The numbers from 01 to 16 represent the camera number. When you back up the file, you may find QLogViewer and Player application included in the backup folder (see also [Chapter 5](#)).

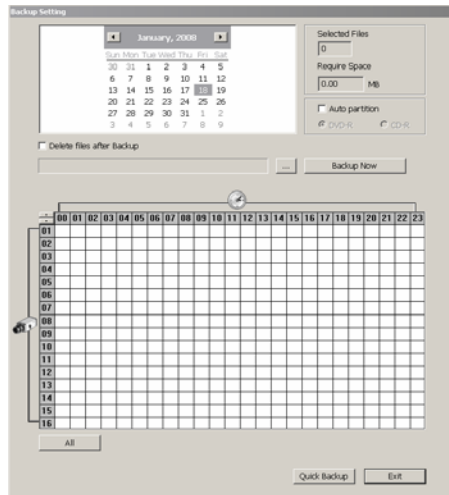

4.6.1 To Backup file

1. Select the date of the recorded file in the calendar you want to backup. Use ◀ and ▶ buttons to shift the calendar to the left or right.
2. In the table below, click on the blue block to select the recorded file. The blue block turns red when it is selected. The block that appears in white doesn't have data. If you want to set

the specific time, right-click on the selected block. Then, set the time to start and end.

3. Check the information beside the calendar.

Selected Files : Show the number of files selected.

Require Space : Show the total size of the selected file.

4. Enable Auto partition and select to divide the file size into DVD-R or CD-R. The DVR will automatically backup and divide the file sizes to facilitate burning into DVD or CD disc.
5. If you do **NOT** want to keep the recorded file in the storage folder, enable **Delete files after Backup** check box.
6. Click to set the path on where to store the backup file.
7. Click to start archiving the selected file.
8. In the Processing... dialog box, to stop archiving press **Abort**. When done, the Backup Path list, shows the archived item. To burn the file in CD, select the item in the list and click **Burn**. Click **Exit** to end this procedure and burn it later.

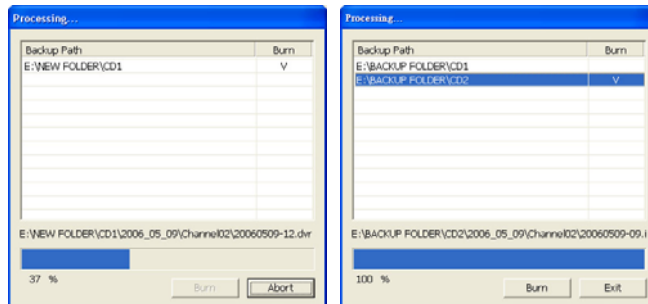

9. In CD/DVD Backup, enable/disable Delete file after burning check box to remove the archived file after burning. Click **Burn** to start and **Exit** to cancel this process.

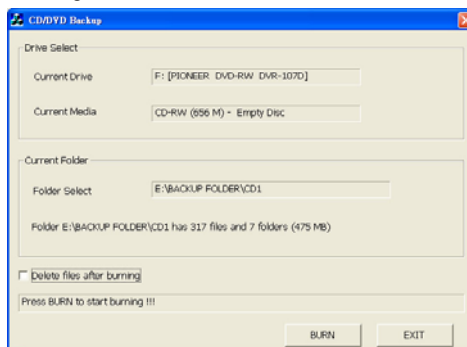

4.6.2 Setup Quick Backup

Set a quick backup rule for user when user presses to execute backup instantly.

1. Click **Quick Backup**
2. In Quick Backup Setting, mark **Enable**
3. And then, select the channels that want to backup

4. **Backup Last:** Set the time before minutes to backup. For example: time before 60 minutes means backup the recorded file from now backward 60 minutes. Present time is 13:00, the system will backup start from 12:00 when press quick backup button

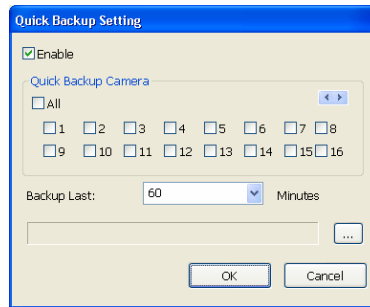

4.7 Sensor Setting

The I/O device must be installed to use this function.

1. Click the drop-down list and select the sensor ID number.
2. Enter sensor name.
3. Click **External IO** to configure external I/O device if it is available(see also [4.7.1](#))
4. The system automatically detects the sensor and input relates information. In the Content section, enter sensor description.
5. In the test section, click **Test** to check the sensor status. Red is high and Green is low.
1. Click **OK** to exit and accept the setting and **Cancel** to exit without saving the setting.

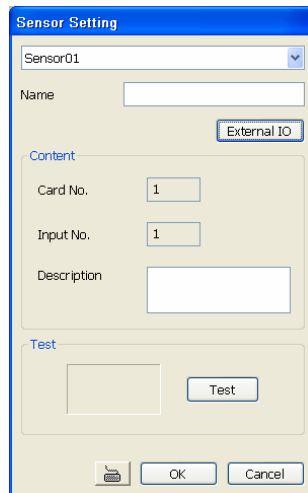

4.7.1 To Setup External I/O Box

The DVR system can connect the external I/O box for more installed of I/O devices.

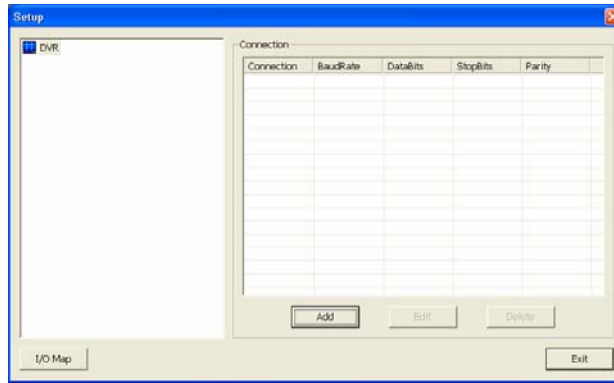

1. Click **Add**.
2. Mark **Enable** box to enable this external I/O box.
3. Select the Brand of external I/O box from drag down list.
4. In **Port Setting**, different brand of external I/O box may have different port parameters. Please refer to the external I/O box's user manual for port setting information. Using the default value if user uses External I/O box.
5. Click **OK** to save the setting.
6. To add more than one external I/O box, click **Add** and follow the above step 2~4.

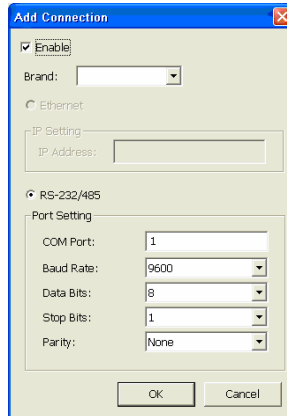

7. In External I/O box setup dialog, user will see all added External I/O. Click added External I/O box and click **Add** to scan the connected relays and sensors.
8. In **Add Module** windows, click **Scan** to scan the connected relays and sensors on the External I/O box.

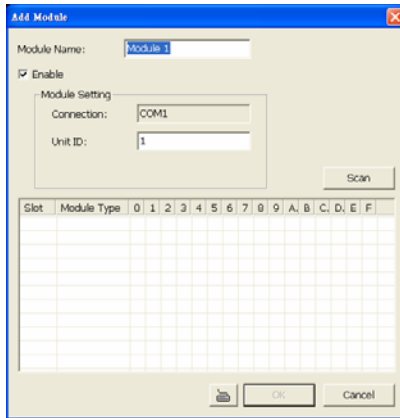

9. All connected relays and sensors will be listed. User can click radio button to control relays' status. And then, click **OK** to save the setting and click **Cancel** to exit and without saving.

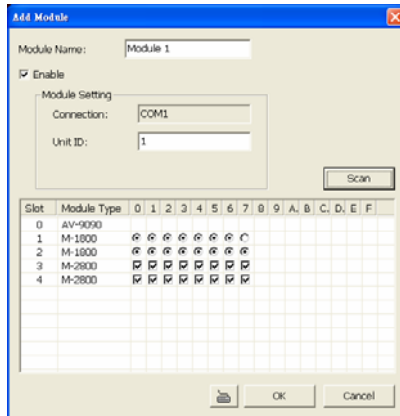

10. All connected External I/O box and their modules will be listed as tree topology in External I/O Setup windows.



- To view the all I/O devices information, click **I/O Map**.

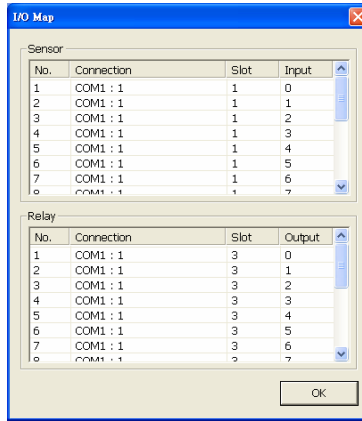

4.8 Relay Setting

The I/O device must be installed to use this function.

- Click the drop-down list and select the relay ID number.
- Mark **Enable** to enable the selected relay.
- Click **External IO** to configure external I/O device if it is available (see also 4.7.1). When external I/O is set and it will be available in drag down list for selecting.
- The system automatically detects the card and input number. In the Content section, enter relay description.
- In the test section, click **Test** to trigger relay. Red is high and Green is low.
- Click **OK** to exit and accept the setting and **Cancel** to exit without saving the setting.

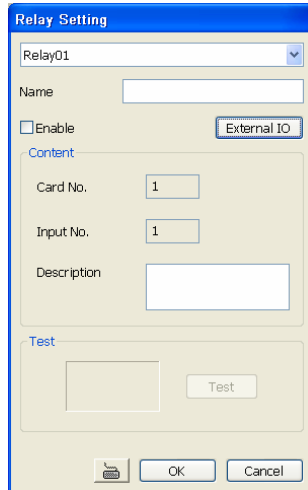

4.9 Alarm Setting

In the Alarm Setting dialog box, click **Add** to insert and set new alarm setting, click **Delete** to remove the selected alarm setting, click **OK** to exit and save the setting, **Cancel** to exit without saving, and **Default** to revert back to original factory setting.

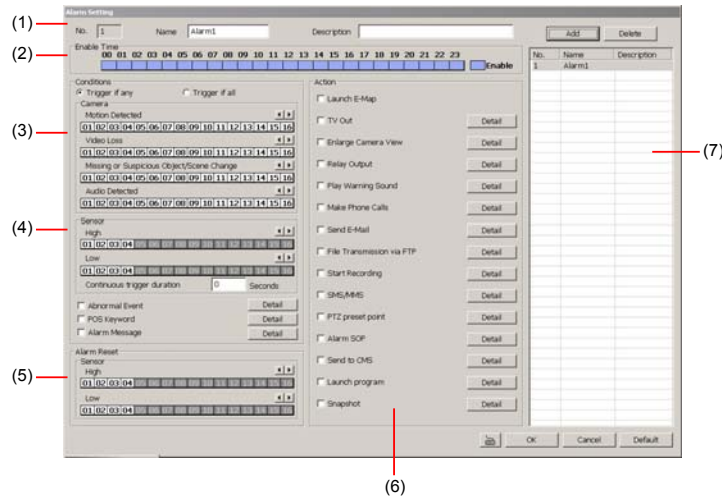

To set the Alarm Setting:

1. Click **Add** to insert and set a new alarm setting. Click the items in the **(7) Alarm Setting List**, if you want to modify the alarm setting.
2. In **(1) Alarm Setting number/Name/Description**, display the selected alarm setting number in the list below. Enter alarm name and description.
3. In **(2) Enable Time**, the number from 00 to 23 represent the time in 24-hour clock. Select the time and click the block you want to activate or deactivate the alarm function. When it is deactivated the color of the block turns white.
4. In **(3) Conditions**, you can set "**Trigger if any**" to activate if it falls to one of the conditions or "**Trigger if all**" to activate if it falls to all conditions.
 - In **Camera** section, select and click on the camera number (01 to 16) in **Motion Detected** and **Video Loss** to set the condition for the system to alarm.
 - In **Missing and Suspicious Object Detected**, click the camera number (01 to 16) and select the certain object on the screen (right click on camera number for detailed setting)), and when the certain object is missing or doubtful, the system will alarm.(see also [Chapter 4.9.12](#))
 - In **Scene Change**, click the camera number (01 to 16) and when the camera has been moved, the system will alarm.
5. In **(4) Sensor**, select and click on the sensor number (01 to 16) to set the condition for the system to alarm. If the sensor normal status is high, set the sensor condition to low (see [Chapter 4.7 step #4](#)).
 - Enable/disable the **Abnormal Event** check box, to set the condition of the event for system to alarm.

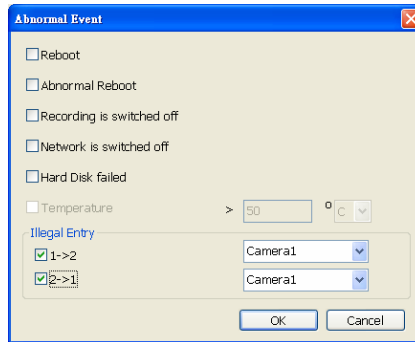

- **Normal Reboot:** when the DVR system reboot without abnormal condition, the system will send out the alarm message.
- **Abnormal Reboot:** when the DVR system reboot in irregular condition, the system will send out the alarm message.
- **Recording is switched off:** when the recording has been stopped, the system will send out the alarm message.
- **Network is switched off:** when the network connection of DVR system is lost, the system will send out the alarm message.
- **Hard Disk failed:** when the hard disk can't work normally, the system will send out the alarm message.
- **Temperature:** set a temperature limited of system for system to alarm. When DVR system temperature is over the temperature limited, the system will send out the alarm.
- **Illegal Entry:** any objects move between selected regions which user has set up in **Object Counting** section (see [Chapter 4.2.1](#)), the system will send out the alarm. Select the entry (object moves from region 1 to 2 or from region 2 to 1) and camera for system alarm detection.



Only if camera has been setup in **Object Counting** will be available for selecting in **Illegal Entry**.

- Enable/disable the **POS Keyword** check box, to scan the data from the POS if it matches the keyword (see also [Chapter 4.9.11](#)).
 - Enable/disable the **Alarm Message** check box, to active with external alarm message by your own program. For the detail configuration, please contact the local reseller.
6. In **(5) Alarm Reset**, click the camera number (01 to 16) to set the reset condition of alarm. Once alarm is reset, all alarm action will stop at the moment. If the sensor normal status is high, set the sensor condition to low.
7. In **(6) Action**, you may now set the alarm action for the system to perform when the alarm condition is activated.
- **Launch EMAP**
Display mini EMAP screen.
 - **Call Monitor Out**
Switch to only display the video on Call Monitor from where the alarm is activated.
 - a. Select the camera from drop down list to specify which camera video to be

displayed on TV when the alarm is triggered.

- ⊙ **Alarm Camera:** the channel video that has an alarm occurred will be displayed on TV.
 - ⊙ **Camera #(1~32):** select the camera channel video that you want to be displayed on when an alarm is activated.
- b. **Retrieve time:** set the waiting duration before system switching back to original display mode on automatically. If the retrieve time is un-mark, the alarm video will keep displaying until user switches back to normal display mode manually. The retrieve time range is 3~ 600 seconds.

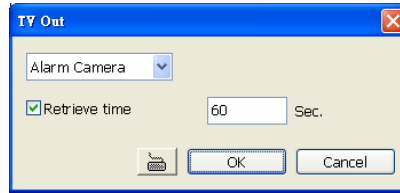

- **Enlarge Camera View**

Switch to only display video in Preview/Advanced mode from where the alarm is activated.

- a. Select the camera from drop down list to specify which camera video to be enlarged on screen when the alarm is triggered.
- ⊙ **Alarm Camera:** the channel video that has an alarm occurred will be enlarged on screen.
 - ⊙ **Camera # (1~32):** the selected channel video that will be enlarged on screen when an alarm is activated.
- b. **Retrieve time:** set the waiting duration before system switching back to original Preview mode. If the retrieve time is un-mark, the alarm video will keep enlarging until user switch back to Preview mode manually. The retrieve time range is 3~ 600 seconds.

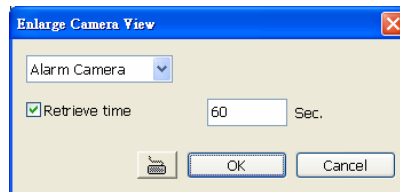

- **Relay Output**

Set to enable/disable the relay operation when the alarm is activated and to extend additional time in second before it stops the relay operation (see also [Chapter 4.9.1](#)).

- **Play Warning Sound**

Play alarm sound. To setup click **Detail** (see also [Chapter 4.9.2](#)).

- **Make Phone Calls**

Dial and contact the number in the list. To setup click **Detail** (see also [Chapter 4.9.3](#)). To use this feature, the PC must have a voice modem connected to it. The supported audio system is only 8KHz and 16Bit mono.

- **Send E-mail**

Send an electronic text message. To setup click **Detail** (see also [Chapter 4.9.4](#)).

- **File Transmission via FTP**

Upload file to remote computer thru FTP (File Transfer Protocol). To setup click **Detail** (see also [Chapter 4.9.5](#)).

- **Start Recording**

Record the video from the selected camera. To setup click **Detail** (see also [Chapter 4.9.6](#)).

- **SMS (Short Message Service)/MMS (Multimedia Messaging System)**

SMS transmits only text messages to mobile phone. MMS transmits text messages and images over wireless networks using the wireless application protocol (WAP). Make sure your mobile phone support this feature and your PC is connected to GSM/GPRS modem. To setup click **Detail** (see also [Chapter 4.9.7](#)).

- **PTZ preset point**

Position the PTZ camera based on the preset point setting. To setup click **Detail** (see also [Chapter 4.9.8](#)).

- **Alarm SOP (Standard Operation Procedure)**

List the instructions to inform the person of what to do when the alarm is activated. To setup click **Detail** (see also [Chapter 4.9.9](#)).

- **Send to CMS (Central Management System)**

Enable/disable the selected camera to send video to CMS when the alarm is activated (see also [Chapter 4.9.10](#))

- **Launch Program**

To call up the external program that is provided by 3rd party. Click **Detail** and click  to locate the program path. Enable **Multiple instance** check box to allow the program can be executed many times at the same time.

- **Snapshot**

Take a snapshot when the alarm is activated.

a. **Select Camera:** specify which channel video to be snapshot when the alarm is occurred.

⊙ **Alarm Camera:** when a channel has an alarm occurred, and then, the DVR system will snapshot the channel video.

⊙ **Camera # (1-32):** the selected channel would be snapshot when an alarm is occurred.

b. **Video Size:** select the size of snapshot picture.

c. **Number of picture:** the number of picture that is going to be taken.

d. **Snapshot Interval:** a time gap for next snapshot

e. **Save Path:** a storage path for saving snapshot pictures.

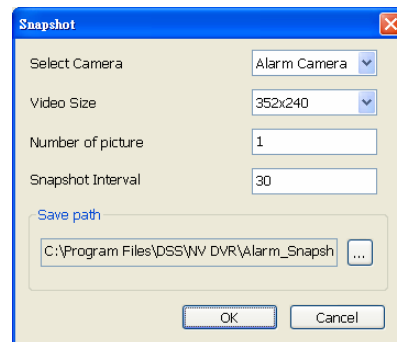

4.9.1 To Setup Alarm Relay:

1. Beside the Relay Output check box, click **Detail**.
2. In the Alarm Relay dialog box, select from the available relay list and in the ON column, set to enable/disable the relay operation when the alarm is activated.
3. In the Retrieve time check box, you may enable/disable to extend the relay operation time and set the duration in second.
4. Click **OK** to exit and accept the setting and **Cancel** to exit without saving the setting.

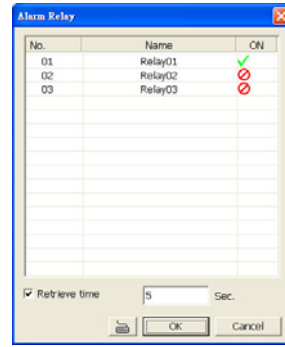

4.9.2 To Setup the Alarm Sound Setting:

1. Beside the Play Warning Sound check box, click **Detail**.
2. In the Alarm Sound Setting dialog box, click **...** to select other wav file from other source or folder, **Play** to listen, **Record** to make a new copy of a sound.
3. If you click **Record**, you will be prompted if you want to replace the file. Click **OK** to continue and **Cancel** to discontinue.
4. When the Sound Recorder appears, use the record control panel to record, stop, play, rewind and forward. If you want to keep the existing file, click **File > Save As...**, enter filename and click **Save**. Make sure you have microphone connected to your PC.
5. Click **OK** to exit and accept the setting and **Cancel** to exit without saving the setting.

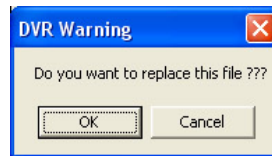
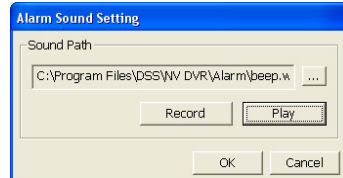

4.9.3 To Setup Call Out List:

1. Beside the Make Phone Calls check box, click **Detail**.
2. In the Call Out List, click **Add** to insert a new contact number, **Modify** to edit the selected item, **Remove** to delete the selected item, **Test** to check if it is working.

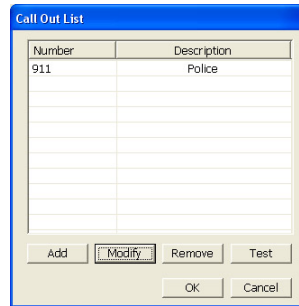

3. In the Call Out Setting, enter the phone number and description. Click **...** to select existing sound recorded massager and **Record** to make a new voice message.
4. When the Sound Recorder appears, use the record control panel to record, stop, play, rewind and forward. If you want to save the file, click **File > Save As...**, enter filename and click **Save**. Make sure you have microphone connected to your PC.

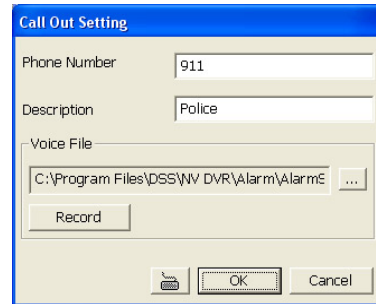

The supported audio system is only 8KHz and 16Bit mono.

5. Click **OK** to exit and accept the setting and **Cancel** to exit without saving the setting.

4.9.4 To Setup Send E-mail Setting:

Beside the Send Email check box, click **Detail**. In the E-mail Setting dialog box, click **OK** to exit and save the setting and **Cancel** to exit without saving the setting.

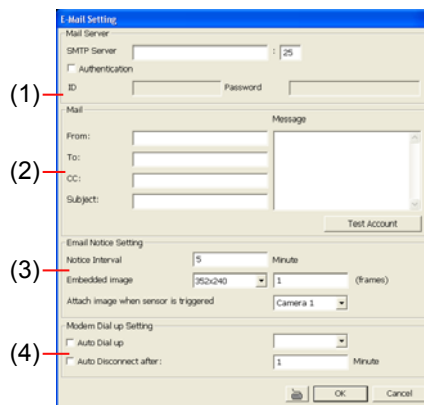

(1) Mail Server

Enter the SMTP Server and port. If your e-mail system requires user identification, enable **Authentication** check box and enter User ID and Password.

(2) Mail

To check if it is working, click **Test Account** button.

From : Enter the sender e-mail address.

To and CC : Enter the recipient email address and separate it with comma or a semicolon (;).

Subject : Enter the message title.

Message :Type the message.

(3) Email Notice Setting

Notice Interval Set the period of time before it sends another e-mail notice.

Embedded image Select the image size and set the number of frames.

Attach image when sensor is triggered When the sensor is triggered, the system will capture the image and send the image to the certain e-mail address with the alarm message.

(4) Modem Dial up Setting

If you are using dial up modem, enable **Auto Dial up** check box and select the modem name. You may also set the time to disconnect automatically, just enable the **Auto Disconnect after** check box and set time.

4.9.5 To Setup FTP Setting:

1. Beside the File Transmission via FTP check box, click **Detail**.
2. In the FTP Setting dialog box, enter the FTP IP, port, user ID and password.
3. In **Number of Pic** text box, enter the number of sequence images that want to send when file is transmitting.
4. In **Upload image when sensor is triggered**, select the camera that the images will be capture and send when the sensor is triggered.
5. Click **OK** to exit and save the setting and **Cancel** to exit without saving the setting.

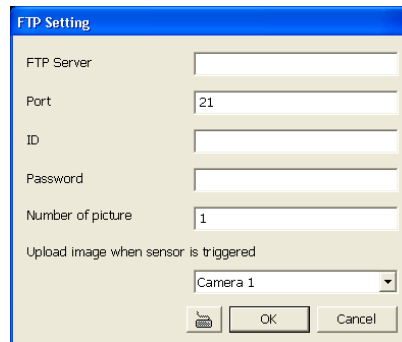

4.9.6 To Setup Alarm Recording Setting:

1. Beside the Start Recording check box, click **Detail**.
2. In the Alarm Recording Setting dialog box, select the camera to enable/disable video recording. Enable **All** to select all cameras.
3. In the Frame Rate selection, select **As Setting** to record the number of frames based on the Recording Setting or **Max** to record the maximum of frames based on the available speed.
4. In the Stop Recording after text box, set the number in second for the program to continue recording after the alarm has ended.
5. Click **OK** to accept the new settings and **Cancel** to exit without saving.



4.9.7 To Setup SMS/MMS Setting:

To use this feature, GSM/GPRS modem is required. Connect the GSM/GPRS modem to the serial COMM port of PC. Beside the SMS/MMS check box, click **Detail**.

Select the port number in Com Port drop down list from where the GSM/GPRS modem is connected.



1. Click **Modem Setup** button to automatically detect the Modem Baud Rate.
2. In **Local Phone Number** text box, enter the GSM SIM card phone number.
3. In **Phone Num** text box, enter the contact number.
4. You may now set to send thru SMS &/or MMS. If you enable SMS setting, just enter the message in the text box. If you enable MMS, enter the APN name, WAP IP, MMS address and the message. If you are not sure, please contact your mobile service provider.
5. **Attach image when sensor is triggered** select the camera that the images will be capture and send when the sensor is triggered.
6. Click **OK** to accept the new settings and **Cancel** to exit without saving.



Make sure your ISP provider and cell phone provider both support JPG file format transmitting.

4.9.8 To Setup PTZ Preset Point:

Beside the PTZ preset point check box, click **Detail**. In the Trigger PTZ Preset Setting dialog box, select the PTZ camera number then select the Enable check box. Select the position of the PTZ camera when the alarm is activated and ended. For the PTZ camera ended point, user also can select one preset position or **Auto Pan** between preset position groups.

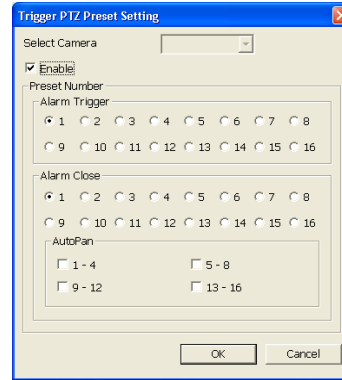

4.9.9 To Setup Alarm SOP:

Beside the Alarm SOP check box, click **Detail**. In the step text boxes, type the standard protocol when the alarm is activated. When the alarm is activated the Standard Operation Procedure dialog box will appear. Just click **Next** to see the next instruction, **Back** to see the previous instruction, **Finish** to end and **Abort** to terminate.

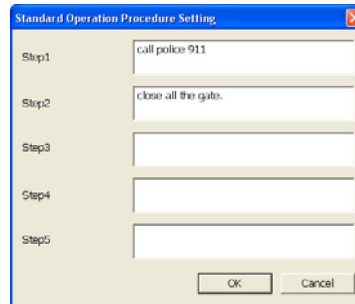

4.9.10 To Setup CMS Setting

Beside the Send to CMS check box, click **Detail**. In the CMS Setting, select the camera to enable/disable sending the video to CMS. Enable **All** to select all cameras. Then, click **OK** to accept the new settings and **Cancel** to exit without saving.

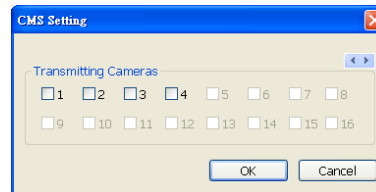

4.9.11 To Setup POS Keyword Setting

1. Beside the Send to POS Keyword check box, click **Detail**.
2. In the POS Keyword Setting, select the camera to enable/disable scanning the keyword. Enable **All** to select all cameras.
3. Enter the text below keyword text box. Click **Add** to include the keyword in the list. To remove, select the word in the list and click **Delete**. You may only add 8 keywords. User can define the color for each keyword. To set the color, click the color panel after next to POS keyword column and a color selection window will pop up. Select the color that user wants and click **OK**.
4. Click **OK** to accept the new settings and Cancel to exit without saving.

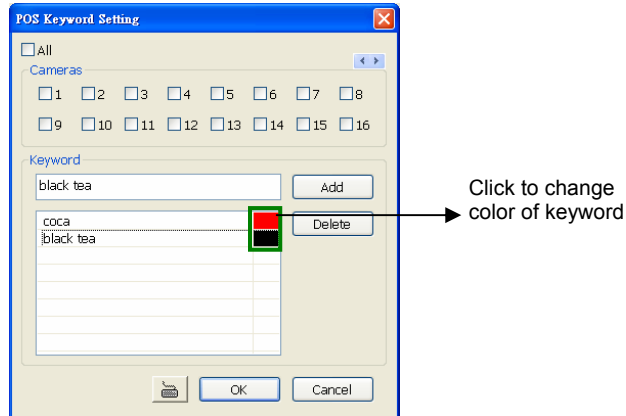

4.9.12 Missing, Suspicious Object, and Scene Change Detected

- Missing Object

Select the certain object on the screen for the system to detect; when the object is disappear or move and the system will alarm. Click **OK** to exit and save the configuration. To exam the setup condition, click **Start Test**.

1. Select the camera number (0-16) and press RIGHT button on the mouse to call up the setup windows.
2. Click **Save** to capture the image for comparing reference first. To view the captured image, enable the **Show Reference Image** check box. The captured image will display on screen. The reference image is sharing with the Suspicious Object and Scene Change function.
3. Mark the **Enable** check box to setup the condition.
4. Use the mouse to click and drag the frame on the screen. User can drag more than one frame.
5. **Sensitivity**: Set the system detects sensitivity.
6. **Delay Time**: Set the lasting time for system to detect the object.
7. To reset all object frames, click **Clean**. To clean an object frame, click right button of mouse and drag the object frame that user want to clean.

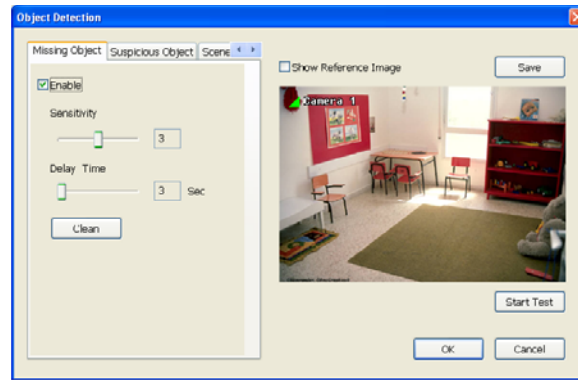

- **Suspicious Object**

Suspicious Object is including the object missing or the doubtful object appears on the screen. Click **OK** to save and exit the setup windows. To exam the setup condition, click **Start Test**.

1. Select the camera number (0-16) and press right button on the mouse to call up the setup windows. And then, click the **Suspicious Object** Tab.
2. Click **Save** to capture the image for comparing reference. To view the captured image, enable the **Show Reference Image** check box. The captured image will display on screen. The reference image is sharing with the Missing Object and Scene Change function.
3. Mark the **Enable** check box to setup the condition.
4. **Sensitive:** Set the system detects sensitivity.
5. **Delay Time:** Set the lasting time for system to detect the object.
6. Use the mouse to click and drag the frame on the screen.
 - **Maximum_Object:** the maximum detect size. The objects are out of the maximum detect area will be disregard. Use mouse to click and drag the frame on the screen.
 - **Minimum_Object:** the minimum detect area. When the objects are smaller than the minimum detect area, the system will disregard. Use mouse to click and drag the frame on the screen.
7. **Enable Mask**
Mark an area on the screen to disregards the motion in the marked area and to only monitor outside the marked area. Mark the **Enable Mask** check box, click and drag the mask frame on the screen.
8. To reset all object frames, click **Clean**. To clean an object frame, click right button of mouse and drag the object frame that user want to clean

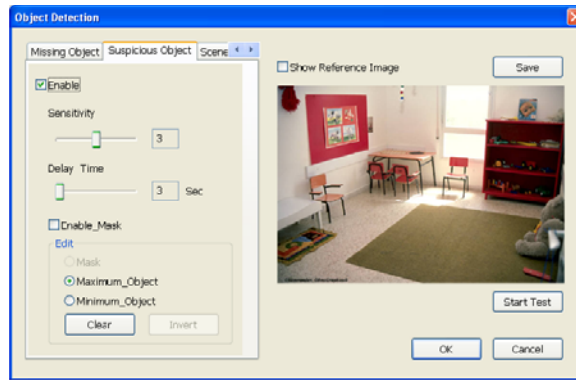

Scene Change

When the camera has been moved, the system will alarm.

1. Select the camera number (0-16) and press right button on the mouse to call up the setup windows. And then, click the **Scene Change** Tab.
2. Click **Save** to capture the image for comparing reference. To view the captured image, enable the **Show Reference Image** check box. The captured image will display on screen. The reference image is sharing with the Missing Object and Suspicious Object function.
3. Mark the **Enable** check box to setup the condition.
4. **Sensitive**: Set the system detects sensitivity.
5. **Delay Time**: Set the lasting time for system to detect the movement.
6. **Change Rate**: Set the camera movement range which compare with the original position.
7. **Enable Mask**
Mark an area on the screen to disregards the motion in the marked area and to only monitor outside the marked area. Mark the **Enable Mask** check box, click and drag the mask frame on the screen.
8. To reset all object frames, click **Clean**. To clean an object frame, click right button of mouse and drag the object frame that user want to clean.

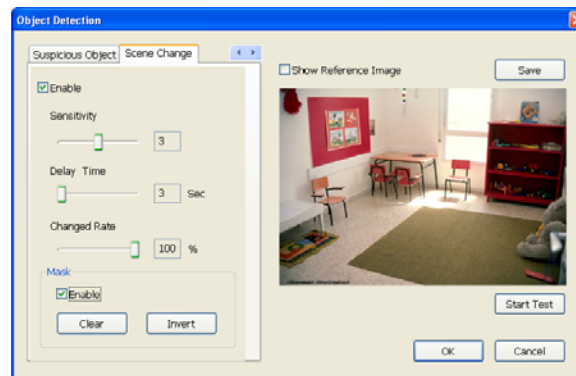

4.10 User Setting

Only administrator can access User Setting. In the User Setting dialog box, click **Add** to insert a new user, **Delete** to remove the selected user, **Edit** to modify the user control right, **OK** to exit and accept the setting, and **Cancel** to exit without saving the setting.



After clicking **Add** or **Edit**, you may customize the user control setting. **OK** to exit and accept the setting, and **Cancel** to exit without saving the setting

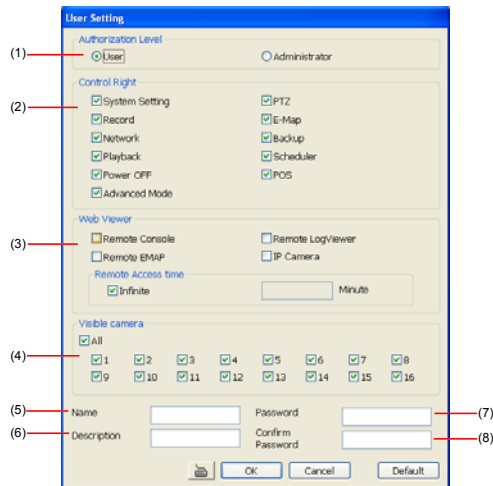

(1) Authorization level

Select the status of the user. Only Administrator-level can access User Setting, and reset the Alarm status when using the Remote Console.

(2) Control Right

Enable the items that would allow the user to access.

(3) Web Viewer

Enable/disable Web Viewer control right that allow the user to operate from a remote location using internet explorer.

- **Remote Console**
Allow the user to remote modify DVR system setting.
- **Remote LogViewer**
Allow the user to view the event log from remote site.
- **Remote EMAP**
Allow the user to view the E-map of DVR from remote site.
- **IP Camera**
Enable/disable user to add new IP camera when using the Web Viewer.

- **Remote Access Time**

Enable **Infinite** check box to access DVR without time limit. If you want to set time limit, enter the number of minutes in **Minute** text box.

(4) Visible Camera

Select the camera number that would allow the user to access or view. To select all the cameras, enable the **ALL** check box.

(5) Name

Enter the user name.

(6) Description

Enter the user description.

(7) Password

Enter the user password.

(8) Confirm Password

Enter the same user password for confirmation.

Chapter 5 Backup Video Players

You can playback the backup files using QLogViewer and Player applications. When you back up the recorded file, QLogViewer and Player applications are automatically included in the backup folder.

QLogViewer can only playback one video at a time. It only comes with video segmentation, output segmentation, capture screen shot, and print the screen. With Player, it is the same as in Playback mode and supports six (6) different split screen types to view all the video at the same time. The only difference is that there are no Preview and Playback buttons.

To run the application, go to backup folder and double-click QLogViewer or Player icon.

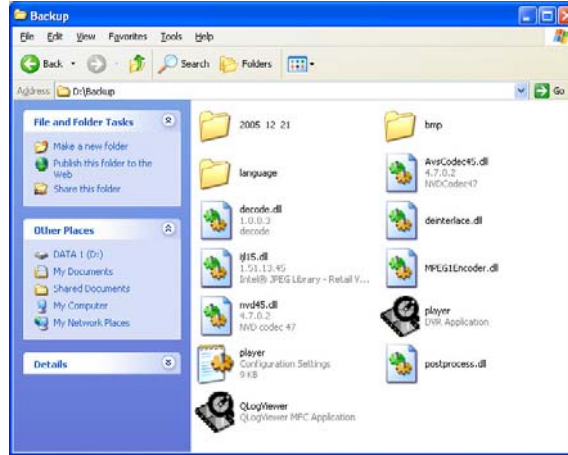

5.1 Familiarizing QLogViewer Buttons

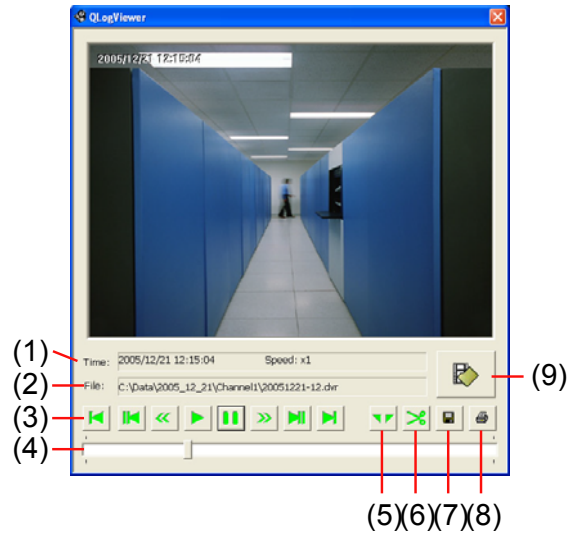

Name	Function
(1) Time	Display the file date, time and play speed.
(2) File	Display the path where the file is located.
(3) Playback Control Buttons	<p>Begin: Move at the beginning of the recorded video file.</p> <p>Previous: Go back to the previous frame.</p> <p>Slower: Play the recorded video file at the speed of ½x, ¼x, or ⅓x.</p> <p>Rewind: Wind back the recorded video file.</p> <p>Pause: Briefly stop playing the recorded video file.</p> <p>Play: Play the recorded video file.</p> <p>Faster: Play the recorded video file at the speed of 2x, 4x, or 8x.</p> <p>Next: Go to the next frame.</p> <p>End: Go to the end of the recorded video file.</p>
(4) Progress bar	Show the progress of the file being played. You may move the bar to seek at any location of the track.
(5) Segmentation	Keep a portion of the recorded video you want. For operational procedure, please refer to Chapter 4.8.
(6) Output	Save the segmented file in *.mpg, *.avi, or *.dvr format.
(7) Save	Capture and save the screen shot either in *.jpg or *.bmp format.
(8) Print	Print the screen shot.
(9) Open	Access the backup video file.

5.2 Familiarizing the Player Buttons



Name	Function
(1) Split Screen Mode	Select from six (6) different split screen type to playback the recorded video file of all the camera, or one camera over the other or alongside on a single screen.
i	<ul style="list-style-type: none"> - If there are only 4 cameras, you won't be able to switch to 9, 16, and 13 split screen mode. - To zoom in an area on the screen, Right click and Drag a square on the area you want to enlarge.
(2) Exit	Close the Player.
(3) Progress bar	Show the progress of the file being played. You may move the bar to seek at any location of the track.
(4) Hour Buttons	Select and click to playback the recorded video file on the specific time frame.
(5) Playback Control Buttons	<p>Begin: Move at the beginning of the recorded video file.</p> <p>Previous: Go back to the previous frame.</p> <p>Slower: Play the recorded video file at the speed of 1/2x, 1/4x, or 1/8x.</p> <p>Rewind: Wind back the recorded video file.</p> <p>Pause: Briefly stop playing the recorded video file.</p> <p>Play: Play the recorded video file.</p> <p>Faster: Play the recorded video file at the speed of 2x, 4x, or 8x.</p> <p>Next: Go to the next frame.</p> <p>End: Go to the end of the recorded video file.</p>

Name	Function
(6) Date	Select the date on the calendar and the time from 00 to 23 to where to start playing the recorded video file.
	<p>The numbers from 00 to 23 represent the time in 24-hour clock. The numbers from 01 to 16 represent the camera ID. The blue colored column indicates that there is a recorded video file on that period of time. While the red colored column indicates on where to start playing the recorded video file.</p>
(7) Status bar	Display the recorded date, time and play speed.
(8) Camera ID	Show the number of cameras that are being viewed. When you are in single screen mode, click the camera ID number to switch and view other camera.
(9) Output	Save the segmented file in *.mpg, *.avi, or *.dvr format (see also Chapter 3.7).
(10) Segment	Keep a portion of the recorded video you want (see also Chapter 3.7).
(11) Print	Print the screen shot.
(12) Snapshot	Capture and save the screen shot either in *.jpg or *.bmp format.
(13) Full screen	<p>View in Playback-compact mode. To return, Right click the mouse or press ESC on the keyboard.</p> <p>When you switch to full screen in multiple-screen mode, Left click to toggle to only display one of the video in the multiple-screen mode or all.</p>
(14) Visual Search	Search from a specific camera by Date, Hour, Minute, 10 Seconds and Second. (See also Chapter 3.9)
(15) Find Next	Search for the next event or changes in the motion detector frame. You can use this when you are using Intelligent Search or Event Search only.
(16) Event Search	Search from the recorded activities that take place in the system (i.e., Sensor, Motion, Video Loss, POS). (See also Chapter 3.10)
(17) Intelligent Search	Search the changes in the motion detector frame (See also Chapter 3.11).

Chapter 6 Using Functional Keys

The DVR system provides shortcut keys. The table shows the function keys and descriptions.

Function Keys	Description
F1	Display system information
F2	Start recording
F3	Enable network function
F4	Access system settings
F5	Switch to playback mode
F6	Access EMAP setting
F7	Access PTZ camera control panel
F8	Snapshot
F9	Switch to Full Screen
F11	Switch to AutoScan
Ctrl + A	Turn on/off hardware AGC (Auto Gain Control)

Chapter 7 Using the Remote Programs

You can use Microsoft Internet Explorer to access DVR server by entering the IP address or domain name. To use this feature, make sure that you are connected to the internet and the Network feature is enabled.

Accessing this feature for the first time you will be prompted by your browser to install WebCamX.cab, allow the installation and you should be able to connect and login afterwards.

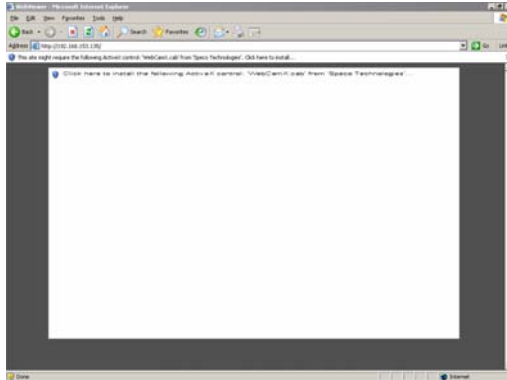

For Windows XP, click **Install** when the Internet Explorer - Security Warning dialog box appears.

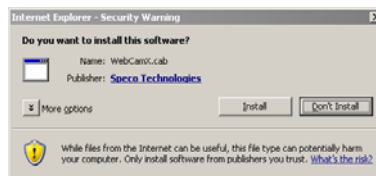

After installing the WebCamX.cab and when connecting to the DVR server, you are required to enter User ID, password and select the network type.

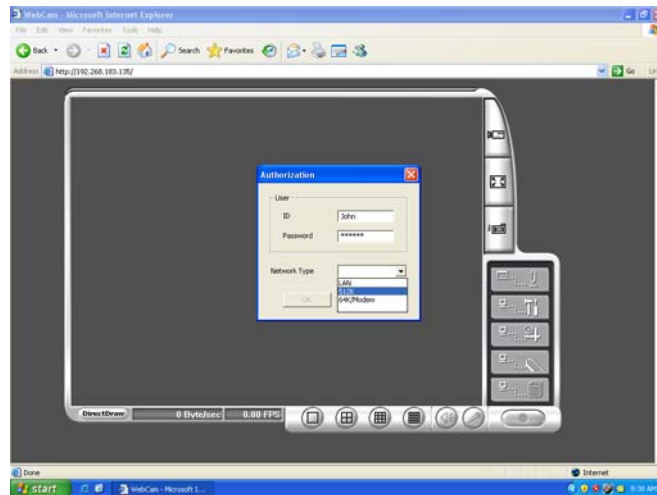

7.1 Familiarizing the WebViewer Buttons

Right-clicking on the webviewer video screen, enables you to start video recording, change video quality, switch camera and enable/disable DirectDraw.



Name	Function
(1) DirectDraw	Enhance the video quality.
<p>i Not all graphic cards can support this function.</p>	
(2) Received file size	Indicate the size of the data being sent per second.
(3) Camera frames	Indicate the number of frames per second.
(4) Split display mode	Select from six (4) different split screen types to view all the cameras. It also allows you to switch and view different camera number.
(5) Audio	Enable/disable remote sound.
(6) 2-Way Talk	Enable/disable 2-way audio function. This function allows the client and server to talk via internet using MIC. Make sure your microphone and speakers work before using this function. If the DVR server Talk to web-client setting is disabled, you won't be able to hear from the other side.
(7) Record	Save the video of the selected camera in AVI format.
(8) Event Log Viewer	Display the Event logs, Operation logs, POS logs, System logs, and Network logs.
(9) Remote Console	Initiate Remote Console. The interface is the same as DVR application and allows you to control DVR server (see also Chapter 7.2).
(10) Remote EMAP	Display the DVR server EMAP screen (see also Chapter3.6).

Name	Function
(11) Remote setup	Change the DVR server settings (see also Chapter 7.1.1).
(12) Select a PTZ Camera	Initiate PTZ camera controller (see also Chapter 7.2)
(13) Snapshot	Capture and save the screen shot in *.bmp format.
(14) Full screen	Use the entire area of the screen to only display the video. To return, Right click the mouse or press ESC on the keyboard.
(15) Select cameras to view	<p>Select to the view camera from different server. In Select Camera dialog box, Display column, click to enable/disable viewing the camera. In Video Quality column, click to select between High, Normal or Low.</p> <ul style="list-style-type: none"> - Click Add Server and select the server type between DVR and IP Cam to add. - Click Delete Server to delete the selected item. - Click Import to replace it with the previous saved list. - Click Export to save the list. - Click Apply All to change all the camera video quality based on the selected setting. - Click OK to exit.

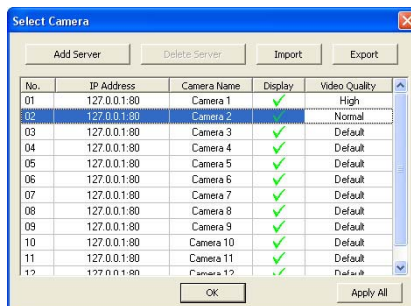

To add IP Cam, user need to enable IP Camera control right at the **User setting** of DVR system.(see [Chapter 4.10](#))

7.1.1 To Setup Remote System Setting

Click **OK** to exit and save the setting and **Cancel** to exit without saving the setting. The setting here applies to Remote DVR only.

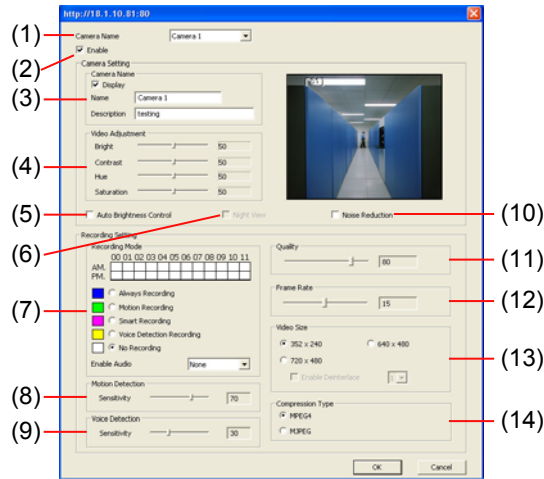

(1) Camera Name

Select the camera you want to adjust the settings.

(2) Enable

Set to enable/disable the selected camera. When there is no video source on the camera, we suggest disabling it so that the system won't detect it as video loss error.

(3) Camera Setting

- Display

Enable/disable to show the video. Even if the video of the selected camera is hidden you can still record the video and preview it in playback mode.

- Name

Change the camera name.

- Description

Add a short comment.

(4) Video Adjustment

Adjust the Brightness, Contrast, Hue and Saturation of the selected camera.

(5) Auto Brightness Control

Automatically adjust the brightness.

(6) Night View

Automatically adjust the exposure to make the image more visible especially when the site is dark. You can only use this function when the Auto Brightness Control is enabled.

(7) Recording Mode

The blocks from 00 to 11 (AM & PM) represent the time in 24-hour clock. To record in full 24 hours, select the recording mode and click the ☉ button. If you want to only record at a particular time, click the colored block beside the recording mode then click on the time blocks. When the system starts recording a red triangle mark would appear at the upper left corner of the screen. The recording modes are listed below:

- **Always Recording**
Record the video from the selected camera and save it to the designated storage path (see also [Chapter 4.1 #1](#)).
- **Motion Recording**
Start recording the video from the selected camera only when the system detects motion. Once a motion is detected, the system automatically saves the previous frames and stop based on the Start Record Prior and Stop Record After settings.
- **Smart Recording**
Automatically switch to recorded at the maximum frame rate setting once a motion is detected and if there is no motion, it records at the minimum frame rate setting Set the maximum and minimum frame rate setting in [\(7\) Frame Rate](#) section.
- **No Recording**
The system won't do any recording.

(8) Motion Detection

Adjust the sensitivity of the motion detector. The higher the value, the finer the sensitivity is detected. When it detects a motion, a green triangle mark would appear at the upper left corner of the screen.

(9) Voice Detection

Adjust the intensity of the audio detector. The system detects sound when it exceeds the intensity value.

(10) Noise Reduction

Reduce undesirable video signal and improve the quality of the video.



Noise Reduction uses lots of CPU resource. Please use this feature only if it is really necessary.

(11) Quality

Adjust the video quality. The higher the value, the lower the compression level and uses more hard disk space.

(12) Frame Rate

Set the number of images per second of the video to be recorded. The frame rate ranges from 1 to 30 for NTSC and 1 to 25 for PAL. The higher frame rate, it uses more hard disk space.

(13) Video Size

Select the size of the video and click the  button. The higher the size, the larger the file it create. You can also activate the **Enable Deinterlace** to enhance the video quality. Set the **Enable Deinterlace** mode to #1, if you are capturing motionless picture and #2, if it captures lots of movement.

(14) Compression Type

Select between the 2 compression types. MPEG4 uses higher compression rate and the file is smaller. While MJPEG uses lower compression rate and the file is bigger.

7.2 Familiarizing the WebViewer PTZ Buttons



Name	Function
(1) Direction buttons	Adjust and position the focal point of the PTZ camera. Click the center to pan automatically.
(2) Select PTZ	Choose to enable/disable the PTZ camera. In the Select PTZ dialog box, Select column, click to enable/disable viewing and controlling the PTZ camera. Click OK to exit and save the setting and Cancel to exit without saving the setting.
(3) AutoPan Groups	Operate the PTZ cameras automatically based on the selected camera group preset position number.
(4) Camera preset position number	Move the PTZ camera to the preset point.
(5) Zoom +/-	Zoom in and out the image.
(6) Focus +/-	Adjust the focus manually to produce clear image.

7.3 Familiarizing the Remote Console Buttons

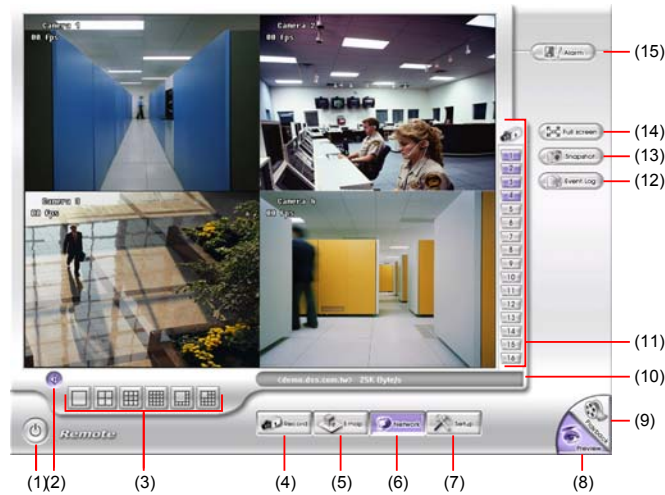

Name	Function
(1) Exit	Close the Remote Console.
(2) Volume	Enable/disable the sound.
(3) Split Screen Mode	Select from six (6) different split screen type to playback the recorded video file of all the camera, or one camera over the other or alongside on a single screen.
	- If there are only 4 cameras, you won't be able to switch to 9, 16, and 13 split screen mode.
	- To change the video quality, right-click on the screen and select between High, Normal or Low.
(4) Record	Start/stop video recording.
(5) EMAP	Display the map in each area, the camera/sensor/relay location and the warning event. (see also Chapter 3.6)
(6) Network	Enable/disable remote system access. This feature allows you to access DVR server from a remote location via internet connection.
(7) Setup	Configure the Remote Console setting. (see also Chapter 7.3.1)
(8) Preview	Switch to Preview/Advanced mode. This allows you to view live camera display.
(9) Playback	Switch to Playback mode. This allows you to view the recorded video file. (see Chapter 7.4)
(10) Status Bar	Display the current date, time and hard disk free space.

Name	Function
(11) Camera ID	Show the number of cameras that are being viewed. When you are in single screen mode, click the camera ID number to switch and view other camera.
(12) Event log	Show the record of activities that take place in the system. To filter the records, select and click the option button to only display Event, System, Operation, Network or POS.
(13) Snapshot	Capture and save the screen shot either in *.jpg or *.bmp format.
(14) Full screen	Use the entire area of the screen to only display the video. To return, Right click the mouse or press ESC on the keyboard.
(15) Alarm	Alert and display warning info. Only Administrator-level can reset and turn on, off and trigger the Sensor and Relay by right-clicking the item in the Sensor and Relay list.

7.3.1 To Setup Remote Console Setting

Click **OK** to exit and save the setting and **Cancel** to exit without saving the setting.

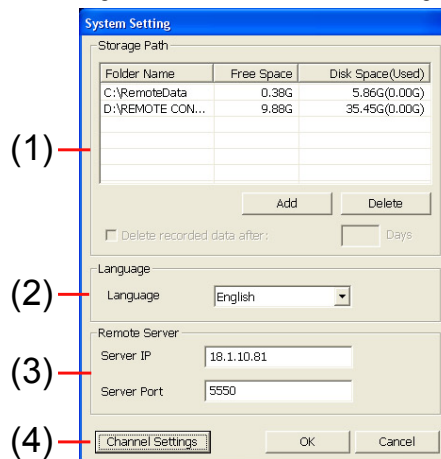

(1) Storage Path

Set the directory on where to save the data. When there is not enough free space to record one hour data, the system automatically replaces the oldest data. In case you have more than one storage path, the system automatically saves the data to the next storage path.

By default the data is stored in C:\RemoteData, to insert another storage path, click **Add**. To remove the selected path, click **Delete**.

If you want the system to automatically erase the data after a certain days, enable the **Delete recorded data after** check box and enter the numbers of days in **Days** text box.

(2) Language

Customize the system to display the tool tips and dialogs based on the selected language. By default the language is in English.

(3) Remote Server

Enter the DVR Server IP and Port number.

(4) Channel Settings

The numbers from 01 to 16 represent the camera ID. In Transmitting Channels section, enable the camera number to receive the camera signal from the server. In Visible Channels section, enable the camera number to view the camera signal on Remote Console screen. To select all the cameras, enable the **ALL** check box.

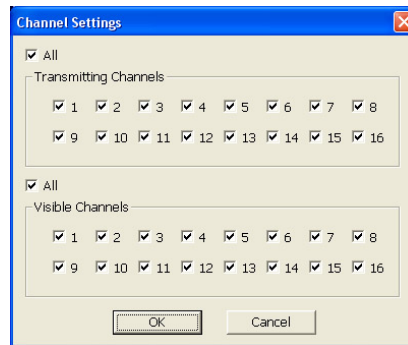

7.4 Using the Remote Playback

To use this feature, first you need to select the source of the file. In the Select Playback Mode dialog box, choose **Local Playback** to open the file that is recorded in the Remote Console, and **Remote Playback** to open the file that is recorded in the DVR server. When you choose Remote Playback, select **RealTime Playback** if your internet bandwidth is fast and big enough, otherwise choose **Download and Playback**.

Click **OK** to proceed and **Cancel** to void this operation.

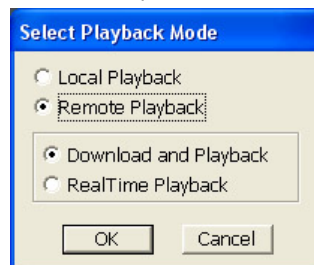

In the Video Playback Date/Time Selection, the number from 00 to 23 represent the time in 24-hour clock. The numbers from 01 to 16 represent the camera number.

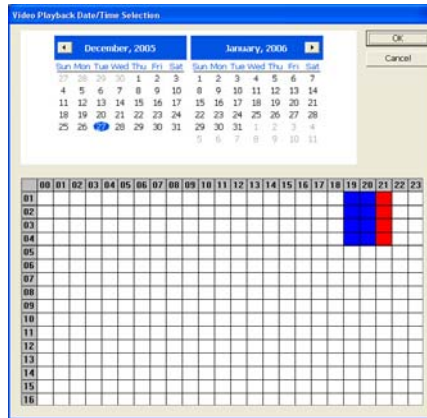

To Make a Selection:

1. Select the date in the calendar. Use ◀ and ▶ buttons to shift the calendar to the left or right.
2. In the table below, click on the blue block to select and open the recorded file. The blue block turns red when it is selected. The block that appears in white doesn't have data. You can only select one block when you choose Download and Playback.
3. Click **OK** to proceed and **Cancel** to void this operation.
4. If you select Download Playback and after making the selection, the system divides the selected hour into 16 video thumbnails. In the Time Selection screen, click on the video thumbnail you want to download and open (see also [Chapter 7.4.2](#)).

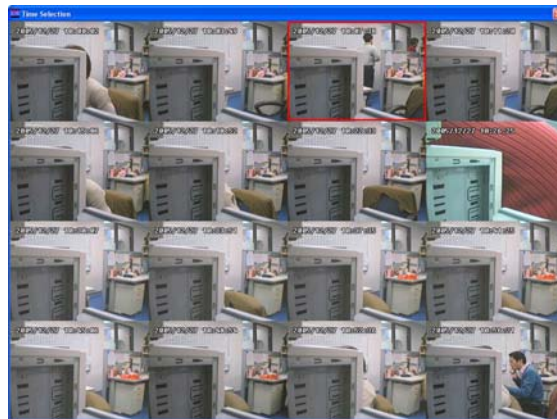

7.4.1 Familiarizing the Local Playback Buttons

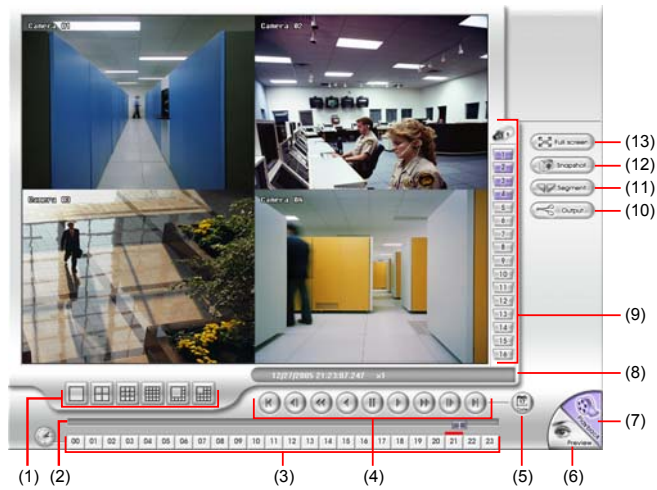

Name	Function
(1) Split Screen Mode	Select from six (6) different split screen type to playback the recorded video file of all the camera, or one camera over the other or alongside on a single screen.
<p>i - If there are only 4 cameras, you won't be able to switch to 9, 16, and 13 split screen mode.</p> <p>- To zoom in an area on the screen, Right click and Drag a square on the area you want to enlarge.</p>	
(2) Progress bar	Show the progress of the file being played. You may move the bar to seek at any location of the track.
(3) Hour Buttons	Select and click to playback the recorded video file on the specific time frame.
<p>i The Hour buttons represent the time in 24-hour clock. The blue bar on top of the hour button indicates that there is a recorded video file on that period of time. While the red bar indicates that you are currently viewing the recorded video file.</p>	
(4) Playback Control Buttons	<p>Begin: Move at the beginning of the recorded video file.</p> <p>Previous: Go back to the previous frame.</p> <p>Slower: Play the recorded video file at the speed of 1/2x, 1/4x, or 1/8x.</p> <p>Rewind: Wind back the recorded video file.</p> <p>Pause: Briefly stop playing the recorded video file.</p> <p>Play: Play the recorded video file.</p> <p>Faster: Play the recorded video file at the speed of 2x, 4x, 8x, 16x or 32x.</p> <p>Next: Go to the next frame.</p> <p>End: Go to the end of the recorded video file.</p>

Name	Function
(5) Date	Select the date on the calendar and the time from 00 to 23 to where to start playing the recorded video file.
	<p>The numbers from 00 to 23 represent the time in 24-hour clock. The numbers from 01 to 16 represent the camera ID. The blue colored column indicates that there is a recorded video file on that period of time. While the red colored column indicates on where to start playing the recorded video file.</p>
(6) Preview	Switch to Preview/Advanced mode.
(7) Playback	Switch to Playback mode. This allows you to view the recorded video file.
(8) Status bar	Display the recorded date, time and play speed.
(9) Camera ID	Show the number of cameras that are being viewed. When you are in single screen mode, click the camera ID number to switch and view other camera.
(10) Output	Save the segmented file in *.mpg, *.avi, or *.dvr format (see also Chapter 3.7).
(11) Segment	Keep a portion of the recorded video you want (see also Chapter 3.7).
(12) Snapshot	Capture and save the screen shot either in *.jpg or *.bmp format.
(13) Full screen	<p>View in Playback-compact mode. To return, press the right button of the mouse or ESC on the keyboard.</p> <p>When you switch to full screen in multiple-screen mode, Left click to toggle to only display one of the video in the multiple-screen mode or all.</p>

7.4.2 Familiarizing the RealTime Playback Buttons

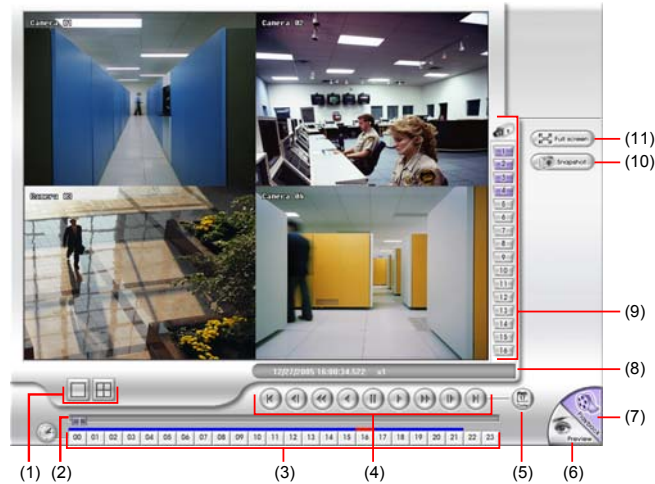

Name	Function
(1) Split Screen Mode	Select from two (2) different split screen type to playback the recorded video file of all the camera, or one camera.
i	<ul style="list-style-type: none"> - If there are only 4 cameras, you won't be able to switch to 9, 16, and 13 split screen mode. - To zoom in an area on the screen, Right click and Drag a square on the area you want to enlarge.
(2) Progress bar	Show the progress of the file being played. You may move the bar to seek at any location of the track.
(3) Hour Buttons	Select and click to playback the recorded video file on the specific time frame.
i	The Hour buttons represent the time in 24-hour clock. The blue bar on top of the hour button indicates that there is a recorded video file on that period of time. While the red bar indicates that you are currently viewing the recorded video file.
(4) Playback Control Buttons	<p>Begin: Move at the beginning of the recorded video file.</p> <p>Previous: Go back to the previous frame.</p> <p>Slower: Play the recorded video file at the speed of ½x, ¼x, or ⅓x.</p> <p>Rewind: Wind back the recorded video file.</p> <p>Pause: Briefly stop playing the recorded video file.</p> <p>Play: Play the recorded video file.</p> <p>Faster: Play the recorded video file at the speed of 2x, 4x, 8x, 16x or 32x..</p> <p>Next: Go to the next frame.</p> <p>End: Go to the end of the recorded video file.</p>

Name	Function
(5) Date	Select the date on the calendar and the time from 00 to 23 to where to start playing the recorded video file.
	<p>The numbers from 00 to 23 represent the time in 24-hour clock. The numbers from 01 to 16 represent the camera ID. The blue colored column indicates that there is a recorded video file on that period of time. While the red colored column indicates on where to start playing the recorded video file.</p>
(6) Preview	Switch to Preview/Advanced mode.
(7) Playback	Switch to Playback mode. This allows you to view the recorded video file.
(8) Status bar	Display the recorded date, time and play speed.
(9) Camera ID	Show the number of cameras that are being viewed. When you are in single screen mode, click the camera ID number to switch and view other camera.
(10) Snapshot	Capture and save the screen shot either in *.jpg or *.bmp format.
(11) Full screen	<p>View in Playback-compact mode. To return, press the right button of the mouse or ESC on the keyboard.</p> <p>When you switch to full screen in multiple-screen mode, Left click to toggle to only display one of the video in the multiple-screen mode or all.</p>

7.4.3 Familiarizing the Download and Playback Buttons

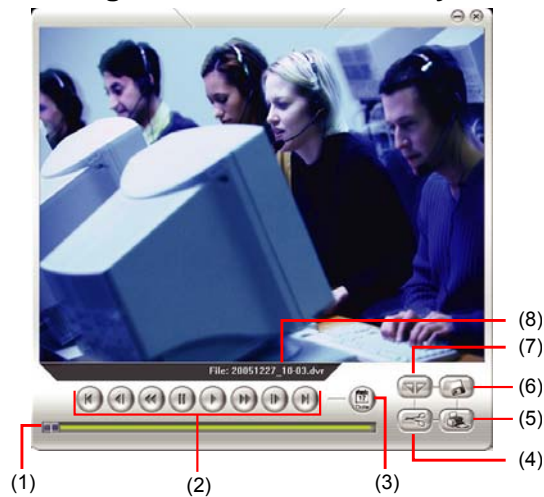

Name	Function
(1) Progress bar	Show the progress of the file being played. You may move the bar to seek at any location of the track.
(2) Playback Control Buttons	<p>Begin: Move at the beginning of the recorded video file.</p> <p>Previous: Go back to the previous frame.</p> <p>Slower: Play the recorded video file at the speed of ½x, ¼x, or ⅓x.</p> <p>Rewind: Wind back the recorded video file.</p> <p>Pause: Briefly stop playing the recorded video file.</p> <p>Play: Play the recorded video file.</p> <p>Faster: Play the recorded video file at the speed of 2x, 4x, or 8x.</p> <p>Next: Go to the next frame.</p> <p>End: Go to the end of the recorded video file.</p>
(3) Date	Open other file.
(4) Output	Save the segmented file in *.mpg, or *.avi, format.
(5) Print	Print the screen shot.
(6) Save	Save the screen shot either in *.jpg or *.bmp format and video in *.dvr format.
(7) Segment	Keep a portion of the recorded video you want. You may follow the instruction in Chapter 3.7 .

7.5 Using HandyViewer to Access DVR server

Users can use a mobile phone to access the DVR through Internet. Make sure your mobile phone support IE browser and is connected to the internet. To access the DVR server, open IE browser and enter `http://enter server IP or domain name here/mobile`. You can see the latest screen shot. Click << >> to change the channel or camera and **Refresh** to reload new screen shot.

7.6 Using PDAViewer to Access DVR Server

Users can also use a PDA to access the DVR through Internet. Make sure your PDA support IE browser and is connected to the internet. To use this feature, you need to install the PDAViewer software either thru ActiveSync connection or download it from the internet. Please check if your PDA meets the 2 requirements below.

OS: MS Windows CE 4.0, PocketPC 2002/2003, Mobile 5 PDA version
CPU: ARM architecture

7.6.1 To install PDAViewer thru ActiveSync

1. Connect your PDA to your PC. Place the CD into the CD-ROM drive then click Install PDAViewer. And follow the on screen instructions.



2. Click **Next** to continue.

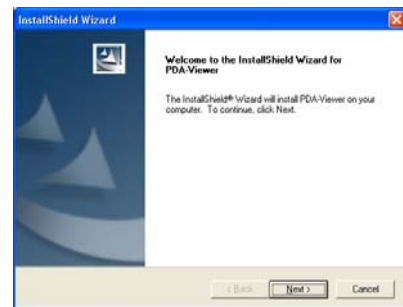

3. Read the license agreement and click **Yes** to accept all the terms. The system will then automatically install the application.



4. When you are prompted, click **Yes** to install the application using the default directory.

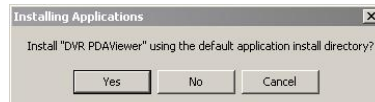

5. When done, click **OK**.



7.6.2 To install PDAViewer from the Internet

1. Make sure you are connected to the internet.
2. Open the web browser and enter the server IP. Then click the hyperlink Download PDAViewer.
3. When the Download dialog box appears, enable Open file after download and click **Yes**.

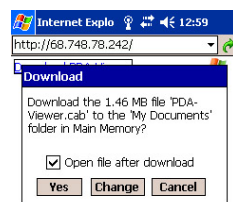

- After the installation, the PDAViewer 5.5 icon will appear in the Programs list.

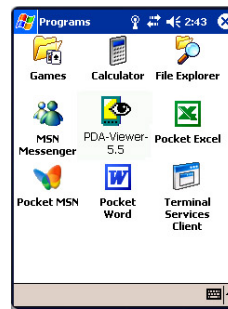

7.6.3 To Use the PDAViewer

- Run the **PDAViewer 5.5** in the Programs.
- Familiarizing the PDA Viewer buttons.

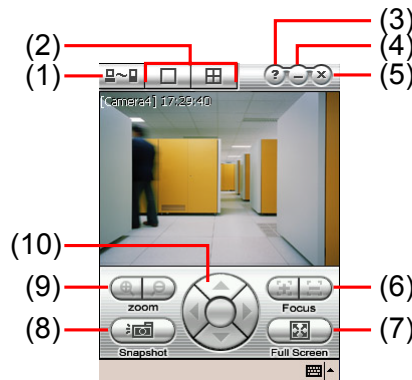

Name	Function
(1) Connect	Hook up to the DVR server. Make sure you are connected to internet. When the iView screen appears, enter the server IP, port, user ID, password and select the connection type. Then, click OK .
(2) Split Screen Mode	Select between 2 screen display types. It also allows you to switch and view different camera number or channels.
(3) About	Display the PDA-Viewer software version.



Name	Function
(4) Minimize	Reduce the size to taskbar.
(5) Exit	Close the PDA-Viewer.
(6) Focus	Adjust the focus of PTZ camera to produce clear image.
(7) Full Screen	Use the entire screen to only display the video.
(8) Snapshot	Capture and save the screen shot in *.bmp format.
(9) Zoom	Zoom in and out the PTZ camera image.
(10) Direction buttons	Adjust and position the focal point of the PTZ camera.

- To change the video quality, enable/disable audio, and select to display different camera, tap on the video screen longer the pop up menu will appear.



7.6.4 Using JavaViewer to Access DVR Server

Using the mobile phone within Symbian Smart Phone OS to access the DVR through Internet. Make sure your mobile phone supports Symbian Smart Phone OS and can be connected to the internet. To use this feature, you need to install the JAVAVIEWER program that it can be downloading it from the DVR server through the internet.

To install JAVAVIEWER from the DVR Server

- Open the web browser and enter the DVR server IP (<http://DVR server IP: port/JAVAVIEWER.html>). Then click **Connect**.
- When the Download screen appears, select **JAVAVIEWER.jad** and download it to your mobile phone.
- After the installation, the JAVAVIEWER will be in your mobile phone system. To find the JAVAVIEWER program where is located, please refer to your mobile phone user's manual.

7.6.5 To Use the JAVAViewer

1. Run the JAVAViewer program.
2. Enter the DVR IP address, port number, user ID, and password. Please refer to your DVR server setting for that information.
3. And then, select the Connect to connect to DVR server.
4. Click **Yes** to accept the data from DVR server.
5. When connection is success, you will see the camera video on the screen.



6. To switch to different camera view, select menu and select the channel.



7. The JAVAViewer support PTZ control function, you can refer to **Help** file for detail function control key. Select **menu** and go the way down to select the **Help** file.



Chapter 8 Image Verification

ImageVerification is a watermark-checking program to identify the authenticity of a saved image (e.g. by snapshot). This program can only verify uncompressed bmp image files.

8.1 To Run the ImageVerification program

1. Click **Start > Programs > DSS > ImageVerification**.
2. In the ImageVerification screen, click **Load Source Image** and locate the image source.
3. Click **Verify Image** to begin the process.
4. Check the result in the Processed Image screen. If the picture is unmodified, the image in the Source Image and Processed Image screen would be exactly the same. If the picture is being modified, a warning dialog box would prompt you and the modified area is highlighted.

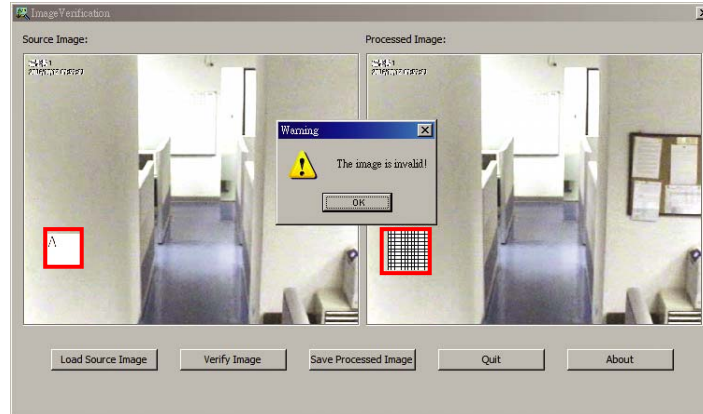

Chapter 9 iEnhance

The bundled iEnhance is a video editing tool and can only be used with *.dvr video file. It allows you to adjust the video picture quality, segment and save the wanted portion of the video, zoom in and out the image, and print or save the screen shot. You can also save the setting and apply it on other files.

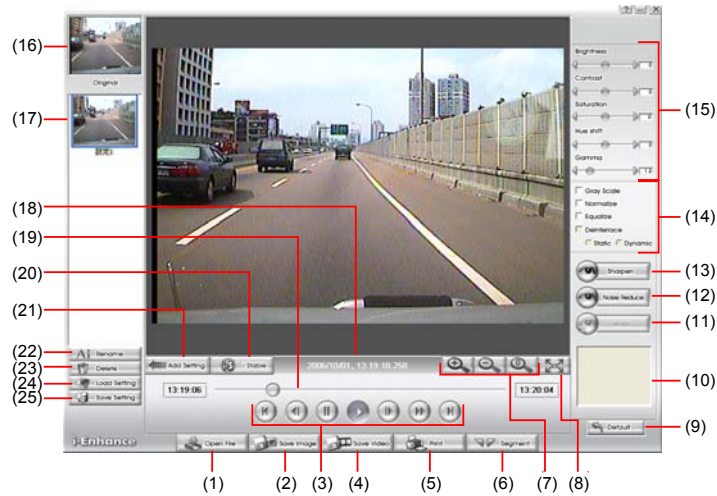

Name	Function
(1) Open File	Access *.dvr video file.
(2) Save Image	Capture and save the screen shot in *.bmp format.
(3) Playback Control Buttons	<p>Begin: Move to the beginning of the video file.</p> <p>Previous: Go back to the previous frame.</p> <p>Pause: Briefly stop playing the video file.</p> <p>Play: Play the video file.</p> <p>Faster: Play the video file at faster speed</p> <p>Next: Go to the next frame.</p> <p>End: Go to the end of the video file.</p>
(4) Save Video	Save the edited or segmented video in *.avi format.
(5) Print	Print the screen shot.
(6) Segment	Mark the beginning and the end of the wanted portion of the video. Two triangle marks will appear on the slider. To cancel video segmentation, click this button again.
(7) Zoom Buttons	Enlarge, reduce, and set the image back to normal size.
(8) Full Screen	Use the entire screen to only display the video.
(9) Default	Set the video back to original state and delete all the changes in the history box.

Name	Function
(10) History Box	List all the actions.
(11) Undo	Delete the last action.
(12) Noise Reduce	Adjust the softness and repair the damaged colours.
(13) Sharpness	Improve the overall image by enhancing edges. This gives the image more depth.
(14) Effects	<ul style="list-style-type: none"> • Gray Scale: convert the image into black and white (monochrome). • Normalize: adjust the brightness intensity. • Equalize: automatically adjust the images that are too dark. • De-interlace: smooth out the overlying frames. • Static: de-interlace for motionless scene. • Dynamic: de-interlace for moving scene.
(15) Picture Adjustment	Adjust the Brightness, Contrast, Saturation, Hue and Gamma.
(16) Original Screen	Display the original state of the image.
(17) Temporary Setting Block	Display the sample settings. Click the sample to apply the setting on the current video.
(18) Status Bar	Display the date, and time of the video.
(19) Progress Bar	Show the progress of the file being played. You may move the bar to seek at any location of the track.
(20) iStable	To reduce the jolt in the recorded video.(also see Chapter 9.1)
(21) Add Setting	Include the new setting to the temporary setting block.
(22) Rename	Change the name of the selected setting in the temporary setting block.
(23) Delete	Permanently remove the selected setting in the temporary setting block.
(24) Load Setting	Call the saved settings.
(25) Save Setting	Store the settings in the temporary setting block.

9.1 To Use iStable

The iStable function can reduce the jolt in the recorded video.

1. Click **Open File** button and select the recorded video.
2. And then, click **iStable** button.
3. iStable windows will show up.
4. Select the **smoothness level** – 1(Low), 2, 3, 4, and 5(High). The default value is 3.
5. Click **Play** button, and then i-Stable function will start to initial the recorded video.
6. When the initialize is done, user will see the original and stabilized recorded video play in two windows.

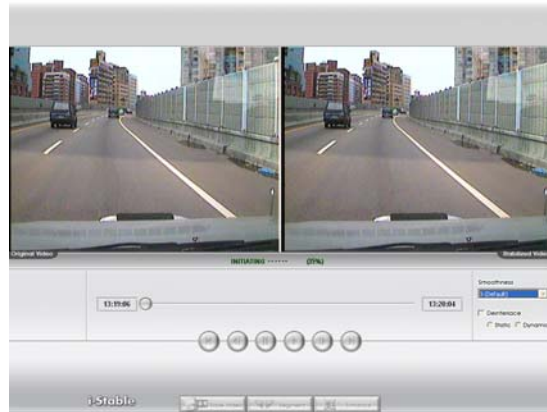

Chapter 10 Web Tools

The bundled Web Tools includes Dispatch Server and Remote Backup program. To install Web Tools, place the CD into the CD-ROM drive then click **Install Web Tools**.

10.1 Dispatch Server

Dispatch is designed to reduce the network traffic of the DVR server. Instead of connecting directly to the DVR server, the client can connect to the computer that is connected to the DVR server using the Dispatch program.

To Run Dispatch program:

1. Make sure you are connected to the internet.
2. Click **Start>Programs>DSS>Tool>Dispatch**.
3. In the DVR Server section, enter the DVR server IP, port, user ID and password. You can also select to display the language you prefer.
4. **Auto connect when star**
Enable to automatically connect the dispatch server when start up
5. In the **Dispatch Service** section, if you have installed more than one network card, select the Service IP number.
6. In the **Dynamic DNS Configuration** section, enter the DNS server Name and Password. The DNS server can be the remote storage server for sharing the DVR system loading.
7. Click **START** to connect.

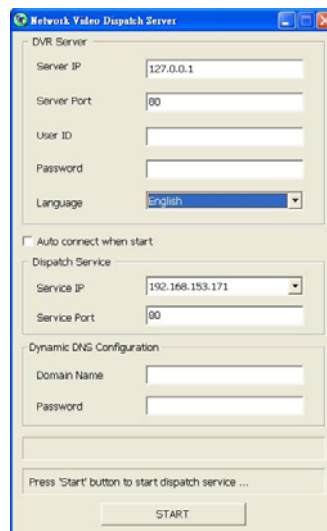

The screenshot shows the 'Network Video Dispatch Server' configuration window. It is divided into several sections:

- DVR Server:** Contains input fields for 'Server IP' (127.0.0.1), 'Server Port' (80), 'User ID', 'Password', and a 'Language' dropdown menu set to 'English'.
- Auto connect when start:** A checkbox that is currently unchecked.
- Dispatch Service:** Contains a 'Service IP' dropdown menu (set to 192.168.153.171) and a 'Service Port' input field (80).
- Dynamic DNS Configuration:** Contains 'Domain Name' and 'Password' input fields.
- Bottom:** A 'START' button and a text prompt: 'Press 'Start' button to start dispatch service ...'.

10.2 Remote Setup

Remote Setup is a tool for configuring DVR server from remote site. To install Remote Setup application, insert the Installation CD into CD-ROM drive and click **Web Tools**. After installation, click  to start the Remote Setup application.

10.2.1 To Add DVR server

User need to add a DVR server and make connection in order to setup remote DVR server.

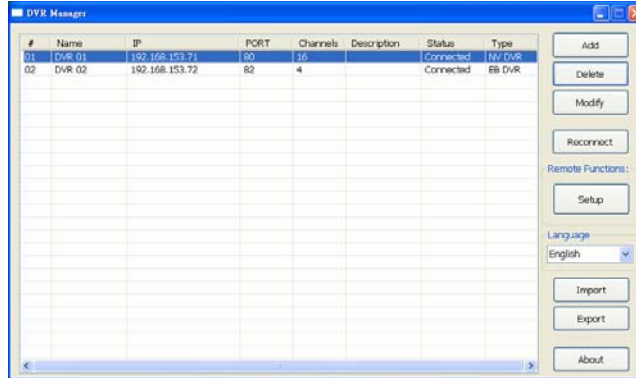

1. Click **Add**
2. In Edit DVR windows, fill in the following items:
 - **Name:** give a name for remote DVR server for easy managing
 - **IP:** fill in remote DVR server's IP address
 - **Port:** the port use to connect to remote DVR server. The port number is same the Webviewer port on the remote DVR server. The default is 80.
 - **User ID:** fill in the remote DVR server's login account
 - **Password:** fill in the remote DVR server's login password
 - **Description:** fill in a short description for the remote DVR server

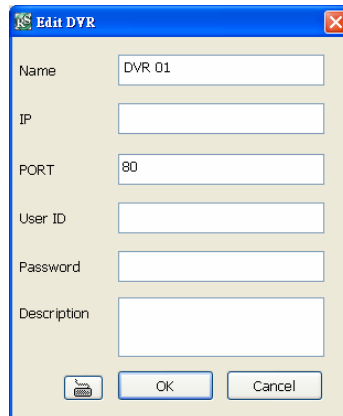

Fields: Name (DVR 01), IP, PORT (80), User ID, Password, Description

Buttons: OK, Cancel

3. Click **OK** to complete adding remote DVR server.
4. The added DVR server will be listed and auto connects to DVR server.

5. Once the connecting is success, user can start to configure DVR server.
6. When connection is lost, click **Reconnect** to connect again.
7. To modify or delete the added DVR server, select the DVR server from listing and click **Modify** to change the setting and click **Delete** to remove the DVR server.
8. User also can import the setting by clicking **Import** button. To save the setting to local hard disk, click **Export** button.

10.2.2 To Setup Remote DVR Server

Select the DVR server from listing and click **Setup** to configure remote DVR server.

System Setting

In the System Setting windows, click **Update** to accept the new settings, click **Exit** to exit without saving, and click **Default** to revert back to original factory setting.

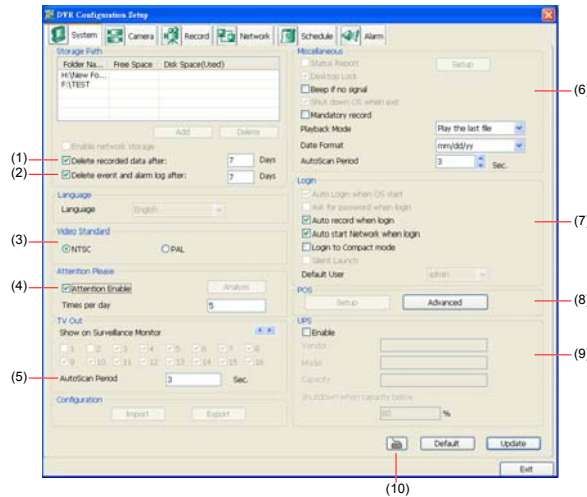

(1) Delete recorded data after

If you want the system to automatically erase the data after a certain days, enable the **Delete recorded data after** check box and enter the numbers of days in **Days** text box.

(2) Delete event and alarm log after

If you want the system to automatically erase the event and alarm log files after a certain days, enable the **Delete event and alarm log after** check box and enter the numbers of days in **Days** text box.

(3) Video Standard

Change and select the proper video system according to your camera video system. If the video system setting is wrong, the video would appear abnormal.

(4) Attention Please

Check the attentiveness of the person who is monitoring the system. You may set the number of times the Attention dialog box to appear in a day in **Times per day** text box.

When this feature is enabled, the **Attention** dialog box would appear. The person who is monitoring the system must enter the same number that appears from the left box at

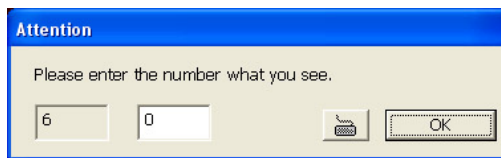

the right text box and then click **OK**.

(5) TV Out

Set the display time gap from 3 to 10 sec. before it switches to the next camera.

(6) Miscellaneous

Enable the conditions in **Miscellaneous** section you want the system to perform.

-Beep if no signal

Make sound when the video signal is lost.

-Mandatory Record

Always record video when software is running

-Playback Mode

Select the mode of playback the video.

Select date and time: Select the date and time which user wants to playback.

Play the last file: Automatically playback the video from the last hour

Instant Playback: Automatically playback the video which has just recorded

-Date Format

Select the date format which wants to display in **Select date and time** playback mode

-Auto Scan Period

Set the time gap of the Auto Scan function from 3 to 10 seconds. This automatically switches to the next video in cycle depending on the set time gap.

(7) Login

Enable the conditions in Login section you want the system to automatically carry out.

-Auto record when login

Automatically start video recording when the DVR is executed.

-Auto start Network when login

Automatically connect to network when the DVR is executed.

-Login to compact mode

Switch to compact mode directly when the DVR is executed.

(8) POS

Set from which camera screen to display the data from the POS equipment. To set the text flow and color format, click **Advanced**.

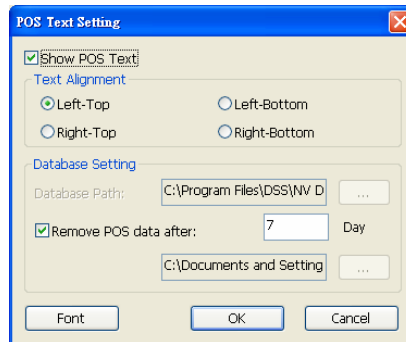

(9) UPS (Uninterruptible Power Supply)

Protect the system from damaging, such as power surges or brownouts. This automatically gives time to close the DVR properly when the battery backup power has reached the Shutdown when capacity below percentage level setting. The UPS device must be connected to your DVR.



The DVR system default supports SPECO UPS.

(10) Virtual Keyboard

If the keyboard is not available, you may use the Virtual Keyboard. Just click  to show the virtual keyboard. For uppercase and lowercase, click **shift** button.

Camera Setting

Select the camera from remote DVR servers to modify settings. In the Camera Setting windows, click **Update** to save and apply the new settings, click **Exit** to exit without saving, and click **Default1/ Default2** to revert back to original factory setting.

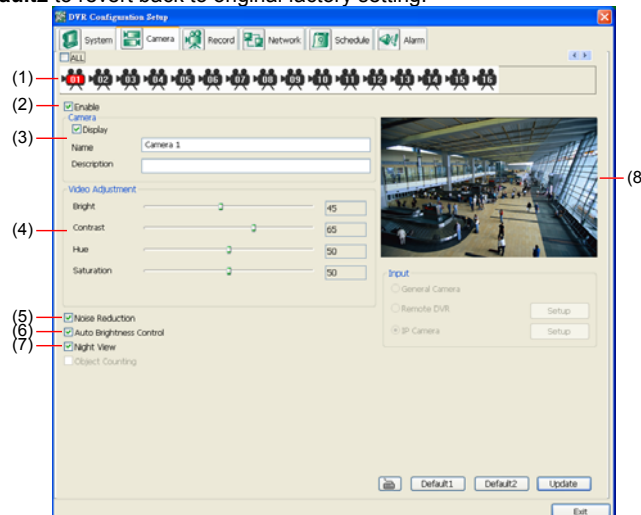

(1) Camera Icons

Select the camera number you want to adjust the video setting. To select all the cameras, enable the **ALL** check box. To select more than one camera, Right click on the camera icon. To select one camera only, Left click on the camera icon. The camera icon turns red when it is selected.

(2) Enable

Set to enable/disable the selected camera. When there is no video source on the camera, we suggest disabling it so that the system won't detect it as video loss error.

(3) Camera

Display

Enable/disable to show the video. Even if the video of the selected camera is hidden you can still record the video and preview it in playback mode.

Name

Change the camera name.

Description

Add a short comment.

(4) Video Adjustment

Adjust the Brightness, Contrast, Hue and Saturation of the selected camera.

(5) Noise Reduction

Reduce undesirable video signal and improve the quality of the video.



Noise Reduction uses lots of CPU resource. Please use this feature only if it is really necessary.

(6) Auto Brightness Control

Automatically adjust the brightness.

(7) Night View

Automatically adjust the exposure to make the image more visible especially when the site is dark. You can only use this function when the **Auto Brightness Control is enabled**.

(8) Video Screen

Display the video of the selected camera.

Record Setting

In the Recording setup windows, click **OK** to accept the new settings, click **Exit** to exit without saving, and click **Default** to revert back to original factory setting.

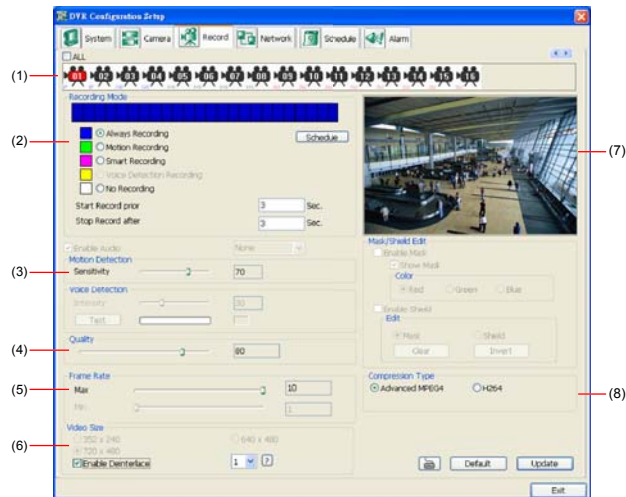

(1) Camera Icons

Select the camera number you want to set the recording setting. To select all the cameras, enable the **ALL** check box. To select more than one camera, **Right click** on the camera icon. To select one camera only, **Left click** on the camera icon. The camera icon turns red when it is selected.

(2) Recording Mode

The blocks from 00 to 23 represent the time in 24-hour clock. To record in full 24 hours, select the recording mode and click the button. If you want to only record at a particular time, click the colored block beside the recording mode then click on the time blocks. When the system starts recording a red triangle mark would appear at the upper left corner of the screen. The recording modes are listed below:

-Always Recording

Record the video from the selected camera and save it to the designated storage path

-Motion Recording

Start recording the video from the selected camera only when the system detects movement. Once a motion is detected, the system automatically saves the previous frames and stop based on the **Start Record Prior** and **Stop Record After** settings.

-Smart Recording

Automatically switch to recorded at the maximum frame rate setting once a motion is detected and if there is no motion, it records at the minimum frame rate setting. Set the maximum and minimum frame rate setting in [\(5\) Frame Rate](#) section.

-No Recording

The system won't do any recording.

(3) Motion Detection

Adjust the sensitivity of the motion detector. The higher the value, the finer the sensitivity is detected. When it detects a motion, a green triangle mark would appear at the upper left corner of the screen.

(4) Quality

Adjust the video quality. The higher the value, the lower the compression level and uses more

hard disk space.

(5) Frame Rate

Set the maximum number of frames to be recorded during motion and motionless state. The frame rate ranges from 1 to 30 for NTSC and 1 to 25 for PAL. The higher the frame rate, it uses more hard disk space.

(6) Video Size

User can activate the **Enable Deinterlace** to enhance the video quality. Set the **Enable Deinterlace** mode to #1, if you are capturing motionless picture and #2, if it captures lots of movement.

(7) Video Screen

Display the video of the selected camera

(8) Compression Type

User can refer the table below to check the NV card supports what type of compression. H264 is the latest and advanced video compression format that delivers better video quality and smaller file size but this uses more CPU resource. Advanced MPEG4 and MJPEG, both provide a standard for color picture compression rate. MPEG4 uses higher compression rate and smaller file size. While MJPEG uses slightly lower compression rate and bigger file size.

Network Setting

In the Network Setting dialog box, click **Update** to accept the new settings, click **Exit** to exit without saving, and click **Default** to revert back to original factory setting. For the network service ports that use by DVR server, please see [Appendix D](#).

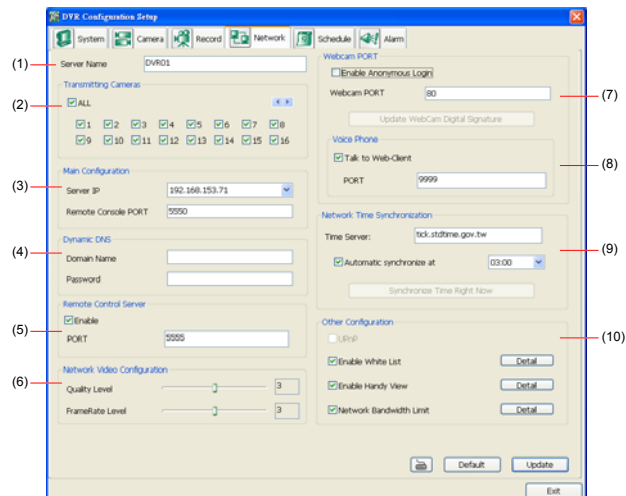

(1) Server Name

Assign a name for the DVR unit. Letters of the alphabet and numbers only.

(2) Transmitting Cameras

Select and click on the camera number in the Transmitting Camera section you want to make it accessible via internet using WebViewer, Remote Console, PDAViewer and HandyViewer (still image). To select all the cameras, enable the **ALL** check box.

(3) Main Configuration

Set the Server IP and Remote Console Port number. The system will automatically detect your Server IP address. You need this when accessing DVR server from the remote location via internet.

(4) Dynamic DNS (Domain Name System)

Enter the Domain Name and Password. To use this feature, first register your domain name on the following Web site <http://ddns.dss.com.tw>

1. User Login

Browse the website ddns.dss.com.tw with Microsoft IE or Netscape Navigator to access the following dialog. You will be prompted to enter CD key number, product name, password, and user information. Use this service if the IP address changes each time when you connect to internet.

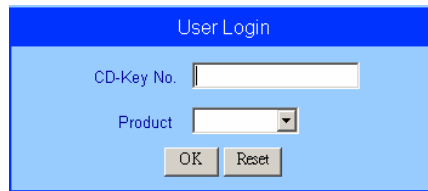

The 'User Login' dialog box has a blue header and a light blue body. It contains a text input field for 'CD-Key No.', a dropdown menu for 'Product', and two buttons at the bottom: 'OK' and 'Reset'.

- First input CD-Key number (serial number) and select the product name.
- Then click **OK** to login or **Reset** to clear the previous input.

2. User Information

Please provide the following user information, **Host Name** (user can choose any name he/she likes except the one violence with other users), **Password**, **E-mail**, **Company**, and **Country**. And then, click **OK** to complete the domain name registration.



The 'User Information' dialog box has a blue header and a light blue body. It contains several fields: 'Host Name' (text input with a red asterisk), 'Domain Name' (text input with 'dss.com.tw' and a red asterisk), 'Password' (text input with a red asterisk), 'Confirm Password' (text input with a red asterisk), 'E-mail' (text input with a red asterisk), 'Company' (text input), and 'Country' (dropdown menu with 'United States' selected). At the bottom are 'OK' and 'Reset' buttons.

(5) Network Video Configuration

Set up the video quality and frame rate for viewing and transmitting to the remote program. Scrolling adjust bar to set the **Quality level** and **FrameRate level**.

(6) WebViewer Configuration

Activate **Enable Anonymous Login** to remotely access the DVR server without the need of password. The default of Web port is 80.

(7) Voice Phone

Voice Phone is a 2-Way Talk feature that allows the client and server to talk via internet using microphone. Make sure both microphone and speakers work before using this feature. If the **Talk to Web-Client** is disabled, the person in the DVR server side can only hear the voice from the client side that is when the WebCam 2-Way Talk button is activated. (See also [Chapter 7.1 #6](#)). The default port of voice phone is 9999.

(8) Network Time Synchronization

Adjust the DVR system time same as network time server. Fill in the **Time Server** IP address or domain name. Select **Automatic Synchronize** time to set automatic synchronize time on a daily

basis.

(9) Other Configuration

- UPnP

Enable UPnP function to automatically configure the port setting on the local network. This function is available when there is UPnP device in the same network. It will write the DVR port information into the router or other network device

- Enable White List

An access permit list for the remote accessing of DVR server. Enter the IP address and click **Add**. Or, enter a range of IP address and click **Add**. To delete the IP from the list, select the IP and click **Delete** button. To reset the input, click **Clear** button.

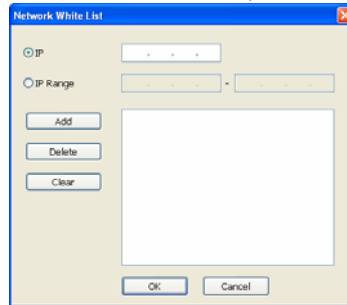

- Enable HandyViewer

Enable remote users to use a PDA or a mobile phone to access DVR server and select the video size and quality. (See also [Chapter 7.5](#) and [7.6](#))

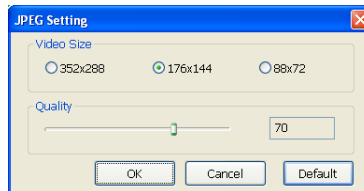

- Network Bandwidth Limit

By Channel: Set the network bandwidth by each channel.

All: Set the total network bandwidth consumption limit.

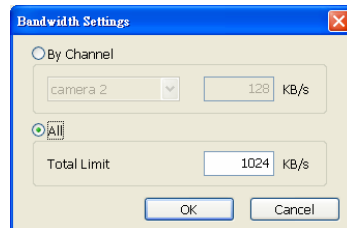

Schedule Setting

Schedule to record, backup, enable network, reboot and disable alarm of all the cameras either weekly or one time. The number from 00 to 23 represent the time in 24-hour clock. The left most column display the days in a week.

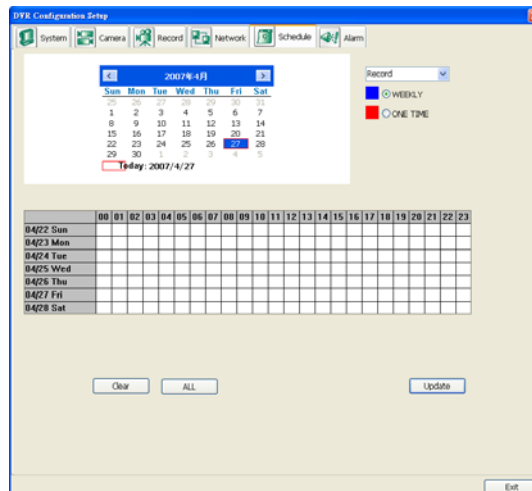

To Set the Schedule Setting:

1. Select the date in the calendar. Use and buttons to shift the calendar to the left or right.
2. Select the condition you want to schedule in the drop down list.
 - **Record**
Activate all the cameras to start video recording at the set time based on the Recording setting (see also [Chapter 4.3](#)).
 - **Backup**
Save another copy of all the data at the set time and specified backup path. DVR automatically updates and only backup the data that are not yet included in the archive.
 - **Network**
Activate DVR remote system to access at the set time. After the appointed time, the Network function will be disabled. If the Network function is already enabled, the Network function will not be disabled when the appointed time has ended.
 - **Disable Alarm**
Deactivate the alarm at the set time temporarily.
3. Specify to either schedule it weekly or one time. Click to make a selection.
4. Click on the blocks to set the schedule (see also [Chapter 4.5.1](#)). Or click **All** to select all. To store the setting, click **Save**. To remove the settings, click **Clear**.
5. To end Schedule Setting, click **Update** to exit and accept the setting and **Exit** to exit without saving the setting.

Alarm Setting

In the Alarm Setting dialog box, click **Add** to insert and set new alarm setting, click **Delete** to remove the selected alarm setting, click **OK** to exit and save the setting, **Cancel** to exit without saving, and **Default** to revert back to original factory setting.

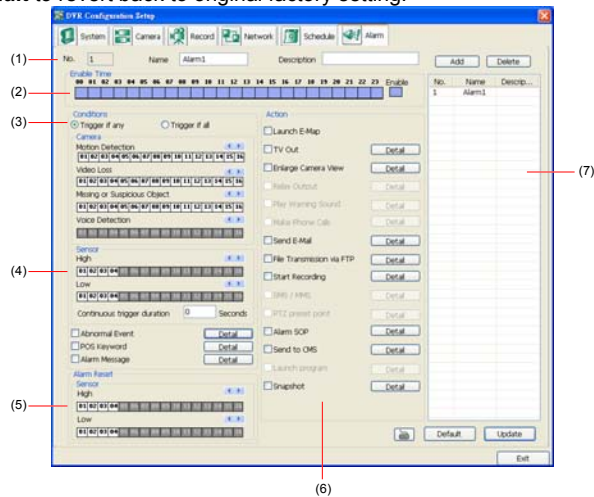

To set the Alarm Setting:

1. Click **Add** to insert and set a new alarm setting. Click the items in the **(7) Alarm Setting List**, if you want to modify the alarm setting.
2. In **(1) Alarm Setting number/Name/Description**, display the selected alarm setting number in the list below. Enter alarm name and description.
3. In **(2) Enable Time**, the number from 00 to 23 represent the time in 24-hour clock. Select the time and click the block you want to activate or deactivate the alarm function. When it is deactivated the color of the block turns white.
4. In **(3) Conditions**, you can set **"Trigger if any"** to activate if it falls to one of the conditions or **"Trigger if all"** to activate if it falls to all conditions.
 - In **Camera** section, select and click on the camera number (01 to 16) in **Motion Detected** and **Video Loss** to set the condition for the system to alarm.
 - In **Missing and Suspicious Object Detected**, click the camera number (01 to 16) and select the certain object on the screen (right click on camera number for detailed setting)), and when the certain object is missing or doubtful, the system will alarm. (see also [Chapter 4.9.12](#)) In **Scene Change**, when the camera has been moved, the system will alarm, too.
 - In **Voice Detection**, click the camera number (01 to 16) to the system to alarm when detect the abnormal voice.
5. In **(4) Sensor**, select and click on the sensor number (use ◀ and ▶ to select the sensor) to set the condition for the system to alarm. If the sensor normal status is high, set the sensor condition to low (see [Chapter 4.7 step #4](#)).
 - Enable/disable the **Abnormal Event** check box, to set the condition of the event for system to alarm.
 - **Normal Reboot**: when the DVR system reboot without abnormal condition, the system will send out the alarm message.
 - **Abnormal Reboot**: when the DVR system reboot in irregular condition, the system will send out the alarm message.
 - **Recording is switched off**: when the recording has been stopped, the system will

send out the alarm message.

- **Network is switched off:** when the network connection of DVR system is lost, the system will send out the alarm message.
- **Hard Disk failed:** when the hard disk can't work normally, the system will send out the alarm message.
- **Temperature:** set a temperature limited of system for system to alarm. When DVR system temperature is over the temperature limited, the system will send out the alarm.



Temperature setting only supports on NV DOM 6000 Express card.

- **Illegal Entry:** any objects move between selected regions which user has set up in **Object Counting** section (see also [Chapter 4.2.1](#)), the system will send out the alarm. Select the entry (object moves from region 1 to 2 or from region 2 to 1) and camera for system alarm detection.

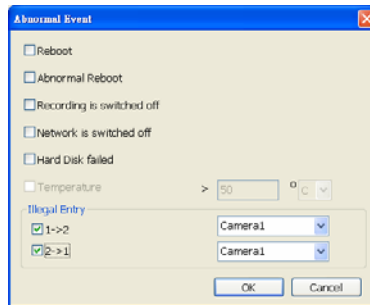

- Enable/disable the **POS Keyword** check box, to scan the data from the POS if it matches the keyword (see also [Chapter 4.9.11](#)).
 - Enable/disable the **Alarm Message** check box, to active with external alarm message by your own program. For the detail configuration, please contact the local reseller.
6. In **(5) Alarm Reset**, click the camera number (use ◀ and ▶ to select the alarm) to set the reset condition of alarm. Once alarm is reset, all alarm action will stop at the moment. If the sensor normal status is high, set the sensor condition to low.
 7. In **(6) Action**, you may now set the alarm action for the system to perform when the alarm condition is activated.
 - **Launch E-Map**
Display mini Emap screen.
 - **TV Out**
Switch to only display the video on TV from where the alarm is activated.
 - **Enlarge Camera View**
Switch to only display video in Preview/Advanced mode from where the alarm is activated.
 - **Send E-mail**
Send an electronic text message. To setup click **Detail** (see also [To Setup Send E-mail](#)).
 - **File Transmission via FTP**
Upload file to remote computer thru FTP (File Transfer Protocol). To setup click **Detail** (see also [To Setup FTP](#)).
 - **Start Recording**
Record the video from the selected camera. To setup click **Detail** (see also [To Setup Alarm Recording](#)).
 - **Alarm SOP (Standard Operation Procedure)**
List the instructions to inform the person of what to do when the alarm is activated. To

- setup click **Detail** (see also [To Setup Alarm SOP](#)).
- **Send to CMS (Central Management System)**
Enable/disable the selected camera to send video to CMS when the alarm is activated (see also [To Setup CMS Setting](#))
- **Snapshot**
Take a snapshot when the alarm is activated.
 - a. **Select Camera:** specify which channel video to be snapshot when the alarm is occurred.
 - **Alarm Camera:** when a channel has an alarm occurred, and then, the DVR system will snapshot the channel video.
 - **Camera # (1~32):** the selected channel would be snapshot when an alarm is occurred.
 - b. **Video Size:** select the size of snapshot picture.
 - c. **Number of picture:** the number of picture that is going to be taken.
 - d. **Snapshot Interval:** a time gap for next snapshot
 - e. **Save Path:** a storage path for saving snapshot pictures.

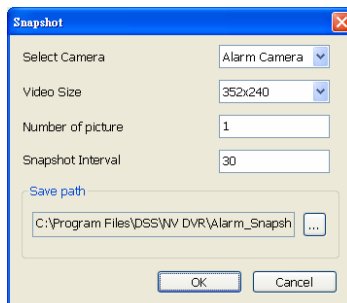

To Setup Alarm Relay:

1. Beside the Relay Output check box, click **Detail**.
2. In the Alarm Relay dialog box, select from the available relay list and in the **ON** column, set to enable/disable the relay operation when the alarm is activated. In the Retrieve time check box, you may enable/disable to extend the relay operation time and set the duration in second.
3. Click **OK** to exit and accept the setting and **Cancel** to exit without saving the setting.

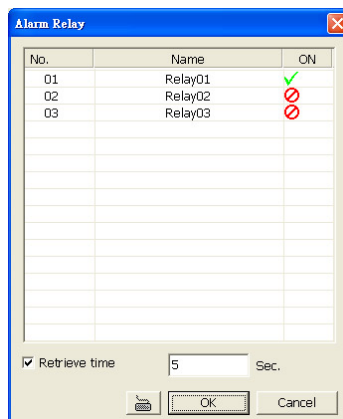

To Setup Send E-mail Setting:

Beside the Send Email check box, click **Detail**. In the E-mail Setting dialog box, click **OK** to exit and save the setting and **Cancel** to exit without saving the setting.

(1) Mail Server

Enter the SMTP Server and port. If your e-mail system requires user identification, enable **Authentication** check box and enter User ID and Password.

(2) Mail

To check if it is working, click **Test Account** button.

From : Enter the sender e-mail address.

To and CC :Enter the recipient email address and separate it with comma or a semicolon (;).

Subject : Enter the message title.

Message : Type the message.

(3) Email Notice Setting

- **Notice Interval**: Set the period of time before it sends another e-mail notice.
- **Embedded image** : Select the image size and set the number of frames.
- **Attach image when sensor is triggered**: When the sensor is triggered, the system will capture the image and send the image to the certain e-mail address with the alarm message.

(4) Modem Dial up Setting

User may set the time to disconnect automatically, just enable the **Auto Disconnect after** check box and set time.

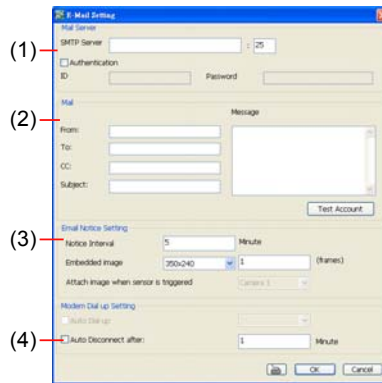

To Setup FTP Setting:

1. Beside the File Transmission via FTP check box, click **Detail**.
2. In the FTP Setting dialog box, enter the FTP IP, port, user ID and password.
3. Click **OK** to exit and save the setting and **Cancel** to exit without saving the setting.

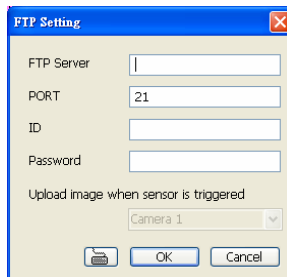

To Setup Alarm Recording Setting:

1. Beside the Start Recording check box, click **Detail**.
2. In the Alarm Recording Setting dialog box, select the camera to enable/disable video recording. Enable **All** to select all cameras.
3. In the Frame Rate selection, select **As Setting** to record the number of frames based on the Recording Setting or **Max** to record the maximum of frames based on the available speed.
4. In the Stop Recording after text box, set the number in second for the program to continue recording after the alarm has ended.
5. Click **OK** to accept the new settings and **Cancel** to exit without saving.



To Setup Alarm SOP:

Beside the Alarm SOP check box, click **Detail**. In the step text boxes, type the standard protocol when the alarm is activated. When the alarm is activated, the Standard Operation Procedure dialog box will appear. Just click **Next** to see the next instruction, **Back** to see the previous instruction, **Finish** to end and **Abort** to terminate.

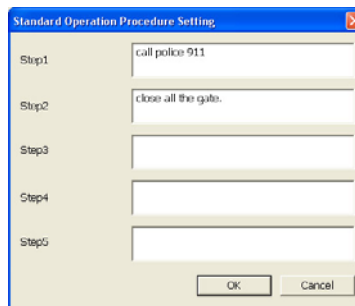

To Setup CMS Setting:

Beside the Send to CMS check box, click **Detail**. In the CMS Setting, select the camera to enable/disable sending the video to CMS. Enable **All** to select all cameras. Then, click **OK** to accept the new settings and **Cancel** to exit without saving.



10.3 Remote Backup

Remote Backup is purely for backing up the *.dvr file from the DVR sever. You can select between Auto Backup and Manual Backup. Auto Backup continuously archives one hour of the recorded data at a time, starting from the specified date. As for Manual Backup, it only archives the recorded data of selected date.



To back up the data, you must have at least 2G hard disk space.

To back up the recoded data from the DVR server:

1. Make sure you are connected to the internet.
2. Click **Start >> Program >> DSS >> Tool >> Remote Backup**

- To add the DVR server, click **Add**

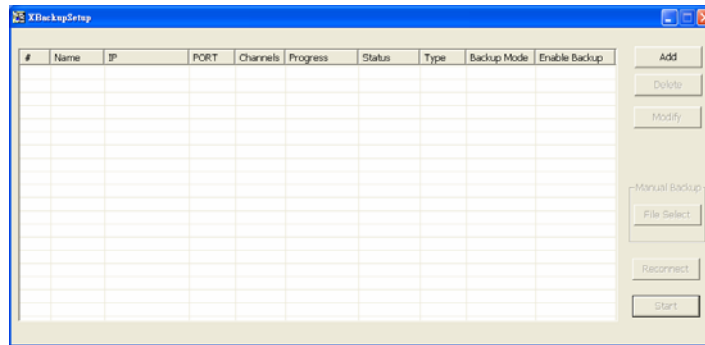

- In the Add New DVR windows, enter the Name, IP, user ID, and password.

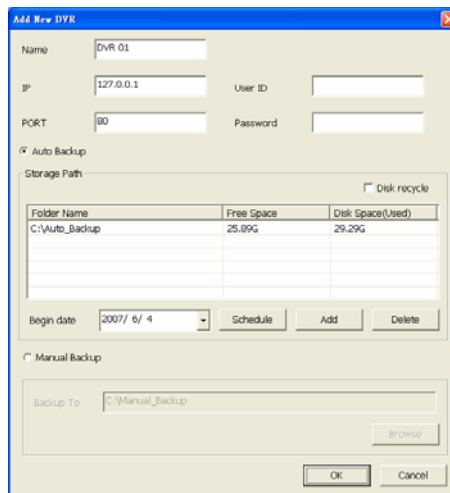

- Select the Backup mode:

Auto Backup mode: the backup will automatically execute when the setup is completed

- In Begin Date drop down calendar, select the date from where to start
- Click **Add** to set the storage path.
- Click **Delete** to remove the selected storage path.
- Click **Schedule** to select/unselect the time you want to backup. The red block turns white when it is unselected.
- Enable/disable **Disk Recycle** check box, to automatically overwrite the oldest file when there is not enough free space to backup the file.

Manual Backup mode: the backup progress will start when user press the backup button

- Click **File Select** to choose the date, time and camera you want to back up.
- Click **Browse** to set the storage path.

- Click **OK** to complete the adding DVR server. The added DVR server will display in Remote Backup main windows.

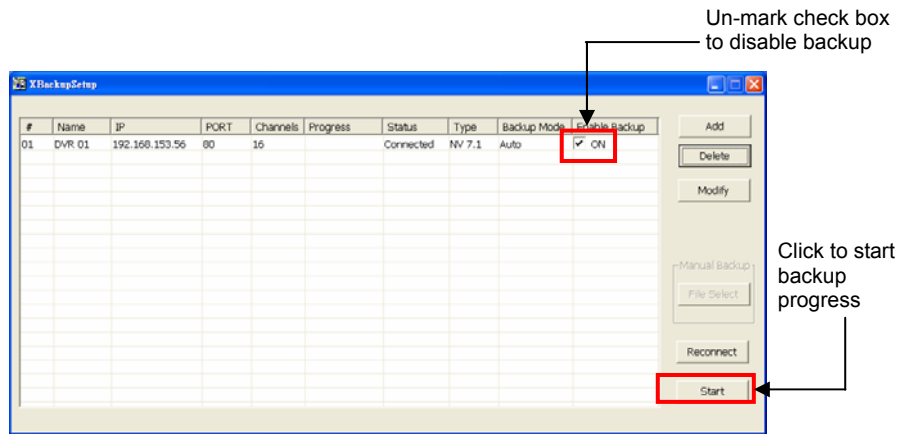

7. Click **Start** to begin backup and click Stop to stop backup progress.

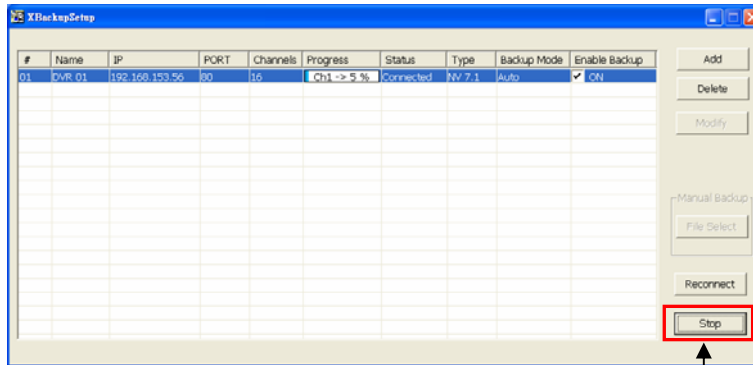



While backup, the **start** button will turn to **stop** button

8. For manually backup, click **file select** button and select the DVR wants to backup

Chapter 11 Using the Remote Control Server

The bundled Remote Control Server enables the PC with Central Management System program (CM1000) installed in it remotely access the DVR server. You may need to manually run this program for CMS access the DVR server. To run, click **start > Programs > DSS > DVR > Remote Control Server**.

The  remote control server icon appears on the taskbar when the remote control server is enabled. To change the port setting or stop server, right-click  icon and then make a selection.

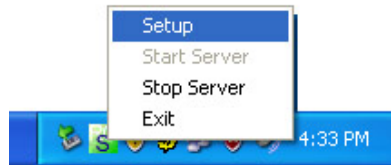

User can also setup Remote Control Server in DVR **Network** setting, please see [Chapter 4.4 #\(5\)](#).

APPENDIX A Network Service Port

The following table shows the ports that DVR server uses for certain network service.

	Port #	Variable
Remote Console (CMS)	5550	Y
WebViewer	80	Y
2-way audio	5552	Y
Remote Control (CMS)	5551	Y
DVR POS	5150	Y
DVR DDNS (Upload / Download)	53 / 1053	N

APPENDIX B Install PTZ through RS-232 Interface

Use the RS232 to RS485 converter to install an analogue PTZ camera to the COM port.

Please refer to the below figure for installation

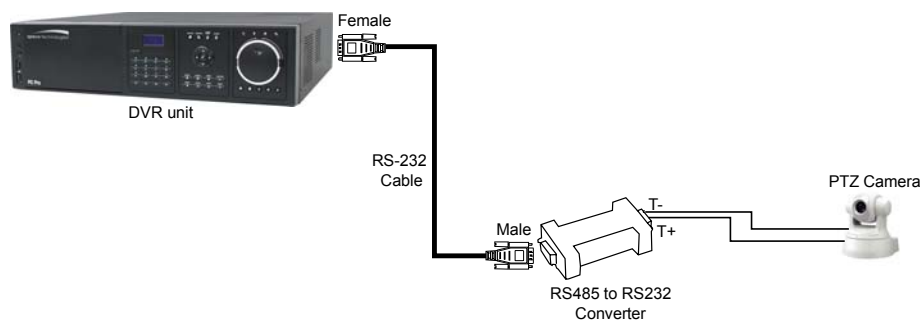

Free Manuals Download Website

<http://myh66.com>

<http://usermanuals.us>

<http://www.somanuals.com>

<http://www.4manuals.cc>

<http://www.manual-lib.com>

<http://www.404manual.com>

<http://www.luxmanual.com>

<http://aubethermostatmanual.com>

Golf course search by state

<http://golfingnear.com>

Email search by domain

<http://emailbydomain.com>

Auto manuals search

<http://auto.somanuals.com>

TV manuals search

<http://tv.somanuals.com>