

INSTRUCTION MANUAL

P-30FACC 30 WATT RMS

P.A. Amplifier with FM/AM tuner and cassette player

P-30FACD 30 WATT RMS

P.A. Amplifier with FM/AM tuner and CD player

P-60FACC 60 WATT RMS

P.A. Amplifier with FM/AM tuner and cassette player

P-60FACD 60 WATT RMS

P.A. Amplifier with FM/AM tuner and CD player

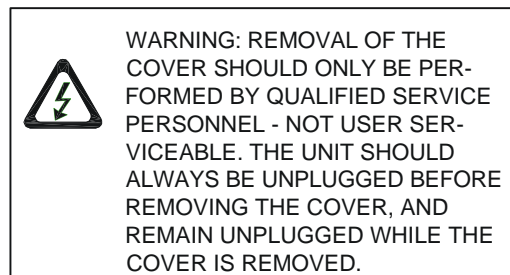
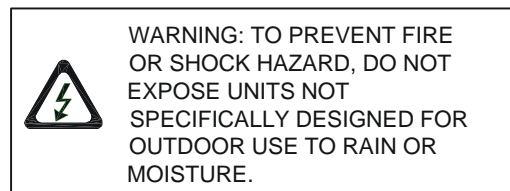
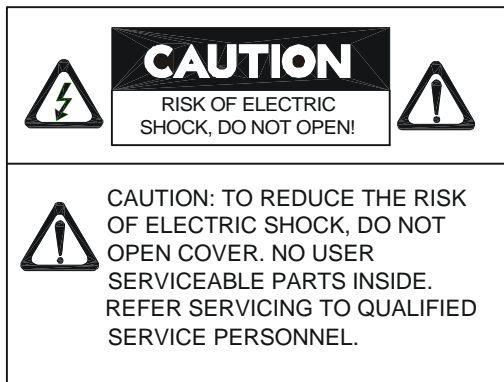

PRECAUTIONS

1. Unpacking

After removing the amplifier from the carton, inspect for any exterior damage to the unit. If damage is noted, notify the carrier at once so that a claim can be justified. Save all packing material. This is important when the claim is processed.

2. Ventilation

To offset heat generated by the unit, it is necessary to provide ample ventilation around the unit. Avoid blocking or impeding the ventilation holes in the unit. To prevent unnecessary problems, install the unit in a place free from any vibrations, direct sunlight, humidity or dust circulation.

3. Avoid spilling liquids or allowing materials to enter the cabinet

If the unit gets wet or any foreign material enters the cabinet, immediately disconnect the A.C. line cord and consult your dealer or qualified technician.

CSI/SPECO

200 NEW HIGHWAY, AMITYVILLE, NY11701
PHONE : 1-800-645-5516, 631-957-8700 IN METRO NY
<http://www.specotech.com>

IMPORTANT SAFETY INSTRUCTIONS

1. Read these instructions.
2. Keep these instructions.
3. Heed all warnings.
4. Follow all instructions.
5. Do not use this apparatus near water.
6. Clean only with dry cloth.
7. Do not block any ventilation openings. Install in accordance with the manufacturer's instructions.
8. Do not install near any heat sources such as radiators, heat registers, stoves, or other apparatus (including amplifiers) that produce heat.
9. Do not defeat the purpose of the polarized or grounding-type plug. A polarized plug has two blades with one wider than the other. A grounding type plug has two blades and a third grounding prong. The wide blade or the third prong are provided for your safety. If the provided plug does not fit into your outlet, consult an electrician for replacement of the obsolete outlet.
10. Protect the power cord from being walked on or pinched particularly at plugs, convenience receptacles, and the point where the exit from the apparatus.
11. Only use the attachments/accessories specified by the manufacturer.
12. Use only with the cart, stand, tripod, bracket, or table specified by the manufacturer, or sold with the apparatus. When a cart is used, use caution when moving the cart/apparatus combination to avoid injury from tip-over.
13. Unplug this apparatus during lightning storms or when unused for long periods of time.
14. Refer all servicing to qualified service personnel. Servicing is required when the apparatus has been damaged in any way such as power supply cord or plug is damaged, liquid has been spilled or objects have fallen into the apparatus, the apparatus has been exposed to rain or moisture, does not operate normally, or has been dropped.
15. Apparatus shall not be exposed to dripping or splashing and no objects filled with liquids, such as vases, shall be placed on the apparatus.
16. Warning – To reduce the risk of fire or electric shock, do not expose this apparatus to rain or moisture.
17. Apparatus shall not be exposed to dripping or splashing and no objects filled with liquids, such as vases, shall be placed on the apparatus.
18. Caution – Use of any controls or adjustments or performance of procedures other than those specified herein may result in hazardous radiation exposure.



Controls and Connections

FRONT PANEL

FACC

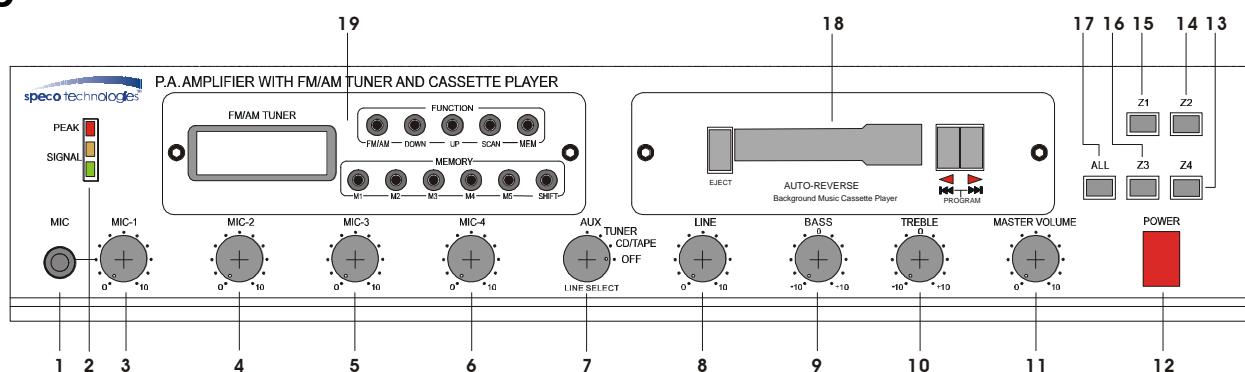

FACD

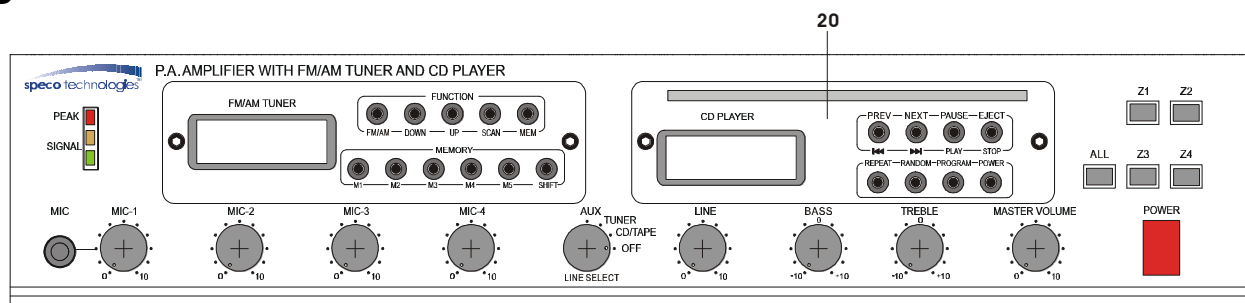

1) MIC-1 input jack (1/4" phone jack)

2) Output level indicator

3) MIC-1 Volume control

4) MIC-2 Volume control

5) MIC-3 Volume control

6) MIC-4 Volume control

7) Line input selector switch

8) Line input volume control

9) Bass control

10) Treble control

11) Master volume control

12) Power on/off switch with LED indicator

13) Zone 4 selector switch

14) Zone 2 selector switch

15) Zone 1 selector switch

16) Zone 3 selector switch

17) All zone selector switch

18) Auto – reverse cassette player unit

19) FM/AM tuner unit

20) CD player unit

REAR PANEL FACC

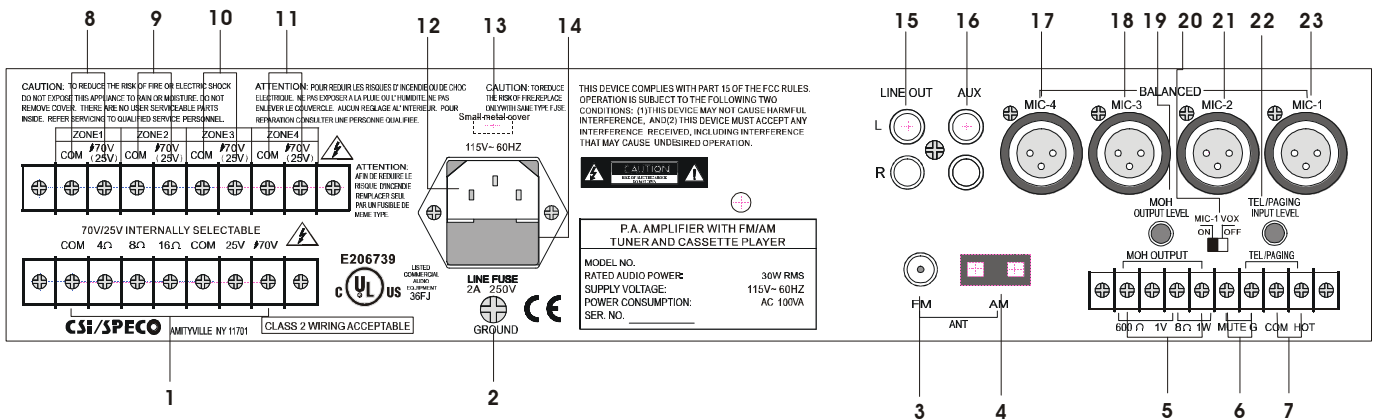

FACD

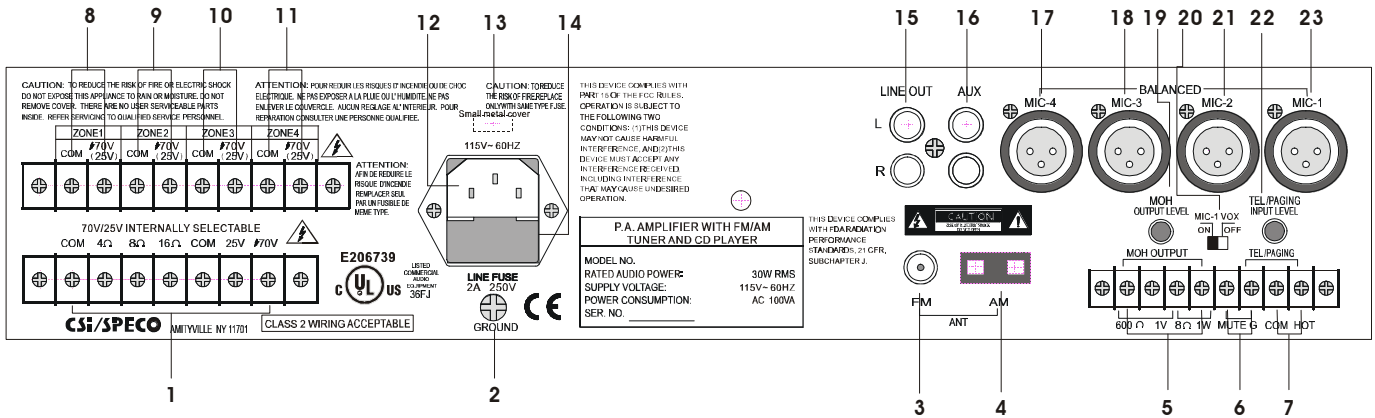

- 1) Speaker outputs
- 2) Ground
- 3) FM antenna input
- 4) AM antenna input
- 5) MOH output terminals*
- 6) Manual muting terminals
- 7) TEL/PAGING input terminals (Balanced)**
- 8) Zone 1 output terminals
- 9) Zone 2 output terminals
- 10) Zone 3 output terminals
- 11) Zone 4 output terminals
- 12) AC input cable receptacle
- 13) AC 115V/230V selector switch BENEATH SMALL METAL COVER(SEE ABOVE).
- 14) AC fuse holder
- 15) LINE output RCA jacks
- 16) AUX input RCA jacks
- 17) MIC-4 (XLR connector) input
- 18) MIC-3 (XLR connector) input
- 19) MOH output level control*
- 20) MIC-1 VOX on/off switch
- 21) MIC-2 (XLR connector) input
- 22) TEL/PAGING input level control**
- 23) MIC-1 (XLR connector) input

*MOH = Music on hold

**TEL/PAGING= Connection input terminals for general or emergency paging.

**TEL/PAGING is not to be connected directly to a telephone circuit or TNV circuit.

FRONT PANEL

- 1) **MIC-1 input jack (1/4" phone jack).** Accepts a balanced low impedance microphone with a standard 1/4" phone plug.
- 2) **Output level indicator.** Indicates power output. Do not overload amp.
- 3) **MIC-1 Volume control.** Adjusts audio level of MIC-1.
- 4) **MIC-2 Volume control.** Adjusts audio level of MIC-2.
- 5) **MIC-3 Volume control.** Adjusts audio level of MIC-3.
- 6) **MIC-4 Volume control.** Adjusts audio level of MIC-4.
- 7) **Line input selector switch.** Allows for selection of high impedance AUX input or music source from tuner, CD player or cassette player.
- 8) **Line input volume control.** Adjusts audio level of line input.
- 9) **Bass control.** Low frequency tone control.
- 10) **Treble control.** High frequency tone control.
- 11) **Master volume control.** Controls all volume levels simultaneously.
- 12) **Power on/off switch with LED indicator.** Illuminates when power is on.
- 13) **Zone 4 selector switch.** Allows for selection the Zone 4 paging with 70V or 25V line output. (internally selected, see page 10)
- 14) **Zone 2 selector switch.** Allows for selection the Zone 2 paging with 70V or 25V line output. (internally selected, see page 10)
- 15) **Zone 1 selector switch.** Allows for selection the Zone 1 paging with 70V or 25V line output. (internally selected, see page 10)
- 16) **Zone 3 selector switch.** Allows for selection the Zone 3 paging with 70V or 25V line output. (internally selected, see page 10)
- 17) **All zone selector switch.** Allows for selection the All zone paging with 70V or 25V line output. (internally selected, see page 10)
- 18) **Auto – reverse cassette player unit.** (see page 7)
- 19) **FM/AM tuner unit.** (see page 8)
- 20) **CD player unit.** (see page 7)

REAR PANEL

- 1) **Speaker outputs.** Speaker lines must be connected to "COM" and one (and only one) of the remaining screw terminals.
- 2) **Ground.** Cabinet enclosure unit ground.
- 3) **FM antenna input.** Connect supplied dipole antenna using supplied 75 matching transformer or coaxial cable to the antenna connector.
- 4) **AM antenna input.** Connect the supplied wire loop antenna to the AM spring loaded terminals.
- 5) **MOH output terminals.** Provided two MOH outputs 600 Ohm, 1 Volt and 8 Ohm, 1 Watt.
- 6) **Manual muting terminals.** Provides manual contact closure muting of the AUX and MIC-2~4 inputs during paging.
- 7) **TEL / PAGING balanced input terminals.** Accepts a balanced telephone paging signal.

- 8 ~ 11) Zone 1~4 output terminals.** In addition to the normal 70V and 25V line outputs, there are four groups of 70V or 25V (internally selected, see page 10) line terminals for 4 zones which can be selected using the push buttons on the front panel.
- 12) AC input cable receptacle .** AC inlet with three pin socket for use of either 115VAC or 230VAC selected by slide switch on rear panel (see page 4). The amplifier is factory set at 115VAC main voltage. (230VAC operation requires AC plug adaptor.)
- 13) AC 115V/230V selector switch (Beneath small metal cover, see drawing of rear panels on page 4).** Allows for selection of either 115VAC or 230VAC operation. For operating on 230VAC main voltage, remove the small metal cover with a screw driver and slide the voltage select switch's actuator from 115VAC(factory set, left side) to 230VAC(right side), then re-mount the small metal cover with the 230VAC sticker showing on back of small metal cover and tighten screws.
- 14) AC fuse holder.** Line fuse for the amplifiers:
- | | | |
|-----------------------|---|-----------------|
| P-30FACC and P-30FACD | - | 2A for 115VAC |
| | - | 1A for 230VAC |
| P-60FACC and P-60FACD | - | 3A for 115VAC |
| | - | 1.6A for 230VAC |
- 15) LINE output RCA jacks.** This booster output supplies the input signal to an additional power amplifier. This signal is after tone control and master volume control. In this fashion, very large systems requiring more power can be accommodated.
- 16) AUX input RCA jacks.** High impedance input available with parallel RCA jacks (for stereo accessories combined for mono.)
- 17) MIC-4 (XLR connector) input.** Accepts a balanced low impedance microphone signal with an XLR connector.
- 18) MIC-3 (XLR connector) input.** Accepts a balanced low impedance microphone signal with an XLR connector.
- 19) MOH output level control.** Controls volume of MOH output. (Music on hold)
- 20) MIC-1 VOX on/off switch.** Allows for disabling of MIC-1 input VOX muting of the MIC-2~4 and AUX input during paging. This allows for multiple MIC paging/operation.
- 21) MIC-2 (XLR connector) input.** Accepts a balanced low impedance microphone signal with an XLR connector.
- 22) TEL/PAGING input level control.** Controls audio level of telephone input.
- 23) MIC-1 (XLR connector) input.** Accepts a balanced low impedance microphone signal with an XLR connector.



Note: Screw terminal designations: G-GND, HOT-Signal positive, COM-Signal negative/common.

CD PLAYER UNIT

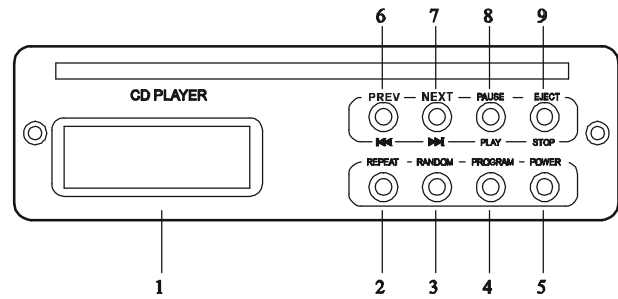
1. CD display
2. Repeat button
3. Random button
4. Program button
5. CD power on/off button
6. Previous track button
7. Next track button
8. Play/pause button
9. Stop/eject button



CD PLAYER OPERATION

1. Select CD mode with LINE selector switch.
2. Press POWER button on CD player.
3. Load disc (label side up) into player and PLAY begins automatically.
4. Press PAUSE button and symbol **II** appears in the display and play is suspended.
Press PAUSE button again to resume play.
5. Pressing **▶▶** button selects the next track and **◀◀** button the previous track.
6. Press the RANDOM button, random appears in the display and tracks are played in random sequence.
7. Press the REPEAT button once and symbol  appears on the display and the current track is repeated. When the button is pressed twice the symbol  appears and indicates repeat play of the disc. To cancel these functions press the REPEAT button again.
8. Programming the CD player – in STOP mode.
 - (a) Press the PROGRAM button
 - (b) Use the next **▶▶** or previous **◀◀** button to select a track.
 - (c) Press REPEAT button to activate memory of the selected tracks in your program. Repeat stages (b) and (c) to continue programming.
 - (d) Press the PLAY button to start the program (Note: The program repeats itself until the CD player is stopped).

CASSETTE PLAYER UNIT

1. Eject switch
2. Cassette slot
3. Direction indicators
4. Fast wind/program buttons

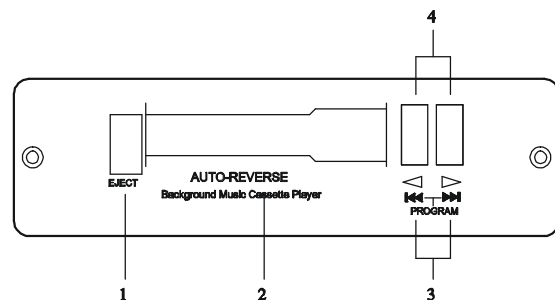

CASSETTE PLAYER OPERATION

The cassette mechanism is an auto-reverse type which detects when the end of the tape has been reached and will automatically reverse the direction of the tape and play the opposite side of the cassette. This function will continue until the cassette is remove from the player.

NOTE: Due to the abrasive nature of cassette tapes some oxide from the tape will be deposited on to the cassette heads and rollers and therefore the mechanism will need cleaning at regular intervals. Cleaning cassettes can be purchased from most good hi-fi stores. DO NOT use C120 (120 minute) cassettes.

INSERTING A CASSETTE

The cassette should be inserted edge first with the exposed tape on the right-hand side, push the cassette into the mechanism until the cassette drops into position.

REMOVING THE CASSETTE

Firmly press the eject button, the cassette will be automatically ejected.

FAST WIND

The cassette can be fast wound in either direction (forward or reverse) to any position on the tape by pressing and holding one of the fast wind buttons and will be stopped automatically after releasing the button.

DIRECTION CHANGE

The side of the cassette currently playing can be reversed to play the other side of the cassette at any time by pressing both fast wind buttons simultaneously.

FM/AM TUNER UNIT

1. Tuner display
2. Memory button
3. Shift button
4. FM/AM selection button
5. Frequency Up / Down button
6. Scan button
7. Set memory button

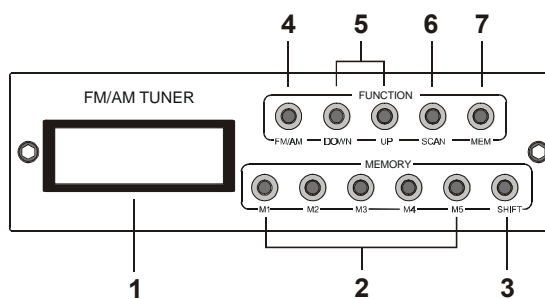

TUNER OPERATION

For FM reception connect the supplied dipole antenna and 75 Ω adaptor or an outdoor antenna using 75 Ω coaxial cable to the connector at the rear of the unit. (see page 4)

For AM reception connect the supplied antenna to the AM spring loaded terminals.

1. Select TUNER mode with the Line selector switch.
2. Select FM or AM.
3. Use the UP/DOWN buttons to set a frequency station manually or the SCAN button to automatically search for the desired station.
4. To program a station press the MEM (Memory) button.
5. Press a MEMORY button (M1 to M5) or SHIFT button and memory button (M6 to M10) to store a frequency.

FEDERAL COMMUNICATIONS COMMISSION INTERFERENCE STATEMENT

This equipment has been tested and found to comply with the limits for a Class B digital device, pursuant to Part 15 of the FCC Rules. These limits are designed to provide reasonable protection against harmful interference when the equipment is operated in a commercial environment. This equipment generates, uses and can radiate radio frequency energy and, if not installed and used in accordance with the instructions manual, may cause harmful interference to radio communications. Operation of this equipment in a residential area is likely to cause harmful interference in which case the user will be required to correct the interference at his own expense.

FCC CAUTION: To assure continued compliance, (example-use only shielded interface cables when connecting to computer or peripheral devices). Any changes or modifications not expressly approved by the party responsible for compliance could void the user's authority to operate this equipment.

OVERCOMING GROUND LOOP PROBLEMS

If the amplifier is mounted in a rack unit (Use rack mount part # PBM-RK2), or is used with equipment having its own ground, it is necessary to ensure that ground loops and the associated problems of hum on the output signal are not introduced by the ground wiring. (see warning)

WARNING

To overcome this problem if it occurs, the electrical and the mechanical ground on the amplifier may be separated by completely removing the wire connecting the power source to ground.

CONSULT AN ELECTRONICS TECHNICIAN TO ACCOMPLISH THIS TO AVOID POTENTIAL PERSONAL INJURY OR A HAZARDOUS CONDITION.

SPEAKER CONNECTION

The rear panel of the amplifier contains a 7 screw terminal strip for connection of speakers. BE CAREFUL TO CONNECT SPEAKERS PROPERLY, see impedance and line voltage instructions below.

The speaker lines are to be connected directly between the appropriate COM terminal on the 7 screw terminal strip and the terminal corresponding to the impedance of the speaker(s) or of the line voltage selected. (70V or 25V)

For 4, 8 and 16 OHM CONNECTIONS (refer to figure 3).

Connect the cables to the terminals on the 7 screw terminal strip provided. Use the screw terminals which correspond to the impedance of the speaker(s). One lead must always be connected to the COM. This is just an example. If in doubt consult a qualified technician.

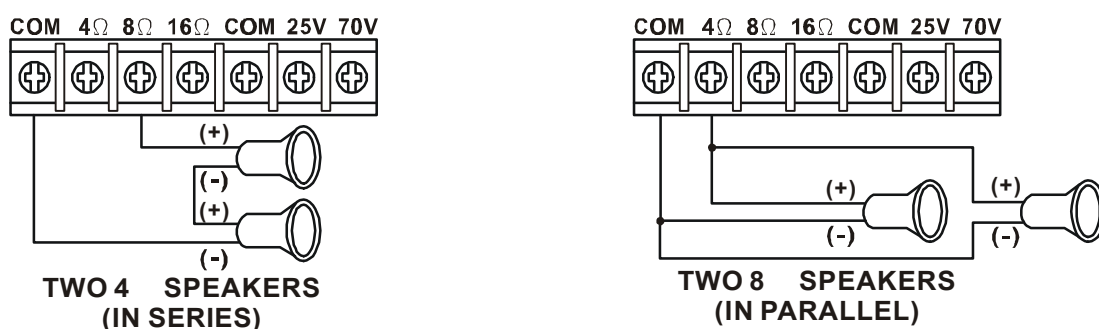
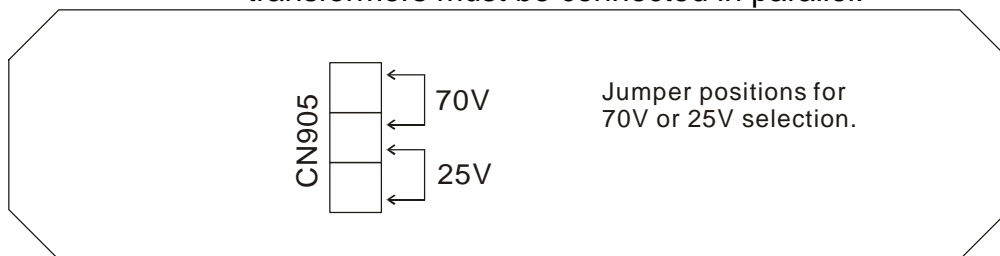

FIGURE 3

For 25V and 70V CONSTANT VOLTAGE LINE CONNECTIONS

(refer to figure 4).

IMPORTANT NOTICE: When the 25V and 70V constant line voltages are used, a line matching transformer must be used with each speaker. All transformers must be connected in parallel.



HOW TO CONNECT LINE MATCHING TRANSFORMERS IN PARALLEL

(25 VOLT LINE OR 70 VOLT LINE)

ALWAYS CONNECT LINE TRANSFORMERS IN PARALLEL

NEVER CONNECT LINE TRANSFORMERS IN SERIES

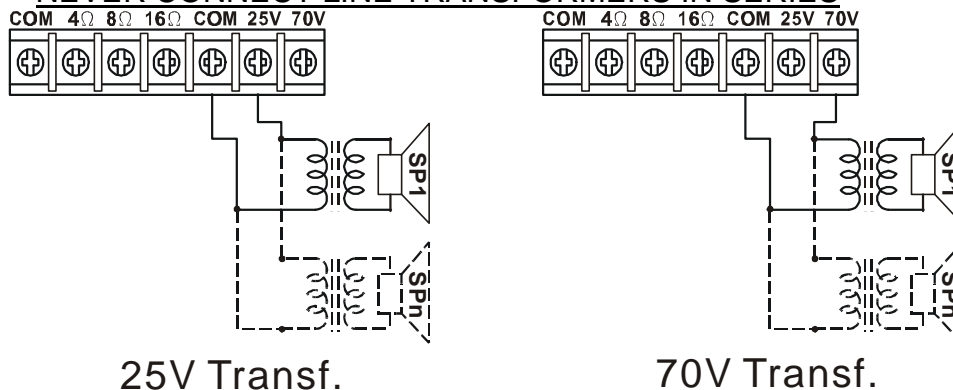

FIGURE 4

SPEAKER IMPEDANCES:

Speaker impedance taps for 4, 8 and 16 Ohm speakers are provided on a terminal strip on the rear panel of the unit. Also, outputs for 25V and 70V constant line voltage are provided. To connect the power output directly to a speaker or PA horn or a combination of speakers and/or PA horns which have a resulting voice coil impedance of 4,8 or 16 Ohm, connect to the COM and the proper impedance tap on the terminal strip. Be sure the speaker(s) or PA horn(s) is capable of handling a reasonable power output from the amplifier or permanent damage to the speaker(s) or PA horn(s) may result. Also, be careful not to overload the amplifier with too many speakers or PA horns. If it is desired to use a number and variety of speakers, the speakers must be arranged in various series or parallel arrays to provide proper impedance matching or the 25V or 70V constant line voltage must be used (parallel connection only). If you are not familiar with impedance matching, consult a professional installer or technician for advice. If the 25V or 70V constant line voltages are used, a line matching transformer must be used with each speaker. Again do not overload or use incompatible speakers. Line transformers are the preferred method for multi-speaker installation.

CABLE REQUIREMENTS

Output cabling need not be shielded in most cases and should be of sufficient gauge to minimize losses due to the resistance of the wire over long runs (insertion loss). Cable thinner than 18 gauge is not recommended. Long runs require 16 gauge or heavier.

In some cases, where the output cable is run in close proximity to unshielded intercom cables, electrical cables, radio transmission antennas or other sources of interference or when the amplifier is being used for paging from a telephone system, the amplifier may require shielded output cabling to prevent audio feedback or interference.

PRIORITY PAGE:THE AMPLIFIER FEATURES A VOICE ACTIVATED PRIORITY PAGE CIRCUIT AND AUTOMATICALLY MUTES ALL PROGRAM MATERIAL (TUNER/TAPE/CD, ETC.) FROM THE AMPLIFIERS OUTPUT AND PERMITS MICROPHONE # 1 AND THE TELEPHONE INPUT TO OVERRIDE FOR PAGING ANNOUNCEMENTS.

TELEPHONE LINE: A TELEPHONE LINE INPUT OF 600 OHMS IS PROVIDED.

THERE ARE MANY OTHER FEATURES OFFERED. PLEASE READ MANUAL COMPLETELY.

WHENEVER IN DOUBT ABOUT INSTALLATION, CONSULT WITH A PROFESSIONAL INSTALLER OR TECHNICIAN OR PERSONAL INJURY, DAMAGE TO THIS AMPLIFIER AND/OR SPEAKERS MAY RESULT AND YOUR WARRANTY MAY BE VOIDED.

PHANTOM POWER JUMPER POSITIONING

These adjustments are to be made by qualified technical personnel – Be certain unit is disconnected from A/C power source prior to removing unit's cover or electrical shock or injury may result. The unit provides a Phantom Power DC 15V for electret condenser microphone use.

Jumper location is to enable (ON) or disable (OFF) Phantom Power feature.

Note: Units come with Phantom Power enable (ON).

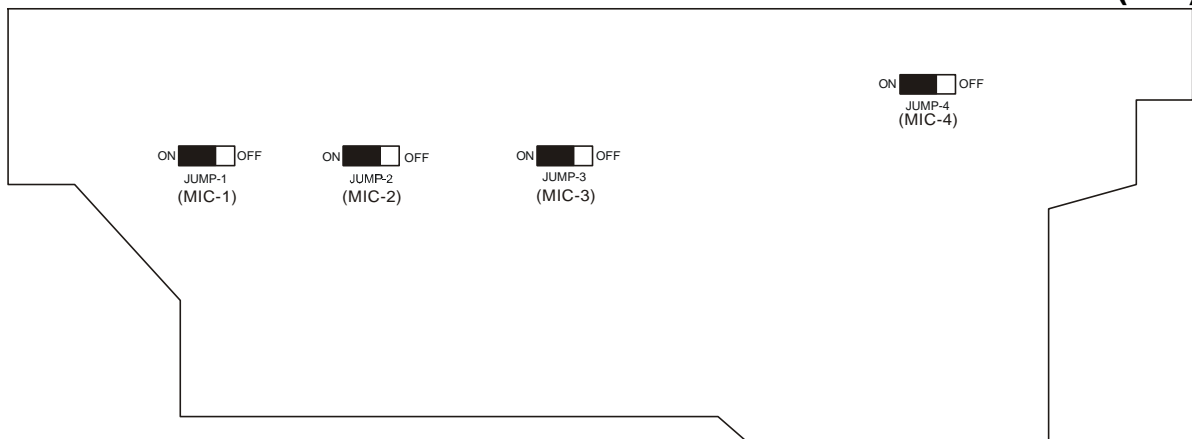



Determining Your Amplifier Needs for Sound Systems

- Step 1: Fill out Wattage Tap Requirement Chart (to right) determining the number of speakers that will be used at each wattage tap for the amplifier.
- Step 2: Multiple the number of speakers by each wattage tap to determine Total Wattage Requirement per Tap setting (See Ex A).
- Step 3: Add all the figures in shaded area to determine the total Wattage Requirement for the amplifier.
- Step 4: Match total Wattage Requirement to the bottom chart "Recommended Amplifier Wattage Chart" to determine acceptable RMS Wattage your amplifier should have.
- Step 5: Repeat this process for each amplifier system required.

Wattage Tap Requirement Chart

	Set Wattage Taps		Number of Speakers at Set Tap	=	Total Wattage Requirement per Tap Setting
Ex A)	5	X	10	=	50
	60	X	_____	=	_____
	30	X	_____	=	_____
	20	X	_____	=	_____
	15	X	_____	=	_____
	10	X	_____	=	_____
	7.5	X	_____	=	_____
	5	X	_____	=	_____
	4	X	_____	=	_____
	3.75	X	_____	=	_____
	2.5	X	_____	=	_____
	2	X	_____	=	_____
	1.50	X	_____	=	_____
	1.25	X	_____	=	_____
	1.00	X	_____	=	_____
	0.50	X	_____	=	_____
	0.25	X	_____	=	_____
	0.125	X	_____	=	_____
Total Sum of Shaded Area Represents Total Wattage Requirement					_____

Recommended Amplifier Wattage Chart

	Acceptable Amplifier RMS Wattage			
	15 Watt	30 Watt	60 Watt	120 Watt
If Sum Wattage Total is 12 Watts or Less	X	X	X	X
If Sum Wattage Total is between 13 and 24 Watts	X*	X	X	X
If Sum Wattage Total is between 25 and 48 Watts	X*	X*	X	X
If Sum Wattage Total is between 49 and 96 Watts	X*	X*	X*	X
If Sum Wattage Total is between 97 and 204 Watts	X*	X*	X*	X*
If Sum Wattage Total is between 205 and 216 Watts		X*	X*	X*
If Sum Wattage Total is between 217 and 240 Watts			X*	X*
If Sum Wattage Total is between 241 and 288 Watts				X*

* RMS Amplifier used in conjunction with Speco Technologies' P-240A Power Booster Amp

For more information contact us at:
 Speco Technologies 200 New Highway, Amityville, NY 11701 Web: www.specotech.com
 Toll Free: 1-800-645-5516 In Metro NY: 631-957-8700 Fax: 631-957-9142 or 631-957-3880

Technical Specifications

Type		PA Amplifier with Music Sources			
Model		P - 30FACC	P - 30FACD	P - 60FACC	P - 60FACD
Supply	Main Voltage	AC 115V/230V ,50/60Hz ± 10% , Switchable			
Output power	Music Max	45W	45W	90W	90W
	RMS Rated	30W	30W	60W	60W
Outputs		Speaker outputs: MOH output : ZONE outputs: 4 ,8 ,16 ,25V,70V 8 1Watt / 600 ,1V balanced. 25V or 70V 4 zones + All Line out:600 ,1V			
Inputs		MIC-1:250 ,1mV,balanced with phantom power selectable (Jump 1) MIC-2:250 ,1mV,balanced with phantom power selectable (Jump 2) MIC-3:250 ,1mV,balanced with phantom power selectable (Jump 3) MIC-4:250 ,1mV,balanced with phantom power selectable (Jump 4) AUX:47K ,200mV,unbalanced. TEL: 0.1~1V,600 ,adjustable, balanced			
Frequency response		60~15K Hz at ± 3dB			
Total harmonic distortion		Less than1% at 1KHz, at rated power			
Signal to noise ratio		All Volume Controls C.C.W : 75dB below rated power. MIC-1~MIC-4 : 60 dB below rated power AUX : 70 dB below rated power TEL : 70 dB below rated power			
Tone Controls		Bass : ± 10 dB at 100Hz Treble: ± 10 dB at 10KHz			
Controls		MIC-1~MIC-4 volume controls Line(AUX/Tuner/CD/Cassette) volume control Master volume control TEL input level control MIC-1 VOX on/off switch MOH output level control Tone controls (Bass, Treble) Zone1, Zone 2, Zone 3, Zone 4 and All zone AC 115V / 230V Voltage Selector Switch.			
Indicators		Output level meter (3 LEDES)			
AC power consumption		100 VA	100 VA	170 VA	170 VA
Priority (VOX)		Priority level (Using for MIC-1, the XLR connector or phone jack) TEL / Emer MIC-1 MIC-2 MIC-3 MIC-4 AUX / Tuner/ CD-Tape 3 2 1 1 1 1			
Dimensions (H x W x D)		3.5"(H) x 16.9"(W) x 11.8"(D)			
Weight		Approx : 15.4 lbs	Approx :15.4 lbs	Approx : 18.7 lbs	Approx : 18.7 lbs
Color		Black			
Mounting options		Table top or, 19" rack mountable(Use # PBM-RK2 rack mount bracket)			
Music Source		TM-2 : FM / AM Digital Tuner Unit CP-2 : Auto-reverse cassette player unit	TM-2 : FM / AM Digital Tuner Unit CD-2 : CD player unit	TM-2 : FM / AM Digital Tuner Unit CP-2 : Auto-reverse cassette player unit	TM-2 : FM / AM Digital Tuner Unit CD-2 : CD player unit

See page 11

CD-2 CD Player Unit

Type	CD Player Unit
Model	CD-2
Distortion	< 0.1 %
S / N	>80 dB
Output	850 mV
Functions	Eject/stop, Pause/play, Next, Previous, Power, Program, Random, Repeat.

CP-2 Auto-Reverse Cassette Player Unit

Type	Auto-Reverse Cassette Player Unit
Model	CP-2
WOW / Flutter	0.45 %
Tape Speed	2940 ~ 3090 Hz
Frequency response	125Hz ~ 6.3KHz ± 4dB
S / N	40 dB
Distortion	3 %
Output	500 mV (0~1V adjustable)
Functions	Eject, Auto-reverse, Program

TM-2 FM/AM Digital Tuner Unit with 20 Programmable Presets

Type	FM / AM Digital Tuner Unit
Model	TM-2
Tuning range	FM: 87.5~108 MHz AM: 522~1620 KHz
Sensitivity	FM: 2i V (26 dB S / N) AM: 30i V (20 dB S / N)
Frequency response	30Hz ~ 15 KHz (+1 / -3 dB)
Distortion	< 1 %
S / N	>63 dB (1 mV, FM)
Output	500 mV (0~1V adjustable)
Functions	FM/AM, Down, Up, Scan, Mem M1, M2, M3, M4, M5, Shift

PS12RM	C501	F501	D501	D502
P-60FA	6800/50V	3SF8A	KBPC1502	6A04
P-30FA	4700/50V	3SF5A	KBPC1002	6A04

FUSE1	PT	OT
P-60FA	PT-060RM	OT-060BM
P-30FA	PT-030RM	OT-030M

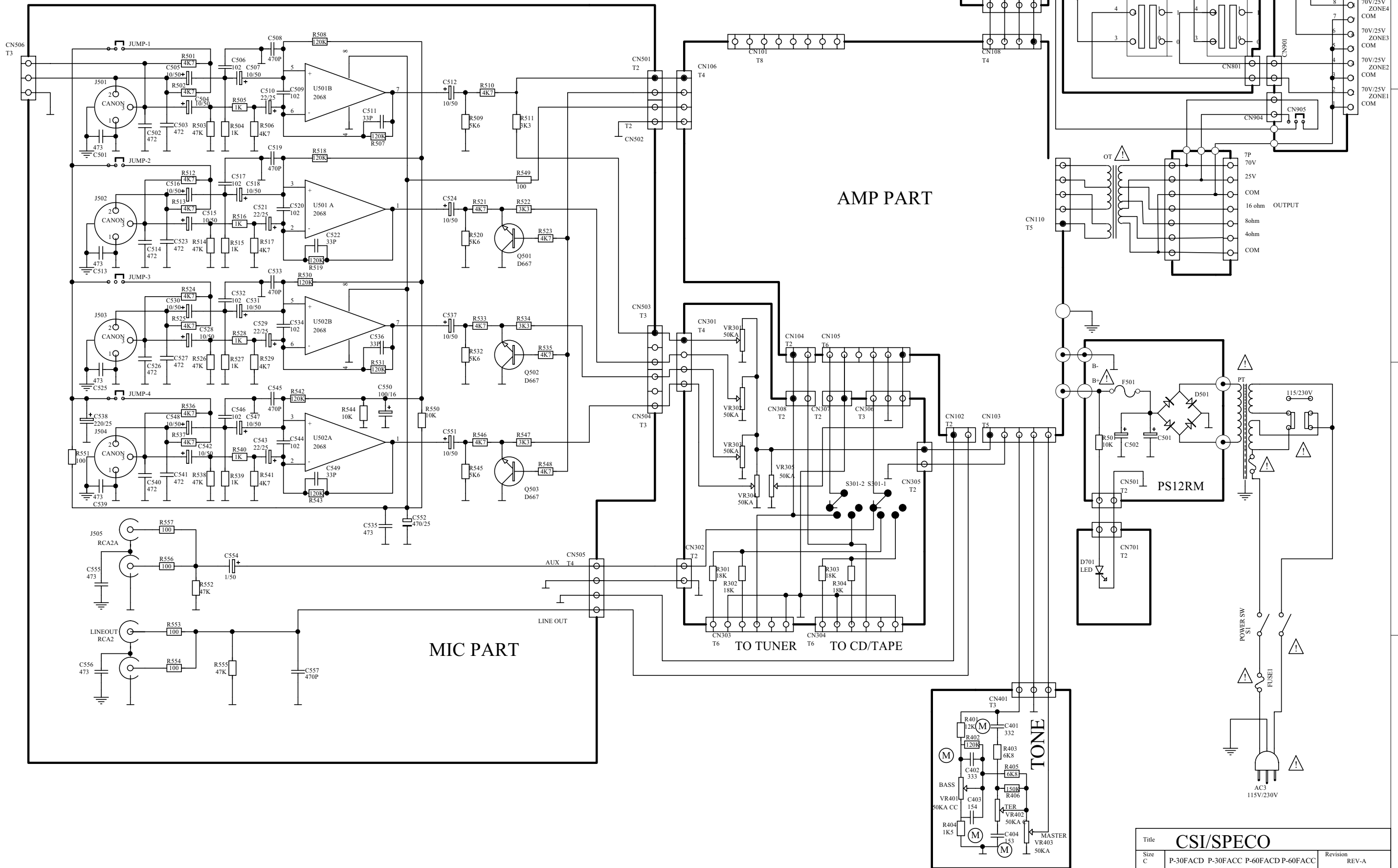

Title	CSI/SPECO		Revision	REV-A
Size	P-30FACD P-30FACC P-60FACD P-60FACC		Sheet	1 of 2
Date:			Drawn By:	LB
File:	P-30FA-1			

	Q112	Q111	Q121	Q124	Q122	Q125	R148	R149	R189
P-60FA	×	×	×	×	C4278	C4278	×	×	×
P-30FA	×	×	×	×	D896	D896	×	×	×
	R190	R192	R198	R197	R199	C135	TH101	CN109	SW-10
P-60FA	×	×	×	×	×	×	×	×	JUMPER
P-30FA	×	×	×	×	×	×	×	×	JUMPER

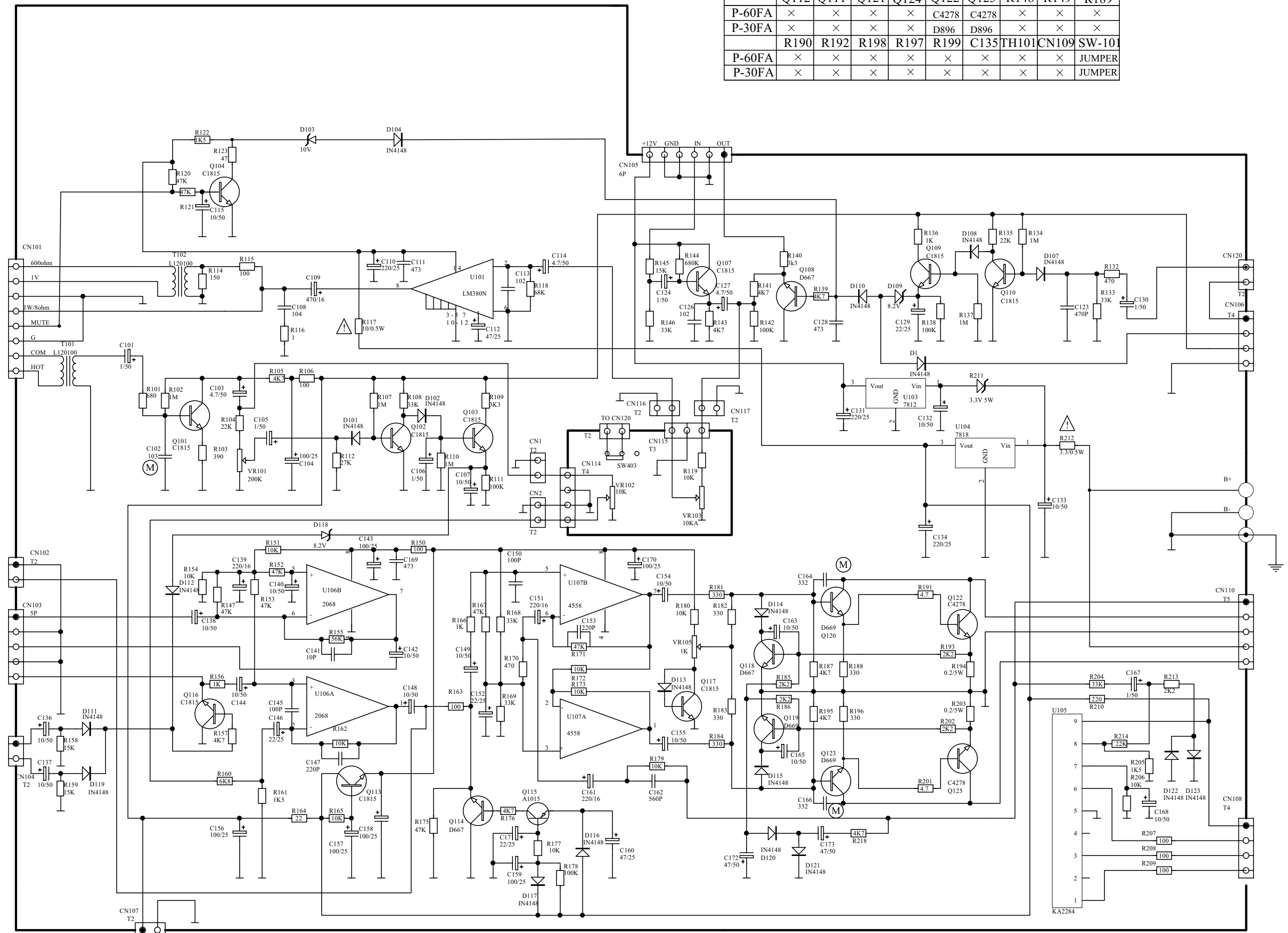

Title		CSI/SPECO	
Size	C	P-30FACD P-30FACC P-60FACD P-60FACC	Revision REV-A
Date:		Sheet 2 of 2	Drawn By: LB
File:	P-30FA-2		

Free Manuals Download Website

<http://myh66.com>

<http://usermanuals.us>

<http://www.somanuals.com>

<http://www.4manuals.cc>

<http://www.manual-lib.com>

<http://www.404manual.com>

<http://www.luxmanual.com>

<http://aubethermostatmanual.com>

Golf course search by state

<http://golfingnear.com>

Email search by domain

<http://emailbydomain.com>

Auto manuals search

<http://auto.somanuals.com>

TV manuals search

<http://tv.somanuals.com>