



DIGITAL CAMERA



OWNER'S MANUAL

KT7002

1. WELCOME TO THE WORLD OF HELLO KITTY

We have taken great care to make sure that this unit was in perfect working order when it left factory. It has been designed to give you many years of enjoyment and trouble free operation. Read this manual before operating this unit to become familiar with its features and obtain the performance that will bring you continued enjoyment for many years.

You can use your Hello Kitty Digital Camera to capture not only snaps of your family and friends, but also video clips of them in action! Upload the images and video clips to your computer (running Windows® 98, ME, 2000 or XP) via the USB (Universal Serial Bus) port.

Please note that your images and videos are stored in your Hello Kitty Digital Camera's internal memory. After you have taken your images and videos, the Hello Kitty Digital Camera will wait for 30 seconds and then automatically switch off. A constant trickle of power from the battery keeps the images and video stored in memory. When the Battery Indicator on LCD Display blanks, at this time all stored images and videos must be uploaded to your computer and saved, otherwise they will be lost.

For future reference, record the serial number in the space provided.

Model Number: KT7002

Serial Number: _____

2. TABLE OF CONTENTS

1.	WELCOME TO THE WORLD OF HELLO KITTY	- 1 -
2.	TABLE OF CONTENTS	- 2 -
3.	SYSTEM REQUIREMENTS	- 3 -
4.	PACKAGE CONTENTS	- 3 -
5.	SOFTWARE INSTALLATION	- 3 -
	HELLO KITTY DIGITAL CAMERA DRIVER, MyDsc2 and PCCAM	- 3 -
	HELLO KITTY STUDIO	- 4 -
6.	POWER SOURCES.....	- 4 -
	BATTERIES INSTALLATION	- 4 -
	BATTERY GUIDANCE.....	- 4 -
7.	FUNCTIONS AND CONTROLS	- 5 -
	HELLO KITTY DIGITAL CAMERA.....	- 5 -
	LCD DISPLAY.....	- 5 -
8.	GETTING STARTED	- 5 -
	GENERAL OPERATION	- 5 -
	TAKING IMAGES	- 6 -
	TAKING VIDEOS	- 6 -
	FUNCTIONAL OPERATION	- 7 -
9.	CONNECTING THE CAMERA TO YOUR COMPUTER	- 8 -
10.	UPLOADING IMAGES/VIDEOS TO YOUR COMPUTER.....	- 8 -
	RUNNING MyDsc2 FOR UPLOADING IMAGES/VIDEOS.....	- 8 -
	RUNNING PCCAM FOR CREATING LIVE VIDEO CLIPS	- 9 -
11.	HELLO KITTY STUDIO (FOR WINDOWS® USER ONLY)	- 10 -
	PHOTO LIBRARY	- 10 -
	EDIT CENTER	- 10 -
	PRINT CENTER	- 10 -
	SLIDE SHOW	- 10 -
	STORY MAKER.....	- 10 -
	GAME CENTER	- 11 -
12.	CARE AND MAINTENANCE	- 11 -
13.	COMPLIANCE WITH FCC REGULATIONS.....	- 11 -
14.	TROUBLESHOOTING GUIDE.....	- 12 -
15.	TECHNICAL SPECIFICATION	- 13 -
16.	SERVICE.....	- 13 -

3. SYSTEM REQUIREMENTS

For Windows® Users

- Compatible with Microsoft® Windows® 98, ME, 2000 or XP
- Intel® Pentium® III 800MHz or higher
- 128MB RAM or higher
- USB 1.1 Port
- 80MB Hard disk space free
- CD-ROM drive
- Color monitor with high color (16-bit) graphic capability or higher
- Standard mouse and keyboard

4. PACKAGE CONTENTS

- Hello Kitty Digital Camera
- Hello Kitty Studio CD-ROM
(Includes Hello Kitty Camera Driver, MyDsc2, PCCam and Hello Kitty Studio)
- Hello Kitty Neck Strap
- Owners Manual
- USB Cable
- Warranty Card

5. SOFTWARE INSTALLATION

For Windows® Users

Hello Kitty Digital Camera Driver, MyDsc2 and PCCam

- **MyDsc2**

MyDsc2 provides an easy-to-use interface for uploading images and videos from the Hello Kitty Digital Camera to your computer.

- **PCCam**

PCCam is a powerful video capture program, which provides you a full-featured platform to create your own digital video!

- **How to Install Hello Kitty Digital Camera Driver, MyDsc2 and PCCam**

1. Insert the CD-ROM disc into the CD-ROM drive and close the CD-ROM drawer.
2. Installation wizard will automatically launch.
3. Click the "Install Hello Kitty Camera Driver" icon.
4. Follow the instructions presented on the screen to complete the installation.
5. Click "Yes, I want to restart my computer now" and "Finish" to restart your computer and wait for your PC to restart automatically.

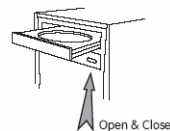

Note:

If the setup screen doesn't appear after loading the CD, then you can manually start it by double-clicking the "My Computer" icon on your desktop, then double-clicking the icon for the CD-ROM drive. When the CD-ROM window opens, double-clicks the "launcher.exe" file.



- **Uninstalling your Hello Kitty Digital Camera Driver, MyDsc2 and PCCam**

To uninstall Hello Kitty Digital Camera Driver, MyDsc2 and PCCam, click the "Start Menu" on your Windows desktop, choose "MyDsc2" folder under Program and choose "Uninstall". Follow the onscreen instructions.

For Windows® Users

Hello Kitty Studio

● Hello Kitty Studio

Hello Kitty Studio is designed for your complete Hello Kitty experience, you can print, email and share your Hello Kitty digital creations!

● How to Install Hello Kitty Studio

1. Insert the CD-ROM disc into the CD-ROM drive and close the CD-ROM drawer.
2. Installation wizard will automatically launch.
3. Click the "Install Hello Kitty Studio Photo Fun and Games" icon.
4. Follow the instructions presented on the screen to complete the installation.
5. Click "OK" to complete the installation wizard.



● Uninstalling your Hello Kitty Studio

1. Re-insert the CD-ROM disc into the CD-ROM drive and close the CD-ROM drawer.
2. Installation wizard will automatically launch.
3. Click the "Uninstall Hello Kitty Studio Photo Fun and Games" icon.
4. Follow the instructions presented on the screen to uninstall the Hello Kitty Studio.
5. Click "OK" to complete the uninstalling wizard.

6. POWER SOURCES

Batteries Installation

1. Press in and slide out the battery compartment door.
2. Following the polarity diagram inside the battery compartment, install 2 "AAA" size (UM-4) batteries.

IMPORTANT: Be sure that the batteries are installed correctly. Wrong polarity may damage the unit.

3. Push down and slide closed the battery compartment door

Note:

To avoid losing images when changing the batteries, please make sure all your images and videos have been uploaded to your PC before changing the batteries. You can also replace the batteries when the camera is plugged into your PC via the USB cable. The computer must be turned on if you choose to replace the batteries using this option.

Battery Guidance

WARNINGS!

- Batteries should only be replaced by an adult.
- Alkaline, standard (carbon-zinc) and other non-rechargeable batteries must not be recharged.
- Rechargeable batteries must be removed from the camera before being charged.
- Rechargeable batteries must only be charged under adult supervision.
- Never mix alkaline, standard (carbon-zinc) or rechargeable batteries.
- Only use batteries recommended by the manufacturer.
- Batteries must be inserted with the correct polarity.
- Exhausted batteries are to be removed from the camera.
- The supply terminals must not be short-circuited.
- Do not dispose of the batteries in fire. Batteries may explode or leak.
- Batteries should be removed from the camera when not in use.

These instructions should be retained for future reference.

7. FUNCTIONS AND CONTROLS

Hello Kitty Digital Camera

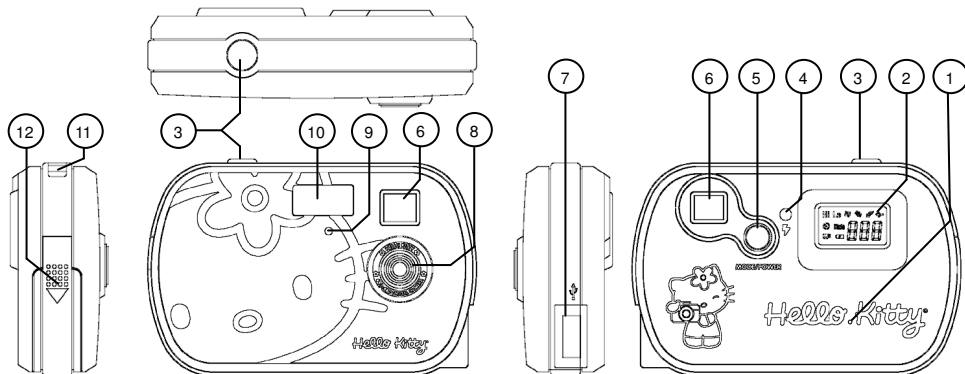

- | | | | |
|----|-------------------|-----|---------------------|
| 1. | Buzzer | 7. | USB Cable Port |
| 2. | LCD Display | 8. | Lens |
| 3. | Shutter Button | 9. | Shutter Indicator |
| 4. | Flash Indicator | 10. | Flash |
| 5. | Mode/Power Button | 11. | Neck Strap Holder |
| 6. | Viewfinder | 12. | Battery Compartment |

LCD Display

- | | | |
|-----|-------------------|------|
| 2a. | High Resolution | Hi |
| 2b. | Low Resolution | Lo |
| 2c. | Delete Last | |
| 2d. | Delete All | |
| 2e. | Continuous Shot | |
| 2f. | USB Connection | |
| 2g. | Self-Timer | |
| 2h. | Video Capture | |
| 2i. | Battery Indicator | |
| 2j. | Mode Operation | Mode |
| 2k. | 3-Digit Icon | 888 |

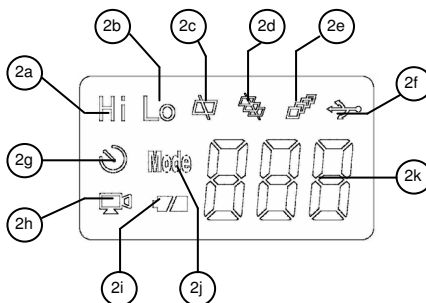

8. GETTING STARTED

General Operation

● Power On

Press **Mode/Power** button (#5) to power on the camera.

LCD display (#2) will show **Hi** (#2a) and (#2i), the 3-Digit Icon (#2k) will show the total number of images currently stored.

● Power Off

In Normal Shot Mode, press **Mode/Power** button (#5) 1 time to choose Power Off Mode. The 3-Digit Icon (#2k) will show **off**. Press the **Shutter** button (#3) again to turn off the camera.

The camera will automatically turn off after 30 seconds of inactivity.

Note:

When the camera is OFF the LCD Display (#2) will be blank, but a constant trickle of power from the battery will keep images and video stored in memory.

● Mode Selection

Every time the **Mode/Power** button (#5) is pressed, the corresponding mode appears in the LCD display (#2), in the following sequence:

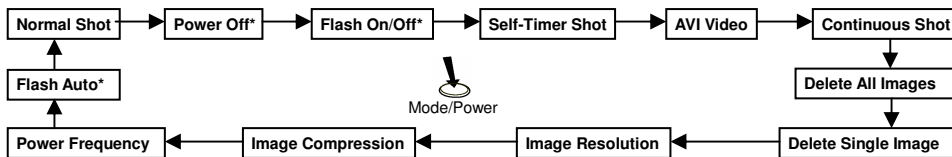

*Note:

Power Off, Flash On/Off and Flash Auto Modes are disabled when using the USB cable.

Taking Images

● Normal Shot Mode

The camera will be in Normal Shot Mode when first turned ON. It will also return to Normal Shot Mode after inactivity for 5 seconds.

Frame your subject using the viewfinder (#6).

Press the **Shutter** button (#3) to take a picture. The buzzer (#1) will beep and Shutter Indicator (#9) will blink. One beep sound indicates that the image was taken successfully and the 3-Digit Icon (#2k) will count up by one.

Note:

Two beep sounds indicates the camera was unable to take a picture and the Shutter Indicator (#9) will not blink. There may be insufficient light to take the image or the camera memory is full.

When the camera memory is full, the 3-Digit Icon (#2k) will display **FL** and flash for 3 seconds.

● Self-Timer Shot Mode

In Normal Shot Mode, press **Mode/Power** button (#5) 3 times to choose Self-Timer Shot Mode. The LCD display (#2) will show  (#2g). The self-timer will delay for 10 seconds.

Frame your subject using the viewfinder (#6).

Press **Shutter** button (#3) to take a picture. The buzzer (#1) and Shutter Indicator (#9) will beep and flash repeatedly for 10 seconds during the count down. A long-beep tone after the last beep indicates the image was taken successfully.

● Continuous Shot Mode

In Normal Shot Mode, press **Mode/Power** button (#5) 5 times to choose Continuous Shot Mode. The LCD display (#2) will show  (#2e). The camera will take 3 consecutive pictures at a time when the **Shutter** button (#3) is pressed.

Frame your subject using the viewfinder (#6).

Press the **Shutter** button (#3) to take a picture. The buzzer (#1) and Shutter Indicator (#9) will beep and blink repeatedly 3 times. Each time indicates a successful picture has been taken.

Taking Videos

● AVI Video Mode

In Normal Shot Mode, press **Mode/Power** button (#5) 4 times to choose AVI Video Mode. LCD display (#2) will show  (#2h).

Frame your subject using the viewfinder (#6).

Press and hold the **Shutter** button (#3) to capture videos. The buzzer (#1) will continuously sound until the shutter button (#3) is released, or the camera memory is full. In both cases the camera will stop capturing video. The 3-Digit Icon (#2k) will count up by one when complete.

Functional Operation

● Deleting a Single Image

In Normal Shot Mode, press **Mode/Power** button (#5) 7 times to choose Delete Single Image Mode. LCD Display (#2) will show  (#2c).



Press **Shutter** button (#3) to delete the last image, the 3-Digit Icon (#2k) will count down by one when the process is completed.



● Deleting All Images

In Normal Shot Mode, press **Mode/Power** button (#5) 6 times to choose Delete All Images Mode. LCD Display (#2) will show  (#2d).

Press the **Shutter** button (#3) once, the 3-Digit Icon (#2k) will flash for 5 seconds. Press the **Shutter** button (#3) again within the 5 seconds to delete all the stored images in memory. The 3-Digit Icon (#2k) will show .

● Image Resolution



There are 2 selectable image resolutions available: High () or Low ()

In Normal Shot Mode, press **Mode/Power** button (#5) 8 times to choose Image Resolution Mode. LCD Display (#2) will show  (#2j), and either  (#2a) or  (#2b) will flash to indicate the current image resolution.

Press **Shutter** button (#3) again to select another resolution setting.

● Image Compression

There are 2 selectable image compression methods: Compressed () or Non-Compressed ()

In Normal Shot Mode, press **Mode/Power** button (#5) 9 times to choose the desired Image Compression Mode. The LCD Display (#2) will show  (#2j), the 3-Digit Icon (#2k) will show either  or , which indicates the current image compression method.

Press the **Shutter** button (#3) again to select another image compression method.



● Power Frequency

There are 2 power frequencies selectable: 50 or 60.

In Normal Shot Mode, press **Mode/Power** button (#5) 10 times to choose Power Frequency Mode. LCD Display (#2) will show  (#2j), the 3-Digit Icon (#2k) will show either 50 or 60, which indicates the current power frequency setting.

Press the **Shutter** button (#3) again to select a different power frequency setting.

● Flash On/Off

In Normal Shot Mode, press **Mode/Power** button (#5) 2 times to choose Flash On/Off Mode. The 3-Digit Icon (#2k) will show either  (Flash OFF) or  (Flash ON), which indicates the current Flash setting.

Press the **Shutter** button (#3) again to select another setting.



Note:

Flash (#10) will be turned OFF each time the camera is powered on. Turn it on manually whenever necessary.

Please wait for the Flash Indicator (#4) to light before taking any photos requiring a Flash.

When the battery power becomes too low to charge the flash, the camera will automatically turn the Flash (#10) OFF.

● Flash Auto

In Normal Shot Mode, press **Mode/Power** button (#5) 11 times to choose Flash Auto Mode. The LCD Display (#2) will show  (#2j), the 3-Digit Icon (#2k) will show either  (Flash forced on) or  (Flash auto), which indicates the current setting.

In Flash Forced On Mode, the Flash (#10) will flash every time pictures are taken. In Flash Auto Mode the flash will only be on if the camera senses more light is needed in order to take the photo.

Press the **Shutter** button (#3) again to select another setting.

Note:

The Flash Indicator (#4) must be lit prior to taking photos in either setting for the Flash to work properly.

9. CONNECTING THE CAMERA TO YOUR COMPUTER

The USB cable allows you to upload images and videos from your Hello Kitty Digital Camera to your computer. One end of the cable connects to the USB port (#7) on the side of the Hello Kitty Digital Camera, while other end connects to your computer's USB port. When the Hello Kitty Digital Camera is connected to your computer, it will draw power from the USB cable and preserve the cameras battery life.

The USB port can be found on the front or back panel of your computer. Look for this symbol  next to the connection port. (Also see your computers operating manual for the location of your USB connection port.)

10. UPLOADING IMAGES/VIDEOS TO YOUR COMPUTER

For Windows® Users

Running MyDsc2 for Uploading Images/Videos



1. Connect your Hello Kitty Digital Camera to your computer via the USB Cable.
2. Run the MyDsc2 application.
Select the MyDsc2 icon from the MyDsc2 program group on Windows Start Menu or double-click the MyDsc2 shortcut icon inside the MyDsc2 folder on the Desktop.

● To Upload Images/Videos

To upload images/videos to your computer, click the "Upload Photos" Icon .

Note: When uploading images/videos, the LCD display will show  (#2f)

● To View Images/Videos

The MyDsc2 application shows 12 images/videos on each page, click  or  to view other pages. Right-click on an image to preview.

● To Edit Images

To edit an image, click the "Edit Image" Icon .

● To Save Images/Videos

Select the images/videos by left-clicking the images/videos you wanted, or by clicking the "Select All Photos in This Page" Icon  to select all images on the current page.

Click the "Save Photos" Icon  to save your selected images.

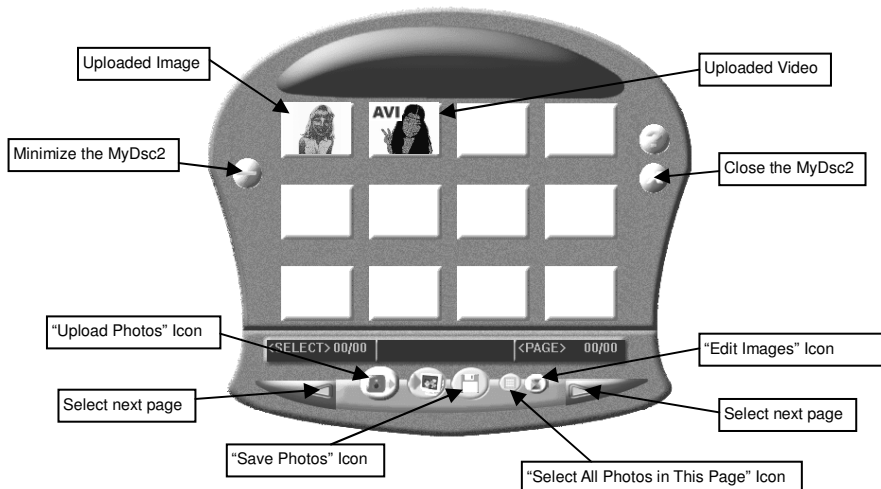

For Windows® Users

Running PCCam for Creating Live Video Clips

1. Connect your Hello Kitty Digital Camera to your computer via the USB Cable.
2. Run the PCCam application.
Select the PCCam icon from the MyDsc2 program group on Windows Start Menu or double-click the PCCam shortcut icon inside the MyDsc2 folder on the Desktop.

- **To Preview a Scene**

To preview your scene, click “Preview” under the “Options” Title Bar.

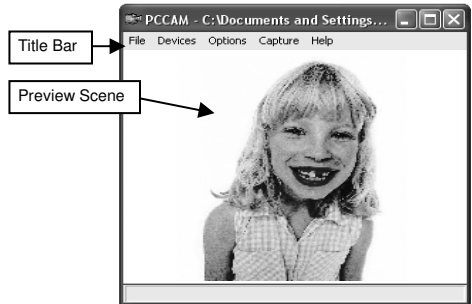

- **To Adjust Resolution**

There are 3 selectable resolutions: 160x120, 320x240 and 640x480

To adjust resolution, click the “Video Capture Pin” under the “Options” Title Bar.

- **To Adjust Frame Rate**

To adjust frame rate (number of frame per second) and time limit (time to capture your video clip) of your live video clip, click “Set Frame Rate” and “Set Time Limit” under “Capture” Title Bar.

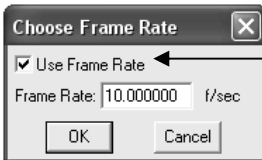

Click “Use Frame Rate” to apply preset frame rate.
For example:
Set 10fps to capture 10 frames of video at every second.

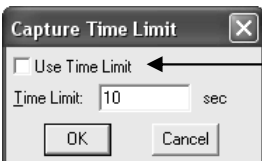

Click “Use Time Limit” to apply preset time limit.
For example:
Set 10s to capture 10 seconds of video.

Note:

The camera supports a maximum of 10fps at 640x480 resolution and 20fps for 320x240 and 160x120 resolutions.

- **Miscellaneous Settings**

To set a default path and filename of your video clip, click “Set Capture File” under the “File” Title Bar.
e.g. To set default path and filename as C:\Documents and Settings\User\Desktop\MyVideo.avi

To adjust the video imaging properties, click “Video Capture Filter” under “Options” Title Bar.

- **To Capture Live Video**

To start capturing, click “Start Capture” under the “Capture” Title Bar, then click “OK” for the pop-up messenger.

To stop the video capture, click “Stop Capture” under the “Capture” Title Bar.

11. HELLO KITTY STUDIO (FOR WINDOWS® USER ONLY)

Photo Library

Use the photo library to manage your photos. Use the import buttons to select and import photos into the Hello Kitty Studio program.

When photos are imported, they are organized by category. The categories correspond to the name of the folder where the original photo resides.

Once photos are imported, you can select one or more photos for editing or printing.



Edit Center

Use any of the 18 editing tools to modify your photo. Then save your edited photo for future use in the Hello Kitty Studio.

Note:

Your original photo will not be altered when you use the edit center.

Print Center

Select one or more photos from the Photo Library, then go to the print center to print or export them.

Hello Kitty Studio offers several printing formats and print options including layouts, image names and photo frames.

Use the export option in the print center to save a copy of the photo to your computer in .jpg or .pdf format. Choose the reduced option to create a smaller file that works better with e-mail.

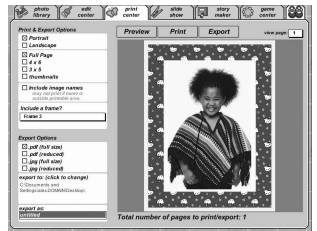

Slide Show

Select a category of Hello Kitty Studio photos for a slide show. Page through the photos one by one, or select the auto-play option to display the photos automatically.

Story Maker

Create a story using your Hello Kitty Studio photos. Then save your story or export it to your computer as a .jpg or .pdf file. Choose from 5 colorful Hello Kitty templates.



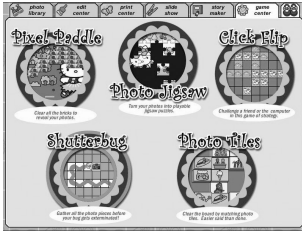

Game Center

Play 5 great games that use your photos in the game!
 Choose from Pixel Paddle, Photo Jigsaw, Click Flip, Shutter Bug or Photo Tiles.

12. CARE AND MAINTENANCE

Your Hello Kitty Digital Camera should only be operated within the following environmental conditions:

- 41 – 104° Fahrenheit; 5 – 40° Celsius.
- 20% - 85% relative humidity, non-condensing.

Battery life or image quality may be affected outside these conditions.

Camera Cautions:

- Never immerse any part of the camera or its components into any fluid or liquid.
- Disconnect the camera from your computer before cleaning it.
- Remove dust or stains with a soft cloth dampened with water or neutral detergent.
- Do not place hot items on the surface of the camera.
- Do not attempt to open or disassemble the camera. This will affect any warranty claim.

13. COMPLIANCE WITH FCC REGULATIONS

This device complies with Part 15 of FCC Rules. Operation is subject to the following two conditions: (1) This device may not cause harmful interference, and (2) This device must accept any interference received, including interference that may cause undesired operation. Warning: Changes or modifications to this unit not expressly approved by the party responsible for compliance could void the user's authority to operate the equipment.

NOTE: This equipment has been tested and found to comply with the limits for Class B digital device, pursuant to Part 15 of the FCC Rules. These limits are designed to provide reasonable protection against harmful interference in a residential installation. This equipment generates, uses and can radiate radio frequency energy and, if not installed and used in accordance with the instructions, may cause harmful interference to radio communications.

However, there is no guarantee that interference will not occur in a particular installation. If this equipment does cause harmful interference to radio or television reception, which can be determined by turning the equipment off and on, the user is encouraged to try to correct the interference by one or more of the following measures:

- Reorient or relocate the receiving antenna.
- Increase the separation between the equipment and receiver.
- Connect the equipment into an outlet on a circuit different from that to which the receiver is needed.
- Consult the dealer or an experienced radio/TV technician for help.

Shielded cable must be used with this unit to ensure compliance with the Class B FCC limits.

Under the environment with electrostatic discharge, the product may malfunction and require user to reset the product.

14. TROUBLESHOOTING GUIDE

The troubleshooting guide is designed to help you. If problems continue, please contact your local customer support hot-line. See your registration card for hotline contact details.

For Windows® Users

Symptom	Problem	Solution
I receive an error message when I am installing the Hello Kitty Digital Camera Driver.	Hello Kitty Digital Camera Driver does not load.	Shut down all other applications and attempt to re-install the driver, or download the updated driver from www.spectraintl.com/xsp/KT7002updates.html and install the updated driver.
		Check the USB controller in your BIOS if they are activated. If these do not work contact your national Customer Support representative.
MyDsc2 folder is not found in the Programs menu after I have installed the driver.	The installer for the Hello Kitty Digital Camera Driver requires the Hello Kitty Digital Camera be connected to the PC (via the USB) after the software has been installed & the PC restarted.	Install the software, restart your PC, and then connect the Hello Kitty Digital Camera to the PC via the USB port, the software folder will appear in the Program menu.
All the images I have taken do not appear on the Hello Kitty Digital Camera.	You have lost power to your Hello Kitty Digital Camera by either:	
	Insufficient battery power	Upload all images to your PC as soon as possible. (Please refer to Battery Guidance section in User's Manual.)
	Removing the battery without being connected to your PC (turned on) via the USB cable.	If you need to change batteries and save the images in your camera's memory, you need to be connected to a PC via the USB cable, and make sure the PC is ON. The camera will now be powered by the USB cable while you insert fresh batteries.
I cannot upload images to the PC	Connection failure	Check that all cable connections are secured and that both plugs are fully inserted.
I pressed shutter button but no response after I turned on the flash.	The Hello Kitty Digital Camera is charging the flash unit and/or processing the image.	Wait for the Flash Indicator to turn on and then take another picture.
The Battery Indicator is flashing.	This means there is insufficient power.	You need to change the batteries.
I cannot run the MyDsc2 Application.	Conflict with another camera driver capture device.	If you have any other camera installed on your computer, remove the camera and its driver completely from your system to avoid conflict with another camera or capture device.
My CD Installation wizard does not work.	The auto installation file is switched to off. or The CD-ROM is disconnected.	Go to the computer desktop. Right click on "My Computer". Click "Properties". Select "Device Manager". Double click on "CD-ROM", double click on "CD-R" (normally the manufacturer's name). Click on "Settings". Ensure "Auto insert notification" is ticked and the "disconnect" is ticked. If you change the settings the computer will ask you to restart your PC. Click "Yes". (Only for Windows® 98 and ME user)

Please also refer to the help files & User Guides that accompany the enclosed applications. For further information and updated software support (driver and application program), please visit the following website:

<http://www.spectraintl.com/xsp/KT7002updates.html>

15. TECHNICAL SPECIFICATION

- Memory: 8MB SDRAM
- Still Image Resolution:
 - High Resolution: 640 x 480 pixels (VGA)
 - Low Resolution: 320 x 240 pixels (QVGA)
- Image Performance for Video:
 - High Resolution: 7-10 fps (frame per second)
 - Low Resolution: 15-20 fps
- Image Capacity*:
 - Non-compressed: VGA - Approx. 24 Images
 - QVGA - Approx. 93 Images
 - Compressed: VGA - Approx. 84 Images
 - QVGA - Approx. 179 Images
- Video Clips: unlimited when connected to the computer via video capture software.
- Self-Timer: Electronic self-timer with 10 seconds delay.
- File Format (For Windows® Users):
 - Still Image: JPEG format
 - Video Image: AVI format
- Interface: USB v1.1
- External Connector: USB
- Auto Power Off: 30 seconds after inactivity
- Power Supply: USB Port, 2 x AAA (UM-4) Batteries (Not Included)
- Operating System:
 - For Windows® Users: Microsoft® Windows® 98, Me, 2000 or XP

*Note: Scene complexity affects an image's file size. The number of images you can store on the camera may vary.

16. SERVICE

Please refer to the instructions on the enclosed warranty card for returning your unit for service. When returning the unit, please remove batteries to prevent damage to the unit in transit and/or from possible battery leakage. We are not responsible for batteries returned with the product or for the cost of replacement.

Distributes by:
Spectra Merchandising International, Inc.
4230 North Normandy Avenue
Chicago, IL 60634, U.S.A.

Please have model number ready, for Customer Service, call 1-800-777-5331

Printed in China
© 1976, 2004 Sanrio Co., Ltd.

Free Manuals Download Website

<http://myh66.com>

<http://usermanuals.us>

<http://www.somanuals.com>

<http://www.4manuals.cc>

<http://www.manual-lib.com>

<http://www.404manual.com>

<http://www.luxmanual.com>

<http://aubethermostatmanual.com>

Golf course search by state

<http://golfingnear.com>

Email search by domain

<http://emailbydomain.com>

Auto manuals search

<http://auto.somanuals.com>

TV manuals search

<http://tv.somanuals.com>