

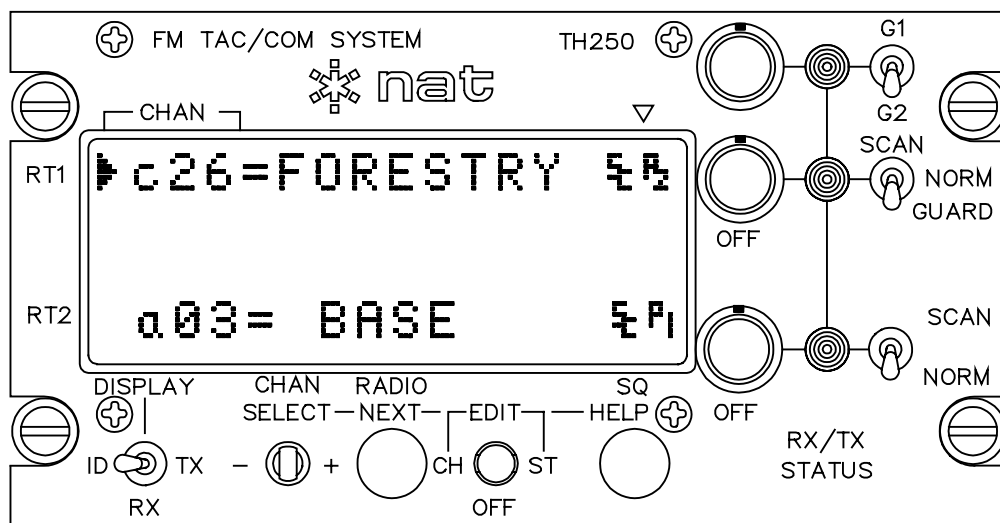

SM06

TAC/COM SERIES
Control Head



INSTALLATION AND OPERATION MANUAL

REV 4.10 January 4, 2006

Northern Airborne Technology Ltd.
1925 Kirschner Road
Kelowna, BC, Canada.
V1Y 4N7

Telephone (250) 763-2232
Facsimile (250) 762-3374

Copyright 2005 by Northern Airborne Technology

CONFIDENTIAL AND PROPRIETARY TO NORTHERN AIRBORNE TECHNOLOGY LTD.

Periodically NAT will release manual amendments. In order to maintain the most accurate and up to date manual these amendments should be carried out immediately upon receipt and recorded on the following amendment record.

AMENDMENT RECORD				
Amendment Number	Amendment Date	Section(s) Changed	Date Entered	Entered By

Insert any Amendment Instruction sheets after this page.

Table of Contents

Section	Title	Page
1	Description	
1.1	Introduction	1-1
1.2	General	1-1
1.2.1	Tac/Com Control Head Family	1-2
1.2.2	Accessories	1-3
1.3	Purpose of Equipment	1-5
1.3.1	Interface Considerations	1-6
1.3.2	Mixed Transceiver System	1-6
1.3.3	Radio Capability Increase With Tac/Com	1-7
1.3.4	Master/Slave Configuration	1-8
1.3.5	Frequency Data Considerations	1-9
1.4	Hardware Design Features & Considerations	1-10
1.4.1	General	1-10
1.4.2	Display Filtering/Lighting Options	1-10
1.5	Specifications	1-11
1.5.1	Electrical Specifications	1-11
1.5.2	Physical Specifications	1-12
1.5.3	Environmental Specifications	1-13
1.6	Unit Nomenclature	1-13
1.6.1	Series Designation	1-13
1.6.2	Number Of Radios	1-13
1.6.3	Display Type	1-14
1.6.4	Display Filter/Lighting Suffix Information	1-14
1.6.5	Interface-Specific Suffix Information	1-15
2	Installation	
2.1	Introduction	2-1
2.2	Unpacking and Inspection	2-1
2.2.1	Warranty	2-1
2.3	Installation Procedures	2-1
2.3.1	Warnings	2-1
2.3.2	Cautions	2-2
2.3.3	Cabling and Wiring	2-2
2.3.4	Mechanical Mounting	2-3
2.3.5	Notes	2-3
2.4	Post Installation Checks	2-4
2.4.1	Voltage/Resistance Checks	2-4
2.4.2	Power On Checks	2-4

Section	Title	Page
2.5	Troubleshooting	2-6
2.5.1	Weak Receive/Transmit, Intermittent Operation, Erratic Squelch	2-6
2.5.2	Strange Noises, No Receive Audio, Transmit Keying problems	2-6
2.5.3	Some Frequencies Can't be Edited	2-6
2.5.4	Display Brightness is Too Low, Can't Increase to Full Brightness	2-6
2.5.5	Amber (RX) Squelch light comes on, but no RX audio is heard.	2-7
2.6	Final Inspection	2-7
2.7	Continued Airworthiness	2-7
2.8	Installation Drawings	2-8
2.8.1	Outline drawings	2-8
2.8.2	System Connector (J-100)	2-8
3	Operation	
3.1	Introduction	3-1
3.2	General	3-1
3.3	Initial Operation	3-2
3.3.1	Power-up Help	3-2
3.3.2	Initial Operating Display	3--2
3.4	Front Panel Controls	3-3
3.4.1	Radio Specific Controls	3-4
3.4.2	General Controls - NORMAL Operation	3-6
3.5	Editing	3-10
3.5.1	Channel Editing	3-11
3.5.2	Summary of Channel Editing	3-14
3.5.3	Summary of Channel Labels	3-15
3.5.4	Summary of Subaudible Tones	3-16
3.6	Status Line Editing	3-19
3.6.1	NEXT and SELECT Switch Use	3-20
3.6.2	Status Edit Features	3-21
3.7	Channel Display Summary	3-23
3.7.1	Display Switch Set to 'ID'	3-23
3.7.2	Display Switch Set to 'RX'	3-24
3.7.3	Display Switch Set to 'TX'	3-24
3.8	Changing Display Brightness	3-25
3.9	Scanning	3-25
3.9.1	Scan Modes	3-27
3.10	NAT NTX138 Wide-band/Narrow-band Operation	3-28
3.11	Master Edit Mode	3-29
3.11.1	Entering Master Edit Mode	3-29
3.11.2	How Data is Stored in the Control Head	3-30
3.11.3	Editing Considerations	3-30
3.12	Installation & Configuration Mode	3-31
3.12.1	Entering Configuration Mode	3-31
3.12.2	Configuration Option Table	3-32

Section 1 Description

1.1 Introduction

This manual contains information on the NAT Tac/Com control heads. All derivative products and interface cards will be covered by manual supplements, which can be obtained from NAT as required.

Information in this section consists of purpose of equipment, features and specifications.

1.2 General

The Tac/Com control head provides exceptional flexibility and ease of operation while using minimal panel space. In a Dzus panel height of only 4 $\frac{7}{8}$ inches, up to four transceiver systems can be controlled and accessed using a Tac/Com control head. The controlled radio systems may be either NAT transceivers or combinations of different manufacturer's transceivers.

Tac/Com controls are available in two basic families: Tac/Com I (both LED and LCD displays), and Tac/Com II (LED only). Note that the Tac/Com I or 'CH' series control heads have been discontinued since 1995. Tac/Com II control head variations include 2-, 3- or 4-transceiver support, master or slave versions and custom panel lighting, and support expanded channel storage (up to 128 channels per radio), remote channel selection, display auto-dimming, and full software configuration of the control head.

Features	Tac/Com I	Tac/Com II
Control/Display Types	2 & 4 Radio LCD, 2 & 4 Radio LED	2, 3 & 4 Radio LED.
Channels/Radio	32 (NT) or 56 (non-scanning)	128 maximum.
Special Features	HELP, Alphanumeric Labelling of Channels	HELP, Alphanumeric Labelling of Channels, High-speed Scrolling, Remote Radio/Channel Selection, Auto Night Dimming.
Master/Slave	Yes	Yes
DTE12 Support	No	Yes
USFS Guard & Tone Capability	No	Yes
NT136-PAS Compatible	No	Yes

The Tac/Com control head carries its own operator's manual in internal software, and can provide on-line help to the operator for all functions. An initial help mode at power-up can provide a complete tutorial of the control head and its operating and storage functions, and pressing the **HELP** button during either **EDIT** operation brings up context-sensitive help for the specific storage or data entry function being carried out. This provides a simple way for new staff to train, as well as providing a private method to refresh their knowledge of the system whenever they chose. The help information 'manual' can never be lost or misplaced because it forms part of the basic control head itself.

Radio control functions and transceiver interfaces are determined by a combination of Tac/Com control head software and internal radio-specific interface cards. To specify a complete control head, you must select the basic size format and the internal interfaces. The range of control heads is shown graphically in the Tac/Com control head family drawing below.

1.2.1 Tac/Com Control Head Family

Each control head type can have user-specified interfaces installed as required. Control heads with LCD displays are no longer available (available as Tac/Com I only). Current models are available with LED displays (Tac/Com II).

Two-Radio Control Heads

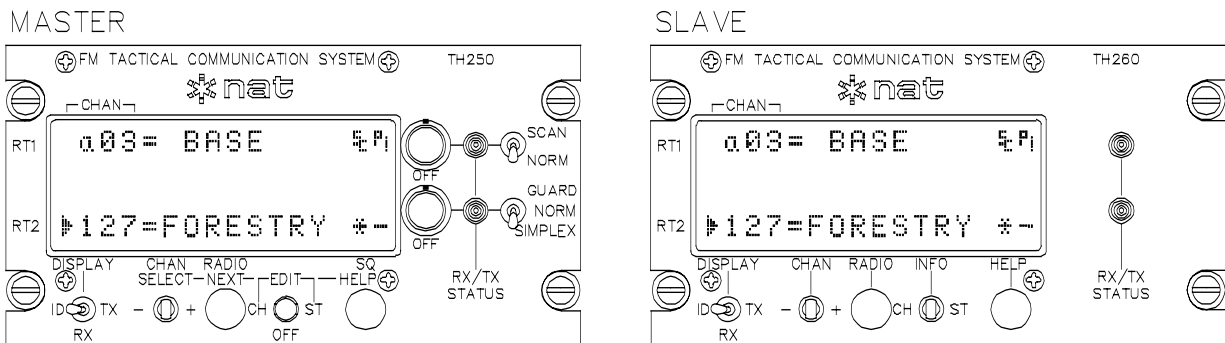

Three-Radio Control Heads

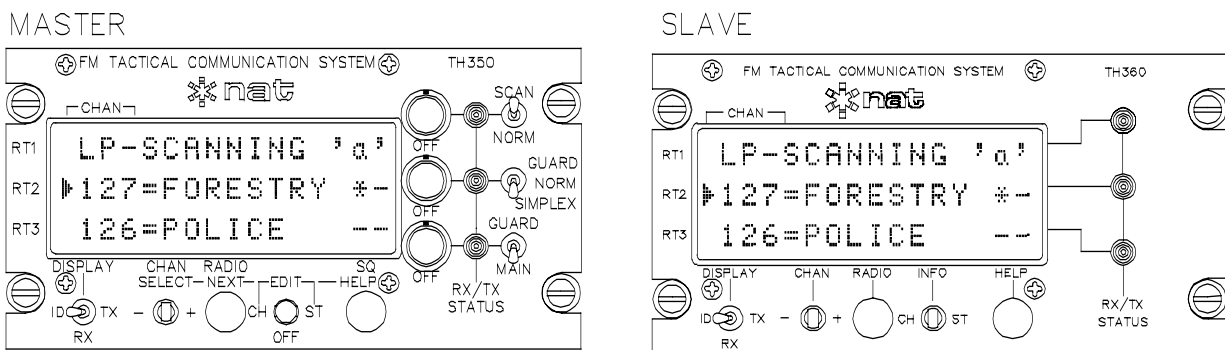

Four-Radio Control Heads

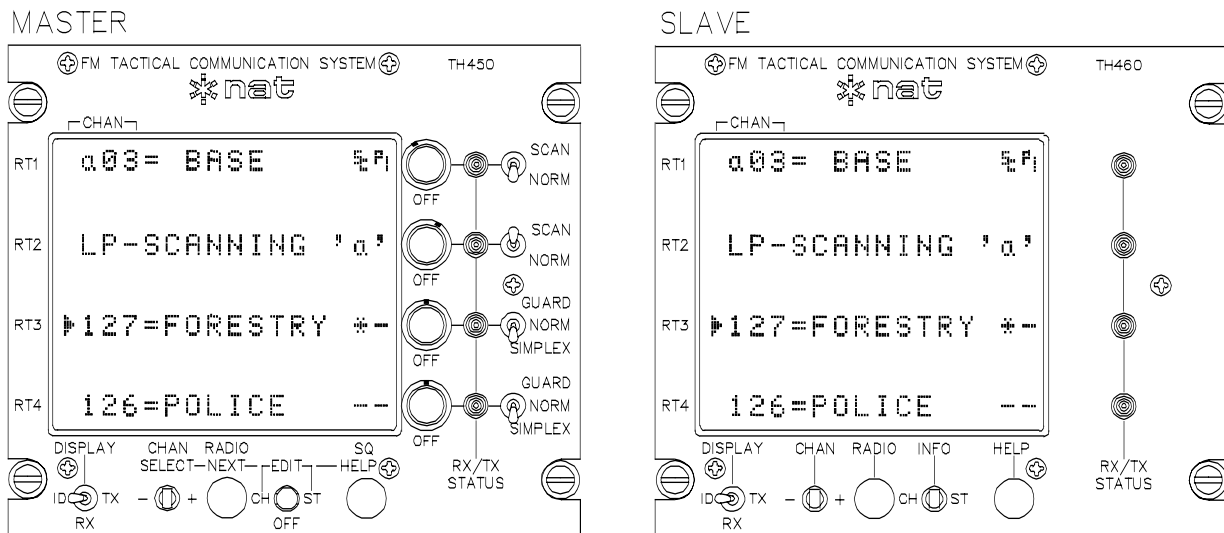

1.2.2 Accessories

The Tac/Com family encompasses numerous specialized accessories to extend system capability, as well as transceivers and the control heads reviewed in this manual.

NAT transceiver capabilities are covered in separate manuals. For reference, the additional system components include:

1.2.2.1 Remote Mount VHF FM Transceivers

*NT030A-xxx	Low Band
*NT030B-xxx	Low Band
*NT136-xxx	High Band
*NT150-xxx	High Band
NTX066-xxx	Mid Band
NTX138-xxx	High Band/Narrow Band Compatible, available with USFS Custom Guard option
NTX138E-100	High Band/Direction Finding (DF) Capability/Enhanced environmental specifications

1.2.2.2 Remote Mount UHF FM Transceivers

*NT403-xxx	Low Band
*NT450-xxx	High Band
*NT450x-xxx	High Band
*NT806-000	800 MHz
NTX403-xxx	Low/High Band
* No longer available as new products.	

1.2.2.3 TE12/DTE12/DP12 DTMF Tone Generator/Keyboard Data Entry Unit

These devices can output DTMF signalling tones from either keyboard control or stored sequences, and can serve as a direct keyboard data entry system for Tac/Com control heads to change channels and frequencies. Consult NAT Ltd. for further information.

1.2.2.4 RA10 Remote Attenuator

This group of remote signal attenuators can be used to alter receive and transmit performance and range under operator control. They allow compliance with restricted transmit power regulations even when the radio itself cannot alter its transmit level. They are used extensively in Europe for changing TX power to even lower levels than the 1W output possible via Tac/Com transceivers directly, and to reduce RX interference from closely spaced repeaters by reducing RX sensitivity.

1.2.2.5 Tactical Direction Finding (TDF) System

This 2-axis DF system allows both left-right and fore-aft sensing with a pictorial display. This provides exceptional accuracy during search and rescue and remote tracking operations, and also provides a positive indication of station passage (impossible with single axis systems) to aid in exact target location.

1.2.2.6 CC250/450 Communications Controllers

The CC250/450 is a compact, easy to install communications controller. It is designed to provide relay and/or simulcast operation for up to 4 transceivers. With these functions, the aircraft can become an airborne repeater or a multi-frequency transmitting platform. When used to its potential, the CC250/450 provides increased efficiency and reduced workload for communication operations. Only the CC450-0V2 is currently in production.

1.2.2.7 CTE12 Calquest™ Headset Adapter

The CTE12-100 Calquest™ Headset Adapter is designed to interface standard avionics headsets to the Calquest™ Cabin Network Unit (CNU). The headset adapter provides a DTMF keypad, status indicators, ring chime control, ring/in-use annunciator control and VOX squelch capability. The headset adapter can interface directly to a headset or a standard avionics audio panel.

1.2.2.8 UT12 Universal Tone Encoder/Decoder

The UT12-000 is capable of encoding and decoding 5-tone CCIR tone sequences and DTMF tones. It is compatible with the NAT Tac/Com system, and when used in conjunction with a TH-series Tac/Com control head provides broader and easier control over tones. The control head or transceiver can select, enable, disable and display tones by communicating with the UT12-000 through a serial port.

1.3 Purpose of Equipment

The Tac/Com series of control heads provides a centralized location for tactical radio control and channelling of up to four independent transceiver systems. Only the Tac/Com II series will be considered; for further information, contact NAT Ltd.

Alphanumeric labeling of each radio channel is provided, as well as a display of receive and transmit frequencies, to ease pilot identification of the selected channel on each radio.

At the Tac/Com (master) control head, individual radio receive volume and radio power on/off status can be controlled. Individual radio functions can also be set, such as scanning, tones, simplex/duplex, TX power and others. Annunciation is provided for TX and RX activity on a per transceiver basis, and the main display can be set to show the channel name (alphabetic label), the receive frequency and tone data, or the transmit frequency and tone data for all radios via the general control group.

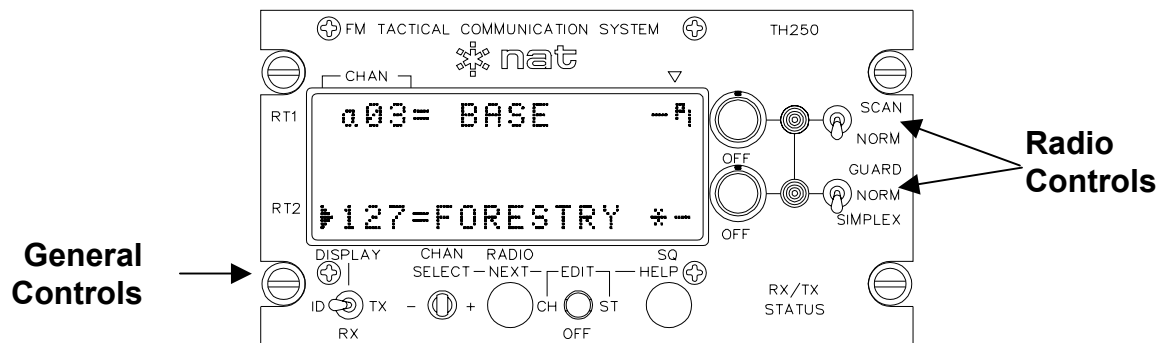

TH250 Control
(2 Radios, 256 Total Channels)

Within the control head, individual radio interface cards translate the control head commands into suitable channelling data for each specific type of radio connected. Software controlling these functions, as well as the built-in help screens for control head operation, is located on the main control head CPU board and can be easily replaced to upgrade or improve control head functions.

The software of the control head's computer can emulate many types of parallel tuned radio controls and this allows the Tac/Com system to directly replace many existing controls such as the C-960, C-961, C-962A, C-722A and C-1000. In addition, since the Tac/Com control allows control of up to four simultaneous radio systems, the single Tac/Com control can replace up to four individual controls, with a substantial reduction in cost and panel space. The following diagram illustrates a system that shows this multiple radio capability using NAT NT-series agile transceivers. Any combination of radios could be used by installation of the appropriate interface cards within the control head. In the example below, an accessory DTE12 is used for DTMF tone generation and direct keyboard data input to the TH450.

1.3.1 Interface Considerations

Tac/Com offers direct plug compatibility for replacement of C-962/A and C-722/A control heads (for use with the RT-9600 and RT-7200), including the second audio connector.

For USFS applications, Tac/Com provides some additional capability when used with the RT-9600. Full guard receiver control can be brought out on the front panel, and the limited tone capability of the RT-9600 (8 variable tones) can be replaced with the internal tone capability of the Tac/Com 'U' interface, which provides all 32 standard CTCSS tones. This interface remains plug-compatible, and also eliminates the awkward external tone encoder required on USFS contracts. A USFS-compatible 'V' interface is provided for use with NT150-050 guard-equipped radios, and the 'H' interface is designed for use with the NTX138-050.

For use with existing Flexcomm installations, NAT provides an adapter cable (p/n FC41-000 Flexcable) that permits direct connection from C-1000 airframe connectors to the 'F' interface.

1.3.2 Mixed Transceiver System

The example shows a four radio Tac/Com control head running a mixed transceiver group, to illustrate what is possible with the interface flexibility of Tac/Com internal architecture. Transceivers may be a combination of fixed and agile radios, with and without scanning, and can be from any of the supported interfaces that NAT provides. See section 1.6.5 or consult Product Support at NAT for further information.

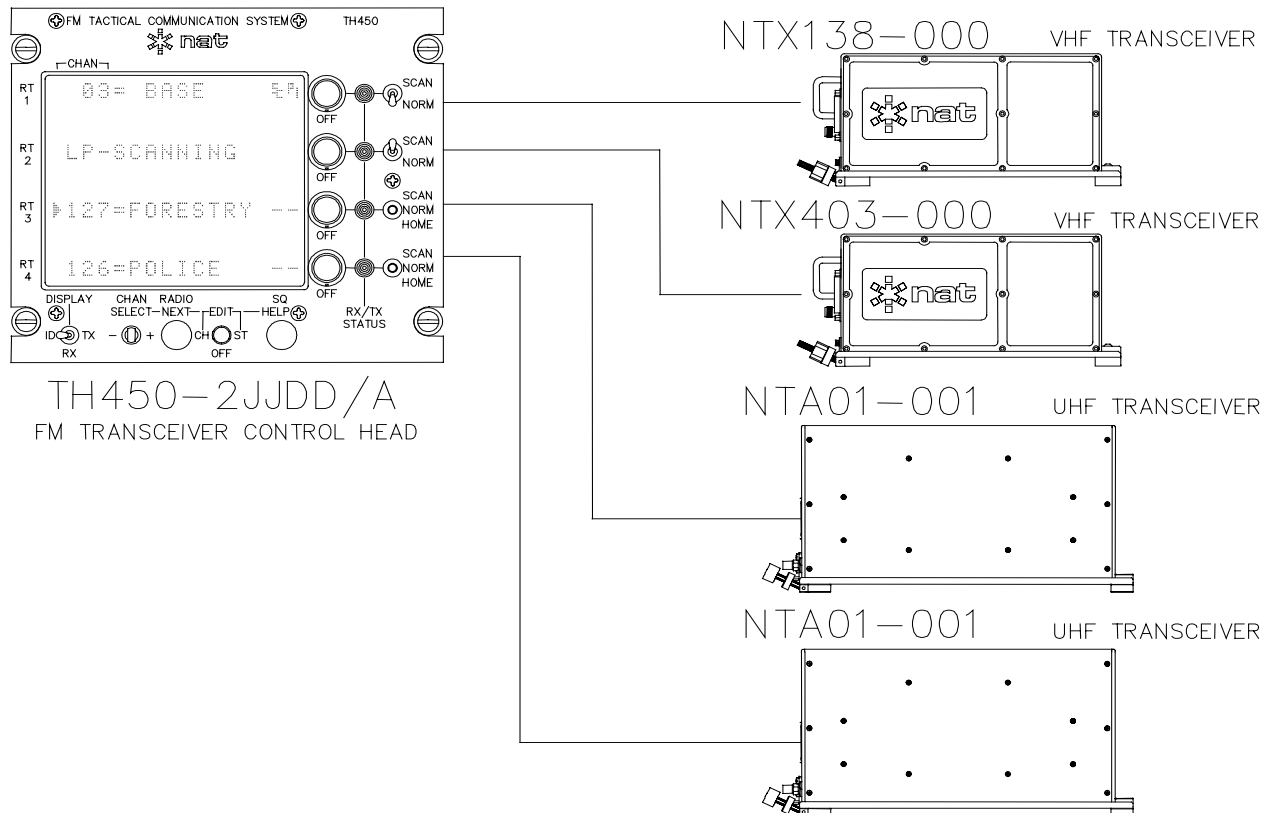

1.3.3 Radio Capability Increase With Tac/Com

Wherever possible, NAT has increased the capability of other transceivers via the Tac/Com control head, and those features are summarized below, compared to the original controls:

Feature	Tac/Com I	Tac/Com II	C1000	C962/722
Stored Channels	32/56 per Radio	128 per Radio	30 Total	15 Total
PL Tones*	38 + 83 DPL	38 + 83 DPL 32 for W.E.D.	32 32 for W.E.D.	8
No. of Transceivers (simultaneous)	1 - 4	1 - 4	1	1
Alpha Labels	Yes	Yes	No	No
Remote Selection (channels & radio)	No	Yes	No	No
Master/Slave (both active)	Yes	Yes	No	No

*NAT NT-series Radios have the capability shown. Tac/Com controls can provide 32 PL tones for Flexcomm. Tac/Com II can also provide an internal tone upgrade for the RT-9600/7200 to provide all 32 standard EIA CTCSS tones ('U' interface).

PL = Private Line (also known as CTCSS)

DPL = Digital Private Line

W.E.D. = Wulfsberg Electronics Division

Note: Only NAT's own NT-series transceivers support all the features provided by Tac/Com controls. Tac/Com controls cannot give a radio functions of which it is inherently incapable. For example, older crystal-controlled Flitefone 40's do not become agile radios when connected to a Tac/Com head, and Flexcomm radios do not acquire high speed scanning or DPL capability.

1.3.4 Master/Slave Configuration

One powerful configuration that NAT's Tac/Com controls support is the master/slave configuration. In this configuration, two controls can be active at the same time (flight crew and medical crew, for example), and both can select channels and radios. The extraordinary aspect of this interface is the fact that this interconnect requires only 6 additional wires to give full support to both stations. Dual controls wired with other units often require hundreds of wires, and still permit only a single control to be active at one time.

A typical master/slave interconnect is illustrated below for clarification. Many variations are possible, and the controls can be 2, 3 or 4 radio types, if required.

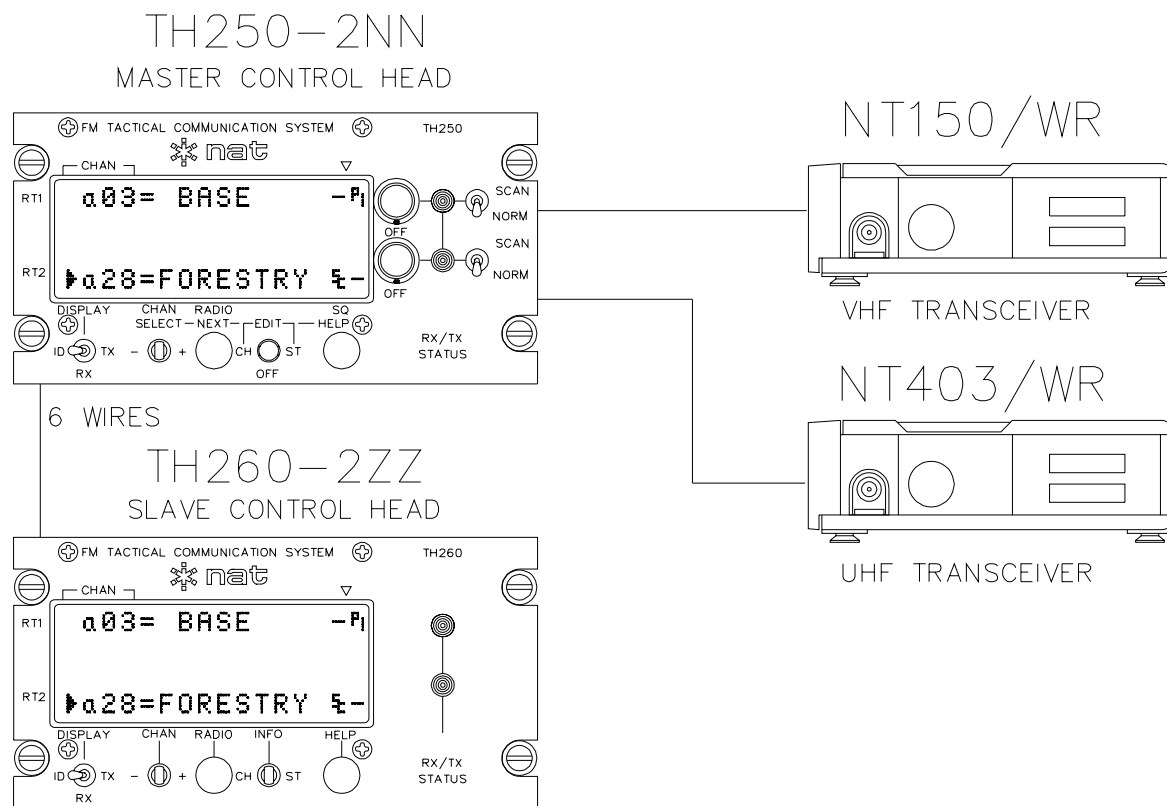

1.3.5 Frequency Data Considerations

Tac/Com controls have an intelligent editor that prevents incorrect data entry when programming frequencies for a given agile radio. VHF radios can receive only valid VHF frequencies; UHF radios only UHF frequencies at the correct intervals, and so on. This greatly eases operator use, and prevents many common pilot errors. The C-1000 permits many types of incorrect entries for radios because of its thumbwheel entry system. This intelligent editor is especially useful when the Tac/Com control head has been set to emulate a C-1000 (i.e., channel any Flexcomm radio), as it detects the range of the radio as the data is being entered, and then restricts subsequent information to correspond to the exact radio type.

Radios in each band-split have specific channel interval assignments (by law), and are typically on 25 kHz, 15 kHz, 12.5 kHz, 6.25 kHz, 5 kHz or 2.5 kHz intervals. Which multiples are possible depends on the design of the radio's synthesizer circuitry, history and restrictions of the country of operation. Tac/Com automatically picks the correct multiples for each radio type based on the stored installation data, and ensures that only valid choices are possible for the operator.

If the operator enters invalid data via either external data entry or other procedure, the control will advise of this error. User intervention is then required to correct the data before proper radio operation can be achieved.

1.3.5.1 Frequency Programming

There are three ways to program channel data into a Tac/Com control head:

- a) From the front panel controls (edit mode).
- b) From a DTE12 Keyboard/Data Unit (edit mode, Tac/Com II only).
- c) From a PC via NAT's data loading software & the system serial port.

1.3.5.2 Channel Selection

There are three ways to select a channel on a Tac/Com control head:

- a) From the front panel controls.
- b) From the remote select switches (Tac/Com II only).
- c) From a DTE12 Keyboard/Data Unit (Tac/Com II only).

1.4 Hardware Design Features & Considerations

1.4.1 General

The Dzus mounted Tac/Com control heads use extremely high quality components, including sealed gold contact switches, gold contact connectors and fully masked, conformal-coated FR4 flame retardant circuit boards. Each unit is fully temperature cycled, life-tested, and then supported with a solid one-year warranty and extensive field support to ensure the best possible customer satisfaction.

A wide range energy conversion power supply is used in the control head, allowing operation from 16-33 Vdc, for nominal 28 Vdc systems. Panel lighting must be adjusted to suit the specific application, and is normally supplied as natural colouration 28 Vdc incandescent lighting. Options include blue/white or NVG lighting available in +5, +14 or +28 operating voltages.

For ease of service, integrated circuits are socketed where possible, allowing fast return to service of failed control heads and quicker bench troubleshooting. Control head software is easily updated for improved features or expanded capability by an internal EPROM exchange. Internal interface cards are plug-in modules to facilitate quick service exchange or upgrade.

Wherever possible, fully plug-compatible interconnects are provided for existing systems replaced by Tac/Com controls, making retrofits and test flights both easy to accomplish and inexpensive. Where it is not possible to directly accomplish this within the control head itself, an adapter cable or plug replacement on an existing cable is used.

1.4.2 Display Filtering/Lighting Options

Current LED displays used in Tac/Com II control heads are green (first generation Tac/Com I controls used a yellow display), with fully formed 5x7-pixel alphanumeric characters. They have a large character height of 5 mm/0.2" and a very wide viewing angle (>150 degrees) that provides good readability from virtually all cabin mounting locations, including centre consoles such as in the Bell 412/212.

Several display filter/panel lighting options are provided with LED controls to give the best visual presentation in different ambient lighting conditions. 'Filter' refers to the DISPLAY colour and appearance and 'Panel Lighting' refers to the panel legend back lighting colour & voltage.

See Section 1.6 Unit Nomenclature for complete option list details.

The backlighting for the control head (which includes the LCD display) can be run from a dimmer separate from other cockpit controls if more adjustment over the LCD back lighting is desired. This will permit both backlighting and contrast to be adjusted for the best presentation. The LED display automatically dims (on current production units) to 50% intensity when voltage is detected on the control head light bus. The LED display is adjustable in 7 steps via the SELECT (+/-) switch, when the Bright +/-Dim - screen is displayed.

1.5 Specifications

1.5.1 Electrical Specifications

Input Power: 16-33 Vdc.

Current: 0.25 A/LED Control 250 Series
 0.35 A/LED Control 350 Series
 0.45 A/LED Control 450 Series
 0.15 A/LCD Control 400 Series
 +0.075 A/Interface Card Installed (for all types)
 +0.250 A/28 Vdc for panel lighting

Values above are maximum, display set to full intensity.

Panel Indicators: Two-colour LED indicates: TX - Green
 RX (SQ) - Orange

One LED per radio, except when the interface supports separate guard controls ('U', 'V', etc.), in which case a second LED is provided for the guard receiver.

Channel Storage: CH-series (Tac/Com I) 32/56 Channels per radio
 TH series (Tac/Com II) 128 Channels per radio

Data Interface: Programming via standard RS-232 from a PC (NAT software), or front panel for all functions.

Scanning: NT -series transceivers: 90 channels/second/radio.
 NTX -series transceivers: 10-20 channels/second/radio.

Modes are LIST, PRIORITY, LIST + PRIORITY.
 Priority monitoring is 3 times/second for 10-15 ms sample.
 Radio will re-channel to the priority channel if traffic is detected, and returns to the monitor channel after a 2 second latency.

All CTCSS tones or DPL codes are inactive during scanning (due to lock delay).

Other scanning parameters depend on the radio type.

1.5.2 Physical Specifications

Height	Tac/Com Series	Rail Height Required
	250/260 and 350/360	3.00"
	450A	3.75"
	450B and 460B	3.375"
	450/460	4.875"
Length	6.27 inches (159.3 mm) excluding connector	
Width	5.8 inches (146.1 mm)	
Weight	2.2 to 2.9 lbs (1 kg to 1.3 kg) depending on model	
Mounting	Horizontal through-panel Dzus mount. Fits standard opening (5" clearance/5.75" panel width) Requires 3" of rail height (450 series require 4.875")	
Front Panel Controls:	Radio Volume/Power ON-OFF One or two radio-specific controls Display Contrast (LCD) Display Mode (ID/RX/TX) Channel/Select (+/-) Radio/Next Edit Switch (Channel-Off-Status) Squelch/Help	
Internal Controls:	Agile Channel Defeat/Enable (on interface cards) Lamp Dimmer Voltage (Panel Overlay) Squelch, Tone & Level Preset where applicable	
<u>Tac/Com I Only, pre-s/n 1129:</u>	NAT R/T Band Select RT-9600/7200 Mode Select Flexcomm Band Select Overall form factor matches C-722A/C-962A/C-1000	
QA/Manufacturing Processes:	TC AWM PART 561 MIL-STD-2000 (MU) Assembly ISO9001-1994	

1.5.3 Environmental Specifications

Altitude:	Pressurized alt. equivalent to 15,000' Unpressurized alt. equivalent to 35,000'
Temperature:	-20° C to +60° C Operating -55° C to +85° C Survival
Humidity:	90% @ +60° C
Vibration:	DO-160 category K/P/S, console or panel mounting in both helicopters or fixed-wing. All Dzus fasteners MUST be secured.

1.6 Unit Nomenclature

Tac/Com control heads are identified by two groups of numbers. The first defines the general capability of the control head in terms of the total number of radios controlled and type of display, and the second specifically defines the display filter and backlight type, as well as the radio types supported. Each section of the part number defines part of the control head capability.

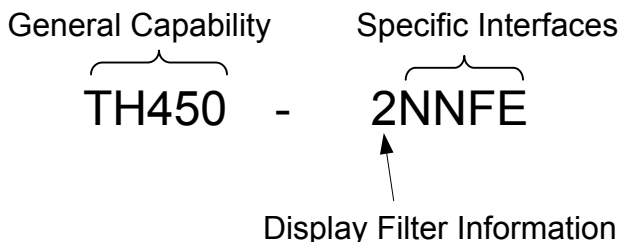

1.6.1 Series Designation

TH450 - 2NNFE

CH = Tac/Com I Series Controls

TH = Tac/Com II Series Controls Above example: Tac/Com II

1.6.2 Number Of Radios

TH250 - 2NN

2 = Two Radio Control

3 = Three Radio Control

4 = Four Radio Control Above example: 2 Radio

1.6.3 Display Type

TH450 - 2FFNN

- 00 = LCD Display, Master (Discontinued)
- 10 = LCD Display, Slave (Discontinued)
- 50 = LED Display, Master
- 60 = LED Display, Slave Above example: LED Master

1.6.4 Display Filter/Lighting Suffix Information

TH260 - 2ZZ

- 0 = Yellow/Green LED Filter, or Clear LCD Filter, Natural 28 Vdc lighting. (LCD Standard)
- 1 = Dark Green LED Filter, NVG-friendly LED 28 Vdc lighting
- 2 = Dark Green LED Filter, Natural 28 Vdc lighting. (LED Standard)
- 3 = Yellow/Green LED Filter w/Z-cloth, Natural 28 Vdc lighting
- 4 = Dark Green LED Filter, Natural 5 Vdc lighting
- 5 = Dark Green LED Filter, NVG-friendly LED 5 Vdc lighting
- 6 = Dark Green LED Filter, Blue/White 28 Vdc lighting
- 7 = Circular Polarized glass, daylight, Natural 28 Vdc lighting
- 8 = Circular Polarized glass, daylight, Blue/White 5 Vdc lighting
- 9 = Deep Red Filter with Red LED Displays, Natural 28 Vdc lighting
- 10 = Yellow/Green with Amber LED Displays, Natural 28 Vdc lighting
- 11 = Circular Polarized glass, daylight, NVG-friendly LED 5 Vdc lighting
- 12 = Circular Polarized glass, daylight, NVG-friendly LED 28 Vdc lighting
- 13 = Circular Polarized glass, Natural 5 Vdc lighting
- 14 = Dark Green LED Filter, Blue/White 5 Vdc lighting
- 15 = Circular Polarized glass, daylight, Blue/White 28 Vdc lighting
- 16 = Circular Polarized glass, daylight, NVIS B Compliant 28 Vdc lighting
- 17 = Circular Polarized glass, daylight, NVIS B Compliant 5 Vdc lighting

1.6.5 Interface-Specific Suffix Information

The position of the digit in the code reflects the position of the card in the control. The code position from left to right equals the relevant card position from top to bottom.

TH450 - 2NNNE

A = ARINC 2 of 5 Comm	M = Midland Syn-Tech I
B = Blank (No Controls)	N = NAT NT-Series
C = Flitefone 40	O = Not Assigned
D = Motorola Astro/XTL Series	P = RT9600/7200 Single Connector
D1 = Motorola Astro/XTL with zone function	Q = RT9600 with Tones, No Guard
E = NT Slot. Controls only. No Card	R = RT9600/7200 Plug Compatible
F = Flexcomm	S = Motorola URC-200
G = Flex Slot. Controls only. No Card	T = NAT NT-Series with Transcript
H = NTX Series with USFS Guard	U = RT9600 with USFS Guard & Internal 32 Tones
I = Not Assigned	
J = NAT Tac/Com NTX Series	V = NAT NT-Series with USFS Guard
J1 = Chelton 805-1, 905-2, 915-1	W = Not Assigned
K = Midland Syn-Tech XTR	X = Not Assigned
L = Motorola Spectra	Y = Serial I/O Expansion Port
L1 = Motorola Spectra with zone function	Z = General Slave Interface

Above example: 3 NAT & 1 Empty (Empty in bottom slot)

Earlier Tac/Com I controls had a different numbering scheme, using only a three character suffix. If you need to convert an older number to a new one, contact NAT for details, or consult revision 1.xx of this manual.

End of section 1

Section 2 Installation

2.1 Introduction

Information in this section consists of: unpacking and inspection procedures, installation procedures, post-installation checks, and installation drawings.

2.2 Unpacking and Inspection

Unpack the equipment carefully and locate the warranty card. Inspect the unit visually for damage due to shipping and report all such claims immediately to the carrier involved. Note that each unit should have the following:

- Tac/Com Control Head
- Warranty Card
- Operator's Manual
- Release certification

Verify that all items are present before proceeding and report any shortage immediately to your supplier.

2.2.1 Warranty

Complete the warranty card information and send it to NAT when the installation is complete. If you fail to complete the warranty card, the warranty will be activated on date of shipment from NAT.

Note: An appropriately rated facility, e.g. Certified Aircraft Repair Station, must install this equipment in accordance with applicable regulations. NAT Ltd's warranty is not valid unless the equipment is installed by an authorized NAT Dealer. Failure to follow any of the installation instructions, or installation by a non-certified individual or agency will void the warranty, and may result in a non-airworthy installation.

2.3 Installation Procedures

2.3.1 Warnings

Do not bundle any lines from this unit with transmitter coax lines. Do not bundle any lines from this unit with 400 Hz synchro wiring, or AC power lines. Failure to observe these limitations may result in incorrect or intermittent operation, or severe audio interference on received and transmitted signals.

In all installations, use shielded cable exactly as shown, and ground as indicated. Significant noise problems and/or improper operation may result from not following these guidelines.

2.3.2 Cautions

All audio installations can be severely degraded by incorrect wiring and shielding, and may result in much higher cross-talk, hum, and ground-loop interference. This should be considered when installing audio wiring to and from the specific radio. Both the audio Hi and Lo wires must be connected from the radios (audio outputs are floating transformer windings on NT-series radios), and should be grounded only at the audio panel via the audio common.

If multiple transceivers are installed, it is very beneficial to use tri-axial cable for the antenna feedlines, with the outer shield grounded at the radio end only. This added electro-static shielding greatly reduces cable coupling, and eliminates many types of interference in the final installation. Observe proper antenna spacing and good routing practice for all RF lines to avoid cross-talk, squelch interference, and phantom sidetone problems.

2.3.3 Cabling and Wiring

All unshielded wire shall be selected in accordance with AC43.13-1B Change 1, Paragraphs 11-76 through 11-78. Wire types should be to MIL-W-22759 as specified in AC43.13-1B Change 1, Paragraphs 11-85, 11-86, and listed in Table 11-11. For shielded wire applications, use Tefzel MIL-C-27500 shielded wire with solder sleeves (for shield terminations) to make the most compact and easily terminated interconnect. Follow the wiring diagrams in Section 2.9 as required.

Installation cabling must allow the unit to be easily withdrawn for disconnection, switch and pot settings (internal), and removal. Ensure an adequate service loop is allowed in the routing of the cable. This can become a serious problem if the unit is installed with the cables so short that the unit cannot be removed without disassembly of the mounting console. At least 1 foot (30 cm) of free cable is recommended.

Allow 3 inches (8 cm) from the end of the wire to the shield termination to allow the hood to be easily installed. Note that the hoods supplied by NAT in installation kits are 'clamshell' hoods, and are installed after the wiring is completed.

Generally, all wiring should be at least 22 AWG, except power and ground connections, which should be 20 AWG - check the appropriate Interconnect drawing for the unit under consideration. Ensure that the ground connection is clean and well secured. To prevent inadvertent system failure, power to this system must be supplied from a separate breaker or fuse, and not bundled to any other source. A 1A breaker is suggested (28 Vdc source).

Notes:

1. The case is grounded electrically and should be attached to a grounded surface for correct RFI shielding. A pin is provided for grounding the case, and this must be connected via its own wire to a suitable ground, not jumpered to the power ground wire connection.

2. The interface cards for the RT9600 and RT7200 have different locks from those on the original harness. The tight packaging on the Tac/Com control head does not allow spring locks to be used. The harness locks must be changed to jackscrews to match the Tac/Com connectors before flight. New locking hardware is furnished with the control head when these cards are installed.

2.3.4 Mechanical Mounting

Installation should be in accordance with AC 43.13-1B chapter 7, sections 3 to 7 and AC 43.13-2A chapter 2.

Mounting is accomplished in a standard Dzus rack or rail assembly with a clearance opening of 5", and full width dimension of 5.75". The rail height required for mounting the various control heads is shown below.

Tac/Com Series	Rail Height Required
250/260 and 350/360	3.00"
450A	3.75"
450B and 460B	3.375"
450/460	4.875"

Be sure that adequate rear cable clearance is allowed when planning console installations. Refer to the aircraft structural repair manual and maintenance manual for instructions and information pertinent to this installation.

2.3.5 Notes

2.3.5.1 Control Head System Connector

The J100 System Connector Power/Lights/Ground connections must be provided for operation of the overall system, in addition to the basic interface card-to-radio connections. For specific RT9600/7200 radios, see the relevant Interface Card supplement (**SM06PQRU\810-0**) for an alternative method for providing these connections to the control head.

Pins 7, 10 and 22 are serial data control lines that may be brought out to a connector for serial loading of the control by a PC. This allows easy large scale data changes without removing the control head from the aircraft. NAT provides a special software package for this function. This port may also be used for Master/Slave operation or the DTE12 DTMF/Keyboard Data Unit.

2.3.5.2 Additional Mounting Considerations

LED display units come in several different display filter styles (see Section 1.6), and the panel location and filter type should be matched for the best performance. LED displays offer very wide viewing angles, and are suitable for centre console mounting and locations not in the pilot's direct field of vision.

2.4 Post Installation Checks

Before the unit is permanently mounted, perform the following functional tests and make any needed adjustments and switch or jumper settings. Ensure that the unit is securely mounted before any flight is attempted.

2.4.1 Voltage/Resistance Checks

DO NOT ATTACH THE TAC/COM CONTROL HEAD UNTIL THE FOLLOWING CONDITIONS ARE MET.

With the Tac/Com control head disconnected from all of its mating connectors, make the following measurements on the system connector P100 mating plug (25-pin) whether it comes from an FC41 adapter cable or from the basic airframe wiring:

- a) Check pins <1> and <2> for +28 Vdc relative to ground.
- b) Check pins <13>, <14> and <15> for continuity to ground (below 0.5 ohms).
- c) Check pin <3> (28 Vdc), pin <4> (14 Vdc) or pin <5> (5 Vdc) for proper lamp dimmer voltage.
- d) Check pin <16>, <17> or <18> for continuity to ground as above (lamp return).

If the control head uses only the RT9600/7200 plug-compatible interface card, it is permissible to not use the system connector, and instead use the existing wiring from the C-962/722. In that case, make the following checks on the C-962/722 25-pin audio connector:

- a) Check pin <19> for +28 Vdc relative to ground.
- b) Check pins <10>, <12> and <20> for continuity to ground (below 0.5 ohms). Pin <12> should be a separate wire to ground.
- c) Check pin <16> (28 Vdc), pin <15> (14 Vdc) or pin <17> (5 Vdc) for proper lamp dimmer voltage.

2.4.2 Power On Checks

WARNING:

**High volume settings can cause hearing damage.
Set the headset volume control to the minimum volume
setting prior to conducting this test and slowly increase the
headset volume level to a comfortable listening level.**

Power up the aircraft's systems with the Tac/Com control head and RT's installed, and turn ON all of the radios and other accessories required for this system.

Make the following performance checks (refer to Section 3, Operation):

- a) Confirm that the desired radios are installed in the assigned Tac/Com control head slots (this data appears at power-up on the display). If any aspect of the radio assignments is incorrect, or if messages such as 'waiting for slave' appear when there is no slave, etc., the set-up of the control head may be incorrect. Consult the Installation Configuration Mode section of this manual (Section 3.12), or contact the Product Support department at NAT for instructions on how to alter this data before proceeding.
- b) Check for correct radio operation and channelling, both receive and transmit, and ensure that all status indications are correct (TX and RX). Do not proceed until the radios are operating correctly. It may be necessary to set the display screen (after the last radio) on the control head to obtain a clear or bright display.
- c) Correct squelch operation may require setting the AUDIO and FAST SQUELCH pots on the top of the control head (NT-series radios only). The FAST pot is set for the correct trigger point of the panel indicator (scan trigger point), and the AUDIO pot is used to set the audible squelch threshold. These are factory set, and any field adjustment may cause problems.
- d) If squelch settings are to be made in the aircraft, use a calibrated signal generator connected directly to the radio. The visual squelch indicator must be set so that it appears at the same point as the audible squelch. Note that the visual trip point (fast squelch) has no hysteresis, while the audible trip point will remain tripped as the input level is decreased. This is normal and required for correct operation.
- e) If remote channel switches (Tac/Com II only) or a DTE12 (Tac/Com II only) are installed, confirm that all remote channelling and editing functions are working. All of these connections are via the system connector, J100/P100. DTE12 data is serial, while the external remote switches are ground closures (pulled up to +5 V internally).
- f) Check each antenna feedline with a through-line wattmeter and suitable frequency elements at the RT to ensure correct antenna matching. Reflected power in excess of 25% represents a serious problem and should be investigated carefully, or serious RFI and system interference as well as possible radio damage may result. Check that forward power is to specifications for the radio in use.

2.5 Troubleshooting

2.5.1 Weak Receive/Transmit, Intermittent Operation, Erratic Squelch

Ensure all antenna mounts are secure, cleanly grounded, and well terminated. Avoid sharp coax cable bends or crushed coax from tie wraps. Never mount any antenna on a composite surface unless a well-grounded and adequately sized (equal in radius to the height of the antenna) ground plane has been provided. Keep antennas widely separated, especially between VHF radios, and VHF and UHF radios. Bad antenna matches and close proximity will result in large amounts of spurious radiation, which may affect VHF-FM to VHF-AM operation and may result in harmonic interference between VHF and UHF radios.

2.5.2 Strange Noises, No Receive Audio, Transmit Keying problems

Buzzes, hums or other background audio noises are symptomatic of multiple grounds or noisy external systems such as inverters, blowers or pumps sharing wiring with the audio system connections. Failure to key or correctly modulate a transmitter, or no receive audio is often caused by not connecting all required grounds or wires to the radio or external audio system. Check to make sure that the MIC AUDIO and PTT lines are not reversed (keys, but no TX audio). Be sure both audio output wires are connected from the transceivers (no or very faint RX audio).

A special caution is that no audio ground should be taken from the front instrument panel or similar location that shares a ground return with a turn and bank or horizon or other motor driven instrument. If this caution is not observed, the sound of the t&b motor may be heard mixed in with receiver audio.

2.5.3 Some Frequencies Can't be Edited

Some frequencies are not really agile entries (such as crystal guard frequencies), and as such should not be edited during normal operation. All such entries must be set via the MASTER EDIT mode (see Section 3.11).

When in the SIMPLEX mode (RX and TX frequency lines display an 's'), you cannot edit the TRANSMIT portion of the radio channel assignments because there is actually a valid TRANSMIT frequency stored. It is temporarily hidden because of the SIMPLEX function. To edit these frequencies, simply return the control head to DUPLEX operation via the STATUS EDIT function or front panel switch, as appropriate.

2.5.4 Display Brightness is Too Low, Can't Increase to Full Brightness

The intensity of the display is set by two functions, the level set from the display screen (advance the cursor past the last radio, then set the brightness up or down with the SELECT switch) AND the status of the panel dimmer line. If the dimmer is active, then the display automatically dims to HALF BRIGHTNESS of the previous setting. In some

aircraft, such as Aerospatiale airframes, there are two dimmers, one of which MUST be ON for normal daylight flight, to drive engine instruments. If this line is accidentally used, then the display will always be at half intensity. A dimmer must be used that is OFF during normal daylight flying, and ON during night flying for correct control head operation. Early control heads (prior to Tac/Com II) did not have this automatic feature, which has been added to improve night visibility by reducing display glare in the cockpit.

2.5.5 Amber (RX) Squelch light comes on, but no RX audio is heard.

Press the HELP/SQ button. If audio is heard, this means there is a problem either with the subaudible tones, or with the AUDIO squelch setting. Refer to the CTCSS or Subaudible Tone Table in Section 3.5.4.2 of this manual to check the CTCSS tone format and frequency, and/or refer to the Power On Checks section (2.4.2) to check the audio squelch.

2.6 Final Inspection

During the test flight, check levels and operation of all functions. Display brightness or contrast may have to be tailored for adequate viewing by the flight crew. Ensure there is no interaction between any transmit functions and received NAVAIDS, or any other communication receiver functions. Antenna placement or cable routing may have to be changed if these problems are encountered. Closely spaced antennas or coax cable runs may cause problems, especially between VHF systems (AM & FM), and between VHF transmissions and UHF receiving (due to third harmonic relationship), particularly if the RT406F (with its less selective front end) is used in a complex system.

Ensure that there is no interaction between Tac/Com control head operation and ADF performance. If interference exists, relocation or re-routing of the interconnect cabling may be required.

Before leaving the aircraft, ensure that all the mating connectors are securely fastened to the Tac/Com control head. Also ensure that the unit is securely fastened to the aircraft from the front panel, and that all Dzus fasteners are locked.

If all functions are satisfactory, the aircraft may be released for service once all required log entries, electrical load and weight and balance amendments are made, the flight manual supplement is updated, and the required local regulatory paperwork is completed. There is currently no Technical Standing Order (TSO) for FM Communication systems, regardless of manufacturer.

2.7 Continued Airworthiness

Maintenance of the Tac/Com Series control heads is 'on condition' only. Periodic maintenance of this product is not required.

2.8 Installation Drawings

This section has the complete interconnect drawing set for all installations, both current and previous revisions. Be sure to use the correct drawings for your installation. Any unique notes for a given installation type appear in the relevant Interface Card Supplement and in Section 2.3.5. Consult this section for any information that may apply to your specific installation.

All information for interface cards will be provided by Manual Supplements, available by contacting NAT Ltd.

2.8.1 Outline drawings

DRAWING	REV.	DESCRIPTION	TYPE
TH250\NF903	-	Control head plan view (3.0")	Mechanical
TH450\NNFF903	-	Control head plan view (4.875")	Mechanical
TH250\NN\905-0	1.01	Faceplate of Typical Tac/Com II, TH250	Faceplate
TH260\905-0	1.01	Faceplate of Typical Tac/Com II Slave, TH260	Faceplate
TH350\NNN\905-0	1.00	Faceplate of Typical Tac/Com II, TH350	Faceplate
TH360\905-0	1.10	Faceplate of Typical Tac/Com II Slave, TH360	Faceplate
TH450\NNNN\905	1.00	Faceplate of Typical Tac/Com II, TH450	Faceplate
TH460\905-0	1.01	Faceplate of Typical Tac/Com II Slave, TH460	Faceplate
CH200\NF905	-	Faceplate of Typical Tac/Com I, CH200 (LCD)	Faceplate
CH400\NNRR905	-	Faceplate of Typical Tac/Com I, CH400 (LCD)	Faceplate

2.8.2 System Connector (J-100)

DRAWING	REV.	DESCRIPTION	TYPE
CH400-1\403-1	-	Tac/Com I System Connector s/n 1001 – 1043	Interconnect
CH400-1\403-2	-	Tac/Com I System Connector s/n 1044 – 1127	Interconnect
CH402-1\403	B	Tac/Com I System Connector s/n 1127 and up	Interconnect
TH402-1\403-0	1.03	Tac/Com II System Connector s/n 1001 and up	Interconnect
CH410\403	B	Tac/Com I Master-Slave Installation	Interconnect
TH460\403	A	Tac/Com II Master-Slave Installation	Interconnect
TH460\403-1A	A	Tac/Com II Master-Slave Installation with DTE/DP12	Interconnect
CH400-1\405-1	-	Tac/Com I System Connector s/n 1001 - 1043	Connector Map
CH400-1\405-2	-	Tac/Com I System Connector s/n 1044 - 1127	Connector Map
CH402-1\405	B	Tac/Com I System Connector s/n 1127 and up	Connector Map
TH402-1\405	B	Tac/Com II System Connector s/n 1001 and up	Connector Map

Section 2 ends after these Drawings

PLAN VIEW OF A TH250 CONTROL HEAD.
CH200, CH300, CH400, AND TH350 SERIES
CONTROL HEADS HAVE THE SAME DIMENSIONS.

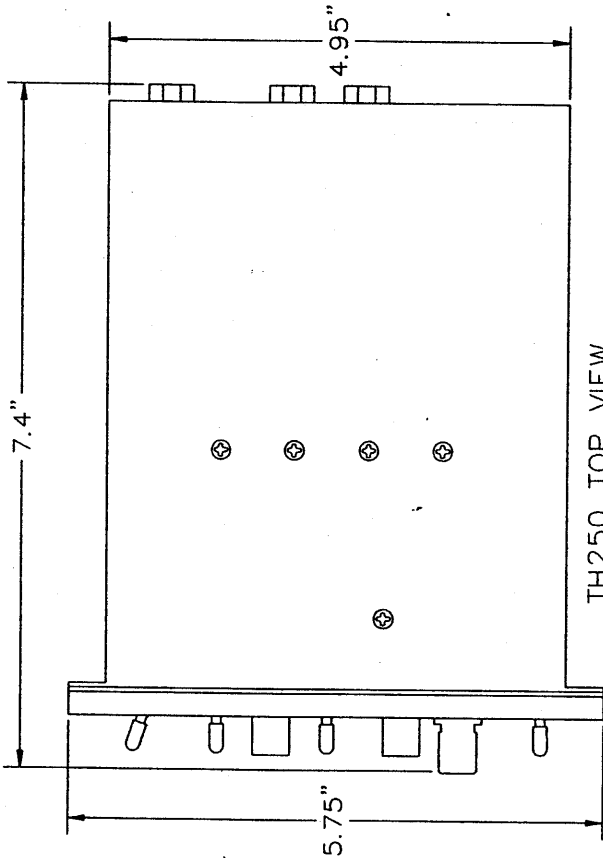

HEIGHT OF
CONTROLS

DEPTH BEHIND DZUS RAIL

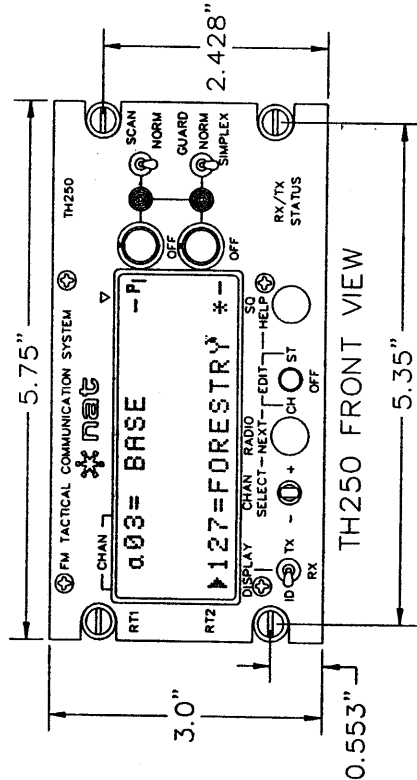
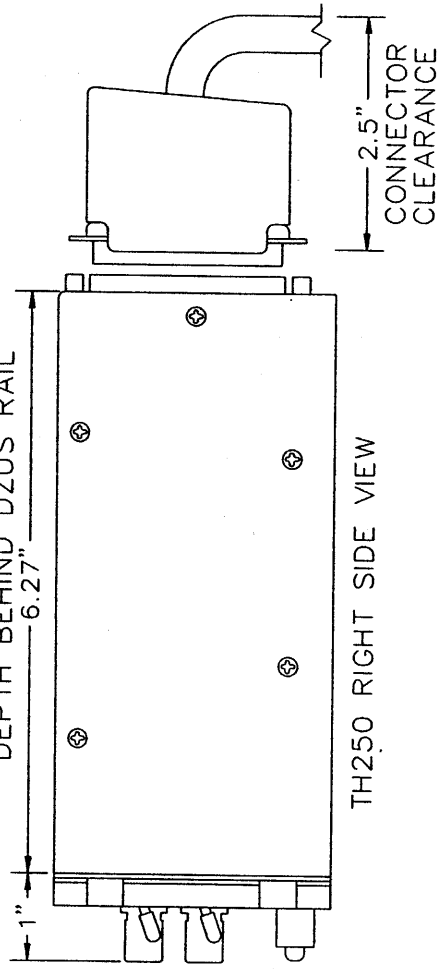

Confidential and Proprietary to NAT

REVISION	DATE	DESCRIPTION	PART NUMBER	DRAWING NUMBER
			TH250-2NF	TH250/NF903
			DRAWN BY	APPROVED BY
			24 JUNE 91	SCOTT MOORE

NAT
QA 100

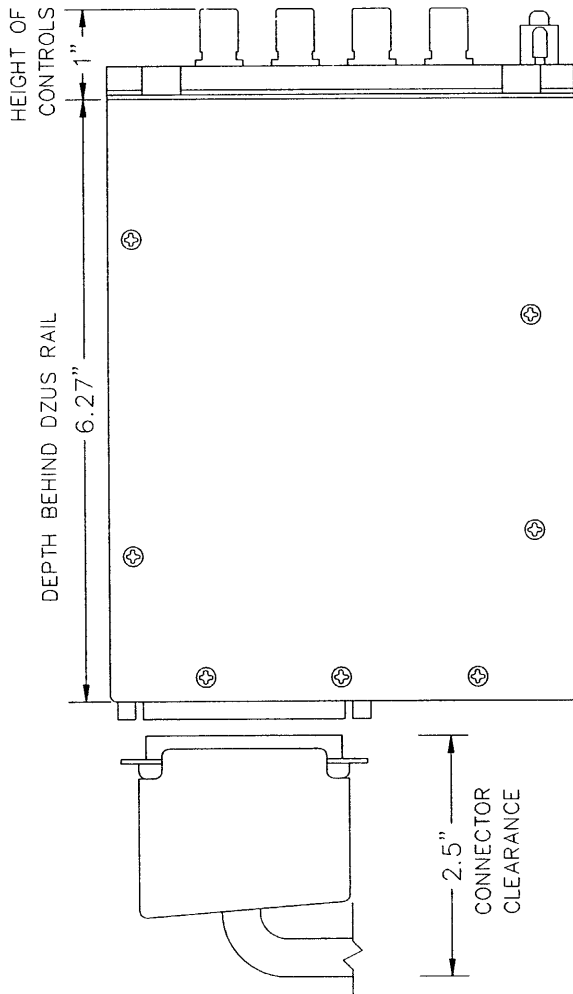

TH450 RIGHT SIDE VIEW

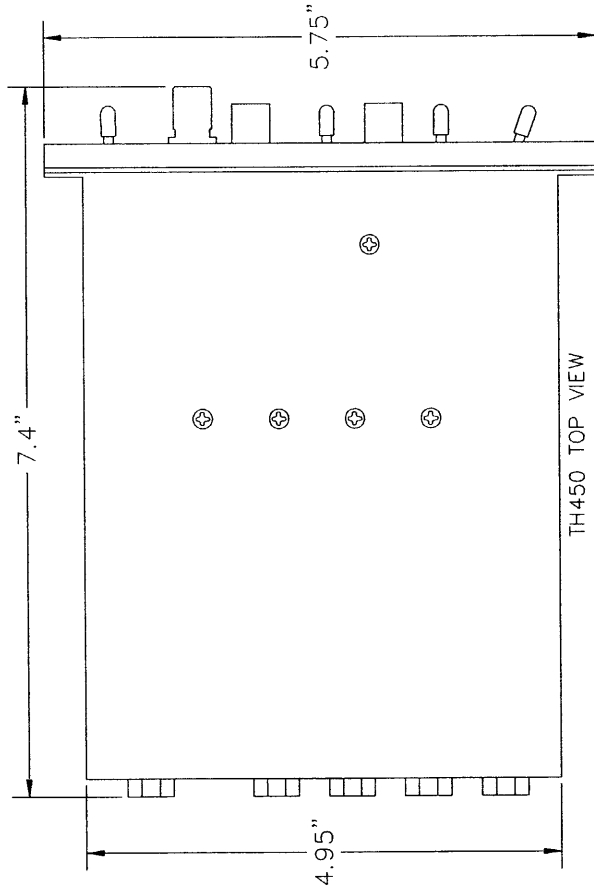

TH450 TOP VIEW

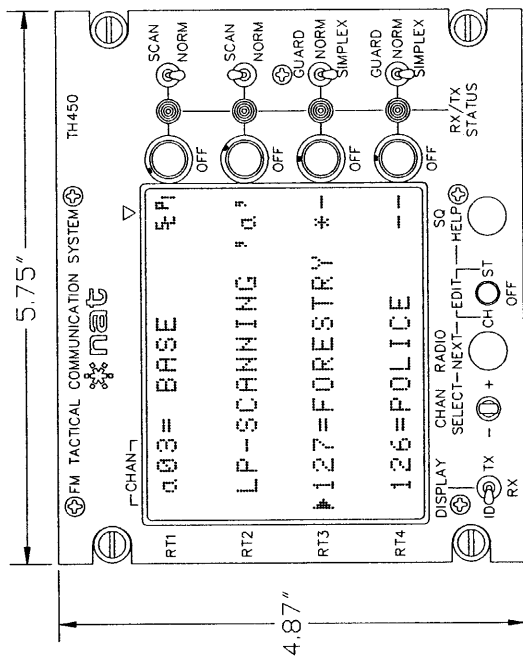

TH450 FRONT VIEW

PLAN VIEW OF A TH450 SERIES CONTROL HEAD.

Confidential and Proprietary to NAT

REVISION	DATE	DESCRIPTION	PART NUMBER	DRAWING NUMBER
			TH450-2NNFF	TH450\NNFF303



APPROVED BY: SCOTT MOORE
 DRAWN BY: SCOTT MOORE
 DATE: 24 JUNE 91

NAT
 QA 100

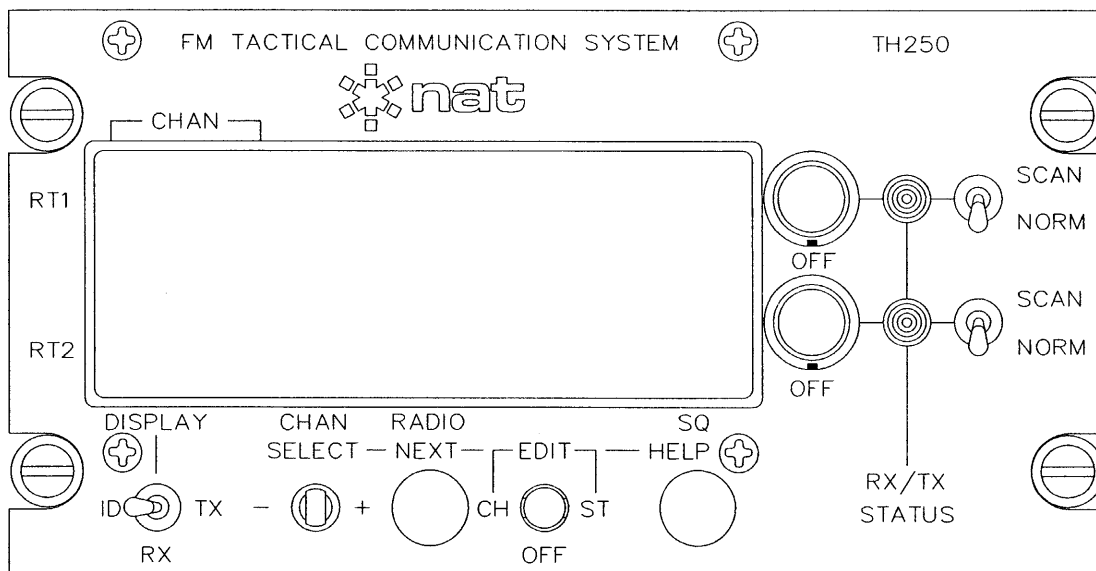
REVISIONS			
REV	DESCRIPTION	DATE	BY
1.01	FORMAT CHANGES ONLY	FEB 8/96	TGM





Confidential and Proprietary to NAT

DESIGNED	MQS/DV	 NAT NORTHERN AIRBORNE TECHNOLOGY LTD.				
DRAWN	TGM					
DATE	OCT 31/95	TITLE TAC/COM CONTROL HEAD				
CHECKED						
APPROVED		SIZE A	CAGE CODE 3AB01	PART NO. TH250-xNN	REV. 1.01	SHEET 1/2
FILE	905-0101.DWG	DWG. TYPE	FACEPLATE	DWG. NO. TH250\NN\905-0		

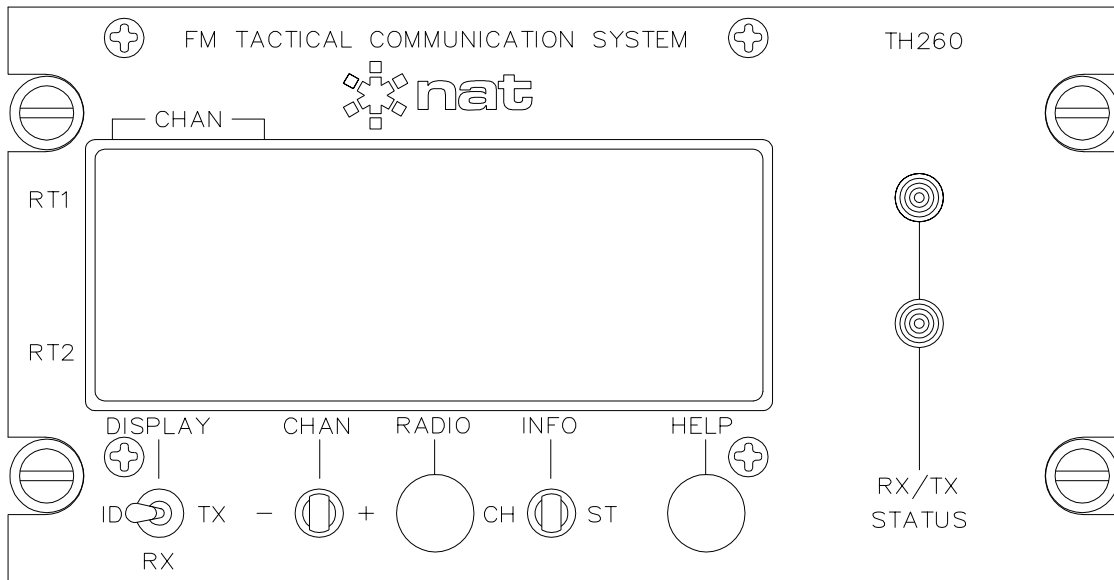
REVISIONS			
REV	DESCRIPTION	DATE	BY
1.01	ECR #630 CORRECTED LIGHT HOLE LOCATIONS	JAN 10/97	TGM



Confidential and Proprietary to NAT

DESIGNED	MQS/DV	 NORTHERN AIRBORNE TECHNOLOGY LTD.				
DRAWN	TGM					
DATE	FEB 7/96	TITLE	TAC/COM II SLAVE CONTROL HEAD			
CHECKED	NAT PROD					
	145					
APPROVED		SIZE	CAGE CODE	PART NO.	REV.	SHEET
		A	3AB01	TH260	1.01	1/2
FILE	905-0101.DWG	DWG. TYPE	FACEPLATE	DWG. NO.	TH260\905-0	

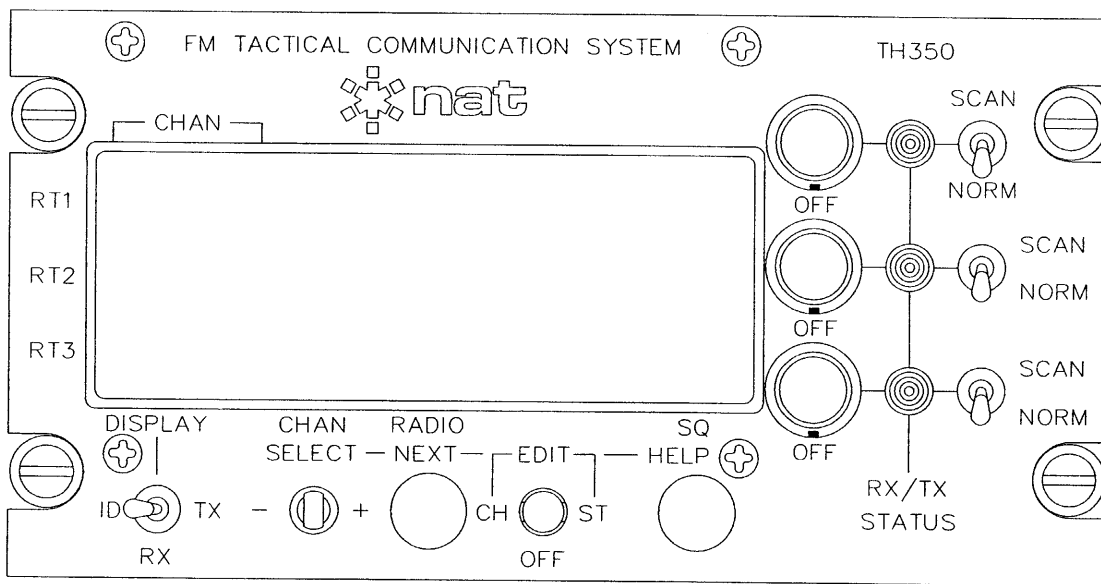

Confidential and Proprietary to NAT

REVISION	DATE	*nat NORTHERN AIRBORNE TECHNOLOGY LTD.			
1.00	DEC 1/95	DESIGNED BY	DESCRIPTION		
		MQS/DV	TAC/COM CONTROL HEAD		
		DRAWN BY	PART NUMBER	DRAWING TYPE	SHEET
		T. MASTERS	TH350-xNNN	FACEPLATE	1/2
		APPROVED BY	DRAWING NUMBER	FILE NUMBER	
		NAT 107	TH350\xNNN\905-0	TH350\xNNN\905-0100	

REVISIONS			
REV	DESCRIPTION	DATE	BY
1.10	LED SPACING	MAY 6/96	MWS

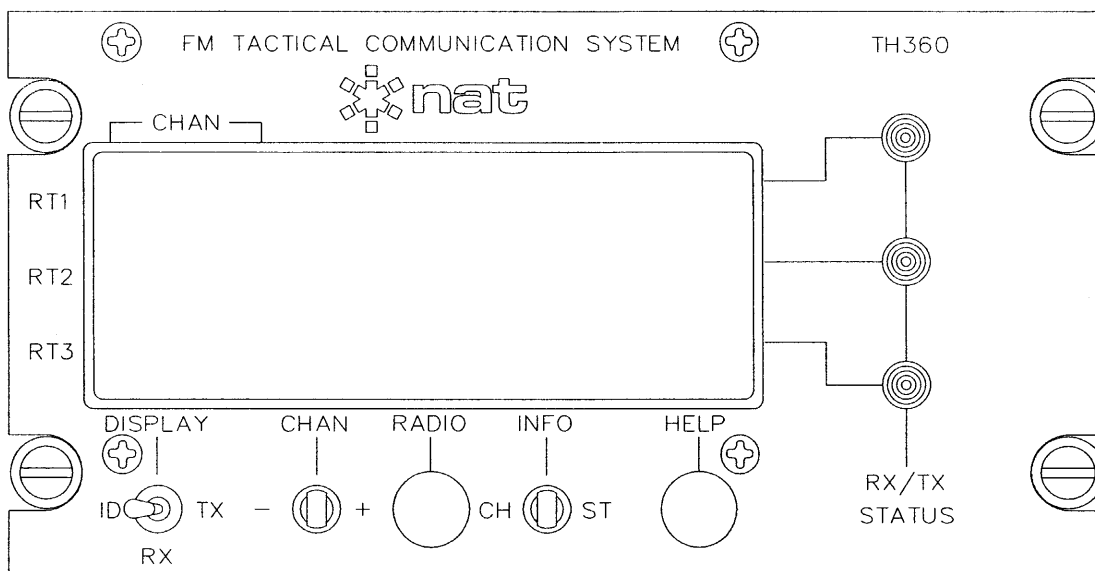

Confidential and Proprietary to NAT

DESIGNED	MQS/DV	NORTHERN AIRBORNE TECHNOLOGY LTD.				
DRAWN	TGM					
DATE	FEB 7/96	TITLE TAC/COM II SLAVE CONTROL HEAD				
CHECKED						
APPROVED		SIZE	CAGE CODE	PART NO.	REV.	SHEET
		A	3AB01	TH360	1.10	1/2
FILE	905-0110.DWG	DWG. TYPE	FACEPLATE	DWG. NO.	TH360\905-0	

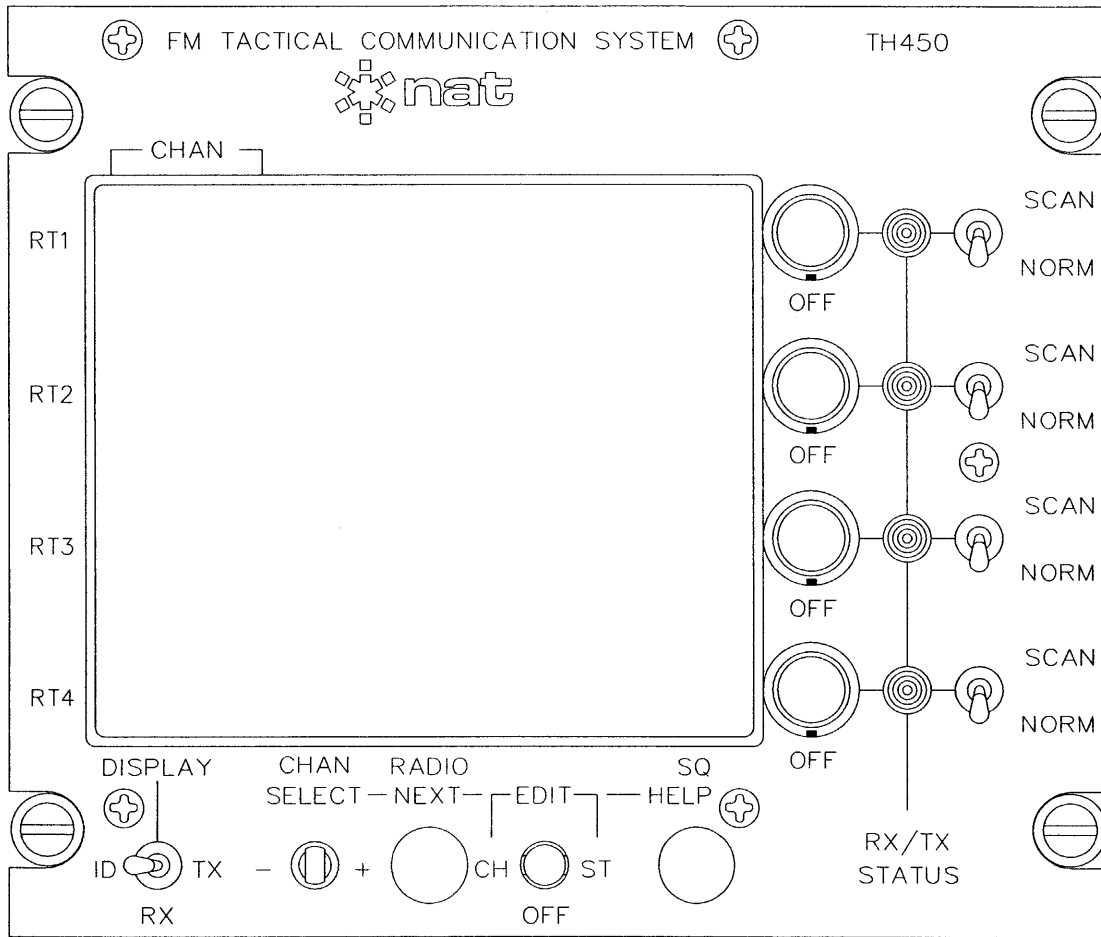

Confidential and Proprietary to NAT

DESIGNED	MQS	NORTHERN AIRBORNE TECHNOLOGY LTD.				
DRAWN	MWS					
DATE	JAN 23/96	TITLE				
CHECKED	NAT PROD. 145	CUSTOM TAC/COM II CONTROL HEAD				
APPROVED		SIZE	CAGE CODE	PART NO.	REV.	SHEET
		A	3AB01	TH450-xNNNN	1.00	1/2
FILE	905-0100.DWG	DWG. TYPE	FACEPLATE	DWG. NO. TH450\NNNN\905-0		

REVISIONS

REV	DESCRIPTION	DATE	BY
1.01	ECR #1395 - CORRECTED LIGHT HOLES, ADDED MISSING SCREW, FORMAT CHANGES.	APR 13/99	TAT

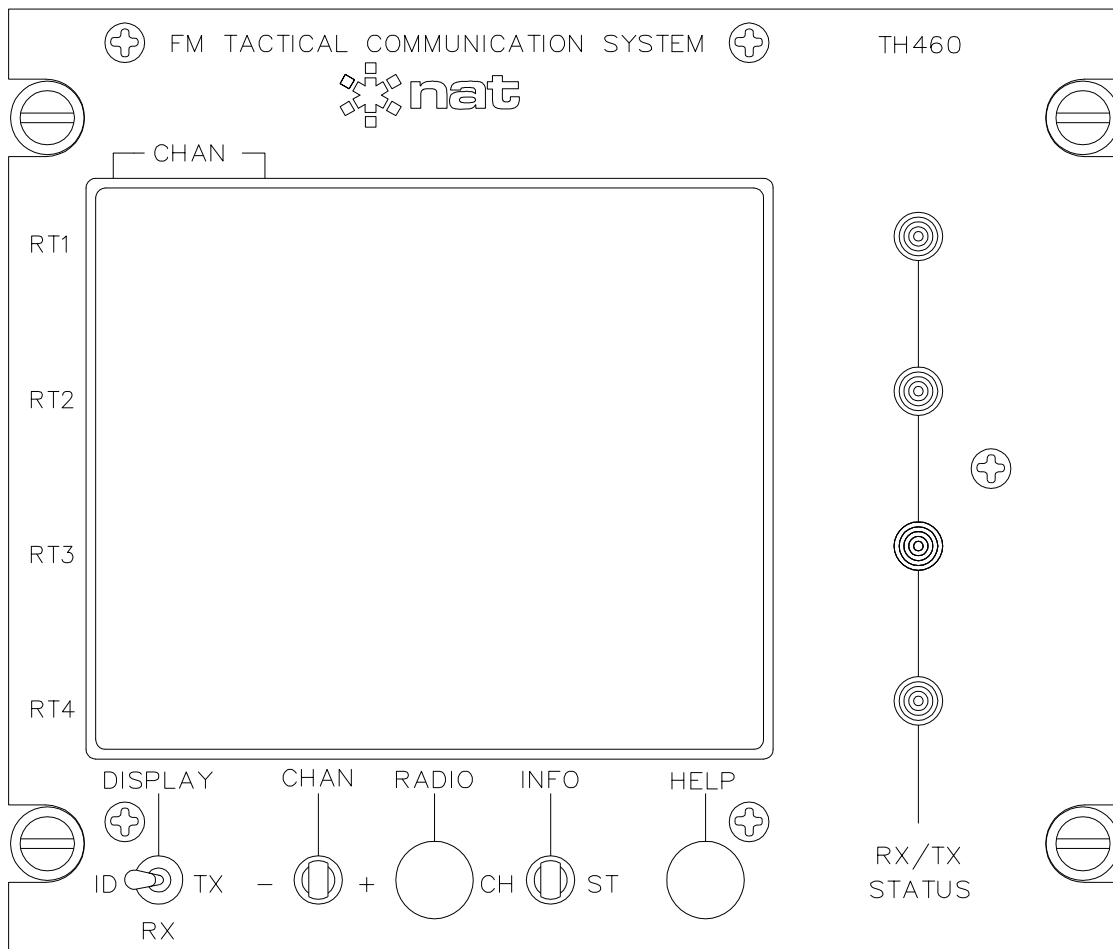

PROPRIETARY AND CONFIDENTIAL TO NAT LTD.

DESIGNED	MQS	NORTHERN AIRBORNE TECHNOLOGY LTD.				
DRAWN	TGM/MWS					
DATE	FEB 7/96	TITLE				
CHECKED	NAT PROD 145 214	TAC/COM II SLAVE CONTROL HEAD				
APPROVED	NAT 107	SIZE	CAGE CODE	PART NO.	REV.	SHEET
FILE	905-0101.DWG	A	3AB01	TH460	1.01	1/2
DWG. TYPE		FACEPLATE		DWG. NO. TH460\905-0		

FACE PLATE DRAWING OF A NAT TAC/COM I CONTROL HEAD

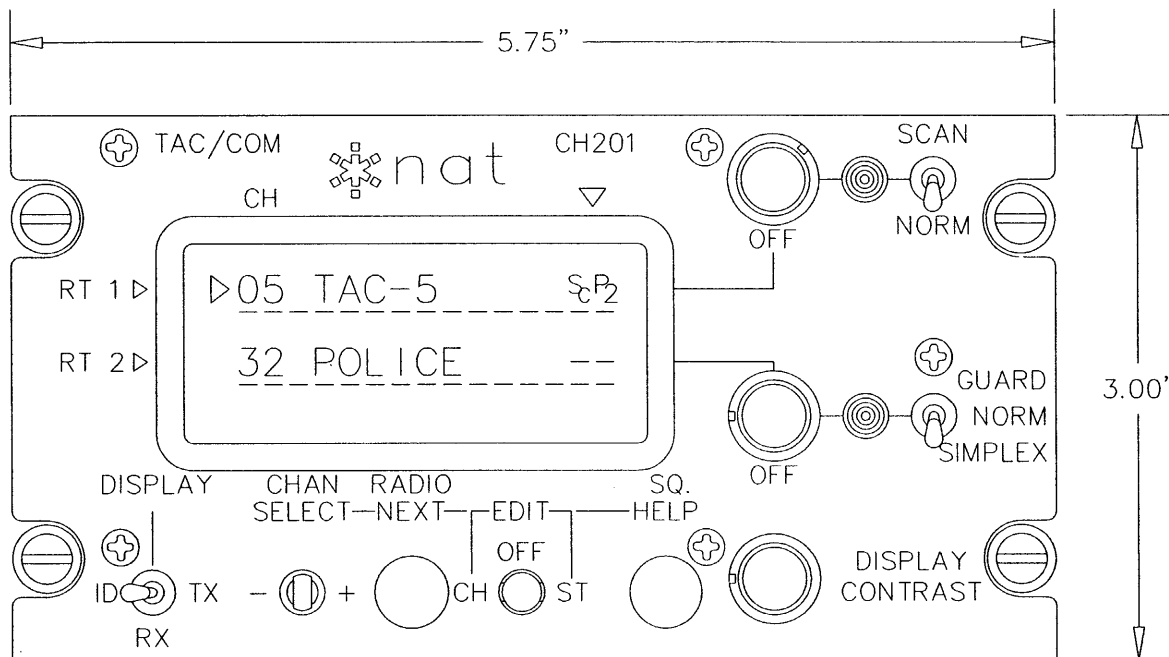

Confidential and Proprietary to NAT

REVISION	DATE	NORTHERN AIRBORNE TECHNOLOGY LTD. 1925 KIRSCHNER RD. KELOWNA, B.C.		
		DESCRIPTION	PART NUMBER	DRAWING NUMBER
		FACEPLATE	CH201	CH200\NF905
		DATE	DRAWN BY	APPROVED BY
		21 JUNE 1991	MITCH Q. STINSON	NAT QA 100

FACEPLATE DRAWING OF A NAT TAC/COM 1 CONTROL HEAD

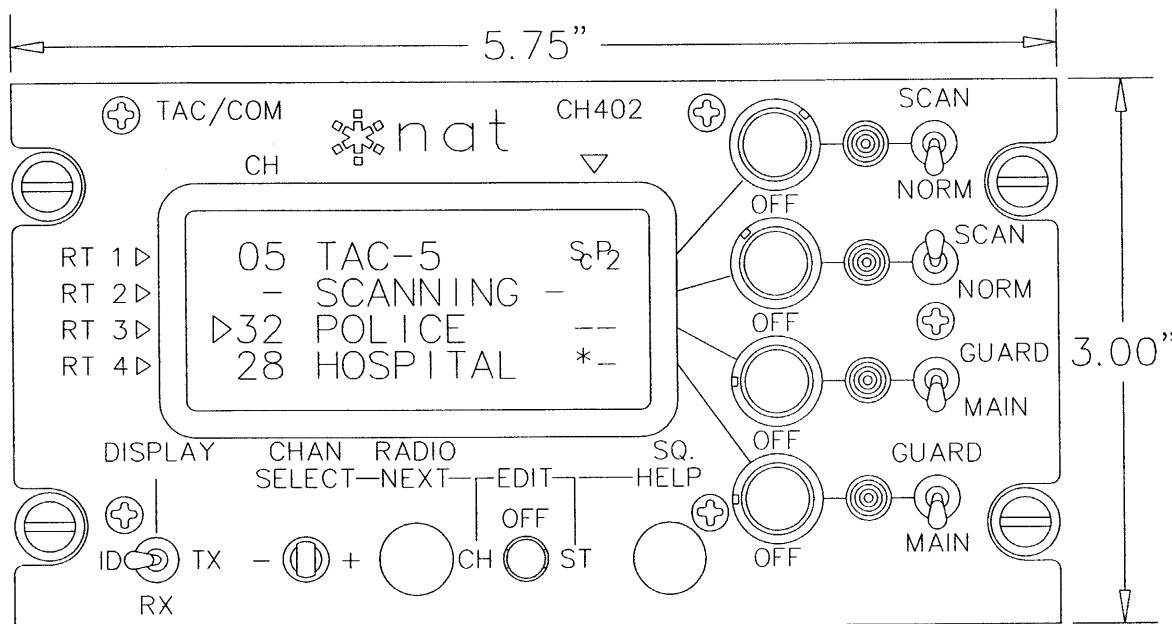

Confidential and Proprietary to NAT

REVISION	DATE	NORTHERN AIRBORNE TECHNOLOGY LTD. 1925 KIRSCHNER RD. KELOWNA, B.C.		
		DESCRIPTION	PART NUMBER	DRAWING NUMBER
		FACEPLATE	CH402	CH400\NNRR905
		DATE	DRAWN BY	APPROVED BY
		21 JUNE 1991	MITCH Q. STINSON	NAT QA 100

INTERCONNECT DRAWING FOR THE TAC/COM I CONTROL HEAD SYSTEM CONNECTOR
 (POWER SUPPLY CARDS CH400-1 REV A & B)

TAC\COM I

This drawing is for Tac/Com I Control Heads with serial numbers: 1001 to 1043

TAC/COM I CONTROL HEAD
 SYSTEM CONNECTOR
 P100 = DB25S

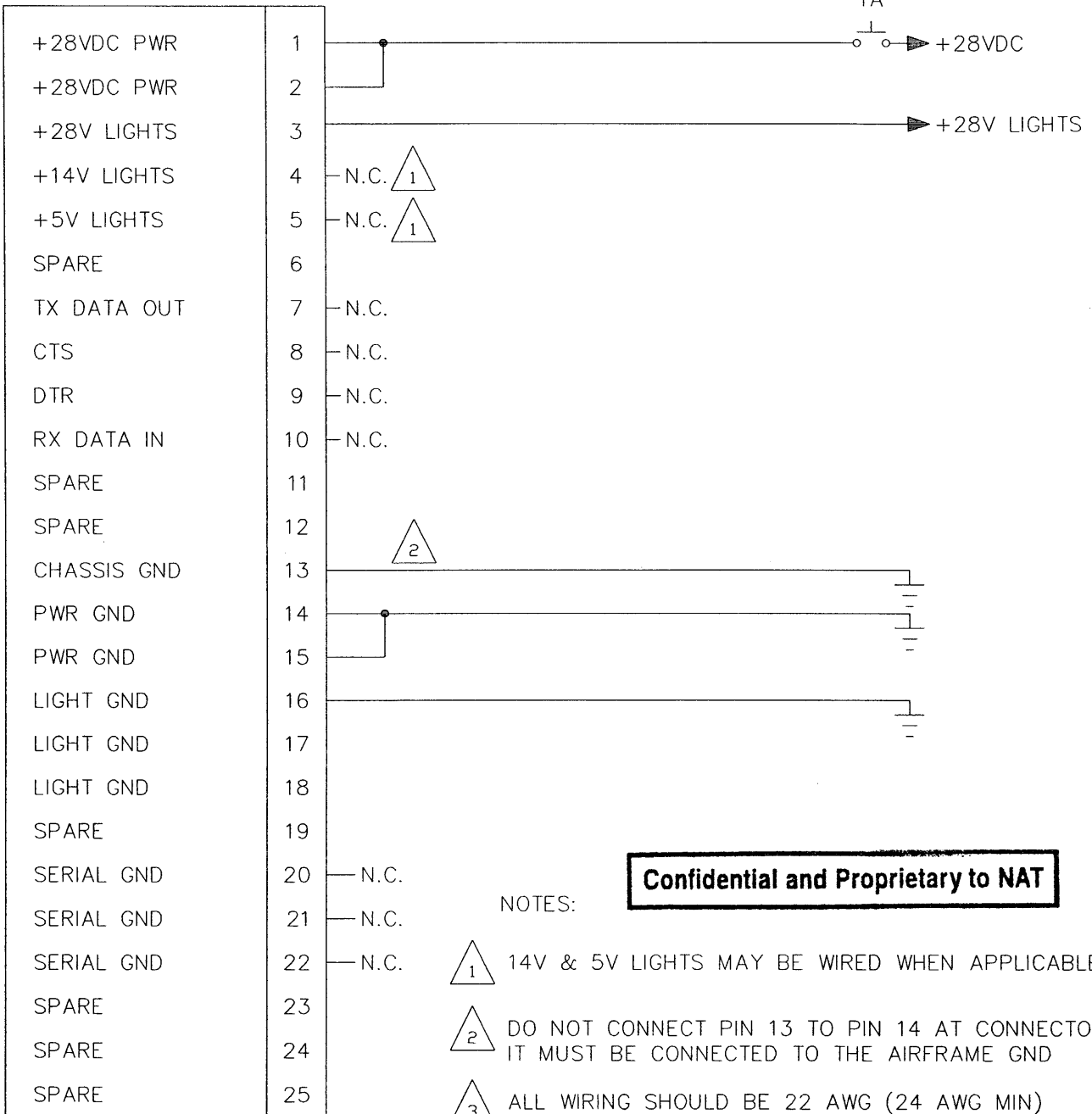

Confidential and Proprietary to NAT

NOTES:

- 1 14V & 5V LIGHTS MAY BE WIRED WHEN APPLICABLE
- 2 DO NOT CONNECT PIN 13 TO PIN 14 AT CONNECTOR IT MUST BE CONNECTED TO THE AIRFRAME GND
- 3 ALL WIRING SHOULD BE 22 AWG (24 AWG MIN) EXCEPT POWER AND GROUND MUST BE 20 AWG.

FOR REFERENCE ONLY, SEE DRAWING CH402-1\403 FOR NEW CONTROL HEAD INSTALLATIONS.

REVISION	DATE	NORTHERN AIRBORNE TECHNOLOGY LTD. 1925 KIRSCHNER RD. KELOWNA, B.C.		
		PART NUMBER	DRAWING NUMBER	FILE NUMBER
		CH400-1	CH400-1\403-1	CH400-1\403-1
		DESCRIPTION	SHEET	DATE
		INTERCONNECT	1 OF 1	20 AUG 93
		DESIGNED BY	DRAWN BY	APPROVED BY
			SCOTT MOORE	NAT PROD
				119

INTERCONNECT DRAWING FOR THE TAC/COM I CONTROL HEAD SYSTEM CONNECTOR
(POWER SUPPLY CARD CH400-1 REV B & C)

TAC/COM I

This drawing is for Tac/Com I (CH-SERIES) Control Heads with serial numbers: 1044 to 1127

TAC/COM I CONTROL HEAD SYSTEM CONNECTOR
P100 = DB25S

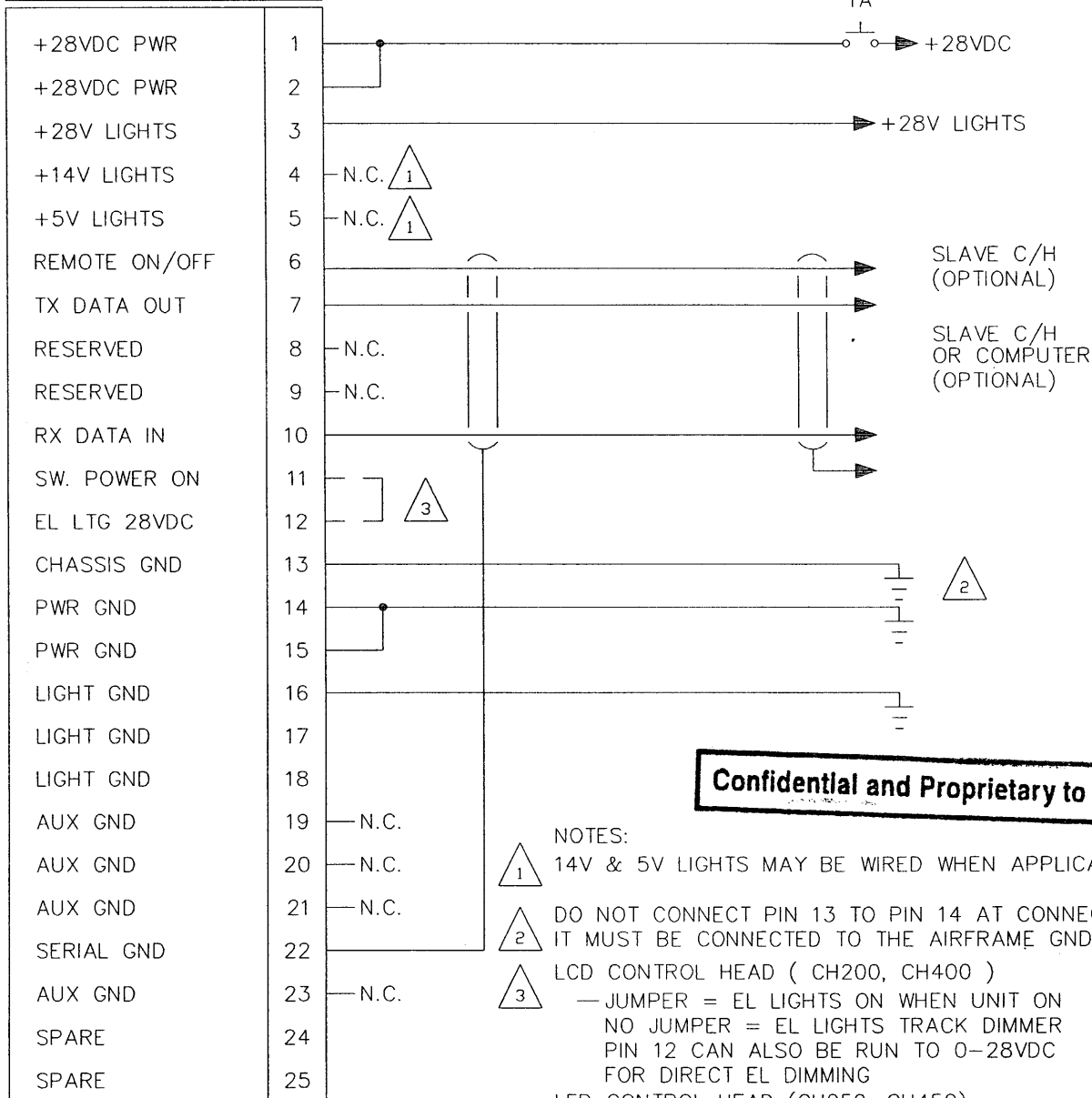

Confidential and Proprietary to NAT

- NOTES:
- 1 14V & 5V LIGHTS MAY BE WIRED WHEN APPLICABLE
 - 2 DO NOT CONNECT PIN 13 TO PIN 14 AT CONNECTOR IT MUST BE CONNECTED TO THE AIRFRAME GND
 - 3 LCD CONTROL HEAD (CH200, CH400)
— JUMPER = EL LIGHTS ON WHEN UNIT ON
NO JUMPER = EL LIGHTS TRACK DIMMER
PIN 12 CAN ALSO BE RUN TO 0-28VDC FOR DIRECT EL DIMMING
 - LED CONTROL HEAD (CH250, CH450)
— DO NOT INSTALL EL LIGHTING
 - 4 ALL WIRING SHOULD BE 22 AWG (24 AWG MIN.) EXCEPT POWER AND GROUND MUST BE 20 AWG.

FOR REFERENCE ONLY, SEE DRAWING CH402-1\403 FOR NEW INSTALLATIONS.

		NORTHERN AIRBORNE TECHNOLOGY LTD. 1925 KIRSCHNER RD. KELOWNA, B.C.		
REVISION	DATE	PART NUMBER	DRAWING NUMBER	FILE NUMBER
		CH400-1	CH400-1\403-2	CH400-1\403-2
		DESCRIPTION	SHEET	DATE
		INTERCONNECT	1 OF 1	20 AUG 1993
		DESIGNED BY	DRAWN BY	APPROVED BY
		MQS	SCOTT MOORE	NAT PROD 119

INTERCONNECT DRAWING FOR THE TAC/COM I CONTROL HEAD SYSTEM CONNECTOR
 (POWER SUPPLY CARD CH402-1 REV A,B)

TAC/COM I

This drawing is for Tac/Com I (CH-SERIES) Control Heads with serial numbers starting at 1128

TAC/COM I CONTROL HEAD
 SYSTEM CONNECTOR
 P100 = DB25S

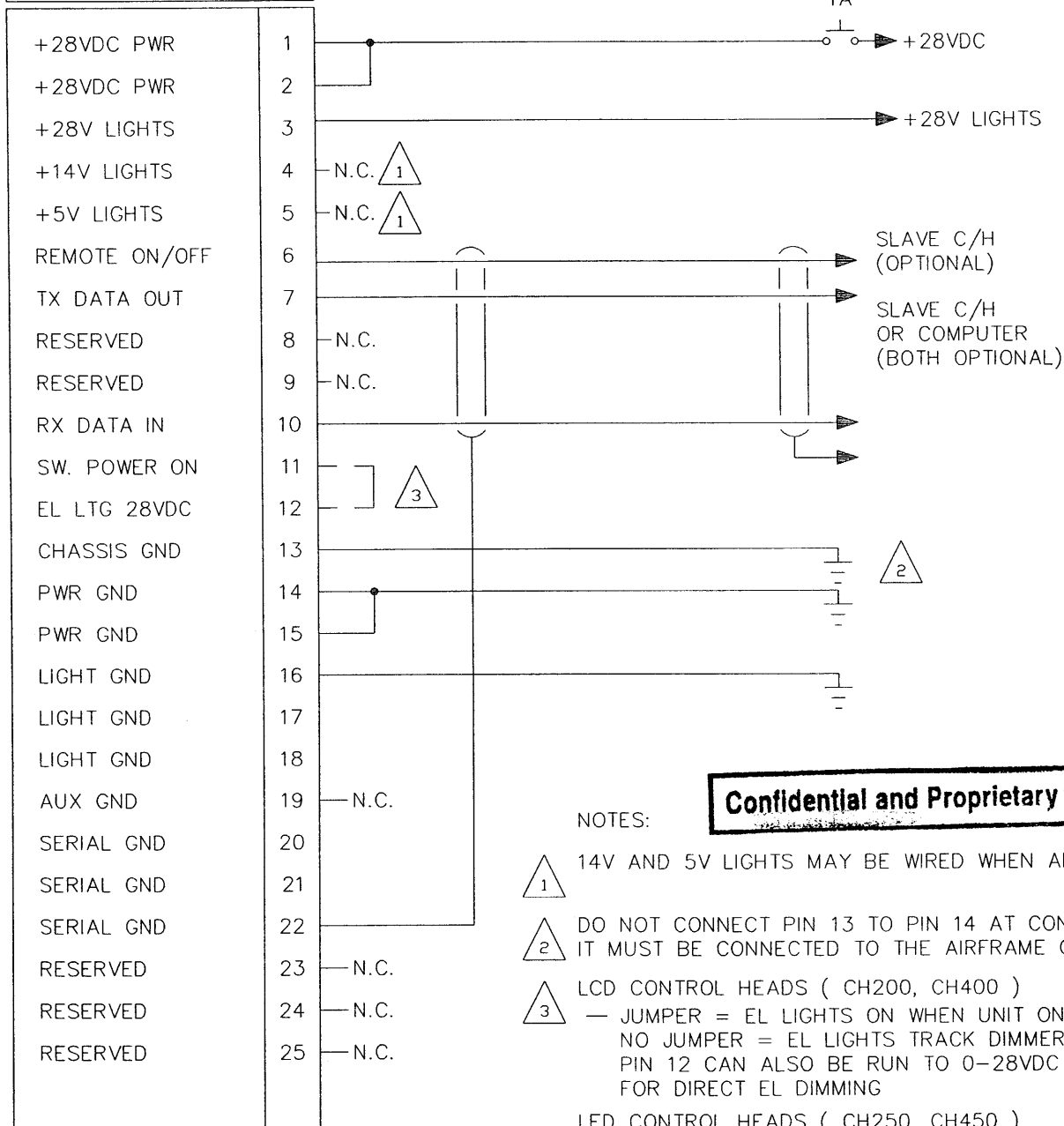

Confidential and Proprietary to NAT

NOTES:

- 1 14V AND 5V LIGHTS MAY BE WIRED WHEN APPLICABLE.
- 2 DO NOT CONNECT PIN 13 TO PIN 14 AT CONNECTOR IT MUST BE CONNECTED TO THE AIRFRAME GND
- 3 LCD CONTROL HEADS (CH200, CH400)
 — JUMPER = EL LIGHTS ON WHEN UNIT ON
 NO JUMPER = EL LIGHTS TRACK DIMMER
 PIN 12 CAN ALSO BE RUN TO 0-28VDC FOR DIRECT EL DIMMING
- LED CONTROL HEADS (CH250, CH450)
 — DO NOT INSTALL EL LIGHTING VOLTAGE.
- 4 ALL WIRING SHOULD BE 22 AWG (24 AWG MIN.) EXCEPT POWER AND GROUND MUST BE 20 AWG.

REVISION	DATE	NORTHERN AIRBORNE TECHNOLOGY LTD. 1925 KIRSCHNER RD. KELOWNA, B.C.		
A	24 JUNE 91	PART NUMBER	DRAWING NUMBER	FILE NUMBER
B	16 AUG 93	CH402-1	CH402-1\403	CH402-1\403B
		DESCRIPTION	SHEET	DATE
		INTERCONNECT	1 OF 1	10 FEB 1991
		DESIGNED BY	DRAWN BY	APPROVED BY
		MQS	SCOTT MOORE	NAT PROD

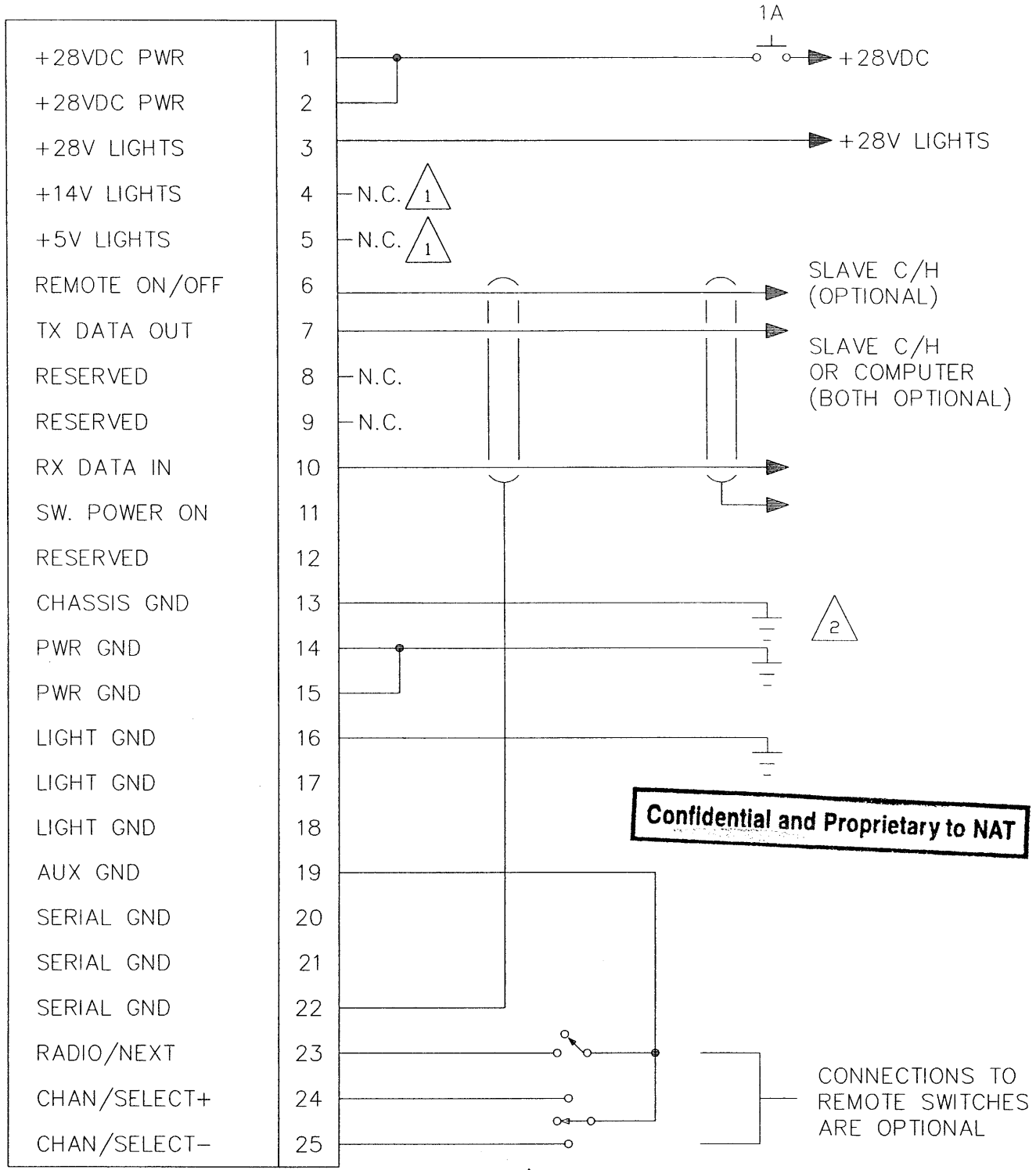

TAC/COM II CONTROL HEAD
SYSTEM CONNECTOR
DB25S

- NOTES:
- 1 14V AND 5V LIGHTS MAY BE WIRED WHEN APPLICABLE.
 - 2 DO NOT CONNECT PIN 13 TO PIN 14 AT CONNECTOR IT MUST BE CONNECTED TO THE AIRFRAME GROUND.
 - 3 ALL WIRING SHOULD BE 22 AWG. (24 AWG MIN.) EXCEPT POWER AND GROUND MUST BE 20 AWG.

		*nat NORTHERN AIRBORNE TECHNOLOGY LTD.			
REVISION	DATE	DESIGNED BY	DESCRIPTION		
-	SEP 28/89	MQS	TAC/COM CONTROL HEAD POWER SUPPLY		
A	JUN 24/91	MQS	TAC/COM CONTROL HEAD POWER SUPPLY		
B	AUG 16/93	DRAWN BY	PART NUMBER	DRAWING TYPE	SHEET
1.03	JUL 10/95	MQS	CH402-1	INTERCONNECT	1/1
		APPROVED BY	DRAWING NUMBER	FILE NUMBER	
		NAT R&D	TH402-1\403-0	TH402-1\403-0103	

INTERCONNECT DRAWING FOR CONNECTING A TAC/COM I MASTER CONTROL HEAD TO A TAC/COM I SLAVE CONTROL HEAD.

(POWER SUPPLY CARDS CH400-1 REV A,B,C)

This drawing is for TAC/COM I (CH-Series) Control Heads with serial numbers from 1044 to 1127.

Confidential and Proprietary to NAT

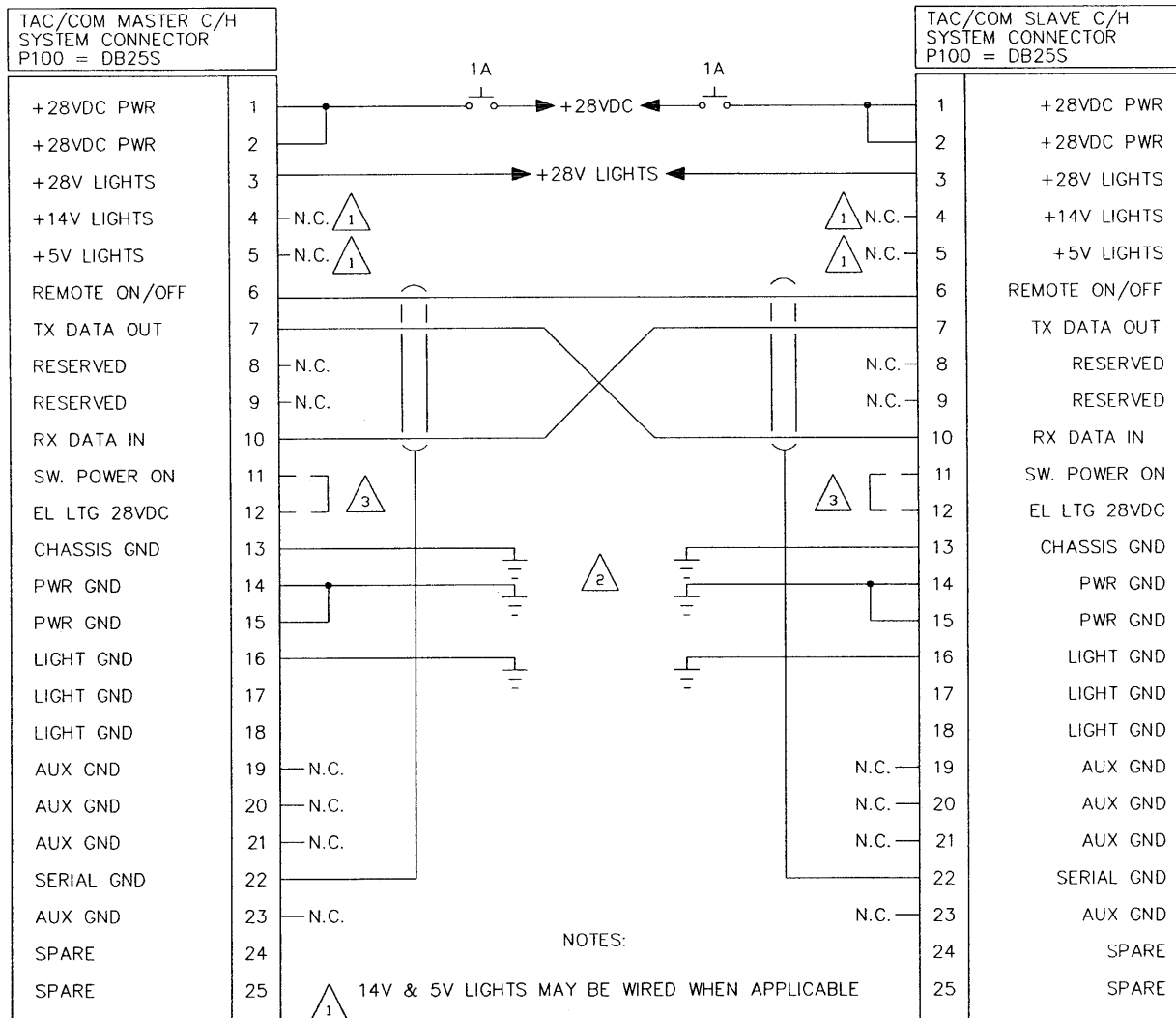

NOTES:

- 1 14V & 5V LIGHTS MAY BE WIRED WHEN APPLICABLE
- 2 DO NOT CONNECT PIN 13 TO PIN 14 AT CONNECTOR IT MUST BE CONNECTED TO THE AIRFRAME GND
- 3 CH200, CH300, CH400 (LCD CONTROL HEADS) ONLY
 JUMPER = EL LIGHTS ON WHEN UNIT ON
 NO JUMPER = EL LIGHTS TRACK DIMMER
 PIN 12 CAN ALSO BE RUN TO 0-28VDC FOR DIRECT EL DIMMING
- 1 ALL WIRING SHOULD BE 22 AWG (24 AWG MIN) EXCEPT POWER AND GROUND MUST BE 20 AWG.

REVISION		DATE		NORTHERN AIRBORNE TECHNOLOGY LTD. 1925 KIRSCHNER RD. KELOWNA, B.C.		
A		24	JUNE	91	PART NUMBER	DRAWING NUMBER
B		27	AUG	93	CH410	CH410\403
					DESCRIPTION	FILE NUMBER
					INTERCONNECT	CH410
					DESIGNED BY	SHEET
					MQS	DATE
					MITCH Q. STINSON	OCT 24/88
						APPROVED BY
						NAT PROD

INTERCONNECT DRAWING FOR CONNECTING A TAC/COM MASTER CONTROL HEAD TO A TAC/COM SLAVE CONTROL HEAD.
 (POWER SUPPLY CARDS CH402-1 REV A,B)
 This drawing is for all TAC/COM II Control Heads.

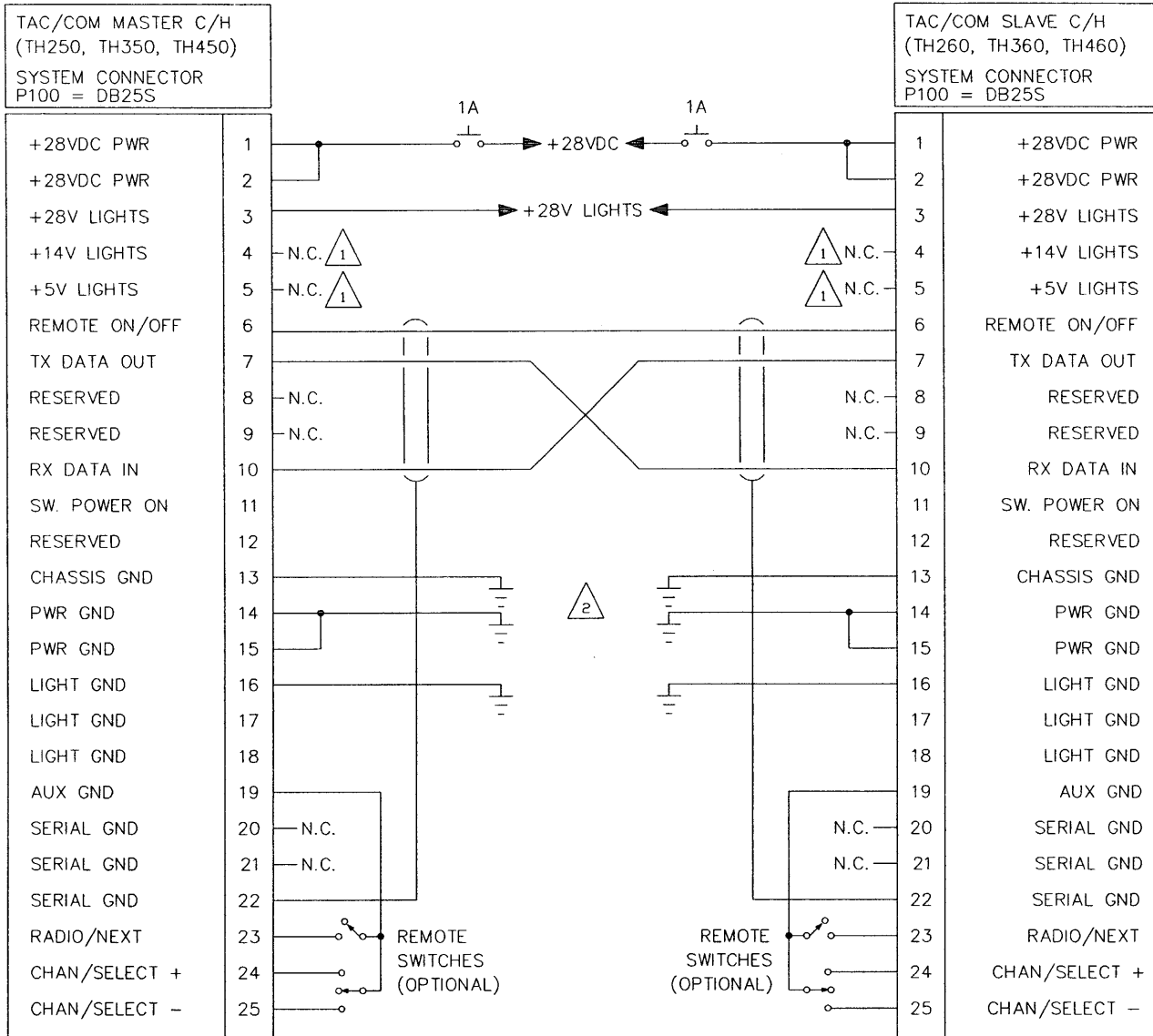

- NOTES:
- 1 14V & 5V LIGHTS MAY BE WIRED WHEN APPLICABLE
 - 2 DO NOT CONNECT PIN 13 TO PIN 14 AT CONNECTOR IT MUST BE CONNECTED TO THE AIRFRAME GND
 - 3 ALL WIRING SHOULD BE 22 AWG (24 AWG MIN) EXCEPT POWER AND GROUND MUST BE 20 AWG.

Confidential and Proprietary to NAT

REVISION	DATE	NORTHERN AIRBORNE TECHNOLOGY LTD. 1925 KIRSCHNER RD. KELOWNA, B.C.		
A	20 AUG 93	PART NUMBER	DRAWING NUMBER	FILE NUMBER
		TH450, TH460	TH460\403	TH460\403A
		DESCRIPTION	SHEET	DATE
		INTERCONNECT	1 OF 1	24 JUNE 91
		DESIGNED BY	DRAWN BY	APPROVED BY
			SCOTT MOORE	NAT PROD

INTERCONNECT DRAWING FOR CONNECTING A TAC/COM MASTER CONTROL HEAD, A TAC/COM SLAVE CONTROL HEAD WITH SERIAL I/O INTERFACE CARD, AND A DTE-12 TONE ENCODER / DATA ENTRY PAD.

(POWER SUPPLY CARDS CH402-1 REV A,B)

This drawing is for all TAC/COM II Control Heads.

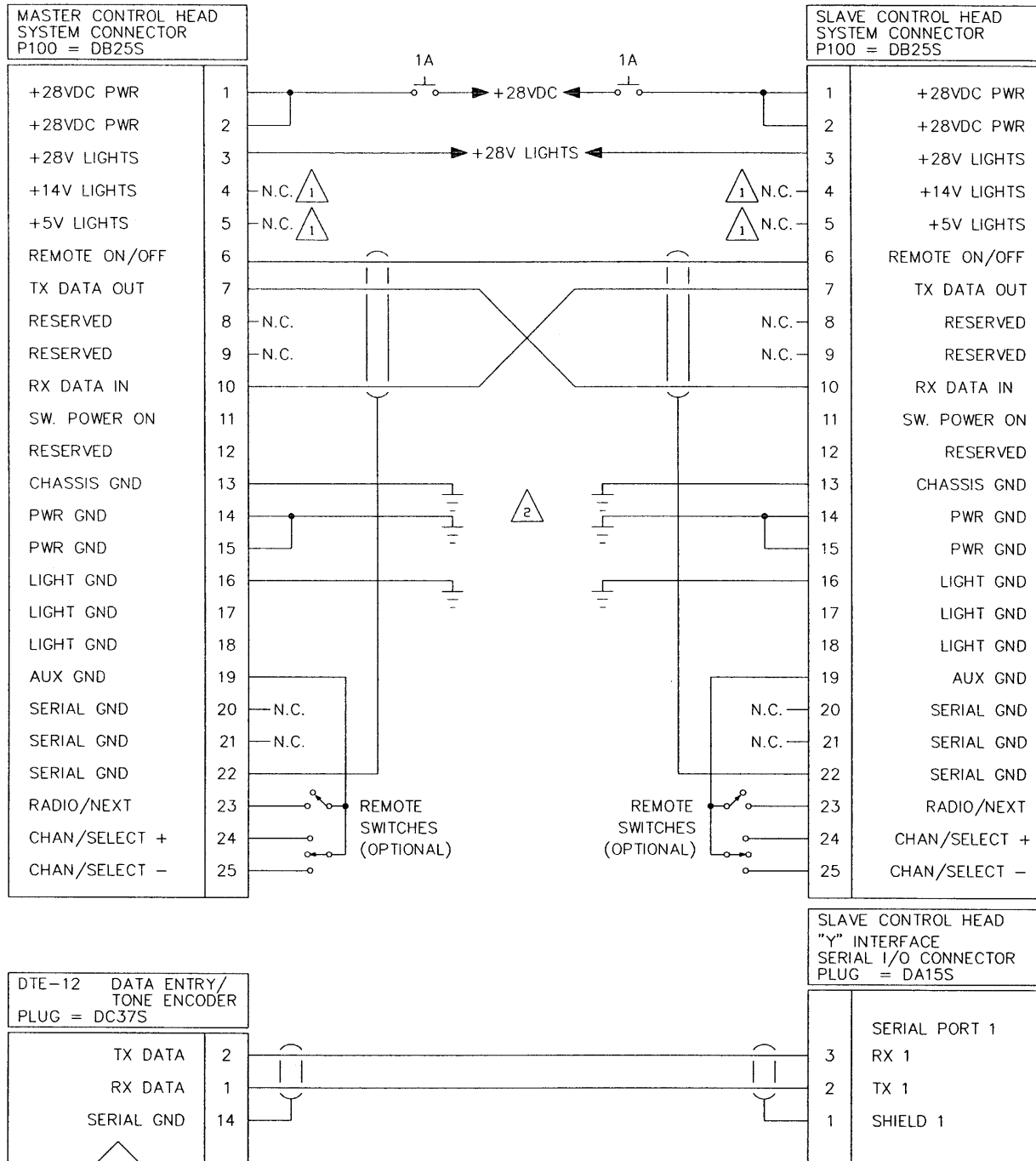

NOTES:

- 1 14V & 5V LIGHTS MAY BE WIRED WHEN APPLICABLE.
- 2 DO NOT CONNECT PIN 13 TO PIN 14 AT THE CONNECTOR. IT MUST BE CONNECTED TO THE AIRFRAME GND.
- 3 ALL WIRING SHOULD BE 22 AWG (24 AWG MIN.) EXCEPT POWER AND GROUND MUST BE 20 AWG.

Confidential and Proprietary to NAT

REVISION		DATE		NORTHERN AIRBORNE TECHNOLOGY LTD. 1925 KIRSCHNER RD. KELOWNA, B.C.		
A		16 AUG 93		PART NUMBER	DRAWING NUMBER	FILE NUMBER
				TH460	TH460\403-1A	TH460\403-1A
				DESCRIPTION	SHEET	DATE
				INTERCONNECT	1 OF 1	15 OCT 91
				DESIGNED BY	DRAWN BY	APPROVED BY
				MQS	SCOTT MOORE	NAT PROD

CONNECTOR MAP FOR THE TAC/COM CONTROL HEAD SYSTEM CONNECTOR
 (POWER SUPPLY CARD CH400-1 REV 'A', 'B')

This Connector Map is for Tac/Com I Control Heads with Serial Numbers: 1001 - 1043

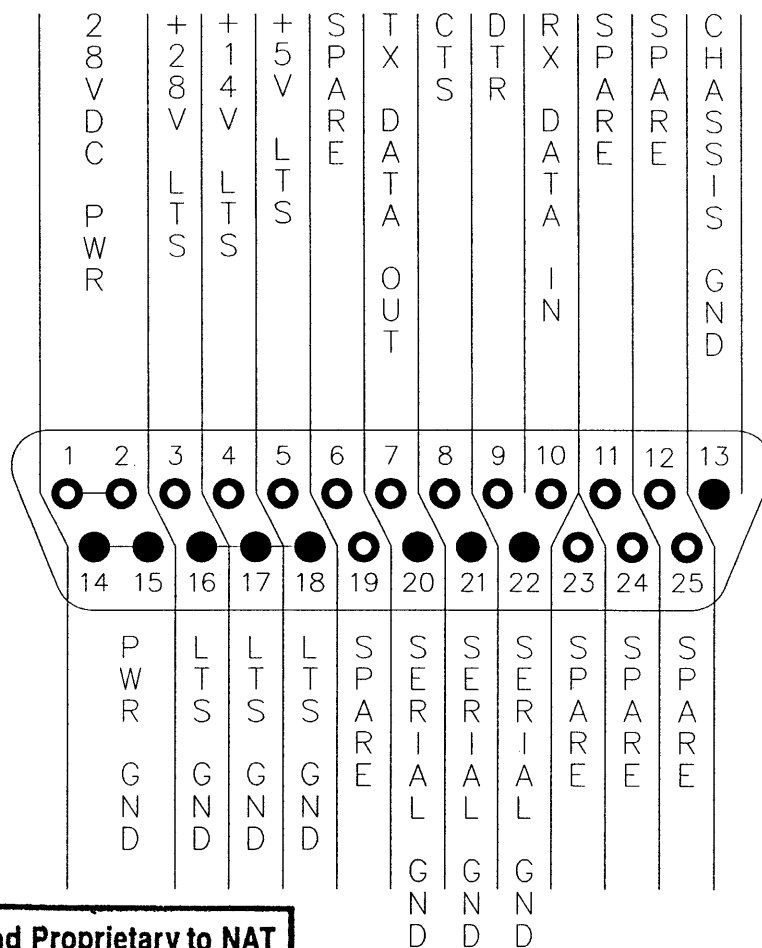

TAC/COM
P100

Confidential and Proprietary to NAT

FOR REFERENCE ONLY, SEE DRAWING CH402-1\405 FOR NEW CONTROL HEAD INSTALLATIONS.

REVISION	DATE	NORTHERN AIRBORNE TECHNOLOGY LTD. 1925 KIRSCHNER RD. KELOWNA, B.C.		
		PART NUMBER	DRAWING NUMBER	FILE NUMBER
		CH400-1	CH400-1\405-1	CH400-1\405-1
		DESCRIPTION	SHEET	DATE
		CONNECTOR MAP	1 OF 1	27 AUG 93
		DESIGNED BY	DRAWN BY	APPROVED BY
		MQS	SCOTT MOORE	NAT PROD

CONNECTOR MAP FOR THE TAC/COM CONTROL HEAD SYSTEM CONNECTOR
 (POWER SUPPLY CARD CH400-1 REV 'B','C')

This Connector Map is for Tac/Com I Control Heads with Serial Numbers: 1044 to 1127

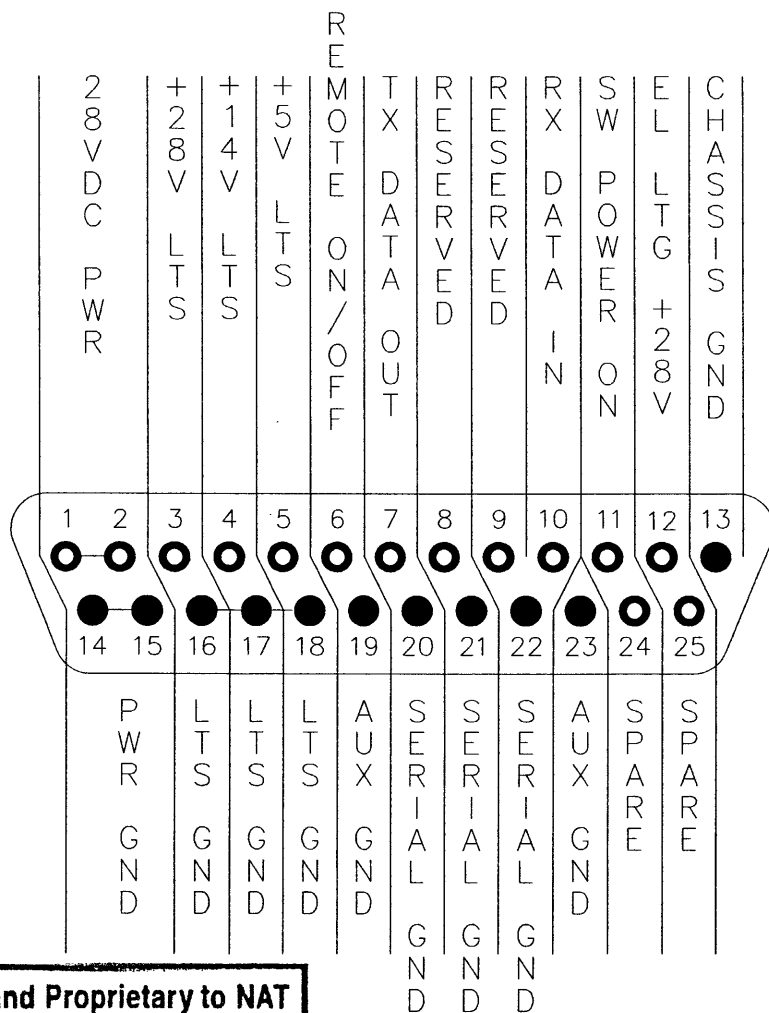

Confidential and Proprietary to NAT

FOR REFERENCE ONLY, SEE DRAWING CH402-1\405 FOR NEW CONTROL HEAD INSTALLATIONS.

REVISION	DATE	NORTHERN AIRBORNE TECHNOLOGY LTD. 1925 KIRSCHNER RD. KELOWNA, B.C.		
		PART NUMBER	DRAWING NUMBER	FILE NUMBER
		CH400-1	CH400-1\405-2	CH400-1\405-2
		DESCRIPTION	SHEET	DATE
		CONNECTOR MAP	1 OF 1	27 AUG 93
		DESIGNED BY	DRAWN BY	APPROVED BY
		MQS	SCOTT MOORE	NAT PROD

Confidential and Proprietary to NAT

CONNECTOR MAP FOR THE TAC/COM CONTROL HEAD SYSTEM CONNECTOR
 (POWER SUPPLY CARD CH402-1 REV 'A','B')

This Connector Map is for Tac/Com I Control Heads with serial numbers starting at 1128

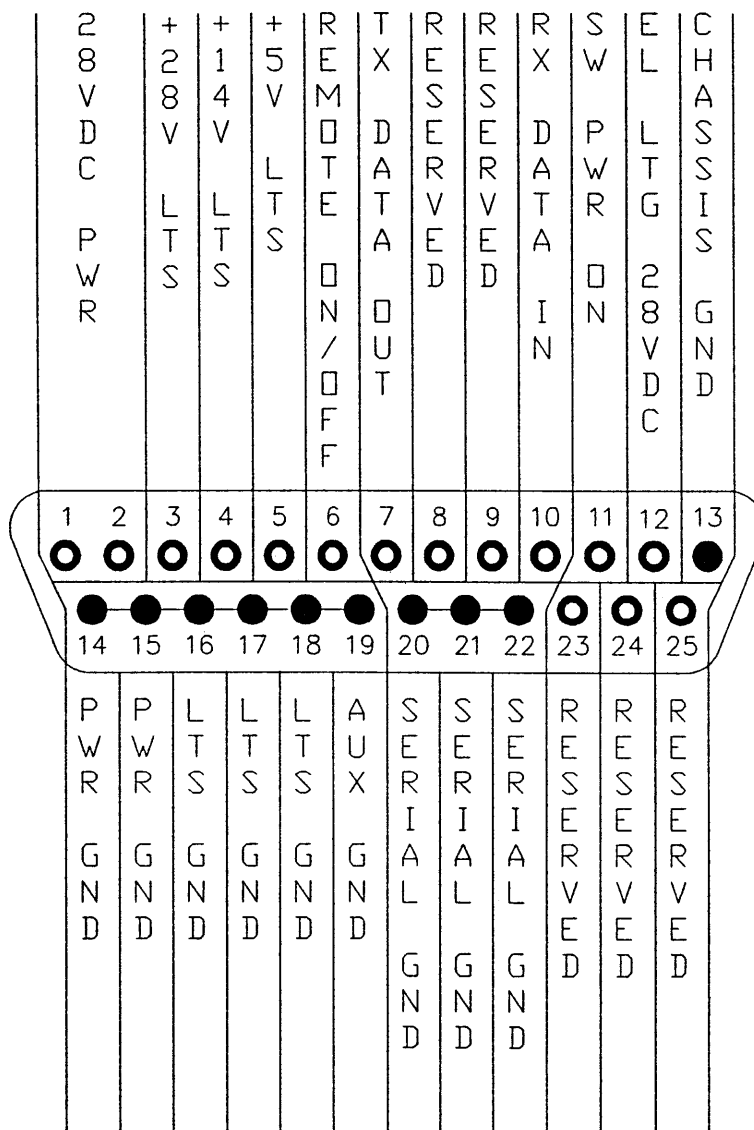

TAC/COM
P100

REVISION	DATE	NORTHERN AIRBORNE TECHNOLOGY LTD. 1925 KIRSCHNER RD. KELOWNA, B.C.		
A	24 JUNE 1991	PART NUMBER	DRAWING NUMBER	FILE NUMBER
B	23 AUG 93	CH402-1	CH402-1\405	CH402-1\405B
		DESCRIPTION	SHEET	DATE
		CONNECTOR MAP	1 OF 1	10 FEB 1991
		DESIGNED BY	DRAWN BY	APPROVED BY
		MQS	SCOTT MOORE	NAT PROD 119

Confidential and Proprietary to NAT

CONNECTOR MAP FOR THE TAC/COM CONTROL HEAD SYSTEM CONNECTOR
 (POWER SUPPLY CARD CH402-1 REV 'A','B')

This Connector Map is for Tac/Com II Control Heads with serial numbers starting at 1001

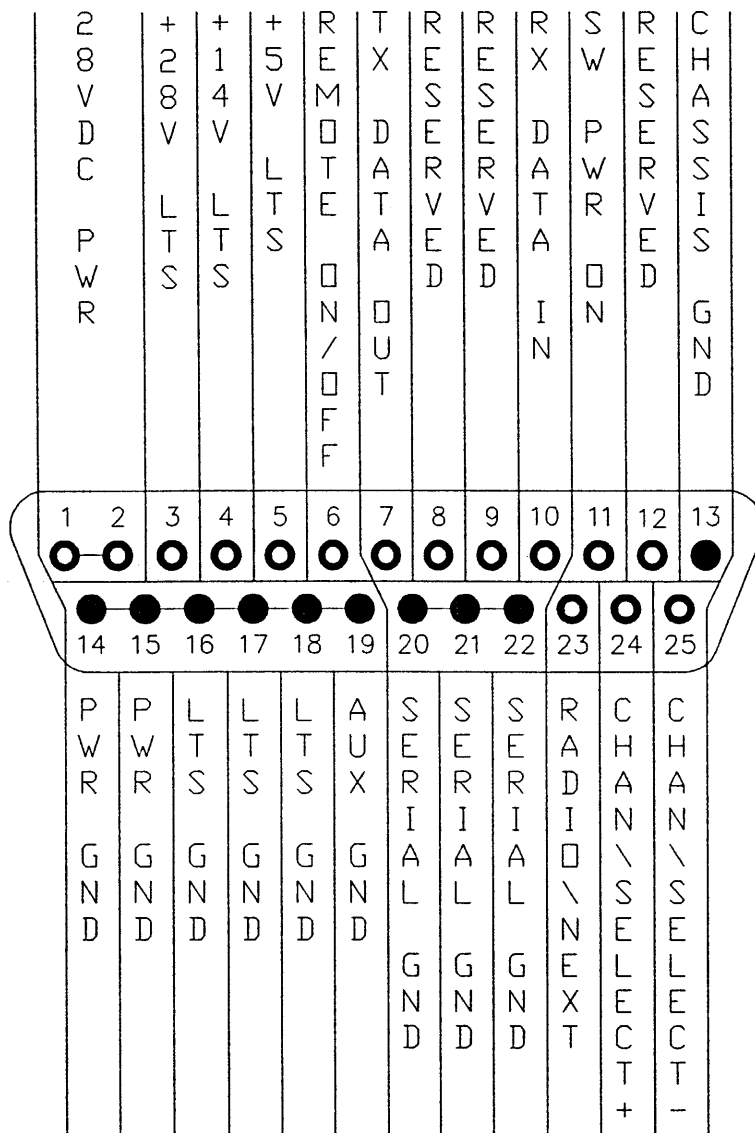

TAC\COM II
P100

REVISION	DATE	NORTHERN AIRBORNE TECHNOLOGY LTD. 1925 KIRSCHNER RD. KELOWNA, B.C.		
A	24 JUNE 1991	PART NUMBER	DRAWING NUMBER	FILE NUMBER
B	23 AUG 1993	TH402-1	TH402-1\405	TH402-1\405B
		DESCRIPTION	SHEET	DATE
		CONNECTOR MAP	1 OF 1	10 FEB 1991
		DESIGNED BY	DRAWN BY	APPROVED BY
		MOS	SCOTT MOORE	NAT PROD

Section 3 Operation

3.1 Introduction

Information in this section consists of the functional and operating procedures for the Tac/Com Control Heads.

3.2 General

To understand the operation of the Tac/Com control, a quick review of basic FM radio operation is helpful here. It is normally a requirement to carry out the following general operations on any FM radio system.

1. Turn the radio on and off.
2. Adjust the receive volume of the radio.
3. Select the required channel on the radio.
4. Optionally select/enable any special tones required for proper network or repeater operation.
5. Optionally select/enable any guard receive or transmit functions.

It is also helpful to show visually that the radio is transmitting or receiving, so that the pilot is assured of correct performance. If the radio is 'frequency agile' (i.e., the frequency of operation can be set directly by the operator) a method must also be provided to enter the specific frequency data, and identify and store the information.

Every manufacturer attacks these requirements in a different manner, and since the Tac/Com system provides the ability to interface with other manufacturer's equipment as well as NAT's own transceivers, a uniform method of operation must be provided. How each common operating function is accomplished in the Tac/Com system is described in the following sections. It is also possible to interrogate the control head itself for help in learning how to operate it, simply by pressing the **HELP** button during the first power-up screen or at any time while editing.

The on-line help function for the system is comprehensive enough to address most operational questions, and corrects a long standing problem in the cockpit relating to lost or missing operator's manuals. Every control function and valid editing choice is fully explained through this system, which can be activated by pressing the **HELP** button.

It is important to remember that the many radios simultaneously controlled by the Tac/Com system may have very different features and attributes as well as frequencies. If the radio was incapable of some functions prior to connection to the Tac/Com head, it will not suddenly acquire all the functions possible just by connection to the Tac/Com control. Crystal controlled radios, such as the FliteFone 40, for example, do not suddenly become agile radios, and Flexcomm radios don't scan simply because they are connected to a Tac/Com control head. Only NAT's own radios offer full capability, which includes extended tones, DPL, encryption, scanning and variable transmit power.

3.3 Initial Operation

3.3.1 Power-up Help

Turn the Tac/Com system on by rotating any radio volume control away from the **OFF** detent position. The software revision number will be briefly displayed, followed by a screen presenting an option for use of the on-line **HELP** system, as shown below.

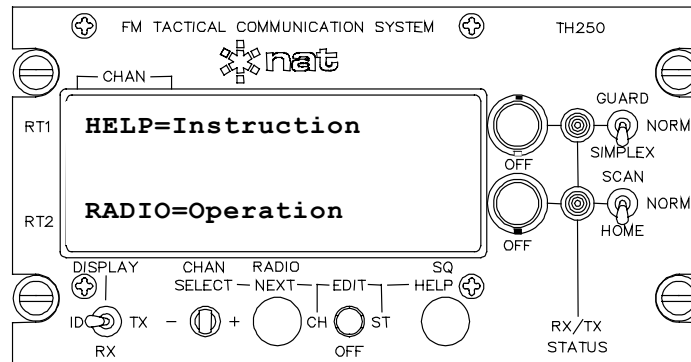

If help is selected (i.e., the **HELP** button is pushed), the control head will present a tutorial on the operation of each control head feature. To advance through the tutorial, press **HELP** after reading each screen. To exit this initial help function at any time, press the **RADIO** button, and the control head will begin normal radio operation.

3.3.2 Initial Operating Display

If help is declined (by using the **RADIO** button as directed), the control head will display a summary of the installed functions and current settings for each radio (this feature can be disabled in the installation set-up for faster start-up). Once all of the functions have been displayed, the radio will be ready for normal operation.

Once normal control head operation is selected, the display will install the radio and its settings as specified by the interface card and software set-up instructions. This will produce the following system message on the control head:

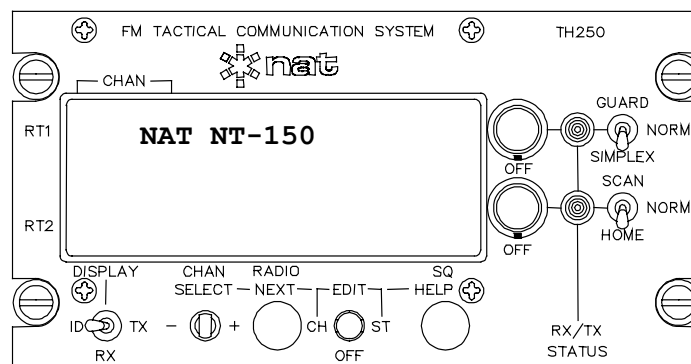

NAT NT-150 or WULFS RT-7200 (etc.)

This is the radio type designated for that transceiver slot in the control head (RT1-4), and will change if either the interface card, the stored software set-up or hardware jumper selections are changed in the control head. This message is to advise what the control head thinks should be in that interface slot.

Next, the status of the radio is presented which represents the state of its radio-wide functions such as transmit power, duplex operation or tones. A summary of all the selection options will be displayed, unless defeated in the installation software set-up to speed up turn-on of the control head. This display will produce messages such as those shown below, for each radio:

POWER=LO, TONES=OFF (etc.)

The control head will continue with each radio in sequence, and will finally position the cursor (arrow) by the selected radio when it has finished. There may also be messages such as those shown below, which are system error/alert messages reported by the Tac/Com control head:

NO I/F BOARD

There is no interface card installed in this specific slot (RT1-4) inside the Tac/Com control head. This message appears if there are empty slots in the control head, to warn that the panel controls are inactive.

-- NO RADIO --

When tested by the Tac/Com control head, no radio was found installed in this specific slot. It may have been removed for service, used in another aircraft, or have the mating connector disconnected.

-- RADIO OFF --

When checked by the Tac/Com control head, the radio was found to be turned off or defective (if turned ON at the front panel). This message also appears for Flexcomm radios if they are removed from the aircraft, as they do not support the **-- NO RADIO --** function.

3.4 Front Panel Controls

There are two main groups of controls, and a 2-, 3- or 4-line by 16-character display on the Tac/Com control head. The first group of controls is 'radio specific', and affects the operation of only a single radio (there can be up to four installed in a single control head). The second are general controls that affect the over-all operation of the control head. The function and relative location of these important groups is as follows:

3.4.1 Radio Specific Controls

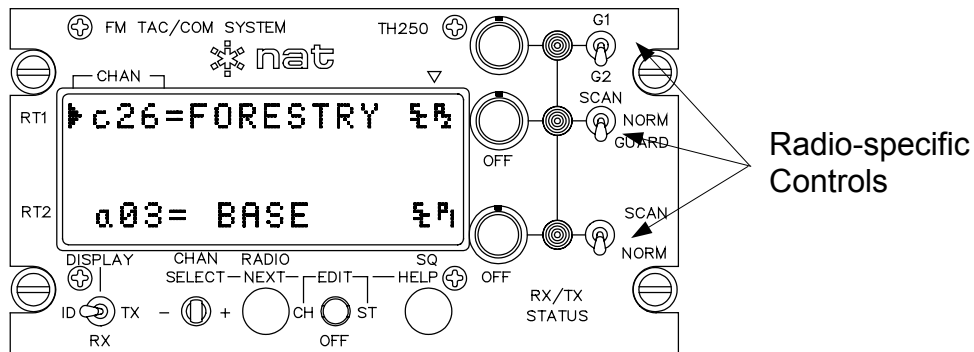

Radio specific controls allow the general operation and function of each radio to be modified independently. The radios are identified as 'RT1, RT2', etc. to the left of the display, and the line of text continues through the display to connect to the specific controls for that radio on the right hand side of the control head. The exact functions that are provided on the front panel via the radio function switch will vary with each radio type. Some radios support very few features, while others require both the front panel switch, and a number of status line functions to set all of the radio functions. Guard controls are not available on all units.

3.4.1.1 Guard Controls

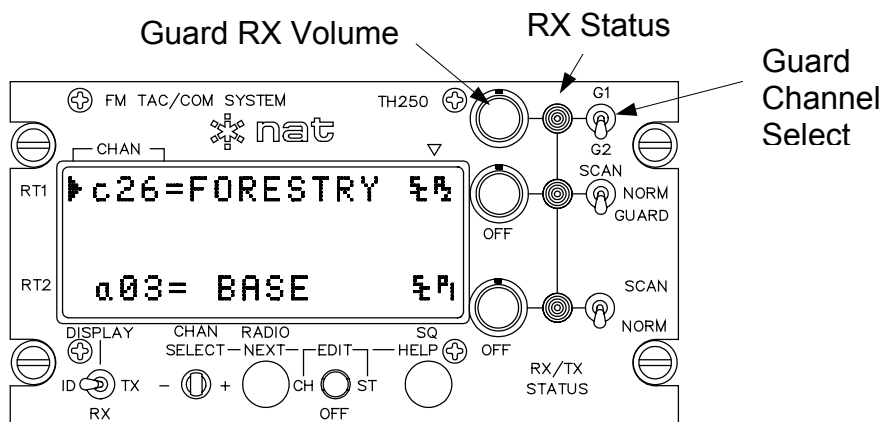

In general, the **GUARD** volume control permits a zero volume level without turning the radio off, but in some instances, such as USFS GUARD RX controls, this will not be true. OAS government contracts require that this level not go to zero regardless of pot setting, with a minimum fixed output at all times.

A second set of controls is provided for guard operation only when 'H', 'U' or 'V' interface cards are installed. Note that the **GUARD** volume control has no OFF detent position. Forcing the control fully counter-clockwise may cause switch damage. The internal minimum guard volume adjustment is accessible through the right side of the control head. The additional guard controls provide selection of the guard 1 and guard 2 channels, plus a separate RX status indicator.

3.4.1.2 RX (Receive) Volume Control

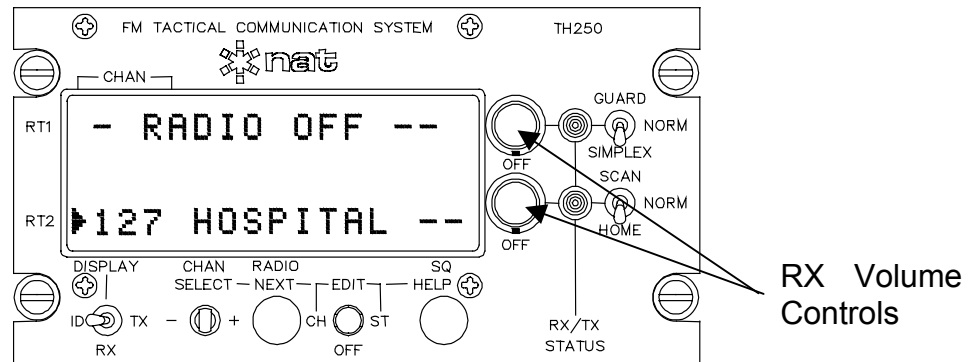

The RX volume control is adjusted via the round knob for each radio. Rotating this control fully counter-clockwise to **OFF** turns the specific radio off. If all controls are **OFF**, then the control head itself turns off.

3.4.1.3 RX/TX Status Indicator

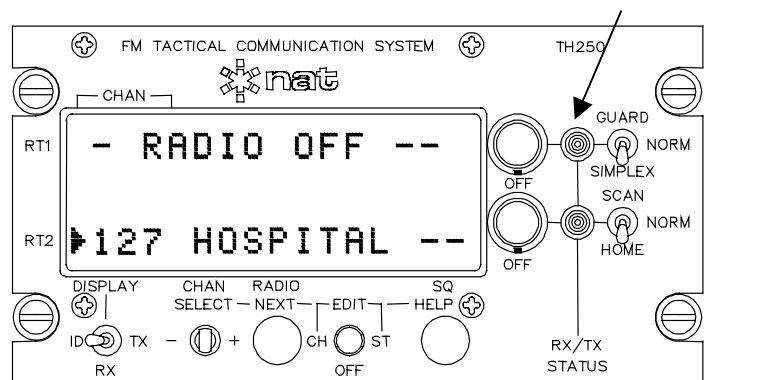

Next to the volume controls are bi-colour indicators that display TX (Transmit) status or RX (Receive) status. If that specific radio is keyed to transmit, the LED will be green. If a signal is being received, the LED will be amber.

A radio that is receiving may still not produce any audio, if the tones or DPL codes for that channel do not match the tones or DPL codes set in the control head. If tones are set to ON for a given radio from the status line, then all data (frequency and tone/DPL code) must be correct to hear the receive audio. If tones are OFF, then all incoming transmissions are received. The indicator lights whether the logic is correct for audio or not, to warn the pilot that channel is active with radio traffic of some kind.

If the radio is idle (not receiving or transmitting), the LED will be off. The colour coding used for these functions corresponds to the existing indications used in the FF40, C-62 and C-1000, for pilot familiarity. It is worth noting that these conventions are reversed from vehicular standards, and may be confusing for some emergency services staff used to land mobile equipment. When used with a Wulfsberg radio equipped with a guard channel, both the main and guard RX signal will illuminate the RX LED, unless equipped with separate guard controls.

3.4.1.4 Radio Mode Switch

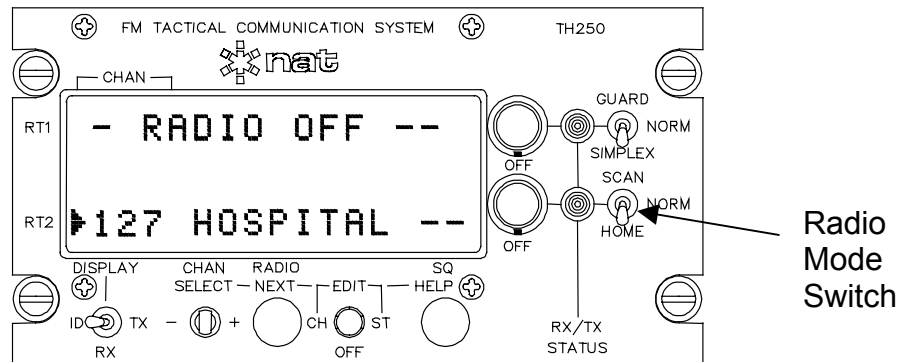

The last radio specific control is the **MODE** or **FUNCTION** switch, which varies with the type of radio used. For NT-series transceivers, it selects either **NORM** or **SCAN** modes of operation, as specifically defined in the status line.

For NT-series transceivers scanning occurs at 90 channels/second/radio, and the following scan modes (defined in the status edit mode) are:

LIST (up to a block of 32 channels/list).

PRIORITY (up to 2 priority channels + active monitor channel).

LIST+PRIORITY (2 priority + 30 channels in a given block).

Priority monitoring is 3 times/second for a 10-15ms sample. The radio will re-channel to the priority channel if traffic is detected, and returns to the monitor channel (channel the radio was resting on when scanning was selected) after a 2 second latency. All CTCSS tones or DPL codes are inactive during scanning (due to lock delay).

With some radios, this mode switch is reserved for **GUARD** or **MAIN** transmit selection, as scanning is not supported. It may also select **SIMPLEX** or direct (repeater talk-around) operation as opposed to **NORM** (Duplex) or repeater operation. Data for all channels is stored as individual TX and RX frequencies, which permits them to be entered and used in any way. The forced **SIMPLEX** function pushes the stored RX frequency into the TX slot temporarily to permit 'talk-around' of an existing stored repeater frequency, and avoids having to store a separate channel with this information.

3.4.2 General Controls - NORMAL Operation

The general control head functions include the switches that effect the over-all operation of the control head. Some of these switches have dual functions depending on control head mode of operation. The two modes of operation are NORMAL and EDITING.

The TOP ROW is for NORMAL OPERATION.

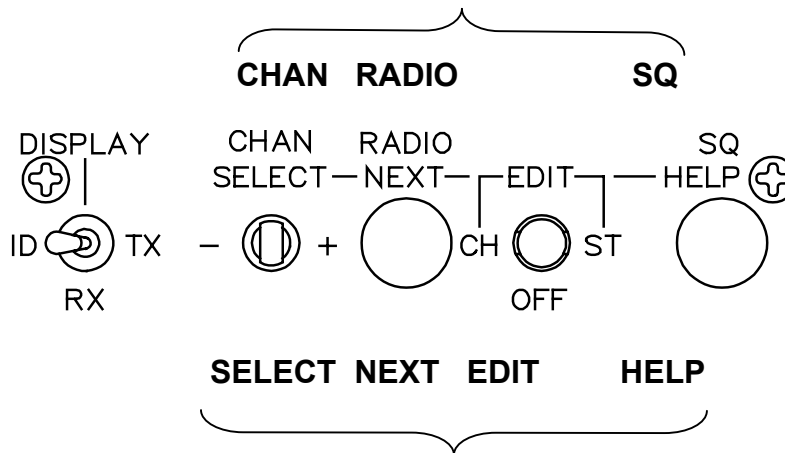

The BOTTOM ROW is for EDITING.

To show that they are related, engraved panel lines tie the EDITING functions together. The alternate EDITING functions become active whenever the **EDIT** switch is in any position other than **OFF**.

3.4.2.1 Display Switch

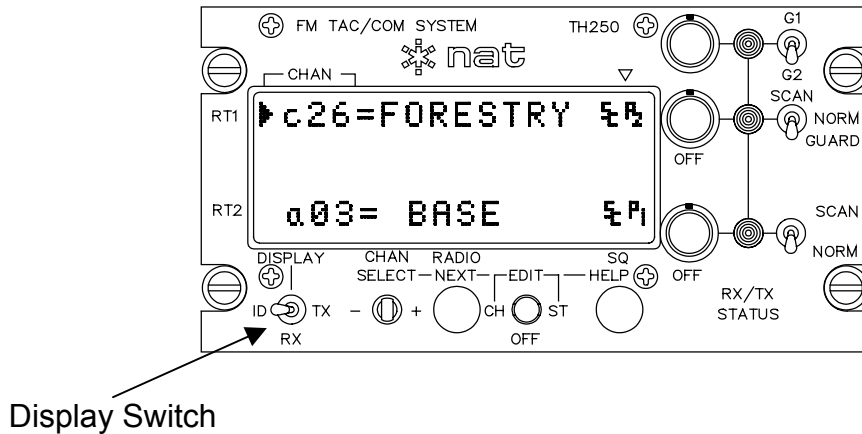

The **DISPLAY** switch works the same in both NORMAL and EDIT modes of operation.

The **DISPLAY** switch determines what data is shown on the individual channel presentations for each radio. Either the alphanumeric channel name or identification (**ID** position), or the actual channel frequency (**RX** and **TX** positions) can be displayed. When editing, this also determines what will be edited. Whatever data is visible is the material that can be edited. During normal operation, the crew can select whatever presentation is the most helpful to them, which is generally the ID or channel name display. The cursor, or left hand arrow, shows which radio is set up for channelling or editing.

3.4.2.2 CHAN +/- Toggle Switch - NORMAL Operation

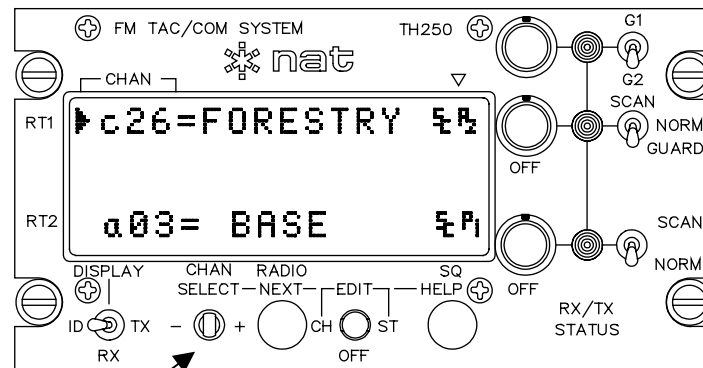

Channel Switch

To change channels, press the **CHAN** switch in the desired direction, either **+** for ascending, or **-** for descending numbers. Channel selection can also be accomplished remotely if the remote channelling switch is installed. The radio that has the cursor in front of it is the one that will be channelled.

Channel numbers will increase from a02 upwards (a03, a04, etc.) with each press of the switch to '+' position. If the switch is held to either position, it will scroll rapidly, increasing in speed the longer it is held down.

3.4.2.3 RADIO Push Button - NORMAL Operation

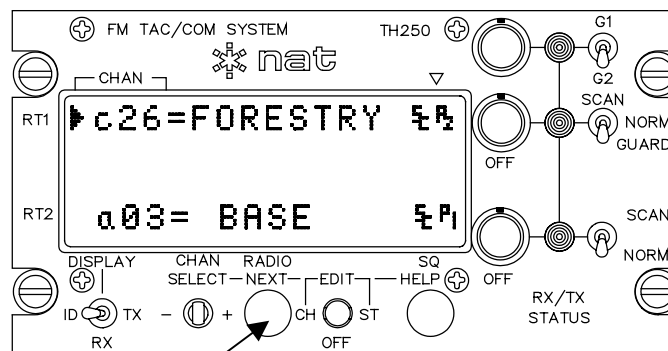

Radio Pushbutton

This push button switch picks the active radio selected for any operation. The radio selected is indicated by a triangular cursor to the left of the channel number (RT1 in this example). Cursor movement is from top to bottom, to the brightness screen and then returns back to the top again.

The radio that has the cursor in front of it is the one that will be channelled (RT1). To select RT2, press **RADIO**. If pressed a second time, the display brightness screen will be displayed.

When selected, a radio may be channelled, edited, or the manual squelch test operated. It has no bearing on transmit or receive capability, and only serves as an indication of which radio the control head is prepared to perform some operation on. This selection works in increasing order only (1,2,3,4, display brightness), and then re-starts at the beginning.

3.4.2.4 EDIT Switch Function - NORMAL Operation

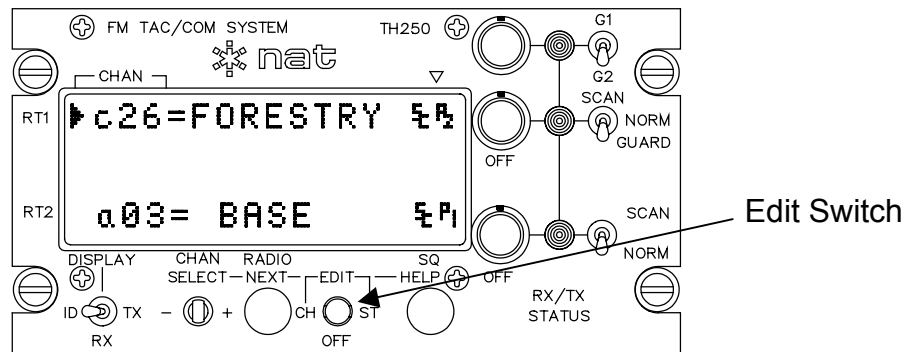

When the **EDIT** switch is in the centre-off locked position, all editing functions are off, and the control is in normal operation. If the switch is set to any other position, then editing is active, and either radio or channel data can be altered by the operator.

3.4.2.5 Squelch Function - NORMAL Operation

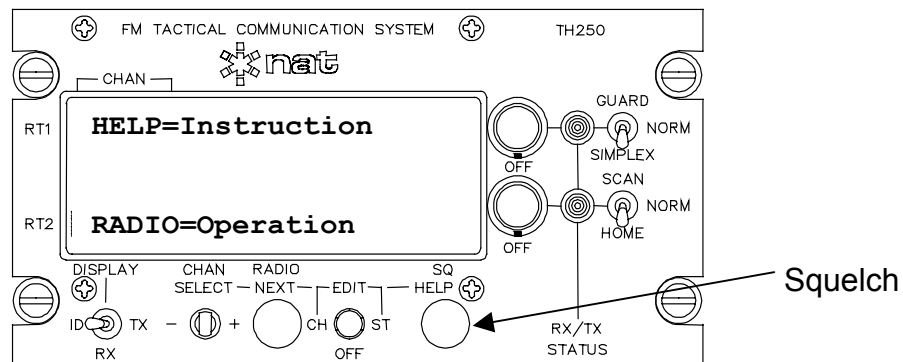

Pressing this button during the power-up screen presentation (when the control head is first turned on) will take the operator through detailed help screens for each function of the control head. In the normal operation of the control head, this is the only access to help (on power-up), as this button is then the manual squelch (**SQ**) test button for the selected radio.

The squelch test function is useful for monitoring activity on a radio when tones prevent the squelch from opening normally, or to verify volume settings or radio function. Pressing **SQ** over-rides all squelch logic, and lets the radio's raw receive signal pass to the ship's audio system.

When the locking **EDIT** switch is in any position other than **OFF** (centre), the **HELP** switch again becomes active, and provides context sensitive help for whatever function is being attempted, such as frequency entry, tones or labelling.

These two modes of help (power on and edit) provide assistance to the pilot/operator without interfering with the selected operation of the control head. If, basic help is required after the Tac/Com control head is already on, cycle the control head off again (turn all volume controls to OFF, or cycle the external breaker), and when powered up again, the option for comprehensive help will re-appear.

3.5 Editing

Editing is the general term for changing any information stored in the Tac/Com control head.

There are two basic types of editing that can be selected from the front panel of the control head. These are **CH** (channel) editing, and **ST** (status) editing. As the name implies, channel editing permits channel data to be controlled by the operator. This includes channel names, the transmit and receive frequencies and matching tones, scan flags (for list scan) and for some radios, channel discrete lines. To edit different channel information, such as frequency data or channel names, it is necessary to first select which information (**ID**, **RX**, or **TX**) will be edited via the **DISPLAY** switch.

There is simply not enough room to fit every possible function switch that might be needed for a given radio on the front of a Tac/Com control. Some radios also have many more functions than others complicating this control arrangement. The solution for this clutter is the use of the status line to show features that are important, but not constantly in use on the front panel. Status functions can be as extensive as required for a given radio. The internal editor permits only valid choices at all times, so that the operator is not required to know a great deal about the specific radio in question, but only what needs to be accomplished.

Editing Controls:

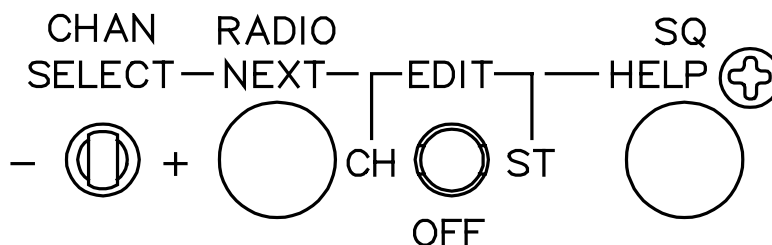

Two sets of legends exist for each of these switches. The bottom row (connected by lines) represents the function of the switches during the edit mode of operation. It takes some time to become familiar with the dual nature of these switches, but they greatly reduce clutter on the front panel, and make it possible to package all of the required functions into a size mechanically compatible with other systems.

3.5.1 Channel Editing

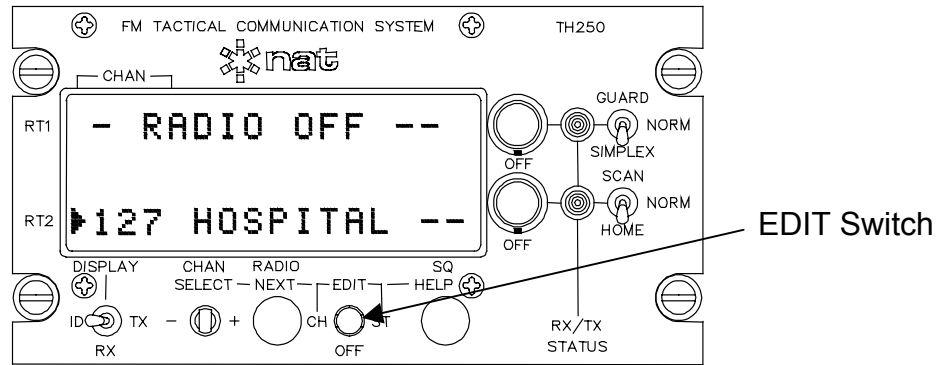

When the **EDIT** switch is in the **CH** position, the **ID**, **RX**, and **TX** information may be edited. The position or character to be edited will flash or blink on and off. When channel editing of data is in progress, operation of the radios is suspended, and the dual function edit switches work in the following way:

3.5.1.1 SELECT Switch

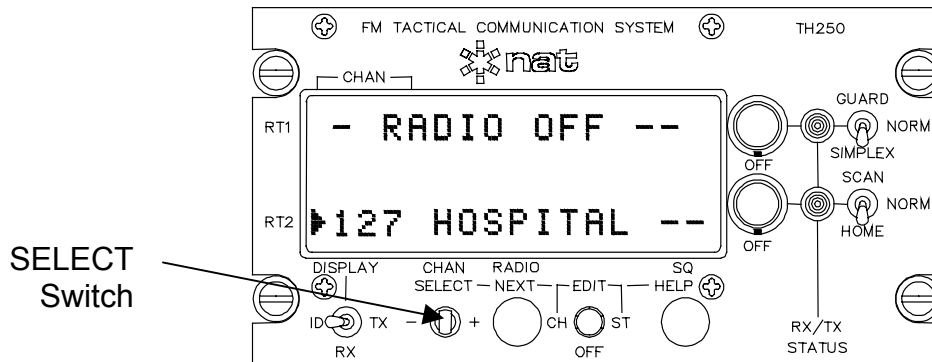

This switch is used to step the data entry up or down (+/-) on the currently marked radio. The character that will be selected flashes. This flashing character is referred to as the editing cursor, since it shows what is about to change. The intelligent editor within the control head only permits a valid choice for every position for data entry. This is to aid operators in reducing entry mistakes, particularly when busy with other flight procedures.

The selection choices are strung together in a circle, and choices move through this circle with the **SELECT** switch as shown below in the diagram:

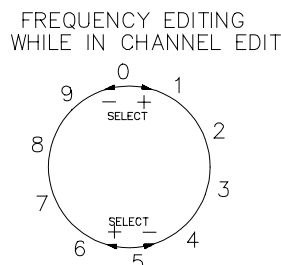

Depending on which way the **SELECT** switch is set (+ or -), the choices will move around the circle in either direction. The editor removes numbers from this circle that don't apply to the particular cursor position. For example, VHF High Band radios can only have a 3, 4, 5, 6 or 7 in the 10's of MHz position, so no other numbers are permitted during editing from the front panel in this location. Some radios do not channel below 150 MHz, so then the editor removes the 3 and 4, and so on through each position that can be edited.

When editing the channel ID label or name, the editor opens the circle to include all the alphanumeric characters, and some frequently used symbols, like the blank (visible as a flashing underline '_' to show the cursor location), slash (/) and number sign (#). The choices for selection are shown below:

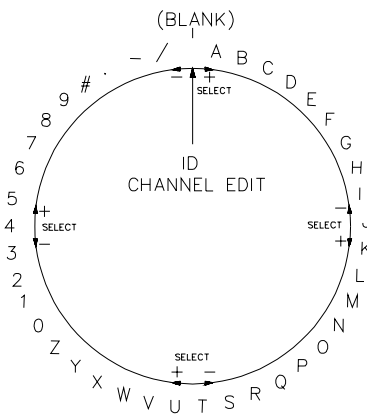

3.5.1.2 NEXT Switch

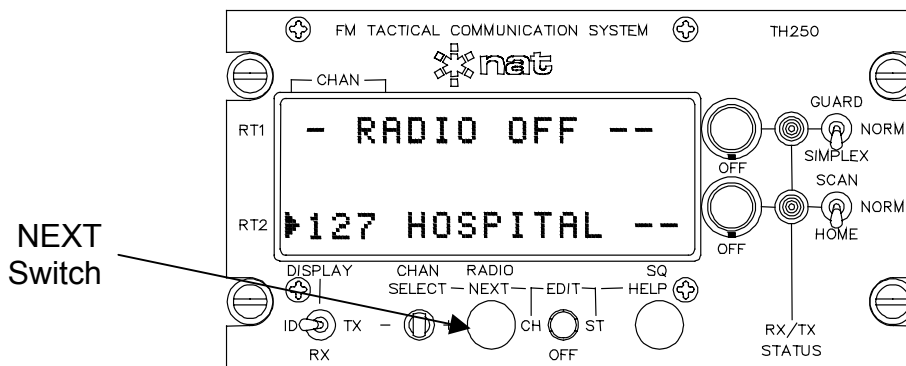

This push button switch cycles the editing cursor from left to right to the next character to edit. The editor will change what choices are valid as the cursor moves from one character to the next.

Sometimes more than one character will flash. This is because the only valid choices involve two characters, such as the fractional kHz entry for a channel frequency. This is also true for tone code entries. The **SELECT** switch will then scroll through the available entries from an internal table.

Note that a STAR appears at the right side of the RT #2 ID label in the diagram below. This means that the channel discrete line is enabled for that channel. This is a line to control external switching of a special function. It is programmed just like a scan flag, by advancing to that position with the **NEXT** button, and then toggling the entry with the **SELECT** switch. There is only one channel discrete line to set, and it appears only for the Flexcomm radios. This is a seldom-used function, and is provided for compatibility reasons only.

3.5.1.3 EDIT Switch

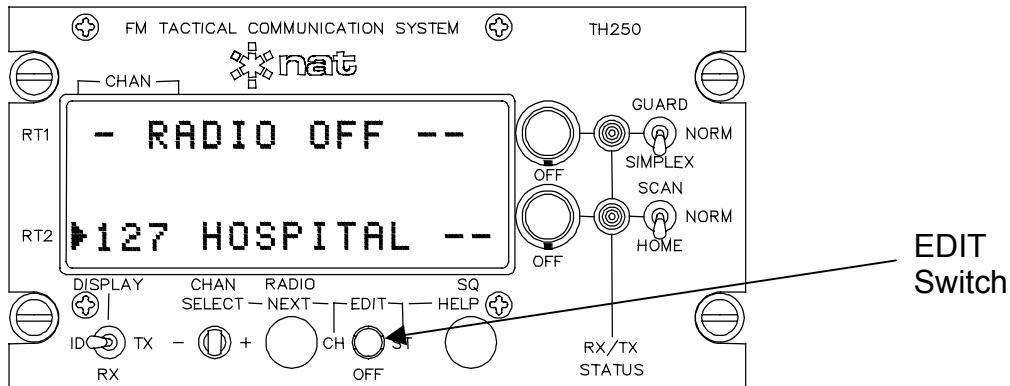

This locking, centre-off switch shifts the operation of the control head from editing back to the normal operating mode. For normal radio operation, it must be returned to the centre or **OFF** position. No special activity is needed to store the data that has been entered while editing. It is stored as soon as it is entered. When editing is finished, set the **EDIT** switch back to **OFF**.

3.5.1.4 HELP Switch

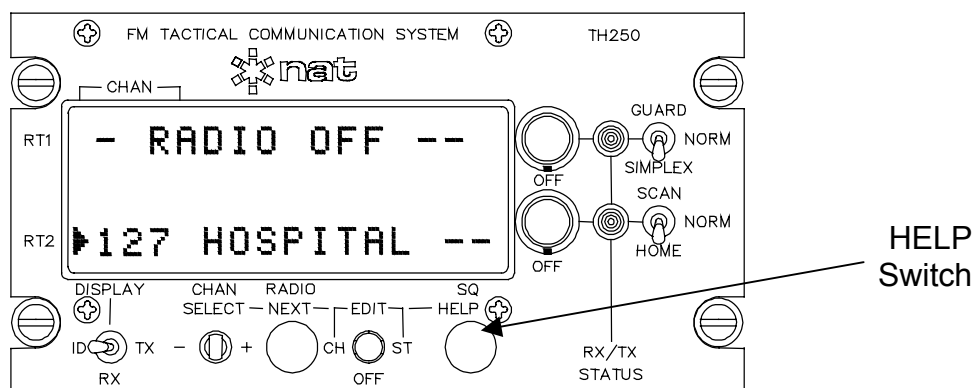

The help screen may be accessed at any time, and for any function, while in the edit mode. Press the **HELP** button if the operation of any function is unclear during editing. Information will be provided for the desired edit function, and if pressed while channel editing in the tone character position, will bring up the complete tone look up table for reference.

3.5.2 Summary of Channel Editing

For each channel stored in the control head, there are three possible data entries; identification label (**ID**), receive frequency (**RX**) and transmit frequency (**TX**). If equipped, the radio may also have tone and scan information associated with these entries. Note that non-agile radios can still have frequency data entered in the master edit mode (for reference only), but changing this data will have no effect on radio operation.

The ID label or channel name has no effect on radio operation, and is provided for operator/pilot convenience in identifying the selected channel. Any alphabetical character, the numbers 0-9, and some punctuation (space # . - /) may be inserted in the ID label.

Help can be used at any time when editing, to give instruction for the operation being performed. The exact data that pressing **HELP** provides depends on the current activity, as it is context-sensitive. Editing tone locations and pressing **HELP** will bring up the tone look-up table. Editing channel frequencies will bring up frequency information, and so on.

It is important to remember that while frequency data may be edited, the radio itself must be an agile radio, with the AGILE MODE ENABLED on the interface card for any change to actually take place. Crystal controlled radios, or PROM coded radios which allow editing of this data in the master edit mode (for reference only), will not change frequency after editing. Receive frequency editing is also allowed for guard channels (also crystal controlled) used in some radios, but again, this is for reference only, and no change will take place in the operation of the radio.

When editing RX or TX frequency data, only those frequencies the control head recognizes as valid can be entered, and only in the fractional multiples allowed. If mismatched multiples occur when editing, a warning message, **FREQ ERROR** will appear, because the RX and TX frequencies must both be divisible by the same synthesizer interval.

The last positions (far right hand) on the RX and TX lines are for tone data (these locations have scan flags on the ID line). Depending on the type of radio installed, differing codes are possible here to represent the CTCSS (or sub-audible) tones used for repeater or squelch control. A different tone can be set for receive and transmit. The capability to have tones can also be enabled or disabled through the status lines, providing the radio will support this function. If the tones are enabled (via the status line), an '=' (equal sign) will be displayed between the channel number and following information on all three presentations. If the special function, DPL, or Digital Private Line has been enabled at installation time, then 83 different 3 digit DPL codes are available for use with NT-series radios.

3.5.3 Summary of Channel Labels

Tac/Com permits two kinds of channel numbers (set at installation time) for ease of use and as a memory aid. Block numbers begin with a letter, a-d, and have 32 channels per block. This allows channels to be grouped together for convenience (i.e., all channels for forestry in one block, all EMS in another, all police in another, etc.), and also clearly shows which channels can be scanned together as a group. NAT NT-series radios hold 32 channels at one time for scanning, and they must be from the same block. Block numbers are a reminder of which channels are grouped together.

Blocks:	a01-a32	Sequential Numbers:	001-032
	b01-b32		033-064
	c01-c32		065-096
	d01-d32		097-128

The control head can also be set to show 128 sequential channels (or some lesser number, if preferred, and if it has been set up that way at installation time). In this case, the channel numbers go 001 to 128. This is often used with Flexcomm radios, where there is no scan function.

There is also one additional mode, which is supported only on the NT136-PAS multi-mode transceiver. In this case, channel numbers are labelled A01 to A64 and F01 to F64. The 'A' channels are AM, and the 'F' channels are FM. Each 32-channel block may be scanned within each bank (1-32 and 33-64), but all channels must be AM or FM within the scan group.

Blocks:	A01-A32	Sequential Numbers:	001-032
	A33-A64	(equivalent)	033-064
	F01-F32		065-096
	F33-F64		097-128

In addition to using the front panel channel and radio switches, the remote channel and radio switches may also be used, if installed. They work exactly the same way as the front panel switches.

A DTE12 or DP12 can also be used to access a channel directly by number. In this case, just key in the number (sequential number) and press the **ENTER** key on the DTE12. It is important to understand how channel numbers work, because some things may occur on the display that might be confusing. An example is shown below, demonstrating what happens when the control head is channelled below a01.

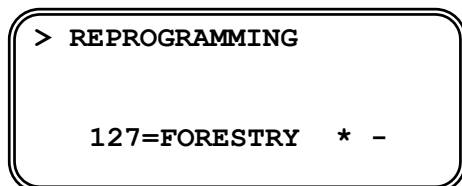

Note that the control displays the message REPROGRAMMING while it re-loads the next block of 32 channels into the NAT radio for scanning. This happens very quickly, but creates a short pause when scrolling through each block of 32 channels.

As soon as the data is loaded into the radio, the next channel in the next block appears (d32). Channels wrap around from highest to lowest, so that it is never necessary to reverse direction to advance to any channel.

3.5.4 Summary of Subaudible Tones

Subaudible tones are sometimes used to screen unwanted transmissions on shared frequencies. They are often referred to as PL Tones or Private Line Tones. The correct name defined by the Telecommunications Industry Association (TIA) is Continuous Tone Controlled Squelch System (CTCSS).

Tac/Com has stored a useful tone look-up table inside the help function. To view it, edit a channel and move the editing cursor (flashing character) to the far right hand position where the tone should be. Pressing **HELP** there will allow the CTCSS tone table to be reviewed.

3.5.4.1 Methods of Tone Display

Over the years, many different codes have come into existence to describe these tone sub-audible tone frequencies. They are listed below:

Tone Frequency (FREQ): - This is the TIA standard.

This is a frequency below 300 Hz that uniquely identifies the tone key that is used to control the radio squelch (allows audio to be heard), or control a repeater function. There are only three digits available on the control head for this data, so any decimal fraction is omitted from the display (i.e., 103.5 Hz becomes 103). Although not displayed, the correct frequency is still used.

EIA Codes (1-32):

This is a sequential number from 1-32 (or 38) that identifies the tone in order from lowest (67.0 Hz) to highest (203.5 Hz or 250.3 Hz), as defined by the Electronics Industry Alliance (EIA).

Wulfsberg Codes (WCODES):

These are sequential shifted OCTAL codes based on the thumbwheel design of the C-1000 control. Because they are missing numbers ending in 0 & 9, they are often confused with the straight sequential number for the EIA tones.

Motorola Codes (MCODES):

These are alphanumeric codes that seem largely random in assignment, but often appear in the land mobile business if Motorola equipment is used.

3.5.4.2 CTCSS or Subaudible Tone Table

The following table shows the relationship of the supported tone codes. All of these are available in the control head, and when editing, the **SELECT** slew switch (+/-) will bring up only valid choices for each type of code. Pressing **HELP** while editing these positions of the channel data will bring up the tone table for reference. The Frequency shown will have the decimal fraction truncated when displayed on the control head.

Tone Frequency	1-32 (1-38)	WCODE	MCODE
67.0 Hz	1	01	XZ
71.9 Hz	2	02	XA
74.4 Hz	3	03	WA
77.0 Hz	4	04	XB
79.7 Hz	5	05	SP
82.5 Hz	6	06	YZ
85.4 Hz	7	07	YA
88.5 Hz	8	08	YB
91.5 Hz	9	11	ZZ
94.8 Hz	10	12	ZA
97.4 Hz	11	13	ZB
100.0 Hz	12	14	1Z
103.5 Hz	13	15	1A
107.2 Hz	14	16	1B
110.9 Hz	15	17	2Z
114.8 Hz	16	18	2A
118.8 Hz	17	21	2B
123.0 Hz	18	22	3Z
127.3 Hz	19	23	3A
131.8 Hz	20	24	3B
136.5 Hz	21	25	4Z
141.3 Hz	22	26	4A
146.2 Hz	23	27	4B
151.4 Hz	24	28	5Z
156.7 Hz	25	31	5A
162.2 Hz	26	32	5B
167.9 Hz	27	33	6Z
173.8 Hz	28	34	6A
179.9 Hz	29	35	6B
186.2 Hz	30	36	7Z
192.8 Hz	31	37	7A
203.5 Hz	32	38	M1
210.7 Hz (NAT)	33 (NAT ONLY)	41 (NAT ONLY)	M2 (NAT ONLY)
218.1 Hz (NAT)	34 (NAT ONLY)	42 (NAT ONLY)	M3 (NAT ONLY)
225.7 Hz (NAT)	35 (NAT ONLY)	43 (NAT ONLY)	M4 (NAT ONLY)
233.6 Hz (NAT)	36 (NAT ONLY)	44 (NAT ONLY)	M5 (NAT ONLY)
241.8 Hz (NAT)	37 (NAT ONLY)	45 (NAT ONLY)	M6 (NAT ONLY)
250.3 Hz (NAT)	38 (NAT ONLY)	46 (NAT ONLY)	M7 (NAT ONLY)

The multiple codes shown are available on current generation Tac/Com II controls only. Previous generation Tac/Com I & II controls had only a single code, which was the WCODE, for compatibility with existing aircraft transceivers.

The additional codes and frequency display were added in the new control head software in 1991 for USFS/OAS contracts. Tone data is often received in the EIA sequential number format, or as the raw frequency, and requires additional tone support for ease of use. Controls with USFS interfaces (guard controls) are set for the EIA sequential tone code at the factory. Older controls (pre-1991 Tac/Com II) may upgrade to current generation software for this expanded tone display.

3.5.4.3 Using Help to Get the Table

The tone code table is accessed by pressing **HELP** while editing a tone location during channel editing. Scroll through the table by pressing **HELP** until the desired entry is located. Press **RADIO** to exit, or continue through the table by pressing **HELP** until the data entry screen is reached.

3.5.4.4 DPL Codes

NAT NT-series transceivers support 83 Digital Private Line Codes (DPL) in addition to the CTCSS or Private Line subaudible tones. This option must be enabled at installation time in the installation and configuration mode of operation. It is normally shipped set to OFF by the factory to reduce confusion over tone codes.

DPL codes are three digit sequences that describe a digital code sent at low frequency in the background of regular transmissions. They are filtered out of normal receive audio and provide another method of signalling or squelch control.

Code numbers are arbitrary and are stored in an internal table. When in use, the control head finds the correct entries based on how the code is entered. The **FREQ** option for tone presentation is not available if DPL is enabled.

- | | | |
|-----|-----------|---|
| 023 | DPL Code | If the '0' position is chosen for edit, the control head is programmed to select a 3-digit DPL code and bring up the table for the SELECT switch to choose from. |
| 32 | Tone Code | If the first digit position is skipped, the control head is tone code programmed to select a 2-digit CTCSS tone code and bring up the table for selection. |

This arises **ONLY** if DPL is enabled. For most users, this selection will not be used because only subaudible tones are used.

3.6 Status Line Editing

The status lines for each radio contain all the extra functions supported by the radio. Because this is largely defined in software, it also provides a very cost-effective method of upgrading the system performance or features through simple software (EPROM) changes, rather than radical panel re-design. Some radios may have little or no function support (such as the FliteFone 40), others may have many features (such as NT-series RT's) including power level shift, scan, tones, and priority.

Like editing other data, only allowable options are presented, guided by the control head's reading of the interface card's capability and the stored software installation set up routines. This mode can also be used to display the status of the radio quickly, without editing any data.

To edit status line data, press the **RADIO** button until the triangular cursor appears to the left of the radio whose status is to be edited or displayed. Once the radio is selected, **ST(status) EDIT** mode may be entered to change the information.

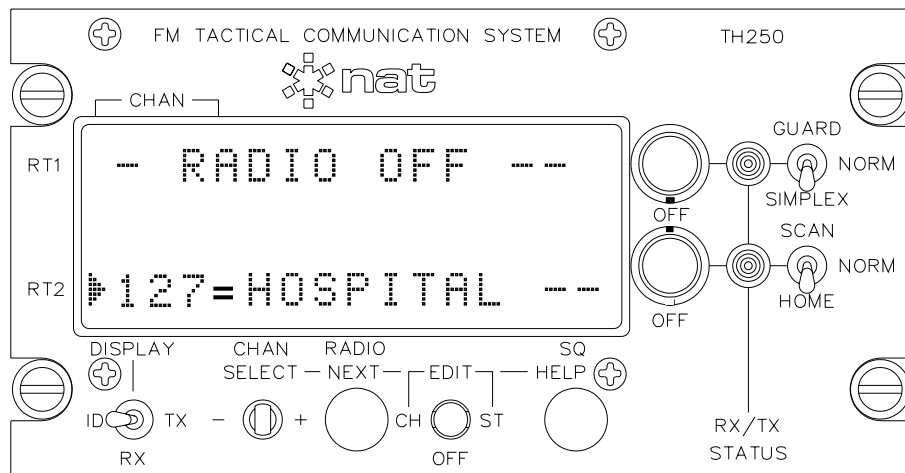

In this mode, each of the available functions for the radio can be set, or reviewed. Only valid functions and choices will be presented. Note that for this radio, the TX mode function is set for DUPLEX operation. Pressing **NEXT** will advance to the next function, while pressing **SELECT** will select what choice is wanted for this function.

3.6.1 NEXT and SELECT Switch Use

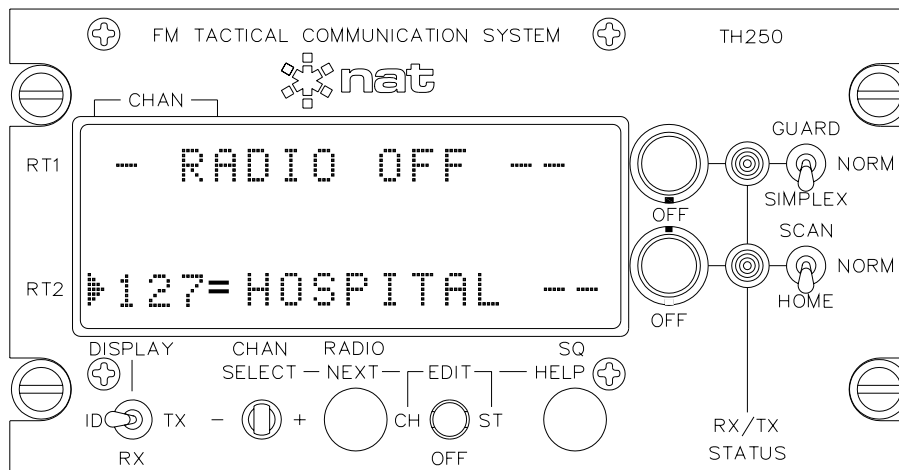

- SIMPLEX** This choice will cycle with the SELECT switch.
- TX MODE** This function will cycle with the NEXT switch.

Cycling **SELECT** will change the choice displayed for any given function.

To advance to the next function, press **NEXT**, and it will appear. Use the **SELECT** switch to again insert the desired option, and continue in this manner until the radio status is correctly defined. If **NEXT** is pressed again, the functions will cycle around again in a loop to allow for any error corrections. The pattern of this selection is shown below to illustrate the flow of information:

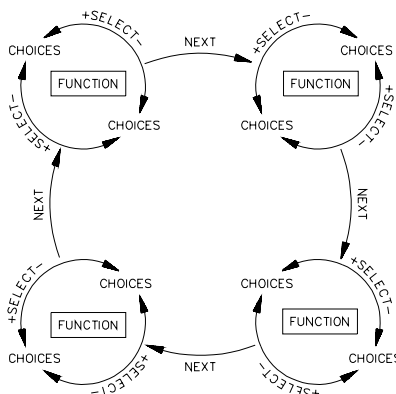

The specific functions that appear in this general loop vary with each transceiver type, and to some extent, the version of the software. New generation Tac/Com II controls have three scan modes, while older ones have only two. This can be upgraded by replacing the EPROM in an older control head.

To illustrate the choices possible in the STATUS EDIT MODE, the following diagram shows all the current options and choices for an NT-series transceiver. While this appears complicated as a chart, it is very simple to use and just represents a sequence of clear choices that cycle around for user selection.

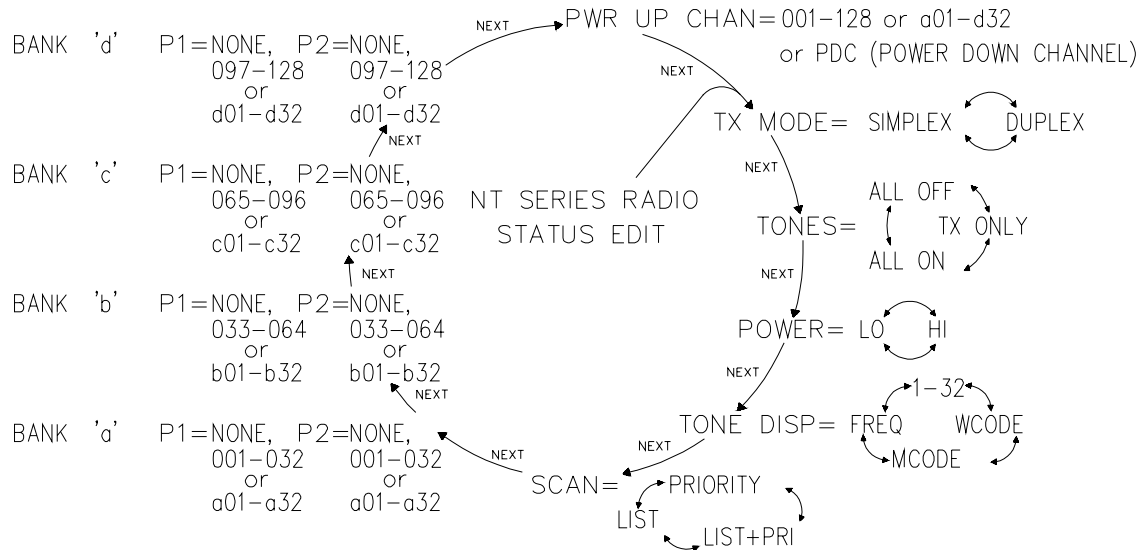

When editing is finished, return the **EDIT** switch to **OFF**, and the information will be stored. It is not necessary to go through the entire status listing, and exit is available at any time. This feature may also be used to check how the radio is set up without making any changes.

3.6.2 Status Edit Features

The status edit features currently implemented in Tac/Com are as shown and explained below:

3.6.2.1 TX MODE=

There are two modes possible, either **DUPLEX** (REPEATER) operation, or **SIMPLEX** (DIRECT) operation. This determines whether a common frequency is used for RX and TX, or whether different frequencies will be used. This function over-rides what is stored in the individual channel data locations, and allows those stored channels to also be operated in SIMPLEX mode without taking up another storage location. Not all radios have this capability.

3.6.2.2 TONES=

Most radios have this capability. **TONES** can be set **ON** or **OFF** for the radio by this function, thus enabling or disabling any tones which may be set on a per channel basis through channel editing. NAT NT-series radios and the RT-96/7200 also support a tones mode of **TX ONLY**, which enables only the transmit tone, but not the receive tone.

This is used where the tones are needed only to open the repeater and serve no RX squelch function.

3.6.2.3 POWER=

Some radios, such as NAT's NT-series and the RT-9600/7200 support a high and low power transmitter function. Many radio station licenses have power restrictions at altitude, and must be set to low TX power above 5,000' for legal operation. This may also be required to prevent repeater interference at altitude, or to permit secure operations.

3.6.2.4 TONE DISP=

New generation software now permits the user to define the tone presentation to suit local operations on a radio-by-radio basis. This selection can be set to the tone frequency referred to as **FREQ**, or to one of several codes. The sequential numbers for the first 32 EIA tones are referred to as 1-32. The alphanumeric codes for Motorola radios are referred to as **MCODES**. The shifted octal codes used by Wulfsberg are referred to as **WCODES** on the status line.

To select the desired tone display option from the list, chose the desired display mode with the **SELECT** switch. The options are **1-32**, **WCODE**, **MCODE** and **FREQ**. Note that the **FREQ** option will not appear if the DPL tones have been selected ON in the IAC edit mode. Refer to Section 3.5.4.4 for more information.

3.6.2.5 SCAN=

For NAT series transceivers, the option of scanning a **LIST**, **PRIORITY** channels, or on newer generation control heads, **LIST + PRIORITY** is provided. The Scan List channels are edited in the second last digit on the ID line from normal channel edit mode. For more details on scanning refer to Section 3.9.

3.6.2.6 P1=, P2=

The Priority 1 and 2 channels are selected by toggling the **CHAN +/-** switch. Two channels are selected for each bank of channels (a through d). When the scan option is selected to List, the priority channels are not active but are retained in memory.

3.6.2.7 GUARD RCVR=

The RT-9600 guard functions can be from either the front panel (U interface), or the status line, depending on which type of interface has been installed in the control head. If the status line is used (R or P interface) the line appears as **GUARD=0** (off), 1, or 2.

For Flexcomm, the guard RX may only be enabled or not from the status line, as only one channel exists. Front panel guard functions refer to guard transmit operation.

3.6.2.8 PWR-UP CHAN=

This is the channel the control head will go to when it is powered up. This may be set for each radio. On early Tac/Com I controls, only a specific channel could be set, but current generation Tac/Com I & II motherboards have additional non-volatile memory to remember the last channel used, and so can also provide an option of returning to the last channel set prior to power down. This channel is referred to as the PDC or Power Down Channel, and can be set as an option instead of any specific channel number.

3.6.2.9 ENCRYPTION=

NAT NTX138 radios are available with an encryption option. If installed in the radio the control head will include a status line to allow the selection of encryption 'on' or 'off'.

3.7 Channel Display Summary

The NAT Tac/Com control heads provide three displays for each channel of stored radio information as set by the **DISPLAY** switch at the lower left side of the control head.

3.7.1 Display Switch Set to 'ID'

ID or Channel Label Information. This is a name, such as FORESTRY, HOSPITAL or BASE 5. The display format shows the CHANNEL number, ID LABEL, and any SCAN FLAGS.

A typical ID Label might look like this:

a01= FORESTRY S_c
Channel Label Scan Flag

The '=' indicates that TONES ARE ENABLED. This appears only once the tones are turned ON from the STATUS EDIT function. Tones can be stored, but not active, and can be activated for TX ONLY, or both TX and RX, as required. TX ONLY is the normal mode for forestry operations on USFS/OAS/BLM contracts. If all tones (both RX and TX) are activated, no audio may be heard in some simplex operations, as no tones may be present, and thus the radio squelch will not open.

SCAN FLAGS indicate which channels are flagged for monitoring during LIST SCAN. Another flag can appear here, the PRIORITY SCAN FLAG for the P1 and P2 channels, but this data is set from the STATUS EDIT function, as it can exist only once for each radio, or once for each bank (NT-series radios). Both list & priority scan are supported in NAT NT-series radios, and can be programmed by the operator. For Flexcomm radios, a CHANNEL DISCRETE flag (I) can also be programmed, to be used for special external switching. It appears in the same place as the SCAN FLAG on the display.

NAT NTX138 radios provide wide-band and narrow-band operation. The bandwidth flag indicates the selected mode. It indicates the current modulation acceptance and transmit deviation mode. When a \overline{w} character is displayed the channel is operating in wide-band mode. When a \overline{n} character is displayed the channel is operating in narrow-band mode

A typical NTX138 ID line might look like this

```

a01= FORESTRY   $\overline{n}$   Sc P1
Channel   Label   Bandwidth   Scan
                               Flag     Flags

```

3.7.2 Display Switch Set to 'RX'

RX or Receive Frequency and Tone. This is the receive frequency of a given channel, plus its Receive Tone (if any), displayed in the format selected previously.

A typical RX frequency might look like this:

```

a01= 156.875r  91
Channel  RX Freq.  Tone

```

The '=' indicates that tones are enabled from the STATUS EDIT function. The small 'r' indicates that the data displayed is a RECEIVE frequency. If the radio is put into the simplex mode, this will be replaced with an 's'. In SIMPLEX or DIRECT operation, the radio's TX frequency is shifted to the RX frequency, to permit talk-around operation on repeaters. The old data remains in the control head memory, but is not displayed.

3.7.3 Display Switch Set to 'TX'

TX or Transmit Frequency and Tone. This is the transmit frequency of a given channel, plus its Transmit Tone (if any), in the format selected previously.

A typical TX frequency might look like this:

```

a01= 154.775t  100
Channel  TX Freq.  Tone

```

The '=' indicates that tones are enabled from the STATUS EDIT function. The small 't' indicates that the data displayed is a transmit frequency. If the radio is put into the simplex mode, this will be replaced with an 's', and the TX frequency cannot be edited. In SIMPLEX or DIRECT operation, the radio's TX frequency is shifted to the RX frequency, to permit talk-around operation on repeaters. The old data remains in the control head memory, but is not displayed.

3.8 Changing Display Brightness

There is one additional display function, which is the INTENSITY/CONTRAST setting. On LED controls, this is selected by advancing the cursor past the bottom radio. The display brightness screen below will be shown. On a two radio control, simply press the **RADIO** button two times if the cursor is set to the top radio, or once if set to the bottom radio, and the screen below will appear. The display brightness is adjusted with the SELECT switch. Press **RADIO** again to return to normal operation.

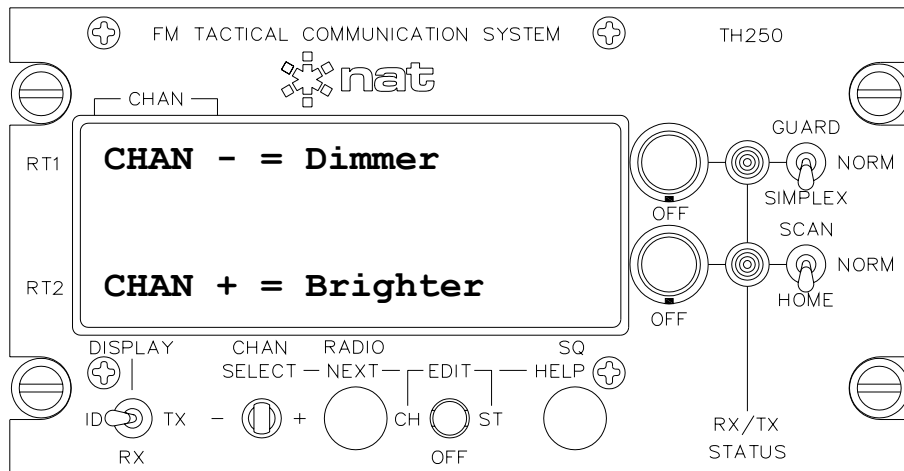

On LCD controls, there are two ways of making this adjustment, either by the screen described above, or by a **DISPLAY/CONTRAST** pot, if there is adequate room on the front panel. The Contrast control changes the contrast ratio and viewing angle of the LCD to suit varying light and position situations. If the display is subjected to dramatic temperature extremes (hot or cold), it will alter the chemical properties of the display, and may require an adjustment of this control to return the appearance to the desired presentation.

3.9 Scanning

Scanning is an automatic internal function that rapidly samples radio channels under operator control. The operator may select one of several predefined modes that control how the radio will carry out this function (via the STATUS EDIT function), and has a front panel switch to send the radio into this mode of operation.

Scanning is very useful for checking radio traffic on one or more channels, while working a 'home' or monitor channel (the one the radio was on before scanning was selected). When scanning is active, all CTCSS/Subaudible Tone or DPL Functions are ignored, and with the NT150, the radio does not test for these conditions when determining that a channel has been found. Tones remain active for squelch control. This is because the delay to test for tones is so long compared to the radio lock-up time, that scanning would be seriously compromised. NT-series transceivers scan at rates of

approximately 90 channels/second. It takes almost half a second to provide tone or DPL decoding, which would result in virtually useless scanning of 2 channels/second. It is therefore recommended that when using either the NT150 or the NTX138, the tones should be turned off to prevent slow scanning.

When Scanning is active, the front panel **CHAN** switch is inactive (for that radio), because channel control is taken over by the scanning logic in the control head. This may cause some operator confusion if the control head has acquired a channel (while scanning) and manual channel change is attempted. No change will occur, and the radio must be selected out of **SCAN** into **NORM** operation for manual channel changes to work from the panel control.

If the microphone for a transceiver is keyed while the control head is scanning, the radio will be rechannelled to the 'home' or monitor channel for transmission.

When scanning, a signal needs to be slightly stronger than during normal operation because the time interval for detection is so short. No tones or DPL codes are taken into account when scanning. The radio will stop on any scan-designated channel that has an RF signal present, but received audio may not be heard if the tones are incorrectly set in the control head. To avoid any confusion, tones can be set to OFF (via the status edit function) during scanning so that all channels will be heard.

Any channel can be designated as both a PRIORITY channel and a LIST channel within the 4 banks of 32 channels supported by NAT NT-series transceivers. The appropriate scan flags will then appear after the channel name in the ID mode (P1, or P2, and/or SC). Any or all of the 32 channels in a bank can be in the list for LIST SCANNING, but only one channel each may be assigned the P1 and P2 Priority designation.

NOTE: NAT NTX138 radios provide 128 continuous channels. Therefore there can be only one pair of priority channels selected.

When scanning is selected by the front panel mode switch, a message will be displayed to indicate what the radio is doing. On earlier Tac/Com controls, this message was 'SCANNING', but in new software revisions, the scan mode and bank are now displayed for better operator understanding. These messages are now as follows:

<u>Display</u>	<u>Scan Mode</u>
L -SCANNING 'a'	LIST SCANNING, bank 'a'
P -SCANNING 'b'	PRIORITY SCANNING bank 'b'
LP-SCANNING 'c'	LIST+PRIORITY SCANNING bank 'c'

3.9.1 Scan Modes

If priority scan channels are enabled through the status editing mode, the channel label will then be followed by the ident: **P1** or **P2** viewed in the **ID** display mode, indicating priority status. If the channel was added to the list scan mode, the **SC** flag will also be displayed when viewing the channel label. Priority channels are selected by the status line, as is the **SCAN MODE** (list or priority). Channels are tagged for list scanning in the **ID** label edit (**CH**) function. Current generation Tac/Com II software supports three scan modes as follows:

3.9.1.1 LIST Scanning

Channels are selected for **LIST** scanning by adding a scan flag (S_c) to the end of the **ID** line when in the channel editing mode. This space can be toggled to be either a dash (not flagged), or the (S_c) flag, showing that the channel is added to the scan list for that radio, or block of 32 channels (NT-series radios).

Once scanning is active, the control will move through all the flagged channels in order until a carrier is detected, then it will remain on that channel until traffic stops, plus a 2-3 second latency period to permit a reply to any incoming traffic. If there is no further activity, the control will continue through the list, and then start over. When scanning is de-selected, the control head resumes normal operation and the radio will return to the 'home' or monitor channel it was set to before scanning began.

3.9.1.2 PRIORITY Scanning

Because they can exist only once for each radio or block of 32 channels (NT-series radios), and to avoid accidental duplication, priority channels are set via the status edit function. The same priority channels could be set for every block (NT-series radios), but they must then be entered into channels within each block. The highest priority channel is designated **P1**, and the next priority **P2**; the lowest priority is the 'home' or monitor channel. The P_1/P_2 flags will appear after the channel names in the **ID** mode, once they are set. It is not necessary to have both **P1** and **P2** assigned, if they are not required.

If a transmission is received on the 'home' channel, both **P1** and **P2** continue to be checked. If a transmission occurs on the **P2** channel, the radio will continue to check for activity on **P1**. If a transmission occurs on the designated **P1** channel, the radio will rechannel to that frequency, regardless of activity on other channels. The check during priority is very fast, about every 1/3 second, and will sound like a faint tick when occurring during other reception. Whenever an incoming transmission is detected, the display will show the correct channel data corresponding to the display mode selected (**ID**, **RX** or **TX**).

3.9.1.3 LIST+PRIORITY Scanning

In this mode, both **LIST & PRIORITY** features are combined, so that a list can be checked while still periodically testing for activity on two priority channels. This is a new feature and only exists on software revisions 2.13 and later for Tac/Com II, and 1.45 and later for Tac/Com I controls. In this case, priority allocations remain per the normal priority mode, but list channels have a lower priority than the 'home' channel, and are scanned only when there is not any activity on the other three.

Note for NTX Transceivers:

When CTCSS tones are enabled, the access time for the decoder is added to the LIST + PRIORITY scanning time, dramatically reducing receive audio intelligibility. NAT therefore recommends that the combination of CTCSS tones and LIST + PRIORITY scan should be avoided for these units.

3.9.1.4 AM Scanning

While this was not an original feature of Tac/Com and the NT136-PAS multi-mode transceiver, it is now fully implemented. Some hardware updates are required to the transceiver (below s/n 1018) to achieve the required sensitivity for fast-lock AM reception, but coupled with current software, it can provide scanning with AM levels down to 2.0 uV. Because of the electrically noisy environment aircraft present, squelch thresholds must be much higher for AM receivers than for FM (2-3.0 uV versus 0.5 uV). When scanning, the effective range of coverage will be smaller for AM than for FM signals of the same strength.

3.9.1.5 Scanning on other systems

On Midland Syn-Tech I radios, channels added to the scan list will have the letters 'a' or 'b' added to the end of the ID label display. The status line is used to select whether list 'b' or both list 'a' and 'b' are used in the **SCAN** mode. Only list 'a' channels are used in the priority mode. Scanning is not provided for Wulfsberg radios due to their very long synthesizer lock up times, which preclude scanning.

3.10 NAT NTX138 Wide-band/Narrow-band Operation

The NAT NTX138 radios are capable of operating in either a wideband mode (5.0 kHz modulation) or narrowband (2.5 kHz modulation) mode. These modes are largely determined by the operating system used by the radio, and the associated channel spacing.

See section 3.7.1 for wide/narrow band display indication.

3.11 Master Edit Mode

USE THIS MODE WITH GREAT CARE.

**SERIOUS PROBLEMS CAN DEVELOP IF THIS MODE IS USED INCORRECTLY,
RESULTING IN SEVERE CHANNELING DIFFICULTY.**

This mode is intended for service related activities, but is presented here briefly for reference, and to aid with any field related data problems. Normally, there is no reason to ever enter this mode unless it is necessary to change a frequency display for some non-agile channel, such as a guard.

Note: Master Edit Mode is seldom used in normal operation.

If the data in the control head has developed an error that cannot be edited out, this mode will correct these problems. Such problems may be:

Garbled or incorrect channel number, or out of sequence numbers.
Mystery characters in a space that can't be reached for edit.
Incorrect guard or crystal channel data.

3.11.1 Entering Master Edit Mode

To enter this mode, carry out the following steps, **EXACTLY AS DESCRIBED**:

- a) Turn on the control head.
- b) Press the **RADIO** button to activate a radio.
- c) Move the **EDIT** switch to **CH**. The editing cursor will flash after the channel label and tones on/off indicator.
- d) Push the **HELP** button to bring up the **HELP** function.
- e) Advance through screens by pressing **HELP** until the Enter applicable password appears.
- f)
 - i) Using the **CHAN** switch scroll to **N**.
 - ii) Press the **NEXT** Button.
 - iii) Using the **CHAN** switch scroll to **A**.
 - iv) Press the **NEXT** Button.
 - v) Using the **CHAN** switch scroll to **T**.
 - vi) Press the **NEXT** Button.
- g) If the password is entered correctly, the control will say Correct. If not, the control head will drop back into normal operation. Press **NEXT** again, and the regular data screen will appear, but the editing cursor will be in the left-hand position after the arrow.

Anything visible on the screen may now be edited, **SO BE CAREFUL!!!** If channel numbers are being changed, be sure that they are **CORRECT!** A mistake here can be very difficult to correct later.

IMPORTANT!

This mode stays active until the unit is powered down, and is active for **ALL RADIOS, not just the one initially selected.** Anything that needs to be changed may be fixed, but be sure to power the unit **OFF** before normal operation.

If you are unsure of this function, PLEASE CALL NAT for more information!

3.11.2 How Data is Stored in the Control Head

In current generation Tac/Com I and II controls, all detailed radio configuration data is stored in special software set-up routines, to make field changes much simpler.

The over-all operating software for the control head is stored in an EPROM (Erasable Programmable Read Only Memory), which is an integrated circuit storage device, and can be removed and updated through a service centre exchange.

These program updates come only from NAT itself. Some control head data, such as set-up information, channel labels and frequencies, are stored in EEPROM (Electrically Erasable Programmable Read-Only Memory) circuits and can be accessed and updated by the user/operator as required.

3.11.3 Editing Considerations

It is important to remember that data stored in the EEPROM can be damaged by catastrophic component failure, severe static discharge (particularly by friction induced static during shipping if incorrectly packed), or accidental servicing or installation errors.

If odd or un-removable characters should appear in the display, particularly in unfortunate locations such as channel numbers, they can be removed via the 'MASTER EDIT' mode.

Channels should be set up in terms of easy scrolling access, with the most often used being close together in numerical sequence. This will save endless cycling back and forth, looking for channels.

3.12 Installation & Configuration Mode

This mode of operation is also not required for normal operation and is intended to aid in servicing and control head set-up. Some firmware functions of the control head can be set via this mode, including the following installation parameters:

- Transceiver selection for each interface slot.
- Transceiver selection for Wulfsberg C-1000 system emulation operation (RT-406F-SYS or RT-450-SYS)

- Number of radios installed in the control head.
- Number of channels per radio.
- Master/Slave operation.
- DPL enable (this function is normally set OFF, to avoid tone confusion).

To enter this mode requires a special code, and switch sequence and should be **USED ONLY AT THE FACTORY OR BY QUALIFIED SERVICE PERSONNEL**. It is possible to completely **DISABLE** the control head by incorrect settings in this mode, so considerable care is required.

3.12.1 Entering Configuration Mode

WARNING!
Incorrect Use Of This Mode May Render The Control Head INOPERABLE!
Use This Function With Extreme Care.

If you have ANY questions, please phone NAT prior to use.

To enter this mode do the following, **EXACTLY AS DESCRIBED**:

- a) With the power turned off, move the **EDIT** switch to the **CH** position.
- b) Turn on the control head. The '(Lock) **EDIT** switch **OFF** for normal operation.' message should appear.
- c) Press the **HELP** button. The '...**password**:' message should appear.
- d)
 - i) Using the **CHAN** switch scroll to **I**.
 - ii) Press the **NEXT** Button.
 - iii) Using the **CHAN** switch scroll to **A**.
 - iv) Press the **NEXT** Button.
 - v) Using the **CHAN** switch scroll to **C**.
 - vi) Press the **NEXT** Button.
- e) Push **HELP** to advance to the first configuration screen. Depending on the style of control head, and the options selected, the information on this and subsequent screens will vary. So don't worry if you don't see all of the features listed in the following table.

- f) Using the normal editing procedure (**SELECT/NEXT**), select a valid option for each feature presented. The configuration mode may not be left until all options are completed.
- g) It is up to you to ensure that the selected options are compatible with each other and with the hardware being used. If they are not, the control head may not operate correctly. Read the following table carefully to ensure that you understand the configuration options completely.

3.12.2 Configuration Option Table

FEATURE	VALID OPTIONS	COMMENTS	S/W VER.*
# OF RADIOS	2,3,4	This is the maximum number of radios the control head can handle, not the number installed.	2.00
DIGITAL GRD or DPL CODES	ON,OFF	Controls the Digital Channel Guard option for all NT-series radios installed. (Digital Channel Guard is also known as Digital Private Line or DPL)	2.00
MASTER C/H	ON,OFF	Determines whether this control head will act as a master in a master/slave setup. Normally OFF.	2.00
# OF SLAVES	0,1,2	Set to the # of slaves that are connected to this master control head. This feature supersedes the MASTER C/H feature.	2.26
STATUS DISPLAY ON POWER-UP	ON,OFF	Determines whether or not the radio status lines are displayed on power-up.	2.20
HELP DISPLAY ON POWER-UP	ON,OFF	Determines whether or not the help information option is displayed on power-up.	2.47
DATA PAD PORT	0,A,B,C	Set to the serial port that the master control head's Data Entry Pad is connected to. Set to 0 if you do not have a Data Entry Pad. Port A is on the main system connector. Ports B and C are on the optional auxiliary serial I/O board connector.	2.26
RADIO	RT-9600, RT-7200, RT-30, RT-138, RT-450, 450-SYS, RT-406, 406- SYS, NT30A, NT30B, NT136, NT150, NT403, NT450, NT450A, NT450B, NT450C, NT806, FF-40, SYN I, SYN XTR, 2x5,2x5 EXT,PAR BCD, 805-1, SPEC L, SPEC L1, SPEC L2, ASTRO, NTX138, NTX066, NTX403	Selects the radio type for each slot. Make sure that the radio type selected matches the interface board installed in that slot. The 450-SYS and 406-SYS options simulate the C-1000 control head (with an RT-450 or RT-406F as the UHF RT). SPEC = SPECTRA, L indicates a standard radio, L1 indicates control set up with a 'Zone' switch, L2 is Reserved (S/W Ver. 2.44)	2.00

FEATURE	VALID OPTIONS	COMMENTS	S/W VER.*
CHANS. INST.	6, 12, 16, 22, 32, 64, 80, 96, 99, 100, 125, 126, 127, 128	The number of channels available for each radio. Does NOT include guard channels. Ensure that the number of channels is valid for the radio-type selected as follows: RT9600/7200 - any up to and including 126 FLEXCOMM - any up to and including 127 FLEXCOMM SYSTEM - any up to and incl. 125 NT SERIES - 32,64,96,128 FF40 - 6,12,16 SYNTECH I - 80 SYNTECH XTR - 100 ARINC 2x5 and PARALLEL BCD - any 805-1 - 99 ASTRO, SPECTRA - any NTX138, NTX066, NTX403 - any	
**RT9600 TONES	8, 32	Set to 8 if using the internal RT9600/7200 tones. Set to 32 if using the internal TAC/COM tones.	2.20
**RT9600 GRD	NONE, ST-ED, F/P	Set to NONE if there is no RT9600/7200 guard receiver installed. Set to ST-ED if using the Status Edit mode to control the RT9600/7200 guards. ST-ED option is invalid if 'RT9600 TONES' is set to 32. Set to F/P if using the extra TAC/COM Front Panel controls to control the RT9600/7200 guards.	2.20
**NTX MODE	FM ONLY/FM & AM	Allows selection of modulation type (AM applicable to NTX138-300 only)	2.47
**RT9600 P/BW	P/BW	Allows selection of either Transmit Power control or Bandwidth control	2.47
**NT GRD INST	YES, NO	This line will appear once for each NT-series radio that is installed. Set to YES for each radio that has a guard receiver installed.	2.21
**NT136	FM ONLY, AM/FM	This line will appear once for each NT136-type radio that is installed. Set to FM ONLY for a standard NT136 radio. Set to AM/FM for an NT136-PAS radio.	2.22
**CHAN LBL	C/H, SPECTRA	This line will appear once for each SPECTRA-type radio that is installed. These selections indicate the source of the Labels (LBL) displayed, either from the Control Head or the Spectra radio.	2.44
** ASTRO TYPE	W4, W5, W7, W9	This line will appear once for each ASTRO-type radio that is installed. These select the type of Astro control head for which the T99 Astro radio has been configured. Note: For the XTL series, W9 MUST be selected for proper operation	2.52

* Software version in which the feature was introduced.
Except where otherwise noted, all later versions also include the feature.

** These will appear only if the radio has been selected in the 'RADIO' box of the Feature column.

End of section 3

Free Manuals Download Website

<http://myh66.com>

<http://usermanuals.us>

<http://www.somanuals.com>

<http://www.4manuals.cc>

<http://www.manual-lib.com>

<http://www.404manual.com>

<http://www.luxmanual.com>

<http://aubethermostatmanual.com>

Golf course search by state

<http://golfingnear.com>

Email search by domain

<http://emailbydomain.com>

Auto manuals search

<http://auto.somanuals.com>

TV manuals search

<http://tv.somanuals.com>