



Installation and Operation

Link Wireless Telephone System
Link 150 M3 MCU

Part Number: 72-0075-01
Issue C-W

NOTICE

SpectraLink Corporation has prepared this document for use by SpectraLink personnel and clients. The drawings and specifications contained herein are the property of SpectraLink and shall be neither reproduced in whole or in part without the prior written approval of SpectraLink, nor be implied to grant any license to make, use, or sell equipment manufactured in accordance herewith.

SpectraLink reserves the right to make changes in specifications and other information contained in this document without prior notice, and the reader should in all cases consult SpectraLink to determine whether any such changes have been made.

The terms and conditions governing the sale of SpectraLink hardware products and the licensing of SpectraLink software consist solely of those set forth in the written contracts between SpectraLink and its customers. No representation or other affirmation of fact contained in this document including but not limited to statements regarding capacity, response-time performance, suitability for use, or performance of products described herein shall be deemed to be a warranty by SpectraLink for any purpose, or give rise to any liability of SpectraLink whatsoever.

In no event shall SpectraLink be liable for any incidental, indirect, special, or consequential damages whatsoever (including but not limited to lost profits) arising out of or related to this document, or the information contained in it, even if SpectraLink has been advised, knew, or should have known of the possibility of such damages.

Trademark Information

SpectraLink

Wireless@work

LinkPlus

Link Wireless Telephone System

NetLink Wireless Telephone System

ccLink Wireless Telephone System

are trademarks and registered trademarks of SpectraLink Corporation.

All other trademarks used herein are the property of their respective owners.

Link 150 M3 Master Control Unit System Documentation

© 2001 SpectraLink Corporation.

All Rights Reserved

Printed in the United States of America

SpectraLink Corporation 5755 Central Avenue Boulder, CO 80301 303.440.5330 or 800.676.5465 www.spectralink.com

Note concerning the Master Control Unit:

This equipment has been tested and found to comply with the limits for a Class A digital device, pursuant to Part 15 of the FCC Rules. These limits are designed to provide reasonable protection against harmful interference when the equipment is operated in a commercial environment. This equipment generates, uses, and can radiate radio frequency energy and, if not installed and used in accordance with the instruction manual, may cause harmful interference to radio communications. Operation of this equipment in a residential area is likely to cause harmful interference in which case the user will be required to correct the interference at his own expense.

Note concerning shielded cable:

SpectraLink recommends the use of shielded cable for all external signal connections in order to maintain FCC Part 15 emissions requirements.

Note concerning the Wireless Telephone and Base Stations:

This device complies with Part 15 of the FCC Rules. Operation is subject to the following two conditions: (1) This device may not cause harmful interference, and (2) this device must accept any interference received, including interference that may cause undesired operation.

WARNING Changes or modifications to this equipment not approved by SpectraLink Corporation may cause this equipment to not comply with part 15 of the FCC rules and void the user's authority to operate this equipment.

WARNING SpectraLink products contain no user-serviceable parts inside. Refer servicing to qualified service personnel.

UL Information



This symbol on the nameplate means the product is listed by Underwriter's Laboratories, Inc. It is designed and manufactured to meet rigid U.L. safety standards against X-radiation, fire, casualty, and electrical hazards.

The following are statements required for UL certification, related to safety procedures that must be adhered to during installation.

Follow these general precautions while installing telephone equipment:

- Never install telephone wiring during a lightning storm.
- Never install telephone jacks in wet locations unless the jack is specifically designed for wet locations.
- Never touch uninsulated telephone wires or terminals unless the telephone line has been disconnected at the network interface.
- Use caution when installing or modifying telephone lines.

When installing Base Stations outside or in buildings other than the one containing the System Controller, take the following precaution:

If wiring for a Base Station exits a building—whether to reach an outdoor Base Station location or to reach a Base Station in another building—the wiring must be protected at both ends by a Quick Clip Fuse from Illinois Tool Works, Linx Division, model number SCP-2X2. The Quick Clip Fuse replaces the bridging clips on the 66 blocks for all four connections to the non-internal Base Station.

FCC Information

The Master Control Unit Complies with Part 68, FCC Rules

FCC Registration Numbers:

Link 150: IYGUSA-33400-PX-E

Ringer Equivalence:

Link 150 Model 3: 0.3B

SpectraLink Corporation

Link 150

Made in the USA

This equipment complies with Part 68 of the FCC Rules. On the back of this equipment is a label that contains, among other information, the FCC Registration Number and Ringer Equivalence Number (REN) for this equipment. If requested, this information must be given to the telephone company.

This equipment uses RJ-21 connectors.

The REN is useful to determine the quantity of devices you may connect to your telephone line and still have all of those devices ring when your number is called. In most, but not all, areas, the sum of the RENs of all devices connected to one line should not exceed five (5.0). To be certain of the number of devices you may connect to your line, as determined by the REN, you should contact your local telephone company to determine the maximum REN for your calling area.

If your telephone equipment causes harm to the telephone network, the telephone service may discontinue your service temporarily. If possible, they will notify you in advance. But if advance notice isn't practical, you will be notified as soon as possible. You will be informed of your right to file a complaint with the FCC.

Your telephone company may make changes in its facilities, equipment, operations or procedures that could affect the proper functioning of your equipment. If they do, you will be notified in advance to give you an opportunity to maintain uninterrupted telephone service.

If you experience trouble with this telephone equipment, please contact:

SpectraLink Corporation

5755 Central Avenue

Boulder, CO 80301

303-440-5330

for information on obtaining service or repairs. The telephone company may ask that you disconnect this equipment from the network until the problem has been corrected or until you are sure that the equipment is not malfunctioning. There are no user serviceable parts in this equipment.

This equipment may not be used on coin service provided by the telephone company. Connection to party lines is subject to state tariffs.

Industry Canada (IC) Notice

Notice:

The Industry Canada (IC) label identifies certified equipment. This certification means that the equipment meets telecommunications network protective, operational, and safety requirements as prescribed in the appropriate Terminal Equipment Technical Requirements document(s). The department does not guarantee the equipment will operate to the user's satisfaction.

Before installing this equipment, users should ensure that it is permissible to be connected to the facilities of the local telecommunications company. The equipment must also be installed using an acceptable method of connection. The customer should be aware that compliance with the above conditions may not prevent degradation of service in some situations.

Repairs to certified equipment should be coordinated by a representative designated by the supplier. Any repairs or alterations made by a user to this equipment, or equipment malfunctions, may give the telecommunications company cause to request the user to disconnect the equipment.

Users should ensure for their own protection that the electrical ground connections of the power utility, telephone lines and internal metallic water pipe system, if present, are connected together. This precaution may be particularly important in rural areas.

Caution: Users should not attempt to make such connections themselves, but should contact the appropriate electric inspection authority, or electrician, as appropriate.

Notice: The Ringer Equivalence Number (REN) assigned to each terminal device provides as indication of the maximum number of terminals allowed to be connected to a telephone interface. The termination of an interface may consist of any combination of devices.

REN 0.3B

Approval Numbers:

Link 150: 2128-9760 A

Warranty and Repair Service Center:

SpectraLink Corporation
5755 Central Avenue
Boulder, CO 80301
303-440-5330

DOC Spread Spectrum certification

Base Station	Cert. No.	2128-K1373
Wireless Telephone	Cert. No.	2128-K1374

Warranty Support Program

World-class support for your Wireless Telephone System

Service Overview	<p>The SpectraLink Warranty Support Program provides predictable no cost factory repair and telephone technical support for the first twelve months you own your system. Services include overnight parts replacement for SpectraLink infrastructure components, repair or replacement of defective Wireless Telephones shipped within three-days of receipt at our factory, and technical telephone support seven days a week, twenty-four hours a day, including weekends and holidays. You can choose to upgrade your first year warranty on either infrastructure or Wireless Telephones, or both. See details below.</p>
Service Coverage	<p>All models within the Link 150 and Link 3000 product families, Link WTS Base Stations, Wireless Telephones, and the full range of NetLink products.</p>
Term	<p>Twelve (12) month warranty on hardware and software.</p>
Service Features	<p>In conjunction with customer-provided on-site labor resources, SpectraLink Warranty Support provides high-quality parts repair and at no additional charge. SpectraLink uses a hotline as the first level of support to facilitate problem solving and provide technical assistance. Telephone response is immediate. Ensuing problems will be escalated according to established policies to effect timely resolution of problems.</p> <p>Telephone Technical Support is provided seven days a week, twenty-four hours a day, including weekends and holidays. On-site technical support may be purchased at \$100 per hour during business days (8am to 5pm), and \$150 per hour after business hours.</p> <p>Software that fails in normal operation and/or does not conform to published specifications will be repaired or replaced as appropriate.</p> <p>After-Hours Remote Testing can be purchased at \$750 per year. This service option provides for SpectraLink to access their system via dial-up after hours and perform diagnostics on all infrastructure equipment. Infrastructure failures will be automatically logged and the customer notified the following business morning.</p>
Warranty Upgrade	<p>Customers may upgrade the warranty repair of their Wireless Telephones from three-day factory repair to advanced replacement. Customers may also increase the level of support of their infrastructure to next business day on-site service from advanced parts replacement, which includes after-hours remote diagnosis at no additional charge.</p>
SpectraLink Responsibilities	<ol style="list-style-type: none"> 1. Provide toll-free hotline telephone number for accessing SpectraLink Technical Support and placing a service request. 2. Provide technical telephone assistance during the PPM. 3. Provide parts repair and replacement services in accordance with response time commitments. 4. Provide 45 days prior written notice of the service period expiration.

Customer Responsibilities	<ol style="list-style-type: none">1. Maintain the installation site and provide the necessary utility services for use of the Product in accordance with SpectraLink's applicable published specifications, see installation guide.2. Provide all on-site labor necessary to assist SpectraLink in troubleshooting; and for receiving, replacing, and returning all parts required to effect a repair.3. Provide unattended dial-up modem access to the system for remote diagnosis by SpectraLink service personnel.4. Customer will return to SpectraLink all defective equipment for which an advanced shipment replacement has been made within ten business days. Failure to return replaced items within the above-referenced period will result in a customer obligation to pay full purchase price for the replacement item.
Return Material Authorization	All equipment failures must be verified by a SpectraLink Customer Support representative and assigned a Return Material Authorization (RMA) number. Replacement equipment will not be shipped without an RMA number assigned. Equipment received by SpectraLink without an RMA number will be returned to the customer without being repaired.
Exclusions	<p>The following services are not included under this Agreement:</p> <ol style="list-style-type: none">1. Support of Products not listed under the Coverage section above.2. On-site services performed by SpectraLink to effect repair.3. Services required to repair Product which has been opened, disassembled, or otherwise tampered with due to unauthorized attempts by persons other than SpectraLink employees or persons authorized by SpectraLink to install, repair, maintain, or modify the hardware or software.4. Services required due to causes external to the SpectraLink maintained Products including, but not limited to fire, flood, lightning, physical abuse, immersion in liquids, or exposure to solvents.5. Services in connection with the relocation of the Product, or the addition, removal, or maintenance of other devices not furnished by SpectraLink, including communications devices, networks, or links.
Termination	SpectraLink requires 30-days written notice to cancel any optional services purchased to upgrade the SpectraLink Warranty Support . Such written notice must be on company stationary and indicate the date on which the cancellation is to be effective. SpectraLink will credit the customer any unused prepaid maintenance fees, calculated on a pro rata basis.

Cleaning Tips for Wireless Telephones

Wireless Telephones may occasionally need to be cleaned to maintain appearance. Generally, wiping the handset surface with a clean, water-dampened cloth or paper towel will remove most films or residues. If the soiling is too stubborn for plain water, a mild detergent solution may be used. Be sure to wipe away any detergent residue with a plain water dampened cloth.

DO NOT IMMERSER WIRELESS TELEPHONES IN WATER OR OTHER LIQUID.

The Wireless Telephone may be cleaned with any general-purpose household glass and surface type cleaner. Spray the cleaner on a soft cloth or paper towel, then wipe the surface.

DO NOT SPRAY THE HANDSET DIRECTLY.

Pre-treated cloths, like those used for eyeglasses or cameras, may be used to clean the Wireless Telephone. Pre-moistened towelettes may also be used. Avoid those containing lanolin or aloe as it will leave a slippery residue.

The surface of the handset may be cleaned occasionally with disinfectants used for general cleaning in a medical environment. Isopropyl alcohol may be used occasionally applied by a damp cloth or paper towel. When using alcohol, do not rub the keypad characters vigorously. Doing so will significantly degrade legibility.

- Do not use furniture polishes, waxes or plasticizer-based cleaner (Armor All™, etc.)
- Do not use lanolin, aloe, glycerin or other skin care type products.
- Do not apply any solvent such as acetone, mineral spirits etc.
- Do not directly spray or immerse the handset.

Should the headset connector become dirty, a scratchy or intermittent signal may be experienced. To clean the connector, dip the non-padded end of either a wooden or paper handled cotton swab in isopropyl alcohol. *Gently* insert in the connector and twist, repeating several times. If available, blow compressed air into the connector to clear debris.

Table of Contents

1. ABOUT THIS DOCUMENT	1
1.1 Questions?	1
1.2 Icons and Conventions	1
1.3 Installation Overview	1
2. LINK WIRELESS TELEPHONE SYSTEM OVERVIEW	3
2.1 System Operation	3
2.2 The Front Panel of the Link 150 M3 MCU	5
3. SITE PREPARATION	6
3.1 Required Materials	6
3.2 Determine Location of MCU	6
4. RUN CABLE FOR SYSTEM	7
4.1 Run Cables to Base Station Locations	7
4.2 Pull Cable	8
4.3 Terminate Cable at Base Station Locations	8
4.4 Prepare Demarc Blocks	9
4.5 Install Demarc Blocks	13
4.6 Assign and Program Ports	13
4.7 Connect Cables from Base Stations and Phone Lines to Demarc Blocks	14
5. INSTALL LINK WIRELESS TELEPHONE SYSTEM	18
5.1 Survey Site	18
5.2 Check Components	18
5.3 Install MCUs	19
5.4 Install Base Stations	23
5.5 Install Outdoor Base Stations	25
6. CONNECT AND REGISTER WIRELESS TELEPHONES	26
6.1 Set Up Diagnostic Modem	26
6.2 Register Wireless Telephones	26
6.3 Unregister Wireless Telephones	27
6.4 Program Wireless Telephone Features	28
6.5 Test Wireless Telephones	28

7. SITE CERTIFICATION	29
8. SYSTEM ADMINISTRATION	30
8.1 Troubleshoot Error Codes	30
8.2 Troubleshoot Phone Features	30
8.3 Status LED Codes	31
8.4 Replace a Wireless Telephone	35
8.5 Replace an MCU	36
8.6 Replace a Base Station	37
9. WIRELESS TELEPHONE PLANNING WORKSHEET	38
10. BASE STATION LOCATION WORKSHEET	39
11. APPENDIX A: TECHNICAL PARAMETERS	40
11.1 Select Alternate Spread Spectrum Sequence	40
11.2 Change Companding	41
12. APPENDIX B: PROGRAM ANALOG FEATURES	42
12.1 Defining Macros	42
12.2 Plan Programming	42
12.3 Program Macro Codes	43
12.4 Examples of Programming	44
13. APPENDIX C: INSTALLING THE OPEN APPLICATIONS INTERFACE (OAI) TELEPHONY GATEWAY	45
13.1 Before Installing the OAI Telephony Gateway	45
13.2 The OAI Telephony Gateway's Front Panel	46
13.3 Mount Telephony Gateway to Wall	46
13.4 Initial Test	47
13.5 Connect the OAI Telephony Gateway to the MCU	48
13.6 Connect the OAI Telephony Gateway to the Application Server	49
13.7 Assign A Function Key to OAI Telephony Gateway	49
13.8 Certification Test	50

1. About This Document

This document explains installation and operation of SpectraLink's Link Wireless Telephone System (WTS), using the Link 150 Model 3 (M3) Master Control Unit (MCU). The Link 150 M3 MCU adds wireless service to your existing telephone system. The installation process connects the Link Wireless Telephone System to your telephone system, and activates SpectraLink Wireless Telephones.

1.1 Questions?

SpectraLink wants you to have a successful installation. If you have questions please contact

SpectraLink Customer Support Hotline at (800) 775-5330..

The Hotline is open Monday through Friday, 7:00 AM to 6:00 PM Mountain Time.

1.2 Icons and Conventions

This manual uses the following icons and conventions.



Caution! Follow these instructions carefully to avoid danger.



Note these instructions carefully.

NORM

This typeface indicates a key, label, or button on the MCU or Wireless Telephone.

1.3 Installation Overview

Installation has three phases. In most cases, a separate person is responsible for each phase.

- **Site preparation and wire installation** – this is usually done by a wire technician or contractor.
- **Installing the SpectraLink system** – this is done by SpectraLink or one of our certified distributors.
- **Programming the customer's telephone system to work with the SpectraLink system** – this is usually done by the customer's system administrator or technician.

Because these major steps require some parallel activities, it is important to coordinate the activities among the persons involved.

This table lists the installation steps and the person usually responsible for each step.

✓	Task Description	Wire Contractor	Installer	System Admin
	Site Preparation			
	Determine Location of MCU			✓
	Run Cable for System			
	Run Cable to Base Station Locations	✓		
	Pull Cable	✓		
	Terminate Cable at Base Station Locations	✓		
	Prepare and Install Demarc Blocks	✓		
	Assign and Program Ports			✓
	Connect Cables to Demarc Blocks	✓		
	Install SpectraLink System			
	Survey Site and Check Components		✓	
	Install MCUs		✓	
	Install Base Stations		✓	
	Install Outdoor Base Stations	✓		
	Connect and Register Wireless Telephones		✓	
	Set Up Diagnostic Modem		✓	
	Register Wireless Telephones		✓	
	Program Wireless Telephone Features			✓
	Test Wireless Telephones		✓	
	Site Certification		✓	

2. Link Wireless Telephone System Overview

Review this section if you are unfamiliar with the features and operation of the Link Wireless Telephone System.

2.1 System Operation

The Link Wireless Telephone System (WTS) is a wireless communication system that offers direct telephone access for incoming and outgoing calls anywhere within a facility.

The Link WTS consists of three basic components: the Master Control Unit (MCU), the Base Station and SpectraLink Wireless Telephones. This diagram shows an overview of system. Components are described below.

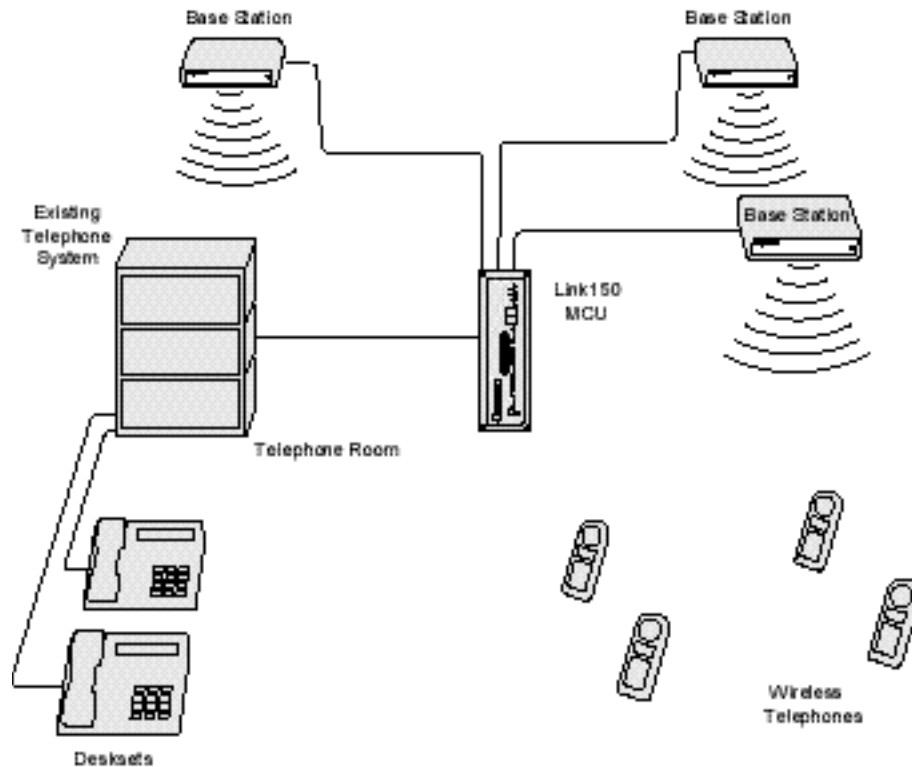

The Link Wireless Telephone System

- **Master Control Unit (MCU)** – serves as the connecting point, or gateway, between the Base Stations and the existing telephone system. One or more of these boxes (approximately 12 x 3 x 7 inches) are typically installed in the telephone equipment room and provide connectivity from the telephone system to the Link Wireless Telephone System. Each MCU is hard-wired to one or more Base Stations, which in turn provides the wireless link to each of the Wireless Telephones. The MCU establishes the connection from the telephone line to the appropriate Base Station in order to reach a Wireless Telephone.

The MCU supports four Base Stations and up to 16 Wireless Telephones. Up to four Link 150 M3 MCUs can be linked together for extended coverage area. Chained MCUs support up to 64 Wireless Telephones maximum.

SpectraLink offers an analog MCU that works with telephone systems (CO, PBX or Key Systems) with analog (loop start) ports. We also offer digital MCUs that work with the most common brands of telephone systems' (PBX or key systems) digital ports.

- **Base Stations** – act as a radio transceiver to provide the communications signal between the Wireless Telephone and the MCU. Base Stations are slightly larger than a smoke detector and are typically mounted on the ceiling, in strategic locations throughout the facility. A single Base Station can provide radio coverage for an area of 5,000 to 50,000 square feet depending on building obstructions. Base Stations may be located up to 2,200 cable feet from the MCU.

When a Wireless Telephone user makes or receives a call, the Wireless Telephone and Base Station establish a digital radio communication link. As the user moves around the coverage area, calls are “handed off” to the Base Station that is able to provide the best radio signal (typically the closest Base Station). These handoffs involve the Wireless Telephone establishing a communication link with another Base Station and dropping the previous link.

- **Link Wireless Telephones** – communicate with the Base Station using digital spread spectrum transmission at 902-928 MHz. Employees can carry Wireless Telephones to keep in contact as they move throughout the building. The Wireless Telephones use on-premise wireless technology; they are not cellular or satellite phones. They are connected to the facility's existing telephone system and, just like wired telephones, can receive calls directly, receive transferred calls, transfer calls to other extensions, and make outside and long distance calls (subject to the restrictions applied in your facility.)

2.2 The Front Panel of the Link 150 M3 MCU

The MCU's front panel contains the connections to the telephone system, switches to control system administration, and status LEDs.

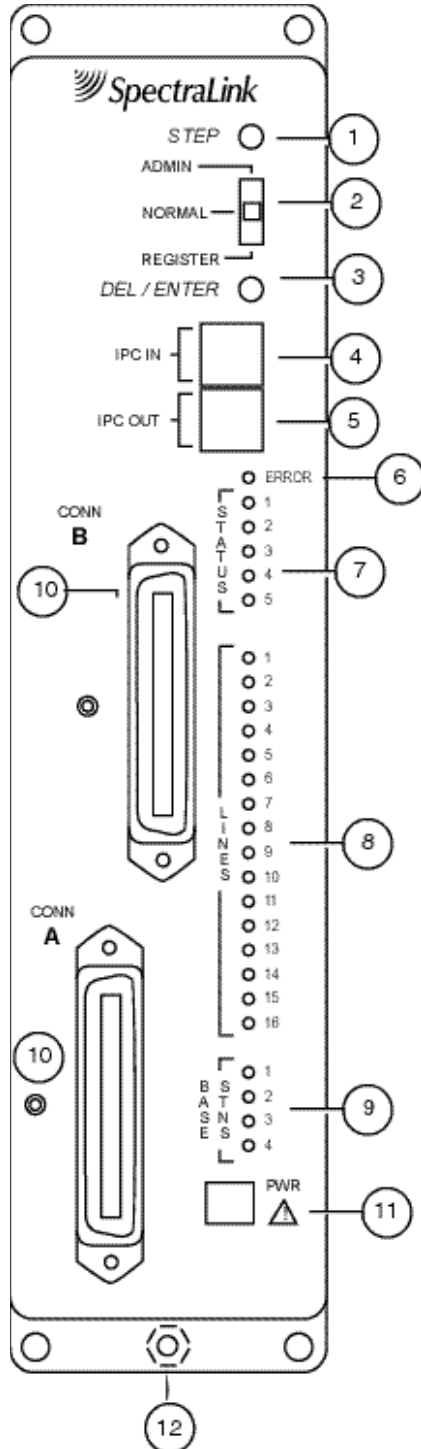

1. **STEP Button** – Selects a specific line or Base Station during registration process.

2. **Mode Switch** – Selects the mode of operation for the Link 150 Wireless Telephone System.

ADMIN: Administration mode, used to set up system features to match features on the telephone system.

NORMAL: Normal mode, used during day-to-day operations.

REGISTER: Registration mode, used to add or delete Wireless Telephones and Base Stations.

3. **DEL/ENTER Button** – Removes a registered Wireless Telephone from the system.

4. **IPC IN Port** – Used to connect preceding MCUs in a multi-MCU configuration.

5. **IPC OUT Port** – Used to connect sequential MCUs in a multi-MCU configuration or to connect to an Open Applications Interface (OAI) Telephony Gateway.

6. **Error LED** – Flashes when the system has detected an error. When flashing, check the Status LEDs for an error code.

7. **Status LEDs** – Indicate system error messages and status. Refer to *LED Status Codes* for more information.

8. **Line LEDs** – Indicate the line status of each Wireless Telephone: ringing, in use, or not active.

9. **Base Stn LEDs** – Indicate the status of each Base Station.

10. **Conn A or B** – RJ-21 connector to the cross-connect demarc block. Connector B is supplied and used only with 4 wire interface.

11. **Power Jack** – Connects to the AC adapter to supply power to the system.

CAUTION: Use only the provided Class II AC Adapter with output 24VDC, 1A.

12. **Grounding Lug** – For use on the analog interface MCU (SCA-5XX).

3. Site Preparation

3.1 Required Materials

The following equipment must be provided by the customer.

1. **Outlet Strip** – Recommended for installations with more than one MCU. This will allow the MCUs to be turned on and off together.
2. **Cross-Connect Block** – required to connect the telephone switch ports and the Base Stations to the MCU.
3. **25 Pair Cables** – RJ-21 male at MCU end, required to connect the MCU to the cross-connect blocks.
4. **Backboard space** – the MCU is designed to be wall mounted to $\frac{3}{4}$ " plywood securely screwed to the wall.
5. **Quick Clip Fuse** – Required with an RCO410 Outdoor Base Station or when a Base Station is located in a separate building from the Link 150 M3 MCU. Recommended Quick Clip Fuse is available from Illinois Tool Works, Linx Division, Model # SCP-2X2.
6. **Base Station Mounting Hardware** – If the Base Stations will be mounted on finished walls or ceilings, a 4-5" long $\frac{1}{4}$ " bolt, nuts, and washers will be required for each Base Station mounted.

3.2 Determine Location of MCU

Each MCU is approximately 2.75 inches wide, 12.5 inches high, and 7 inches deep, and weighs about 5 pounds. The unit is designed to be wall mounted over $\frac{3}{4}$ " plywood.

Select a location for the MCU with sufficient backboard space and an available outlet.

The MCU must be within 2,200 feet of the Base Stations.

All digital interface modules must be within 250 feet of the telephone system.

See your telephone system specifications for distance limitations for analog modules.

Since the front panel is used for cabling and as an operator's console, mount the units so the front panel is accessible.



If your system has more than one MCU, the units should be mounted vertically, side by side, physically touching the adjacent unit. Do not stack units on top of one another. Stacked MCUs can cause overheating and failure.

4. Run Cable for System

4.1 Run Cables to Base Station Locations

The Base Station locations should be designated on the building floor plans provided to the installer. Base Stations can be mounted easily on raised or acoustical ceiling tiles, or on the wall. Avoid locating Base Stations in high or hard-to-reach places, as this will hinder maintenance, testing, or repositioning.

Wire Specifications



The customer's wire contractor is responsible for adhering to all local codes for wiring.

SpectraLink recommends UL-Listed Wire that conforms to the following specifications for AWG, distance, and number of power pairs required for this installation.

Power Pairs	Max Cable Feet 22 AWG	Max Cable Feet 24 AWG	Max Cable Feet 26 AWG
1	1,100	750	470
2	2,200	1,500	940
3	2,200	2,200	1,400



One additional pair is required for Data.

Attenuation must not exceed 6.8 dB/1,000 feet @ 772KHz.

Wire that is already installed (spare house cable) can be used when it is available. House cable will usually run from the MDF in the telephone equipment room to Intermediate Distribution Frames (IDFs) spread throughout the facility. Install new wire from the closest IDF to the Base Station. Be sure no bridge taps, multiples, or "Y" connections are created or present.

Determine the amount of wire needed to connect the Base Station to the MCU by scaling from a floor plan or a sketch, pacing, measuring, or estimating. Remember to include enough wire to reach the ceiling.



The wire length between the MCU and each Base Station may not exceed 2,200 cable feet.

Install an extra 25 feet of wire at the Base Station to allow for possible relocation.

4.2 Pull Cable

Pull the cable from the MCU location (usually in the telephone equipment room) to the Base Station locations designated on the floor plans.



If the cabling exits the building, consult the telephone system manual, the NEC, and local codes for instructions on providing lightning and other over-current protection.

When cabling an external Base Station or a Base Station with wiring that exits the building, protect all Base Station wiring with the Quick Clip Fuse (Illinois Tool Works, Linx Division, SCP-2X2) before bridging with other Base Station power leads.

Run all cable before attaching the RJ-45 connectors to the Base Stations. Label both the demarcation block end and the Base Station end of each wire with the Base Station number using a wire tie marker or other form of marker.



Remove bridge taps, multiples, or "Y" connections to the Base Station wires; these will cause data transmission errors.

The area above some suspended ceilings is used as an environmental air plenum. The National Electric Code requires that wire installed in plenums be rated for plenum installation.

4.3 Terminate Cable at Base Station Locations

After running the wire to the Base Station location, terminate the wire using an RJ-45 modular crimp-on plug. Connect the data pair to pins 1 and 2 and the power pair to pins 7 and 8.

If the connection uses more than two pair, refer to the table on the following page.



To avoid damage to the connectors or crimps, be sure to run the wire to the Base Station before connecting the RJ-45 connectors.

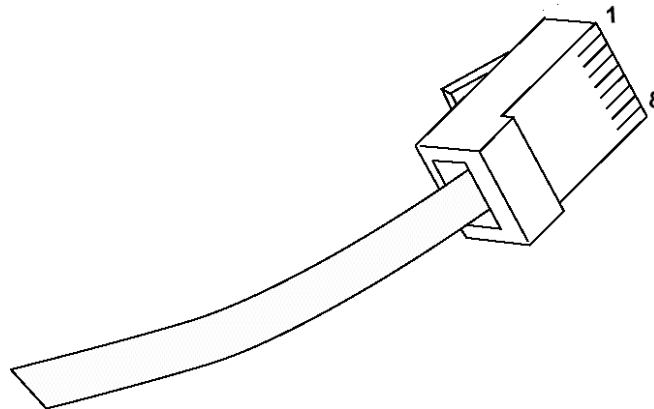

RJ-45 Modular Cable

When wiring the 8-pin connector, use the following table as a guide.

8-pin modular connector	MCU Pin Function	Polarity
1	Data 1	Any
2	Data 2	Any
3	Power 3	+
4	Power 2	-
5	Power 2	+
6	Power 3	-
7	Power 1	-
8	Power 1	+

4.4 Prepare Demarc Blocks

The MCU connects to the existing telephone system using RJ-21 connections. An MCU is designed to operate with a specific interface to the telephone system: two wire digital or analog, or four wire digital. The number of demarcation blocks required for the system depends on the number and type of MCUs installed.

Interface Type	MCU Part Number	Wire Pairs	# Blocks
Analog POTS	SCA-5XX	1	1
Universal Digital Interface (Norstar, Meridian, Comdial, Fujitsu, Inter-Tel, DEFINITY 2-wire, NEC, Rolm, Toshiba)	SCU-5XX	1	1
Merlin Legend and DEFINITY 4-wire	SCF-5XX	2	2
Mitel (DNIC)	SCX-5XX	1	1
Panasonic (Universal 2-wire Auxiliary Digital)	SCP-5XX	1	1
Executone (Universal 4-wire Auxiliary Digital)	SCB-5XX	2	2



If the wiring between the Link 150 M3 MCU and the telephone system leaves the building, consult your telephone system manual for instructions on providing adequate lightning and other over-current protection. All MCUs (except the analog interface SCA-5XX) are intended only for connection to the isolated side of an on-premise telephone switch. The interfaces are intended to connect to digital telephone switch ports that provide signals of 5Vp-p (max) AC component and some telephone switches provide a 48 V DC offset.

Based on the number and type of interfaces in the system, determine the number of 25-pair cables required to connect line ports and Base Stations to the demarcation blocks.

The diagrams which follow provide an overview of the connections.

Multiple Power Pairs

Some sites may prefer to wire Base Stations to a separate demarc block in order to split out power pairs.

Dedicated Line for Diagnostic Modem

The Link 150 M3 MCU can be accessed remotely using an internal modem. To use the modem for remote access, a dedicated dial-in line must be provided. On digital interface systems this line must be terminated as a digital extension to the MCU.

Two Wire Analog or Digital Interface

The wiring diagram below shows the connections required for a two-wire analog or digital interface.

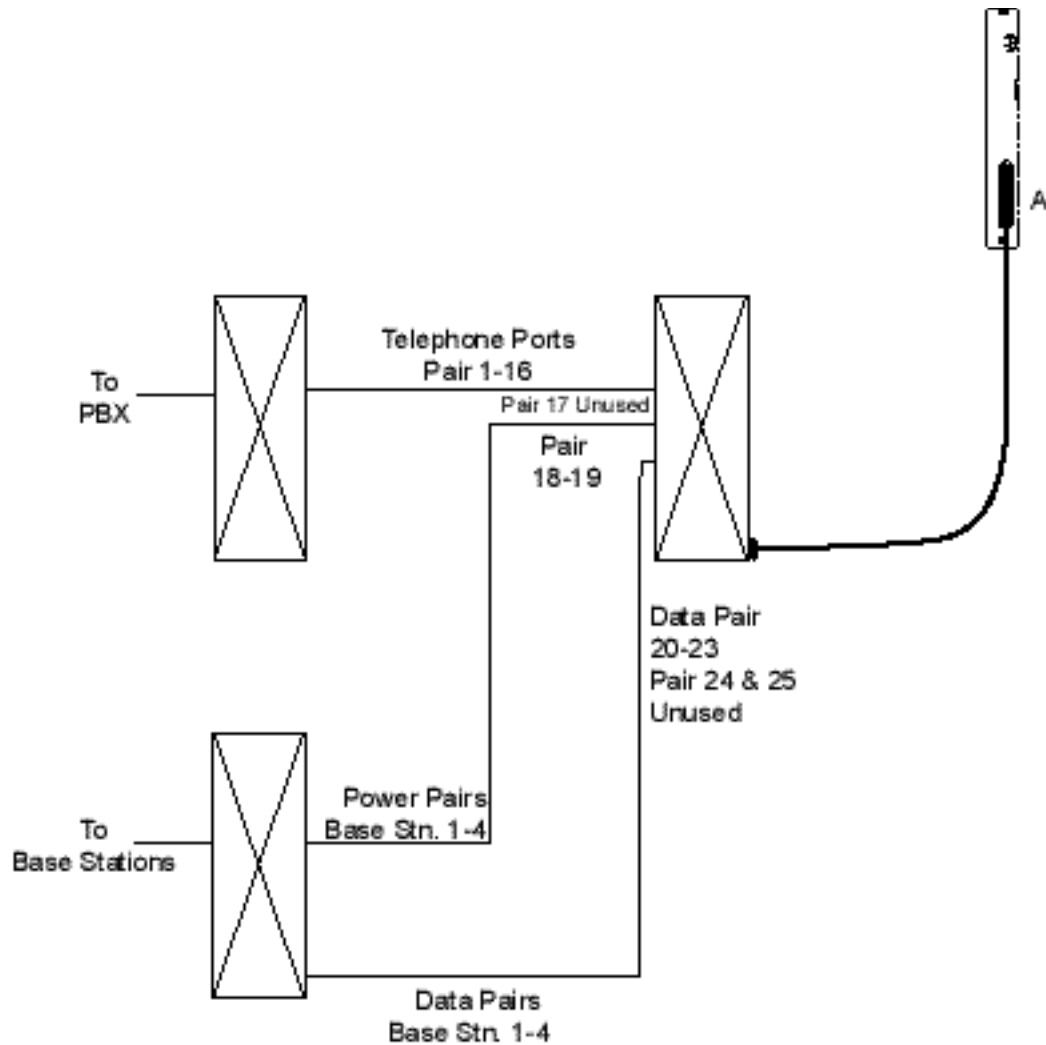

Two Wire Analog or Digital Connection

Four Wire Digital Interface

The wiring diagram below shows the connections required for a four-wire interface . Each MCU of this type requires two demarcation blocks which will be wired as indicated.

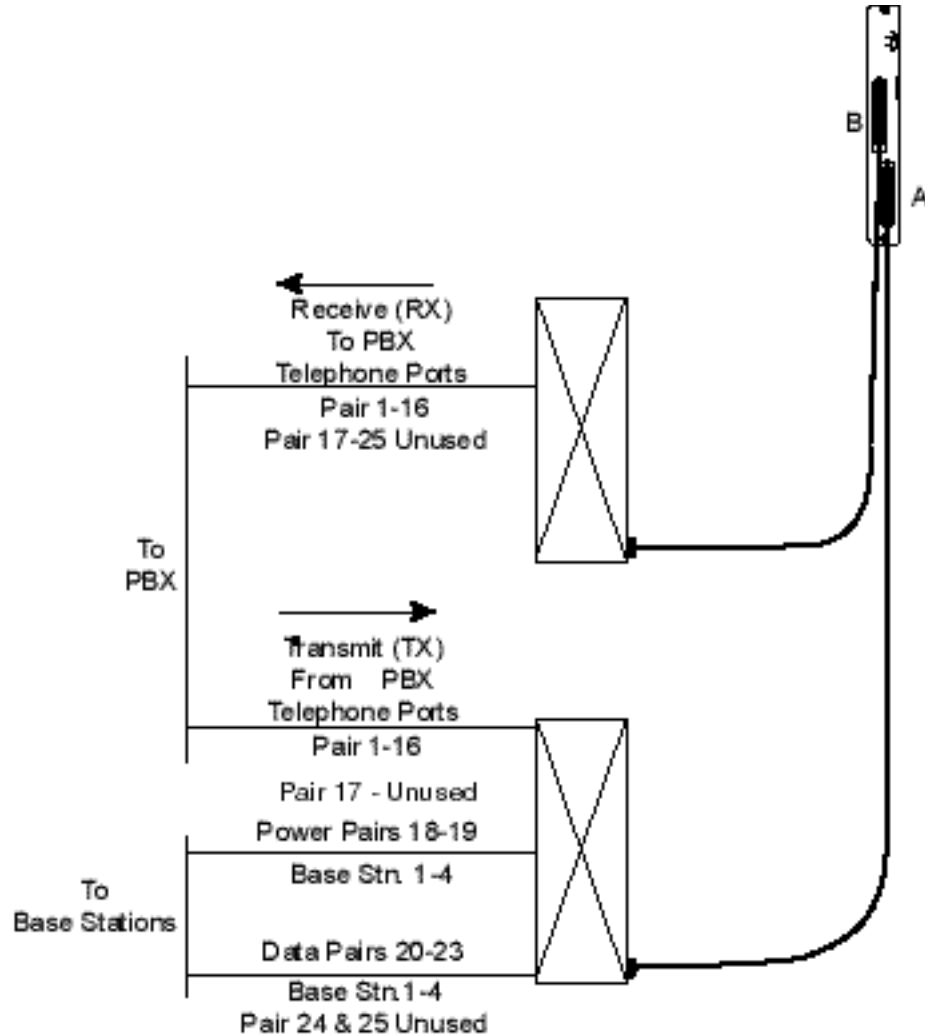

Four Wire Digital Connection

4.5 Install Demarc Blocks

The demarcation blocks used to connect the telephone system and Base Stations to the MCU should be installed on a typical telephone facility backboard. A ½" or ¾" thick board mounted on the wall near the MCU is typical. Although this manual uses 66-blocks as examples, any standard cross-connect blocks are acceptable.



When cabling an external Base Station or a Base Station with wiring that exits the building, protect all Base Station wiring with the Quick Clip Fuse (Illinois Tool Works, Linx Division, SCP-2X2) before bridging with other Base Station power leads.

If the cabling between the MCU and the telephone system leaves the building, consult the telephone system manual, the NEC, and local codes for instructions on providing lightning and other over-current protection.

4.6 Assign and Program Ports

The wire contractor should inform the system administrator which port numbers have been designated for the Wireless Telephones and the remote diagnostics modem line.

The system administrator must assign extension numbers to the Wireless Telephones and plan the functions (trunk access, toll restrictions, system features, ringing options etc.) to be programmed for the Wireless Telephones. This programming will be done after the Wireless Telephones are registered, but will be faster if it is planned in advance by verifying the parameters and features on the current telephone system and wired phones.

For details, refer to the section of *LinkPlus Digital Integration Guide* (PN 72-0070-00) for the type of telephone system for the MCU in use at your location.

4.7 Connect Cables from Base Stations and Phone Lines to Demarc Blocks

Two-pair twisted cable from Base Stations installed throughout the facility converge at the demarc block or backboard. Each MCU can support four Base Stations and up to 16 Wireless Telephones. The Base Station and Wireless Telephone cables are punched down onto the demarc/cross-connect blocks as shown in the demarc block diagrams below. Refer also to the diagrams in .

Photocopy the Base Station Location Form and Extension Assignments Worksheets provided in this manual as needed. Use the forms to track the Base Stations and Wireless Telephone port assignments connected to each MCU. As the installer makes each Base Station or Wireless Telephone connection, fill in the information on the form to identify the position of the Base Station or Wireless Telephone (the building and floor number, for example) and a detailed description of the location (perhaps a room number). A copy of this form should be posted near the cross-connect block.



Up to four Base Stations can be connected on a single MCU. Each Base Station uses 2 pair, one for data and one for power.



When cabling an external Base Station or a Base Station with wiring that exits the building, protect all Base Station wiring with fuse protection. One method is to use a Quick Clip Fuse (Illinois Tool Works, Linx Division, SCP-2X2) to provide protection from external wiring.

If the wiring between the MCU and the telephone system leaves the building, consult the telephone system manual, the NEC, and local codes for instructions on providing lightning and other over-current protection.

Two Wire Analog or Digital Demarc Block

The demarc block for the two-wire analog or digital interface should be wired as follows.

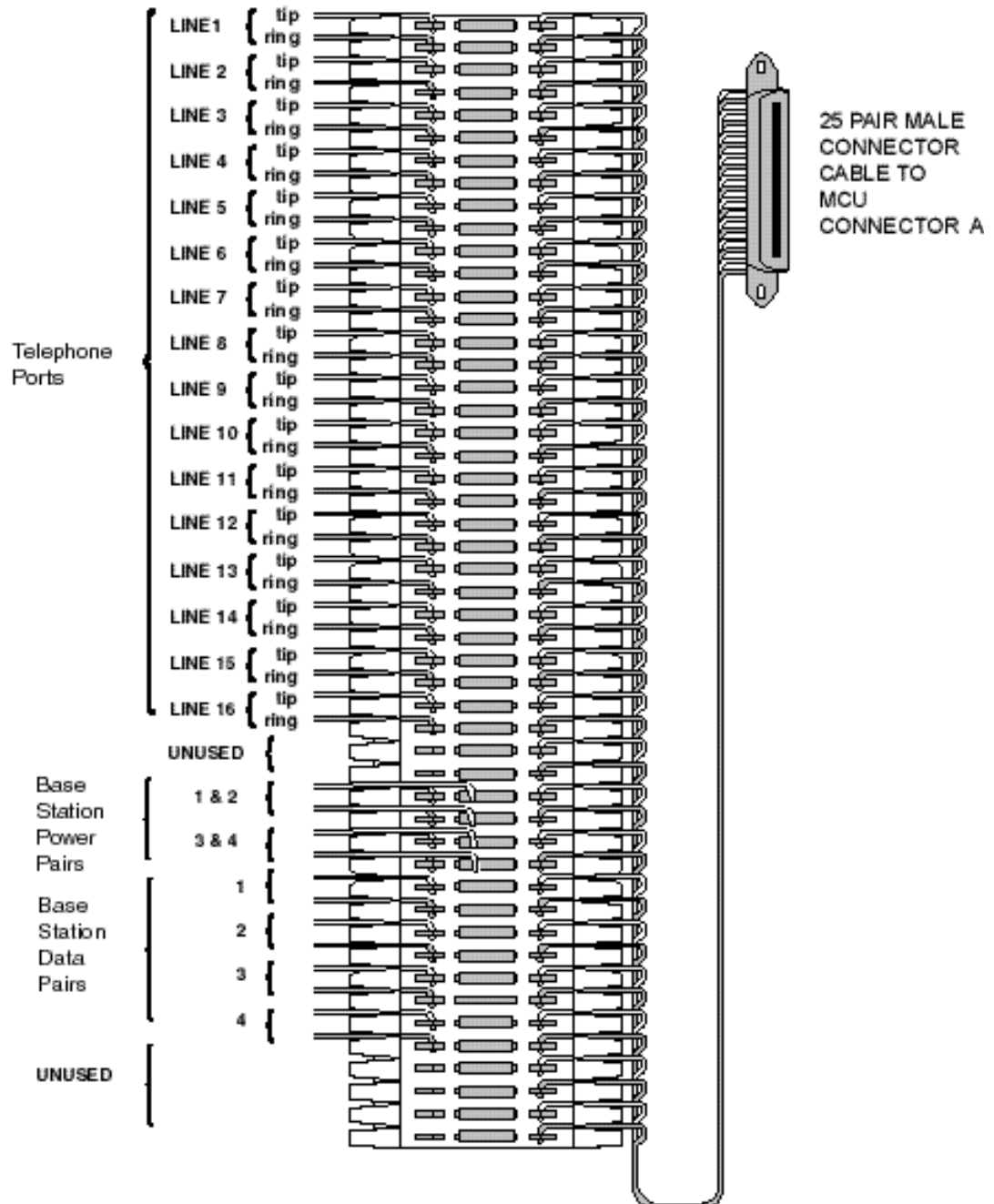

Four Wire Digital Demarc Block

The four wire digital interface (future release) requires two demarc blocks, one to Connector A and one to Connector B on the MCU. They should be wired as follows.

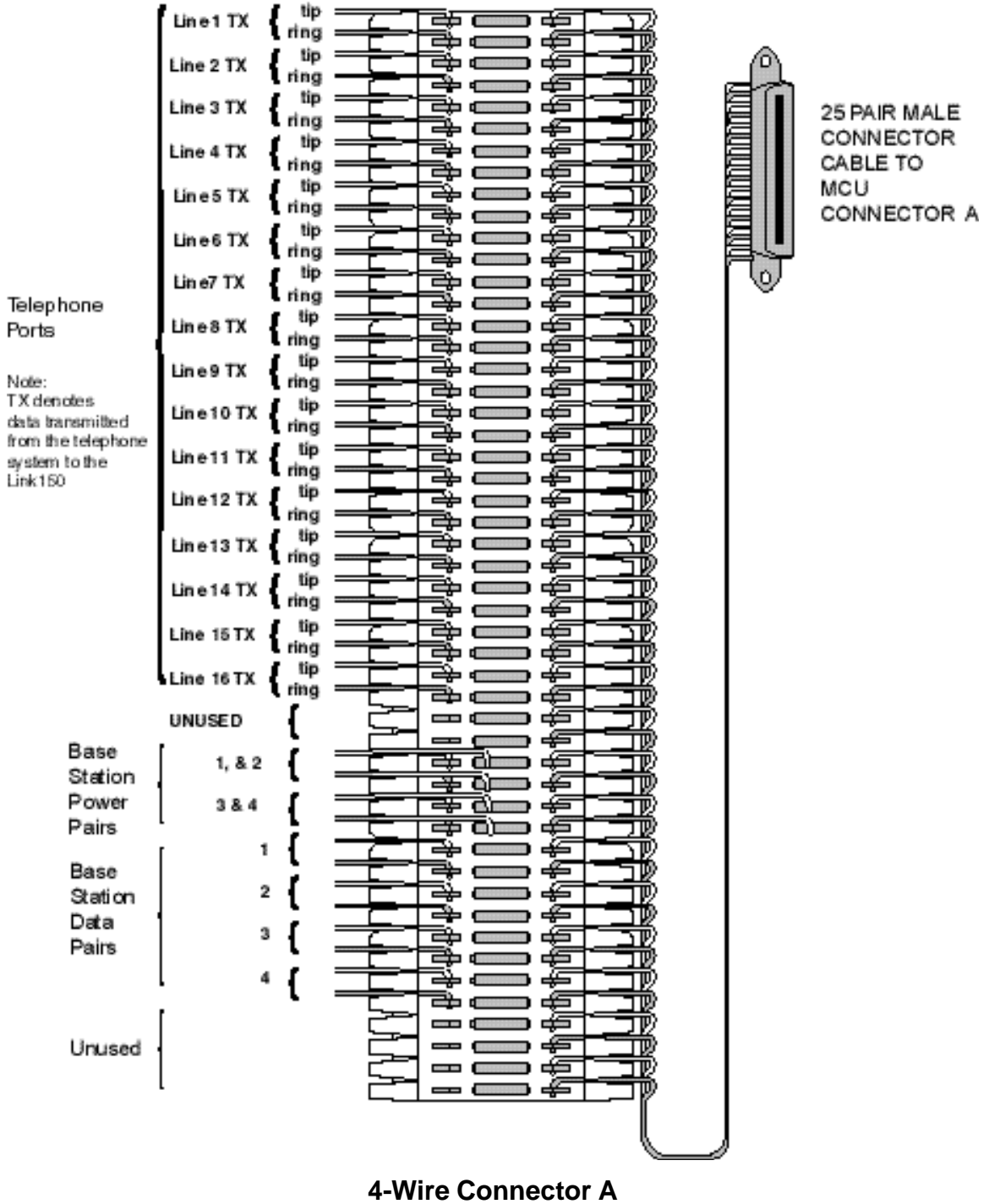

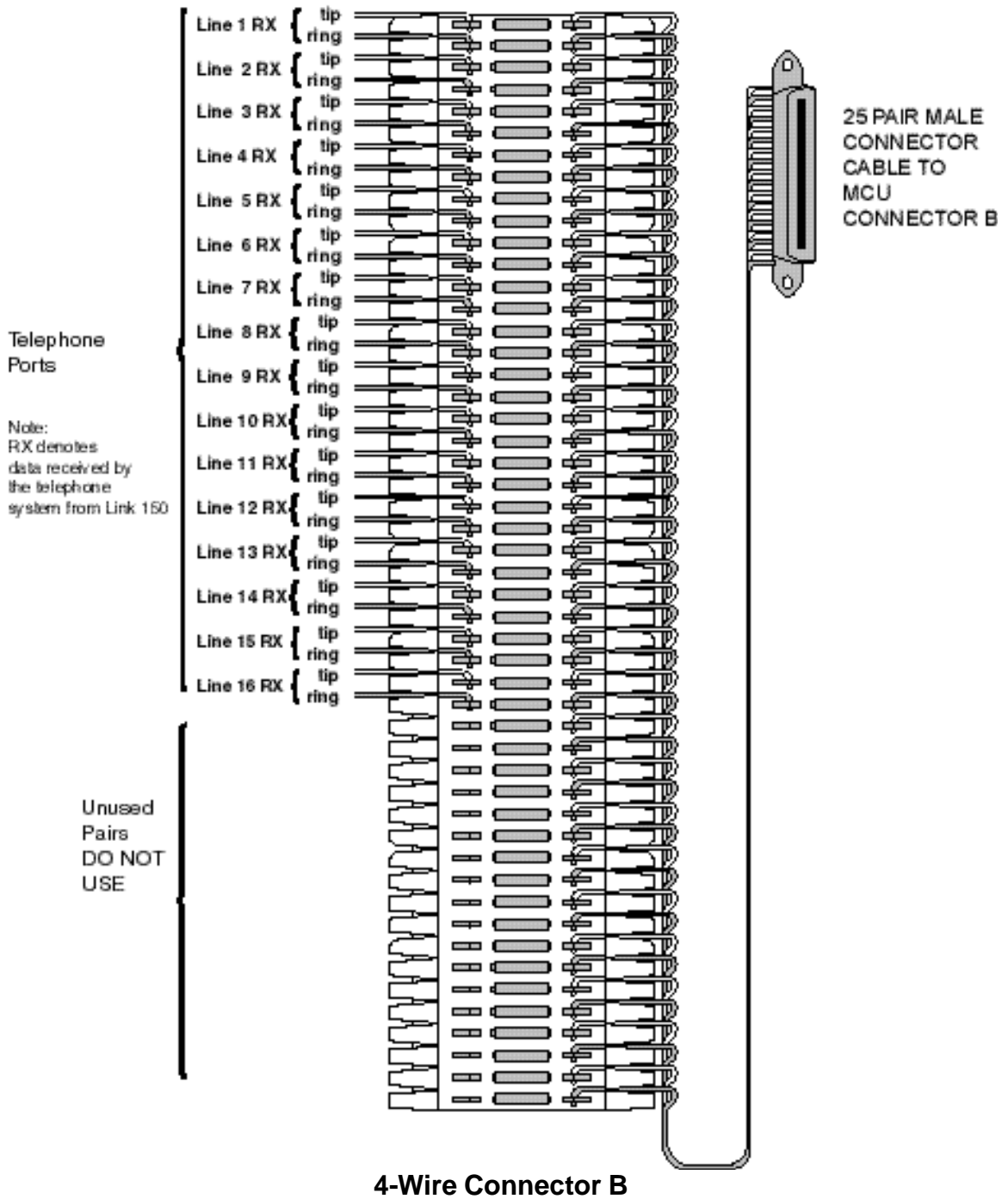

5. Install Link Wireless Telephone System

5.1 Survey Site

Check the site to be sure pre-installation work has been completed correctly. This includes:

- Location chosen for the MCU is adequate, and power is available.
- Wiring to Base Station locations has been pulled and correctly terminated.
- Phone lines for the Wireless Telephones are installed and properly terminated.
- Dedicated line is available for remote access to diagnostic modem.
- Telephone system administrator is on-site to program the existing telephone system.

If the work has not been completed, the SpectraLink installer can leave the site and reschedule the installation when the items have been completed or corrected, or assist in preparing the site.

5.2 Check Components

The following items should be at the installation site.

- Link 150 M3 Master Control Unit – Depending on the size of your system, there may be up to four MCUs, which will be chained together to extend the coverage area.



The Link Wireless Telephone System **MUST** contain only Link 150 M3 MCUs. Link 150 Model 2 MCUs or Model 1 MCUs cannot be used in an M3 system.

- **AC Adapter** – Supplies power to the Link 150 M3 MCU.



Use only the provided Class II AC Adapter with output 24VDC, 1A.

- **IPC Cable** – Each MCU is shipped with one Inter-Processor Communication (IPC) cable to carry signals between Link 150 M3 MCU units. It is used only when multiple MCUs are chained together.
- **Base Stations** – SpectraLink Part Number RCC 400/410 or RCO 400/410 (for outdoor use). Your system may have up to four Base Stations for each MCU shipped.
- **Base Station Mounting Hardware** – A ceiling clip and plastic bolt used to attach each Base Station to the T-bar ceiling tile grid.
- **MCU Mounting Hardware** – four #8-3/4” panhead wood screws and star washers, used to mount the MCU to the wall.
- **ESD Bonding Straps** – to provide static protection for the MCU.

- **Link Wireless Telephones** – The correct number of Wireless Telephones for this installation.
- **Battery Chargers** – SpectraLink Wireless Telephones require a battery charging system, usually one per Wireless Telephone.
- **Batteries** – The system may have one or more spare batteries per Wireless Telephone, depending on the needs at your location.
- **Documentation and Training Information** – This includes a Link Wireless Telephone User Guide for each telephone.

5.3 Install MCUs

Mount MCUs to Wall

The MCUs are designed to be mounted on a backboard of ¾ inch plywood, securely fastened to the wall. Mount the MCUs vertically, side by side, using 2.75 inch spacing center-to-center for each unit. Do not stack MCUs on top of one another.

To mount the MCUs:

1. Using a 1/8" drill bit, drill four pilot holes, on 2 inch by 12.1-inch centers.
2. If installing only one MCU, insert the #8 x 3/4 inch screws in the pilot holes and tighten, leaving a 1/8 to 1/4 inch gap from the wall.
3. If installing more than one MCU, the ESD bonding strap(s) must be installed between adjacent units:
 - 3.1 Remove the screws from the bottom of adjacent units.
 - 3.2 Place the ESD strap over the pilot holes that span two units and hold it against the plywood backboard.
 - 3.3 Place the star washer on top of the ESD strap.
 - 3.4 Insert the #8 x 3/4 screw and tighten to leave 1/8 to 1/4 inch gap from the wall.
 - 3.5 Repeat for all ESD straps.
4. Slide the MCU over the screws until it drops in place.
5. Tighten screws fully.
6. When installing an analog interface MCU (SCA-5XX), the grounding terminal in the rear panel of each unit must be electrically connected to earth ground. Consult the NEC and local codes for instructions on making the connection to the ground.

Connect MCU to Demarc Blocks

Connect the male RJ-21 connector from the appropriate demarcation block to the designated RJ-21 connector (A or B) on each MCU. Secure the cables using the keeper.

Connect Multi-Unit Systems

Use the following procedure to connect *multiple* MCUs.

1. Mount the MCUs side by side.
2. Connect the IPC cable from the OUT Port of the first unit to the IN Port of the adjacent unit. Repeat until all units are connected, as shown in the following illustration.

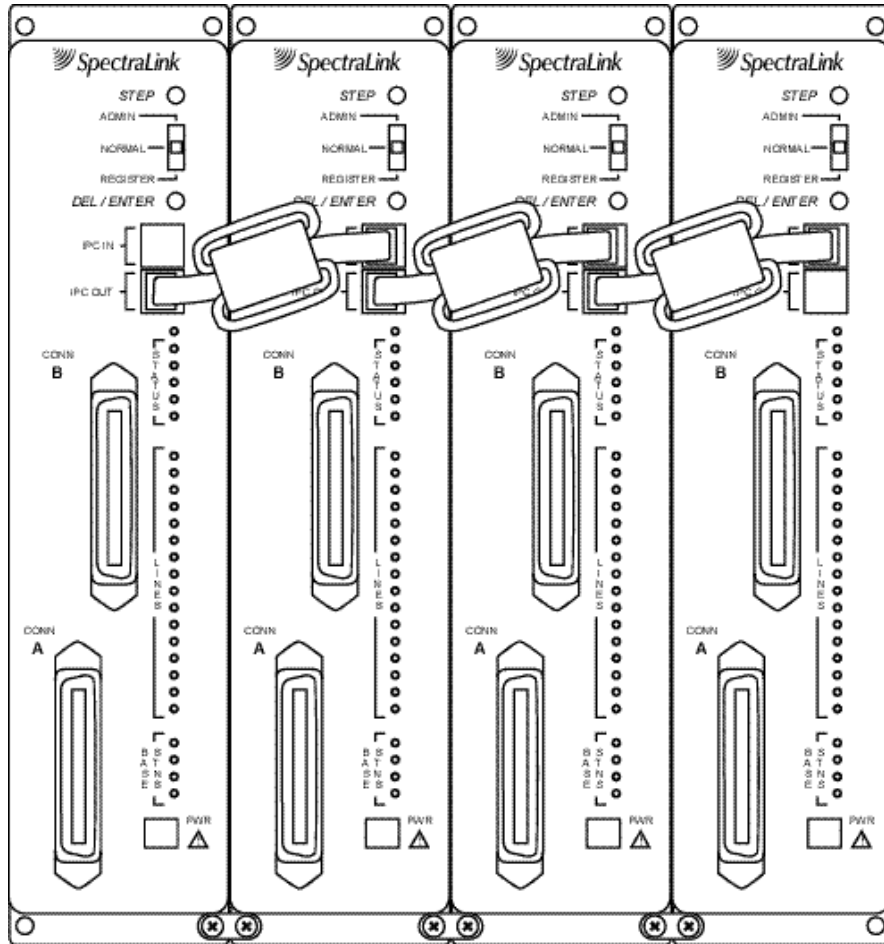

Multi-Unit Link 150 MCUs



No IPC cable is connected to the IN Port of the first unit. An Open Applications Interface (OAI) Telephony Gateway may be connected to the out port of the last unit.

Connect Power

1. Connect the power plug from the AC adapter to the jack labeled PWR on the MCU.



Use only the provided Class II AC Adapter with output 24VDC, 1A.



For installations with more than one MCU, use an outlet strip with a built in power switch. This allows the MCUs to be turned on and off together.

2. Plug the AC adapter into a 110VAC outlet or switch on the outlet strip to apply power to the MCU.

Set Switch Interface Type

The following steps explain how to assign a switch interface type to the MCU. This procedure **must be done in on each MCU**.

1. Power on the MCU with the Mode Switch in the **NORMAL** position.
Because the MCU does not have a switch type assigned, it will alarm (the Error LED will flash along with Status LEDs 1,2,3,4 and 5). This should take less than 2 minutes.
2. Power off the MCU.
3. Move the Mode Switch to **ADMIN** and power on the MCU. Within 15 seconds, Status LEDs 2 and 4 will light.
4. Press the **STEP** button three times.
Status LEDs 1, 2 and 4 must be lit. Line LEDs 1 through 8 (indicating an unconfigured MCU) should also be lit.
If any other combination of Line LEDs is lit, then a switch type has already been selected. Go to step 5 to pick the desired switch type.
5. Press the **DEL/ENTER** button to select the correct switch interface type. With each press of the **DEL/ENTER** button, a different series of Line LEDs will be lit. Continue to press **DEL/ENTER** until the correct Line LEDs are lit. Use the following list to select the desired switch interface.

Switch Interface	Line LEDs	MCU Type	Notes
Analog	1	SCA	The SCA will only support Analog
Comdial	3	SCU	
DEFINITY - 2 wire	1,4	SCU	
DEFINITY - 4 wire	1,5	SCF	
Executone	2,5	SCB	
Fujitsu	2,4	SCU	
Inter-Tel	2,3,4	SCU	
Meridian	1,2	SCU	
Merlin Legend	1,3	SCF	
Mitel	1,2,3	SCX	The SCX will only support Mitel
NEC	1,2,4	SCU	
Norstar	2	SCU	
Panasonic	5	SCP	
Siemens / Rolm	4	SCU	
Toshiba	2,3	SCU-5XX	
Unconfigured	1 through 8		

6. Move the Mode Switch back to **NORMAL**.
7. The MCU will cycle through diagnostic testing. When the system is ready for use, the error LED should be off, and the LED for the MCU Number (1-4) will be lit. This should take less than two minutes.

If the LED for the MCU ID does not light, or if an MCU ID is duplicated, there is most likely a problem with the IPC cabling. If the system displays an error refer to 8.1 *Troubleshoot Error Codes*.

8. If you select a switch type that is not supported by the MCU type, the system will alarm. The Error LED will flash along with Status LEDs 4 and 5. For example, this alarm will display if you assign switch type NEC to an SCB-5XX – Executone MCU.

If this alarm displays, use the table above to verify that your MCU type supports the selected switch type. If you need to change the switch type, repeat steps 2 through 6.

5.4 Install Base Stations

Be sure the Base Station is positioned clear of anything that might damage it. The Base Station should be well above head height, away from doors and other objects that might strike it, and away from areas open to the elements or possible water leaks.

Check your location for other radio antenna devices and place the Base Stations to avoid interference. Leave enough slack wire (approximately 25 feet) to account for possible future Base Station moves.

Mount Base Stations on Dropped Tile Ceilings

A ceiling clip and plastic bolt are supplied to install Base Stations on the drop ceiling rails (T-bars) used to support acoustical tile. The plastic bolt screws into the top of the Base Station, then snaps into the ceiling clip which has been attached to the rails that hold the acoustical tile. The fastener is designed for use on 15/16" wide rails.

1. Attach the metal fastener to the rail (T-bar) supporting the dropped ceiling by rotating it into position until it snaps into the locked position.
2. Screw the plastic bolt to the 1/4 x 20 captive nut into the top of the Base Station.
3. Slide the bolt into the exposed prongs of the metal clip until it snaps into position.

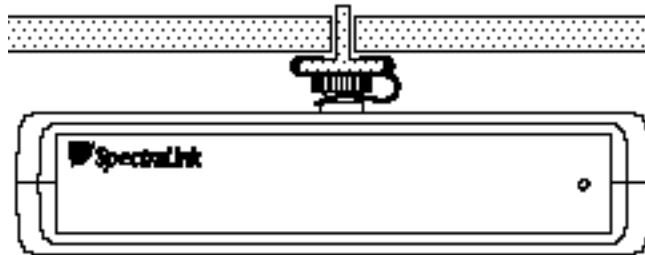

4. When properly attached the Base Station should sit almost flush against the ceiling and be tightly attached to the clip and T-bar grid work.
5. Once the Base Station is anchored to the fastener, lift the acoustical tile and plug the RJ-45 8-pin modular plug into the connector on the top of the Base Station.
 - The LED will blink red and green as the system software downloads to the Base Station and the Base Station is tested.
 - When the LED blinks amber, the system is ready for operation.
 - When the LED blinks green, a telephone has established a radio link with that Base Station.
 - If the LED turns solid red, there should be an error message on the MCU's status LEDs. Refer to 8.1 *Troubleshoot Error Codes*.

Mount Base Stations On Finished Ceilings

If your site does not have a dropped tile ceiling, the Base Station can be mounted to a finished ceiling or wall with a 4-5" long 1/4" –20 TPI plastic or nylon screw or bolt (such as a lag screw).



The customer's wire contractor is responsible for this installation.

1. Drill two holes approximately one inch apart. Make the holes large enough to accommodate the RJ-45 connector and a bolt to secure the Base Station.
2. Insert a wide washer above the ceiling, then screw the bolt into the beam or ceiling.
3. Insert three nuts on the bolt, then screw the Base Station into the bolt, **being careful not to insert the bolt more than 1/3 inch, five full turns, into the Base Station.**

If the ceiling is open with I-beams or pipe construction, mount the Base Station with I-beam clamps or pipe clamps.

5.5 Install Outdoor Base Stations

Outdoor Base Stations are equipped with a protective enclosure, designed to be mounted to a wall or pole. After the enclosure is mounted, the Base Station is inserted in the enclosure and connected.



Only RCO Base Stations can be used outdoors.

The customer's wire contractor is responsible for wiring and mounting the outdoor Base Station enclosure. The contractor is responsible for supplying screws, brackets, and other appropriate hardware.

Wire and Connect Outdoor Base Stations



If the wiring for a Base Station exits a building—whether to reach an outdoor Base Station location or to reach a Base Station in another building—it should be equipped with primary protection according to the National Electric Code (NEC) and/or local codes.

Wiring that exits the building must also be fuse protected at both ends. For example, use a Quick Clip Fuse from Illinois Tool Works, Linx Division, model number SCP-2X2. Insert the Quick Clip fuses in place of bridging clips on a 66 Block for the non-internal Base Station circuits.

1. Mount the outdoor Base Station enclosure to a wall or pole. The enclosure should be attached at the highest point available that will provide central coverage for the outdoor area.
2. Insert the Base Station cable through the compression fitting and tighten the fitting.
3. Wire the Base Station connector just as you wired the RJ-45 connectors for the indoor Base Stations.
4. Place the Base Station inside the enclosure with the part number label facing the back of the enclosure.
5. Screw the protective cover onto the Base Station enclosure.

6. Connect and Register Wireless Telephones

6.1 Set Up Diagnostic Modem

Each MCU has an internal modem feature that allows SpectraLink technicians to dial into the system for troubleshooting and maintenance. The modem is enabled on Line 1 when no Wireless Telephone is registered to Line 1. When enabled, the modem will autoanswer an incoming call to that line.



This internal modem uses proprietary communication software. You cannot use commercial software packages to access this software. If you have a multiple MCU system, you only need to enable one modem line, on Line 1 of MCU 1. Line 1 positions on the other MCUs can be used for Wireless Telephones.

To set up the diagnostic modem:

1. Connect an analog Direct Inward Dial (DID) line to Analog Interface MCUs (SCA-5XX) or a digital DID line to Digital Interface MCUs.
2. Move the mode switch to the **REGISTER** position. The LED for Line 1 should be off, indicating that no Wireless Telephone is registered to Line 1. If the LED is on then a Wireless Telephone is registered to the line. Refer to 6.3 *Unregister Wireless Telephones*.
3. Dial the number associated with the DID line. After one or two rings, you should hear high-pitched modem answer tone.

6.2 Register Wireless Telephones

Before a Wireless Telephone can be used it must be registered to a line on one of the MCUs. While Wireless Telephones are being registered, the system will continue normal operation.

Use the *Wireless Telephone Planning Worksheet* filled out by the system administrator to be sure you are correctly assigning each Wireless Telephone to its port and extension number.

All lines are unregistered when shipped from the factory. However, if you are replacing a failed MCU you may not need to register the Wireless Telephones. Refer to 8. *System Administration* for details.



Line 1 MCU 1 should be skipped to allow for remote access through the diagnostic modem.

Each MCU supports eight simultaneous conversations. To optimize performance and reduce the possibility of call blocking, distribute the Wireless Telephones evenly across all MCUs.

To register a Wireless Telephone to your system do the following:

1. Be sure all unregistered Wireless Telephones are powered off and that there is a Base Station plugged in and within range of the Wireless Telephones to be registered.
2. Move the mode switch to the **REGISTER** position. (If your system has more than one MCU, be sure to move the switch only on the correct MCU.) The LED which indicates the Box ID (1-4) may change. This is normal and is not an error.

The Line Indicator LEDs now show the registration status of each line.

- If the LED is on, a Wireless Telephone is registered to the line.
 - If the LED is off, no Wireless Telephone is registered to the line.
3. Press the **STEP** button until the LED for the line to be registered flashes.
 - If the LED is flashing, that line is selected. A flash with the LED mainly off indicates no Wireless Telephone registered; a flash with the LED mainly on indicates a Wireless Telephone is registered to the selected line.
 - Initially Line 2 will flash. This is because Line 1 is usually set up as the remote access diagnostic modem. To register a Wireless Telephone to Line 1, press the **STEP** button until Line 1 flashes.
 - If the desired line already has a Wireless Telephone registered to it, follow the procedure outlined below to unregister the Wireless Telephone, then return to this step.
 4. Turn on the Wireless Telephone to be registered by holding down the **PWR** key until the Wireless Telephone beeps twice. After a few seconds, the line indicator LED on the MCU will shine solid red. Once the Wireless Telephone is registered, the LED for the next line begins to flash.
 5. To assign the extension number, hold down the **FCN** key until Volume Level displays. Press the **# >** key (NEXT) until **EXTENSION** displays on the Wireless Telephone. Press **0**, then enter the correct extension number. Press **END** when finished.
 6. Repeat steps 3-5 for all Wireless Telephones to be registered.
 7. When all Wireless Telephones are registered, return the mode switch to the **NORM** position.

6.3 Unregister Wireless Telephones

If the desired line already has a Wireless Telephone registered to it, follow this procedure to unregister the Wireless Telephone.

1. Move the mode switch on the MCU to the **REGISTER** position. If your system has more than one MCU, be sure to move the switch on the correct MCU. The line indicator LEDs now show which lines have Wireless Telephones registered.
2. Use the **STEP** button to select the line to be unregistered. The line indicator LED for a line that has a Wireless Telephone registered to it will flash with the LED

mainly on.

3. Press the **DEL/ENTER** button. The line indicator LED for the selected line will be off with a short on flash
4. Register the new Wireless Telephone or return the mode switch to the **NORM** position.

6.4 Program Wireless Telephone Features

PBX and Key Systems provide users with special features such as hold, transfer, conference, camp on, and speed dial. These features can be accessed via the Wireless Telephone, but the telephone system or Link 150 M3 MCU must be programmed to allow access to these features from the Wireless Telephone. For information on programming the switch to operate with the Wireless Telephones, refer to *LinkPlus Digital Integration Guide* (PN 72-0070-00).

- If the Link 150 M3 MCU is connected to your telephone system via analog lines, refer to Appendix B: Program Analog Features.
- If your Link 150 M3 MCU is connected to a digital key telephone system or PBX, refer to the section of the *LinkPlus Digital Integration Guide* document that deals specifically with your brand of telephone system.

6.5 Test Wireless Telephones

Verify proper registration and operation of each Wireless Telephone by performing the following steps.

1. Press the **START** key on each Wireless Telephone. The extension number should clear and you should hear dial tone. On some digital systems, depending on how the telephone system is programmed, you may have to select a line to get dial tone.
2. Place a call to each Wireless Telephone to verify ring, answer, clear transmit, and clear receive audio.
3. Verify all programmed features on each Wireless Telephone.
4. Press the **END** key. The line indicator should turn off.

7. Site Certification

The installer should not leave the site before contacting SpectraLink to perform remote install verification.

Contact a SpectraLink engineer on the technical support line 800-775-5330. The hours of operation are 7:00 a.m. to 6:00 p.m. Mountain Time, Monday through Friday, excluding holidays.

The engineer will connect with the diagnostic modem, verify calling functions, and listen while you perform a walk test. The walk test will require you to walk the inside perimeter of the coverage area. If all Base Stations are running, note any areas with heavy static or clarity problems and report it to a SpectraLink engineer.

The installation is not complete until these certification steps have been performed. Do not hand out Wireless Telephones at a site that has not been certified.

8. System Administration

8.1 Troubleshoot Error Codes

When an alarm is detected, the Error LED will light and the MCU's status LEDs will display an alarm code.

If the error code refers to a Base Station problem, the Base Station LED will indicate which Base Station has the problem. If more than one Base Station LED is on, the error code refers to the lowest numbered Base Station with an error. Use the **STEP** button to select another Base Station to display its error code.

Contact SpectraLink Customer Support at (800) 775-5330 (Monday through Friday, 7:00 a.m. to 6:00 p.m. Mountain Time) for additional assistance in troubleshooting your system.

8.2 Troubleshoot Phone Features

If Wireless Telephone features are not working properly, disconnect the Wireless Telephone from the MCU and plug a wired telephone into the port. The telephone should be the same type as the emulated telephone. Refer to the appropriate section of *LinkPlus Digital Integration Guide* for more details.

Test the features on the wired telephone.

- For analog MCUs, verify that feature access codes and switchhook flash work correctly.
- For digital MCUs, verify that features are assigned to the correct keys and are working properly. Refer to the appropriate section of *LinkPlus Digital Integration Guide* for button mapping information for the brand of telephone system at your location.



Certain four-wire telephones (such as MERLIN LEGEND) use a different connector on the phone than on the back of the MCU. Therefore you may need phone cord or an adapter to perform these tests.

8.3 Status LED Codes

Status LEDs 12345	Description	Action
Random Cycling	The Link 150 M3 MCU is powering up. Initialization to follow.	This is not an error and should change to another code after a minute.
5	Link 150 M3 MCU is initializing.	Code number will change when finished.
1,2,3 or 4	MCU identification number.	Indicates normal operation when it is on steady.
	If the same LED is lit on more than one MCU: If the LED is flashing and the error light is on:	Check the IPC connections. There is a problem with the MCU indicated by the flashing box ID.

The following STATUS LEDs are displayed in combination with the ERROR LED.

Status LEDs	Description	Action
1,2,3,4,5	MCU has not been configured for switch interface type.	Assign a switch type to the MCU. See section 5.3.5 for instructions.
1,3	A Base Station has reported an internal problem.	Replace the Base Station. In rare cases a problem with the MCU can cause this error.
2,3	No communication with one or more Base Stations on this MCU.	<p>Check cabling to verify that the Base Station's cable is plugged into and fully seated in the Base Station port at the back of the MCU and plugged into the Base Station at the other end.</p> <p>If the LED on the Base Station is not lit, check for proper wiring of the 8-pin modular plugs. See section 4.3.</p> <p>If the cable is over 600 feet long, verify that the extra wire pairs have been connected correctly.</p> <p>If the Base Station LED is flashing red, check for open or shorts on pins 1 and 2 of the cable.</p> <p>If the Base Station has been removed, acknowledge the alarm by moving the Mode Switch to REGISTER. Press the STEP button until the LED for the removed Base Station is blinking. Press DEL/ENTER, then move the Mode Switch back to NORMAL.</p>
1,2,3	Internal communication problem with the MCU.	Replace the MCU.

Status LEDs	Description	Action
4	IPC problem.	Check IPC cabling by disconnecting and reconnecting the MCUs. Connect the Male RJ-21 connector from the appropriate demarcation block to the designated RJ-21 connector (A or B) on each MCU. Secure cables using the keeper. If the error still occurs try using a different IPC cable. Replace MCU if the problem still occurs.
4,5	The switch type selected is not supported by this MCU.	Verify that the switch type selected is correct. If the type is incorrect, repeat the steps to select a new switch type. See section 5.3.5.
1,4	The operator is trying to register a Wireless Telephone or place an admin call on an MCU with no phone lines.	Return mode switch to the NORM position.
2,4	The MCU was powered on with the mode switch in the wrong position.	Turn off the MCU, place the mode switch to the NORM position and turn back on.
3,4	Configurations on a multi-MCU installation do not match in each of the units. Most likely to occur when an MCU was just added to the system.	Erase the configuration in the MCU with incorrect configuration definitions (probably the MCU that was just added.) To erase the configuration, refer to <i>Replace an MCU</i> . <i>Note:</i> Do not erase the configurations in all the MCUs. In multiple MCU installations the Wireless Telephone registration information is shared among the MCUs. This allows you to replace an MCU without re-registering all the Wireless Telephones.
1,3,4	REGISTER or ADMIN mode selected on more than one MCU at the same time.	Only one mode switch can be in ADMIN or REGISTER at a time. Check the MCUs and take one of them out of REGISTER or ADMIN mode.
2,3,4	The MCU was powered on with the mode switch in the wrong position.	Turn off the unit, place the mode switch to the NORM position and turn back on.
1,2,3,4	Internal problem with the MCU.	Contact SpectraLink Customer Service for technical support.
1,5	The MCU was powered on with the mode switch in the wrong position. A possible Base Station failure has been detected. A Base Station that had previously been heard by another Base Station can no longer be heard.	Turn off the MCU, place the mode switch in the NORM position and turn back on.. Check to see if the system was powered on with the switch in the wrong position. If not, contact SpectraLink Customer Service.

Status LEDs	Description	Action
5	<p>The MCU was powered on with the mode switch in the wrong position.</p> <p>One or more of the Base Stations on this unit is disabled because it is located too close to other Base Stations. The error display refers to the LED that is red. If more than one LED is red, it refers to the lowest numbered Base Station.</p> <p>If Mode switch is in ADMIN mode:</p>	<p>Turn off the MCU, place the mode switch in the NORM position and turn back on..</p> <p>Identify which Base Station has been disabled and move it away from its nearest neighbor Base Station</p> <p>Adjust the companding mode from Mu law to A law. Refer to 11.2 Change Companding</p>
3,5	The MCUs have incompatible versions of software.	Contact SpectraLink Customer Service for technical support.

Wireless Telephone Status Indicator Messages

Indicator	Description	Action
BATT	Displays when user is on the Wireless Telephone and the battery charge is low. The user has two minutes to complete the call.	Replace the battery with a charged battery.
BATTERY LOW	Displays when user is not on the Wireless Telephone and battery charge is low. The Wireless Telephone will ring to alert user to this condition. The Wireless Telephone will not work until the battery is replaced.	Replace the battery with a charged battery.
INTERNAL ERROR	Communications error between the Wireless Telephone and the MCU.	Have the user turn the Wireless Telephone off, then on again. If the error persists try registering another Wireless Telephone to this port. If the problem persists, contact technical support.
NO PBX	There is no telephone system port connected to the port associated with this Wireless Telephone, or the telephone system has not yet synchronized the port.	This message should disappear when the telephone system ports are wired and programmed correctly.
PT UNREGISTERED	The Wireless Telephone is not yet registered to an MCU.	Register the Wireless Telephone.

8.4 Replace a Wireless Telephone

If a Wireless Telephone breaks or needs to be replaced, the old Wireless Telephone must be deleted and the new Wireless Telephone added.

Delete Old Wireless Telephone

1. Make sure all unregistered Wireless Telephones are **OFF**. If this is not done an unregistered Wireless Telephone may unintentionally register to an available line.
2. Move the mode switch to the **REGISTER** position on the MCU.
3. Press the **STEP** button until the LED for the line to be deleted is flashing red.
4. Press the **DEL/ENTER** button.

You can now register a new Wireless Telephone or return the mode switch to the **NORM** position.

Register New Wireless Telephone

1. Make sure all unregistered Wireless Telephones are **OFF**.
2. Move the mode switch to the **REGISTER** position.
3. Press the **STEP** button until the desired line to be registered is flashing red. Only unregistered lines can be registered.
4. Press **PWR** on the Wireless Telephone that needs to be registered. The LED should change to mostly on once the Wireless Telephone is registered.
5. Wait at least 3 seconds and then press **END**.
6. Return the mode switch to the **NORM** position.
7. To assign the extension number, hold down the **FCN** key until Volume Level displays. Press the **# >** key (NEXT) until EXTENSION displays on the Wireless Telephone. Press **0**, then enter the correct extension number.
8. When the Wireless Telephone is turned **ON**, the extension will be displayed. Test the Wireless Telephone by placing a call to each Wireless Telephone to verify that the correct Wireless Telephone rings.

8.5 Replace an MCU

When the system has more than one MCU, each MCU contains a complete set of configuration information for the entire system. This includes Wireless Telephone registration information, function definitions, and frequency sequence selection.

This Configuration Sharing feature allows a failed MCU in a multi-unit installation to be replaced without having to register the Wireless Telephones again.

To replace a failed MCU, first clear the configuration information on the replacement MCU, then replace the failed MCU.

Clear Configuration on Replacement MCU

1. Remove power from the replacement MCU. There should be no IPC cables connected to the IPC ports.
2. Slide the mode switch on the Replacement MCU to the ADMIN position.
3. Apply power.
4. Press the **STEP** button until the status LEDs light 2,3, and 4 of the Replacement MCU.
5. Press the **DEL/ENTER** button.
6. Remove power from the unit.
7. Slide the mode switch to the **NORM** position.

Connect the Replacement MCU

1. Remove the failed MCU from the IPC chain
2. Connect the replacement MCU in the position vacated by the failed MCU.
3. Reconnect the IPC cables for the chain. Double-check that the IN and OUT ports are correctly connected.
4. Apply power to the MCU.
 - After a few moments each MCU in the chain should have a unique box ID number (1-4), shown on the status LEDs. If this is not the case, recheck the IPC wiring.
 - If the replacement MCU has status LED 3 and 4 lit, the configuration data has not been successfully shared. Most likely, the replacement MCU was powered up before it was correctly attached to the IPC chain. Repeat the entire replacement procedure.

8.6 Replace a Base Station

To replace a Base Station, unplug the existing Base Station and plug in the new Base Station.

- The LED will blink red and green as the system software downloads to the Base Station and the Base Station is tested.
- When the LED blinks amber, the system is ready for operation.
- When the LED blinks green, a Wireless Telephone has established a radio link with that Base Station.
- If the LED turns solid red, there should be an error message on the MCU's status LEDs and the MCU Error LED should be lit.

9. Wireless Telephone Planning Worksheet

Copy and complete this worksheet to keep track of the port numbers, extensions, users, and features assigned to your Wireless Telephones.

MCU ID: _____

Tel No.	Extension	Port ID	User Name	Feature Notes
1 *				
2**				
3				
4				
5				
6				
7				
8				
9				
10				
11				
12				
13				
14				
15				
16				



*On MCU No. 1: Reserve Port 1 for access to SpectraLink Diagnostic Modem

**On MCU No. 1: Port 2 is used for administrative programming (analog system only)

10. Base Station Location Worksheet

MCU: _____

Base Station #	Location (e.g.: building, floor #, detailed description)	Port ID
Base Station 1		1
Base Station 2		2
Base Station 3		3
Base Station 4		4

MCU: _____

Base Station #	Location (e.g.: building, floor #, detailed description)	Port ID
Base Station 1		1
Base Station 2		2
Base Station 3		3
Base Station 4		4

MCU: _____

Base Station #	Location (e.g.: building, floor #, detailed description)	Port ID
Base Station 1		1
Base Station 2		2
Base Station 3		3
Base Station 4		4

MCU: _____

Base Station #	Location (e.g.: building, floor #, detailed description)	Port ID
Base Station 1		1
Base Station 2		2
Base Station 3		3
Base Station 4		4

11. Appendix A: Technical Parameters

11.1 Select Alternate Spread Spectrum Sequence

The SpectraLink system uses spread spectrum radio transmission. Spread spectrum takes a discrete signal, such as a digitized voice conversation, and spreads it over a wide range of frequencies rather than transmitting at a single carrier frequency. The frequency range may need to be adjusted if other wireless devices in your facility, such as data terminals or bar code readers, share the same frequency band.

Units shipped from the factory are preset to operate on sequence 1, which spans the entire spectrum from 902MHz to 928MHz. If interference between the SpectraLink system and other 900MHz radio devices is anticipated or observed, any one of six alternate sequences can be selected.

Determine the frequency band of the interfering device, then use the frequency ranges below (given in MHz) to select the best interference avoidance pattern for the situation.

Sequence	Frequencies Used by SpectraLink
1	902-928
2	902-915
3	902-909 & 921-928
4	914-928
5	902-904 & 909-921
6	904-910 & 920-928
7	908-922

To change a system to an alternate sequence, perform the following steps for **EACH** MCU.

1. Wait for any calls in progress to end. Power the system OFF, then slide the mode switch to the **REGISTER** position.
2. Power the system ON. Status LEDs 5 and 1 should be lit, indicating frequency selection mode. One of the line LEDs from 1 to 7 will be indicating the current frequency selected for the MCU.
3. Use the **STEP** button to select the desired new sequence.
4. Press the **DEL/ENTER** button. The LED indicates the new frequency that has been selected.
5. Return the mode switch to the **NORM** position.
6. Repeat Steps 1-5 for each MCU of a multi-unit installation.

11.2 Change Companding

The factory setting on the Link 150 M3 MCU is compatible with Mu-law companding (signal compression), which is the standard used by most PBXs in North America. Systems outside North America generally use A-law companding. If the PBX companding is incompatible with the MCU's, the Wireless Telephones will have distorted or hissing dial tone and voice will be unintelligible.

- Before you begin, if the system has more than one MCU, erase the configurations from all MCUs except MCU 1. Refer to 8.5 *Replace an MCU* for instructions.

To change the default from Mu- to A-law on the Link 150 M3 MCU follow these steps.

1. Power the system OFF.
2. Slide the mode switch on the first MCU to the **ADMIN** position.
3. Power the system ON. Status LEDs 2, 3, and 4 will be solid green.
4. Press the **STEP** button once. Status LEDs 2, and 5 will be lit.
5. If the LED for **LINE 1** is lit, the system is set for Mu-law.
If the LED for **LINE 2** is lit, the system is set for A-law.
6. Press the **DEL/ENTER** button to toggle between Mu-law and A-law.
7. When the correct **LINE** LED is lit, return the mode switch to the **NORM** position.

12. Appendix B: Program Analog Features

12.1 Defining Macros

On an analog telephone system, telephone system features such as transfer, hold, or speed dial are usually accessed via key presses or hook flashes. The Link Wireless Telephone System allows these features to be customized using system macros. These features can then be accessed from all Wireless Telephones by pressing **FCN** followed by a digit. The macro definitions are the same for all Wireless Telephones in the system.

For example, suppose your telephone system uses **FLASH * 7** to transfer a call. On the Link Wireless Telephone System, you can assign the transfer function to **FCN 2**. When the Wireless Telephone user presses **FCN** followed by **2**, the telephone system will enter the transfer function. Using macros instead of complicated key presses makes it easier for users to remember and access features.



Do not program analog features on a digital system.

Macro definitions are made up of combinations of the following characters:

0 to 9	TheWireless Telephone keys numbered 0 to 9
#	TheWireless Telephone # key
*	TheWireless Telephone * key
F	Flash
S	Pause 65 milliseconds

The Link Wireless Telephone System will accept programming for eleven functions. The maximum number of key entries for each function is 20.

Open Application Interface

For digital and analog systems with Open Application Interface (OAI) software, the user may press **FCN** key sequences to access certain applications. Macro assignments are also used to assign a function key to initiate an OAI application.

12.2 Plan Programming

Before programming the features, review the manual for your telephone system to determine what keystrokes are used to access the desired functions. Then determine which function key numbers should be assigned to these functions on the Link Wireless Telephone System.

12.3 Program Macro Codes

Functions are defined by placing an Administrative Call using the Administrative Wireless Telephone (registered to Line 2 of MCU 1). Follow these steps to place an administrative call and define functions.



In multi-unit installations, be sure all MCUs are properly connected to one another before making an administrative call.

1. On the MCU that displays a box ID of **1**, move the mode switch to the **ADMIN** position.
2. Press the **START** key on the administrative Wireless Telephone (the Wireless Telephone registered to MCU 1, line 2). This is the only Wireless Telephone enabled to make the administration call.
3. When you hear a steady tone (not a dial tone), the Wireless Telephone is in an administrative call and is ready to program.
4. Press the **FCN** key followed by the key strokes used to access the function. Valid keys are **0-9**, *****, **#**, **START** (flash), and **FCN** (pause). Note that **FCN + 1** is reserved for Mute.
5. Press the function key sequence to be programmed. If a key sequence is incorrectly entered, go to the next step.
6. Press the **END** key to complete the programming of the function. Repeat steps 4-7 for all remaining functions or to reprogram a function to correct an input error.
7. Return the mode switch to the **NORM** position.

The line LEDs now indicate line status and the administrative Wireless Telephone can now place calls normally.

12.4 Examples of Programming

Transfer:

On your telephone system, the **Transfer** feature is accessed using **Flash * 7**. On the Wireless Telephone, Transfer will be accessed using **FCN 2**.

With the Mode switch in the **ADMIN** position, key in the following sequence on the Administrative Wireless Telephone:

START,FCN, 2
START(flash),*,7,END

Speed Dial:

You want **FCN 4** to dial 555-1234. The system must access an outside line by dialing 9 and wait for dial tone, then dial the call. Key in the following sequence on the Administrative Wireless Telephone:

START,FCN,4
9,FCN(pause),FCN(pause),5,5,5,1,2,3,4,END

The number of pause entries depends upon how quickly your telephone system accesses outside dial tone.

Clear or Erase A Function:

You want to clear FCN 5 from memory. Key in the following:

START,FCN,5,END

Remember that when you change or delete a function using the Administrative Wireless Telephone, you will change or delete that function on all Wireless Telephones.

13. Appendix C: Installing the Open Applications Interface (OAI) Telephony Gateway

The OAI Telephony Gateway (MOG 500) allows the Link 150 M3 MCU to interface with an application server as shown in the diagram below. This enables third-party applications to communicate directly with the Link 150 M3 MCU, allowing users to retrieve and respond to information using Wireless Telephones. A single OAI Telephony Gateway can be connected to a Link 150 Master Control Unit (MCU) using an IPC cable (8-conductor cable with RJ-45 connectors)..

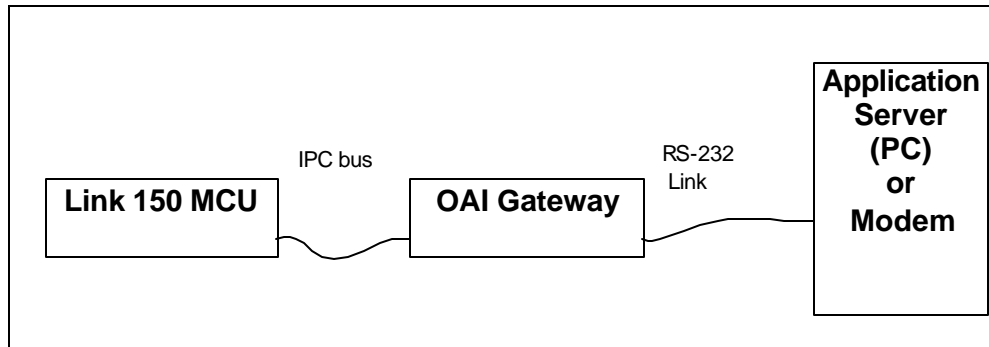

13.1 Before Installing the OAI Telephony Gateway

If this is a new system installation, secure the OAI Telephony Gateway to the wall, power up and test the Telephony Gateway when the MCUs are tested. Connect the OAI Telephony Gateway to the MCU after the Base Stations are installed.

If you are adding the OAI Telephony Gateway to an existing system, the system will need to be shut down and re-set to install the OAI Telephony Gateway. Notify users that the system will be out of service during the installation.

13.2 The OAI Telephony Gateway's Front Panel

The OAI Telephony Gateway's front panel has the following status indicators.

- **ERROR:** indicates an internal error
- Status LEDS:
 - **LED 1:** future use
 - **LED 2:** future use
- **LED 3/IPC:** indicates the status of the communication between the OAI Telephony Gateway and the other MCUs.
- **LED 4/RD:** indicates the OAI Telephony Gateway is receiving data on the RS-232 port.
- **LED 5/SD:** indicates the OAI Telephony Gateway is sending data on the RS-232 port.
- **PWR:** indicates status of DC power connection.

13.3 Mount Telephony Gateway to Wall

Like the MCU, the OAI Telephony Gateway is designed to be mounted on a backboard of $\frac{3}{4}$ inch plywood, securely fastened to the wall. Mount the Telephony Gateway vertically, adjacent to the last MCU. Do not stack the MCUs or Telephony Gateway on top of one another.

To mount the OAI Telephony Gateway:

1. Using a 1/8" drill bit, drill four pilot holes, on 2 inch by 12.1 inch centers.
2. In each pilot hole, sandwich a star washer between the ESD bonding strap and the backboard, then insert the screw (#8 panhead wood screw, 3/4 inch long) and tighten it, leaving approximately 1/8 to 1/4 inch gap from the wall.
3. Slide the Telephony Gateway over the screw until it drops in place.
4. Tighten screws fully.

13.4 Initial Test



Use only the provided Class II AC Adapter with output 24Vdc, 1A, 24W.

1. Connect the power plug from the OAI Telephony Gateway's power adapter to the jack labeled POWER on the back of the OAI Telephony Gateway box.
2. Plug the power adapter into an 110VAC outlet or outlet strip.
3. Apply power to the OAI Telephony Gateway. The Power LED on the front panel should come on. All other LEDs should be off.
 - If the ERROR LED comes on at any time, there is a hardware problem. Note which other LEDs are on (if any) and contact SpectraLink Customer Service.

13.5 Connect the OAI Telephony Gateway to the MCU

1. The OAI Telephony Gateway must be connected as the last box in the MCU chain. Connect the OAI Telephony Gateway to the OUT port on the MCU, using the IPC cable supplied.
2. Double-check that the IN and OUT ports are correctly connected on all MCUs. The first MCU will have no connection to the IN port; the last MCU is connected to the OAI Telephony Gateway. The following diagram shows a chain of four MCUs and the OAI Telephony Gateway.

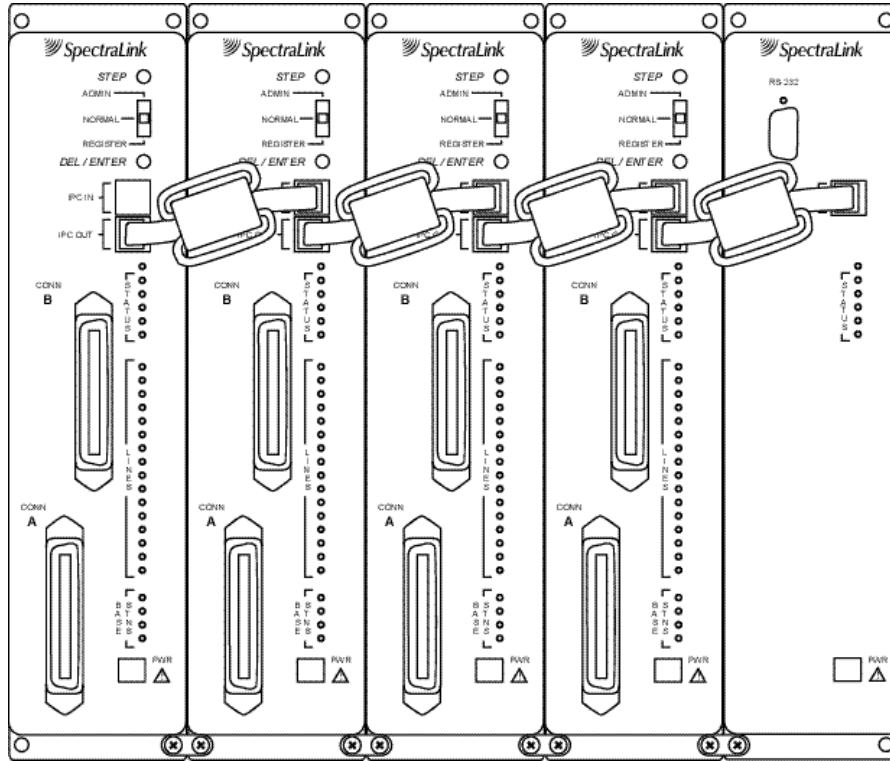

Do NOT stack the MCUs and OAI Telephony Gateway on top of each other. Units should be placed side by side physically touching the adjacent unit.

3. Power up the entire system.
 - The Power and IPC LEDs on front panel of the OAI should be on. If the IPC LED remains off, try replacing the IPC cable. If this does not correct the problem, or if the Error LED is on, contact Customer Service.
 - All the MCUs should go through their usual diagnostic routine, and a unique Box ID should display on the status LEDs of each MCU. If this does not happen, recheck the IPC wiring.

13.6 Connect the OAI Telephony Gateway to the Application Server

Using a standard 9-pin female D-type connector, connect the serial port on the front panel of the OAI Telephony Gateway to the PC, application server, or modem that will be used to interface with the application.

The OAI Telephony Gateway uses the following pins on the connector:

Pin	Function
2	Data OAI Receives
3	Data OAI Transmits
5	Ground

If the application is up and running, the RD and SD LEDs on the front panel of the OAI Telephony Gateway should be lit or blinking, indicating that the OAI Telephony Gateway is sending and receiving data to or from the PC.

13.7 Assign A Function Key to OAI Telephony Gateway

To access the OAI application, the user presses **FCN** and an assigned number key. Follow these steps to assign a function key to initiate the OAI application.

1. Make sure a Link Wireless Telephone is registered to line 2. This is the only port with administration access.
2. With the system up and running and within range of a Base Station, move the **Mode** switch on the MCU to the **ADMIN** position.
3. Press **START** on the Wireless Telephone registered to line 2. You should hear a steady tone.
4. Press the **FCN** key followed by the key you want to assign for OAI access.
5. Press **##555**, then press **END**. This assigns OAI to the specified key.
6. Return the MCU **Mode** switch to the **NORM** position.

13.8 Certification Test

When the OAI Telephony Gateway is properly connected to the application server, the LEDs should look like this:

Power	On
Error	Off
LED 1	
LED 2	
LED3/IPC	On
LED4/SD	On when sending data to server
LED5/RD	On when receiving data from server

To test the Wireless Telephones:

- If this is a new installation, continue with Wireless Telephone registration and PBX programming, and perform the usual voice and coverage tests when Wireless Telephone installation is complete.
- If you added the OAI Telephony Gateway to an existing system, place a call and test the features on each Wireless Telephone to be sure the system is working properly.
- Test the application on each Wireless Telephone. The **SD** and **RD** LEDs should be on when the OAI Telephony Gateway is communicating with the server (at least every 30 seconds). Consult your application provider for specific test procedures.

Index

- AC Adapter
 - MCU, 18
 - OAI, 47
- A-law, 41
- Alternate sequence, 40
- Function Keys, 49
- Attenuation, 7
- Base Station, 18
 - Cabling, 7, 8
 - Description, 4
 - Installation, 23
 - LED, 30
 - Location form, 39
 - Outdoor, 25
 - Outside Wiring, 25
 - Replacing, 37
- Battery Chargers, 19
- Cabling
 - Base Station specifications, 7
 - Base Station, external, 13
 - Base Station, internal, 7
 - Demarcation blocks, 13
 - Exiting the building, 8
 - Four wire digital, 12
 - IPC, 22, 45
 - OAI Gateway, 45
 - Prepare Demarc Blocks, 9
 - Quick Clip Fuse, 6
 - RJ-45 modular, 8
 - RS-232, 45
 - Shipped with system, 18
 - Troubleshooting, 31
 - Two-wire analog or digital, 11
- Ceiling clip, 18, 23
- Chargers, 19
- Companding, 41
- Configuration sharing, 36
- Connecting MCU to Telephone System, 9
- Coverage, 4
- Customer Support Hotline, 1
- Demarcation blocks
 - Four wire digital, 16
 - Installing, 13
 - Two wire analog or digital, 15
- Diagnostic Modem, 10
- Error Codes, 30
- ESD bonding strap, 18
- Extension numbers, 35
- Features, Defining Macros for, 42
- Batteries, 19
- Forms
 - Base Station location, 39
 - Wireless Telephone
 - Planning Worksheet, 38
- Frequency, transmission, 40
- Hand-off, 4
- Hotline, 1
- Interface types, Demarc, 9
- Interference, frequency, 40
- LED
 - Base Station, 30
 - Codes, 31
 - Front Panel, 5
 - Line indicator, 5
 - Troubleshooting, 30
- Link WTS, Overview, 3
- Macros, Defining, 42
- Master Control Unit. See MCU
- MCU
 - Base Station cabling, 8
 - Connect to Demarc Blocks, 19
 - Description, 3
 - Front Panel, 5
 - Location, 6

- Mounting, 19
- Multiple, 20
- Replacing, 36
- Mode Switch, 5
- Modem, 10, 26
- Mounting Hardware, 18
- Mu-law, 41
- OAI
 - Assigning Function Key, 49
 - Certification Test, 50
 - Connecting to MCU, 48
 - FCN** key, 42
 - Gateway Connection Diagram, 48
 - Gateway front panel, 46
 - Mounting the Telephony Gateway, 46
- Open Applications Interface. *See* OAI
- PBX type, 21
- Power
 - AC Adapter. *See*
 - Outlet strip, 6
 - Power jack, 5
- Programming, 13
- Quick Clip Fuse, 6
- Register Wireless Telephone, 26
- Remote Access via modem, 10
- Replacing
 - Base Station, 37
 - MCU, 36
 - Wireless Telephone, 35
- Site Certification, 29
- Site Preparation, 6
- Site Survey, 18
- Spread Spectrum Sequence, 40
- STEP Button, 5
- Switch programming, Analog, 42
- Switch type, 21
- Ports, 10
- Troubleshooting, 30
- Unregister Wireless Telephone, 27
- Walk test, 29
- Wireless Telephone
 - Description, 4
 - Planning Worksheet, 38
 - Program, 28
 - Register, 26
 - Replacing, 35
 - Test, 28
 - Unregister, 27

Free Manuals Download Website

<http://myh66.com>

<http://usermanuals.us>

<http://www.somanuals.com>

<http://www.4manuals.cc>

<http://www.manual-lib.com>

<http://www.404manual.com>

<http://www.luxmanual.com>

<http://aubethermostatmanual.com>

Golf course search by state

<http://golfingnear.com>

Email search by domain

<http://emailbydomain.com>

Auto manuals search

<http://auto.somanuals.com>

TV manuals search

<http://tv.somanuals.com>