

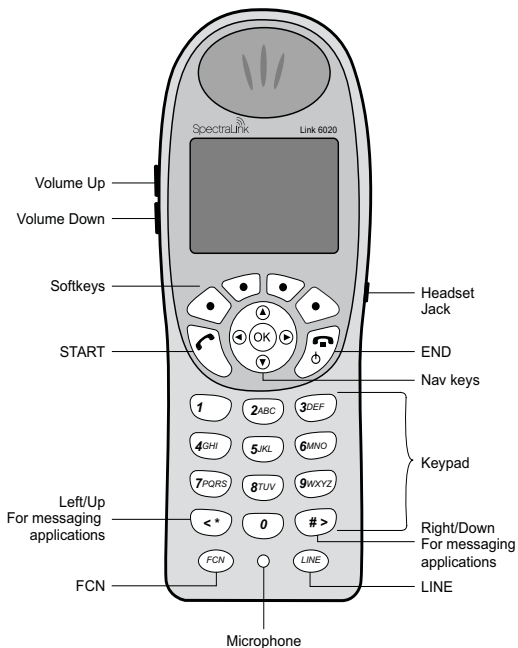

LINK 6020 WIRELESS TELEPHONE AND ACCESSORIES USER GUIDE



Link 6020 Wireless Telephone



INTRODUCTION

Your Link 6020 Wireless Telephone is a state-of-the-art communication device that utilizes radio wave technology to send and receive voice transmissions. It is designed to operate like a cell phone. However, the handset utilizes the private telephone system installed in your facility and will not operate outside the area covered by this system.

About This Guide

This guide is meant to provide general information about your handset. Contact your phone system administrator for additional information on how your handset functions within your telephone system. This guide includes information about:

- The Handset
- Getting Started
- Advanced Features
- Handset Accessories
- Handset Administration
- Safety Information

Notice

SpectraLink Corporation has prepared this document for use by SpectraLink personnel and clients. The drawings and specifications contained herein are the property of SpectraLink and shall be neither reproduced in whole or in part without the prior written approval of SpectraLink, nor be implied to grant any license to make, use, or sell equipment manufactured in accordance herewith.

SpectraLink reserves the right to make changes in specifications and other information contained in this document without prior notice, and the reader should in all cases consult SpectraLink to determine whether any such changes have been made.

The terms and conditions governing the sale of SpectraLink hardware products and the licensing of SpectraLink software consist solely of those set forth in the written contracts between SpectraLink and its customers. No representation or other affirmation of fact contained in this document including but not limited to statements regarding capacity, response-time performance, suitability for use, or performance of products described herein shall be deemed to be a warranty by SpectraLink for any purpose, or give rise to any liability of SpectraLink whatsoever.

In no event shall SpectraLink be liable for any incidental, indirect, special, or consequential damages whatsoever (including but not limited to lost profits) arising out of or related to this document, or the information contained in it, even if SpectraLink has been advised, knew, or should have known of the possibility of such damages.

For regulatory information, please see *Link Wireless Telephone Regulatory Guide* (72-1401-00).

Model Numbers

Handset model: 602X

Charger models: PCS1850, PCD1850, PCQ1850

Battery Pack models: PBP0850, PBP1300, PBP1850

TABLE OF CONTENTS

INTRODUCTION	3
About This Guide	3
THE HANDSET	7
Modes of Operation	7
Menu Navigation	7
Handset Displays	8
Shortcut Keys	9
Status Bar Indicators	10
Softkey Labels	12
GETTING STARTED	14
Basic Handset Operation Summary	14
ADVANCED FEATURES	18
Facility-Specific Features	18
Message Alert Feature	18
Data Entry and Editing	19
The Config Menu	20
Toggle Options	20
Profiles	21
Changing Ring Settings	22
Default Profile Settings	23
Config Menu Options	24
CHARGERS, BATTERY PACKS AND ACCESSORIES	26
Battery Packs	26
Charger Models	27
Charging Status	28
Single Charger	29
Dual Charger	30

Quad Charger	31
Carrying Options	32
Headsets	32
HANDSET ADMINISTRATION	33
FAQs	33
SAFETY INFORMATION	36
Chargers and Battery Packs	36
Wireless Telephones	37
Operational Warnings	37
Electromagnetic Interference and Compatibility	38
Use While Driving	39
INFORMATIONS CONCERNANT LA SÉCURITÉ	40
Chargeurs et batteries	40
Téléphones sans fil	41
Avertissements concernant le fonctionnement	41
Interférences électromagnétiques et compatibilité ...	42
Utilisation au volant	43
SPECIFICATIONS	46
CARE OF YOUR HANDSET	47

THE HANDSET

Modes of Operation

Your handset has four modes of operation:

Mode	Description
Standby	The handset is not in a call or messaging.
Active	A call is coming in, a call is being dialed or the handset is in a call or messaging.
Config Menu	User preferences are being accessed in the Config Menu . In this mode the handset is on, but will not receive calls.
Message Alert	Custom text messaging applications may be programmed for your facility. This mode is activated through the FCN menu. See <i>Advanced Features</i> .

Menu Navigation

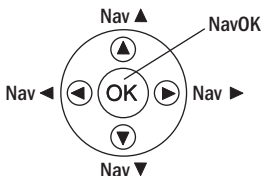

The navigation keys (Nav keys) just below the softkeys are used to navigate through menu options. These are referred to in this guide as **Nav▲**, **Nav▼**, **Nav◀**, **Nav▶**, and **NavOK**.

Handset Displays

The top row of the display provides status indicators for various handset conditions. It is referred to as the status bar.

The middle lines display information about the handset identity, user profile, calls in progress, menu options, and data from telephone system.

The bottom row displays softkey labels.

Standby Mode Display

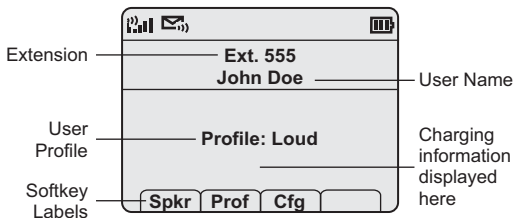





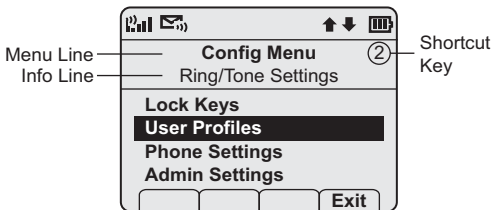

When the handset is in a call or in active mode, information from the telephone system in your facility displays. Information may include extension or telephone number of called or calling party, active line information, and softkeys that have been programmed by your system administrator.

Shortcut Keys

When a menu is displayed, a shortcut key may be displayed on the right edge of the menu line. Press the corresponding number on the keypad to activate the corresponding menu option.



Status Bar Indicators

Indicator	Function
	The signal-strength icon indicates the strength of the signal and can assist the user in determining if the handset is moving out of range.
	If voicemail is available the voicemail icon will appear when a new voicemail message is received.
	The battery icon indicates the amount of charge remaining in the Battery Pack. When only one level remains, the Battery Pack needs to be charged.
	The speakerphone icon displays when the speakerphone is active.
	The line indicators are associated with telephone line status and access.
	Up and down arrows are displayed when a menu has additional options above or below. Left or right arrows are displayed during editing when the cursor may be moved left or right.
Muted	The muted indicator displays after the Mute softkey has been pressed during a call. It indicates that the microphone is not transmitting sound. Press the Mute softkey again to unmute the microphone.

Indicator	Function
Locked	Locked indicates that the keypad is locked to prevent accidental activation. Press the Unlk softkey and then the # key to unlock it.
	The download icon indicates that the handset is downloading code. This icon only appears while the handset is running the over-the-air downloader. It appears to the right of the signal strength icon in the same location as the voicemail icon.

Softkey Labels

The bottom row of the handset displays labels associated with the four softkeys just below it. When a softkey is active, a label appears to describe its function. Pressing the softkey will activate the feature.

Label	Description	Action
Back	Go back	Returns to the previous menu display.
CAPS caps	Change case	Toggles to allow a change in case when entering alphabetical text.
Cfg	Configure	Opens the Config Menu .
Clr	Clear	Deletes the entry.
Cncl	Cancel	Returns to the previous menu display without saving any data that might have been entered.
Del	Delete	Deletes the character to the left of the cursor.
Exit	Exit	Exits out of the menus.
Hold	Hold	Places a call on hold.
Mute	Mute	Toggles to mute or unmute the microphone.
No	Negative reply	Press to reply “No” to a displayed question.
Play	Play	Plays the selected ring tone.
Prof	Profile	Opens the Profile menu.

Label	Description	Action
Spkr	Speakerphone	Toggles speakerphone function.
Unlk	Unlock keys	Press Unlk , then the # key to unlock a locked keypad.
Yes	Positive reply	Press to reply “Yes” to a displayed question.

GETTING STARTED

Your Link 6020 Wireless Telephone is designed for full mobility within the workplace and operates much like a cell phone. It also interfaces with the telephone system at your workplace and incorporates advanced telephony features. This section covers the basic functions available in every facility. For specific telephony system functions, see the *Facility-Specific Features* section or contact your system administrator.



Place the handset into the charger for a minimum of two hours. The handset's Battery Pack must be fully charged before its first use. See the *Charger Models* section for full information.

Basic Handset Operation Summary

If you want to	Then
Remove the Battery Pack	Press down on the latch on the Battery Pack at the back of the handset and pull the Battery Pack towards you. The Battery Pack releases outward.
Replace the Battery Pack	Slide the lip of the Battery Pack into the bottom of the cavity. Push the top of the Battery Pack until it snaps into place. You should not have to force it into the handset.
Turn handset on	Press and hold the END key until two chirps sound.
Turn handset off	Press and hold the END key. One chirp will sound. If you are in a call, hang up first, then turn off the handset.

If you want to	Then
Unlock the keypad	Press the Unlk softkey, then # , to unlock the keypad.
Lock the keypad	Press the Cfg softkey, then NavOK . See Phone Settings in the Config Menu for Keypad Autolock settings.
Make an internal call	Press the START key, wait for a dial tone, then dial the extension.
Make an external call	Press the START key, wait for a dial tone, then dial the number just as you would from your desk phone.
Select a line	If multiple lines are available, your telephone system may require you to select a line before dialing a number. Press LINE and the number key corresponding to the desired line. You will hear a dial tone.
Dial a number	Once you hear a dial tone, press the number keys to dial the number.
Answer a call	The handset will ring or vibrate to alert you of an incoming call. Additionally, a line indicator on the display may flash and the display may show information about the call, such as the caller's name and extension. To answer a call, press the START key and hold the earpiece to your ear. You may also activate the speakerphone by pressing the Spkr softkey or use a headset.

If you want to	Then
Answer a call on a second line	If you are on a call and hear subdued ringing, a call is coming in on a second line. The line number on the display may be flashing. To answer this call, put your first call on hold and press the LINE key, then the line number of the second call.
Answer with headset	Press any key (other than END) to answer a call when a headset is plugged in.
Silence while ringing	Press the END key to silence the ring.
Change the ring volume	Press the up/down volume buttons on the side of the handset during ringing. The default ring volumes are set in the User Profile menus.
Adjust the speaker volume	Press the up/down volume buttons on the side of the handset during the call.
Adjust the headset volume	Press the up/down volume buttons on the side of the handset during the call.
Place a call on hold	Press the Hold softkey.
Resume a held call	Press the LINE key followed by the line number key.
Mute the microphone	Press the Mute softkey.
End the call	Press the END key. Be sure to do this at the end of each call to return to the standby mode.

If you want to	Then
Change the profile	Press the Prof softkey and use the Nav keys to select a new profile while in standby mode. The selected profile is marked with an asterisk (*).
Display additional features	During a call press the FCN key to display the options programmed to additional features available in your facility. These might include transfer, conference, voicemail, etc.
Turn on the backlight	The backlight comes on when any key is pressed or when there is an incoming call and stays on for 10 seconds. It turns off after 10 seconds if another key is not pressed within that period.
Use message alerts	If programmed in your facility, message alerts may be activated by pressing the FCN key and then a menu option assigned by the system administrator. The greater-than asterisk (< *) key is used for left and up navigation and the lesser-than pound (# >) key is used for right and down navigation. Contact your system administrator for detailed information about message alert mode.

ADVANCED FEATURES

Facility-Specific Features

Press the **FCN** key while off-hook or in a call to display the the menu options programmed for advanced telephony features such as transfer, conference, and voicemail.

Contact your system administrator for more information about custom features available in your facility. The Quick Reference Guide has a form for you to record facility-specific key press sequences for advanced features.

Message Alert Feature

Custom applications may allow you to read and respond to text messages. The Message Alert application may be available through the **FCN** menu if programmed in your facility. While off-hook, press **FCN** to view the menu, then press one or more number keys to open the application. The handset is now in Message Alert mode.

The **Nav** keys are not enabled by text messaging applications. Instead, use **<*** to move left or up and **#>** to move right or down.

You may change **Message Alert** ring settings through the **Config Menu**. See the diagram on page 22 and the *Changing Ring Settings* section.

The Quick Reference Guide has a form for you to record facility-specific Message Alert 1 and Message Alert 2 information.

Data Entry and Editing

Enter numbers by pressing the buttons on the keypad. The blinking underscore identifies the current cursor position. When entering alphanumeric strings, the **CAPS/caps** softkey will appear and may be pressed to toggle the case. Enter letters by repeatedly pressing the corresponding key until the desired letter displays on the screen. Use the **CAPS** softkey to change the case as needed.

To edit during entry, delete the character to the left of the cursor by pressing the **Del** softkey. To replace an entry, delete it by pressing the **Clr** softkey and then enter the new data. To edit an existing entry, use **Nav◀** and **Nav▶** to move the cursor position, and then press the **Del** softkey to delete the character to the left. Insert new data by pressing the buttons on the keypad.

Alphanumeric entries:

Key	caps	CAPS
1	1	1
2	2 a b c	2 A B C
3	3 d e f	3 D E F
4	4 g h i	4 G H I
5	5 j k l	5 J K L
6	6 m n o	6 M N O
7	7 p q r s	7 P Q R S
8	8 t u v	8 T U V
9	9 w x y z	9 W X Y Z
0	0	0
*	* . - ! \$ % & ' () + , : ; / \ = @ ~	
#	# <space>	

The Config Menu

When the handset is in standby mode, press the **Cfg** softkey to enter the **Config Menu**. The handset cannot make or receive calls while in the **Config Menu**. This menu allows you to set user preferences. Refer to the diagrams on pages 24-25.

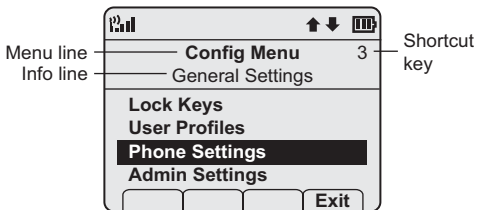

Scroll through menu options by using **Nav▲** and **Nav▼**. When an asterisk (*) appears to the left of an option, it indicates that the option is currently selected. Press the **Exit** softkey to return to standby mode. Use the **Back** softkey to return to the previous menu.

Toggle Options

Some menu options that have only two possibilities operate on a toggle basis. The current setting is shown on the second row of the display, called the info line. Highlight the option and press **NavOK** to toggle between the settings. For example, when **Ring in Headset** is the menu option, **Currently Speaker** will show on the info line. If you select **Ring in Headset**, **Currently Headset** will show on the info line and the menu option will become **Ring In Speaker**.

Profiles

Your handset ring behavior is established by five User Profiles: **Silent**, **Vibrate**, **Loud**, **Soft**, and **Custom**. The currently-active user profile is shown on the standby display. The ring behavior can easily be changed by pressing the **Prof** softkey and selecting a new profile from the list when the handset is in standby mode. The currently-active profile is marked with an asterisk (*).

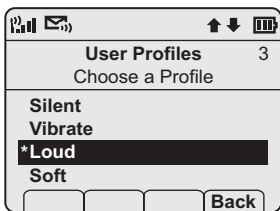

Changing Ring Settings

To change the ring tone or any other ring setting for any profile, go to **User Profiles** and select the profile. Select **Ring Settings** and then select **Telephone** for standard phone calls or one of the **Message Alerts** for text messages. Then select the ring option you want to adjust.

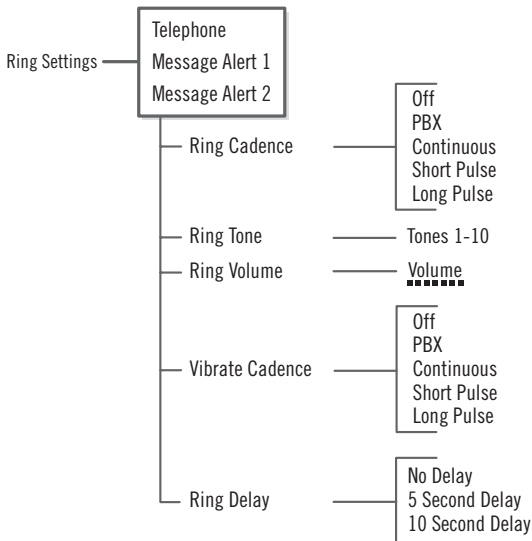

Default Profile Settings

Setting/Profile	Silent	Vibrate	Soft	Loud	Custom
Ring Cadence	Off	Off	Telephone	Telephone	Telephone
Ring Tone	Tone 1	Tone 1	Tone 1	Tone 1	Tone 1
Ring Volume	1	1	3	7	5
Vibrate Cadence	Off	Telephone	Off	Off	Telephone
Ring Delay	0	0	0	0	5
Noise Mode	Normal	Normal	Normal	Normal	Normal
Headset/Speaker	Speaker	Speaker	Speaker	Speaker	Speaker
Key Tones	Off	Off	On	On	On
Warning Tones	Off	Off	On	On	On

Contact your system administrator if you want to reset all user profiles back to these default settings.

Config Menu Options

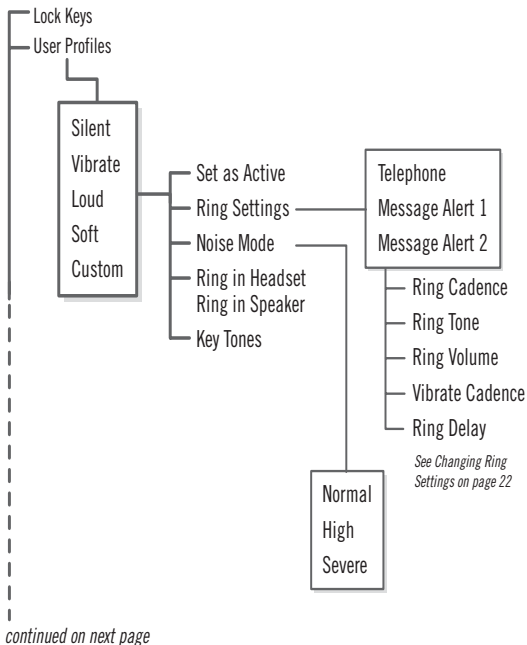

continued from previous page

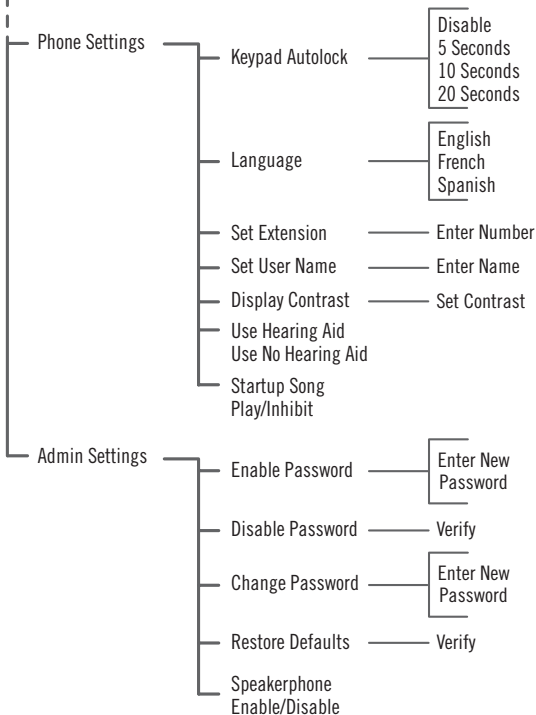

CHARGERS, BATTERY PACKS AND ACCESSORIES

Accessories for the Link 6020 Wireless Telephone include three different charger models, three different Battery Pack models, headsets and several carrying options.

Battery Packs

The Battery Packs must be recharged periodically. Each type of Battery Pack requires a different amount of time to achieve a fully charged state from a fully depleted state. Three Battery Pack options are available

Type	Talk Time	Standby Time	Charging Time
Standard	4 hours	80 hours	2 hours
Extended	6 hours	120 hours	3 hours
Ultra-Extended	8 hours	160 hours	4 hours

The Battery Pack icon on the status row indicates the charge amount remaining. Additionally the handset will sound warning tones and display the **Battery Low** message when there are fewer than two minutes of talk time remaining.

A melody will play when the handset is powered on for the first time after being fully charged, unless this feature has been disabled. Each Battery Pack type has a different melody.

See your system administrator if you have questions about the type of Battery Pack you have been issued.



The type of Battery Pack is printed on the label. Remove the Battery Pack and view the label to determine the type of Battery Pack you have been issued.

The Battery Pack can be changed while the call is still in progress. Do not press **END**. Quickly remove the discharged Battery Pack and replace with a charged Battery Pack, press **END** to turn the handset back on and then press **START** to resume the call.

Charger Models

Three charger models are available for the Link 6020 Wireless Telephone. The Single Charger will charge a single handset with an installed Battery Pack. The Dual Charger will charge the handset and a spare Battery Pack. The Quad Charger can charge up to four Battery Packs at a time.

The Single and Dual Chargers allow the handset to remain operative in speakerphone mode or with a headset while charging. Handsets may be charged while in standby mode, while in an active call or while turned off.

Place the Single or Dual Charger on a flat, horizontal surface. Plug the power supply into the charger and into an appropriate wall outlet. The Quad Charger may be mounted on a horizontal or vertical surface.

Charging Status

The handset display and the LED on the Dual and Quad Chargers indicate whether or not charging is occurring or completed or if a Battery Pack failure has been detected.*

Handset/LED	Charging Status
-------------	-----------------

Charging... LED Solid On	The Battery Pack in the handset is charging.
-------------------------------------	--



Note that in the Dual Charger, the handset's Battery Pack takes charging precedence, and when it is finished charging, the single Battery Pack in the rear slot will charge.

Charge Complete	The Battery Pack in the handset has finished charging.
------------------------	--

LED Off	Battery Pack fully charged, empty slot, or unit is not powered.
----------------	---

Battery Failure LED Flash	Error. Battery Pack not able to be charged. Reinsert Battery Pack or replace Battery Pack.
--------------------------------------	--

* Note: the Single Charger does not have an LED indicator.

Single Charger



The Single Charger is designed to allow the handset to remain operational through speakerphone or headset use while the handset's Battery Pack is being charged. The handset may also be charged while it is in standby mode or turned off.

Place the handset in the Single Charger facing forward. While the handset is charging in standby mode, it will display its extension number and **Charging...** An animated charge icon will indicate that charging is in progress. The handset is fully operational and will ring if called. When the handset is charging while turned off, only **Charging...** will display and no calls will be received. The dots will be racing during the charging cycle.

When the handset is fully charged, **Charge Complete** will display. No charging information will display during an active call.

Dual Charger

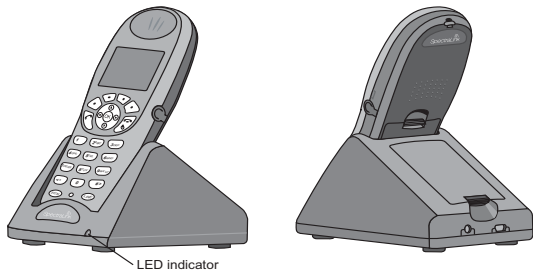

The Dual Charger is designed to charge the Battery Pack in the handset while it remains operational and also charge an additional Battery Pack in the rear charging bay. The handset has charging priority when both slots are occupied.

Place the handset in the front slot, facing forward. The Battery Pack alone snaps into the charging bay as shown in the illustration.

The LED indicates the status of the Battery Pack in the rear bay. The handset displays its charging status as described for the Single Charger.

When the handset is fully charged or is removed, the Battery Pack will begin charging.

Note that the time it takes for the Battery Pack to charge will be lengthened if its charging cycle is interrupted for a handset to charge.

Quad Charger

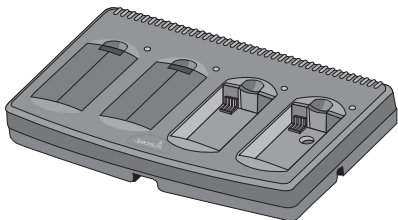

The Quad Charger is designed to simultaneously charge four Battery Packs. It may be mounted on a horizontal or vertical surface. The Battery Pack snaps into the charging slot. The LED above the occupied bay indicates the charging status of the Battery Pack in the bay.



A flashing LED may indicate a Battery Pack failure. Verify the condition of the Battery Pack by the following procedure before replacing it. First check the Battery Pack in a different bay or substitute another charger and repeat the operation that caused the failure. If the same Battery Pack lights a steady LED when inserted in a different bay or charger, the first charger may be faulty. Contact your system administrator for service information.

Carrying Options

The following options are available for handset protection and easy handset carrying and removal.

Belt clip: Spring-loaded plastic belt clip that attaches to the back of the handset.

Swivel belt clip: Swivel-style belt clip that attaches to the back of the handset with full 360 degree swivel or eight-position ratchet options.

Swivel carrying case: Black leather case with keypad cover and swivel-style quick release belt clip.

Holster: Black holster with belt clip.

Cord lanyard: Nylon cord lanyard with quick disconnect.

Coiled lanyard: Plastic coiled lanyard with clothing clip.

Headsets

SpectraLink offers optional headsets for use in noisy environments or if you need to have your hands free while talking on the handset.

To use the headset, simply plug it into the jack on the right side of the handset.

While using a headset, the handset will ring according to the user profile setting established in the **Headset/Speaker Ring** option. The external ring will ring according to the setting of the profile.

The headsets offered by SpectraLink have been laboratory tested and work properly with the wireless telephone. SpectraLink does not recommend using other headsets.

HANDSET ADMINISTRATION

FAQs

How does the handset power off and power on?

The **END** key is the power on/power off key. Press and hold it to turn the handset on. Turn the handset off from the standby mode by pressing and holding the **END** key. If you are in an active call, end the call by pressing the **END** key. This returns the handset to the standby mode, then press **END** again to turn the handset off.

How do I place a call and terminate a call?

To place a call, press the **START** key and then dial the number. End the call by pressing the **END** key. You can also use the speakerphone instead of the **START** key.

Can I change the ring?

The ring is fully adjustable and may be set differently for different profiles. For a complete explanation of how to change the ring, see the *Profile Settings* section of this guide.

How do I change the voice volume and the ringing volume?

Whether using a headset, the speakerphone, or the internal speaker, the speaker volume for the current call may be raised or lowered by pressing the up and down volume buttons on the side of the handset.

The volume buttons may be pressed while the handset is ringing to raise or lower the ring volume, which also changes the ring volume setting in the current profile.

What is the range of the wireless telephone?

As barriers affect radio transmission, there is no single answer for this question. Normally, you can expect the same range as with any other wireless device. However, if your facility has metal walls or other materials that inhibit radio waves, the range will be reduced.

How do I charge the Battery Pack?

The Battery Pack in the handset may be charged in a Single or Dual Charger without being removed from the handset by simply placing the handset into the charger. A spare Battery Pack may be charged in the rear bay of the Dual Charger or in a Quad Charger.

How long does the Battery Pack hold a charge?

There are three different Battery Pack models and each has a different charge capacity. The type of Battery Pack is printed on the label. Remove the Battery Pack and view the label to determine the type of Battery Pack you have been issued.

Type	Talk Time	Standby Time	Charging Time
Standard	4 hours	80 hours	2 hours
Extended	6 hours	120 hours	3 hours
Ultra-Extended	8 hours	160 hours	4 hours

What features (transfer, mute, etc.) are available and how are they activated?

Active call features such as Mute and Hold are available by pressing the softkey programmed to the feature. Additional features, such as Transfer and Conference, are locally programmed and usually activated by pressing the **FCN** key and then the softkey that corresponds to the programmed feature. Contact your phone system administrator for detailed information on how to access these features in your facility.

Can I use the wireless telephone at home?

Access points installed in your facility transmit the radio waves emitted by your wireless telephone to the telephone system in your facility which links the handsets to each other and to the rest of the world. The handset operates only within range of these access points and therefore will not work in your home.

How should I clean the handset?

Wiping the handset surface with a water-dampened cloth or paper towel will remove most films or residues. If the soiling is too stubborn for plain water, a mild detergent solution may be used. A spray cleaner may be used with care. Do not spray at an angle. Do not allow liquid cleaners to seep into keypad. Be sure to wipe away any detergent residue with a clean water-dampened cloth. Do not immerse in any fluid.

SAFETY INFORMATION

Chargers and Battery Packs

It is normal for the Battery Pack to become warm when charging.

Chargers operate in a 50° to 85° F (10° to 30° C) environment. Do not expose them to freezing temperatures or direct sunlight.

Do not place anything in the charger other than the handset or single Battery Pack as appropriate, to avoid bending the contacts. Bent contacts can keep the Battery Pack from charging.

Only use SpectraLink Battery Packs with SpectraLink chargers.

Never use a non-SpectraLink charging unit as it could damage the Battery Pack.

Only use the original plug-in power adapter for the chargers.

Contact your service representative for assistance if you have a faulty Battery Pack or a problem with your charger.



Do not immerse the Battery Pack in water or throw into fire.

Do not throw away the Battery Pack with your domestic waste. Take used Battery Packs to an appropriate collection point for recycling or send them back to your supplier or servicing agent.



All batteries can cause property damage and/or bodily injury, such as burns, if a conductive material such as jewelry, keys, or beaded chains touches exposed terminals. The conductive material may complete an electrical circuit (short circuit) and become quite hot. Exercise care in handling any charged battery, particularly when placing it inside a pocket, purse, or other container with metal objects.

Wireless Telephones



WARNING: Changes or modifications to this equipment that are not approved by SpectraLink may cause this equipment to fail to comply with part 15 of the FCC rules, voiding the user's authority to operate this equipment.



WARNING: SpectraLink products contain no user-serviceable parts inside. Refer servicing to qualified service personnel.



It is recommended that standard acceptance procedures be followed prior to operating this equipment in proximity of life-support systems.



Earpiece may retain magnetic objects.

Operational Warnings

Potentially Explosive Atmospheres

Turn off your handset prior to entering any area with a potentially explosive atmosphere. Do not remove, install, or charge batteries in such areas. Sparks in a potentially explosive atmosphere can cause an explosion or fire resulting in bodily injury or even death.



Areas with potentially explosive atmospheres include fueling areas such as below decks on boats, fuel or chemical transfer or storage facilities, areas where the air contains chemicals or particles such as grain, dust, or metal powders, and any other area where you would normally be advised to turn off your vehicle engine. Areas with potentially explosive atmospheres are often posted, but not always.

Electromagnetic Interference and Compatibility



Nearly every electronic device is susceptible to electromagnetic interference (EMI) if inadequately shielded, designed, or otherwise configured for electromagnetic compatibility.

Facilities

To avoid electromagnetic interference and/or compatibility conflicts, turn off your handset in any facility where posted notices instruct you to do so. Hospitals or health care facilities may be using equipment that is sensitive to external RF energy.

Pacemakers

The Health Industry Manufacturers Association recommends that a minimum separation of 6 inches (15 cm) be maintained between a handheld, wireless-radio product and a pacemaker. These recommendations are consistent with the independent research by, and recommendations of, Wireless Technology Research. Persons with pacemakers should:

- ALWAYS keep the handset more than 6 inches (15 cm) from their pacemaker when the handset is turned on.
- Not carry the handset in a breast pocket.
- Use the ear opposite the pacemaker to minimize the potential for interference.
- Turn the handset off immediately if you have any reason to suspect that interference is taking place.

Hearing Aids

Some digital wireless handsets may interfere with some hearing aids. The **Phone Settings** option—**Use Hearing Aid**—is designed to improve the audio for hearing aid users. If interference persists, you may want to consult your hearing-aid manufacturer to discuss alternatives.

Other Medical Devices

If you use any other personal medical device, consult the manufacturer of your device to determine if it is adequately shielded from external RF energy. Your physician may be able to assist you in obtaining this information.

Use While Driving

Campus installations and warehouse facilities that use vehicles such as forklifts or golf carts should abide by these guidelines when using wireless telephones:

- Give full attention to driving and to the road, aisle, or path.
- Use hands-free operation, if available.
- Pull off the road, aisle, or path and park before making or answering a call.

For Vehicles Equipped with an Airbag

Do not place a portable device in the area over the airbag or in the airbag deployment area. An airbag inflates with great force. If a handset is placed in the airbag deployment area and the airbag inflates, the handset may be propelled at high speed and cause serious injury to occupants of the vehicle.

INFORMATIONS CONCERNANT LA SÉCURITÉ

Chargeurs et batteries

Il est normal que la batterie chauffe au cours du chargement.

Les chargeurs fonctionnent dans un environnement où la température est comprise entre 10 ° et 30 °C (soit 50 ° à 85 °F). Ne les exposez pas directement au soleil, ni à des températures négatives.

Ne placez dans le chargeur aucun objet autre que le combiné ou la batterie, selon les cas, pour éviter d'endommager les contacts. Si les contacts sont abîmés, la batterie ne pourra pas se charger correctement.

Utilisez exclusivement des batteries SpectraLink avec les chargeurs SpectraLink.

N'utilisez jamais de chargeurs autres que ceux de la gamme SpectraLink car ils risqueraient d'endommager la batterie.

Utilisez toujours l'adaptateur d'alimentation fourni avec les chargeurs.

Si votre batterie est défectueuse ou en cas de problème avec votre chargeur, contactez le représentant du service à la clientèle pour obtenir une assistance.



Ne plongez pas la batterie dans l'eau et ne la jetez pas au feu.

Ne jetez pas la batterie avec vos ordures ménagères. Déposez les batteries usagées à un point de recyclage ou renvoyez-les à votre fournisseur ou agent de maintenance.



Toutes les batteries peuvent entraîner des dommages matériels et/ou des blessures corporelles, par exemple des brûlures, si un matériau conducteur comme un bijou, des clés ou des chaînes à perles entrent en contact avec les bornes exposées. Le matériau conducteur peut refermer un circuit électrique (court-circuit) et devenir assez chaud. Soyez vigilant lorsque vous manipulez une batterie chargée, en particulier si vous la placez à l'intérieur d'une poche, d'un porte-monnaie ou de tout autre réceptacle contenant des objets métalliques.

Téléphones sans fil



AVERTISSEMENT : Toute modification apportée à cet équipement qui n'a pas été expressément approuvée par SpectraLink peut altérer la conformité de l'appareil à la section 15 des normes de la FCC, annulant alors votre droit d'utiliser cet appareil.



AVERTISSEMENT : Les produits de SpectraLink ne contiennent aucune pièce réparable par l'utilisateur. Pour toute réparation, adressez-vous à un technicien qualifié.



Il est recommandé de suivre les procédures d'acceptation standard avant d'utiliser cet équipement à proximité d'équipements d'assistance respiratoire.



L'écouteur peut contenir des objets magnétiques.

Avertissements concernant le fonctionnement

Atmosphères potentiellement explosives

Mettez votre combiné hors tension avant d'entrer dans une zone présentant une atmosphère potentiellement explosive. Ne retirez pas, n'installez pas et ne chargez pas les piles dans ces zones. Dans une atmosphère potentiellement explosive, des étincelles peuvent provoquer une explosion ou un incendie, entraînant des blessures corporelles, voire la mort.



Les zones à atmosphère potentiellement explosive auxquelles il est fait référence ci-dessus comprennent les zones de ravitaillement en carburant, par exemple les ponts inférieurs de bateaux, les installations de transvasement ou d'entreposage de carburant ou de produits chimiques, les zones où l'air contient des produits chimiques ou des particules telles que des grains, des poussières ou des poudres métalliques et toute autre zone où il vous est généralement recommandé d'éteindre le moteur de votre véhicule. Les zones à atmosphère potentiellement explosive sont souvent, mais pas toujours, clairement signalées.

Interférences électromagnétiques et compatibilité



Quasiment tous les appareils électroniques sont sensibles aux interférences électromagnétiques (EMI) s'ils ne sont pas convenablement protégés, conçus ou configurés pour être compatibles avec ce type d'énergie.

Établissements particuliers

Pour éviter les interférences électromagnétiques et tout problème de compatibilité, mettez votre combiné hors tension dans tout établissement où des panneaux vous invitent expressément à l'éteindre. Les hôpitaux ou les centres de santé sont susceptibles d'utiliser des équipements sensibles à l'énergie externe des radio-fréquences.

Stimulateurs cardiaques

L'association des fabricants de matériel médical recommande que les équipements radio portables sans fil soient maintenus à une distance minimale de 15 centimètres des stimulateurs cardiaques. Ces recommandations sont conformes aux recherches et aux recommandations du cabinet indépendant Wireless Technology Research. Il est recommandé aux personnes portant un stimulateur cardiaque de :

- TOUJOURS maintenir le combiné, lorsqu'il est sous tension, à une distance minimale de 15 cm de leur stimulateur cardiaque ;
- ne pas porter le combiné dans une poche proche de leur cœur ;
- utiliser l'oreille du côté opposé à celui du stimulateur cardiaque pour minimiser les interférences potentielles ;
- mettre immédiatement hors tension le combiné s'ils soupçonnent le moindre problème d'interférences.

Prothèses auditives

Certains combinés sans fil numériques peuvent gêner le fonctionnement des prothèses auditives. L'option **Phone Settings—Use Hearing Aid** vise à améliorer la qualité audio pour les utilisateurs portant une prothèse auditive. Si les interférences persistent, il peut s'avérer préférable de consulter le fabricant de la prothèse auditive pour discuter d'autres solutions.

Autres appareils médicaux

Si vous utilisez un autre appareil médical, consultez son fabricant afin de déterminer s'il est suffisamment protégé contre l'énergie RF externe. Votre médecin peut vous aider à obtenir ces informations.

Utilisation au volant

Si vous conduisez des véhicules, par exemple des chariots élévateurs à fourche ou des voiturettes de golfe, sur votre campus ou au sein de vos entrepôts, vous devez respecter les lois et réglementations régissant l'usage des téléphones portables au volant :

- Vous devez être très attentif à la route, à l'allée ou au chemin où vous circulez.
- Utilisez la fonction mains libres, si celle-ci est disponible.
- Le cas échéant, arrêtez-vous et garez-vous sur le côté de la route, de l'allée ou du chemin avant d'effectuer un appel ou d'y répondre.

Pour les véhicules équipés d'un airbag

Ne posez pas un combiné portable sur un airbag ou dans sa zone de déploiement. Les airbags se gonflent avec puissance. Si un combiné est posé dans sa zone de déploiement et l'airbag se gonfle, le combiné risque d'être violemment projeté à l'intérieur du véhicule et de blesser gravement les occupants.

INDEX

A

Accessories

- Battery Packs 26
- Carrying options 32
- Chargers 27
- Headset 32

Active mode 7

Administration

- Care of handset 47
- FAQs 33
- Handset Operation Summary 14–17
- Specifications 46

Answer call

- First line 15
- Second line 16
- Via headset 16

B

Backlight 17

Battery Packs

- Charging 28–31, 34
- Charging status 28
- Dual Charger 30
- Options 26
- Quad Charger 31
- Remove/replace 14
- Single Charger 29

C

Care of handset 47

Carrying options 32

Chargers

- Charging status 28
- Cleaning 47
- Dual Charger 30
- Quad Charger 31

Single Charger 29

Use of 27–31

Cleaning handsets and chargers 35, 47

Config Menu

- Default profile settings 23
- Defined 20
- Entering 20
- Mode 7
- Options diagram 24–25
- Profiles 21

Config menu

- Options diagram 24

D

Data entry 19

Data entry table 19

Dial call

- Outgoing calls 15, 33

Displays, handset 8

E

Edit

- Arrows during 10
- Data entry 19

External call 15

F

Features

- Config Menu 20
- Config Menu options 24–25
- Display additional 17
- Facility-specific 18
- Message alert 7, 17, 18

H

Handset Operation Summary 14–17

Hang up 14, 16

Headset
 Answer 16
 Cleaning connector 47
 Profile setting 23
 Use of 32
 Volume 16, 33
 While charging 27, 29

Hold
 Place a call on 16
 Softkey label 12

I

Internal call 15

K

Keypad
 Cleaning 35, 47
 Cover 32
 Illustration 2
 Lock 11, 15
 Unlock 13, 15

M

Menu navigation 7
Message alert 7, 17, 18
Modes of operation 7
Mute
 On status bar 10
 Softkey label 12
 Use of 16, 34

N

Navigation 7

R

Range 33

S

Safety
 Use while driving 39

Shortcut key 9

Softkey

 Active 12–13

 Labels 12–13

Speakerphone

 Answer with 15

 Icon 10

 Softkey label 13

 Use of 33

 Volume with 33

 While charging 27, 29

Specifications 46

Standby mode 7

Status indicators 10–11

U

User profile

 Changing 17

 Headsets and 32

 Setting 21–23

V

Volume

 Changing 33

 Headset 16

 Ring 16, 23

SPECIFICATIONS

Radio frequency	902–928 MHz
Transmission type	Frequency Hopping Spread Spectrum (FHSS)
FCC certification	Part 15.247
Voice encoding	ADPCM (Proprietary)
Transmit power	Up to 100 mW peak, < 10 mW average
Display	Up to four lines of text plus two icon status rows and one row for softkey labels.
Model dimensions	5.4" × 2.0" × 0.9" (14.0 × 5.1 × 2.3 cm)
Model weight	3.9 ounces (112.4 g) with Standard Battery Pack 4.1 ounces (115.7 g) with Extended Battery Pack 4.5 ounces (128.8 g) with Ultra-Extended Battery Pack
Standard Battery Pack capacity	4 hours talk time 80 hours standby
Extended Battery Pack capacity	6 hours talk time 120 hours standby
Ultra-Extended Battery Pack capacity	8 hours talk time 160 hours standby

CARE OF YOUR HANDSET

- Avoid dropping the handset or knocking it against hard surfaces. Carrying the handset in a holster or carrying case will help protect it.
 - There are no serviceable parts in the handset or chargers. You should not open the handset case or disassemble the chargers. Doing so will void your warranty.
 - Turn off the handset and unplug chargers before you clean them. Take care not to exert undue pressure on charger electrical contacts while wiping.
 - Wiping the handset surface with a water-dampened cloth or paper towel will remove most films or residues. If the soiling is too stubborn for plain water, a mild detergent solution may be used. A spray cleaner may be used with care. Do not spray at an angle. Do not allow liquid cleaners to seep into keypad. Be sure to wipe away any detergent residue with a clean water-dampened cloth. Do not immerse.
 - Should the headset connector become dirty, you may experience a scratchy or intermittent signal. To clean the connector, dip the non-padded end of a wooden or paper cotton swab stick in isopropyl alcohol. Gently insert in the connector and twist, repeating several times. If available, blow compressed air into the connector to clear debris.
 - Keep the headset jack covered when it is not in use.
 - Using a carrying case may help protect the surfaces and help prevent liquids (e.g., rain) from entering into the interior of the handset.
 - If your handset interior gets wet, do not try to accelerate drying with the use of an oven or a dryer as this will damage the handset and void the warranty. Instead, do the following:
 1. Immediately power off the handset.
 2. Remove the Battery Pack from handset.
 3. Shake excess liquid from the handset.
 4. Place the handset and Battery Pack in an upright position in an area that is at room temperature and has good airflow.
 5. Let the handset and Battery Pack dry for 72 hours before reconnecting the Battery Pack and/or powering on the handset.
- If the handset does not work after following the steps listed above, contact your phone system administrator for servicing information.

SpectraLink Corporation
5755 Central Avenue
Boulder, CO 80301
303 440 5330
800 676 5465
www.spectralink.com

Trademark Information

SpectraLink®

Link

Are trademarks and registered trademarks of SpectraLink Corporation.

The SpectraLink logo is a registered trademark in the United States of America and in other countries.

Copyright © 2007 SpectraLink Corporation.

All rights reserved

Information in this document is subject to change without notice and does not represent a commitment on the part of SpectraLink Corporation. The software described in this document is furnished under a license and may only be used pursuant to the terms of (1) SpectraLink's software license agreement available at <http://www.spectralink.com/softwareUpdates> OR (2) the terms and conditions previously agreed to in writing between the user and SpectraLink Corporation OR (3) the terms and conditions previously agreed to in writing between the user and an authorized SpectraLink reseller (each, the "Agreement"). The software may be used only in accordance with the terms of the Agreement. No part of this manual, or the software described herein, may be reproduced or transmitted in any form or by any means, electronic or mechanical, including photocopying and recording, for any purpose except for the sole intent to operate the product or without the express written permission of SpectraLink Corporation.

Free Manuals Download Website

<http://myh66.com>

<http://usermanuals.us>

<http://www.somanuals.com>

<http://www.4manuals.cc>

<http://www.manual-lib.com>

<http://www.404manual.com>

<http://www.luxmanual.com>

<http://aubethermostatmanual.com>

Golf course search by state

<http://golfingnear.com>

Email search by domain

<http://emailbydomain.com>

Auto manuals search

<http://auto.somanuals.com>

TV manuals search

<http://tv.somanuals.com>