

AIR HOGS™

SKYWINDER™



INSTRUCTIONS

Contents:

- 1 SkyWinder™ Stunt Plane
- 1 Controller
- 1 Charger/Trainer/Display Stand
- 2 Extra Propellers
- 1 Tool

NO ASSEMBLY REQUIRED

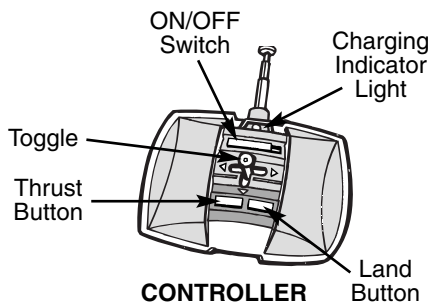

CONTROLLER

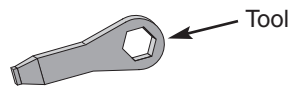

Tool

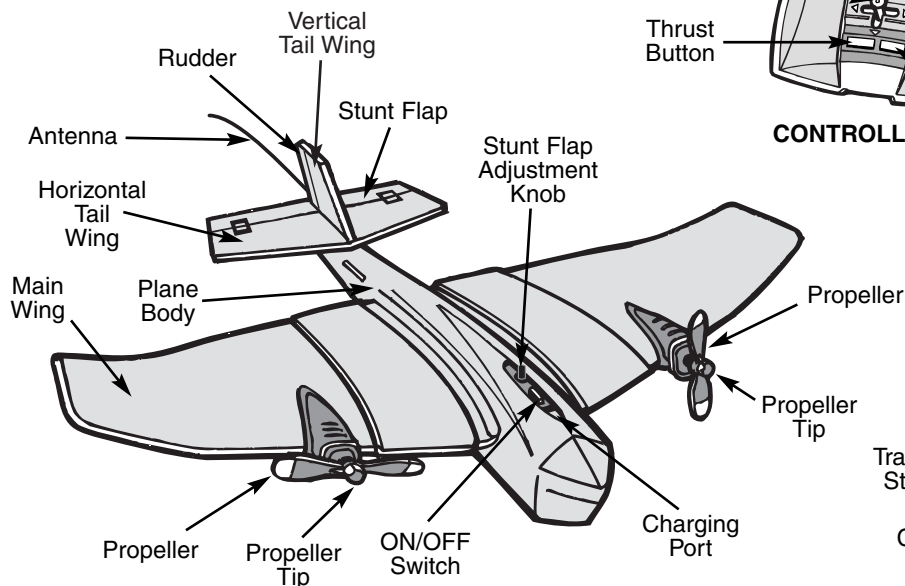

SKYWINDER™ STUNT PLANE

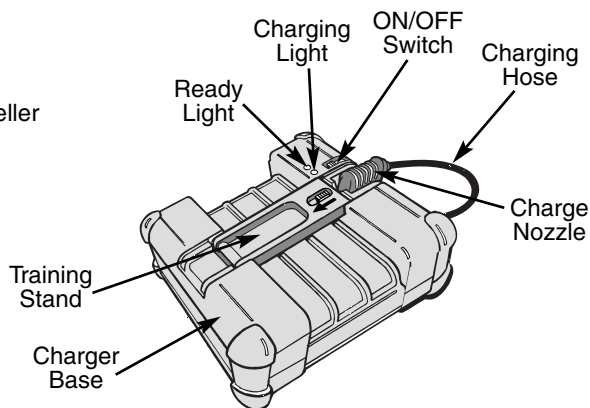

CHARGER/TRAINER/DISPLAY STAND

BATTERY INSTALLATION

CONTROLLER

1. Use a Phillips screwdriver to loosen the screw in the battery compartment door.
2. Remove the battery door.
3. Insert six 1.5 Volt AA batteries (not included).
4. Replace battery compartment door and refasten the screw.

IMPORTANT:

Be sure to insert the batteries as indicated inside compartment with the correct polarity.

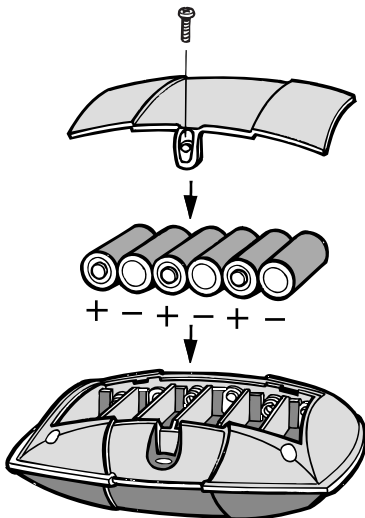

CHARGER/TRAINER/DISPLAY STAND

1. Use a Phillips screwdriver to loosen the screw in the battery compartment door.
2. Remove the battery door.
3. Insert eight 1.5 Volt D alkaline batteries (not included).
4. Replace battery compartment door and refasten the screw.

IMPORTANT:

Be sure to insert the batteries as indicated inside compartment with the correct polarity.

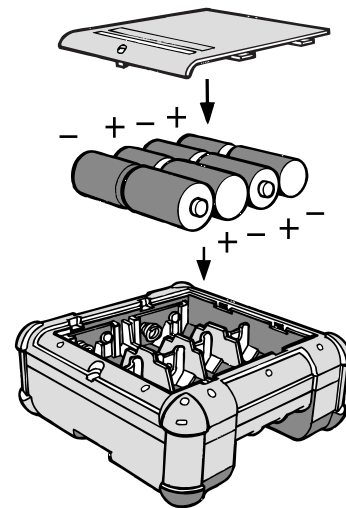

IMPORTANT BATTERY INFORMATION

- Battery installation should be performed by an adult.
- Use only batteries recommended. Be careful to install the batteries with the correct polarity, as indicated.
- Do NOT mix old and new batteries.
- Do NOT mix alkaline, standard, or rechargeable batteries.
- Do NOT attempt to charge non-rechargeable batteries.
- Do NOT short circuit the supply terminals.
- Do NOT overcharge the plane's batteries.
- Exhausted batteries are to be removed, as they will adversely affect the performance.
- Do not dispose of batteries in fire. Battery may explode or leak.

- CAUTION: Plane contains a rechargeable cell. If fluid leaks from the plane, avoid contact with eyes and dispose of the plane. Only use charger supplied with this package.
- Do NOT use any other source to charge your SkyWinder™.
- Different types of batteries or new and used batteries are not to be mixed.
- Do not use rechargeable batteries.
- Only batteries of the same or equivalent type as recommended are to be used.
- Rechargeable batteries are to be removed from the toy before being charged (if removable).
- Rechargeable batteries are only to be charged under adult supervision (if removable).

CHARGING YOUR SKYWINDER™

IMPORTANT: BEFORE YOUR FIRST FLIGHT, YOU MUST CHARGE AND DISCHARGE YOUR AIRPLANE FULLY 1 TIME. YOU MUST ALSO REPEAT THIS STEP WHEN A PROLONGED PERIOD OF TIME HAS PASSED WITHOUT FLYING. FAILURE TO DO THIS WILL RESULT IN SHORTENED LIFESPAN FOR YOUR AIRPLANE. FOR ALL OTHER FLIGHTS, CHARGE THE BATTERIES ONCE ONLY. DO NOT OVERCHARGE THE BATTERIES AS THIS WILL PERMANENTLY DAMAGE THE BATTERIES.

STEP 1

Ensure that the ON/OFF SWITCH on the plane and the charger are "OFF".

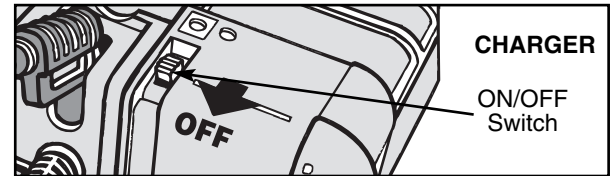
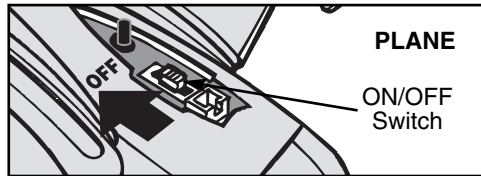

STEP 2

Insert the CHARGE NOZZLE into the plane's CHARGING PORT.

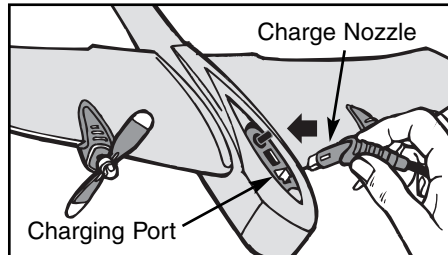

STEP 3

Start charging by switching the charger's ON/OFF SWITCH to "ON". Let the plane charge for 5 minutes. **NOTE: The CHARGING LIGHT on the charger will blink red during charging. When charging is complete, the READY LIGHT will turn to a solid green.**

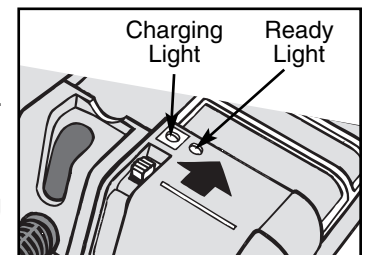

STEP 4

Turn the ON/OFF SWITCH on charger to "OFF".

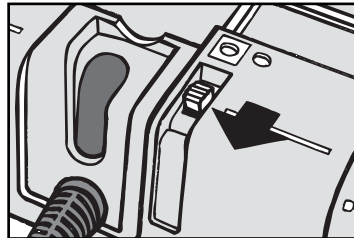

STEP 5

Unplug the CHARGE NOZZLE from the plane's CHARGING PORT. **NOTE: You are now ready to set up your SkyWinder™ for indoor training.**

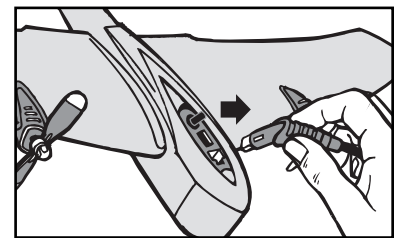

IMPORTANT CHARGING TIPS

By following these charging tips, your SkyWinder™ plane's batteries lifespan is extended.

- After each flight, switch off the plane.
- Before storing the plane for a long period of time, fully charge your plane and switch the plane off.
- Prior to flying in cold weather, store the plane in an indoor area with a temperature above 68°F/20°C.
- If the battery condition (completely drained or fully charged) is unknown, drain the battery fully by turning the plane on until the plane's rotors stop moving.
- Do not charge the plane's batteries more than twice at a time. If the battery power is weak, drain the batteries by leaving the plane on. Rest the plane for 1 minute before recharging the battery.

SETTING UP YOUR SKYWINDER™ FOR INDOOR TRAINING

STEP 1

Unlock the TRAINING STAND and lift it until it is vertical with the CHARGER BASE.

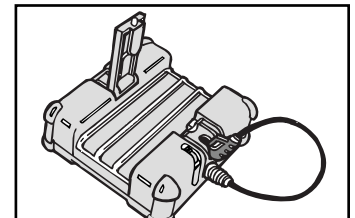
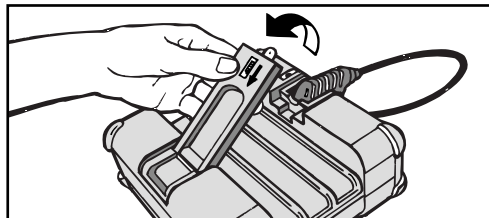

STEP 2

Carefully place the plane's TRAINING STAND PORT onto the TRAINING STAND ROD.

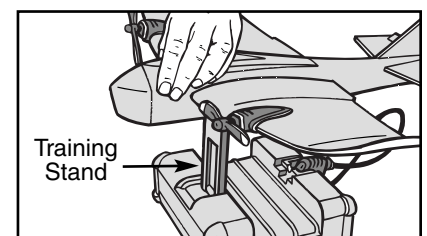
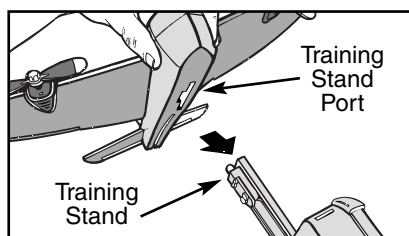

SETTING UP YOUR SKYWINDER™ FOR INDOOR TRAINING continued

STEP 3

Turn the plane's ON/OFF SWITCH to "ON".

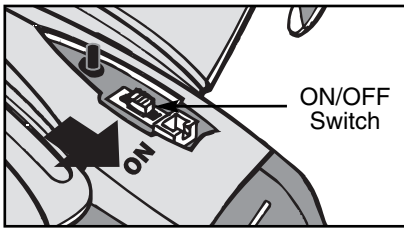

STEP 4

Turn the controller's ON/OFF SWITCH to "ON".

NOTE: You are now ready to practice flying on your INDOOR TRAINER! Please refer to Page 4 for Basic Controls.

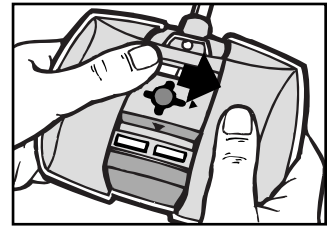

PRE-FLIGHT CHECK

1. Ensure that the STUNT FLAP is LEVEL (or ALIGNED WITH) the HORIZONTAL TAIL WING.

CORRECT ALIGNMENT

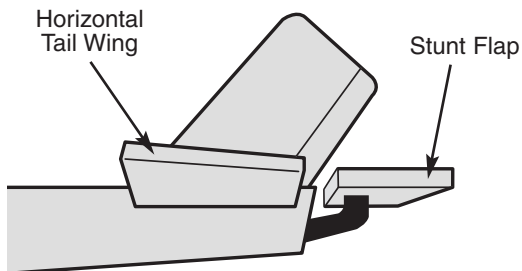

INCORRECT ALIGNMENT

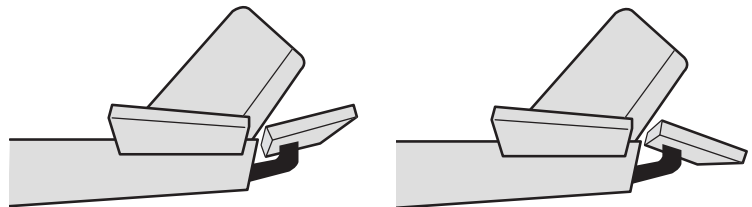

IF THE FLYING HEIGHT IS TOO LOW OR THE PLANE DOES NOT CLIMB, THE STUNT FLAP MAY NOT BE HORIZONTAL. ADJUST THE STUNT FLAP UPWARD UNTIL IT IS LEVEL WITH THE HORIZONTAL TAIL WING.

Adjustments can be made by turning the STUNT FLAP ADJUSTMENT KNOB.

- Turning the STUNT FLAP ADJUSTMENT KNOB *counter-clockwise* will adjust the STUNT FLAP upwards.
- Turning the STUNT FLAP ADJUSTMENT KNOB *clockwise* will adjust the STUNT FLAP downwards.

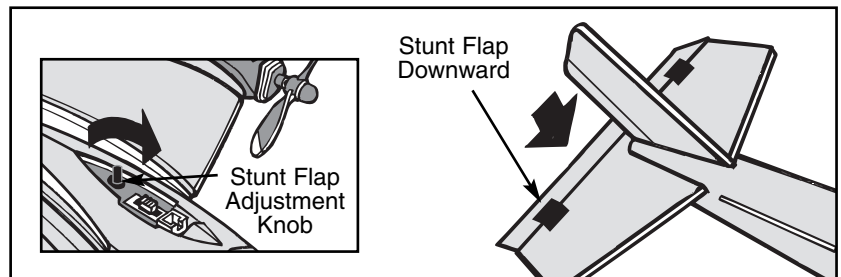
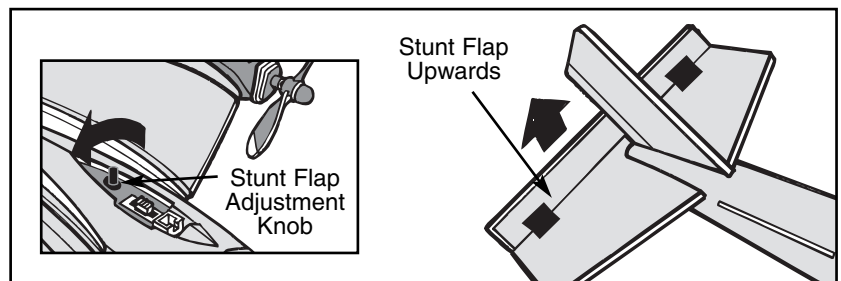

2. HORIZONTAL TAIL WING, VERTICAL TAIL WING and MAIN WING are straight (not bent or twisted).
3. Both PROPELLERS can spin freely.

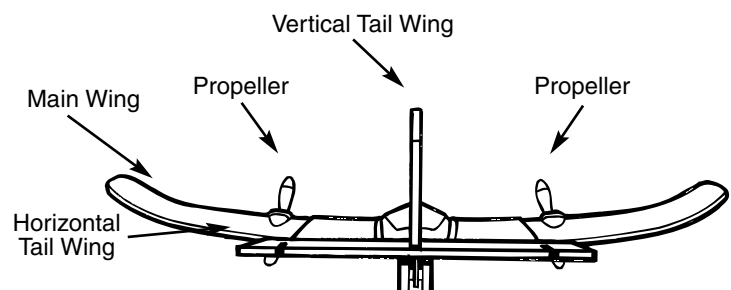

BASIC FLYING TIPS

- Always launch your plane against the wind direction for best performance.
- Never fly the plane in high winds. HIGH WINDS WILL LIMIT, AND MAY PREVENT, YOUR ABILITY TO CONTROL THE AIRPLANE. USE IN HIGH WINDS MAY ALSO RESULT IN LOSS OF, OR DAMAGE TO, THE AIRPLANE.

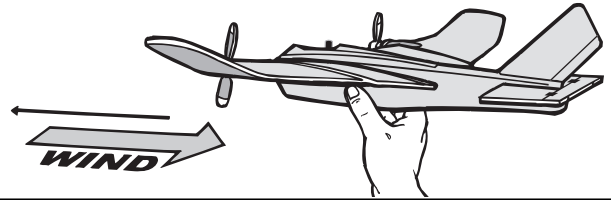

BASIC CONTROLS FOR YOUR AIR HOGS™ SKYWINDER™

TURN LEFT/RIGHT

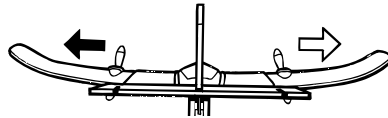
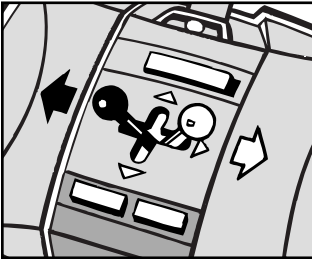

Toggle LEFT or RIGHT

NOSE DOWN

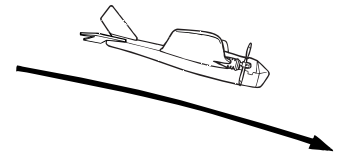
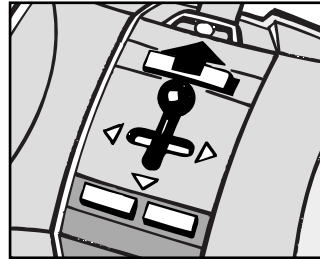

Toggle FORWARD

NOSE UP

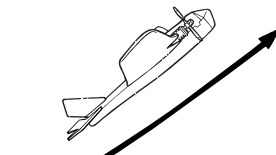
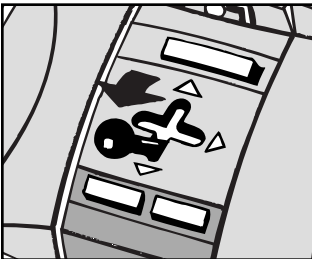

Toggle BACK

CLIMB

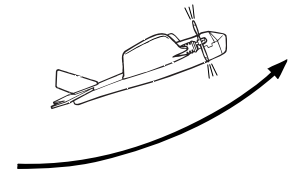
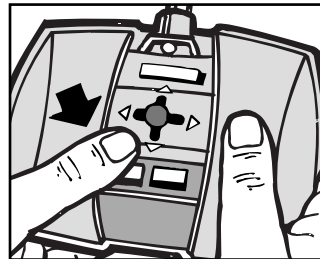

Press THRUST button

LAND – OPTION 1

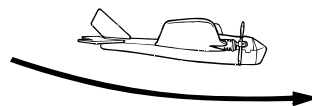
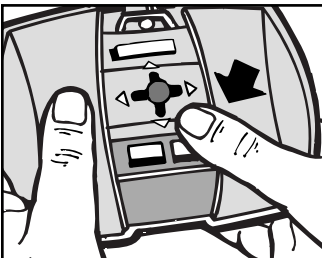

Push LAND button

LAND – OPTION 2

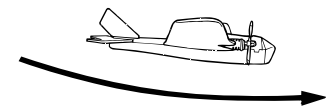
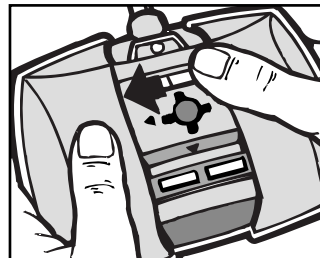

Turn ON/OFF SWITCH to the "OFF" position.

NOTE: Once SWITCH is turned off, you WILL NO LONGER be able to control the plane's direction.

LEVEL OFF

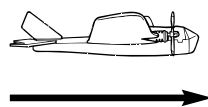

Toggle to NEUTRAL position

NOTE: This plane has a 300 foot control range. Flying out of range may result in loss and/or potential damage to the plane.

HOW TO COMPLETE ADVANCED STUNTS ON YOUR AIR HOGS™ SKYWINDER™

STEP 1

Set plane's ON/OFF SWITCH to "ON" for power.
NOTE: ENGINES WILL NOT START YET (See Step 2).

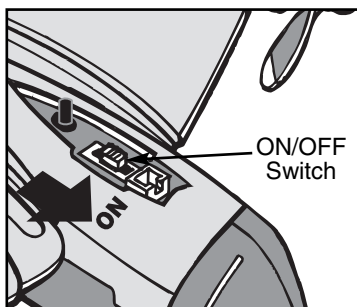

STEP 2

Set controller's ON/OFF SWITCH to "ON".
NOTE: ENGINES WILL NOW START.

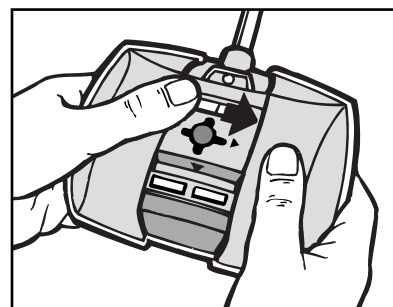

STEP 3

Launch plane against wind. Toss it firmly, level with the ground.

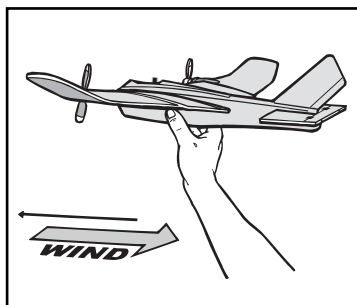

STEP 4

Press the THRUST BUTTON to climb.
IMPORTANT: DO NOT attempt any stunts until the plane has reached and leveled off at the minimum altitude listed below, and the plane is flying against the wind.

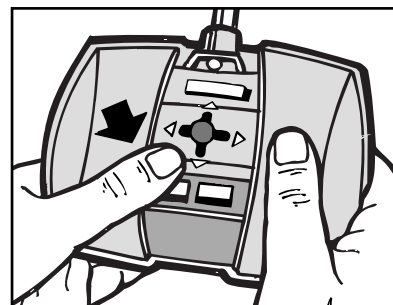

STEP 5 - STUNTS

1. NORMAL LOOP

MINIMUM ALTITUDE 50 Feet

A.

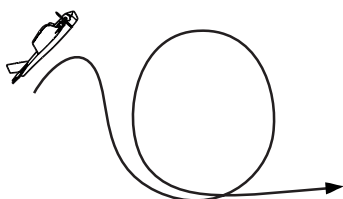

B.

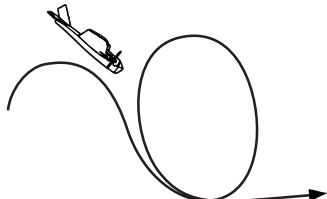

C.

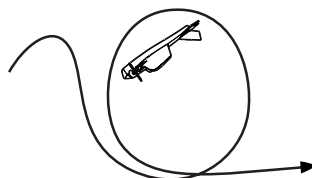

D.

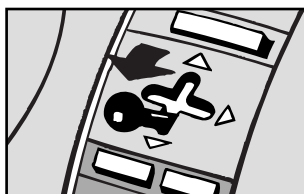
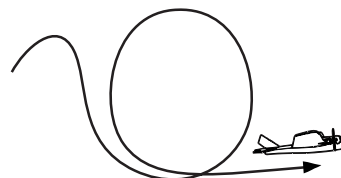

Toggle BACK briefly.

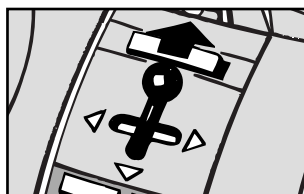

Toggle FORWARD.

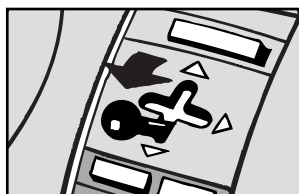

As soon as the plane dives down, pull the TOGGLE BACK and HOLD that position to complete the loop.



After the loop is completed, return TOGGLE to NEUTRAL position to level off.

STEP 5 – STUNTS continued

2. SIDEWINDER

MINIMUM ALTITUDE 30 Feet

A.

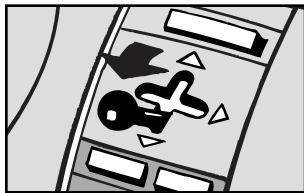
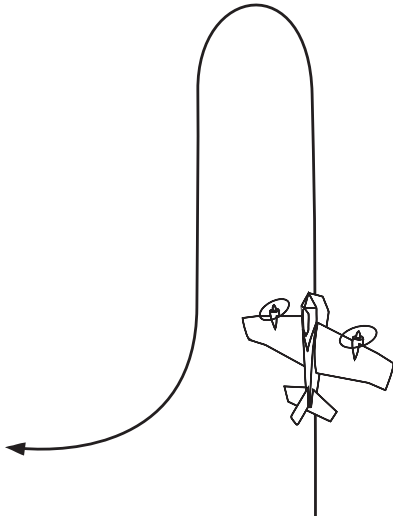

TOGGLE BACK to climb.

B.

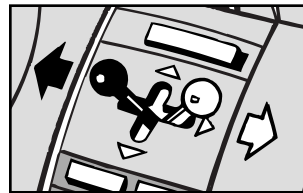
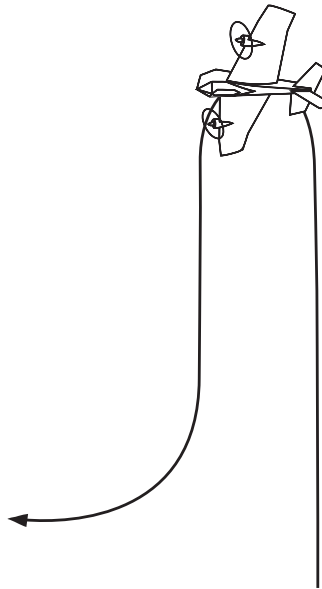

When the plane reaches a vertical position TOGGLE – LEFT to complete a LEFT SIDEWINDER. To complete a RIGHT SIDEWINDER, TOGGLE – RIGHT when the plane reaches a vertical position.

C.

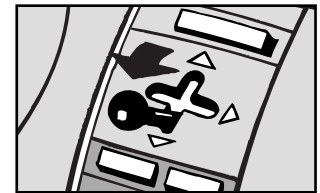
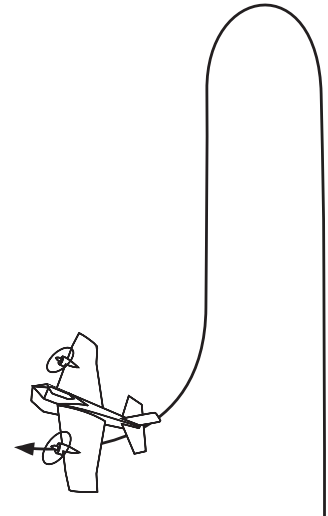

TOGGLE back to pull out of dive then return to NEUTRAL to level off.

REMEMBER:

When you are finished flying your SKYWINDER™, turn the plane's ON/OFF SWITCH to "OFF" and the CONTROLLER'S ON/OFF SWITCH to "OFF".

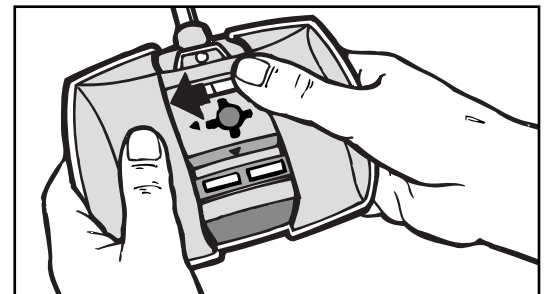
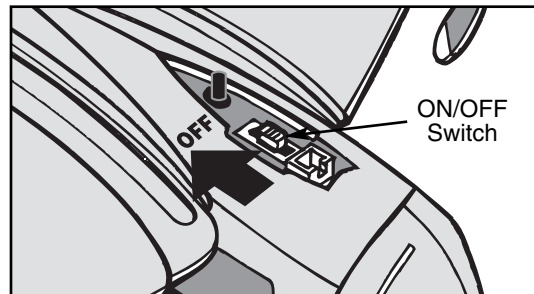

IMPORTANT INFORMATION – ADULT SUPERVISION IS RECOMMENDED

Keep propellers away from face, eyes, hair, and fingers. Point plane away from face when launching. Do NOT launch at people or animals. Use caution; make sure people around you know you are playing with Air Hogs™. **Recommended for use in wide-open, grassy areas. Do NOT fly near overhead wires, trees, buildings, or other obstructions.** Do NOT fly in rain, electrical storms, snow, or other adverse weather conditions. Fly on warm sunny days, with no wind. Do NOT fly in temperatures below 45°F/7°C. Use alkaline batteries only. Use only the charger and controller included in this package. Please retain this information for future reference.

CHANGING PROPELLERS ON YOUR SKYWINDER™

In case of propeller damage, please use the steps below to replace the damaged propeller:

1. With one hand, grab hold of the PROPELLER.
2. While holding the PROPELLER in place, use your opposite hand to unscrew the removeable PROPELLER TIP with the PROPELLER REPLACEMENT TOOL.
3. After removing the PROPELLER TIP, pull the damaged PROPELLER from the shaft and replace with a new propeller.
4. While holding the propeller in place, replace the PROPELLER TIP by screwing it back onto the shaft of the PROPELLER with the PROPELLER REPLACEMENT TOOL.

CAUTION: The damaged propeller may have sharp edges, use caution when handling the damaged PROPELLER, and dispose of it properly.

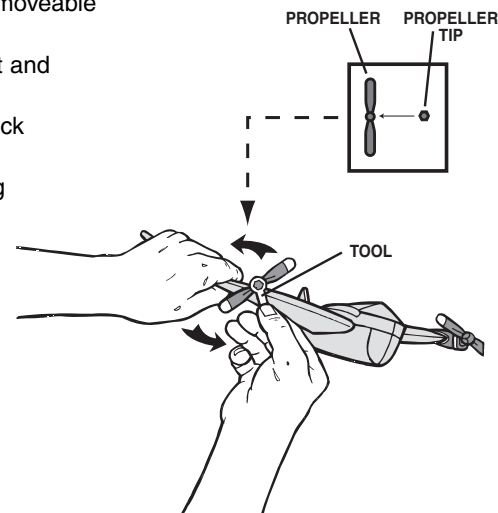
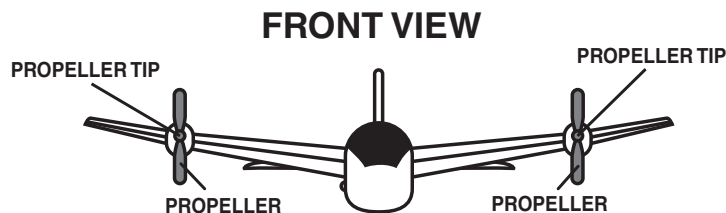

TROUBLE-SHOOTING GUIDE

PROBLEM	CAUSE	SOLUTION
Plane will not loop.	1. Not enough charge.	1. Repeat the charging process. Refer to the "Charging your SkyWinder™" section on Page 2.
	2. STUNT FLAP is not in the correct position.	2. Adjust STUNT FLAP so that it is level with the HORIZONTAL TAIL WING.
	3. Winds are too strong.	3. Fly in conditions with little or no wind for best performance.
	4. Improper technique.	4 A. LOOPING TAKES TIME AND PRACTICE! Pilots should master directional control on their TRAINER first. Once pilots are comfortable with their technique, they should then practice flying outdoors. B. ENSURE: (1) the minimum altitude is reached before attempting to loop and (2) the step-by-step toggle directions are followed (See Pages 5 and 6).
	5. Rudder Alignment is OFF.	5 A. If the plane rolls out to the RIGHT before fully completing loops – Bend the rudder slightly to the LEFT. B. If the plane rolls out to the LEFT before fully completing loops – Bend the rudder slightly to the RIGHT.
Plane crashes OR will NOT fly.	1. Not enough charge.	1. Repeat the charging process. Refer to the "Charging your SkyWinder™" section on Page 2.
	2. Plane misaligned OR damaged from previous flights.	2. Wings: <ul style="list-style-type: none"> • Use clear tape to repair wings. • Ensure that the HORIZONTAL TAIL WING is parallel to the MAIN WING. • Ensure that the VERTICAL TAIL WING is 90° with the MAIN WING. Propellers: <ul style="list-style-type: none"> • Ensure that both PROPELLERS can spin freely. Plane: <ul style="list-style-type: none"> • Ensure plane responds to control functions by turning the plane "ON" while holding it in your hand.
Plane not responding to controller OR plane responds to some other signal.	1. Interference from other radio transmission signals in the area.	1. Turn the plane "ON" and hold it in your hand. If the plane responds without you touching the controller, there is interference. DO NOT FLY. You SHOULD NOT fly the plane if it does not respond to your controller, or if it responds to something other than your controller. If the problem persists, it is recommended that you fly your plane in another area.

FCC REQUIREMENTS

CAUTION: Changes or modifications to this product not expressly approved by the party responsible for compliance may void the user's authority to operate the equipment.

WARRANTY (U.S.A.)

Spin Master Ltd. warrants to the original consumer purchaser, that this product is thoroughly tested and inspected before shipment and is guaranteed to be free of factory defects in materials and workmanship for ninety (90) days (unless specified in alternate warranties) from the date of purchase.

In the event of such a defect within the warranty period, Spin Master Ltd., at our sole option, will repair or replace the product or provide you with another product of equal value. Repair or replacement shipment is free of charge. Shipping replacement may take 2 to 6 weeks, depending on customer's location.

In the event of a defect covered under this warranty, please call the toll-free number listed below. Many problems can be solved in this manner. If necessary, you will be instructed to return the defective part or unit, packed securely, postage prepaid and insured by the customer, to the address below. Enclose your name, address, dated sales receipt, and a brief explanation of the defect. There may be an additional handling charge if you send the entire toy.

The warranty is valid if and only if the product has been operated in accordance with the instructions. This warranty does not cover worn or defective batteries, damage resulting from neglect, unauthorized modification, accident, misuse, abuse, any action or omission which constitutes a deviation from the instructions or from the use of accessories or parts not manufactured by Spin Master Ltd. If the product is returned without a dated sales receipt the product is excluded from coverage under this warranty.

Spin Master Ltd.'s liability for defects in material and workmanship under this warranty shall be limited to repair or replacement, at our sole option, and in no event shall we be responsible for accidental, consequential, or contingent damages (except in those states that do not allow this exclusion or limitation) or refunds. This warranty is exclusive, and is made in lieu of any express or implied warranty. This warranty is valid only for products sold in the U.S.A. This warranty gives you specific legal rights and you may have other rights, which vary from state to state. Some states do not allow the exclusion of incidental or consequential damages, so the above exclusions or limitations may not apply to you.

Spin Master Ltd. reserves the right to improve the design of any product without assuming any obligation to modify any product previously manufactured.

If you have a problem, please contact our Customer Care Centre below for help.

Spin Master Ltd., 450 Front Street West, Toronto, ON M5V 1B6 Canada
Spin Master, Inc., PMB #10053, 300 International Drive, Suite 100,
Williamsville, NY 14221
Spin Master Toys Far East Limited, Rm # 1113, 11/F, Chinachem Golden Plaza,
77 Mody Rd., Tsimshatsui E., Kowloon, HK
Spin Master France SAS, 36 rue de Silly, 92100 Boulogne, France

North American Consumer Information
Phone: 1-800-622-8339
www.spinmaster.com

Air Hogs TM and SkyWinder TM are trademarks of Spin Master Ltd.
© 2003 Spin Master Ltd. All rights reserved.
Manufactured for and distributed by Spin Master Ltd.
Conforms to safety standards ASTM F963-03,
EN71 Regulatory Requirements. Products and colors may vary.
Please retain this information for future reference.
MADE IN CHINA.

REV 6 US ENG Asst. #44000.

Download from Www.Somanuals.com. All Manuals Search And Download.



Free Manuals Download Website

<http://myh66.com>

<http://usermanuals.us>

<http://www.somanuals.com>

<http://www.4manuals.cc>

<http://www.manual-lib.com>

<http://www.404manual.com>

<http://www.luxmanual.com>

<http://aubethermostatmanual.com>

Golf course search by state

<http://golfingnear.com>

Email search by domain

<http://emailbydomain.com>

Auto manuals search

<http://auto.somanuals.com>

TV manuals search

<http://tv.somanuals.com>