



## **Phone User Guide**

**PowerSource™ Phone  
Motorola Deluxe™ ic902**

**[www.sprint.com](http://www.sprint.com)**

© 2007 Sprint Nextel. All rights reserved. SPRINT, the NEXTEL name and logo, and other trademarks are trademarks of Sprint Nextel.

Printed in the U.S.A.

Motorola, Inc.  
Consumer Advocacy Office  
1307 East Algonquin Road  
Schaumburg, IL 60196

[www.hellomoto.com](http://www.hellomoto.com)

1-800-331-6456 (United States)

1-888-390-6456 (TTY/TDD United States for hearing impaired)

1-800-461-4575 (Canada)

Product Support:

[www.motorola.com/iden/support](http://www.motorola.com/iden/support)

Certain mobile phone features are dependent on the capabilities and settings of your service provider's network. Additionally, certain features may not be activated by your service provider, and/or the provider's network settings may limit the feature's functionality. Always contact your service provider about feature availability and functionality. All features, functionality, and other product specifications, as well as the information contained in this user's guide are based upon the latest available information and are believed to be accurate at the time of printing. Motorola reserves the right to change or modify any information or specifications without notice or obligation.

© Motorola, Inc., 2007. MOTOROLA and the Stylized M Logo are registered in the US Patent & Trademark Office. All other product or service names are the property of their respective owners.

### **Software Copyright Notice**

The Motorola products described in this manual may include copyrighted Motorola and third-party software stored in semiconductor memories or other media. Laws in the United States and other countries preserve for Motorola and third-party software providers certain exclusive rights for copyrighted software, such as the exclusive rights to distribute or reproduce the copyrighted software. Accordingly, any copyrighted software contained in the Motorola products may not be modified, reverse-engineered, distributed, or reproduced in any manner to the extent allowed by law. Furthermore, the purchase of the Motorola products shall not be deemed to grant either directly or by implication, estoppel, or otherwise, any license under the copyrights, patents, or patent applications of Motorola or any third-party software provider, except for the normal, non-exclusive, royalty-free license to use that arises by operation of law in the sale of a product.

Manual number: NNTN7130A

Software Versions: DBACK2\_02.46.00R; BB0.01.02

USR Version: 67.00/19.00

CP Version: 00A.00.00

# Table of Contents

---

<b>Welcome to Sprint</b> .....	<b>i</b>
<b>Introduction</b> .....	<b>ii</b>
<b>Your Phone's Menu</b> .....	<b>iv</b>
<b>Section 1: Getting Started</b> .....	<b>1</b>
<b>1A. Setting Up Service</b> .....	<b>2</b>
Getting Started .....	3
Setting Up Your Voicemail .....	4
Account Passwords .....	5
Getting Help .....	6
<b>1B. Your Phone: The Basics</b> .....	<b>8</b>
Your Motorola Deluxe ic902 Phone .....	9
Getting Started With Your Phone .....	15
Finding Your Phone Number and Walkie-Talkie Number .....	23
Basic Phone Features .....	24
Accessories .....	30
Entering Text .....	31
<b>Section 2: Using Your Phone</b> .....	<b>35</b>
<b>2A. Making and Answering Calls</b> .....	<b>36</b>
Types of Calls .....	37
Making and Answering Phone Calls .....	38
Making and Answering Nextel Walkie-Talkie Calls .....	48
Making and Answering Talkgroup Calls .....	57
Making and Answering Nextel Direct Talk Calls .....	60
Using Call Alerts .....	66
Keeping Track .....	68
<b>2B. Controlling Your Phone's Settings</b> .....	<b>71</b>
Sound Settings .....	72
Display Settings .....	75
Location Settings .....	79
Messaging Settings .....	80

Airplane Mode .....	84
TTY Use .....	85
Phone Setup Options .....	86
Nextel Walkie-Talkie Settings .....	90
<b>2C. Setting Your Phone's Security .....</b>	<b>92</b>
Accessing Your Security Menu .....	93
SIM Card Security .....	93
Using Your Phone's Lock Feature .....	96
Limiting Use of Your Phone .....	98
Erasing Data .....	102
Resetting Your Phone .....	102
Security Features for Sprint Power Vision .....	103
<b>2D. Controlling Your Roaming Experience .....</b>	<b>105</b>
Understanding Roaming .....	106
Setting Your Phone's Roam Mode .....	108
Alerting Yourself to Roaming .....	109
Using Data Roam Guard .....	110
<b>2E. Managing Call History .....</b>	<b>111</b>
Viewing Call History .....	112
Phone Call History Options .....	115
Walkie-Talkie Call History Options .....	117
Erasing Call History .....	119
<b>2F. Using Contacts .....</b>	<b>120</b>
About Contacts .....	121
Finding Contacts Entries .....	122
Creating a Contacts Entry .....	125
Contacts Entries for Walkie-Talkie Groups and Talkgroups ..	129
Managing Your Contacts .....	132
Using Your SIM Manager .....	133
Dialing Sprint Services .....	136
Using Wireless Backup .....	137
<b>2G. Using the Phone's Tools .....</b>	<b>139</b>
Using Your Phone's Calendar .....	140

Using the Alarm Clock .....	143
Using the Calculator .....	144
Using the World Clock .....	144
Using the Stop Watch .....	145
Using the Notepad .....	145
Using the Tip Calculator .....	146
Using the Currency Converter .....	147
Using the Unit Converter .....	148
Using Voice Records .....	149
Using the File Manager .....	151
<b>2H. Using Your Phone's Voice Services .....</b>	<b>157</b>
Voice Recognition — Dialing & Messaging .....	158
Setting Up Voice Recognition .....	162
Working With Voice Recognition .....	166
<b>2I. Using the microSD Card .....</b>	<b>168</b>
Using Your Phone's microSD Card and Adapter .....	169
Working With the microSD Card .....	176
<b>2J. Using the Built-in Camera .....</b>	<b>177</b>
Taking Pictures .....	178
Storing Pictures .....	182
Shooting Videos .....	185
Storing Your Videos .....	188
Sending Pictures and Videos .....	189
Using Sprint Picture Mail .....	192
<b>2K. Using the Built-in Media Player .....</b>	<b>196</b>
Your Multimedia Channel Options .....	197
Accessing Media Player's Channel Listings .....	198
Playing a Video or Audio Clip .....	199
Multimedia FAQs .....	200
<b>2L. Using Bluetooth .....</b>	<b>203</b>
Turning Bluetooth On and Off .....	204
Setting Up Your Bluetooth .....	205
Transferring Files Between Your Phone and Your PC .....	208

Bluetooth Profiles .....	209
<b>Section 3: Service Features .....</b>	<b>211</b>
<b>3A. Sprint Service Features: The Basics .....</b>	<b>212</b>
Using Voicemail .....	213
Using SMS Text Messaging .....	219
Using SMS Voice Messaging .....	221
Using Caller ID .....	224
Responding to Call Waiting .....	224
Making a Three-Way Call .....	225
Using Call Forwarding .....	226
Updating Phone Software .....	227
<b>3B. Sprint Voice Command .....</b>	<b>228</b>
Getting Started With Sprint Voice Command .....	229
Creating Your Own Address Book .....	230
Making a Call With Sprint Voice Command .....	231
Getting Information With Sprint Voice Command .....	232
<b>Section 4: Safety and Warranty Information .....</b>	<b>233</b>
<b>4A. Important Safety Information .....</b>	<b>234</b>
General Precautions .....	235
Safety and General Information .....	236
Using Your Phone With a Hearing Aid .....	246
Battery Tips .....	248
Specific Absorption Rate Data .....	249
Information From the World Health Organization .....	251
Product Registration .....	251
Owner's Record .....	252
Phone Guide Proprietary Notice .....	252
Export Law Assurances .....	252
Wireless: The New Recyclable .....	253
Smart Practices While Driving .....	254
Declaration of Conformity .....	256
California Perchlorate Label .....	258
Privacy and Data Security .....	259

<b>4B. Manufacturer's Warranty</b> .....	<b>261</b>
Motorola Limited Warranty for the United States and Canada .....	262
Service and Repairs .....	267
<b>Index</b> .....	<b>268</b>





# Welcome to Sprint

---

## **The Power To Do More.**

Sprint and Nextel have come together offering you more choice and flexibility to do whatever you want, just about whenever you want.

You can make both wireless phone calls on the Nationwide Sprint PCS Network and Nextel Walkie-Talkie calls on the Nextel National Network from the same phone, simplifying your calling experience while expanding the number of persons you can connect to. This combination gives you more of what you need to do more of what you want.

With Sprint, the power is back in your hands, where it belongs. Sprint. Power Up.

**Welcome and thank you for choosing Sprint.**

# Introduction

---

This **Phone Guide** introduces you to Sprint service and the features of your new phone. It's divided into four sections:

- ◆ **Section 1: Getting Started**
- ◆ **Section 2: Using Your Phone**
- ◆ **Section 3: Service Features**
- ◆ **Section 4: Safety and Warranty Information**

Throughout this guide, you'll find tips that highlight special shortcuts and timely reminders to help you make the most of your new phone and service. The Table of Contents and Index also help you quickly locate specific information.

You'll get the most out of your phone if you read each section. However, if you'd like to get right to a specific feature, simply locate that section in the Table of Contents and go directly to that page. Follow the instructions in that section, and you'll be ready to use your phone in no time.

**Phone  
Guide  
Note:**

Due to updates in phone software, this printed guide may not be the most current version for your phone. Visit [www.sprint.com](http://www.sprint.com) and sign on to access the most recent version of the phone guide.

**WARNING**

Please refer to the **Important Safety Information** section on page 234 to learn about information that helps you safely use your phone. Failure to read and follow the Important Safety Information in this phone guide may result in serious bodily injury, death, or property damage.

# WANT TO KEEP TRACK OF YOUR MINUTES?

## IT'S EASY TO CHECK RIGHT FROM YOUR PHONE!

DIAL \* 4 

You'll hear a summary of your service plan minutes and the minutes remaining in your current billing cycle, along with your phone's individual usage if you're on a shared plan. You'll also hear a summary of your account balance and your most recent payment information.

## USE YOUR PHONE'S WEB BROWSER

From the Sprint Power Vision home page, select My Account (Option 0). You'll see many helpful categories including Payment Due, Current Usage, and Plan Overview. Select a topic to display the latest information.

---

### NOTE

---

Reported minutes and balances are estimates only. Please consult your Sprint Invoice for actual minutes used.

---

# Your Phone's Menu

---

The following list outlines your phone's menu structure. For more information about navigating through the menus, please see "Navigating Through Phone Menus and Options" on page 28.

## MISSED ALERTS

## CALL HISTORY

## CONTACTS

### 1: VIEW ALL

### 2: ADD NEW

- |                      |                        |              |
|----------------------|------------------------|--------------|
| 1: Contact           | 2: Walkie-Talkie Group | 3: Talkgroup |
| 4: Distribution List | 5: Category            |              |

### 3: FILTER BY

### 4: SPEED DIAL #S

### 5: MY BUSINESS CARD

### 6: SERVICES

- |                       |                  |                    |
|-----------------------|------------------|--------------------|
| 1: Customer Solutions | 2: Account Info  | 3: Dir. Assistance |
| 4: Sprint Operator    | 5: Voice Command |                    |

### 7: MANAGE CATEGORIES

- |            |           |            |
|------------|-----------|------------|
| 1: General | 2: Family | 3: Friends |
| 4: Work    |           |            |

### 8: MEMORY STATUS

### 9: SIM MANAGER

- |                     |                |               |
|---------------------|----------------|---------------|
| 1: Copy to Contacts | 2: Copy to SIM | 3: Manage SIM |
| 4: Help             |                |               |

### 10: WIRELESS BACKUP

- |              |                  |               |
|--------------|------------------|---------------|
| 1: Subscribe | 2: Alert: OFF/ON | 3: Learn More |
|--------------|------------------|---------------|

## MESSAGING

### 1: SEND MESSAGE

- 1: Text Message      2: Picture Mail      3: Voice SMS

### 2: TEXT MESSAGING

- 1: Inbox                      2: Outbox                      3: Sent Folder  
4: Drafts Folder            5: Preset Messages        6: Send Message

### 3: PICTURE MAIL

- 1: Inbox                      2: Sent Mail                      3: Saved Mail  
4: Pending Messages      5: Send Message

### 4: PREMIUM CONTENT

### 5: VOICE SMS

- 1: Inbox                      2: Outbox                      3: Send Message

### 6: IM & EMAIL

- 1: PCS Mail                      2: AOL                      3: MSN  
4: Yahoo!                      5: Other

### 7: CHAT & DATING

### 8: VOICEMAIL

- 1: Call Voicemail            2: View Details            3: Clear Icon

### 9: SETTINGS

- 1: Text Messaging            2: Voice SMS                      3: Picture Mail  
4: Notification

## WALKIE-TALKIE

### 1: W-T CONTACTS

### 2: DIRECT TALK

### 3: SETTINGS

- 1: One Touch W-T            2: Talkgroup Silent            3: Talkgroup Area

## ON DEMAND

## PICTURES

### 1: CAMERA

### 2: CAMCORDER

<b>3: PICTURE MAIL</b>		
1: Inbox 4: Pending Messages	2: Sent Mail 5: Send Message	3: Saved Mail
<b>3: MY ALBUMS</b>		
1: In Phone	2: Memory Card	3. OnLine Albums
<b>4: PRINT</b>		
<b>6: MEMORY MANAGER</b>		
<b>7: ACCOUNT INFORMATION</b>		
<b>8: SETTINGS</b>		
1: Storage Location	2: Statusbar Display	3: Auto Erase Media After Upload
<b>MY CONTENT</b>		
<b>1: GAMES</b>		
1: Get New	2: My Content Manager	
<b>2: THEMES</b>		
1: Get New 4. Sprint	2: My Content Manager	3. Moto
<b>3: RINGERS</b>		
1: Get New	2: My Content Manage	
<b>4: SCREEN SAVERS</b>		
1: Get New	2: My Content Manager	
<b>5: APPLICATIONS</b>		
1: Get New	2: My Content Manager	
<b>6: IM &amp; EMAIL</b>		
1: Get New	2: My Content Manager	
<b>7: CALL TONES</b>		
<b>MUSIC</b>		
<b>MEDIA PLAYER</b>		
<b>1: CHANNEL LISTING</b>		
<b>2: EXTERNAL MEMORY</b>		
<b>WEB</b>		

## SETTINGS/TOOLS

### 1: SETTINGS

#### 1: Sounds

##### 1: Ringer Type

- |           |               |                |
|-----------|---------------|----------------|
| 1: Ringer | 2: Messaging  | 3: Calendar    |
| 4: Alarm  | 5: Call Alert | 6: Roam Ringer |

##### 2: Volume

- |             |              |                  |
|-------------|--------------|------------------|
| 1: Ringer   | 2: Messaging | 3: Alarm         |
| 4: Key Beep | 5: Advanced  | 6: Reset Volumes |

##### 3: Indicators

- |            |                |              |
|------------|----------------|--------------|
| 1: Service | 2: Minute Beep | 3: Call Lost |
| 4: Connect | 5: New Message |              |

#### 4: Key Tone Length

#### 2: Display

##### 1: Screensaver

- |                   |                     |                    |
|-------------------|---------------------|--------------------|
| 1: None           | 2: In Phone         | 3: External Memory |
| 4: Assigned Media | 5: Take New Picture |                    |

##### 2: Themes

##### 3: Foregrounds

- |          |                           |                    |
|----------|---------------------------|--------------------|
| 1: Clock | 2: Navigation Key Display | 3: Greeting Banner |
|----------|---------------------------|--------------------|

##### 4: Light Control

- |                             |                        |
|-----------------------------|------------------------|
| 1: Screen Backlight Control | 2: Keypad Light Sensor |
| 3: Walkie Talkie Button     | 4: Status Indicator    |

##### 5: Menu Style

##### 6: Assign Keys

- |          |                  |         |
|----------|------------------|---------|
| 1: Up    | 2: Down          | 3: Left |
| 4: Right | 5: Walkie Talkie |         |

##### 7: Time and Date

- |                |                |
|----------------|----------------|
| 1: Time Format | 2: Date Format |
|----------------|----------------|

##### 8: Incoming Calls

- |                 |                    |
|-----------------|--------------------|
| 1: Call with ID | 2: Call without ID |
|-----------------|--------------------|

#### 3: Walkie Talkie

- |                   |                     |
|-------------------|---------------------|
| 1: One Touch W-T  | 2: Talkgroup Silent |
| 3: Talkgroup Area |                     |

#### 4: KeyGuard

- |                  |
|------------------|
| 1: Auto KeyGuard |
|------------------|

<b>5: Data Services</b>		
1: Data Services	2: Net Guard	3: Data Services Profile
<b>6: Roaming</b>		
1: Set Mode	2: Call Guard	3: Data Roam Guard
<b>7: Location</b>		
<b>8: Security</b>		
<b>1: Lock Phone</b>		
<b>2: Lock Code</b>		
<b>3: SIM PIN</b>		
<b>4: SIM PIN Code</b>		
<b>5: Special Numbers</b>		
1: Special Number 1	2: Special Number 2	3: Special Number 3
<b>6: Limit Use</b>		
1: Contacts	2: Data Services	3: Pictures
4: Restrict Outgoing Calls	5: Restrict Incoming Calls	6: Restrict W-T Calls
<b>7: Manage Applications</b>		
1: Contacts	2: My Content	3: Voice Records
4: Pictures	5: Messages	
<b>8: Reset Settings</b>		
1: Browser	2: Favorites	3: Personal Dictionary
4: All Settings	5: Walkie-Talkie Service	6: Phone Reset
<b>9: External Memory</b>		
<b>9: Others</b>		
<b>1: Airplane Mode</b>		
<b>2: Call Setup</b>		
1: Abbreviated Dial	2: Answer Options	3: Auto Answer
4: Auto Redial	5: Speed Dial	
<b>3: Connection</b>		
1: Bluetooth Settings	2: USB Settings	
<b>4: Headset Mode</b>		
<b>5: Language</b>		
<b>6: Phone Book Match</b>		
<b>7: Text Input</b>		
1: Personal Dictionary	2: Word Completion	3: Auto Space
<b>8: TTY</b>		



<b>9: Voice Guide</b>		
<b>10: Wireless Backup</b>		
1: Subscribe	2: Alert: ON/OFF	3: Learn More
<b>10: Phone Info</b>		
1: My Phone Numbers 4: Advanced	2: Icon Glossary 5: Phone Software	3: Version
<b>2: TOOLS</b>		
<b>1: Bluetooth</b>		
<b>1: Trusted Devices</b>		
1: Add New	2: Find Me	
<b>2: Calendar</b>		
<b>3: Alarm Clock</b>		
1: Add New Alarm		
<b>4: Calculator</b>		
<b>5: Tip Calculator</b>		
<b>6: World Clock</b>		
<b>7: Stop Watch</b>		
<b>8: Currency Converter</b>		
<b>9: Unit Converter</b>		
1: Area 4: Length 7: Speed	2: Energy 5: Mass 8: Temperature	3: Force 6: Power 9: Volume
<b>10: Notepad</b>		
1: Add New Note		
<b>11: Voice Records</b>		
<b>12: File Manager</b>		
<b>1: Pictures</b>		
1: In Phone	2: External Memory	3: Assigned Media
<b>2: Sounds</b>		
1: In Phone	2: External Memory	3: Assigned Media
<b>3: External Memory</b>		
1: DCIM	2: MEDIA	3: (additional folders)
<b>4: Memory Usage</b>		

### **13: SIM Manager**

1: Copy to Contacts  
4: Help

2: Copy to SIM

3: Manage SIM

**Section 1**

# **Getting Started**



# Setting Up Service

---

## In This Section

---

- ◆ Getting Started
  - ◆ Setting Up Your Voicemail
  - ◆ Account Passwords
  - ◆ Getting Help
- 

**Setting up service on your new phone is quick and easy.** This section walks you through the necessary steps to unlock your phone, set up your voicemail, establish passwords, and contact Sprint for assistance with your wireless service.

# Getting Started

## Determining If Your Phone Is Already Activated

If you purchased your phone at a Sprint Store, it is probably ready to use. If you received your phone in the mail, it probably has been activated; all you need to do is unlock it. If your phone is not activated, please use another phone to call Sprint Customer Service at 1-888-211-4727.

**Tip:** You must be in an area covered by the Nationwide Sprint PCS Network and the Nextel National Network when you first power up and unlock your phone.

## Unlocking Your Phone

To unlock your phone, follow these easy steps:

1. Press and hold  to turn the phone on.
2. Press **Unlock** (right softkey).

**Note:** To select a softkey, press the button directly below the text appearing on the bottom left and right of your display screen. Softkey actions change according to screen.

3. Enter your four-digit lock code.

**Tip:** If you can't recall your lock code, try using the last four digits of your wireless phone number. If this doesn't work, call Sprint Customer Service.



When you power up your phone the first time, it performs a series of security checks. For example, it verifies the phone is Sprint-approved and the correct SIM card is installed. If you don't pass the security checks, your phone displays messages and screen prompts showing what to do next. If you still encounter security messages, call Sprint Customer Service.

# Setting Up Your Voicemail

---

Unanswered phone calls are automatically transferred to your voicemail, even if your phone is in use or turned off. Therefore, you may want to set up your voicemail and personal greeting as soon as your phone is activated.

## To set up your voicemail:

1. From standby mode, press and hold .
2. Follow the system prompts to:
  - Create your passcode.
  - Record your name announcement.
  - Record your greeting.
  - Choose whether to activate One-Touch Message Access (a feature that lets you access messages simply by pressing and holding , bypassing the need for you to enter your passcode).

**Note:****Voicemail Passcode**

If you are concerned about unauthorized access to your voicemail account, Sprint recommends that you enable your voicemail passcode.

For more information about using your voicemail, see “Using Voicemail” on page 213.

# Account Passwords

---

As a Sprint customer, you enjoy unlimited access to your personal account information, your voicemail account, and your data services account. To ensure that no one else has access to your information, you need to create passwords to protect your privacy.

## Account Password

If you are the account owner, you have an account password to sign on to [www.sprint.com](http://www.sprint.com) and to use when calling Sprint Customer Service. Your default account password is the last four digits of your Social Security number or the password you selected when you purchased your phone. If you are not the account owner (if someone else receives the invoice for your Sprint service), you can get a sub-account password at [www.sprint.com](http://www.sprint.com).

## Voicemail Password

You create your voicemail password (or passcode) when you set up your voicemail. See “Setting Up Your Voicemail” on page 4 for more information on your voicemail password.

## Data Services Password

With your Motorola Deluxe ic902 phone, you may elect to set up a data services password. This optional password may be used to authorize purchase of Premium Services content and to protect personal information on multi-phone accounts.

For more information, or to change your passwords, sign on to [www.sprint.com](http://www.sprint.com) or call Sprint Customer Service at **1-888-211-4727**.

# Getting Help

---



## Visit [www.sprint.com](http://www.sprint.com)

You can go online to:

- Access your account information.
- Check your minutes used (depending on your service plan).
- View and pay your bill.
- Enroll for online billing and automatic payment.
- Purchase accessories.
- Shop for the latest phones.
- View other service plans and options available.
- Learn more about data services and other great products like games, ringers, screen savers, and more.

## Reaching Sprint Customer Service

You can reach Sprint Customer Service many different ways:

- Dial    on your phone.
- Sign on to your account at [www.sprint.com](http://www.sprint.com).
- Call us toll-free at 1-888-211-4727.

## Receiving Automated Invoicing Information

For your convenience, your phone gives you access to invoicing information on your account. This information includes balance due, payment received, invoicing cycle, and an estimate of the number of minutes used since your last invoicing cycle.

To access automated invoicing information:

- ▶ Press   .



**Note:** This service may not be available in all Affiliate areas.

## Sprint 411

You have access to a variety of services and information through Sprint 411, including residential, business, and government listings; movie listings or show times; driving directions, restaurant reservations, and major local event information. You can get up to three pieces of information per call, and the operator can automatically connect your call at no additional charge.

There is a per-call charge to use Sprint 411 and you are billed for airtime.

### To call Sprint 411:

▶ Press    .

## Operator Services

Operator Services provides assistance when placing collect calls or when placing calls billed to a local telephone calling card or to a third party.

### To access Operator Services:

▶ Press  .

For more information or to see the latest products and services, visit us online at [www.sprint.com](http://www.sprint.com).

# Your Phone: The Basics

---

## In This Section

---

- ◆ **Your Motorola Deluxe ic902 Phone**
  - ◆ **Getting Started With Your Phone**
  - ◆ **Finding Your Phone Number and Walkie-Talkie Number**
  - ◆ **Basic Phone Features**
  - ◆ **Accessories**
  - ◆ **Entering Text**
- 

**Your phone is packed with features that simplify your life and expand your ability to stay connected to the people and information that are important to you.** This section gives you an overview of your phone, describes its basic features, shows you how to power it on and off, charge your battery, and insert your SIM card.

# Your Motorola Deluxe ic902 Phone

## Front View of Your Phone

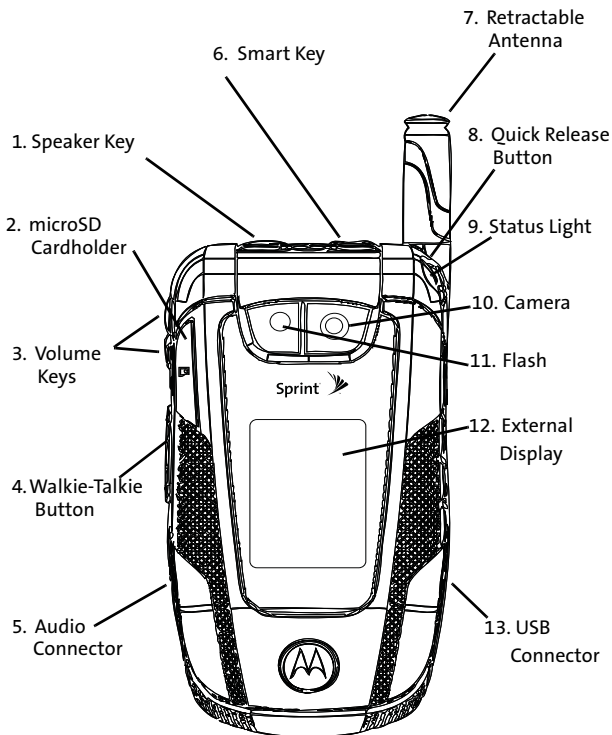

## Inside View of Your Phone

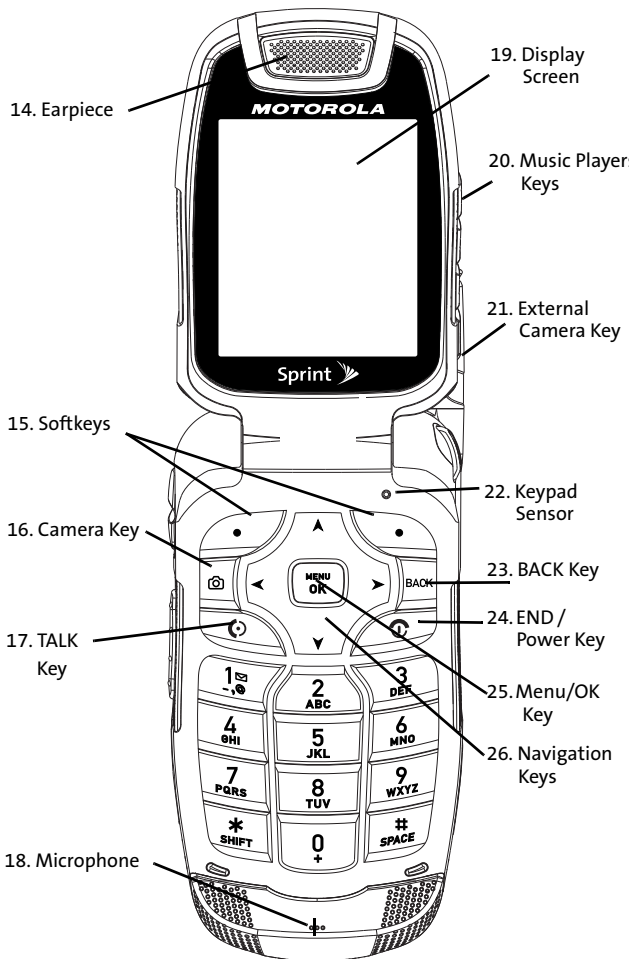

## Key Functions



1. **Speaker Key** turns the speakerphone on and off during phone calls and Nextel Walkie-Talkie calls. You can also use it to answer phone calls in speaker mode. When the phone is closed, it can be used with the Smart Key to make a phone call from the Call History list.
2. **microSD Cardholder** holds a microSD memory card. Inserting a microSD card here expands your phone's available memory and allows you to easily store images, videos, music, and voice data in your phone. See "Using the microSD Card" on page 168.
3. **Volume Keys** allow you to adjust the ringer volume in standby mode or adjust the voice volume during a call. You can use the Volume keys to scroll up or down the different menu options. To mute the ringer during an incoming call, press the volume key up or down.
4. **Walkie-Talkie Button** allows you to use your phone as a long-range, digital Walkie-Talkie.
5. **Audio Connector** allows you to plug in an optional headset for convenient, hands-free conversations. Your Walkie-Talkie headset can only use this connector.

**Note:**

The use of wireless phones while driving may cause distraction. Discontinue a call if you can't concentrate on driving. Additionally, the use of wireless devices and their accessories may be prohibited or restricted in certain areas. Always obey the laws and regulations on the use of these products.

6. **Smart Key** ends a phone call or Walkie-Talkie call, forwards an incoming call to voicemail, and dismisses a Call Alert. In standby mode, it accesses Call History when the phone is closed.
7. **Retractable Antenna** can be extended to optimize your phone's performance during phone calls, Walkie-Talkie calls, and data sessions.
8. **Quick Release Button** opens your phone when pressed.
9. **Status Light** does the following:
  - Flashes green to indicate your battery is charging.
  - Flashes red to indicate your battery is low.
  - Flashes red and green to indicate you have an incoming call.
  - Flashes orange and green to indicate you have received a message or Call Alert, or that an alarm has expired.
10. **Camera** allows you to take sharp, high-resolution digital pictures.
11. **Flash** helps illuminate the pictures you take with your phone's camera.
12. **External Display Screen** provides all the information you need to operate your phone, such as incoming call notification, Contacts, date and time, signal coverage, battery strength, and much more when your phone is closed.
13. **USB Connector** allows you to attach the battery charger or other accessories to your phone.
14. **Earpiece** lets you hear the caller and automated phone prompts.
15. **Softkeys** let you select softkey actions or menu items appearing on the bottom left and right of the display screen.

16. **Camera Key** activates your phone's camera mode and allows you to take sharp, high-resolution digital pictures.
17. **TALK Key** allows you to place or receive phone calls, answer Call Waiting, and use Three-Way Calling.
18. **Microphone** allows the other caller to hear you clearly when you are speaking to them.
19. **Display Screen** provides all the information you need to operate your phone, such as incoming call notification, Contacts, date and time, signal coverage, battery strength, and much more.
20. **Music Player Keys** allow you to control the music playing through the Sprint Music Store when the phone is closed. After you begin playing music through the Sprint Music Store, if you close your phone, you can use these keys as follows:
  - Press the center key to pause or unpause music playback.
  - Press the right-arrow key to skip to the next song. Press and hold the right-arrow key to rewind.
  - Press the left-arrow key to skip to the previous song. Press and hold the left-arrow key to fast-forward.
21. **External Camera Key** activates your phone's camera mode and allows you to take sharp, high-resolution digital pictures.
22. **Keypad Sensor** detects ambient light. If Keypad Sensor is enabled, your phone measures the available light and determines whether the keypad backlight needs to be turned on.
23. **BACK Key** deletes characters from the display screen in text entry mode. When in a menu, press  to return to the previous menu. This key also allows you to return to the previous screen during a data session.

24. **END/Power Key** ends a call. Press and hold  for two seconds to turn your phone on or off. While in the main menu, it returns the phone to standby mode and cancels your input. When you receive an incoming call, press  to mute the ringer.
25. **Menu / OK Key** selects the highlighted choice when navigating through a menu. From standby mode, pressing  takes you to the main menu.
26. **Navigation Keys** scroll through the phone's menu options and act as shortcut keys from standby mode. To assign shortcuts to the navigation keys, see "Shortcuts" on page 86.

## Antenna

To optimize your phone's performance, extend the antenna during phone calls, Nextel Walkie-Talkie calls, and data sessions.

To extend the antenna, pull gently on the rounded tip until the antenna is fully extended and clicks into position. When finished with a call, retract the antenna by pushing gently on the rounded tip until the antenna clicks into place.



# Getting Started With Your Phone

To start using your Motorola Deluxe ic902 phone:

- Make sure your SIM card is in place.
- Charge the battery.
- Turn on your phone.

After you've completed these items, you are ready to begin using your new phone.

## Locating Your SIM Card

Your SIM (Subscriber Identity Module) card is a small card with gold foil lodged within a larger card. This card is included in the shrink-wrap package that also contains the phone user guide and other documentation.

If no SIM card came with your phone, contact Sprint Customer Service at 1-888-211-4727.

### IMPORTANT

**You must use the SIM card that comes with your PowerSource phone.** If you have a black or yellow Nextel SIM card from a previous phone, you can transfer Contacts entries stored in the SIM card to your phone. See "Copying Contacts Entries – SIM Card to Phone" on page 135 for an explanation of how to do this.

After you begin using your phone with a SIM card, you cannot switch to a different SIM card with this phone. If you need to change SIM cards, contact Sprint Customer Service.

## Inserting Your SIM Card

To insert your SIM card:

1. Detach the SIM card from the larger card in which it is lodged.
2. With your phone powered off, remove the battery door and battery. See “Removing the Battery” on page 20.
3. With your fingers, carefully slide the SIM card in under the edge, and press it gently in place.

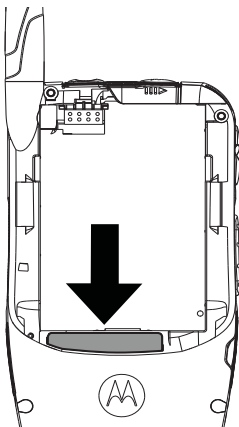

**Important:**

Do not touch the gold-colored areas of your SIM card.

## Removing Your SIM Card

**Important:** To avoid losing information stored in your SIM card, do not remove it from your phone unless absolutely necessary.

To remove your SIM card:

1. With your phone powered off, remove the battery door and battery. See “Removing the Battery” on page 20.
2. With your fingernail, carefully slide the SIM card out from under the edge.

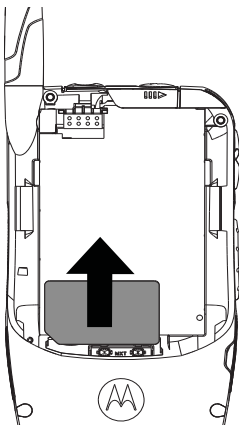

**Note:** Protect your SIM card as you would any delicate object. Store it carefully.

## Using Your Phone's Battery and Charger

**WARNING** Use only Sprint-approved or Motorola-approved batteries and chargers with your phone. The failure to use a Sprint-approved or Motorola-approved battery and charger may increase the risk that your phone overheats, catches fire, or explodes, resulting in serious bodily injury, death, or property damage.

Sprint-approved and Motorola-approved batteries and accessories can be found at Sprint Stores, through Motorola, or by calling 1-888-211-4727 to order. They're also available at [www.sprint.com](http://www.sprint.com) – just click the **Accessories** link.

### Battery Capacity

Your phone is equipped with a Lithium Ion (Li-Ion) battery. It allows you to recharge your battery before it is fully drained.

When the battery reaches 5% of its capacity, your phone makes a sound and displays a message. When there are approximately two minutes of talk time left, the phone sounds an audible alert and then powers down.

**Note:** Long light settings, searching for service, vibrate mode, browser use, and other variables may affect battery life.

**Tip:** Be sure to watch your phone's battery level indicator and charge the battery before it runs out of power.

## Installing the Battery

**Note:** Depending on the capacity of the battery, your battery and battery door may look slightly different than the illustrations shown in this user guide.

### To install your battery:

1. Make sure the phone is powered off.
2. Slide the release button to the side until it releases the battery door.
3. Allow the battery door to pop up, and remove it from the back of your phone.

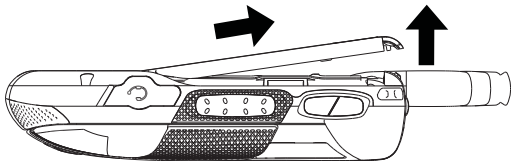

4. Insert the top of the battery into the battery area. Be sure the gold-colored areas on the battery and on the phone are touching.
5. Press the battery down to secure it.

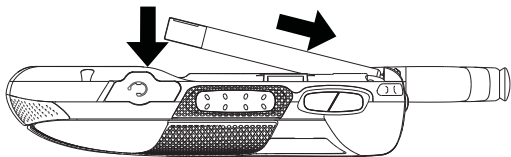

6. Replace the battery door and press it gently until you hear a click.

## Removing the Battery

**WARNING** Do not handle a damaged or leaking Li-Ion battery as you can be burned.

To remove your battery:

1. Make sure the phone is powered off.
2. Slide the release button back until the battery door unlatches.
3. Allow the battery door to pop up, and remove it from the back of your phone.

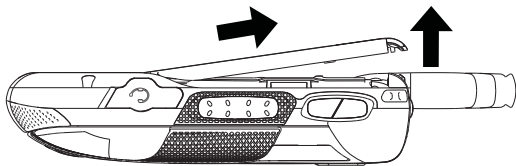

4. Remove the battery by lifting it out from the side.

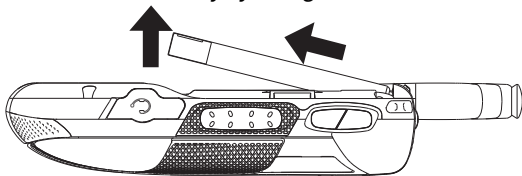

## Charging the Battery

Your phone's Li-Ion battery is rechargeable and should be charged as soon as possible so you can begin using your phone.

Keeping track of your battery's charge is important. If your battery level becomes too low, your phone automatically turns off, and you lose all the information you were just working on.

For a quick check of your phone's battery level, glance at the battery charge indicator located on your display screen. If the battery charge is getting too low, the phone makes a sound and displays a message.

Always use a Sprint-approved or Motorola-approved charger or vehicle power adapter to charge your battery.

## Using the Charger

To use the charger provided with your phone:

1. Plug the charger into an electrical outlet.
2. Pull and rotate the connector cover.

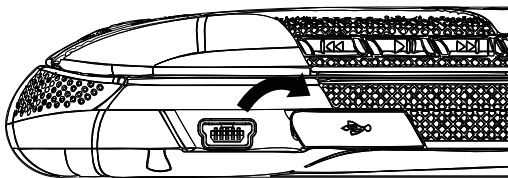

3. Plug the other end of the charger into the USB connector.

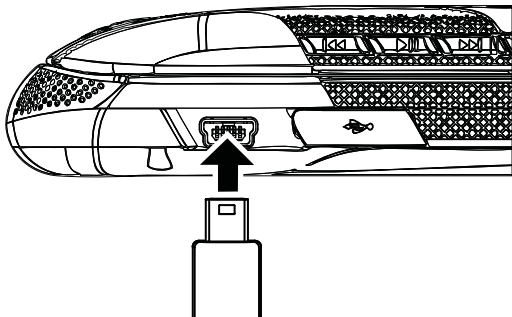

Your display screen lets you know the battery is charging. Both the battery icon  and a text message show the charging status.

**Tip:**

You can also charge your phone using a Motorola-approved USB cable and a computer that supports charging through its USB port. You can only use a Motorola-approved USB cable.

## Battery Use and Maintenance

- Sprint-approved Li-Ion chargers provide optimum performance. Other chargers may not charge the Li-Ion battery, only partially charge it, or may yield a reduced number of lifetime charge cycles
- Extreme temperatures degrade battery performance. Do not store the battery where temperatures exceed 140°F (60°C) or fall below -4°F (-20°C).
- Li-Ion batteries have a self-discharge rate and, without use, lose about 1% of their charge per day.



## Turning Your Phone On and Off

To turn your phone on:

1. Open the phone.
2. Press and hold  for approximately two seconds.

As your phone connects to the network, you see a connecting message. Your phone may require you to enter identifying information to use it or to access specific features. See “Setting Your Phone’s Security” on page 92 for more information.

To turn your phone off:

1. Open the phone.
2. Press and hold .

## Finding Your Phone Number and Walkie-Talkie Number

---

My Business Card lets you view your phone number, Walkie-Talkie number, and other information.

To view information about your phone:

1. Press  > **Contacts** > **My Business Card**.
2. Scroll to see your information:
  - **Mobile** lists your phone number.
  - **Walkie-Talkie** lists your Walkie-Talkie number.

To enter additional information, press **Edit** (left softkey). You can now enter your name, home and work numbers, and email, if you want. See “Entering Text” on page 31 for more instructions on how to do this.

# Basic Phone Features

---

Congratulations on purchasing your new Motorola Deluxe ic902 phone. Your phone is lightweight, durable, and easy-to-use. It offers many significant features and service options.

The following list previews some of those features and provides page numbers where you can find out more:

- Dual-mode capability allows you to make both Nextel Walkie-Talkie calls on the Nextel National Network and traditional wireless phone calls on the Nationwide Sprint PCS Network. Nextel Walkie-Talkie calls include Walkie-Talkie, Group Walkie-Talkie, Talkgroup, and Nextel Direct Talk<sup>SM</sup> calls (page 37).
- Walkie-Talkie button lights up whenever you receive a Walkie-Talkie call (page 50).
- SMS Text Messaging (page 219) and SMS Voice Messaging (page 221), provide quick and convenient messaging capabilities.
- Contacts stores Walkie-Talkie numbers, phone numbers, and other information in an easy-to-use, integrated format (page 120).
- A Calendar and many other built-in tools to help you manage your busy lifestyle (page 139).
- Your phone is equipped with a Location feature for use in connection with location-based services (page 79).
- Word English Text Input lets you quickly type messages with one key press per letter (page 32).
- Sprint Voice Command lets you dial phone numbers by saying a name or the digits of a phone number (page 228).
- Voice Records allows you to make recordings right on your phone (page 149).

- Speed dial lets you dial phone numbers with fewer key presses (page 47).
- Data Roam Guard will alert you when you are roaming and using your browser or other online applications, giving you the option to continue using those applications while in the roaming area (page 110).
- You can pair your Bluetooth-enabled phone to other Bluetooth devices, including headsets and handsfree devices (page 203). You may also pair with a personal computer or hand-held device for dial-up networking, using your phone as a wireless modem.
- The built-in camera allows you to take full-color digital pictures and videos, view your pictures and videos using the phone's display, and instantly share them with family and friends using Sprint Picture Mail service (page 177).
- The Media Player allows you to enjoy video clips and listen to audio files with your phone (page 196).

**Note:**

**Sprint Power Vision** — Your phone and service provide access to Sprint Power Vision enhanced data services, including Sprint TV<sup>SM</sup>, the Sprint Music Store<sup>SM</sup>, fast Web access, downloadable games, ringers, and applications, and more. For complete information on the services available, see the *Experience Sprint Power Vision* guide that came with your phone.

## Viewing Status Information

Your phone's display screen provides a wealth of information about your phone's status and options. This list identifies some of the symbols you'll see on your phone's display screen:

**Tip:**

To view a complete list of your phone's icons and descriptions, press  > **Settings/Tools** > **Settings** > **Phone Info** > **Icon Glossary**.



shows your current signal strength. (The more lines you have, the stronger your signal.)



means your phone cannot find a signal.



indicates battery charge level (icon shown is full).



indicates you are "roaming" off the Nationwide Sprint PCS Network.



indicates you have a new message (text message, SMS Voice message, or Picture Mail).



indicates you have voicemail messages. (Press and hold  to call your voicemail box.)



tells you a call is in progress.



indicates a missed phone call.



Sprint Vision connection/coverage indicator (1XRTT/CDMA Packet Data Service).















Sprint Power Vision connection/coverage indicator (EVDO).



indicates your phone is operating in TTY mode.



indicates a data cable is connected to your phone.

-  indicates your phone's location feature is on.
-  indicates your phone's location feature is off.
-  indicates you are in Airplane mode.
-  indicates you have Nextel Walkie-Talkie coverage.
-  indicates the Walkie-Talkie speaker is on.
-  indicates the Walkie-Talkie speaker is off.
-  indicates your phone is set to ring for incoming calls.
-  indicates a Nextel Walkie-Talkie call is in progress.
-  indicates a Talkgroup call is in progress.
-  indicates a Nextel Group Walkie-Talkie call is in progress.
-  indicates a Nextel Direct Talk call is in progress.
-  indicates you have received a Call Alert.
-  indicates you missed a Walkie-Talkie call or a Talkgroup call.

## Navigating Through Phone Menus and Options

The navigation keys on your phone allows you to scroll through menus and options quickly and easily.

To navigate through a list-type menu, simply press your navigation keys up or down. The scroll bar at the right of the menu keeps track of your position in the menu at all times.









For a diagram of your phone's menu, please see "Your Phone's Menu" on page iv.

Some features, such as Call History and Contacts, allow you to access options by highlighting icons near the top of the screen. To navigate through these options, press your navigation keys left or right.

### Selecting Menu Items

As you navigate through the menu, menu options are highlighted. Select an item by highlighting it and pressing .



For example, if you want to see your volume settings:

1. Press  to access the main menu.
2. Select **Settings/Tools** by pressing  or by highlighting it and pressing .
3. Select **Settings** by pressing  or by highlighting it and pressing .
4. Select **Sounds** by pressing  or by highlighting it and pressing .
5. Select **Volume** by pressing  or by highlighting it and pressing .

**Note:**

For the purposes of this guide, the above steps condense into "Press  > **Settings/Tools** > **Settings** > **Sounds** > **Volume.**"

## Backing Up Within a Menu

- ▶ To go to the **previous menu**, press .
- ▶ To return to **standby mode**, press .

## Shortcuts and Favorites

In standby mode, your phone give you ways to quickly access features you use frequently:

- ▶ Use the navigation keys to use shortcuts to five features.
- ▶ Press Favorites (right softkey) to access a list of favorite features.

## Help

Your phone contains an in-device help program to help you understand complicated or seldom used features. When you access a feature, **Help** sometimes appears as a menu item or softkey. Select **Help** and read the text for a quick overview of the feature. For more information, refer to this guide.

## Accessories

---

Your phone comes with the following accessories:

- A Li-Ion battery and charger.
- A 128K SIM card.
- A microSD memory card.
- A stereo headset.
- A carry holster.

Various accessories are available for use with your ic902 phone, including cases, vehicle power chargers, data cables, hands-free accessories, and more.

To make communicating with Nextel Walkie-Talkie easier, the Motorola Walkie-Talkie headset allows hands-free operation. You can use it for phone calls as well as Nextel Walkie-Talkie calls.

To order additional accessories, go to [www.sprint.com](http://www.sprint.com) or call 1-888-242-4187. You can also contact your Sprint Authorized Representative or stop by any Sprint Store. For information on Sprint Store locations, go to [www.sprintstorelocator.com](http://www.sprintstorelocator.com).



# Entering Text

## Selecting a Character Input Mode

Your phone provides convenient ways to enter words, letters, punctuation, and numbers whenever you are prompted to enter text (for example, when adding a Contacts entry or when using SMS Text Messaging).

To change the character input mode:

1. When you display a screen where you can enter text, press **Options** (right softkey) to change the character input mode.
2. Select one of the following options:
  - **Word English** to enter text using a predictive text entering system that reduces the keys that need to be pressed while entering a word (see page 32).
  - **Multi-Tap** to cycle through the alpha characters associated with the letters on the keypad (see page 33).
  - **Numbers** to enter numbers by pressing the numbers on the keypad (see page 34).
  - **Symbols** to enter symbols (see page 34).
  - **Word Spanish** to enter Spanish text using predictive text like Word English (see page 32).

**Tip:**

When entering text, press  to change letter capitalization.







An additional option (**Insert Preset Msg**) is available when using messaging. See “Managing Preset Messages” on page 82.

## Entering Characters Using Word English Text Input

Word English Text Input lets you enter text into your phone by pressing keys just once per letter. (To select the **Word English** mode when entering text, see “Selecting a Character Input Mode” on page 31.)

Word English Text Input analyzes the letters you enter using an intuitive word database and creates a suitable word. (The word may change as you type.)

To enter a word using **Word English Text Input**:

1. Select the **Word English** character input mode. (See “Selecting a Character Input Mode” on page 31.)
2. Press the corresponding keys once per letter to enter a word (for example, to enter the word “Bill,” press    ). (If you make a mistake, press  to erase a single character. Press and hold  to delete an entire entry.)

If the word you want is not displayed after you have entered all the letters, press the navigation key **down** to scroll through other word options. A pop-up list appears with the word options.

To accept a word and insert a space, press .

– or –

To accept a word completion (such as “Billion” when you entered “Bill”), press the navigation key right.

### Tip:

To turn word completion on or off, press  > **Settings/Tools** > **Settings** > **Others** > **Text Input** > **Word Completion** > **On** or **Off**.

## Adding a Word to the Word English Database

If a word you want to enter is not displayed as an option when you are using Word English Text Input, you can add it to the database.

To add a word to the Word English Text Input database:







1. Select the **Multi-Tap** character input mode. (See “Selecting a Character Input Mode” on page 31.)
2. Enter the word using multi-tap text entry. (See “Entering Characters Using Multi-Tap Mode” on page 33.) The word appears as an option the next time you scroll through options during Word English Text Input.

### Tip:

To turn the dictionary on or off, press  > **Settings** > **Others** > **Text Input** > **Personal Dictionary** > **On** or **Off**.













## Entering Characters Using Multi-Tap Mode

To enter characters by tapping the keypad:

1. Select the **Multi-Tap** mode. (See “Selecting a Character Input Mode” on page 31.)
2. Press the corresponding keys repeatedly until the desired letter appears. (For example, to enter the word “Bill,” press  twice,  three times,  three times, and  three times again). If you make a mistake, press  to erase a single character. Press and hold  to erase an entire word.

By default, the first letter of an entry is capitalized and the following letters are lowercased. After a character is entered, the cursor automatically advances to the next space after two seconds or when you enter a character on a different key.

Characters scroll in the following order:

	. ? ! , @ ' - _ : ; ( ) & " 1 0 ^ ` % \$ + * / \   ~ [ ] = > < #
	A B C 2
	D E F 3
	G H I 4
	J K L 5
	M N O 6
	P Q R S 7
	T U V 8
	W X Y Z 9
	0 (no letters)
	Space
	Shift

## Entering Numbers and Symbols

To enter numbers:

- ▶ Select the **Numbers** mode and press the appropriate key. (See “Selecting a Character Input Mode” on page 31.)

To enter symbols:

- ▶ Select the **Symbols** mode. (See “Selecting a Character Input Mode” on page 31.) To enter a symbol, press the appropriate key indicated on the display screen.

## Section 2

# Using Your Phone



# Making and Answering Calls

---

## In This Section

---

- ◆ **Types of Calls**
  - ◆ **Making and Answering Phone Calls**
  - ◆ **Making and Answering Nextel Walkie-Talkie Calls**
  - ◆ **Making and Answering Talkgroup Calls**
  - ◆ **Making and Answering Nextel Direct Talk Calls**
  - ◆ **Using Call Alerts**
  - ◆ **Keeping Track**
- 

**Your Motorola Deluxe ic902 phone offers many different ways to connect to your family, friends, and associates.** In addition to traditional wireless phone calls, you can make Nextel Walkie-Talkie calls to both individuals and groups, participate in Talkgroups, use Nextel Direct Talk, and send Call Alerts.

## Types of Calls

With the Nationwide Sprint PCS Network, Nextel Walkie-Talkie, and your Motorola Deluxe ic902 phone, you have the following traditional wireless phone and Nextel Walkie-Talkie services available to you:

- **Digital Wireless Phone Calls** offer clear calls and many extra services, including missed call notification, three-way calling, speakerphone, and speed dialing (page 38).
- **Digital Nextel Walkie-Talkie Calls** allow two-way radio communication with other Nextel Walkie-Talkie users within the Nextel National Network (page 48).
- **Nextel Group Walkie-Talkie Calls** allow coast-to-coast two-way radio calling to up to 20 Nextel Walkie-Talkie customers simultaneously (page 53).
- **Talkgroup Calls** allow two-way radio calling to up to 100 Nextel Talkgroup customers simultaneously (page 57).

**Note:**

To learn more about the differences between NextelGroup Walkie-Talkie calls and Talkgroup calls, please see “Difference Between Group Walkie-Talkie and Talkgroup Calls” on page 57.

- **Nextel Direct Talk Calls** allow two-way radio communication between two or more Nextel Direct Talk-capable phones. These calls are not made on the network (page 60).

**Note:**





Please see your service plan for information on pricing.

# Making and Answering Phone Calls

## Making Calls

Placing a traditional, wireless phone call from your phone is as easy as making a call from any landline phone.

To make a phone call using your keypad:

1. Make sure your phone is on and open.
2. Enter a phone number from standby mode. (If you make a mistake while dialing, press  to erase one digit at a time. Press and hold  to erase the entire number.)
3. Press . (To make a call when you are roaming and Call Guard is enabled, see “Using Call Guard” on page 109.)
4. Press  or close the phone when you are finished.

**Tip:** To redial your last outgoing call, press  twice.

## Answering Calls

To answer an incoming call:

1. Make sure your phone is on.

**Note:** When your phone is off, incoming phone calls go directly to voicemail.

---

If you are on another phone call or Walkie-Talkie call, or using data services, please see “Keeping Track” on page 68.

2. Press  to answer an incoming call.  
– or –  
Press **Answer** (left softkey).



**Note:** When the phone is closed, you can answer a call by pressing the **Speaker Key**.

Depending on your phone's settings, you may also answer incoming calls by opening the phone or by pressing any number key. See "Call Answer Mode" on page 87 for more information.

Your phone notifies you of incoming calls in the following ways:

- The phone rings or vibrates.
- The status light flashes green and red.
- The backlight illuminates.
- The display screen show an incoming call notification. If the incoming call is from a number stored in your Contacts, the entry's name and/or number appears.

### Answering a Roam Call With Call Guard Enabled

Call Guard is an option that helps you manage your roaming charges when making or receiving calls while outside the Nationwide Sprint PCS Network. Please see "Controlling Your Roaming Experience" on page 105 for more information about roaming.

To answer a call when you are roaming and Call Guard is enabled:

- ▶ Press  to answer the call. (See "Using Call Guard" on page 109 for additional information.)

### Ending a Call

To disconnect a call when you are finished:

- ▶ Close the phone or press .

**Note:** When the phone is closed, you can end a call by pressing the **Smart Key**.

## Missed Phone Calls

Missed phone calls are forwarded to voicemail.

## Calling Emergency Numbers

You can place calls to 911 (dial    and press ) , even if your phone is locked or your account is restricted.

During an emergency call, press **Options** (right softkey) to display your options.

When you place an emergency call, your phone automatically enters Emergency mode. Your phone exits Emergency mode a few minutes after you end the emergency call.

**To exit Emergency mode, do one of the following:**

- ▶ Wait until your phone exits Emergency mode.
- ▶ Dial a non-emergency phone number.

## Emergency Mode and Nextel Walkie-Talkie Calls

Your phone's Walkie-Talkie functionality impacts Emergency mode as follows:

- If your phone has only been provisioned for Nextel Walkie-Talkie service, you cannot make emergency calls.
- You cannot make or receive any Walkie-Talkie calls when your phone is in Emergency mode.
- If you are on a Walkie-Talkie call, you must wait until the phone reconnects to a cellular network before attempting to make an emergency 911 call.
- You may be in an area that has Nextel Walkie-Talkie coverage, but no cellular network coverage. If so, you will not be able to make emergency calls.

## Emergency Mode With an Inactive SIM Card

You can still make emergency calls if your SIM card is not working or if your SIM security code is not being accepted.

## Enhanced 911 (E911) Information

This phone features an embedded Global Positioning System (GPS) chip necessary for utilizing E911 emergency location services where available.

When you place an emergency 911 call, the GPS feature of your phone begins to seek information to calculate your approximate location. Depending on several variables, including availability and access to satellite signals, it may take up to 30 seconds or more to determine and report your approximate location.

### IMPORTANT

**Always report your location to the 911 operator when placing an emergency call.** Some designated emergency call takers, known as Public Safety Answering Points (PSAPs) may not be equipped to receive GPS location information from your phone.

## In-Call Options

Pressing **Options** (right softkey) during a call displays a list of features you may use during the course of a call. To select an option, highlight it, and press . The following options are available:

- Select **Speaker On** to route the phone's audio through the speaker. You can adjust the speaker volume using the volume keys on the side of the phone. Select **Speaker Off** to use the phone's earpiece.

### Note:

You can also turn the speakerphone on or off by pressing the **Speaker Key** during a phone call.

Due to higher volume levels, do not place the phone near your ear during speakerphone use.

- **Contacts** opens your phone's address book.

- **3-Way Call** lets you initiate a three-way call (see page 225).
- **Record Recipient** creates a Voice Record of the call.
- **Phone Info** opens your Phone Info menu.
- **Send Text Message** opens your Text Messaging menu.
- **Call History** opens your Call History menu.
- **Use Bluetooth** or **Switch Audio** switches the call from a Bluetooth headset to your phone.
- **Tools** opens your Tools menu.
- **TTY** allows you to set TTY options.

During a call, the left softkey button functions as the **Mute** button. Press it to mute the phone's microphone for privacy. Press it again to **Unmute** the phone.

## End-of-Call Options

If you have just finished a call with someone listed in your Contacts, the entry's name and the duration of the call are displayed.

After receiving a call from or making a call to a phone number that is not in your Contacts, the phone number and the duration of the call are displayed. After finishing the call, press **Options** (right softkey) and then select **Save** to store the number to Contacts.

<b>Note:</b>	The End-of-Call options are not displayed for calls identified as No ID or Restricted.
--------------	--





To go to Call History after ending a call:

- ▶ Press **Call History** (right softkey) or **Options** (right softkey) and then select **Call History**.

## Saving a Phone Number

Your phone can store up to five phone numbers in each Contacts entry. Each entry's name can contain 24 characters. Your phone automatically sorts the Contacts entries alphabetically. (For more information, see "Using Contacts" on page 120.)

To save a number from standby mode:

1. Enter a phone number.
2. Press **Options** (right softkey).
3. Select **Save** and press .
4. Select **As New Entry** and press . Use the numeric keypad to enter the new contact name, then press **Save** (left softkey).  
– or –  
Select **To Existing Entry** and press . Scroll to the existing entry where you want to save the number and press , then press **Save** (left softkey).

## Dialing and Saving Phone Numbers With Pauses

You can dial or save phone numbers with pauses for use with automated systems, such as voicemail or credit card billing numbers.

There are two types of pauses available on your phone:

- **Hard Pause** sends the next set of numbers when you press the left softkey.
- **2Sec Pause** automatically sends the next set of numbers after two seconds.

**Note:** You can have multiple pauses in a phone number and combine two-second pauses with hard pauses.

### To dial or save phone numbers with pauses:

1. Enter the phone number.
2. Press **Options** (right softkey) and select either **Hard Pause** or **2Sec Pause**.
3. Enter additional numbers.  
Press  to dial the number.  
– or –  
Press **Options** (right softkey) and select **Save** to save the number in your Contacts.



**Note:**

When dialing a number with a hard pause, press **Yes** (left softkey) to send the next set of numbers.

## Plus (+) Code Dialing

When placing international calls, you can use Plus Code Dialing to automatically enter the international access code for your location. From the United States, this number is usually 011.

### To make a call using Plus Code Dialing:

1. Press and hold  until a “+” appears on your display screen.
2. Dial the country code and phone number you're calling and press . (The access code for international dialing is automatically dialed, followed by the country code and phone number.)

## Abbreviated Dialing

You can set up your phone to make calls using just the last four digits of the number. Your phone automatically prepends the first digits (for example, the area code and prefix).

You must enable Abbreviated Dialing and define the first digits before you can use this feature. To set up Abbreviated Dialing, see “Calling Options” on page 88.

To make a call using only the last four digits of the number:

1. Enter the last four digits of a phone number.
2. Press .

## Dialing From Contacts

To dial directly from a **Contacts** entry:

1. Press **Contacts** (left softkey).
  2. Scroll to the phone number you want to call and press .
- or –

To call another number from the entry, use the navigation keys to scroll left and right until you reach the phone number you wish to call and press .





**Tip:**

To make a Nextel Walkie-Talkie call, press **Contacts** (left softkey), find the number you want to call, and press and hold the Walkie-Talkie button.

## Dialing From Call History

You can make calls from Call History with your phone open or closed.

**To make a call with the phone open:**

1. Press  > **Call History**.
2. Find the entry you want on the All Calls list or scroll left or right to view the entries on The Walkie Talkie list, the Missed Calls list, the Incoming Calls list, and the Outgoing Calls list.
3. Scroll to the phone number you want to call.  
– or –  
If the number shown is Calls History is stored in your Contacts with another number you want to call:  
Scroll to the entry and press .  
Press  again to see all numbers store in the Contact entry.  
Scroll to the number you want to call.
4. Press  to place the call.

**To make a call with the phone closed:**

1. Press the **Smart Key** to view the All Calls list on your phone's external display.
2. Use the volume keys to scroll through the All Calls list.
3. Scroll to the phone number you want to call.
4. Press the **Speaker Key** to place the call.
5. Press the **Smart Key** to end the call.

**Tip:**

To make a Nextel Walkie-Talkie call from Call History with the phone open or closed, find the Walkie-Talkie number you want to call and press and hold the Walkie-Talkie button to place the call.



## Using Speed Dialing

You can store up to 99 numbers in your phone's speed dial memory. With this feature, you can speed dial entries using one key press for locations 2-9, and two key presses for locations 10-99.

<b>Note:</b>	You must enable speed dialing before you can use it. See "Calling Options" on page 88 for instructions.
	Speed dialing is not available when you are roaming; when you are roaming off the Nationwide Sprint PCS Network, you must always dial using 11 digits (1 + area code + number).

### For Speed Dial locations 2-9 (One-Touch Dialing):

- ▶ Press and hold the appropriate key for approximately two seconds. The display screen confirms that the number has been dialed when it shows "Calling..."

### For Speed Dial locations 10-99 (Two-Touch Dialing):

1. Press the first digit.
2. Press and hold the second digit for approximately two seconds. The display screen confirms that the number has been dialed when it shows "Calling..."

# Making and Answering Nextel Walkie-Talkie Calls

---

## Making Nextel Walkie-Talkie Calls

To make a Walkie-Talkie call:

1. Enter the Walkie-Talkie number you want to call. (See “Dialing Nextel Walkie-Talkie Numbers” below.)
2. Press and hold the Walkie-Talkie button on the side of your phone. Begin talking after your phone emits a chirping sound.
3. Release the Walkie-Talkie button to listen.

A Walkie-Talkie call ends automatically after there is no activity on the call for several seconds.

<b>Note:</b>	When the phone is closed, you can end a call by pressing the <b>Smart Key</b> .
--------------	---

## Dialing Nextel Walkie-Talkie Numbers

Every Walkie-Talkie number has three parts —

- An area ID.
- A network ID.
- A member ID.

An asterisk separates each part (for example: 999\*999\*9999). When you enter a number containing all three parts, you must separate them with asterisks.

<b>Note:</b>	The number of digits in each part of a Walkie-Talkie number may vary. For example, your Walkie-Talkie number may be formatted as 999*999*9999, while another valid number may appear as 555*555555*55.
--------------	--

**Tip:**

When you store a Walkie-Talkie number in Contacts, it is good practice to include the whole number, including the asterisks.

## Using Just the Member ID

If you are contacting someone sharing your network and area IDs, you only need to enter the member ID.

To make a Walkie-Talkie call using only the member ID:

1. Enter the member ID of a Walkie-Talkie number.
2. Press and hold the Walkie-Talkie button on the side of your phone. Continue as you would on any Walkie-Talkie call.

## Using Stored Nextel Walkie-Talkie Numbers

You can also make Walkie-Talkie calls using numbers stored in Contacts or Call History. Just access the appropriate Walkie-Talkie number and make the call. This makes it easy to call frequently-used Walkie-Talkie numbers.

To access a Walkie-Talkie number from Call History:

- ▶ Press  > **Call History** and then scroll left or right to go to **All Calls** or **Walkie Talkie**. Scroll to and highlight the Walkie-Talkie number you want.

To access a Walkie-Talkie number from Contacts:

1. Press **Contacts** (left softkey).
2. Scroll to and highlight the contact you want to call.
3. Use the navigation keys to scroll left and right to find the Walkie-Talkie number (if it is not the first number displayed).

## W-T Contacts

W-T Contacts filters Contacts and Call History to display only Walkie-Talkie numbers.

To access a Walkie-Talkie number using W-T Contacts:

1. Press  > **Walkie-Talkie** > **W-T Contacts**.
2. Use your left and right navigation keys to select **W-T Contacts** or **W-T Call History**.
3. Scroll to and highlight the Walkie-Talkie number you want to call.

## Answering Nextel Walkie-Talkie Calls

When you receive a Walkie-Talkie call, your phone emits a chirping sound or vibrates, and the Walkie-Talkie button lights up. You then hear the voice of your caller.

To answer a Walkie-Talkie call:

1. Wait for the caller to finish speaking.
2. Press and hold the Walkie-Talkie button on the side of your phone. Continue as you would on any Walkie-Talkie call.
3. Press  to end the call.

A Walkie-Talkie call ends automatically after there is no activity on the call for several seconds.

**Note:**

If your phone is closed, you can end a call by pressing the **Smart Key**.

## Sending Contact Information

Use **Send via Walkie-Talkie** to send your own (or another's) contact information to a Walkie-Talkie user.

### Setting Up Send via Walkie-Talkie

By default, your phone automatically sends your personal information every time you make a Walkie-Talkie call. You can turn this functionality off or modify how much information you want to send.

To setup **Send via Walkie-Talkie**:

1. Press **[OK]** > **Contacts** > **My Business Card**.
2. Press **Options** (right softkey) and then select **Send Settings**.
3. Clear or select **Auto Send** as desired by pressing **[OK]**.
4. Clear or select the contact information you want to send — **Mobile, Home, Work, Pager, Other, E-mail, and Web Address**— by pressing **[OK]** after each selection.
5. Select **Save** (left softkey).

**Note:**

You will probably want to set up your **My Business Card** screen to contain other contact information, like your name and other phone numbers. See “Finding Your Phone Number and Walkie-Talkie Number” on page 23 for more details.



### Using Send via Walkie-Talkie

You can use **Send via Walkie-Talkie** during a Walkie-Talkie call to send contact information to the person you are speaking to. You can also initiate **Send via Walkie-Talkie** from **Contacts** or **Call History**.

### To send contact information using Send via Walkie-Talkie during a Walkie-Talkie call:

1. Begin a Walkie-Talkie call in the regular manner.
2. Release the Walkie-Talkie button.
3. Press **Options** (right softkey).
4. To send your own contact information to the caller, select **Send Business Card**.  
– or –  
To send another's contact information to the caller, select **Send a Contact**, scroll to the contact you want to send, and then press .
5. Press and hold the Walkie-Talkie button to send the information.

### To send contact information from Contacts to a Walkie-Talkie user:

1. Press  > **Contacts** > **View All**.
2. Highlight the Contacts entry you want to send.
3. Press **Options** (right softkey) and then select **Send this Contact > Walkie-Talkie**.  
Your phone displays a list of numbers capable of receiving Send via Walkie-Talkie information.
4. Scroll to the entry you want to send the information to, and then press .
5. Press the Walkie-Talkie button to send the information.

### To send your own contact information from Contacts to a Walkie-Talkie user:

1. Press  > **Contacts** > **View All**.
2. Highlight the Contacts entry you want to send your information to.

3. Press **Options** (right softkey) and then select **Send Business Card > Walkie-Talkie**.
4. Press the Walkie-Talkie button to send the information.

**Note:** You can also use the All Calls and Walkie-Talkie lists in Call History to Send via Walkie-Talkie. Press **☰ > Call History** and scroll to **All Calls** or **Walkie Talkie**.

## Nextel Group Walkie-Talkie Calls

A Nextel Group Walkie-Talkie call is made to multiple Walkie-Talkie users at the same time. You can call up to 20 persons anywhere on the Nextel National Network on their Group Walkie-Talkie compatible phones.

These Groups do not have established memberships. They are created by you or other Group Walkie-Talkie users. A Group can be set up for one-time use or it can be stored in Contacts for repeated use.

For information on creating Groups and storing them in Contacts, see “Contacts Entries for Walkie-Talkie Groups and Talkgroups” on page 129.

## Making Nextel Group Walkie-Talkie Calls

To make a Group Walkie-Talkie call:



1. From **Contacts** or the appropriate **Call History** list, scroll to and select the Group you want to call.
2. Press the Walkie-Talkie button and continue as if making a regular Walkie-Talkie call.

**Note:** You can also highlight a call from W-T Contacts. Press **☰ > Walkie-Talkie > W-T Contacts**. Press the navigation key right or left from **W-T Contacts** or **W-T Call History**.

## Creating a Group Using Walkie Talkie Contacts

Use Walkie Talkie Contacts to create a Group and make a Group Walkie-Talkie call quickly. Or, you can save it to Contacts and then make the Group Walkie-Talkie call.

To create a Group using Walkie Talkie Contacts:

1. Press  > **Walkie-Talkie** > **W-T Contacts**.
2. Use the left and right navigation keys to select **W-T Contacts** or **W-T Call History**.
3. Highlight each entry you want to call and press  to make each selection.
4. To make a Walkie-Talkie Group call, press and hold the Walkie-Talkie button  
– or –  
To save the Group, press **Options** (right softkey) and select **Save Group**. Enter the **Name**, **Category**, and then press **Save** (left softkey). You can then make a Group Walkie-Talkie call.

## Answering Group Walkie-Talkie Calls

When you receive a Group Walkie-Talkie call, the name of the Group appears on your display screen. Answer a Group Walkie-Talkie call in the same way you answer a regular Walkie-Talkie call. Only one person may speak on a Group call at a time.



## Group Walkie-Talkie Call Information

While you are on a Group Walkie-Talkie call, the following appears on the display screen:

- The name of the Group.
- The name or the Walkie-Talkie number of the person speaking.
- The number of participants in the Group Walkie-Talkie call.

## Group Walkie-Talkie Call Details

During a Group Walkie-Talkie call, you can view details about the other Group members, such as their name, Walkie-Talkie number, and their status on the call.

To view call details while on a Group Walkie-Talkie call:

- ▶ Press **Details** (right softkey).

Your display screen shows the names of the Group members next to an icon identifying their status on the call.



The Group member who is currently speaking.



A Group member who is active on the Group call, but is not speaking.



A Group member who has exited the call.



A Group member who could not be reached on the Group call.



A Group member whose status is unknown.

## Sharing Groups

You share Groups by saving Groups from calls you participated in and by sending Groups to other callers.

To store Groups from Call History:

1. Press **[OK]** > **Call History** and scroll to **All Calls** or **Walkie Talkie**.
2. From the list, select the Group you want.
3. Press **Options** (right softkey) and then select **Save**.
4. Select **As New Entry**, complete the Contacts entry, and then press **Save** (left softkey).  
– or –  
Select **Replace Entry** and press **[OK]**.

### Using Send via Walkie-Talkie

Use **Send via Walkie-Talkie** to forward an established Group to another Walkie-Talkie user.

To forward a Group using **Send via Walkie-Talkie**:

1. Press **[OK]** > **Contacts** > **Filter by** > **Walkie-Talkie Group**.
2. Scroll to the Group you want to send and then press **Options** (right softkey).
3. Select **Send this Contact**.
4. Select **Yes** or **No** to include or exclude yourself from the Group.

**Note:**

If you choose to include yourself and the list already contains the maximum number of members, you will be prompted that the list is full. You will then be excluded from the list.

5. Use the left and right navigation keys to select **Contacts** or **Call History**.



- Highlight the caller you want to forward the Group to and press .
- Push the Walkie-Talkie button to send the Group.

## Making and Answering Talkgroup Calls

A Talkgroup is a predetermined group of Walkie-Talkie users, created by an account administrator. They can contain up to 100 members.

### Difference Between Group Walkie-Talkie and Talkgroup Calls

In a Group Walkie-Talkie call, you or another caller determines who can participate in the call. By contrast, participation in a Talkgroup is determined by an administrator. Here are the ways Group Walkie-Talkie and Talkgroup calls differ.

	Group	Talkgroup
<b>Icon</b>		
<b>Geography</b>	Nationwide.	All users in a Talkgroup must share the same network and area IDs and be physically present in their home market.
<b>Maximum Size</b>	21 (including originator).	100.
<b>Set-up</b>	Dynamically, via your phone.	Predefined by an account administrator.

## Joining a Talkgroup

To participate in a Talkgroup, the account administrator must first add you to the membership and then you must “join” the Talkgroup.

To join a Talkgroup:

1. Press **Contacts** (left softkey).
2. Scroll to the Talkgroup you want to join.
3. Press **Join** (left softkey).

You can now receive communications from other members of this Talkgroup.

You will hear all active Talkgroup conversations on your phone. To silence them, go to  > **Settings/Tools** > **Settings** > **Walkie Talkie** > **Talkgroup Silent** and then select **On**. See “Silencing Talkgroup Calls” on page 91 for more information.

**Note:**

You can create a Contacts entry for the Talkgroup or save a Talkgroup from Call History. See “Creating Talkgroup Entries” on page 131 for more information.

## Adding More Talkgroups

You can be included in additional Talkgroups by doing one of the following:

- Using Talkgroup Management at [www.sprint.com](http://www.sprint.com). You must be an account administrator to use Talkgroup Management.
- Contacting your Sprint Sales Representative at the time of activation.

**Note:**

You can only in participate in (“join”) one Talkgroup at a time.

## Making Talkgroup Calls

To make Talkgroup calls:

1. Press  and then enter the Talkgroup number using the keypad.  
– or –  
Select the Talkgroup from **Contacts**, the **All Calls** and **Walkie-Talkie** lists in **Call History**, or from **Walkie Talkie Contacts**.
2. Press the Walkie-Talkie button and continue as if making a Walkie-Talkie call.

## Receiving Talkgroup Calls

To answer a Talkgroup call:

- ▶ Answer it as you would a regular Walkie-Talkie call.

Only one person at a time may speak on a Talkgroup call. The Walkie-Talkie number or name of the person who is speaking appears on the display screen below the Talkgroup number.

During and immediately after a Talkgroup call ends, press **Options** (right softkey). Your phone displays actions you can take at this time.

# Making and Answering Nextel Direct Talk Calls

---

Nextel Direct Talk allows for two-way radio communication “off the network” between two or more phones equipped with this capability. This feature is very useful in areas without network coverage.

You can make –

- **Code calls** – two-way radio calls conducted off the network and using open channels and codes. In these calls, anyone using your same channel and code can hear your conversation.
- **Private calls** – two-way radio calls conducted off the network and using the wireless phone numbers of the participants. In these calls, others using the same channel cannot listen in.

When using Direct Talk mode, the two phones should be a minimum of six feet apart to maximize performance and improve transmission range. You can only make Direct Talk calls to users located within your range. This varies according to terrain, man-made structures, and atmospheric conditions.

The following features are not available while in Direct Talk mode:

- On-network phone calls.
- On-network Walkie-Talkie, Group Walkie-Talkie, Talkgroup calls, and Call Alerts.
- Data Services.
- Sending and receiving messages.
- Call timer.
- Sending Call Alerts.
- Call forwarding.

## Setting Your Phone to Nextel Direct Talk

Before you and another caller can use Direct Talk, both of your phones must be set to Direct Talk mode.

**To set your phone to Direct Talk:**

- ▶ Press  > **Walkie-Talkie** > **Direct Talk**.

After a few seconds, your channel and code appear on the display screen. Your phone displays the last channel and code used for Direct Talk.

**To return to network mode from Direct Talk:**



- ▶ In Direct Talk mode, press **Options** (right softkey) and then select **Exit Direct Talk**.

After a few seconds, your phone returns to network service.

### Direct Talk Setup Options

You can set up your phone to alert you and remind you whenever you are in Direct Talk mode.

**To set your phone to remind you periodically that you are in Direct Talk mode:**



1. In Direct Talk mode, press **Options** (right softkey) and then select **Direct Talk Setup**.
2. Select **Reminder**.
3. Press your navigation key down and press .
4. Select the time interval for the reminder tone and press .
5. Press  to return to the Direct Talk main screen.

## Code Nextel Direct Talk Calls

Your phone has 10 channels and 15 codes within each channel. Channels represent the radio frequencies on which you make and receive Nextel Direct Talk calls. Codes allow you to minimize interference from others using the same channel as you.

To make Direct Talk Code calls, both parties must be on the same channel and code and have their phones set to Direct Talk. Be aware that others using both your same code and channel can hear your conversation. And, you can hear their conversations as well.

**To set a channel and code:**

1. In Direct Talk mode, press **Options** (right softkey) and then select **Edit Channel/Code**.
2. With **Channel** number field highlighted, use your up and down navigation keys to set a channel number and press .
3. Press your navigation key down.
4. With **Code** number field highlighted, use your up and down navigation keys to set a code number and press .
5. Press **Save** (left softkey).

### Making and Receiving Code Calls in Direct Talk Mode

**To make a Code call using Direct Talk:**

- ▶ In Direct Talk mode, press and hold the Walkie-Talkie button. Your phone displays **Transmitting**, along with the channel and code selected.

The tone emitted from your phone when making a Direct Talk call is four beeps and sounds different from the tone heard on Walkie-Talkie calls conducted on the network.



If you receive an error message, this means:

- There may be no parties on your channel or code.
- You are out of range.

When you receive a Code call using Direct Talk, your phone displays **Receiving**, along with the channel and code selected. Answer a Direct Talk Code call just like you would any other Walkie-Talkie call.

## Private Nextel Direct Talk Calls

Private Direct Talk allows you to silence all the calls on a channel that are not directed specifically at you. To do this, you must first set your phone to **Private Only**.

To set your phone to **Private Only**:

1. In Direct Talk mode, press **Options** (right softkey) and then select **Edit Channel/Code**.
2. With **Code** number field highlighted, use your up and down navigation keys to select **Private Only** and press .
3. Press **Save** (left softkey).

To reach you, other Direct Talk callers must be on your same channel and dial your 10-digit wireless phone number to reach you.

## Receiving a Private Direct Talk Call

The number or name of the person who initiated the call appears on your display screen. Answer the call in the same way you answer a regular Walkie-Talkie call.

A Private Direct Talk call ends a short time after the last party releases the Walkie-Talkie button. The display screen returns to Direct Talk standby mode.

<b>Note:</b>	You do not need to set your phone to Private Only to receive Private calls. As long as you are on the same channel as your caller, you can receive Private Direct Talk calls.
--------------	---

## Making a Private Direct Talk Call

You can make Private Direct Talk calls to any person on your same channel. You do not need to set your phone to **Private Only**.

To make a private Direct Talk Call:

1. In Direct Talk mode, enter the 10-digit wireless phone number of the person you want to call on your channel. (You can also scroll to the number in **Contacts** or **Call History**.)
2. Make the call in the same way you make a regular Walkie-Talkie call. The number or name of the person you are calling appears on your display screen.

If you receive an error message, it means:



- You may not be using a valid wireless phone number.
- The person that you are trying to reach may not be in Direct Talk mode.
- The person that you are trying to reach is set to a different channel, or is out of range.

## Receiving All Calls on a Channel

You can set your phone to receive all Direct Talk transmissions that are within range and set to the same channel. Do this by selecting **Receive All**, instead of a code.

However, you cannot initiate a call when the code is set to **Receive All**. If you press the Walkie-Talkie button to initiate a Walkie-Talkie call and your code is set to **Receive All**, you receive an error message.

### To set the code to Receive All:

1. In Direct Talk mode, press **Options** (right softkey) and then select **Edit Channel/Code**.
2. With **Code** number field highlighted, use your up and down navigation keys to select a channel number and press .
3. Select **Receive All** and press .
4. Press **Done** (left softkey).

## Making Emergency Calls While in Direct Talk Mode

If you attempt to make an emergency 911 call while in Direct Talk mode, your phone automatically exits Direct Talk mode and attempts to find a network signal.

If you are out of network coverage, your phone cannot make an emergency 911 call until you return to a network coverage area. You must wait until the phone reconnects to a network before attempting to make an emergency 911 call.

# Using Call Alerts

---

Sending a Call Alert lets the recipient know you want to talk to him or her on a Nextel Walkie-Talkie call. When you send a Call Alert, the recipient's phone alerts them and displays your name or Walkie-Talkie number.

## Sending Call Alerts

To send a Call Alert:

1. Enter the Walkie-Talkie number you want to send the alert to.
2. Press **Alert** (left softkey).
3. Press the Walkie-Talkie button until **Alert Sent to** appears on the display screen.

If the alert is not successful, this may mean the person you are trying to reach is on a call or has the phone turned off.

**Note:**

You can send a Call Alert from Call History or Contacts. Find the Walkie-Talkie number you want to send a Call Alert to and continue as explained above.

## Responding to a Call Alert

**Note:** You can set a distinctive ringer for Call Alerts. See “Ringer Types” on page 72.

### To answer a Call Alert:

- ▶ Press the Walkie-Talkie button to make a Walkie-Talkie call to the sender.

### To clear a Call Alert, do one of the following:

- ▶ Press **Dismiss** (right softkey).
- ▶ If the phone is closed, press the **Smart Key**.

## Viewing Call Alerts

In Call History, the All Calls and Walkie-Talkie Calls lists store the Call Alerts you have received. Call Alerts are shown as regular Walkie-Talkie calls. Call Alerts remain on the appropriate Call History lists until you delete them or they reach the end of list.

### To view a Call Alert upon receiving it:

- ▶ Press **View** (left softkey).

### To view Call Alerts stored in Call History:

1. Press **[Call History]** > **Call History** and scroll to **All Calls** or **Walkie-Talkie Calls**.
2. Scroll through the list.
3. Select a Call Alert to view detailed information about it.

# Keeping Track

---

Your Motorola Deluxe ic902 phone allows you to contact your family, friends, and business associates in many different ways – phone calls, Walkie-Talkie calls, Group Walkie-Talkie calls, Talkgroup calls, and Call Alerts. Your phone tracks these communications through Call History and the Events list.

The Events lists notifies you of incoming phone and Walkie-Talkie calls, Call Alerts, voicemail and text messages, meetings on the calendar, and more. When the Events list contains information, it appears dynamically or your phone displays an **Events** softkey.

Your phone then offers easy-to-follow prompts that allow you to respond to the notification.

## Incoming Phone Calls

If...	Then...
Your phone is turned off.	Phone calls are sent to voicemail and are not listed in Call History.
Your phone is in standby mode or on another phone call.	Your phone displays an incoming call notification, lists the call in Call History, and, if unanswered, forwards the call to voicemail.
Your phone is on a Walkie-Talkie call.	Your phone neither alerts you to the incoming call nor lists it in Call History. It does forward the call to voicemail.
Your phone is in a data session, but you are not transmitting data.	Your phone displays an incoming call message, lists it in Call History, and forwards it to voicemail.
Your phone is in a data session and you are transmitting data.	Your phone neither displays an incoming call message nor lists it in Call History. It does forward the call to voicemail.

## Incoming Walkie-Talkie Calls, Talkgroup Calls, and Call Alerts

If...	Then...
Your phone is turned off.	Your phone does not list Walkie-Talkie calls, Talkgroup calls, or Call Alerts in Call History.
Your phone is in standby mode.	You receive the Walkie-Talkie call, Talkgroup call, or Call Alert, along with an appropriate notification. They are listed in Call History.
Your phone is on a phone call.	You receive notification of a missed Walkie-Talkie call, Call Alert, or Talkgroup call and they are listed in Call History. After you finish the phone call, the missed Call Alert is displayed.
You are on a Walkie-Talkie call.	Your phone does not display a notice for incoming Walkie-Talkie calls, Talkgroup calls, or Call Alerts. Walkie-Talkie calls, Talkgroup calls, and Call Alerts are not listed in Call History.
Your phone is in a data session, but you are not transmitting data.	Your phone displays a notice for incoming Walkie-Talkie calls and Talkgroup calls. If you receive a Call Alert, your phone displays the alert. It records these events in Call History.
Your phone is in a data session and you are transmitting data.	Your phone does not display a notice for incoming Walkie-Talkie calls, Talkgroup calls, or Call Alerts as long as you are actively transmitting data. It records these events in Call History. After you finish transmitting, your phone notifies you of these events.

## **Nextel Group Walkie-Talkie Calls**

Your phone does not display an incoming call notification for Group Walkie-Talkie calls. It does display the calls in the Call History.

## **Nextel Direct Talk**

Because Code calls do not take place on the network, your phone does not track them. However, you do receive notification of Private calls and they are listed in Call History.



# Controlling Your Phone's Settings

---

## In This Section

---

- ◆ Sound Settings
  - ◆ Display Settings
  - ◆ Location Settings
  - ◆ Messaging Settings
  - ◆ Airplane Mode
  - ◆ TTY Use
  - ◆ Phone Setup Options
  - ◆ Nextel Walkie-Talkie Settings
- 

Using the menu options available on your phone, you can customize your phone to sound, look, and operate just the way you want it. This section describes how you can change your phone's settings to best suit your needs. Take a few moments to review these options and to adjust or add settings that are right for you.

# Sound Settings

---

## Ringer Types

Ringer types help you identify incoming calls and messages. You can assign ringer types to individual Contacts entries, types of calls, and types of messages.

- **Preprogrammed Ringers** include a variety of standard ringer types and familiar music included with your phone.
- **Vibrating Ringer** alerts you to calls or messages without disturbing others.
- **Downloaded Ringers** can be downloaded right to your phone.

## Selecting Ringer Types for Phone Calls

Your phone provides a variety of settings that allow you to customize your ringer and volume settings. These options allow you to identify incoming calls by ring.

To select a ringer type for voice calls:

1. Press **[OK]** > **Settings/Tools** > **Settings** > **Sounds** > **Ringer Type** > **Ringer**.
2. Select **Call with ID** or **Call without ID** and press **[OK]**.
3. Select **In Phone**, **External Memory**, **Assigned Media**, or **New Voice Recording**. (The list of available ringers is displayed.)
4. Use your navigation keys to scroll through the available ringers. To hear a ringer, press **Listen** (left softkey).
5. Press **[OK]** or **Assign** (left softkey) to assign the ringer.

**Tip:**

If you want to hear a unique ringer whenever you are roaming, you can press **[OK]** > **Settings/Tools** > **Settings** > **Sounds** > **Ringer Type** > **Roam Ringer** and choose **Distinct**. For information about roaming, see page 105.

## Selecting Ringer Types for Messages

To select a ringer type for messages:

1. Press **[Menu]** > **Settings/Tools** > **Settings** > **Sounds** > **Ringer Type** > **Messaging**.
2. Select **Text Message**, **Voice SMS**, **Picture Mail**, or **Voicemail**.
3. Select **In Phone**, **External Memory**, **Assigned Media**, or **New Voice Recording**. (The list of available ringers is displayed.)
4. Use your navigation keys to scroll through the available ringers. To hear a ringer, press **Listen** (left softkey).
5. Press **[Menu]** or **Assign** (left softkey) to assign the ringer.

**Tip:** You can also select unique ringers for Call Alerts, calendar appointments, and alarms. Go to **[Menu]** > **Settings/Tools** > **Settings** > **Sounds** > **Ringer Type** > **[category]** and follow the prompts.

## Selecting Ringer Types for Calendar and Alarm

To select a ringer type for calendar appointments and alarms:

1. Press **[Menu]** > **Settings/Tools** > **Settings** > **Sounds** > **Ringer Type** > **Calendar** or **Alarm**.
2. Select **In Phone**, **External Memory**, **Assigned Media**, or **New Voice Recording**. (The list of available ringers is displayed.)
3. Use your navigation keys to scroll through the available ringers. To hear a ringer, press **Listen** (left softkey).
4. Press **[Menu]** or **Assign** (left softkey) to assign the ringer.

## Adjusting the Phone's Volume Settings

You can adjust your phone's volume settings to suit your needs and your environment.

To adjust your phone's volume settings:

1. Press **[OK]** > **Settings/Tools** > **Settings** > **Sounds** > **Volume**.
2. Select **Ringer, Messaging, Alarm, Key Beep, or Advanced**, and press **[OK]**.
3. If you selected **Advanced**, you can then select **Applications, Calendar, Call Alert, Connected Call, Incoming W-T, Power On, and Speaker Phone**.
4. Follow the prompts to choose a volume level and press **Done** (left softkey).

To adjust the ringer, open your phone and use the volume keys to set the desired level of sound. However, if you are on a call, pressing the volume keys regulates the sound of the call. In this case, you can use the volume keys regardless of whether the phone is opened or closed.

### Tip:

To reset your volume setting to factory defaults, press **[OK]** > **Settings/Tools** > **Settings** > **Sounds** > **Volume** > **Reset Volumes**.

## Sound Indicators

Your phone can alert you with an audible tone when you change service areas, once a minute during a voice call, or when a call has been lost or connected.



To enable or disable alert sounds:

1. Press **[OK]** > **Settings/Tools** > **Settings** > **Sounds** > **Indicators**.
2. Select **Service (Service Change), Minute Beep, Call Lost, Connect (Call Connect), or New Message** and press **[OK]**.
3. Select **On** or **Off** and press **[OK]**.

## Key Tones

You can set the duration of key tones whenever you press a key.

To set your key tone length:

1. Press  > **Settings/Tools** > **Settings** > **Sounds** > **Key Tone Length**.
2. Select **Short** or **Long** and press .

## Display Settings

### Changing the Text Greeting

The text greeting can be up to 12 characters and is displayed on your phone's screen in standby mode. You may choose to keep the phone's default greeting, or you may enter your own custom greeting.

To display or change your greeting:

1. Press  > **Settings/Tools** > **Settings** > **Display** > **Foregrounds** > **Greeting Banner**.
2. To change the greeting text, scroll to the greeting and enter text using your keypad.
3. Press **Save** (left softkey).

**Tip:**



If you don't want to display a greeting banner, press and hold  to remove the text and then press **Save** (left softkey).

## Setting Light Controls

You can determine whether, and for how long, to light the display screen, keypad, Walkie-Talkie button, or status light.

### Status Light or Walkie-Talkie Button Light



To turn on or off the status light or the light behind the Walkie-Talkie button:

1. Press  > **Settings/Tools** > **Settings** > **Display** > **Light Control** > **Status Indicator** or **Walkie Talkie Key**.
2. Select **On** or **Off**, as desired.
3. Press .

### Backlight

The Backlight Control setting lets you select for how long the display screen is backlit.



To change the backlight setting:

1. Press  > **Settings/Tools** > **Settings** > **Display** > **Light Control** > **Screen Backlight Control**.
2. Select how long the backlight should stay on. (If you choose **Always On**, the backlight stays on as long as the phone is open.)
3. Press .

### Keypad Light Sensor

Your phone's Keypad Light Sensor measures available light and determines if the keypad backlight needs to be turned on. If you turn Keypad Light Sensor on, the keypad is lit only when it is needed. If you turn Keypad Light Sensor off, the keypad stays lit whenever you are using your phone.

To set Keypad Light Sensor to measure ambient light:



1. Press  > **Settings/Tools** > **Settings** > **Display** > **Light Control** > **Keypad Light Sensor**.
2. Highlight **On**.
3. Press .

**Note:** Setting long light durations affects the life of the battery.

## Changing the Phone's Menu Style

Your phone allows you to choose how the menu appears on your display screen.



To select the display screen's menu style:

1. Press  > **Settings/Tools** > **Settings** > **Display** > **Menu Style**.
2. Select **Grid Menu**, **List Menu**, or **Tab Menu**, and then press .
  - **Grid Menu** shows the main menu as icons only.
  - **List Menu** shows the main menu as a list of icons and names.
  - **Tab Menu** shows just the selected menu, with the remaining icons displayed as tabs. Use the left and right navigation keys to find the menu you want.

## Changing the Clock Display

Choose whether you want your phone's clock to be displayed in analog mode or digital mode.

To change the clock's appearance on the standby screen:

1. Press  > **Settings/Tools** > **Settings** > **Display** > **Foregrounds** > **Clock**.
2. Select **Analog** or **Digital**, then press . (Select **Hide** if you do not want to display the clock.)

## Changing Other Display Settings

Your Motorola Deluxe ic902 phone offers you many different ways to customize your display screen.

To change additional display settings:

1. Press **[OK]** > **Settings/Tools** > **Settings** > **Display**.
2. Select the display option you want to change. (See below for a list of options.)
3. Follow the prompts to make your choice.
4. Press **[OK]** to save your settings.

<b>Screensaver</b>	Allows you to choose the image on your standby screen.
<b>Themes</b>	Allows you to choose the look of screens throughout your phone.
<b>Foregrounds</b>	Controls aspects of how your phone's display looks in standby mode.
<b>Light Control</b>	Controls how some lighted parts of your phone behave.
<b>Menu</b>	Allows you to set your main menu to appear as a grid of icons, a list, or as tabs.
<b>Assign Keys</b>	Allows you to assign a short cut to each part of the navigation key and to the Walkie-Talkie key.
<b>Time and Date</b>	Determines how the display screen shows the time (12 or 24 hour) and the date formats.
<b>Incoming Calls</b>	Allows you to assign different images to calls with IDs and calls without IDs.





# Location Settings



Your phone is equipped with a Location feature for use in connection with location-based services.

The Location feature allows the network to detect your position. Turning Location off hides your location from everyone except 911.

<b>Note:</b>	Turning Location on allows the network to detect your position using GPS technology, making some applications and services easier to use. Turning Location off disables the GPS location function for all purposes except 911, but does not hide your general location based on the cell site serving your call. No application or service may use your location without your request or permission. GPS-enhanced 911 is not available in all areas.
--------------	--

To enable your phone's Location feature:

1. Press  > **Settings/Tools > Settings > Location**. (The Location disclaimer is displayed.)
2. Read the disclaimer and press .
3. Select **On** or **Off**, and then press .

When the Location feature is on, your phone's display screen displays the  icon. When Location is turned off, the  icon is displayed.

# Messaging Settings

---

Staying connected to your friends and family has never been easier. With your phone's advanced messaging capabilities, you can send and receive text messages without placing a voice call. (See "SMS Text Messages" on page 81, and "SMS Voice Messages" on page 83 for more information.)



Your phone's messaging settings make text messaging even faster and easier by letting you decide how you would like to be notified of new messages and what callback number to include with your message. Your phone can automatically adding a custom signature to each message. You can even create your own preset messages.

## Setting Message Alerts

When new messages arrive, you can choose to have your phone notify you by playing an audible alert. You can choose different alerts for Text Messages, SMS Voice, and Picture Mail. See "Ringer Types" on page 72.

You can also set your phone to notify you of a new message by displaying an icon on your display screen. You can also choose to be notified with a larger pop-up notification on your display screen.

To set how your phone notifies you of an incoming message:

1. Press  > **Messaging** > **Settings**.
2. Highlight the **Notification** field.
3. Select **Msg and Icon** or **Icon only** and press .

## SMS Text Messages

### Auto-Signing for Text Messages

You can choose to have your phone automatically add your name to each text message or a custom signature created by you to reflect your personality.

To add a signature to each sent message:

1. Press **[OK]** > **Messaging** > **Settings** > **Text Messaging**.
2. Highlight the **Add Signature** field.
3. To have your phone add your name to each text message, select **On**.  
— or —  
To have your phone add a custom signature to each text message, select **Change Signature**, enter the closing you want to use, and press **Save** (left softkey).

### Automatically Adding a Callback Number

You can choose to have your phone automatically add, to each text message, a number where you can be reached. This can be your own phone number or another number.

To add a callback number to each sent message:

1. Press **[OK]** > **Messaging** > **Settings** > **Text Messaging**.
2. Highlight the **Callback Number** field.
3. To have your phone number added to each text message, select **My Phone Number**.  
— or —  
To have your phone add another number, select **Other**, enter the new number, and press **OK** (left softkey).

## Managing Preset Messages

Your phone is programmed with 15 preset messages to help make sending text messages faster and easier. These messages, such as “Let’s get lunch” and “Meet me at,” can be customized or deleted to suit your needs. You can also add your own preset messages to the list.

### To edit a preset message:

1. Press **[Menu]** > **Messaging** > **Text Messaging** > **Preset Messages**. (The list of preset messages is displayed.)
2. Select the preset message you want to edit.
3. Press **Edit** (left softkey).
4. Use your keypad to edit the selected message and press **Save** (left softkey).

### To delete a preset message:

1. Press **[Menu]** > **Messaging** > **Text Messaging** > **Preset Messages**. (The list of preset messages is displayed.)
2. To delete a preset message, highlight it and press **Options** (right softkey).
3. Select **Delete** to delete the selected message.

### To add a new preset message:

1. Press **[Menu]** > **Messaging** > **Text Messaging** > **Preset Messages**.
2. Press **Options** (right softkey) and select **Create New**.
3. Use your keypad to edit the selected message and press **Save** (left softkey).

Your new message is added to the beginning of the list.



## SMS Voice Messages

You can customize the way you use SMS Voice messages. You can set your SMS Voice messages to always play in speakerphone mode. You can also set your phone to add a name to each SMS Voice message.

To set your SMS Voice messages to play in speakerphone:

1. Press  > **Messaging** > **Settings** > **Voice SMS**.
2. Highlight **Speaker Phone** and then press .
3. Select **On**.

To assign a name to your SMS Voice messages:



1. Press  > **Messaging** > **Settings** > **Voice SMS**.
2. Highlight **From Name** and then press .
3. Use your keypad to enter the name you want to attach to your SMS Voice messages.
4. Press **Save** (left softkey).

# Airplane Mode

---

Airplane Mode allows you to use many of your phone's features, such as Games, Calendar, Voice Records, etc., when you are in an airplane or in any other area where making or receiving phone calls, Walkie-Talkie calls, or using data services is prohibited. When your phone is in Airplane Mode, it cannot send or receive any phone calls, Walkie-Talkie calls, or access online information.

To set your phone to Airplane Mode:

1. Press  > **Settings/Tools** > **Settings** > **Others** > **Airplane Mode**.
2. Select **On**, **Off**, or **On at Power Up** and press .

While in Airplane Mode, your phone's standby screen displays  and **No Service**.





**Note:**

Selecting **On at Power Up** enables Airplane Mode only the next time you power up. Afterwards, your phone will power up normally.

# TTY Use

A TTY (also known as a TDD or Text Telephone) is a telecommunications device that allows people who are deaf, hard of hearing, or who have speech or language disabilities, to communicate by telephone.

Your phone is compatible with select TTY devices. Please check with the manufacturer of your TTY device to ensure that it supports digital wireless transmission. Your phone and TTY device connects via a special cable that plugs into your phone's headset jack. If this cable was not provided with your TTY device, contact your TTY device manufacturer to purchase the connector cable.

When establishing your wireless service, please call Sprint Customer Service via the state Telecommunications Relay Service (TRS) by first dialing    . Then provide the state TRS with this number: 866-727-4889.

To turn TTY Mode on or off:

1. Press  > **Settings/Tools** > **Settings** > **Others** > **TTY**.
2. If TTY is on, select **Off**.  
– or –  
If TTY is off, select **TTY**, **VCO**, or **HCO**.

**Note:**

In TTY Mode, your phone displays the TTY access icon.

If TTY mode is enabled, the audio quality of non-TTY devices connected to the headset jack may be impaired.

**WARNING****911 Emergency Calling**

Sprint recommends that TTY users make emergency calls by other means, including Telecommunications Relay Services (TRS) and landline communications. Wireless TTY calls to 911 may be corrupted when received by public safety answering points (PSAPs) rendering some communications unintelligible. The problem encountered appears related to TTY equipment or software used by PSAPs. This matter has been brought to the attention of the FCC, and the wireless industry and PSAP community are currently working to resolve this.

## Phone Setup Options

---



### Shortcuts

Your phone offers you the option of assigning shortcuts to favorite or often-used functions. Pressing the navigation keys up, down, left, or right in standby mode launches your designated shortcuts.

**Note:**

You also can assign the One-Touch Walkie-Talkie option to the Walkie-Talkie button from this menu. See “Enabling One Touch Walkie-Talkie” on page 90 for a description of the settings.

To assign your shortcuts:

1. Press  > **Settings/Tools > Settings > Display > Assign Keys.**
2. Select the navigation key direction and press .
3. Select the desired shortcut and press .



**Tip:**



You can choose to show or hide the navigation keys on your screen. Go to  > **Settings/Tools > Settings > Display > Foregrounds > Navigation Key Display** and select **Hide** or **Show**.

Even if you hide the shortcuts, you can still use them by pressing the appropriate navigation key.

## Call Answer Mode

You can determine how to answer incoming calls on your phone, whether by pressing , pressing any number key, or simply by opening the phone.



To set call answer mode:

1. Press  > **Settings/Tools > Settings > Others > Call Setup > Answer Options**.
2. To select an option, highlight it and press .
  - **Any Key** allows an incoming call to be answered by pressing any key.
  - **Auto** automatically picks up incoming calls when connected to an optional hands-free car kit. Remember, your phone answers calls in Auto-Answer mode even if you are not present.
  - **Open** allows an incoming call to be answered by opening the phone.
  - **TALK Key** allows an incoming call to be answered only by pressing .

## Calling Options

You can set up your phone to make dialing numbers even quicker and easier.

To set special options to making dialing easier:



1. Press  > **Settings/Tools** > **Settings** > **Others** > **Call Setup**.
2. Select the calling option you want to use. (See below for a list of options.)
3. Follow the prompts to make your choice.
4. Press  to save your settings.

<b>Speed Dial</b>	Allows you to dial entries using just one or two key presses.
<b>Abbreviated Dial</b>	Allows you to dial numbers sharing the same beginning digits by dialing only the last four. You need to enter the first six digits you want to prepend – for example, the area code and prefix.
<b>Auto Redial</b>	Redials a number if a call did not connect as a result of network difficulties.
<b>Auto Answer</b>	Automatically picks up incoming calls when connected to an optional hands-free car kit. (Auto-Answer picks up calls even if you are not present.)

## Display Language

You can choose to display your phone's menus in English or in Spanish.

To assign a language for the phone's display:

1. Press  > **Settings/Tools** > **Settings** > **Others** > **Language**.
2. Select **English** or **Español** and press .

## Voice Guide

You can enable your phone to read aloud the main menu, your Settings submenu, your Contacts entries, and the digits you are entering.

To set your Voice Guide options:

1. Press  > **Settings/Tools** > **Settings** > **Others** > **Voice Guide**.
2. Select **On**, **Off**, or **Custom**.
3. If you selected Custom in step 2, highlight the field you wish to set and select **On**.
  - **Main Menu** — Your phone reads aloud items on the main menu as you scroll through them.
  - **Settings** — Your phone reads aloud items on the Settings submenus as you scroll through them.
  - **Contact** — Your phone reads aloud the names of your entries as you scroll through them.
  - **Digits** — Your phone reads back each digit after you enter it.

# Nextel Walkie-Talkie Settings



---

Your phone offers you ways to manage your Nextel Walkie-Talkie calls. You may want to consider these options.

- **One Touch Walkie-Talkie** lets you quickly access frequently used functions with a press of the Walkie-Talkie button.
- **Talkgroup Silent** controls whether you hear active Talkgroup calls.
- **Talkgroup Area** lets you define your Talkgroup area.

## Enabling One Touch Walkie-Talkie

To enable One Touch Walkie-Talkie:

1. Press  > **Settings/Tools** > **Settings** > **Walkie Talkie** > **One Touch W-T**.
2. Select **Enable** by pressing . (The **Enable** check box may already be selected.)
3. Highlight **Assign To**, press , and then select one of these options.
  - **Last Call** allows you to call the last Walkie-Talkie call you made.
  - **W-T Contacts** takes you to the Walkie-Talkie Contacts list.
  - **Call History** takes you to the Walkie-Talkie list in Call History.
  - **Assigned Number** allows you call a specific number. (You are prompted to enter the number if you choose this option. You can also press **Search** [right softkey] and select **Contacts** or **Call History** to select a number to assign.)
4. Press **Done** (left softkey).

## Silencing Talkgroup Calls

When you join a Talkgroup, you hear all the conversations among the different members. To mute the chatter, enable the Talkgroup Silent setting.

To set how your phone deals with Talkgroup calls:

- ▶ Press  > **Settings/Tools** > **Settings** > **Walkie-Talkie** > **Talkgroup Silent** > **On** or **Off**.

## Setting Your Talkgroup Area

To set your Talkgroup area:

1. Press  > **Settings/Tools** > **Settings** > **Walkie-Talkie** > **Talkgroup Area**.
2. Scroll and highlight one of the following options:
  - **Wide Area** — to communicate with members inside and outside your Local Area.
  - **Local** — to communicate only with members within your predefined community.
  - **New Area** — to communicate with a custom set of members.
3. Follow the prompts to make your choice.
4. Press **Save** (left softkey).

# Setting Your Phone's Security

---

## In This Section

---

- ◆ Accessing Your Security Menu
  - ◆ SIM Card Security
  - ◆ Using Your Phone's Lock Feature
  - ◆ Limiting Use of Your Phone
  - ◆ Erasing Data
  - ◆ Resetting Your Phone
  - ◆ Security Features for Sprint Power Vision
- 

**By using the security settings on your phone, you receive peace of mind without sacrificing flexibility.** This section will familiarize you with your phone's security settings. With several options available, you can customize your phone to meet your personal needs.

## Accessing Your Security Menu

---

All of your phone's security settings are available through the Security menu. You must enter your lock code to view the Security menu.

To access the Security menu:

1. Press  > **Settings/Tools** > **Settings** > **Security**.
2. Enter your four-digit lock code.

**Tip:**

If you can't recall your lock code, try using the last four digits of your wireless phone number. If this doesn't work, call Sprint Customer Service.

## SIM Card Security

---

**Important:**

Except for making emergency calls, your phone does not function without the SIM card.

You can use your SIM card to store Contacts entries. When you first create an entry, it is stored in your phone. You can use your phone's SIM Manager to copy the entry to your SIM card. You can also copy entries from your SIM card to your phone. See "Using Your SIM Manager" on page 133 for more information.

### SIM Card's PIN

You can protect access to your phone by using the SIM card's PIN (Personal Identification Number). When you enable SIM PIN, you must enter the PIN each time you power up the phone. You can change or disable the SIM PIN.

## Turning SIM PIN On and Off

To turn SIM PIN on or off:

1. Press  > **Settings/Tools** > **Settings** > **Security**.
2. Enter your lock code. (The Security menu is displayed.)
3. Select **SIM PIN**.
4. Select **On** or **Off**.
5. Enter the current SIM PIN.

**Tip:**

The default SIM PIN is 0000. Change your PIN to prevent fraudulent use of the SIM Card.

6. Press **OK** (left softkey).

## Entering the PIN

To enter your PIN:

1. Turn on your phone.
2. When the **SIM PIN** screen appears, enter your SIM PIN.
3. Press **OK** (left softkey).

**Important:**

If you enter your PIN incorrectly three times, your SIM card is blocked. See "Unlocking the PIN" on page 95.

## Changing the PIN

**Note:**

SIM PIN must be turned on in order to access this feature.

To change your PIN:

1. Press  > **Settings/Tools** > **Settings** > **Security**.
2. Enter your lock code. (The Security menu is displayed.)
3. Select **SIM PIN Code**.
4. Enter the current SIM PIN and press **OK** (left softkey).



5. Enter the new SIM PIN and press **OK** (left softkey).
6. Reenter the new SIM PIN to confirm.
7. Press **OK** (left softkey).

## Unlocking the PIN

If you enter your PIN incorrectly three times, your SIM card is blocked. To unblock your SIM card, you must contact Sprint Customer Service to get a PIN Unblock Code (PUK). Follow their instructions for unblocking your SIM PIN

<b>Important:</b>	If you unsuccessfully enter the PUK code 10 times, your SIM card is permanently blocked and must be replaced. If this happens, you get a message to contact Sprint Customer Service. Except for making emergency calls, your phone does not function with a blocked SIM card.
-------------------	---



# Using Your Phone's Lock Feature

---

## Locking Your Phone

Locking your phone secures it from unauthorized access. However, you can still receive incoming calls or make calls to 911, Sprint Customer Service, or special numbers.

To lock your phone:

1. Press  > **Settings/Tools** > **Settings** > **Security**.
2. Enter your lock code. (The Security menu is displayed.)
3. Select **Lock Phone**.
4. Highlight **Lock Now**, **Lock on Power Up**, or a time interval and press .

## Unlocking Your Phone

To unlock your phone:

1. From standby mode, press **Unlock** (left softkey).
2. Enter your lock code.

## Changing the Lock Code

To change your lock code:

1. Press  > **Settings/Tools** > **Settings** > **Security**.
2. Enter your lock code. (The Security menu is displayed.)
3. Select **Lock Code**.
4. Enter your new lock code.
5. Re-enter your new lock code.

## Calling In Lock Mode

You can place calls to 911, Sprint Customer Service, and to your special numbers when in lock mode.



To place an outgoing call in lock mode:

- ▶ To call an emergency number, special number, or Sprint Customer Service, enter the phone number and press .

## KeyGuard

Your phone's KeyGuard feature protects against activating keys accidentally. When you turn on KeyGuard, your phone requires you to press and hold **External Camera Key** and the volume key before you can start using your phone. You can determine whether your phone activates KeyGuard or not, and how long the phone waits after you last use your phone before activating KeyGuard.

To enable or disable KeyGuard:

1. Press  > **Settings/Tools** > **Settings** > **KeyGuard**.
2. Press  and then select **Now**, **1 min**, **3 min**, **5 min**, or **Off** as desired.

## Using Special Numbers

Special numbers are important numbers that you have designated as being “always available.” You can call and receive calls from special numbers even if your phone is locked.

Your phone can store up to three special numbers. These numbers are stored separately from your Contacts entries, and the same numbers may appear in both your Contacts and your Special Numbers.

To add or replace a special number:

1. Press  > **Settings/Tools** > **Settings** > **Security**.
2. Enter your lock code. (The Security menu is displayed.)
3. Select **Special Numbers**.
4. Select a location for your entry.
5. Enter the number and press **Save** (left softkey).

**Note:** You cannot assign speed dial numbers to special numbers.

## Limiting Use of Your Phone

---



Limiting use of your phone protects specific parts of your phone from unauthorized use. You determine what is off-limits to other users.

For example, you can set limitations before you loan your phone to someone, then turn the limitations off when you get your phone back.

You can limit access to Contacts, Sprint Power Vision Services, and Pictures. You can limit access to Contacts and data services. You can also restrict incoming and outgoing phone calls as well as Walkie-Talkie calls.



## Limiting Access to Contacts

To limit access to your Contacts:

1. Press  > **Settings/Tools** > **Settings** > **Security**.
2. Enter your lock code. (The Security menu is displayed.)
3. Select **Limit Use** > **Contacts**.
4. Choose one of the following options and press :
  - **Unlock** clears all limitations.
  - **Lock** asks users to enter your lock code whenever they select **Contacts**.
  - **View Only** lets users view your **Contacts**, but asks them to enter your lock code before they edit them.



## Limiting Web Access

To limit access to the Web:

1. Press  > **Settings/Tools** > **Settings** > **Security**.
2. Enter your lock code. (The Security menu is displayed.)
3. Select **Limit Use** > **Data Services**.
4. Choose one of the following options and press :
  - **Unlock** clears all limitations.
  - **Lock** asks users to enter your lock code whenever they select **Web** or try to launch the browser.



## Limiting Access to Pictures & Videos

To limit access to your pictures and videos:

1. Press  > **Settings/Tools** > **Settings** > **Security**.
2. Enter your lock code. (The Security menu is displayed.)
3. Select **Limit Use** > **Pictures**.
4. Choose one of the following options and press :
  - **Unlock** clears all limitations.
  - **Lock** asks users to enter your lock code whenever they select **Pictures**.



## Limiting Outgoing Calls

To limit outgoing calls:

1. Press  > **Settings/Tools** > **Settings** > **Security**.
2. Enter your lock code. (The Security menu is displayed.)
3. Select **Limit Use** > **Restrict Outgoing Calls**.
4. Choose one of the following options and press :
  - **All** stops all outgoing calls.
  - **None** allows all calls.
  - **Except Contacts** allows outgoing calls only to people in the Contacts list.



## Limiting Incoming Calls

To limit incoming calls:

1. Press  > **Settings/Tools** > **Settings** > **Security**.
2. Enter your lock code. (The Security menu is displayed.)
3. Select **Limit Use** > **Restrict Incoming Calls**.
4. Choose one of the following options and press :
  - **All** stops all incoming calls.
  - **None** allows all calls.
  - **Except Contacts** allows incoming calls only from people in the Contacts list.

## Limiting Walkie-Talkie Calls

To limit Walkie-Talkie calls:

1. Press  > **Settings/Tools** > **Settings** > **Security**.
2. Enter your lock code. (The Security menu is displayed.)
3. Select **Limit Use** > **Restrict W-T Calls**.
4. Choose one of the following options and press :
  - **All** stops all Walkie-Talkie calls.
  - **None** allows all Walkie-Talkie calls.

## Erasing Data

---

You can use your phone's Security menu to erase all entries in your Contacts, all items in My Content, all voice record, all items in Pictures, or all messages from your phone.

To erase all items of a certain type:

1. Press  > **Settings/Tools** > **Settings** > **Security**
2. Enter your lock code. (The Security menu is displayed.)
3. Select **Manage Applications**.
4. Select the type of item you want to erase.
5. If you are sure you wish to erase all these items, press **Yes** (left softkey).

## Resetting Your Phone

---

You can reset some or all of your settings to their factory or service defaults.

- **Browser** – Erases your browser history, Bookmarks, cookies, recent lists, auto-complete text, and URLs.
- **Favorites** – Restores all Favorites to their factory defaults.
- **Personal Dictionary** – Restores all your Personal Dictionary to its factory defaults.
- **All Settings** – Restores all phone settings to their factory defaults.
- **Walkie Talkie Service** – Allows Sprint Customer Service to reset your Nextel Walkie-Talkie service in the event of a security or provisioning issue.
- **Phone Reset** – Deletes all items in Contacts, My Content, Voice Records, Pictures, and Messages, and resets Nextel Walkie-Talkie Services.



To reset your phone:

1. Press  > **Settings/Tools** > **Settings** > **Security**.
2. Enter your lock code. (The Security menu is displayed.)
3. Select **Reset Settings**.
4. Select the option you want.
5. If you are sure you wish to reset the selected option, press **Yes** (left softkey).

## Security Features for Sprint Power Vision

---

### Enabling and Disabling Sprint Power Vision Services

You can disable Sprint Power Vision services without turning off your phone; however, you will not have access to all Sprint Power Vision services, including Web and messaging. Disabling Sprint Power Vision will avoid any charges associated with Sprint Power Vision services. While signed out, you can still place or receive phone calls, check voicemail, and use other voice services. You may enable Sprint Power Vision services again at any time.

To enable or disable Sprint Power Vision services:

1. Press  > **Settings/Tools** > **Settings** > **Data Services** > **Data Services**.
2. Select **Off** to disable or **On** to enable.

## Net Guard

The Net Guard option prompts you each time you connect to Sprint Power Vision. When you access the browser, a screen is displayed with two choices:

- **Connect** to Sprint Power Vision once. (You will be prompted again the next time you sign in.)
- **Always Auto-Connect** to Sprint Power Vision from now on without being prompted.

You can change your Net Guard settings at any time.

To change your Net Guard settings:

1. Press  > **Settings/Tools > Settings > Data Services > Net Guard.**
2. Select **Off** or **On**.

## Update Vision Profile

Your data profile manages your user name and login information and allows you to connect to the Sprint Power Vision Network. It may be necessary to update your profile to maintain peak efficiency.

To update your profile:

- ▶ Press  > **Settings/Tools > Settings > Data Services > Data Services Profile > Update.**

Your phone will connect to the browser and update your data profile. When the update is finished, the phone returns to standby mode.

# Controlling Your Roaming Experience

---

## In This Section

---

- ◆ Understanding Roaming
  - ◆ Setting Your Phone's Roam Mode
  - ◆ Alerting Yourself to Roaming
  - ◆ Using Data Roam Guard
- 

**Roaming is the ability to make or receive phone calls when you're off the Nationwide Sprint PCS Network.** Your new Motorola Deluxe ic902 phone works anywhere on the Nationwide Sprint PCS Network and allows you to roam on other networks where we've implemented roaming agreements with other carriers. (Nextel Walkie-Talkie calls are allowed anywhere on the Nextel National Network.)

This section explains how roaming works as well as special features that let you manage your roaming experience.

# Understanding Roaming

---

## Recognizing the Roaming Icon on the Display Screen

Your phone's display screen always lets you know when you're off the Nationwide Sprint PCS Network. Any time you are roaming, the phone displays the roaming icon ()

<b>Tip:</b>	Remember, when you are using your phone off the Nationwide Sprint PCS Network, always dial numbers using 11 digits (1 + area code + number).
-------------	--

<b>Note:</b>	Unless your service plan includes roaming, you will pay a higher per-minute rate for roaming calls.
--------------	---

## Roaming on Other Digital Networks

When you're roaming on digital networks, your call quality and security will be similar to the quality you receive when making calls on the Nationwide Sprint PCS Network. However, you may not be able to access certain features, such as the browser or Messaging.

<b>Note:</b>	If you're on a call when you leave the Nationwide Sprint PCS Network, your call is dropped. If your call is dropped in an area where you think Sprint service is available, turn your phone off and on again to reconnect to the Nationwide Sprint PCS Network.
--------------	---

## Checking for Voicemail Messages While Roaming

When you are roaming off the Nationwide Sprint PCS Network, you may not receive on-phone notification of new voicemail messages. Callers can still leave messages, but you will need to periodically check your voicemail for new messages if you are in a roaming service area for an extended period of time.

**To check your voicemail while roaming:**

1. Dial 1 + area code + your phone number.
2. When you hear your voicemail greeting, press .
3. Enter your passcode at the prompt and follow the voice prompts.

# Setting Your Phone's Roam Mode



---

Your phone allows you to control your roaming capabilities. By using the **Roaming** menu option, you can determine which signals your phone accepts.

## Set Mode

Choose from three different settings to control your roaming experience.

To set your phone's roam mode:

1. Press  > **Settings/Tools** > **Settings** > **Roaming** > **Set Mode**.
2. To select an option, highlight it and press .
  - **Sprint Only** allows you to access the Nationwide Sprint PCS Network only and prevents roaming on other networks.
  - **Automatic** seeks Sprint service. When Sprint service is unavailable, the phone searches for an alternate system.
  - **Roaming Only** forces the phone to seek a roaming system. The previous setting (Sprint Only or Automatic) is restored the next time the phone is turned on.



# Alerting Yourself to Roaming

Your phone has three ways of alerting you when you are roaming off the Nationwide Sprint PCS Network: the on screen roaming icon, a special ringer you can set for calls you receive when roaming, and Call Guard.

## Using the Roam Ringer

The Roam Ringer feature allows you to set your phone to use a distinct ringer when you receive calls while roaming off the Nationwide Sprint PCS Network.



To set the Roam Ringer:

1. Press  > **Settings/Tools** > **Settings** > **Sounds** > **Ringer Type** > **Roam Ringer**.
2. Highlight **Distinct** to give your incoming roaming calls a distinct ringer. Highlight **Normal** to give incoming roaming calls a ringer that is not distinct from the calls you receive when you are on the Nationwide Sprint PCS Network.
3. Press .

## Using Call Guard

Call Guard makes it easy to manage your roaming charges by requiring an extra step before you can place or answer a roaming call. (This additional step is not required when you make or receive calls while on the Nationwide Sprint PCS Network.)

To turn Call Guard on or off:

1. Press  > **Settings/Tools** > **Settings** > **Call Guard**.
2. Highlight **On** or **Off** and press .

**Note:** Speed dialing is not available when you are roaming with Call Guard enabled.

If the Call Guard feature is set to On, you need to take extra steps to make and receive roaming calls.

**To place roaming calls with Call Guard on:**

1. From standby mode, dial 1 + area code + the seven-digit number and press . (A message is displayed, informing you that you're making a roam call.)
2. Press **Yes** (left softkey) to place the call.

**To answer incoming roaming calls with Call Guard on:**



1. Press . (A message is displayed, notifying you that roaming charges apply.)
2. Press **Yes** (left softkey) to answer the call.

## Using Data Roam Guard

---

Data Roam Guard makes it easy to manage roaming charges incurred when accessing the Web through data services. Whenever you are outside the Nationwide Sprint PCS Network, Data Roam Guard alerts you to this and asks you whether you want to continue using the Web. (This additional step is not required when you connect to the Web while on the Nationwide Sprint PCS Network.)

**To turn Data Roam Guard on or off:**

1. Press  > **Settings/Tools** > **Settings** > **Roaming** > **Data Roam Guard**.
2. Highlight **Always Ask** or **Never Ask** and press .



# Managing Call History

---

## In This Section

---

- ◆ Viewing Call History
  - ◆ Phone Call History Options
  - ◆ Walkie-Talkie Call History Options
  - ◆ Erasing Call History
- 

**Call History keeps track of incoming and outgoing phone calls, missed phone calls, Nextel Walkie-Talkie calls, and Call Alerts.** This section guides you through accessing and making the most of your Call History.

# Viewing Call History

---

Call History makes returning phone and Walkie-Talkie calls, and responding to Call Alerts fast and easy. It lists the last 20 numbers (or Contacts entries) of phone calls you have made, received or missed. Call History also lists Walkie-Talkie calls, Group Walkie-Talkie calls, Talkgroup calls, Call Alerts, and Private Direct Talk calls.

Call History lists are continually updated as new numbers are added to the beginning of the list and the oldest entries are removed from the bottom of the list.

Your phone tracks and displays the call histories of phone calls, Walkie-Talkie calls, and Call Alerts differently.

Call History only records calls that occur while the phone is turned on. If a phone or Walkie-Talkie call is received while your phone is turned off, it does not appear in Call History.

## Tip:

You can also access Walkie-Talkie call history by pressing  > **Walkie-Talkie** > **W-T Contacts** > **Call History**. Your phone displays a filtered Call History list that only contains Walkie-Talkie numbers.



## Viewing the Call History of Phone Calls

## Note:

If you return a phone call from the voicemail menu, it does not appear in your phone's Outgoing Calls list.

Each entry contains the phone number (if it is available) and Contacts entry name (if the phone number is in your Contacts). Duplicate calls (same number and type of call) may only appear once on the list.

To view Call History entries for phone calls:

1. Press  > **Call History**.
2. Scroll left or right to select **All Calls, Walkie Talkie, Missed Calls, Incoming Calls, or Outgoing Calls**. Your phone calls are displayed in reverse chronological order.
3. To view additional details about a call, press .

If the caller is listed in your Contacts, your phone displays the name, number and time/date when the call occurred.

Press  to view the Contacts entry.

If the caller is not listed in your Contacts, your phone only displays the number and time/date when the call occurred.

## Viewing the Call History of Nextel Walkie-Talkie Calls and Call Alerts

Your phone tracks Walkie-Talkie calls, Group Walkie-Talkie calls, Talkgroup calls, and Call Alerts in the All Calls and Walkie-Talkie lists. They are identified by the following icons.



Walkie-Talkie call.



Group Walkie-Talkie call.



Talkgroup call.



Call Alert.

Like all items in the Call History lists, they remain listed until you delete them or until they reach the end of the list.

**Note:** The Walkie-Talkie list contains outgoing, incoming, and missed Walkie-Talkie calls as well as sent and received Call Alerts.

You cannot view Walkie-Talkie calls or Call Alerts on the Missed Calls, Incoming Calls, or Outgoing Calls lists. These only contain phone calls.



### To view Walkie-Talkie calls on the All Calls list:

- ▶ Press  > **Call History** and scroll to **All Calls**. The calls are listed in reverse chronological order, with Walkie-Talkie calls and Call Alerts mixed in with the phone calls.

### To view Walkie-Talkie calls on the Walkie-Talkie list:

- ▶ Press  > **Call History** and scroll to **Walkie Talkie**. Your Walkie-Talkie calls and Call Alerts are displayed in reverse chronological order.

### To view details about a Walkie-Talkie call or Call Alert:

1. Press  > **Call History** and scroll to **All Calls** or **Walkie Talkie**.
2. Scroll through the calls listed and highlight the item you want contact information on.
3. To view additional details about a call, press .

If the caller is listed in your Contacts, your phone displays the name, number and time/date when the call occurred. Press  to view the Contacts entry.

If the caller is not listed in your Contacts, your phone only displays the number and time/date when the call occurred. If the caller sent you their contact information, press your right navigation key to view it.

**Note:** The All Calls and Walkie-Talkie lists also display Private Direct Talk calls. However, in the case of Private calls, the call detail contains the wireless phone number, not the Walkie-Talkie number.

# Phone Call History Options

This feature displays the date and time of the call, the phone number (if available), and the caller's name (if the number is already in your Contacts). By highlighting a Call History entry and pressing **Options** (right softkey), you can select from the following options:

- **Save** to save the number if it is not already in your Contacts. This option only appears when the caller is not listed in Contacts. (See “Saving a Phone Number From Call History” on page 116.)
- **View Contact** to view the Contacts entry for the number. This option only appears when the caller is listed in Contacts.
- **Delete** to delete the entry.
- **Delete All** to erase all the entries in the Call History list you are viewing.
- **Hide My Number** to hide your Caller ID number for the next call.
- **Prepend** to add numbers to the beginning of the selected number.
- **Select Mult** to select multiple entries.

You can send a text message to a number in a Call History entry by highlighting the entry and pressing **Send MSG** (left softkey).

## Making a Phone Call From Call History

To place a phone call from Call History:



1. Press **[Call]** > **Call History**.
2. Scroll left or right to select **All Calls**, **Incoming Calls**, **Outgoing Calls**, or **Missed Calls**.

3. Use your navigation keys to scroll to a Call History entry and press .

## Saving a Phone Number From Call History

Your phone can store up to 1000 numbers or electronic addresses. Individual Contacts entries can contain up to five separate phone numbers, a Walkie-Talkie number, an email address, and a Web address. (For more information, see “Using Contacts” on page 120.)

To save a phone number from Call History:

1. Select a Call History entry and press **Options** (right softkey).
2. Select **Save** and press .
3. Select **As New Entry** to create a new Contacts entry.  
– or –  
Select **To Existing Entry** and then scroll to the entry you want to save the number to.
4. Press .
5. Use the keypad to complete or edit the Contacts entry and press **Save** (left softkey).

## Prepending a Phone Number From Call History

If you need to make a call from Call History and you happen to be outside your local area code, you can add the appropriate prefix by prepending the number.

To prepend a phone number from Call History:

1. Select a Call History entry and press **Options** (right softkey).
2. Select **Prepend**.

3. Enter the prefix and press .  
– or –  
Press **Options** (right softkey) and then select **Save** to save the amended number to your Contacts.

## Walkie-Talkie Call History Options

After viewing a Walkie-Talkie call in the All Calls or Walkie-Talkie lists, you can select from the following options:

- **View Contact** to view the Contacts entry of the caller. This option only appears when the caller is listed in Contacts.
- **Save** to save information from a Walkie-Talkie call. This option only appears when the caller is not listed in Contacts. (See “Saving Walkie-Talkie Information From Call History” on page 118.)
- **Send Business Card** or **Send a Contact** to send your or another’s contact information to the Walkie-Talkie caller. (See “Sending Contact Information” on page 51 for more details.)
- **Delete** to delete the entry.
- **Delete All** to erase all the entries in the Call History list you are viewing.
- **Select Mult** to select multiple entries.

**Note:**

To send a Call Alert from Call History, see “Using Call Alerts” on page 66.

Your phone offers different options after viewing Private Direct Talk calls.

## Making a Walkie-Talkie Call From Call History

To place a Walkie-Talkie call from Call History:



1. Press  > **Call History** and scroll to **All Calls** or **Walkie Talkie**.
2. Scroll through the calls listed, highlight the Walkie-Talkie number you want to call.
3. Press and hold the Walkie-Talkie button and speak.

**Note:**

You cannot make Walkie-Talkie calls from Call History to entries with insufficient information.

## Saving Walkie-Talkie Information From Call History

To save Walkie-Talkie information from Call History:

1. Press  > **Call History** and scroll to **All Calls** or **Walkie Talkie**.
2. Scroll through the calls listed, highlight the Walkie-Talkie call you want to save to Contacts, and then press **Options** (right softkey).
3. Select **Save** and press .
4. Select **Add New Entry** to create a new Contacts entry – or –  
Select **To Existing Entry** and then scroll to the entry you want to save the number to.
5. Use the keypad to complete or edit the Contacts entry and press **Save** (left softkey).

After you have saved the number, the new Contacts entry is displayed.



# Erasing Call History

---

You can erase individual Call History lists or all of them at one time.

To erase Call History:

1. Press  > **Call History**.
2. Select the list you want to erase.
3. Press **Options** (right softkey) and select **Delete All**.
4. If you are certain you want to erase the list, press **Yes** (left softkey).  
– or –  
Press **No** (right softkey) to return to the previous menu.

# Using Contacts

---

## In This Section

---

- ◆ **About Contacts**
  - ◆ **Finding Contacts Entries**
  - ◆ **Creating a Contacts Entry**
  - ◆ **Contacts Entries for Walkie-Talkie Groups and Talkgroups**
  - ◆ **Managing Your Contacts**
  - ◆ **Using Your SIM Manager**
  - ◆ **Dialing Sprint Services**
  - ◆ **Using Wireless Backup**
- 

**Now that you know the basics that make it easier to stay in touch with people and information, you're ready to explore your phone's more advanced features.** This section explains how to use your phone's Contacts and helps you make the most of your time when you are trying to connect with the important people in your life.

# About Contacts

---

Your phone can store up to 1000 numbers or electronic addresses. Individual Contacts entries can contain up to five separate phone numbers, a Walkie-Talkie number, an email address, and a Web address.

The total capacity (numbers and electronic addresses) is 1000, meaning that if each Contacts entry has only one number or electronic address, you have space for 1000 Contacts entries.

Each number or electronic address you add to an individual entry reduces the remaining amount of available entries. For example, if you create 200 entries, each with three numbers for a total of 600 numbers, you only have space remaining for 400 entries with one number (or electronic address) each.

Each Contacts entry may contain:

- A name — The name of the person or organization whose contact information is stored in the entry. It is not required; you can create and store Contacts entries without a name.
- A number — This may be a phone number or Walkie-Talkie number. Each Contacts entry must contain a number or an electronic address.
- A picture — You can assign a picture to display whenever you receive a call from the Contacts entry.
- A ringer — You can assign a ringer to each entry. This is the sound your phone makes when you receive a call from any of the phone numbers stored in the entry.
- A category — You can category, such as Family, Friends, or Work to a entry. You can then sort you Contacts entries by category.

- An electronic address — This may be an email address or Web address. Each Contacts entry must contain a number or an electronic address.
- A memo — You can write a short note to yourself regarding the entry.
- Personal and business information — You can store a birthday, job title, company name, and street address with each entry.
- A speed dial number — After you store a phone number, you can assign a speed dial number to it.

**Important:**

Entries for Group Walkie-Talkie and Talkgroups contain different information. See “Contacts Entries for Walkie-Talkie Groups and Talkgroups” on page 129.

## Finding Contacts Entries



---

There are several ways to display your Contacts entries: by name, by speed dial number, by Category and Type, and by email address. Follow the steps outlined below to find entries in your Contacts.

### Finding Names

To find Contacts entries by name:

1. Press  > **Contacts** > **View All**.
2. Scroll through the entries using your navigation keys and highlight the one you want.



3. Highlight the phone number you want to call and press .  
– or –  
To view the entry's details, press  and then press your navigation keys left or right.  
– or –  
To send a message, press **Send MSG** (left softkey), create the message, and then press **Send** (left softkey).

**Tip:**

You can also find an entry by entering the name in the keypad. Press **Contacts** (left softkey) and use your keypad to enter the name.



## Finding Speed Dial Numbers



To find phone numbers by their assigned speed dial numbers:

1. Press  > **Contacts** > **Speed Dial #s**.
2. Scroll to an entry using your navigation keys. Speed dial numbers are displayed in numeric order.
3. To display the entry details, press .  
– or –  
To dial the phone number assigned to a speed dial number, press .

## Filtering Entries



To filter **Contacts** entries by **Category** or **Type**:

1. Press  > **Contacts** > **Filter by**.
2. Scroll to the **Category** or **Type** you want to filter by and press .
3. Scroll to an entry using your navigation keys.

4. To view the entry's details, press  and then press your navigation keys left or right.  
– or –  
Highlight the phone number you want to call and press .  
– or –  
To send a message, press **Send MSG** (left softkey), create the message, and then press **Send** (left softkey).

## Finding Email Addresses

To find phone numbers you have stored with email addresses:

1. Press  > **Contacts** > **Filter by**.
2. Select **Email**, press , and then highlight the entry you want.
3. To view the entry's details, press  and then press your navigation keys left or right.  
– or –  
To send a message to the email address, press **Send MSG** (left softkey), create the message, and then press **Send** (left softkey).

# Creating a Contacts Entry

---

To add a new Contacts entry:

1. Press **[OK]** > **Contacts** > **Add New**.
2. Highlight **Contact** and press **[OK]**.
3. Enter the Contacts name and press **[OK]**.
4. To enter a Walkie-Talkie number, highlight **Walkie-Talkie**, enter the number, and press **[OK]**.
5. To enter a phone number, highlight **Number**, enter the number, and press **[OK]**.
6. Assign **Mobile**, **Home**, **Work**, **Pager**, or **Other** to the number and press **[OK]**.
7. Press **Save** (left softkey).

If you want, you can add a picture, a special ringer, additional phone numbers, an email or Web address, and an important date. Scroll left or right to view what other information you can assign to your Contacts entry.

## Adding a Phone Number to a Contacts Entry



To add a phone number to an entry:

1. Press **[OK]** > **Contacts** > **View All**.
2. Scroll through the entries using your navigation keys, highlight the one you want, and press **[OK]**.
3. Press **Edit** (left softkey).
4. Scroll to an empty **Number** using your navigation keys.
5. Enter the new phone number and press **[OK]**.
6. Assign **Mobile**, **Home**, **Work**, **Pager**, or **Other** to the number and press **[OK]**.
7. Press **Save** (left softkey).

## Assigning Speed Dial Numbers

Once you have added a number to your Contacts, you can assign a speed dial number to it. Your phone can store 99 numbers in speed dial locations.

To assign a speed dial number to an existing phone number:

1. Press  > **Contacts** > **Speed Dial #s**.
2. Highlight an empty speed dial location and press **Assign** (left softkey).
3. Highlight the number you want to assign to the speed dial location and press .

### Note:

If you attempt to assign an already in-use speed dial number to a new phone number, a dialog appears asking if you wish to replace the existing speed dial number. Press **OK** (left softkey) to assign the location to the new phone number and move the old number to the next available speed dial number.

## Assigning a Ringer or Picture to an Entry

You can assign a ringer to a Contacts entry so you can identify the caller by the ring. (See “Ringer Types” on page 72.) When you assign a picture to an entry, your phone displays it whenever you receive calls from that number.

To assign a ringer or picture to an entry:

1. Display a Contacts entry. (See “Finding Contacts Entries” on page 122.)
2. Press **Edit** (left softkey).
3. Use your navigation key to scroll right to the tab with the **Assign Picture** and **Audio Ringer** or **Video Ringer** options.
4. Scroll down to **Assign Picture** or **Audio Ringer** and press .



5. Select a source for the assigned file (for example, **In Phone**, **External Memory**, **Assigned Media**, or **Take New Picture**).
6. Use your navigation keys to scroll through the available files. To hear a ringer, press **Listen** (left softkey).
7. Highlight your desired picture or ringer and press .
8. Press **Save** (left softkey) to save the entry.

## Assigning an Email Address or Web Address

To assign an email address or Web address to an entry:

1. Display a Contacts entry. (See “Finding Contacts Entries” on page 122.)
2. Press **Edit** (left softkey).
3. Use your navigation keys to scroll right to the tab with the **Email** and **Web Address** options.
4. Scroll down to **Email** or **Web Address**.
5. Use your keypad to enter the email or Web address you want to assign and press .
6. Press **Save** (left softkey) to save the entry.

### Tip:

You can quickly visit the Web address associated with a Contacts entry by displaying the entry, highlighting the Web Address, and then pressing **Go** (left softkey).

## Assigning a Date

You can assign date to a Contacts entry. This is an easy way to remember birthdays.

To assign a date to an entry:

1. Display a Contacts entry. (See “Finding Contacts Entries” on page 122.)
2. Press **Edit** (left softkey).





3. Use your navigation key to scroll right to the tab with the **Birthday** option.
4. Highlight the date field, use your navigation keys or keypad to set the date, and then press .
5. Press **Save** (left softkey) to save the entry.

## Working With Distribution Lists



A Distribution List is a group of entries that you can send messages to — including SMS Text Messages, Picture Mail, and SMS Voice Messages. You can send the message to all the members on the list at the same time.

It's a fast and easy way to keep everyone up to date.

### To create a Distribution List:

1. Press  > **Contacts** > **Add New**.
2. Highlight **Distribution List** and press .
3. Enter the name of the list and press .
4. Highlight **Category** and assign one to the list.
5. Highlight **Add Members** and press .
6. Highlight each entry you want to include in the Distribution List and press  after each selection. A check mark appears next to each selected member.
7. Press **Done** (left softkey) to save the membership.
8. Press **Save** (left softkey) to save the entry.

### To view a Distribution List:

1. Press  > **Contacts** > **Filter by** > **Distribution List**.
2. Scroll through the Distribution Lists.
3. Highlight a Distribution List and press  to view the membership.

**Tip:**

To quickly send a message to the Distribution List, press **[OK]** > **Contacts** > **Filter by** > **Distribution List**. Highlight the Distribution List you want and press **Send MSG** (left softkey).

## Editing a Contacts Entry or Distribution List

To edit a Contacts entry or Distribution List:

1. Display a Contacts entry or Distribution List.
2. Press **Edit** (left softkey).
3. Highlight the part of the entry you wish to edit and press **[OK]**.
4. Add and/or edit the desired information.
5. Press **Save** (left softkey).

## Contacts Entries for Walkie-Talkie Groups and Talkgroups

---



Because Nextel Group Walkie-Talkie and Talkgroup calls communicate with more than one person, you create their Contacts entries differently.

### Creating Group Walkie-Talkie Entries



You create a Group Walkie-Talkie entry by giving it a name and assigning it members that have Group Walkie-Talkie compatible phones. You can also add all the members in an existing Group by assigning it to your new Group.

To create a Contacts entry for a Walkie-Talkie Group:



1. Press **[OK]** > **Contacts** > **Add New**.
2. Highlight **Walkie-Talkie Group**, and then press **[OK]**.
3. Enter a name for the new Group.
4. Choose a Category for the entry.

5. Highlight **Add Members** and press .
6. Use your left and right navigation keys to select **Contacts** or **Call History**.
7. Highlight each Walkie-Talkie contact you want to add to this Group and press  after each selection. A checkmark appears next to each selected entry.
8. Press **Done** (left softkey) to save the membership.
9. Press **Save** (left softkey) to save the entry.

#### To add a member to an existing Group:

1. Press  > **Contacts** > **Filter by** > **Walkie-Talkie Group**.
2. Scroll to the Group you want to add members to and press **Edit** (left softkey).
3. Select **Edit Members**.
4. Highlight each member you want to add and press  after each selection. A checkmark appears next to each selected member.
5. Press **Done** (left softkey) to save the membership.
6. Press **Save** (left softkey) to save the entry.

#### To remove a member from a Group:

1. Press  > **Contacts** > **Filter by** > **Walkie-Talkie Group**.
2. Scroll to the Group you want to delete members from and press **Edit** (left softkey).
3. Select **Edit Members**.
4. Highlight each member you want to delete and press  after each selection. The checkmark next to each selected member clears.
5. Press **Done** (left softkey) to save the membership.
6. Press **Save** (left softkey) to save the entry.

To delete a Group from Contacts:

1. Press  > **Contacts** > **Filter by** > **Walkie-Talkie Group**.
2. Scroll to the Group you want to delete and press **Edit** (left softkey).
3. Press **Options** (right softkey) and then select **Delete**.
4. Press **Yes** (left softkey).

## Editing Walkie-Talkie Group Entries



You can edit the name, Category, or membership of a Group entry.

To edit Group entries:

1. Press  > **Contacts** > **Filter by** > **Walkie-Talkie Group**.
2. Scroll to the Group you want to edit and press **Edit** (left softkey).
3. Highlight the part of the entry you wish to edit and make your changes.
4. Press **Save** (left softkey) to save the entry.

## Creating Talkgroup Entries

To create a Contacts entry for a Talkgroup:

1. Press  > **Contacts** > **Add New**.
2. Highlight **Talkgroup**, and then press .
3. Enter a name for the Talkgroup. Each entry's name can contain 24 characters.
4. Enter the Talkgroup number.
5. Choose a Category for the entry.
6. Press **Save** (left softkey).

# Managing Your Contacts





---

Organize your Contacts entries by assigning them to Categories. Your phone has some already defined – General, Family, Friends, and Work. You can also create your own.

To view your Categories:

- ▶ Press  > **Contacts** > **Manage Categories**.

To create your own custom Category:

1. Press  > **Contacts** > **Manage Categories**.
2. Press **Add New** (right softkey).
3. Enter the name of the new Category.
4. Highlight **Add Members** and press .
5. Highlight each entry you want to add to this Category and press  after each selection. A checkmark appears next to each selected entry.
6. Press **Done** (left softkey) to save the membership.
7. To assign a special ringer to this Category, highlight **Audio Ringer** and press .
8. Select a location for the ringer file (for example, **In Phone**, **External Memory**, **Assigned Media**, or **Take New Picture**).
9. Use your navigation keys to scroll through the available files or to capture a new voice recording. To hear a ringer, press **Listen** (left softkey).
10. Highlight your desired ringer and press .
11. Press **Save** (left softkey) to save the Category.

## Erasing All Contacts

To erase all the **Contacts** entries stored in your phone:

1. Press  > **Settings/Tools** > **Settings** > **Security**.
2. Enter your Lock Code.
3. Select **Manage Applications**.
4. Select **Contacts**.
5. If you are sure you want to delete all **Contacts**, press **Yes** (left softkey).

## Viewing Memory Status

To view how much memory you currently have available for new entries:

- ▶ Press  > **Contacts** > **Memory Status**.

## Using Your SIM Manager

When you create a new entry in **Contacts**, that information is stored in your phone, not on your SIM card. If you decide to save it on your SIM card, you must use the **SIM Manager** to copy it there. The **SIM Manager** also allows you to copy from the SIM card to your phone.

**Tip:**

You can access **SIM Manager** from both the **Contacts** and **Tools** menu.

## Viewing Entries Stored in Your SIM Card

To view entries stored in the SIM card:

1. Press  > **Contacts** > **SIM Manager** > **Manage SIM**.
2. Scroll to view the list of entries.

**Note:** To view details, highlight the Contacts entry and press **Details** (left softkey). If you selected a Walkie-Talkie Group, pressing **Details** (left softkey) displays the members.

You cannot dial numbers directly from SIM Manager. You can do so from Contacts or the Call History lists.

## Deleting Entries Stored in Your SIM Card

To delete entries stored in the SIM card:

1. Press **☰** > **Contacts** > **SIM Manager** > **Manage SIM**.
2. Highlight each entry you want to delete and press **☑** after each selection. A checkmark appears next to each selected entry.
3. Press **Options** (right softkey) and then select **Delete**.
4. Press **Yes** (left softkey).

**Note:** To delete all the entries from the SIM Card, after selecting **Options**, choose **Select All**.

## Copying Contacts Entries – Phone to SIM Card

To copy entries from your phone to your SIM card:

1. Press **☰** > **Contacts** > **SIM Manager** > **Copy to SIM**.
2. Highlight the entries you want to copy and press **☑** after each selection. A checkmark appears next to each selected entry.
3. Press **Copy** (left softkey).
4. Press **OK** (left softkey).



**Note:** Selecting a Group selects all its members.

To copy all the entries to the SIM Card, after selecting **Copy to SIM**, choose **Select All**.



## Copying Contacts Entries – SIM Card to Phone

To copy entries from a SIM card to your phone:

1. Press  > **Contacts** > **SIM Manager** > **Copy to Contacts**.
2. Highlight the entries you want to copy and press  after each selection. A checkmark appears next to each selected entry.
3. Press **Copy** (left softkey).
4. Press **OK** (left softkey).

### Note:

If you have a black or yellow Nextel SIM card from a previous phone, you can copy the stored Contacts from the card onto your phone

Selecting a Group selects all its members.

To copy all the entries to your phone, after selecting **Copy to Contacts**, choose **Select All**.

## While Copying...

While attempting to copy information with your SIM Manager, you may encounter circumstances that prevent you from completing the task. Usually, your phone displays a message explaining what happened and screen prompts showing what to do next.

When you copy a Contacts entry from your phone to your SIM card, the entry may not copy completely. For example, Contact classifications, such as Mobile, Home or Work, may differ on your SIM Card. In addition, some fields, such as IP address, cannot be copied.



Your Contacts entries may also display differently on a SIM Card. For example, the first and last name of an entry may be displayed in reverse order, or a very long name may be truncated.

# Dialing Sprint Services











---

Your Contacts contain entries for various Sprint services.

To dial a service from your Contacts:

1. Press  > **Contacts** > **Services**.
2. Select **Customer Solutions**, **Account Info.**, **Dir. Assistance**, **Sprint Operator**, or **Voice Command**.
3. Press  to place the call.

To dial a service from standby mode using your keypad:

1. Dial the appropriate service number:
  - **Customer Solutions** –   .
  - **Account Info.** –  .
  - **Dir. Assistance** –   .
  - **Sprint Operator** – .
  - **Voice Command** – .
2. Press  to place the call.

# Using Wireless Backup

Wireless Backup is an optional subscription service from Sprint that allows you to securely and privately back up, store, and edit your Contacts on the Web, using your personal computer.

## Setting Up Wireless Backup



1. Press **☰** > **Contacts** > **Wireless Backup**.  
– or –  
Press **☰** > **Settings/Tools** > **Settings** > **Others** > **Wireless Backup**.
2. Select **Subscribe** and press **☑**. You will be prompted to allow a Vision connection to confirm your subscription status.

**Tip:**

For more information about Wireless Backup, select **Learn More** in step 2 above .

3. Select **Yes** and press **☑**. Follow the onscreen prompts to confirm your status.
4. When the Wireless Backup purchase screen is displayed, select **Buy** and press **☑** to purchase a subscription to Wireless Backup.
5. Within a few minutes, you will receive a text message providing you with the Web address ([www.wirelessbackup.sprint.com](http://www.wirelessbackup.sprint.com)) and password for your personal backup folder.

## Backing Up Your Contacts

1. Press  > **Contacts** > **Wireless Backup**.
2. Select **Backup Now** and press  to back up all your contacts from the phone's contacts list to your folder on the Wireless Backup site. You will be notified when the backup has been completed.

## Accessing Wireless Backup on Your PC

1. From your personal computer, launch your Internet browser and go to [www.wirelessbackup.sprint.com](http://www.wirelessbackup.sprint.com).
2. Enter your wireless phone number (without hyphens) in the **Sprint PCS Phone Number** field.
3. Enter the wireless password you received via text message into the **Wireless Backup Password** field.
4. Click **Sign on** and follow the onscreen prompts.

# Using the Phone's Tools

---

## In This Section

---

- ◆ Using Your Phone's Calendar
  - ◆ Using the Alarm Clock
  - ◆ Using the Calculator
  - ◆ Using the World Clock
  - ◆ Using the Stop Watch
  - ◆ Using the Notepad
  - ◆ Using the Tip Calculator
  - ◆ Using the Currency Converter
  - ◆ Using the Unit Converter
  - ◆ Using Voice Records
  - ◆ Using the File Manager
- 

**Your phone is equipped with several personal information management features that help you manage your busy lifestyle.** This section shows you how to use these features to turn your phone into a time management planner that helps you keep up with your appointments, schedules, and commitments. It takes productivity to a whole new level.

# Using Your Phone's Calendar

---

## Adding an Event to the Calendar









Your Calendar helps organize your time and reminds you of important events.

To add an event:

1. Press  > **Settings/Tools** > **Tools** > **Calendar**.
2. Using your navigation keys, highlight the day to which you would like to add an event.

**Tip:**

To quickly go to a date, press **Options** (right softkey) and select **Go to Date**.

3. Press **Add New** (left softkey).
4. Select **Appointment, All Day Event, Multi-Day Event, or Alarm**.
5. Enter the event **Subject** and press .
6. Enter the event **Location** and press .
7. Enter the event **Date** and press .
8. Select a **Start Time** for the event by highlighting the time field and pressing 
  - Using your keypad and/or navigation keys, set the start time for the event, and press .
9. Select an **End Time** for the event by highlighting the time field and pressing 
  - Using your keypad and/or navigation keys, set the end time for the event, and press .
10. Select an alarm time for the event by highlighting the **Reminder** field and pressing .

- Highlight **None**, **On Time**, **5 mins**, **10 mins**, **15 mins**, **30 mins**, **1 hr**, or **1 day** and press .

11. Press **Save** (left softkey) to save the event.

**Tip:**

To change your default event ringer type, from the standby screen, press  > **Settings/Tools** > **Settings** > **Sounds** > **Ringer Type** > **Calendar** and select a ringer.

## Event Alerts

Your phone alerts you to scheduled events as follows:

- By playing the assigned ringer type.
- By illuminating the backlight.

## Event Alert Menu



When your phone is turned on and you have an event alarm scheduled, your phone alerts you and displays the event summary. To silence the alert, press .

You can do the following:

- Dismiss** (right softkey) clear the alert.
- Snooze** (left softkey) silences the alert and schedules it to replay again in 10 minutes.

## Viewing Events

To view your scheduled events:

- Press  > **Settings/Tools** > **Tools** > **Calendar**.
- Using your navigation keys, highlight the day for which you would like to view events and press . (If you have events scheduled for the selected day, they are listed in chronological order.)
- To display the details of an event listed in the schedule, highlight it and press .

## Changing to Weekly View

To go to the Weekly Calendar view:

1. Press  > **Settings/Tools** > **Tools** > **Calendar**.
2. Press **Options** (right softkey).
3. Select **Week View**.



## Going to Today's Date

To go to today's date:

1. Press  > **Settings/Tools** > **Tools** > **Calendar**.
2. Press **Options** (right softkey).
3. Select **Go to Today**.

## Deleting an Event

To delete a day's scheduled events:

1. Press  > **Settings/Tools** > **Tools** > **Calendar**.
2. Using your navigation keys, highlight the day for the event and press .

**Tip:**

In the calendar view, days with events scheduled are marked with a yellow triangle.

3. Highlight the event, press **Options** (right softkey), and select **Delete**.
4. Press **Yes** (left softkey) or **No** (right softkey).

## Deleting All Events

To delete all scheduled events:

1. Press  > **Settings/Tools** > **Tools** > **Calendar**.
2. Press **Options** (right softkey).
3. Select **Delete All**.



4. Press **Yes** (left softkey) or **No** (right softkey).

## Using the Alarm Clock

Your phone comes with a built-in alarm clock with multiple alarm capabilities.

To use the alarm clock:

1. Press **[Menu]** > **Settings/Tools** > **Tools** > **Alarm Clock**.
2. Select **Add New Alarm** and press **[Menu]**.
3. Enter the alarm **Name** and press **[Menu]**.
4. Select a time for the alarm by highlighting the **Time** field and pressing **[Menu]**.
  - Using your keypad and/or navigation keys, set the time for the alarm, and press **[Menu]**.
5. Select a ringer type for the alarm by highlighting the **Ringer** field and pressing **[Menu]**.
  - Select a location for the ringer file (for example, **In Phone**, **External Memory**, **Assigned Media**, or **Take New Picture**).
  - Use your navigation keys to scroll through the available files.
6. Press **[Menu]** or press **Assign** (left softkey) to assign the ringer.
7. Select a repeating status for the alarm by highlighting the **Frequency** field and pressing **[Menu]**.
  - Highlight **Once**, **Daily**, **Mon - Fri**, **Weekends** or **Weekly**, and then press **[Menu]**.
8. Press **Save** (left softkey) to save the alarm.

### Tip:



To change your default alarm ringer type from the standby screen press **[Menu]** > **Settings/Tools** > **Settings** > **Sounds** > **Ringer Type** > **Alarm** and select a ringer.

# Using the Calculator

---

Your phone comes with a built-in calculator.

To use the calculator:



1. Press  > **Settings/Tools** > **Tools** > **Calculator**.
2. Enter numbers using your keypad.
  - Press the navigation keys to enter operators (+ ÷ - ×) as indicated in the display.
  - Press  to enter a decimal.
  - Press  to make the number to the left of the cursor positive or negative.
  - Press **Advanced** (right softkey) to enter parentheses or exponents.
3. Press = (left softkey) to compute.

# Using the World Clock

---

Your phone comes with a built-in world clock to let you view times around the world.

To view the time in different cities around the world:

1. Press  > **Settings/Tools** > **Tools** > **World Clock**.
2. Press **Find City** (left softkey) to choose a city.  
– or –  
Press the navigation keys left or right to scroll through different time zones.
3. When you see the city you want, press .

## Using the Stop Watch

---

Your phone comes with a built-in stop watch.

To use the stop watch:



1. Press  > **Settings/Tools** > **Tools** > **Stop Watch**.
2. Press **Options** (right softkey) to choose **Countdown**, **Lap Summary**, **Setup**, or **Reset**.
3. When you are ready to use the stop watch timer, press **Start** (left softkey).
4. To stop the timer, press **Stop** (left softkey).

## Using the Notepad

---

Your phone comes with a built-in notepad.

To use the notepad:







1. Press  > **Settings/Tools** > **Tools** > **Notepad**.
2. Select **Add New Note** and press .
3. Enter the note title and press .
4. Enter the note text.
5. Press **Save** (left softkey) to save the text.

# Using the Tip Calculator

---

Your phone comes with a built-in tip calculator.





To calculate tips:

1. Press  > **Settings/Tools** > **Tools** > **Tip Calculator**.
2. Enter the bill amount (dollar amount) and press .
3. Enter the bill amount (cent amount) and press .
4. The default number of people paying the bill is one. To change it, press  to delete the number 1 and enter the number of people splitting the bill.
5. Press .
6. The default tip percentage is 15%. To change it, press  to delete the number 15 and enter the tip percentage you want.
7. Press .
8. Upon completion you will see the following:
  - **Tip Amount** – This is the calculated amount of the tip.
  - **Total to Pay** – This is the calculated amount of the total bill plus tip.
  - **Total per Person** – This is the calculated amount of the total each person is responsible for paying.

# Using the Currency Converter

Your phone comes with a built-in currency converter that lets you convert currency amounts if you know the exchange rate.

To use the currency converter:





1. Press  > **Settings/Tools** > **Tools** > **Currency Converter**.
2. Enter the bill amount (dollar amount) and press .
3. Enter the bill amount (cent amount) and press .
4. Enter the exchange rate (dollar amount) and press .
5. Enter the exchange rate (cent amount) and press .
6. Upon completion you will see the following:
  - **Result 1** – Your currency converted to the new currency.
  - **Result 2** – Their currency converted to the your currency.

# Using the Unit Converter

---

Your phone comes with a built-in unit converter that lets you convert a wide variety of units of measure.

To use the unit converter:

1. Press  > **Settings/Tools** > **Tools** > **Unit Converter**.
2. Select the type of unit to be converted:
  - **Area**
  - **Energy**
  - **Force**
  - **Length**
  - **Mass**
  - **Power**
  - **Speed**
  - **Temperature**
  - **Volume**
3. Enter the value (whole number) and press .
4. Enter the value (decimal number) and press .
5. Enter the convert from unit from the drop down menu, and press .
6. Enter the convert to unit from the drop down menu, and press .
7. Upon completion you will see the following:
  - **Result** – Your unit converted to the new unit.

# Using Voice Records

You can record brief records to remind yourself of important events, phone numbers, or grocery list items. You can also record phone conversations.

## Recording Voice Records

To create a new Voice Record:

1. Press **[OK]** > **Settings/Tools** > **Tools** > **Voice Records**.
2. Press **[OK]** and begin recording after the prompt.
3. To end the recording, press **[OK]**.

If you want to review the recording, press **Yes** (left softkey).



To record a conversation during a phone call:

1. Make or answer the call.
2. Press **Options** (right softkey), select **Record Recipient**, and press **[OK]**.
3. Press **[OK]**.
4. To end the recording, press **Done** **[OK]**.

**Note:** You cannot store Voice Records on your microSD card.

## Playing Voice Records

To play the Voice Records you have recorded:

1. Press  > **Settings/Tools** > **Tools** > **Voice Records**.
2. Press **View All** (right softkey).
3. Use the navigation keys to scroll to a recording.
4. Press  to play the Voice Record.







### Tip:

To make finding Voice Records easier, select **Sort By (Name, Date, Size, or Type)**.

You can choose **Play All** (to play all the Voice Records) or **Select Multiple** (to play a several Voice Records consecutively).

## Changing Voice Record Settings

To change your Voice Record maximum length and tone:

1. Press  > **Settings/Tools** > **Tools** > **Voice Records**.
2. Press **Settings** (left softkey).
3. Scroll to **Recording Length**, and press 
  - Select a maximum length of **10 Seconds**, **30 Seconds**, **1 Minute**, **5 Minutes**, or **30 Minutes**, and press .
4. Scroll to **10 Second Tone** and press . This tone beeps every 10 seconds during your Voice Record.
  - Select **Enable** or **Disable** and press .
5. Scroll to **Storage Location** and press 
  - Select **In Phone** or **External Memory** and press .



## Using Other Voice Record Options

You can also rename your Voice Records, use them as ringers, or delete them.

To rename, set as ringer, or delete a Voice Record:

1. Press **[OK]** > **Settings/Tools** > **Tools** > **Voice Records**.
2. Press **View All** (right softkey) and press **[OK]**.
3. Use the navigation keys to scroll to the recording you want to work with.
4. Press **Options** (right softkey) and then choose **Assign**, **Rename**, **Delete**, **Select Multiple**, **Properties**, or **Settings**. Follow the prompts to complete your task.

## Using the File Manager

Your phone comes with a file manager that enables you to manage your pictures, videos, and sounds saved in your phone and on the microSD card inserted in your phone.

To access the file manager:

- ▶ Press **[OK]** > **Settings/Tools** > **Tools** > **File Manager**.

The file manager then gives you these options to choose from:

- **Pictures** – This option allows you to manage your pictures and videos stored either in the phone's memory or on your microSD card.
- **Sounds** – This option allows you to manage your sounds stored either in the phone's memory or on your microSD card.

- **External Memory** – This option allows you to view the properties of the files and folders stored on your microSD card, format an SD card, view the used and available memory in the phone's memory and on the microSD card, and view the file manager Help screen.
- **Memory Usage** – This option shows the used and available memory in the phone's memory and on the microSD card.

## Using the Pictures Option

The Pictures option lets you manage the pictures and video in your phone's memory or on your microSD card.

To manage your pictures and videos in your phone's memory:

1. Press  > **Settings/Tools** > **Tools** > **File Manager**.
2. Select **Picture**.
3. Select **In Phone** to access pictures and videos stored in your phone's memory.
4. Do any of the following:
  - Using your navigation keys, select the desired picture or video. Press **Expand** (left softkey) to view the picture or view the video fullscreen.
  - Using your navigation keys, select the desired picture or video. Press **Options** (right softkey) to view the picture or view the video options menu. The Options menu includes the following options:
    - ◆ **Manage** – This option lets you delete the file you selected, copy it from the phone's memory to the microSD card, or move it from the phone's memory to the microSD card.
    - ◆ **Slide Show** – This option displays all the pictures saved to your memory card in a slide show.
    - ◆ **Play All** – This option plays all videos in the phone's memory.

- ◆ **Filter By** – This option lets you view all the picture and video files in your phone's memory, view only the picture files, or view only the video files.

To manage your pictures and videos on your microSD card:

1. Press  > **Settings/Tools** > **Tools** > **File Manager**.
2. Select **Picture**.
3. Select **External Memory** to access pictures and videos stored on your SD card.
4. Do any of the following:
  - Using your navigation keys, select the desired picture or video. Press **Expand** (left softkey) to view the picture or view the video fullscreen.
  - Using your navigation keys, select the desired picture or video. Press **Options** (right softkey) to view the picture or view the video options menu. The Options menu includes the following options:
    - ◆ **Manage** – This option lets you delete the file you selected, copy it from the microSD card to the phone's memory, or move it from the microSD card to the phone's memory.
    - ◆ **Slide Show** – This option displays all the pictures saved to your memory card in a slide show.
    - ◆ **Play All** – This option plays all videos on the microSD card.
    - ◆ **Filter By** – This option lets you view all the picture and video files on the microSD card, view only the picture files, or view only the video files.

## Using the Sounds Option

The Sounds option lets you manage the audio files stored in your phone's memory or on your microSD card.

To manage your sounds in your phone's memory:

1. Press **[Menu]** > **Settings/Tools** > **Tools** > **File Manager**.
2. Select **Sounds**.
3. Select **In Phone** to access sounds stored in your phone's memory.
4. Do any of the following:
  - Using your navigation keys, select the desired sound. Press **Assign** (left softkey) to assign the selected sound to a phone function.
  - Using your navigation keys, select the desired sound. Press **Options** (right softkey) to view the options menu. The Options menu includes the following options:
    - ◆ **Play All** – This option allows you to listen to all the sounds stored in your phone's memory.
    - ◆ **Filter By** – This option lets you view all the sound files in your phone's memory, view only the downloaded files, view only the preloaded files, or view only the voice records.
    - ◆ **Manage** – This option lets copy or move the file you selected from the phone's memory to the microSD card.

To manage your sounds on your microSD card:

1. Press **[Menu]** > **Settings/Tools** > **Tools** > **File Manager**.
2. Select **Sounds**.
3. Select **External Memory** to access sounds stored on your microSD card.

4. Do any of the following:
  - Using your navigation keys, select the desired sound. Press **Assign** (left softkey) to assign the sound to any of the following: **Set as a Ringer ID, Call with ID, Call without ID, Voicemail, Picture Mail, Text Message, Voice SMS, Calendar, or Alarm**
  - Using your navigation keys, select the desired sound. Press **Options** (right softkey) to view the options menu. The Options menu includes the following options:
    - ◆ **Play All** – This option allows you to listen to all the sounds stored in your microSD card.
    - ◆ **Filter By** – This option lets you view all the sound files in your microSD card, view only the downloaded files, view only the preloaded files, or view only the voice records.
    - ◆ **Manage** – This option lets you delete, copy, or move the file you selected from microSD card to the phone's memory.

## Using the External Memory Option

The External Memory option allows you to view the properties of the files and folders stored on your microSD card, view the used and available memory in the phone's memory and on the microSD card, view the file manager Help screen, and format a microSD card.

For information on formatting the microSD card, see “Formatting the microSD Card” on page 176.

**To view the properties of files and folders on your microSD card:**

1. Press  > **Settings/Tools > Tools > File Manager.**
2. Select **External Memory.**

3. Scroll to the file or folder you for which you want to view properties. To view files within a folder, select the folder.
4. Press **Properties** (left softkey) to view details of the file or folder.

**To view memory usage:**

1. Press  > **Settings/Tools** > **Tools** > **File Manager**.
2. Select **External Memory**.
3. Press **Options** (right softkey).
4. Select **Memory Usage**.

**To view the file manager Help screen:**

1. Press  > **Settings/Tools** > **Tools** > **File Manager**.
2. Select **External Memory**.
3. Press **Options** (right softkey).
4. Select **Help**.

# Using Your Phone's Voice Services

---

## In This Section

---

- ◆ **Voice Recognition — Dialing & Messaging**
  - ◆ **Setting Up Voice Recognition**
  - ◆ **Working With Voice Recognition**
- 

Your phone's voice-recognition software lets you place calls and perform quick tasks using just your voice, and Voice Records allows you to make recordings right on your phone. This section includes easy-to-follow instructions for using Voice Recognition and voice records.

# Voice Recognition — Dialing & Messaging

---

With Voice Recognition, you can place calls and perform tasks simply by speaking. You do not need any voice training to use Voice Recognition. You simply say the appropriate command in a normal tone of voice and your phone performs the desired function.

## Using Call <Name or #>

You dial phone numbers simply by saying “Call.” To place calls to names stored in your Contacts, say “Call” followed by the name and the type of number (**Home, Work, Mobile**, etc.). To make phone calls to numbers not saved to your Contacts, simply say “Call” followed by a valid phone number.

You can also say “Call” by itself and be prompted for the name or number.

## Calling Contacts Entries

To place a phone call to a Contacts entry:

1. Press and hold the **Speaker Key**. (Your phone displays the **Say a command** screen.)
2. Say **Call** and then say the name and the type of number. For example, say “Call John Mobile.” The phone dials the number stored for the entry “John,” labeled “Mobile.”

If a name has only one number, or if you know the name but are not sure which number to call, say “Call” followed by the name only. For example, say “Call John.” If the name is recognized and there is only one number for the name, your phone immediately places the call. If there are multiple numbers stored in the entry, the phone prompts you with a list of options.



If the name or number is not in Contacts, your phone tells you it cannot find a match.

## Calling Phone Numbers (Digit Dialing)

To call a number that is not stored in your Contacts:

1. Press and hold the **Speaker Key**. (Your phone displays the **Say a command** screen.)
2. Say **Call** and then say a valid string of digits to be dialed, for example, say “Call 555 555 5555.”

Speak naturally and clearly and remember to speak one digit at a time—1-800 should be pronounced “One Eight Zero Zero.”

## Using Send Voice SMS <Name or #>

Use Voice Recognition to access the SMS Voice application, with the recipient already addressed.

To send an SMS Voice message:

1. Press and hold the **Speaker Key**. (Your phone displays the **Say a command** screen.)
2. Say **Send Voice SMS** followed by the name (if the recipient is saved to Contacts) or the number.
3. Record your SMS Voice message, attach a signature, and then press **Save** (left softkey). (See “Using SMS Voice Messaging” on page 221.)
4. Press **Send** (left softkey).

If you are sending the SMS Voice message to a recipient listed in Contacts, then you have the option of mentioning the type of number. For example, say “Send Voice SMS John Mobile.”

If you say **Send Voice SMS** without specifying a recipient or a number, your phone prompts you for this information.

**Note:** You cannot send SMS Voice messages to Distribution Lists using **Voice Recognition**.

## Using Send Text <Name or #>

Use **Voice Recognition** to open Text Messaging to the Create Message screen, with the recipient already addressed.

To launch Text Messaging and address a message:

1. Press and hold the **Speaker Key**. (Your phone displays the **Say a command** screen.)
2. Say **Send Text** followed by the name (if the recipient is saved to Contacts) or the number.
3. Use your keypad to enter the message and then press **Send** (left softkey). (See “Using SMS Text Messaging” on page 219.)

If you do not specify the type of number and there are multiple numbers for the name, Voice Recognition chooses the mobile number by default.

If you say **Send Text** without specifying a recipient or a number, your phone prompts you for this information.

**Note:** You cannot send SMS Text messages to Distribution Lists using **Voice Recognition**.

## Using Send Picture <Name or #>

Use Voice Recognition to open Picture Mail to the Create Message screen, with the recipient already addressed.

To launch Picture Mail and address a message:

1. Press and hold the **Speaker Key**. (Your phone displays the **Say a command** screen.)
2. Say **Send Picture** followed by the name stored in Contacts and, optionally, the type of number you want to send it to. For example, say “Send Picture John Smith Work.”
3. Use your keypad to enter the message and then press **Send** (left softkey).

If you do not specify the type of number and there are multiple numbers for the name, Voice Recognition chooses the mobile number by default.

If you say **Send Picture** without specifying a recipient or a number, your phone prompts you for this information.

**Note:**

You cannot send Picture Mail to Distribution Lists using **Voice Recognition**.

See the *Experience Sprint Power Vision* guide that came with your phone for information about Picture Mail.

# Setting Up Voice Recognition

---

You can customize your phone's Voice Recognition feature so that it works for you, the way you want it to.



## Using Choice Lists

Your phone offers Choice Lists whenever it is not confident it has recognized a name or number correctly. In these cases, it displays a Choice List and prompts you with "Call?" followed by the first choice on the list. To confirm the choice, say "Yes," or to hear the next choice, say "No." You can also select the correct choice using your keypad.

To cancel the command, say "Cancel," or to say the name or number again, say "Repeat."

You can determine whether Voice Recognition displays a list of choices or automatically dials the first number without displaying a Choice List.

To enable or disable Choice Lists:

1. Press and hold the **Speaker Key**. (Your phone displays the **Say a command** screen.)
2. Press **Settings** (left softkey).
3. Highlight **Choice Lists** and press .
4. Select **Automatic**, **Always On**, or **Always Off**, and press .

## Sensitivity

The Sensitivity setting controls how Voice Recognition determines when a spoken word is a match. If you frequently experience the message "Please Repeat" or "No Match Found" adjust the sensitivity toward **Reject Less**. If the phone frequently recognizes a name you didn't say, adjust the sensitivity to **Reject More**.

### To adjust the Sensitivity setting:

1. Press and hold the **Speaker Key**. (Your phone displays the **Say a command** screen.)
2. Press **Settings** (left softkey).
3. Highlight **Sensitivity** and press .
4. Using your navigation keys adjust the slider to the desired level.
5. Press **OK** (left softkey).

## Adapting Digit Dial



Some users with heavy accents or distinctive voices find it difficult to use Digit Dialing.

The Adapt Digits feature allows Voice Recognition to recognize the way specific persons say digits. Adaptation involves recording several digit sequences to teach Voice Recognition to recognize your voice. The adaptation process takes about three minutes.

After using Adapt Digits, your phone will be customized to your voice. Other people will not be able to use Digit Dial on your phone unless they reset the phone to factory defaults.

<b>Note:</b>	If your phone recognizes digits with an acceptable level of accuracy, you will find no additional benefit from using Adapt Digits.
--------------	--

### To adapt Digit Dial to your voice:

1. Press and hold the **Speaker Key**. (Your phone displays the **Say a command** screen.)
2. Press **Settings** (left softkey).
3. Highlight **Digit Dialing** and press .
4. Select **Adapt Digits** and press .

5. Follow the prompts to complete the adaptation.

Tips for adapting Digit Dial:

- Adapt digits in a quiet place.
- Make sure you wait for the beep before speaking.
- Speak clearly, but say each digit sequence naturally.
- If you make a mistake while recording a sequence of digits, or if an unexpected noise spoils the recording, you can say or select **No** when the prompt asks if the recording was OK. You will then be prompted to rerecord the sequence.

<b>Note:</b>	To reset Digit Dial to its factory settings, press and release <b>Smart Key</b> and then press <b>Settings</b> (left softkey). Select <b>Digit Dialing &gt; Reset Digits</b> .
--------------	--

## Customizing Audio Prompts

You can customize the way your phone reads prompts to you. This allows you to quickly cycle through prompts and commands that you are familiar with.

<b>Note:</b>	Only experienced users should turn off audio prompts altogether.
--------------	--

To turn audio prompts on or off:

1. Press and hold the **Speaker Key**. (Your phone displays the **Say a command** screen.)
2. Press **Settings** (left softkey).
3. Select **Sound** and press .

- To turn on or off all the audio prompts, select **Prompts** and then select **On** or **Off**.  
— or —  
To turn on or off the playback of digits spoken by you, select **Digits** and then select **On** or **Off**.  
— or —  
To turn on or off the playback of names spoken by you, select **Names** and then select **On** or **Off**.
- Press **OK** (left softkey).

### Adjusting Audio Prompt Speed and Volume

You can adjust how loud and how fast the phone playbacks names you have spoken.

To adjust the speed or volume of name playback:

- Press and hold the **Speaker Key**. (Your phone displays the **Say a command** screen.)
- Press **Settings** (left softkey).
- Select **Sound > Name Settings > Speed** or **Volume**.
- Using your navigation keys adjust the slider to the desired level.
- Press **OK** (left softkey).

# Working With Voice Recognition

---

You can use Voice Recognition to easily perform tasks with your phone. You can look up entries stored in your Contacts, open applications or menus, and view or hear status information.

## Lookup <Name>

You can find and display any Contacts entry by saying “Lookup” followed by the name.

To use **Lookup <Name>** to find a Contacts entry:

1. Press and hold the **Speaker Key**. (Your phone displays the **Say a command** screen.)
2. Say **Lookup** and then the name of the entry. (Your phone displays the Contacts entry.)

<b>Note:</b>	If you say only “Lookup,” your phone asks for the name and displays a Contacts entry list.
--------------	--

## Using Go To <App>

You can open an application or access a menu by saying “Go To” followed immediately by the name of an application or a menu.

To open an application or menu using **Voice Recognition**:

1. Press and hold the **Speaker Key**. (Your phone displays the **Say a command** screen.)
2. Say **Go To**. (Your phone displays a list of applications and menus and prompts you to choose one.)  
— or —  
Say **Go To** and then the name of the application or menu.



**Note:**

You can “go to” the following applications: Voicemail, Camera, Redial, and Received Calls.

## Using Check <Item>

You can have the phone play back and display information about its current state, including its phone number, current signal strength, network coverage, and battery level.

To see and hear status information:

1. Press and hold the **Speaker Key**. (Your phone displays the **Say a command** screen.)
2. Say **Check**. (Your phone displays a list of valid status indicators and prompts you to choose one.)  
— or —  
Say **Check** and then the name of the item you want to check.

You can check the following:

- **Status** — plays back and displays battery, signal, and network status information. (It also reports on volume level, missed calls, voicemail, messages, time, and date.)
- **Battery** — plays back and displays the current level of battery charge.
- **Signal** — plays back and displays current signal strength.
- **Network** — plays back and displays current network coverage.
- **My phone #** — plays back and displays your phone number.

# Using the microSD Card

---

## In This Section

---

- ◆ Using Your Phone's microSD Card and Adapter
  - ◆ Working With the microSD Card
- 

**Your phone allows you to use a microSD card and an adapter to expand the phone's available memory space.** This secure digital card enables you to quickly and easily exchange images, music, and voice data between SD-compatible devices.

This section details the features and options of your phone's microSD functionality.

# Using Your Phone's microSD Card and Adapter

Your phone comes bundled with a microSD (Secure Digital) memory card and its adapter to expand the phone's available memory space.

You can purchase additional microSD cards with up to 2 GB in memory.

It allows you to easily store images, videos, music, and voice data in your phone.

## Inserting the microSD Card

**Note:** Don't bend or scratch your memory card. Keep it away from static electricity, water, and dirt.

The microSD card and its adapter can be easily damaged by improper operation. Please be careful when inserting, removing, or handling them.

**To insert the microSD card into your phone:**

1. Lift the cover of the cardholder as shown in the illustration below.

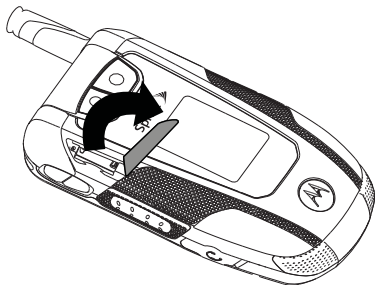

2. Gently insert the microSD card into the cardholder as shown below. Use your fingertip to press in on the card until you hear a click. The card will stay firmly in place when inserted correctly.

**Tip:**

The writing on the microSD card should face up.

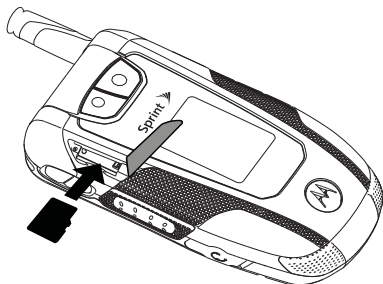

3. Close the top of the cardholder.

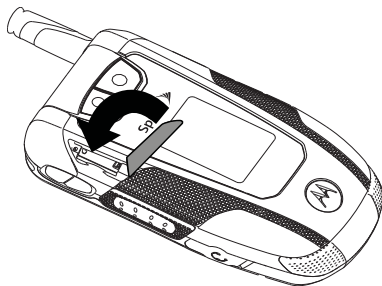

**Note:**

Make sure your battery is fully charged before using the microSD card. Your data may become damaged or unusable if the battery runs out while using the microSD card.

Be sure to use only recommended microSD cards (64MB—2GB). Using non-recommended microSD cards could cause data loss and damage your phone.

## Removing the microSD Card

To remove the microSD card from your phone:

1. Lift the cover of the cardholder as shown in the illustration below.

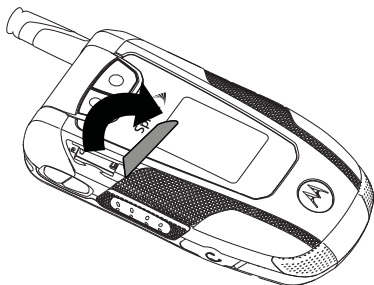

2. Press the card in and then release. The card should eject. Then gently slide out the microSD card from the cardholder.

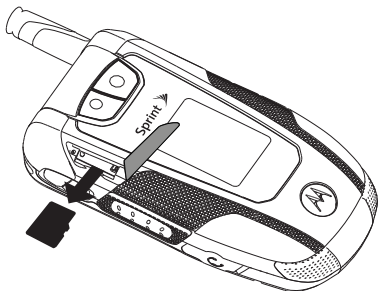

3. Close the top of the cardholder.

**Note:** **DO NOT** remove your memory card while your phone is using it or writing files on it. Doing so will result in loss or damage of data.

### Viewing the microSD Card Indicator

After you have inserted the microSD card, your phone displays **Memory Card** as a place to store your pictures and videos.

To view the external memory associated with your microSD card:

- ▶ Press  > **Pictures** > **My Albums**. Your phone displays the Memory Card option.

**Note:** To view music files stored on you microSD card, press  > **Music** and follow the prompts.

## Using the microSD Adapter

You can transfer files stored in your microSD card to an SD-compatible PC by using the microSD adapter. Because regular SD memory cards differ in size from microSD cards, their corresponding card slots differ as well.

The microSD adapter is sized to fit in a regular-size card slot. To fit a microSD card into a regular-size card slot, insert the microSD card in the adapter. You can then insert the adapter into a regular SD card slot.

**To insert the microSD card into the microSD adapter:**

1. With one hand, hold the microSD adapter with the label facing up.
2. With the other hand, hold microSD card with the writing facing up and the narrow edge toward the adapter.
3. Gently slide the card until it is fully inserted.

**To remove the microSD card from the microSD adapter:**

- ▶ Holding the exposed edge of the microSD card, gently pull it out of the adapter.

**To transfer data from your microSD card to your PC:**

1. Press **[Home]** > **Pictures** > **My Albums**. Your phone displays the Memory Card option.
2. Verify that the microSD card contains the files you want to transfer.
  - If you need to add or delete pictures or videos from your microSD card, see “Storing Pictures in Your microSD Card” on page 184 and “Storing Videos in Your microSD Card” on page 189.
3. Remove the microSD card and insert it in the microSD adapter as explained above.

4. Insert the microSD adapter into the appropriate slot in an SD-compatible PC.
5. Select the files you want to copy from the card and drag them to the appropriate folder displayed on your PC. (Consult your operating system documentation for further details.)

Then just remove the microSD adapter from the PC, remove the microSD card from the adapter and re-insert into your phone.

**Note:** You cannot transfer data from your phone or microSD card to your PC by using a USB cable.

---

DO NOT use your computer to change or edit folder or file names on the microSD, and do not attempt to transfer large amounts of data from the computer to the microSD card. Doing so may cause the microSD card to fail.

---

DO NOT turn off or restart your computer, or put it into standby mode, while using a mass storage device. Doing so will result in loss or damage of data.

---

If you connect a mass storage device to a peripheral device, your device may not work properly.



## Placing Music Files on the microSD to Play on Your Phone

You can transfer music files stored on your SD-compatible PC to your microSD card by using the microSD adapter and then play these files on your phone. These files must be in MP3 or M4A (ACC) format.

<b>Note:</b>	Not all MP3 or M4A (ACC) files that you might place on your microSD card using the microSD adapter can be played on your phone. The file's Digital Rights Management settings may prohibit them from being played.
--------------	--

**To create a folder on your microSD card in which to place music files:**

- ▶ With a formatted microSD card in your phone, access the Sprint Music Store. A folder called “Music” is created on your microSD card. You only need to do this once to create this folder.

After the “Music” folder has been created, use the microSD card adapter to transfer music files from your computer to the “Music” folder on your microSD card.

**To play the music files you placed in the “Music” folder on the microSD card:**

- ▶ Access the Sprint Music Store. If the music files are compatible with your phone, you can play them like music files you have purchased and downloaded from the Sprint Music Store.

For more information on using the Sprint Music Store, refer to the *Experience Sprint Power Vision* guide that came with your phone.

# Working With the microSD Card

---

## Formatting the microSD Card

Your phone automatically formats your microSD card. However, if you cannot save files on your microSD, you may need to format the card yourself.

To format your microSD card:

1. Insert the microSD card. See “Inserting the microSD Card” on page 169.
1. Press  > **Settings/Tools** > **Tools** > **File Manager**.
2. Select **External Memory**.
3. Press **Options** (right softkey).
4. Select **Format**. (A warning will be displayed.).
5. If you are sure you wish to remove all the files from your microSD card, press **Yes** (left softkey).

**Note:**

The formatting procedure erases all the data on the microSD card, after which the files CANNOT be retrieved. To prevent the loss of important data, check the contents before you format the card.

# Using the Built-in Camera

---

## In This Section

---

- ◆ Taking Pictures
  - ◆ Storing Pictures
  - ◆ Shooting Videos
  - ◆ Sending Pictures and Videos
  - ◆ Using Sprint Picture Mail
- 

**Your phone's built-in camera and camcorder give you the ability to take full-color digital pictures and videos.** You can use your phone to share your pictures and videos with others. It's fun and easy to do.

This section explains the features and options of your phone's built-in camera and camcorder.

# Taking Pictures

---

Taking pictures with your phone's built-in camera is as simple as choosing a subject, pointing the lens, and pressing a button.

Your camera features three different resolutions settings — **Economy**, **Normal**, or **Fine** — that let you balance the sharpness of the picture and the size of the file. You can use the zoom to get up to 8X closer to your subjects.



After you take a picture, you can store both in your phone and on your microSD card. You can also easily share them with friends using one of the many options. There are also fun editing tools, so you can make your pictures really special.

**To take a picture:**

1. Press  > **Pictures** > **Camera**.

## Shortcut:

With the phone in standby mode, press the **Camera Key** on your phone's keypad or the **External Camera Key** on the side of the phone. (See the illustration on page 10.) When the phone is closed, press and hold the **External Camera Key** to activate the camera.

2. Using the display screen as a viewfinder, aim the camera lens at your subject.
3. Press **Capture** (left softkey), press the **Camera Key**, press the **External Camera Key**, or press . (The picture will automatically be saved in the **In Phone** folder.)
  - To take another picture, press .

## After Picture Options

After you take picture, press **Options** (right softkey) to do any of the following:

- **Assign** to use the picture as a screensaver, an identifier for calls with or without ID, and as a Picture ID for Contacts entries.
- **Send to Contacts** to transmit the picture to recipients in your Contacts.
- **Print** to send the picture to a printing service, using Sprint Picture Mail.
- **Post To Service** to send the picture to a variety of services, using Sprint Picture Mail.
- **Upload** to save the picture you just took to the Sprint Picture Mail Web site ([www.sprint.com/picturemail](http://www.sprint.com/picturemail)). Depending on your settings, you may be prompted to accept a data connection.

### Note:

If this is the first time you have accessed your Sprint Picture Mail account, you will be prompted to create a password.

See the *Experience Sprint Power Vision* guide that came with your phone for information about Picture Mail.

- **Review/Send Media** to display your In Phone album. See “My Albums” on page 182 for more details and options.
- **Add Text Caption** to enter and attach a brief text note to the picture.
- **Add Voice Caption** to record and attach a brief audio note to the picture.
- **Delete** to delete the picture you just took.
- **Take New Picture** to take another picture.
- **Properties** to view technical information about the picture you just took.

## Camera Options



Your camera has many features that help you take professional-looking pictures quickly and easily. When the phone is in camera mode, press **Options** (right softkey) and then choose one of these features:

- **Icons Display** to show or hide your camera's indicators from the viewfinder.
- **Flash** to turn your phone's flash on and off.
- **Self Timer** to activate the camera's timer. (See page 181.)
- **Image Control** to control the resolution, quality, brightness, and white balance:
  - **Resolution** to determine a picture's sharpness.
  - **Quality** to set the quality of the file: **Economy**, **Normal**, or **Fine**.
  - **Brightness** to set the amount of light in a picture.
  - **White Balance** to adjust your camera to these lighting environments: **Auto**, **Sunny**, **Cloudy**, **Tungsten**, **Fluorescent**, or **Manual**. Choose **Auto** have your phone adjust white balance as needed. Choose **Manual** to set a custom level of white balance.
- **Fun Tools** apply color effects or frames to your pictures or set your camera to take multiple shots:
  - **Color Effect** to apply different color effects to the picture: **Normal**, **Sepia**, **Black and White**, or **Negative**. (The default setting is **Normal**.)
  - **Apply Fun Frame** to decorate your picture with a digital frame. Your phone offers you an array of choices.
  - **Multiple Shots** to set your phone's camera to take two or four shots in succession.

- **Settings > Shutter Sound** to set the sound your camera makes when you take a picture. Your phone offers you an array of choices.
- **View All** to view the pictures stored in My Albums (see page 182).
- **Camcorder Mode** to switch to Camcorder mode (see page 187).

## Setting the Self Timer

To begin the Self Timer:

1. From camera mode, press **Options** (right softkey) and then select **Self Timer**.
2. Highlight the time delay you want to use (**2, 5, 10, or 15 Seconds**) and press . (The viewfinder displays the Self Timer countdown.)
3. Press  or **Capture** (left softkey) to begin the timer, and get ready for the picture.

**Note:** While the Self Timer is active, all keys are disabled except  and **Capture** (right softkey).

## Using the Zoom

This feature allows you to get closer to or farther away from an object when you take its picture. You can adjust the zoom from 1X to 8X.

To use the zoom:

1. From camera mode, press the navigation key right or left to adjust the zoom. (A slider is displayed.)
2. Press **Capture** (left softkey) or press . (The picture will automatically be saved in the **In Phone** folder.)

# Storing Pictures

---

You can store your pictures in your phone's memory, your microSD card, and your Sprint Online Album. Your Sprint Online Album is your designated storage space on the Sprint Picture Mail Web site.

## My Albums

After a picture is taken, it is automatically saved in the **In Phone** folder of My Albums. From the **In Phone** folder, you can view your pictures, save them to your Sprint Online Album, delete them, and access additional options.

To view the pictures stored in the **In Phone** folder:

1. Press  > **Pictures** > **My Albums** > **In Phone**.
2. Use your navigation keys to scroll through the pictures.

## My Albums Options

When you are viewing My Albums, you can customize both the picture and the actual viewing experience.

Press **Expand** (left softkey) to switch the display from thumbnails to one expanded picture that fits your screen. Use your left and right navigation keys to scroll through the pictures. Pressing **Thumbnails** (left softkey) switches the display from one expanded picture back to thumbnails.

For more options, press **Options** (right softkey), select one of the following functions, and then follow the prompts.

**Note:**

Not all options will be available for all pictures or from all menus.



- **Send** to transmit the picture to recipients in your Contacts or to send the picture to a variety of services, using Sprint Picture Mail.
  - **To Contacts** to transmit the picture to recipients in your Contacts.
  - **To Services** to send the picture to a variety of services, using Sprint Picture Mail.
- **Print** to send the picture to a printing service, using Sprint Picture Mail.
- **Manage** to delete, upload, copy, move, select, unselect, and rename pictures.
  - **Delete** to erase the selected picture.

**Note:**

Deleting pictures will free up memory space in your phone to enable you to take more pictures. Once deleted, pictures cannot be uploaded to your online Sprint Picture Mail account.



- **Upload** to upload files from My Album to the Sprint Picture Mail Web site ([www.sprint.com/picturemail](http://www.sprint.com/picturemail)). Depending on your settings, you may be prompted to accept a data connection.
- **Copy To** to copy the selected picture to another location.
- **Move To** to move the selected picture to another location.
- **Select, Select All, Unselect, and Unselect All** allow you to choose and clear pictures for editing or viewing changes.
- **Rename** to assign a different name to the picture. Use your keypad to enter the new name.
- **Properties** to view technical information about the selected picture.

- **Slideshow** to display the pictures in letterbox and play a slide show.
- **Filter By** to control which item are shown: **Show All**, **Pictures Only**, or **Videos Only**.
- **My Albums** to return to the main My Albums menu.

## Storing Pictures in Your microSD Card

Storing pictures in your microSD card frees up memory in My Phone and allows you to transfer photo files to other SD-compatible devices.

To save a picture to the microSD card:





1. Press  > **Pictures** > **My Albums** > **In Phone**.
2. Highlight a picture you wish to save to the microSD card and then press . A checkmark appears on the lower right corner of the picture.
3. Press **Options** (right softkey).
4. Select **Manage** > **Move To** > **External Memory** and then press .

# Shooting Videos

Your phone's built-in video camera allows you to record and view full-color digital videos and send them to your friends and family.

You can shoot videos up to 30 seconds long. The camcorder also features an 8X zoom to let you take close-up videos. After you shoot the video, you can use your phone's many storage and messaging options as well as the fun editing tools.

To record a video:

1. Press  > **Pictures** > **Camcorder**, or press and hold .
2. If prompted, select a video mode:
  - **Video Mail** to record a short video that can be sent using Sprint Picture Mail.
  - **Long Video** to record a longer video (depending on space available on your microSD card).
3. Using display screen as a viewfinder, aim the camcorder lens at your subject.
4. Press **Record** (left softkey) or press .
5. Press **Stop** (right softkey) to finish recording before the 30 second maximum. (The video will automatically be saved in the **In Phone** folder.)
  - To shoot another video, press .

## After Video Options

After you shoot the video, select **Options** (right softkey) to choose one of the following:

- **View All** to all the videos and picture you have saved.
- **Assign** to assign the video to a Contact as a video ringer.
- **Send To Contacts** to transmit the video to recipients in your Contacts.

- **Print** to send the video to a printing service, using Sprint Picture Mail.
- **Post To Service** to send the video to a variety of services, using Sprint Picture Mail.
- **Upload** to upload the video you just shot to the Sprint Picture Mail Web site ([www.sprint.com/picturemail](http://www.sprint.com/picturemail)). Depending on your settings, you may be prompted to accept a data connection.

**Note:**

If this is the first time you have accessed your Sprint Picture Mail account, you will be prompted to create a password.

---

See the *Experience Sprint Power Vision* guide that came with your phone for information about Picture Mail.

- **Review/Send Media** to display your In Phone album. See “My Albums” on page 182 for more details and options.
- **Delete** to delete the video you just took.
- **Record New Video** to record another video.
- **Properties** to view technical information about the video you just took.
- **Take Picture** to activate the Camera.

## Camcorder Options

Your phone's camcorder has many features that help you shoot professional-looking videos quickly and easily.

<b>Note:</b>	Not all options will be available for all videos or from all menus.
--------------	---

When the phone is in camcorder mode, press **Options** (right softkey) to access these features. They work as described in "Camera Options" on page 180.

- **Icons Display** to show or hide your camcorder's indicators from the viewfinder.
- **Flash** to turn your phone's flash on and off.
- **Self Timer** to begin a timer that delays the start of the video shoot.
- **Image Control** to control the resolution, quality, brightness, and white balance:
  - **Resolution** to determine a picture's sharpness: **High**, **Medium**, or **Low**.
  - **White Balance** to adjust your camcorder to these lighting environments — **Auto**, **Sunny**, **Cloudy**, **Tungsten**, **Fluorescent**, or **Manual**.
  - **Brightness** to change the lighting of a scene.
- **View All** to view the videos stored in My Albums.
- **Camera Mode** to activate the camera.

# Storing Your Videos

---

You can store your videos in My Albums, your Sprint Online Album, and your microSD card. Your Sprint Online Album is your designated storage space on the Sprint Picture Mail Web site.

## My Albums

After you shoot a video, it is automatically saved in the **In Phone** folder of My Albums. From the **In Phone** folder, you can play your videos, upload them your Sprint Online Album, delete videos, and access additional options.

To view the videos stored in My Albums:

1. Press  > **Pictures** > **My Albums** > **In Phone**.
2. Use your navigation keys to scroll through the video thumbnails.

## My Video Options



When you are viewing videos, you can customize both the video and the actual viewing experience.

For details on your options, see “My Albums Options” on page 182.

## Storing Videos in Your microSD Card

Storing videos in your microSD card frees up memory in My Album and allows you to transfer video files to other SD-compatible devices.

To save a video to the microSD card:

1. Press  > **Pictures** > **My Albums** > **In Phone**.
2. Highlight a video you wish to save to the microSD card and then press . A checkmark appears on the lower right corner of the thumbnail.
3. Press **Options** (right softkey).
4. Select **Manage** > **Move To** > **External Memory** and then press .

## Playing Video Clips Stored in Your microSD card

You can also play video clips stored in you microSD card. These can be shot by you and stored in your microSD card as well videos shared with you by others.

To play a video clip stored in your microSD card:

1. Press  > **Pictures** > **My Albums** > **Memory Card**.
2. Highlight a stored video.
3. Press **Options** (right softkey) and then press **Play**.

## Sending Pictures and Videos

After you have taken a picture or shot a video, you can share it with family and friends. You can send pictures or videos to up to 16 people at a time using their email addresses or their phone numbers.

Each Picture Mail can contain up to 28 pictures or two videos.

## Sending Pictures and Videos From My Albums

You can send pictures and videos directly from My Albums.

To send pictures or videos from My Albums:

1. Press **☰** > **Pictures** > **My Albums** > **In Phone** or **Memory Card**.
2. Highlight a picture or video you wish to send and then press **☑**. A checkmark appears on the lower right corner of the thumbnail.
3. Press **Options** (right softkey) > **Send**.
4. Select **To Contacts** and press **☑**.
5. Add recipients for the message and press **Next** (left softkey).
  - To enter a recipient directly, highlight the **Add Mobile #** field and enter a wireless phone number, or highlight the **Add Email** field and add an email address.
  - To add a recipient from Contacts, select **Add from Contacts**, select the desired contact(s), and press **Done** (left softkey).
  - To add a recently used recipient, select **Add Recent Recipients**, select the desired contact(s), and press **Done** (left softkey).
6. Select the desired options to include a text message or a voice recording, or to set the message priority.
7. Confirm your recipients, message, voice recording, and picture or video.
8. Press **Send** (left softkey) to send your picture mail.

**Note:**

The first time you send Sprint Picture Mail, you will be prompted to establish an account and password.



## Sending Pictures and Videos From Messaging

You can also send pictures and videos from your Messaging menu, using the Picture Mail application.

To send pictures and videos from the Messaging menu:

1. Press **[App Icon]** > **Messaging** > **Send Message** > **Picture Mail**.
2. Add up to 16 recipients for the message and press **Next** (left softkey).
  - To enter a recipient directly, highlight the **Add Mobile #** field and enter a wireless phone number, or highlight the **Add Email** field and add an email address.
  - To add a recipient from Contacts, select **Add from Contacts**, select the desired contact(s), and press **Done** (left softkey).
  - To add a recently used recipient, select **Add Recent Recipients**, select the desired contact(s), and press **Done** (left softkey).
3. Add pictures or videos to your message.
  - To add an existing picture or video, select **In Phone**, **Memory Card**, or **OnLine Albums**, select the desired files, and press **Next** (left softkey).
  - To add a new picture or video, select **Take New Picture** or **Take New Video**, capture the new picture or video, and press **Accept** (left softkey).
4. If desired, add a subject and a text message.
5. When you have finished, press **Send** (left softkey) to send the message.

### Note:

You can attach the entire album or any media online to send a Picture Mail message to any recipients from the phone.

# Using Sprint Picture Mail

---

Uploading pictures and videos to your Sprint Picture Mail account is a good way to save memory on your phone, and share them with others.

You can use your personal computer to manage your pictures. From the Sprint Picture Mail Web site, you can share pictures and videos, create and edit albums, add captions, and organize files. You can even send your pictures to be printed at participating retail locations.

Sprint Picture Mail offers tools to improve and customize your pictures. You'll be able to lighten, darken, crop, add antique effects, add comic bubbles and cartoon effects, and use other features to transform your pictures.

## Creating Your Sprint Picture Mail Password

Before you can begin using Sprint Picture Mail, you need to establish a password. Use this password to log on to the Sprint Picture Mail Web site at [www.sprint.com/picturemail](http://www.sprint.com/picturemail).

To create your Sprint Picture Mail password:

1. Press  > **Pictures** > **My Albums** > **OnLine Albums** > **View Albums**. (You will be prompted to register your Sprint Picture Mail account and create a password.)

<b>Note:</b>	If your Sprint Service Plan does not include Sprint Picture Mail, you will first be prompted to subscribe to the service for an additional monthly charge.
--------------	--

2. Enter a four-digit to eight-digit password and press . (You will be prompted to confirm your password.)

<b>Tip:</b>	Write down your Sprint Picture Mail password in a secure place.
-------------	---

3. Please wait while the system creates your account.

## Visiting the Sprint Picture Mail Web Site

After you receive confirmation that your account has been registered, you can access the Sprint Picture Mail Web site and begin uploading and sharing pictures.

To visit the Sprint Picture Mail Web site:

1. Open your computer's browser and go to [www.sprint.com/picturemail](http://www.sprint.com/picturemail).
2. Enter your phone number and Sprint Picture Mail password to register.

## Uploading Pictures and Videos

You can upload pictures and videos directly to your Sprint Picture Mail account from your phone.

To upload pictures or videos directly from your phone:

1. Press **[OK]** > **Pictures** > **My Albums** > **In Phone** or **Memory Card**.
2. Select the pictures or videos you want to upload and press **Options** (right softkey) > **Manage** > **Upload**.
3. After your phone connects to the Picture Mail site, select an album for your uploaded pictures or videos and press **Upload** (left softkey).
4. To view an album, highlight it and press **[OK]**.

## Viewing Pictures and Videos

After you upload your pictures and videos to the Sprint Picture Mail site, you can manage, edit, and share them.

To view your online pictures from your phone:

1. Press **[OK]** > **Pictures** > **My Albums** > **OnLine Albums**.
2. Select an album to display and press **[OK]**.

## Sending Pictures and Videos

You can send pictures and videos from your Online Albums view.

To send pictures and videos from online albums:



1. From the online albums display, select a picture or video and press **Send** (left softkey).
2. To complete and send the message, follow steps 4-7 under “Sending Pictures and Videos From My Albums” on page 190.

## Working With Pictures Stored Online

You can manage the pictures you have uploaded to Sprint Picture Mail from your phone and online. You can create, view, and edit albums, download pictures to your phone, and share your albums.



### Managing Pictures

To manage your pictures from your phone:

1. Press  > **Pictures** > **My Albums** > **OnLine Albums**.
2. Select an album to display and press .
3. Select a picture and press **Options** (right softkey) to display your options.
4. To select an option, highlight it and press 
  - **Copy/Move** to copy and move pictures to a selected album.
  - **Create Album** to create a new online album.
  - **Go to Album List** to view your list of albums.
  - **Delete** or **Delete All** to delete the selected picture or all pictures from the current album.
  - **Unselect**, **Select All**, or **Unselect All** to change your current selection.



## Downloading Pictures and Videos to Your Phone

To download pictures and videos from the Sprint Picture Mail Web site:

1. Press  > **Web**.
2. Press **Options** (right softkey) and then select **Go To URL**.
3. Use your keypad to enter [www.sprint.com/picturemail](http://www.sprint.com/picturemail) and press **Go** (left softkey).
4. Enter your phone number and password.
5. Select an album and display a picture or video. (To display additional pictures or videos, highlight **Next**, and then press .)
6. Select **Download** and press . (The selected item will download and be placed in My Album.)

## Sharing Albums

To send an album from the Sprint Picture Mail Web site:

1. From the Picture Mail Web site (see steps 1-4 under "Downloading Pictures and Videos to Your Phone"), select an album, scroll to **Album Options**, and press .
2. Select **Share Album: "<name>"**.
3. Enter a recipient from your Address Book, or enter an email address or wireless phone number.
4. If desired, enter a message.
5. Select **Send** and press  to send the album.

**Note:**

For more information on using Sprint Picture Mail, visit [www.sprint.com/picturemail](http://www.sprint.com/picturemail).

# Using the Built-in Media Player

---

## In This Section

---

- ◆ **Your Multimedia Channel Options**
  - ◆ **Accessing Your Media Player's Channel Listings**
  - ◆ **Playing a Video or Audio Clip**
  - ◆ **Multimedia FAQs**
- 

**Your phone's built-in media player gives you the ability to listen to audio clips and to view video clips right from your phone's display.** It's a great way to stay up-to-date on news, weather, and sports information while also enjoying the latest blockbuster movie trailers or music videos — anywhere, anytime on the Nationwide Sprint PCS Network. Just access your media player from your phone's main menu, scroll to your choice of channel, and select one of the video or audio clips to play. It's like having a TV in the palm of your hand.

This section explains the features and options of your phone's built-in media player.

# Your Multimedia Channel Options

---

Sprint TV offers a variety of accessible audio or video channels, depending on your Sprint service plan and multimedia subscriptions. Your subscription options include a comprehensive basic service as well as a full menu of additional channel options.

- **Preview Channel:** This free channel lets you sample clips from all the available channels before you make a decision to subscribe. It's like viewing the movie preview before deciding whether you want to spend the money to go see the full motion picture.
- **Sprint TV:** This comprehensive basic service gives you access to a variety of content from familiar brands. Think of it as “basic cable” for your phone. It allows you unlimited access to this content as long as you continue to pay the monthly subscription fee.
- **Available Individual Channel Options:** You also have the option of subscribing to individual channels from an extensive menu offering. These channels are available for a monthly subscription fee and allow you unlimited access as long as you continue to pay your monthly subscription fee.

You can always visit [www.sprint.com](http://www.sprint.com) for a comprehensive up-to-date Channel Guide that provides an explanation of the available channels and information on subscription rates.

# Accessing Media Player's Channel Listings

---

It's easy to access and view the channel listings on your **i902** by Motorola from the phone's main menu.

To access your media player and channel listings:

- ▶ Press  > **Media Player** > **Channel Listing**. Depending on your settings, you may be asked to accept the connection.

Your channel listings will be displayed, divided into the following sections:

- **My Channels:** These include the complimentary Previews channel that Sprint provides, as well as any available individual channels for which you have purchased access. If you have purchased Sprint TV, either through a Vision Plan subscription or by purchasing it separately, it will be displayed here.
- **Available Channels:** These are channels that have not yet been purchased but are available to access for a monthly subscription fee. Use your navigation key to scroll through and select a channel, and follow the instructions to purchase access to it. Upon purchasing access to one of these channels, the channel will be listed, along with its corresponding channel number, in the **My Channels** section of your media player's channel listings. You will see it displayed in this section the next time you access your phone's media player.



# Playing a Video or Audio Clip

To select and play a media clip:

1. Press **[OK]** > **Media Player**.
2. Use your keypad to enter a channel number (or use your navigation key to scroll to a channel and press **[OK]**).
  - **My Channels:** If you have selected a channel that you've already signed up for (or if it's a channel with no monthly fee), you will see a list of available clips.
  - **Available Channels:** If you have selected a channel that you have not yet signed up for, you will be prompted to accept the corresponding monthly charge. Follow the prompts to subscribe to the selected channel. (A list of available clips will be displayed.)
3. Scroll to the clip that you would like to play and press **Select** (left softkey) or **[OK]**. (The clip will automatically load and begin playing.)

**Note:**

The first time you access one of your Available Channels, you will be prompted to accept the corresponding monthly fee (unless the channel doesn't have a monthly fee). Accepting the charge gives you access to the channel for as long as you pay the monthly fee. If you accept the charge, the next time you access your phone's media player, this channel will be displayed in the My Channels section of your channel listings.

# Multimedia FAQs

---

**1. Will I know if I'm receiving an incoming call while I'm viewing or listening to an audio clip?**

No. All incoming calls will roll into voicemail while you are playing a clip. If the caller leaves a voicemail, the  voicemail icon will be displayed on the screen.

**2. How long are the clips? Will I know the estimated time it will take to play the clip prior to accessing it?**

Once you have selected a channel, you will see a listing of the available clips, with each clip's length displayed after the clip's title. In general, a clip's duration will depend on the story or content being provided, and can be fairly short or as long as a few minutes.

**3. Can I access a multimedia clip wherever I am, as long as I have my phone?**

As long as you are on the Nationwide Sprint PCS Network, you will have access to the audio and video clips.

**Note:**

Sprint TV Service does not work while roaming off of the Nationwide Sprint PCS Network or where service is unavailable.

**4. Are the videos that I'm viewing "live" videos?**

It depends on the content provider. Some of the channels available through Sprint TV stream live content. Others provide media on demand with video and audio clips that are refreshed throughout the day, but that are not "live."

5. **After purchasing access to an Available Channel for a monthly fee, do I receive any confirmation? That is, how do I know it has been purchased?**

The next time you access your media player's channel listings, the purchased channel title and corresponding number will be displayed in the My Channels section.

6. **Why are some channels already preloaded into the My Channels section?**

Some channels, such as Previews, are offered free of charge as a customer courtesy. These channels are automatically displayed in the My Channels section of your channel listings.

7. **If I don't subscribe to a Sprint Power Vision Plan, will I still be able to view the multimedia clips?**

Yes. For service access charges, please consult your Sprint Service Plan or visit [www.sprint.com](http://www.sprint.com).

8. **How can I easily access a channel without having to scroll through all the channels in my channel listings?**

Each channel will have a number to the left of it. You can simply press this number to quickly access the clips located within that channel.

**Tip:**

When entering the specific channel number, channels 01—09 do not require you to enter a "0." For example, to access channel "07," just press the "7" key.

9. **What does it mean when the video pauses and I see the word "loading" at the bottom of the screen?**

This happens when the media player is loading the data necessary to play the clip. It typically occurs when there is heavy traffic on the network.

- 10. How can I cancel service if I decide I don't want it?**  
To cancel your Sprint TV Service, visit [www.sprint.com](http://www.sprint.com) and sign on to **My Sprint Wireless** with your phone number and password. From this page, you have the ability to cancel the service or any Available Channels to which you subscribe.
- 11. Can I surf to a different channel while I am playing a clip?**  
Yes. While you are playing a clip, you can use the up and down navigation buttons to surf to a different channel. A small pop-up screen will be displayed that tells you which channel you are watching as well as other channels that you have access to. Use the navigation buttons to scroll through the different channels. Once you find a channel that you want to watch, scroll to it and press  (or simply wait approximately three seconds), and the channel will begin loading.

# Using Bluetooth

---

## In This Section

---

- ◆ Turning Bluetooth On and Off
  - ◆ Setting Up Your Bluetooth
  - ◆ Transferring Files Between Your Phone and Your PC
  - ◆ Bluetooth Profiles
- 

**Your phone features built-in Bluetooth technology, allowing you to share information more easily than ever before.** Bluetooth is a short-range communications technology that allows you to connect wirelessly to a number of Bluetooth devices, such as headsets and hands-free car kits, and Bluetooth-enabled handhelds, PCs, printers, and wireless phones. The Bluetooth communication range is usually up to approximately 10 meters (30 feet).





This section details how to set up and make the most of your phone's Bluetooth capabilities.

# Turning Bluetooth On and Off

---

By default, your device's Bluetooth functionality is turned off. Turning Bluetooth on allows your phone to connect to other Bluetooth-capable devices.

To turn Bluetooth on or off:



1. Press  > **Settings/Tools** > **Tools** > **Bluetooth**.
2. Press **Options** (right softkey).
3. Highlight **Settings** and press .
4. Highlight the **Bluetooth Power** field and press .
5. Use your navigation key to select **On** or **Off**, as desired and then press .
6. Press **Save** (left softkey) to save your settings.

**Note:**

To extend battery life, set Bluetooth power to **Off** when not in use.

## Bluetooth Status Indicators

The following icons show your Bluetooth connection status at a glance:

-  — When the icon appears solid, it indicates Bluetooth is powered on. When the icon appears flashing, it indicates your phone is visible (or discoverable) to other Bluetooth equipped devices.
-  — Bluetooth is connected.

# Setting Up Your Bluetooth

---





You need to connect your phone to your Bluetooth headset before you can begin using it. To do this, you need to:

- Enter the name your phone uses for Bluetooth communication.
- Set your phone to be discovered by other Bluetooth devices.
- View your phone's Bluetooth address.

## Your Phone's Bluetooth Name

Your phone's Bluetooth name will be seen by other in-range Bluetooth devices, depending on your Visibility settings. Your phone comes with a default Bluetooth name. You can change this to make it easy for others to find you.



To change the default Bluetooth name:

1. Press  > **Settings/Tools** > **Tools** > **Bluetooth**.
2. Press **Options** (right softkey).
3. Highlight **Settings** and press .
4. Highlight the **Device Name** field and then press .
5. Use your keypad to enter a new name and then press .
6. Press **Save** (left softkey).

## Find Me

By enabling Find Me, you make your phone visible (or discoverable) to other Bluetooth equipped devices.

To enable Find Me and make your phone visible to other Bluetooth devices:

1. Press  > **Settings/Tools > Tools > Bluetooth.**
2. Highlight **Find Me** and press .



Your phone makes itself visible to other Bluetooth devices for three minutes.

## Paired Devices

Bluetooth pairing establishes trusted connections between your phone and another Bluetooth device. When devices are paired, a passkey is shared between devices, allowing for fast, secure connections. This bypasses the discovery and authentication process.

Before trying to connect to another Bluetooth device, make sure your phone's Bluetooth power is **On**; the Bluetooth device is must be ready to pair (see the device's user's guide for instructions).

To pair your phone with another Bluetooth device:

1. Press  > **Settings/Tools > Tools > Bluetooth.**
2. Highlight **Add New** and press . (Your phone will display a list of discovered in-range Bluetooth devices. If your phone is already connected to a device, your phone lists that device and identifies it.)
3. Select the device you wish to pair with and press .



**Note:** Due to different specifications and features of other Bluetooth-compatible devices, display and operations may be different, and functions such as transfer or exchange may not be possible with all Bluetooth-compatible devices.

After a connection is established with a device, no other device can connect to your phone until the currently connected device is disconnected.



When the connection is made, a Bluetooth message with the name of the connected device appears on the home screen.

**Tip** For specific information about an accessory, refer to the instructions that came with it.

## Waiting for Pairing

If you wish to pair your phone with another device, you will need to allow the other device to initiate pairing with your phone.



**To pair your phone with another Bluetooth device:**

1. Press  > **Settings/Tools** > **Tools** > **Bluetooth**.
2. Highlight **Find Me** and press .
3. Initiate pairing from the other device.

## Your Phone's Bluetooth Address

Your phone Bluetooth address is a unique address that allows other Bluetooth devices to pair with it.

**To view your phone's Bluetooth address:**

1. Press  > **Settings/Tools** > **Tools** > **Bluetooth**.
2. Press **Options** (right softkey).
3. Highlight **Settings** and press .

4. Press **Options** (right softkey) and select **Properties** to view information about your Bluetooth feature, including the Bluetooth Address.

## Transferring Files Between Your Phone and Your PC

---

You can transfer files such as music, pictures, and video between your phone and Bluetooth-enabled PC or similar device. You do this using the File Transfer Profile (FTP) in your phone and the Bluetooth FTP client software found in most Bluetooth-enabled PCs. No external FTP client is necessary.

Before transferring files, your phone must be paired with a PC. (For information on pairing, see “Paired Devices” on page 206.) After pairing, you can browse and transfer folders and files between your PC and your phone’s internal memory or the microSD card inserted in your phone.

The types of files you can transfer in this way are stored in the following locations:

- In the phone’s memory:
  - For music, the **audio** folder.
  - For pictures, the **incamera** folder.
  - For video, the **incamcorder** folder.
- On the microSD card:
  - For music, the **Music** folder or **Media** folder.
  - For pictures, the **DCIM** folder.
  - For video, the **DCIM** folder.

# Bluetooth Profiles

---

All of the Bluetooth settings you configure are stored in your phone's Bluetooth user profile. Different profiles can be used for specific Bluetooth functions.

- **File Transfer Profile (FTP)** — This profile functions as a wireless data cable allowing the browsing and transfer of files using the Bluetooth client software available on most Bluetooth-enabled PCs. Files such as music, pictures, and videos can be transferred between the PC and the phone's internal memory or the microSD card inserted in the phone
- **Headset Profile** — This profile functions as a wireless ear jack. When an incoming call is received, the ringer can be heard through the headset instead of through the handset. The call can then be received by pushing a button. While using the handset, you can use the headset instead of the phone by pushing a button on the headset, the same as inserting a jack into the phone. Increase or decrease the volume by using the volume key on the side of the headset.
- **Hands-Free Profile** — This profile functions as a wireless car kit. Incoming calls ring to the hands-free headset or device. Calls can be received by pressing a button on the headset or device. For dialing, four functions are supported: recent call dial, voice dial, speed dial, and number dial. Increase or decrease the volume by using the volume key on the side of the handset.
- **Dial-Up Network Profile (DUN)** — This profile functions as a wireless data cable, connecting a PC or PDA to a network through your handset.

- **Object Push Profile (OPP)** — This profile functions as a mechanism to allow for the transfer of contact information. Contacts and your business card can be transferred to other Bluetooth devices using this profile. In addition, this profile allows the phone to accept and receive contact and business card information from other Bluetooth devices.
- **Advanced Audio Distribution Profile (A2DP)** — This profile functions as a wireless stereo connection to stereo Bluetooth headsets.
- **Audio/Video Remote Control Profile (AVRCP)** — This profile functions as a wireless remote control. In combination with A2DP, an AVRCP enabled stereo headset can be used to play, pause, stop, fast forward, or rewind music. Skipping to the next or previous track is also supported.

# **Service Features**



# Sprint Service Features: The Basics

---

## In This Section

---

- ◆ Using Voicemail
  - ◆ Using SMS Text Messaging
  - ◆ Using SMS Voice Messaging
  - ◆ Using Caller ID
  - ◆ Responding to Call Waiting
  - ◆ Making a Three-Way Call
  - ◆ Using Call Forwarding
  - ◆ Updating Phone Software
- 

Now that you've mastered your phone's fundamentals, it's time to explore the calling features that enhance your **Sprint Service**. This section outlines your basic Sprint Service features.

# Using Voicemail

## Setting Up Your Voicemail



All unanswered calls to your phone are automatically transferred to your voicemail, even if your phone is in use or turned off. Therefore, you will want to set up your Sprint Voicemail and personal greeting as soon as your phone is activated. If you need to set up your voicemail, see “Setting Up Your Voicemail” on page 4.

## Voicemail Notification

There are several ways your phone alerts you to a new message:

- By displaying a message on the screen.
- By sounding the assigned ringer type.
- By displaying  at the top of your screen.

**Note:**

When you are roaming off the Nationwide Sprint PCS Network, you may not receive notification of new voicemail messages. It is recommended that you periodically check your voicemail by dialing  + area code + your phone number. When your voicemail answers, press  and enter your passcode.

Your phone accepts messages even when it is turned off. However, you are only notified of new messages when your phone is turned on and you are in a Sprint service area.

## Sending an Incoming Call to Voicemail

To send an incoming call directly to voicemail, do one of the following:



- ▶ Press **Ignore** (right softkey).

## Retrieving Your Voicemail Messages

You can review your messages directly from your wireless phone or from any other touch-tone phone. To dial from your wireless phone, you can either speed dial your voicemail or use the menu keys.

### Using One-Touch Message Access

To retrieve your voicemail messages:

- ▶ Press and hold . (Your phone will dial your voicemail box.)
- ▶ Press  > **Messaging** > **Voicemail** > **Call Voicemail**.

#### Note:

You are charged for airtime minutes when you are accessing your voicemail from your phone.

### Using Another Phone to Access Messages

To review your messages from another phone:

1. Dial your phone number.
2. When your voicemail answers, press .
3. Enter your passcode.

#### Tip:

When you call into voicemail, you first hear the header information (date, time, and sender information) for the message. To skip directly to the message, press  during the header.







## Voicemail Options

Your phone offers several options for organizing and accessing your voicemail.

### Using Expert Mode

Using the Expert Mode setting for your personal voicemail box helps you navigate through the voicemail system more quickly by shortening the voice prompts you hear at each level.





To turn Expert Mode on or off:

1. Press and hold  to access your voicemail. (If your voicemail box contains any new or saved messages, press  to access the main voicemail menu.)
2. Press  to change your Personal Options, following the system prompts.
3. Press  for Expert Mode. Follow the prompts to turn Expert Mode on or off.

### Setting Up Group Lists

You can create up to 20 separate group lists, each with up to 20 customers.

To create a Group List:

1. Press and hold  to access your voicemail. (If your voicemail box contains any new or saved messages, press  to access the main voicemail menu.)
2. Press  to change your Personal Options, following the system prompts.
3. Press  for Settings.
4. Press  for Group Distribution Lists.
5. Follow the voice prompts to create, edit, rename, or delete group lists.

## Sprint Callback

You can return a call after listening to a message without disconnecting from voicemail.

To return a call directly from voicemail:

- ▶ Press  after listening to a message.

## Voicemail-to-Voicemail Message

You can record and send a voicemail message to other Sprint Voicemail users.

To record and send a voicemail message:

1. From the main voicemail menu, press  to send a message.
2. Follow the voice prompts to send your voicemail message.

## Voicemail-to-Voicemail Message Reply

You can record and send a voicemail message in response to a voicemail from any other Sprint Voicemail user.

To respond and send a voicemail message:

1. After listening to a voicemail message, press .
2. Follow the voice prompts to record and send your reply.

## Voicemail-to-Voicemail Message Forwarding

You can forward a voicemail message, except those marked “Private,” to other Sprint Voicemail users.



To forward a voicemail message:

1. After listening to a message, press .
2. Follow the voice prompts to forward the voicemail message.

## Voicemail-to-Voicemail Receipt Request

You can request confirmation that your voicemail message has been listened to when you send, forward, or reply to other Sprint users.



To mark your message receipt requested:

1. After you have recorded a message, press  to indicate that you are satisfied with the message you recorded.
2. Press  to mark receipt requested.
3. Press  to send your voicemail message.

## Extended Absence Greeting

When your phone is turned off or you are off the Nationwide Sprint PCS Network for an extended period, this greeting can be played instead of your normal personal greeting.

To record an extended absence greeting:

1. From the main voicemail menu, press  for Personal Options.
2. Press  for greetings.
3. Press  to record an Extended Absence Greeting.

## Clearing the Message Icon

Your phone may temporarily continue to display the message icon after you have checked your messages.

To clear the icon from the display screen:

- ▶ Press  > **Messaging** > **Voicemail** > **Clear Icon**.

## Vicemail Menu Key

Following the prompts on the voicemail system, you can use your keypad to navigate through the voicemail menu. The following list outlines your phone's voicemail menu structure.

 Listen

 Send

 Personal Options

 Settings

 Skip passcode

 Autoplay

 Message Date & Time On/Off

 Change Passcode

 Group Distribution List

 Numeric Paging to a Wireless Phone

 Return to Personal Options Menu

 Greetings

 Main Greeting

 Recorded Name

 Extended Absence Greeting

 Return to Personal Options Menu

 Expert Mode (On/Off)

 Return to Personal Options Menu

 Place a Call

 Exit



# Using SMS Text Messaging

With SMS Text Messaging, you can send instant text messages from your phone to other messaging-ready phones — and they can send messages to you.

In addition, SMS Text Messaging includes a variety of preset messages, such as “I’m running late, I’m on my way,” that make composing messages fast and easy. You can also customize your own preset messages (up to 160 characters) from your phone.

## Sending a Text Message

To compose an SMS Text message:

1. Press  > **Messaging** > **Send Message** > **Text Message**.
2. Enter the recipients' phone number or email addresses in any of the following ways:
  - To choose from a list of people you recently send messages to, highlight **Add Recent recipients** and press .
  - To choose from your Contacts list, highlight **Add from Contacts** and press .
  - Use your keypad to enter a recipient's phone number under **Add Mobile #:**.
  - Use your keypad to enter a recipient's phone number under **Add Email:**.
3. When you have entered all the recipients, press **Next**.
4. Scroll to **Message** and compose your message.
  - To type a message, use your keypad to enter your message. Press **Options** (right softkey) to select a character input mode.

- To use a preset message, press **Options** (right softkey), select **Insert Preset Msg**, highlight your desired message, and press .
5. To ask the recipient to call you back, select the **Callback** check box and enter the number you can be reached at.
  6. If you want to receive a receipt when you send your message, select the **Return Receipt** check box.
  7. If your message is urgent, select the **Urgent** check box.
  8. Review your message and press **Send** (left softkey).

## Replying to SMS Text Messages

After your phone notifies you that it has received a message, follow the prompts to open and read it. You can also go to your Messaging Inbox by pressing  > **Messaging** > **Text Messaging** > **Inbox**.

To reply to an SMS Text message:

1. While the message is open, select **Reply** (left softkey).
2. Compose your reply or use the preset messages.
  - To type a message, use your keypad to enter your message. Press **Options** (right softkey) to select a character input mode.
  - To use a preset message, press **Options** (right softkey), select **Insert Preset Msg**, highlight your desired message, and press .
3. To ask the recipient to call you back, select the **Callback** check box and enter the number you can be reached at.
4. If you want to receive a receipt when you send your message, select the **Return Receipt** check box.
5. If your message is urgent, select the **Urgent** check box.
6. Review your message and press **Send** (left softkey).

## Using Preset Messages

See “Managing Preset Messages” on page 82 for information about adding, deleting and editing preset messages.

## Using SMS Voice Messaging

In addition to sending and receiving SMS Text messages, your phone is enabled with SMS Voice Messaging. With SMS Voice Messaging, you can quickly and easily send a voicemail message to other SMS-enabled phones or to working email addresses without making a phone call. Just record a message and send it directly to the recipient’s phone messaging inbox.

You can send SMS Voice messages to up to 10 recipients simultaneously. You can even send an SMS Voice message to yourself, making it an easy way to send yourself reminders and notes. SMS Voice messages are stored right on your phone, there is no need to call your voicemail to retrieve them.

## Activating SMS Voice Messaging

When you first turn on your phone, you will find an SMS Voice message in your SMS Voice Inbox. Listen to the message to get a quick overview of your SMS Voice features.

To activate SMS Voice messages, you need to send an initial SMS Voice message and follow the system prompts.

To activate SMS Voice messages:

1. Press **Contacts** (right softkey).
2. Highlight an entry you want to send an SMS Voice message.
3. Press **Send MSG** (left softkey) and select **Voice SMS**.

4. Press **Record** (left softkey), record a message, and then press **Done** (left softkey).
5. Follow the prompts to activate SMS Voice messaging.

## Playing an SMS Voice Message

To play an SMS Voice message from the main menu:

1. Press **[MMS]** > **Messaging** > **Voice SMS** > **Inbox**.
2. Select the message you want to play.
3. Press **[MMS]** to play the message.

To display the message options, press **Options** (right softkey).

<b>Note:</b>	When you receive an SMS Voice message in standby mode, your phone displays a notification and the option to open it right away.
--------------	---

## Composing SMS Voice Messages

To compose an SMS Voice message:



1. Press **[MMS]** > **Messaging** > **Send Message** > **Voice SMS**.
2. Enter the recipients' phone number or email addresses in any of the following ways:
  - To choose from a list of people you recently sent messages to, highlight **Add Recent recipients** and press **[MMS]**.
  - To choose from your Contacts list, highlight **Add from Contacts** and press **[MMS]**.
  - Use your keypad to enter a recipient's phone number under **Add Mobile #:**.
  - Use your keypad to enter a recipient's phone number under **Add Email:**.
3. When you have entered all the recipients, press **Next**.
4. Press **Record** (left softkey).



5. Start recording after the beep. (You can record up to two minutes.)
6. When you finish recording, press **Done** (left softkey).
7. Press **Send** (left softkey) to send the message.

## Replying to SMS Voice Messages

To reply to an SMS Voice message:





1. Press  > **Messaging** > **Voice SMS** > **Inbox**.
2. Select the message you want to reply to, press , and then press **Reply** (left softkey).
3. Select **Voice SMS**.
4. Press **Record** (left softkey).
5. Start recording after the beep. (You can record up to two minutes.)
6. When you finish recording, press **Done** (left softkey).
7. Press **Send** (left softkey) to send the message.

## Using Caller ID

---

Caller ID allows people to identify a caller before answering the phone by displaying the number of the incoming call. If you do not want your number displayed when you make a call, just follow these easy steps.

To block your phone number from being displayed for a specific outgoing call:

1. Press   .
2. Enter the number you want to call.
3. Press .

To permanently block your number, call Sprint Customer Service.

## Responding to Call Waiting

---

When you're on a call, Call Waiting alerts you to incoming phone calls. Your display screen alerts you that another call is coming in and shows the caller's number (if it is available).



To respond to an incoming call while you're on a call:

- ▶ Press . (This puts the first caller on hold and answers the second call.)

To switch back to the first caller:

- ▶ Press  again.





### Tip:

For those calls where you don't want to be interrupted, you can temporarily disable Call Waiting by pressing    before placing your call. Call Waiting is automatically reactivated after you end the call.

## Making a Three-Way Call

With Three-Way Calling, you can talk to two people at the same time. When using this feature, the normal airtime rates will be charged for each of the two calls.

To make a Three-Way Call:

1. Enter a number you wish to call and press .
2. Once you have established the connection, press **Options** (right softkey), select **3-Way Call**, and press .
3. When you hear a dial tone, enter the second number you wish to call and press .
4. When you're connected to the second party, press  again to begin your Three-Way Call.





If one of the people you called hangs up during your call, you and the remaining caller stay connected. If you initiated the call and are the first to hang up, all other callers are disconnected.

# Using Call Forwarding





---

Call Forwarding lets you forward all your incoming calls to another phone number — even when your phone is turned off. You can continue to make calls from your phone when Call Forwarding is activated.

## To activate Call Forwarding:

1. Press   .
2. Enter the area code and phone number to which your future calls should be forwarded.
3. Press . (You will hear a tone to confirm the activation of Call Forwarding.)

## To deactivate Call Forwarding:

1. Press    .
2. Press . (You will hear a tone to confirm the deactivation.)

**Note:** You are charged a higher rate for calls you have forwarded.

# Updating Phone Software

You can update the software on your phone by downloading software updates over the air.

To update your phone's software:

1. Press  > **Settings/Tools** > **Settings** > **Phone Info** > **Phone Software**.
2. Select **Update**. Your phone checks for software updates.
3. If a software update is available press **Yes** (left softkey) to continue the update process. From this point, the software update may take up to 10 minutes to complete.
4. Press **Next** (left softkey) on the following screen to continue the update.
5. If you want to view more information about the software update, before the update starts, select **More Details**. Press **OK** (left softkey) to return to the previous screen.
6. Select **Update Phone SW** to complete the software update.

After the software update is complete, your phone powers off and then powers back on.

If software updates are available, Sprint may send a request to your phone asking you to update your phone's software. This request will appear as a message on your phone's display. If you see this message, press **Yes** (left softkey) and follow the prompts on your phone's display to complete the software upgrade.

# Sprint Voice Command

---

## In This Section

---

- ◆ **Getting Started With Sprint Voice Command**
  - ◆ **Creating Your Own Address Book**
  - ◆ **Making a Call With Sprint Voice Command**
  - ◆ **Getting Information With Sprint Voice Command**
- 

**With Sprint Voice Command, reaching your friends, family, and coworkers has never been easier — especially when you're on the go.** You can even listen to Web-based information, such as news, weather, and sports. Your voice does it all with Sprint Voice Command.

This section outlines the Sprint Voice Command service.

# Getting Started With Sprint Voice Command



---

With Sprint Voice Command:

- You can store all your contacts' phone numbers, so you can simply say the name of the person you want to call.
- There's no need to punch in a lot of numbers, memorize voicemail passwords, or try to dial while you're driving.
- You can call anyone in your address book — even if you don't remember their phone number.
- You don't need to worry about losing your Contacts or address book. This advanced service is network-based, so if you switch phones or happen to lose your phone, you won't lose your Contacts or address book.

## It's Easy to Get Started

There are two easy ways to sign up for Sprint Voice Command:

- ▶ Sign up when you purchase and activate your phone.
- ▶ Just dial    from your phone to contact Sprint Customer Service and sign up.



There is a monthly charge for Sprint Voice Command.

# Creating Your Own Address Book

---

You can program up to 500 names into your personal address book, with each name having up to five phone numbers. That's 2,500 phone numbers, and with the advanced technology of Sprint Voice Command, you can have instant access to all of them.

There are four ways to update your address book:

- **On the Web.** Go to [www.talk.sprintpcs.com](http://www.talk.sprintpcs.com), sign on with your phone number and password, and access a fully functional Web-based address book to create and update your Contacts.
- **Use an Existing Address Book.** Automatically merge address books from desktop software applications with Sprint Sync<sup>SM</sup> Services for no additional charge. Simply click on the "Click to synchronize" button within your Sprint Voice Command personal address book at [www.talk.sprintpcs.com](http://www.talk.sprintpcs.com).
- **Use Voice Recordings.** Simply dial  and say, "Add name." You will then be asked to say the name and number you want to add to your personal address book. Your address book can store up to 20 voice recorded names at once.
- **Call Sprint 411.** If you don't have a computer or Internet access handy, you can have Sprint 411 look up phone numbers for you and automatically add them to your address book. Just dial  and say "Call operator" and we'll add two names and all the numbers associated with those names to your address book for our standard directory assistance charge.



# Making a Call With Sprint Voice Command

To make a call with Sprint Voice Command:

1. Press  and you'll hear the "Ready" prompt.
2. After the "Ready" prompt, simply say, in a natural voice, "Call" and the name of the person or the number you'd like to call. (For example, you can say, "Call Jane Smith at work," "Call John Baker on the mobile phone," "Call 555-1234," or "Call Bob Miller.")
3. Your request will be repeated and you will be asked to verify. Say "Yes" to call the number or person. (The number will automatically be dialed.) Say "No" if you wish to cancel.

**Tip:**

Keep in mind that Sprint Voice Command recognizes not only your voice, but any voice, so that others can experience the same convenience if they use your phone.

For more helpful hints on Sprint Voice Command, including a list of recognized commands and an interactive tutorial, visit [www.talk.sprintpcs.com](http://www.talk.sprintpcs.com).

# Getting Information With Sprint Voice Command

---

To access information using Sprint Voice Command:

1. Press .
2. Say “Call the Web” and choose from a listing of information categories like news, weather, and sports.  
— or —  
Simply say “Call news room,” “Call the weather,” “Call Sports Central,” etc.

**Note:**

Sprint Voice Command is not available while roaming off the Sprint National Network.

**Section 4**

# **Safety and Warranty Information**



# Important Safety Information

---

## In This Section

---

- ◆ General Precautions
  - ◆ Safety and General Information
  - ◆ Using Your Phone With a Hearing Aid
  - ◆ Battery Tips
  - ◆ Specific Absorption Rate Data
  - ◆ Owner's Record
  - ◆ Phone Guide Proprietary Notice
  - ◆ Information From the World Health Organization
  - ◆ Product Registration
  - ◆ Export Law Assurances
  - ◆ Wireless: The New Recyclable
  - ◆ Smart Practices While Driving
- 

**This phone guide contains important operational and safety information that will help you safely use your phone.** Failure to read and follow the information provided in this phone guide may result in serious bodily injury, death, or property damage.

## General Precautions

---

There are several simple guidelines to operating your phone properly and maintaining safe, satisfactory service.

- Hold the phone with the antenna raised, fully-extended, and over your shoulder.
- Try not to hold, bend, or twist the phone's antenna.
- Don't use the phone if the antenna is damaged.
- Speak directly into the mouthpiece.
- Avoid exposing your phone and accessories to rain or liquid spills. If your phone does get wet, immediately turn the power off and remove the battery.
- Do not expose your phone to direct sunlight for extended periods of time (such as on the dashboard of a car).
- Although your phone is quite sturdy, it is a complex piece of equipment and can be broken. Avoid dropping, hitting, bending, or sitting on it.
- Any changes or modifications to your phone not expressly approved in this document could void your warranty for this equipment and void your authority to operate this equipment.

<b>Note:</b>	For the best care of your phone, only authorized personnel should service your phone and accessories. Failure to do so may be dangerous and void your warranty.
--------------	---

# Safety and General Information

---

This section contains important information on the safe and efficient operation of your mobile device. Read this information before using your mobile device.<sup>1</sup>

## **AglON Antimicrobial™ — Built-in Protection for Your Phone**

Motorola has incorporated AglON antimicrobial into the painted surfaces of your phone to help provide protection against a broad range of product damaging mold and mildew.

Motorola is the first wireless phone manufacturer to incorporate AglON antimicrobial into the phone's painted surfaces.

The antimicrobial technology is an example of Motorola's pursuit for innovation and creativity to produce the best quality wireless experience.

The antimicrobial technology in the paint on Motorola phones helps provide protection against product damage caused by microbes, but does not extend such protection to the user.

Versatile in application, the EPA-registered AglON additive is recommended for institutional, commercial and consumer applications. AglON antimicrobials are used in many settings including hospitals, offices, schools and food processing facilities. They can also be found in leading footwear, fabrics, appliances, water coolers and architectural hardware.

1. The information provided in this document supersedes the general safety information in user's guides published prior to May 1, 2006.

## Benefits of AgION™<sup>1</sup>

- AgION antimicrobial technology helps provide protection against product damaging microbes on the painted surfaces of the phone.
- AgION antimicrobial is effective in protecting the product against a broad spectrum of microbes.
- AgION helps inhibit the ability of microbes to grow and spread on the painted surfaces of the phone.
- The active ingredient helps break down enzymes in the microbe, inhibiting its ability to reproduce and spread on the painted surfaces of the phone.
- Studies have shown that surfaces with AgION antimicrobial can reduce the amount of certain product damaging microbes by 99%.
- The AgION coating will protect the painted surfaces of the product against product damaging microbes for the life of the product.

## Safety

- AgION antimicrobial protection is based on silver, a safe, non-toxic additive to the phone paint. Silver is widely used as an antimicrobial agent in many environments and industries.
- AgION antimicrobial technology is safe to use. Thorough testing has shown the additive to be less toxic than table salt and less irritating than talcum powder.

## How It Works

- The technology continuously inhibits the growth of product damaging microbes on the phone's painted surfaces. The active ingredient helps break down enzymes in the microbe, inhibiting its ability to reproduce and spread on the painted surfaces on the phone.
1. The antimicrobial technology is applied only to the painted surfaces of the Motorola phones, thereby providing protection against damage to such surfaces caused by microbes, but does not extend such protection to the end user.

- The active ingredient in AgIION is silver, in the form of silver ions.

### **Accreditation**

- The AgIION antimicrobial compound is registered with the Environmental Protection Agency (EPA) as a preservative and bacteriostatic agent for use in the manufacturing of polymers and plastics.
- NSF, FDA-listed.

### **RF Operational Characteristics**

Your radio product contains a radio frequency transmitter to convey the information you wish to send as well as occasional automatic signals used to sustain connection to the wireless network, and a receiver which enables you to receive communication and connection information from the network.

### **Portable Radio Product Operation and EME Exposure**

Your Motorola radio product is designed to comply with the following national and international standards and guidelines regarding exposure of human beings to radio frequency electromagnetic energy (EME):

- United States Federal Communications Commission, Code of Federal Regulations; 47 CFR part 2 sub-part J.
- American National Standards Institute (ANSI) / Institute of Electrical and Electronics Engineers (IEEE). C95. 1-1992.
- Institute of Electrical and Electronics Engineers (IEEE). C95. 1-1999 Edition.
- International Commission on Non-Ionizing Radiation Protection (ICNIRP) 1998.
- Ministry of Health (Canada). Safety Code 6. Limits of Human Exposure to Radiofrequency Electromagnetic Fields in the Frequency Range from 3 kHz to 300 GHz, 1999.



- Australian Communications Authority Radiocommunications (Electromagnetic Radiation - Human Exposure) Standard 2003.
- ANATEL, Brasil Regulatory Authority, Resolution 303 (July 2, 2002) "Regulation of the limitation of exposure to electrical, magnetic, and electromagnetic fields in the radio frequency range between 9 kHz and 300 GHz." "Attachment to Resolution 303 from July 2, 2002."

**To assure optimal radio product performance and make sure human exposure to radio frequency electromagnetic energy is within the guidelines set forth in the above standards, always adhere to the following procedures:**

## Phone Operation

When placing or receiving a phone call, hold your radio product as you would a wireline telephone. Speak directly into the microphone.

## Two-way Radio Operation

Your radio product has been designed and tested to comply with national and international standards and guidelines regarding human exposure to RF electromagnetic energy, when operated in the two-way mode (at the face, or at the abdomen when using an audio accessory) at usage factors of up to 50% talk/50% listen.

Transmit no more than the rated duty factor of 50% of the time. To transmit (talk), push the Push-To-Talk (PTT) button. To receive calls, release the PTT button. Transmitting 50% of the time or less, is important because this radio generates measurable RF energy only when transmitting (in terms of measuring for standards compliance).

When using your radio product as a traditional two-way radio, **hold the radio product in a vertical position with the microphone one to two inches (2.5 to 5 cm) away from the lips.**



## Body-worn Operation

To maintain compliance with FCC RF exposure guidelines, if you wear a radio product on your body when transmitting, always place the radio product in a **Motorola approved clip, holder, holster, case or body harness for this product**. Use of non-Motorola-approved accessories may exceed FCC RF exposure guidelines. **If you do not use a Motorola approved body-worn accessory and are not using the radio product in the intended use positions along side the head in the phone mode or in front of the face in the two-way radio mode, then ensure the antenna and the radio product are kept the following minimum distances from the body when transmitting:**

- **Phone or Two-way radio mode: one inch (2.5 cm)**
- **Data operation using any data feature with or without an accessory cable: one inch (2.5 cm)**

## Exposure to Radio Frequency (RF) Energy

Your mobile device contains a transmitter and receiver. When it is ON, it receives and transmits RF energy. When you communicate with your mobile device, the system handling your call controls the power level at which your mobile device transmits.

Your Motorola mobile device is designed to comply with local regulatory requirements in your country concerning exposure of human beings to RF energy.

## Operational Precautions

For optimal mobile device performance and to be sure that human exposure to RF energy does not exceed the guidelines set forth in the relevant standards, always follow these instructions and precautions.

### External Antenna Care

If your mobile device has an external antenna, use only a Motorola-supplied or approved replacement antenna. Use of unauthorized antennas, modifications, or attachments could

damage the mobile device and/or may result in your device not complying with local regulatory requirements in your country. DO NOT hold the external antenna when the mobile device is IN USE. Holding the external antenna affects call quality and may cause the mobile device to operate at a higher power level than needed.

## Product Operation

When placing or receiving a phone call, hold your mobile device just like you would a landline phone.

If you wear the mobile device on your body, always place the mobile device in a Motorola-supplied or approved clip, holder, holster, case, or body harness. If you do not use a body-worn accessory supplied or approved by Motorola, keep the mobile device and its antenna at least 2.5 centimeters (1 inch) from your body when transmitting.

When using any data feature of the mobile device, with or without an accessory cable, position the mobile device and its antenna at least 2.5 centimeters (1 inch) from your body.

Using accessories not supplied or approved by Motorola may cause your mobile device to exceed RF energy exposure guidelines. For a list of Motorola-supplied or approved accessories, visit our Web site at [www.motorola.com](http://www.motorola.com).

## RF Energy Interference/Compatibility

Nearly every electronic device is subject to RF energy interference from external sources if inadequately shielded, designed, or otherwise configured for RF energy compatibility. In some circumstances your mobile device may cause interference with other devices.

## Follow Instructions to Avoid Interference Problems

Turn off your mobile device in any location where posted notices instruct you to do so. These locations include hospitals or health care facilities that may be using equipment that is sensitive to external RF energy.

In an aircraft, turn off your mobile device whenever instructed to do so by airline staff. If your mobile device offers an airplane mode or similar feature, consult airline staff about using it in flight.

## Implantable Medical Devices

A minimum separation of six (6) inches should be maintained between a handheld wireless phone and an implantable medical device, such as a pacemaker or implantable cardioverter defibrillator, to avoid potential interference with the device.

Persons who have such devices:

- Should ALWAYS keep the phone more than six (6) inches from their implantable medical device when the phone is turned ON;
- Should not carry the phone in a breast pocket;
- Should use the ear opposite the implantable medical device to minimize the potential for interference;
- Should turn the phone OFF immediately if there is any reason to suspect that the interference is taking place.
- Should read and follow the directions from the manufacturer of the implantable medical device. If you have any questions about using your wireless phone with such a device, consult your health care provider.

For more information, see [www.fcc.cellphones.gov](http://www.fcc.cellphones.gov).

## Driving Precautions

Check the laws and regulations on the use of mobile devices in the area where you drive. Always obey them.

When using your mobile device while driving, please:

- Give full attention to driving and to the road. Using a mobile device may be distracting. Discontinue a call if you can't concentrate on driving.
- Use hands-free operation, if available.
- Pull off the road and park before making or answering a call if driving conditions so require.

Responsible driving practices can be found in the “Smart Practices While Driving” section of this guide and/or at the Motorola Web site: [www.motorola.com/callsmart](http://www.motorola.com/callsmart).

## Automobile Air Bags

Do not place a mobile device in the air bag deployment area.

## Operational Warnings

Obey all posted signs when using mobile devices in public areas, such as health care facilities or blasting areas.

## Potentially Explosive Atmospheres

Areas with potentially explosive atmospheres are often but not always posted, and can include fueling areas such as below decks on boats, fuel or chemical transfer or storage facilities, or areas where the air contains chemicals or particles, such as grain, dust, or metal powders.

When you are in such an area, turn off your mobile device, and do not remove, install, or charge batteries. In such areas, sparks can occur and cause an explosion or fire.

## Damaged Products







If your mobile device or battery has been submerged in water, punctured, or subjected to a severe fall, do not use it until you take it to a Motorola Authorized Service Center. Do not attempt to dry it with an external heat source, such as a microwave oven.

## Batteries and Chargers

If jewelry, keys, beaded chains, or other conductive materials touch exposed battery terminals, this could complete an electrical circuit (short circuit), become very hot, and could cause damage or injury. Be careful when handling a charged battery, particularly when placing it inside a pocket, purse, or other container with metal objects. **Use only Motorola Original batteries and chargers.**

**Caution:** To avoid risk of personal injury, do not dispose of your battery in a fire.

Your battery, charger, or mobile device may contain symbols, defined as follows:

Symbol	Definition
	Important safety information follows.
	Do not dispose of your battery or mobile device in a fire.
	Your battery or mobile device may require recycling in accordance with local laws. Contact your local regulatory authorities for more information.
	Do not throw your battery or mobile device in the trash.
	Your mobile device contains an internal lithium ion battery.
	Do not let your battery, charger, or mobile device get wet.
	Listening at full volume to music or voice through a handset may damage your hearing.

## Choking Hazards

Your mobile device or its accessories may include detachable parts, which may present a choking hazard to small children. Keep your mobile device and its accessories away from small children.

## Glass Parts

Some parts of your mobile device may be made of glass. This glass could break if the product is dropped on a hard surface or

receives a substantial impact. If glass breaks, do not touch or attempt to remove. Stop using your mobile device until the glass is replaced by a qualified service center.

## Seizures/Blackouts

Some people may be susceptible to epileptic seizures or blackouts when exposed to flashing lights, such as when playing video games. These may occur even if a person has never had a previous seizure or blackout.

If you have experienced seizures or blackouts, or if you have a family history of such occurrences, please consult with your physician before playing video games or enabling a flashing-lights feature (if available) on your mobile device.

Discontinue use and consult a physician if any of the following symptoms occur: convulsion, eye or muscle twitching, loss of awareness, involuntary movements, or disorientation. It is always a good idea to hold the screen away from your eyes, leave the lights on in the room, take a 15-minute break every hour, and stop use if you are very tired.

## Caution About High Volume Usage



Listening at full volume to music or voice through a headset may damage your hearing.

## Repetitive Motion

When you repetitively perform actions such as pressing keys or entering finger-written characters, you may experience occasional discomfort in your hands, arms, shoulders, neck, or other parts of your body. If you continue to have discomfort during or after such use, stop use and see a physician.

# Using Your Phone With a Hearing Aid

---

A number of Sprint phones have been tested for hearing aid compatibility. When some wireless phones are used with certain hearing aids, users may detect a noise which can interfere with the effectiveness of the hearing aid.

Some hearing aids are more “immune” than others to this interference noise, and phones can also vary in the amount of interference noise they may generate. ANSI standard C63.19 was developed to provide a standardized means of measuring both mobile phone and hearing aids to determine usability rating categories for both.

Ratings have been developed for mobile phones to assist hearing aid users find phones that may be compatible with their hearing aid. Not all phones have been rated for compatibility with hearing aids. Phones that have been rated have a label with the rating(s) located on the box, and at [www.motorola.com/iden](http://www.motorola.com/iden).

These ratings are not guarantees of compatibility. Results will vary depending on the user’s hearing aid and individual type and degree of hearing loss. If a hearing aid is particularly vulnerable to interference, even a phone with a higher rating may still cause unacceptable noise levels in the hearing aid. Trying out the phone with your hearing aid is the best way to evaluate it for your personal needs.

**“M” Rating:** Phones rated M3 or M4 meet FCC requirements for hearing aid compatibility and are likely to generate less interference to hearing aids than unrated phones. (M4 is the “better” or higher of the two ratings.) On those models with an extendable antenna this rating is determined only with the antenna extended.

**“T” Rating:** Phones rated T3 or T4 meet FCC requirements and are likely to be more usable with a hearing aid’s telecoil (“T Switch” or “Telephone Switch”) than unrated phones. (T4 is the “better” or higher of the two ratings.) On those models with a telecoil mode setting this rating is determined only with the phone so set. For



setting instructions see “Features for the Hearing Impaired” in the section entitled “Advanced Calling Features”. Note that not all hearing aids have telecoils in them.

Hearing aids may also be measured for immunity to interference from wireless phones and may have ratings similar to wireless phones. Ask your hearing healthcare professional for the rating of your hearing aid.

Add the rating of your hearing aid and your phone to determine the estimated usability:

- Any combined rating equal to or greater than six offers excellent use.
- Any combined rating equal to five is considered normal use.
- Any combined rating equal to four is considered usable.

Thus, if you use an M3 phone with a M3 hearing aid you will have a combined rating of six for “excellent use.” This methodology applies equally for T ratings.

Sprint further suggests you experiment with multiple phones (even those not labeled M3/T3 or M4/T4) while in the store to find the one that works best with your hearing aid. Should you experience interference or find the quality of service unsatisfactory after purchasing your phone, promptly return it to the store within 30 days of purchase. With the Sprint 30-day Risk-Free Guarantee, you may return the phone within 30 days of purchase for a full refund.

More information about hearing aid compatibility may be found at: [www.motorola.com/accessibility](http://www.motorola.com/accessibility), [www.fcc.gov](http://www.fcc.gov), [www.fda.gov](http://www.fda.gov), and <http://www.hearingloss.org/learn/cellphonetech.asp>.

# Battery Tips

---

Battery life depends on the network, signal strength, temperature, features, and accessories you use.

- Always use Motorola Original batteries and chargers. The warranty does not cover damage caused by non-Motorola batteries and/or chargers.
- New batteries or batteries stored for a long time may take more time to charge.
- When charging your battery, keep it near room temperature.
- When storing your battery, keep it uncharged in a cool, dark, dry place.
- Never expose batteries to temperatures below  $-10^{\circ}\text{C}$  ( $14^{\circ}\text{F}$ ) or above  $45^{\circ}\text{C}$  ( $113^{\circ}\text{F}$ ). Always take your phone with you when you leave your vehicle.
- It is normal for batteries to gradually wear down and require longer charging times. If you notice a change in your battery life, it is probably time to purchase a new battery.



Contact your local recycling center for proper battery disposal.



<b>Warning:</b>	Never dispose of batteries in a fire because they may explode.
-----------------	--

# Specific Absorption Rate Data

**This model wireless phone meets the government's requirements for exposure to radio waves.**

Your wireless phone is a radio transmitter and receiver. It is designed and manufactured not to exceed limits for exposure to radio frequency (RF) energy set by the Federal Communications Commission (FCC) of the U.S. Government and by the Canadian regulatory authorities. These limits are part of comprehensive guidelines and establish permitted levels of RF energy for the general population. The guidelines are based on standards that were developed by independent scientific organizations through periodic and thorough evaluation of scientific studies. The standards include a substantial safety margin designed to assure the safety of all persons, regardless of age or health.

The exposure standard for wireless mobile phones employs a unit of measurement known as the Specific Absorption Rate, or SAR. The SAR limit set by the FCC and by the Canadian regulatory authorities is 1.6 W/kg.<sup>1</sup> Tests for SAR are conducted using standard operating positions accepted by the FCC and by Industry Canada with the phone transmitting at its highest certified power level in all tested frequency bands. Although the SAR is determined at the highest certified power level, the actual SAR level of the phone while operating can be well below the maximum value. This is because the phone is designed to operate at multiple power levels so as to use only the power required to reach the network. In general, the closer you are to a wireless base station, the lower the power output.

Before a phone model is available for sale to the public in the U.S. and Canada, it must be tested and certified to the FCC and Industry Canada that it does not exceed the limit established by

1. In the United States and Canada, the SAR limit for mobile phones used by the public is 1.6 watts/kg (W/kg) averaged over one gram of tissue. The standard incorporates a substantial margin of safety to give additional protection for the public and to account for any variations in measurements.

each government for safe exposure. The tests are performed in positions and locations (e.g., at the ear and worn on the body) reported to the FCC and available for review by Industry Canada. The highest SAR value for this model phone when tested for use at the ear is 1.53 W/kg, and when worn on the body, as described in this user guide, is 1.41 W/kg. (Body-worn measurements differ among phone models, depending upon available accessories and regulatory requirements).<sup>1</sup>

While there may be differences between the SAR levels of various phones and at various positions, they all meet the governmental requirements for safe exposure. Please note that improvements to this product model could cause differences in the SAR value for later products; in all cases, products are designed to be within the guidelines.

Additional information on Specific Absorption Rates (SAR) can be found on the Cellular Telecommunications & Internet Association (CTIA) Web site:

<http://www.phonefacts.net>

or the Canadian Wireless Telecommunications Association (CWTA) Web site:

<http://www.cwta.ca>.

1. The SAR information reported to the FCC includes the FCC-accepted Motorola testing protocol, assessment procedure, and measurement uncertainty range for this product.

# Information From the World Health Organization

---

WHO Information Present scientific information does not indicate the need for any special precautions for the use of mobile phones. If you are concerned, you may want to limit your own or your children's RF exposure by limiting the length of calls or by using hands-free devices to keep mobile phones away from your head and body.

Source: WHO Fact Sheet 193

Further information: <http://www.who.int./peh-emf>

## Product Registration

---

Online Product Registration:

<http://www.motorola.com/warranty>

Product registration is an important step toward enjoying your new Motorola product. Registering helps us facilitate warranty service, and permits us to contact you should your product require an update or other service. Registration is for U.S. residents only and is not required for warranty coverage.

Please retain your original dated sales receipt for your records. For warranty service of your Motorola Personal Communications Product you will need to provide a copy of your dated sales receipt to confirm warranty status.

Thank you for choosing a Motorola product.

## Owner's Record

---

The model number, regulatory number and serial number are located on a nameplate inside the battery compartment. Record the serial number in the space provided below. This will be helpful if you need to contact us about your phone in the future.

Model: Motorola Deluxe ic902

Serial No.:

## Phone Guide Proprietary Notice

---

CDMA Technology is licensed by QUALCOMM Incorporated under one or more of the following patents:

4,901,307 5,109,390 5,267,262 5,416,797

5,506,865 5,544,196 5,657,420 5,101,501

5,267,261 5,414,796 5,504,773 5,535,239

5,600,754 5,778,338 5,228,054 5,337,338

5,710,784 5,056,109 5,568,483 5,659,569

5,490,165 5,511,073

## Export Law Assurances

---

This product is controlled under the export regulations of the United States of America and Canada. The Governments of the United States of America and Canada may restrict the exportation or re-exportation of this product to certain destinations. For further information contact the U.S. Department of Commerce or the Canadian Department of Foreign Affairs and International Trade.

## Wireless: The New Recyclable

---

Your wireless phone can be recycled. Recycling your wireless phone reduces the amount of waste disposed in landfills and allows recycled materials to be incorporated into new products.

The Cellular Telecommunications Industry Association (CTIA) and its members encourage consumers to recycle their phones and have taken steps to promote the collection and environmentally sound recycling of end-of-life wireless devices.

As a wireless phone user, you have an important role in ensuring that this phone is recycled properly. When it comes time to give this phone up or trade it in for a new one, please remember that the phone, the charger, and many of its accessories can be recycled. It's easy. To learn more about CTIA's Recycling Program for Used Wireless Devices, please visit <http://www.ctia.org/content/index.cfm/AID/10131>.

# Smart Practices While Driving

---

## Drive Safe, Call Smart<sup>SM</sup>

Check the laws and regulations on the use of mobile devices and their accessories in the areas where you drive. Always obey them. The use of these devices may be prohibited or restricted in certain areas. Contact [www.motorola.com/callsmart](http://www.motorola.com/callsmart) for more information.

Your mobile device lets you communicate by voice and data—almost anywhere, anytime, wherever wireless service is available and safe conditions allow. When driving a car, driving is your first responsibility. If you choose to use your mobile device while driving, remember the following tips:

- **Get to know your Motorola mobile device and its features such as speed dial and redial.** If available, these features help you to place your call without taking your attention off the road.
- **When available, use a handsfree device.** If possible, add an additional layer of convenience to your mobile device with one of the many Motorola Original™ handsfree accessories available today.
- **Position your mobile device within easy reach.** Be able to access your mobile device without removing your eyes from the road. If you receive an incoming call at an inconvenient time, if possible, let your voicemail answer it for you.
- **Let the person you are speaking with know you are driving; if necessary, suspend the call in heavy traffic or hazardous weather conditions.** Rain, sleet, snow, ice, and even heavy traffic can be hazardous.
- **Do not take notes or look up phone numbers while driving.** Jotting down a “to do” list or going through your address book takes attention away from your primary responsibility—driving safely.
- **Dial sensibly and assess the traffic; if possible, place calls when your car is not moving or before pulling into traffic.** If you must make a call while moving, dial only a few numbers, check the road and your mirrors, then continue.



- **Do not engage in stressful or emotional conversations that may be distracting.** Make people you are talking with aware you are driving and suspend conversations that can divert your attention away from the road.
- **Use your mobile device to call for help.** Dial 911 or other local emergency number in the case of fire, traffic accident, or medical emergencies.

**If this equipment does cause harmful interference to radio or television reception, which can be determined by turning the equipment off and on, the user is encouraged to try to correct the interference by one or more of the following measures:**

- Reorient or relocate the receiving antenna.
- Increase the separation between the equipment and receiver.
- Connect the equipment into an outlet on a circuit different from that to which the receiver is connected.
- Consult the dealer or an experienced radio/TV technician for help.

# Declaration of Conformity

---

Per FCC CFR 47 Part 2 Section 2.1077(a)



Responsible Party Name: Motorola, Inc.

Address: 8000 West Sunrise Boulevard  
Plantation, FL 33322 USA

Phone Number: 1 (800) 453-0920

Hereby declares that the product:

Product Name: ic902

Model Number: H93ZAH9JR7AN

Conforms to the following regulations:

FCC Part 15, subpart B, section 15.107(a), 15.107(d) and section  
15.109(a)

Class B Digital Device

As a personal computer peripheral, this device complies with Part 15 of the FCC Rules. Operation is subject to the following two conditions: (1) this device may not cause harmful interference, and (2) this device must accept any interference received, including interference that may cause undesired operation.

**Note:**

This equipment has been tested and found to comply with the limits for a Class B digital device, pursuant to part 15 of the FCC Rules. These limits are designed to provide reasonable protection against harmful interference in a residential installation. This equipment generates, uses and can radiate radio frequency energy and, if not installed and used in accordance with the instructions, may cause harmful interference to radio communications. However, there is no guarantee that interference will not occur in a particular installation.

Per FCC Rule Part 15.21, changes or modifications not expressly approved by Motorola could void the user's authority to operate this product.

**If this equipment does cause harmful interference to radio or television reception, which can be determined by turning the equipment off and on, the user is encouraged to try to correct the interference by one or more of the following measures:**

- Reorient or relocate the receiving antenna.
- Increase the separation between the equipment and receiver.
- Connect the equipment into an outlet on a circuit different from that to which the receiver is connected.
- Consult the dealer or an experienced radio/TV technician for help.

## California Perchlorate Label

---

Some mobile phones use an internal, permanent backup battery on the printed circuit board that may contain very small amounts of perchlorate. In such cases, California law requires the following label:

“Perchlorate Material - special handling may apply. See [www.dtsc.ca.gov/hazardouswaste/perchlorate](http://www.dtsc.ca.gov/hazardouswaste/perchlorate).”

There is no special handling required by consumer.

# Privacy and Data Security

Motorola understands that privacy and data security are important to everyone. Because some features of your mobile device may affect your privacy or data security, please follow these recommendations to enhance protection of your information:

- **Monitor access** — Keep your mobile device with you and do not leave it where others may have unmonitored access. Lock your device's keypad where this feature is available.
- **Keep software up to date** — If Motorola or a software/application vendor releases a patch or software fix for your mobile device which updates the device's security, install it as soon as possible.
- **Erase before recycling** — Delete personal information or data from your mobile device prior to disposing of it or turning it in for recycling. For step-by-step instructions on how to delete all personal information from your device, see the section entitled "Erasing Data" and "Resetting Your Phone" in this user's guide.

**Note:**

For information on backing up your mobile device data before erasing it, go to [www.motorola.com](http://www.motorola.com) and then navigate to the "downloads" section of the consumer Web page for "Motorola Backup" or "Motorola Phone Tools."

- **Understanding AGPS** — In order to comply with emergency caller location requirements of the FCC, certain Motorola mobile devices incorporate Assisted Global Positioning System (AGPS) technology. AGPS technology also can be used in non-emergency applications to track and monitor a user's location—for example, to provide driving directions. Users who prefer not to permit such tracking and monitoring should avoid using such applications.

If you have further questions regarding how use of your mobile device may impact your privacy or data security, please contact Motorola at [privacy@motorola.com](mailto:privacy@motorola.com), or contact Sprint Customer Service.

# Manufacturer's Warranty

---

## In This Section

---

- ◆ **Motorola Limited Warranty for the United States and Canada**
  - ◆ **Service and Repairs**
- 

**Your phone has been designed to provide you with reliable, worry-free service.** If for any reason you have a problem with your equipment, please refer to the manufacturer's warranty in this section.

For information regarding the terms and conditions of service for your phone, please visit [www.sprint.com](http://www.sprint.com) or Sprint Customer Service at 1-888-211-4727.

# Motorola Limited Warranty for the United States and Canada

---

## What Does this Warranty Cover?

Subject to the exclusions contained below, Motorola, Inc. warrants its telephones, pagers, messaging devices, and consumer and professional two-way radios (excluding commercial, government or industrial radios) that operate via Family Radio Service or General Mobile Radio Service, Motorola-branded or certified accessories sold for use with these Products ("Accessories") and Motorola software contained on CD-ROMs or other tangible media and sold for use with these Products ("Software") to be free from defects in materials and workmanship under normal consumer usage for the period(s) outlined below. This limited warranty is a consumer's exclusive remedy, and applies as follows to new Motorola Products, Accessories and Software purchased by consumers in the United States or Canada, which are accompanied by this written warranty:

## Products and Accessories

Products Covered	Length of Coverage
<b>Products and Accessories</b> as defined above, unless otherwise provided for below.	<b>One (1) year</b> from the date of purchase by the first consumer purchaser of the product unless otherwise provided for below.
<b>Decorative Accessories and Cases.</b> Decorative covers, bezels, PhoneWrap™ covers and cases.	<b>Limited lifetime warranty</b> for the lifetime of ownership by the first consumer purchaser of the product.



<b>Products Covered</b>	<b>Length of Coverage</b>
<b>Monaural Headsets.</b> Ear buds and boom headsets that transmit mono sound through a wired connection.	<b>Limited lifetime warranty</b> for the lifetime of ownership by the first consumer purchaser of the product.
<b>Consumer and Professional Two-Way Radio Accessories.</b>	<b>Ninety (90) days</b> from the date of purchase by the first consumer purchaser of the product.
<b>Products and Accessories that are Repaired or Replaced.</b>	<b>The balance of the original warranty or for ninety (90) days</b> from the date returned to the consumer, whichever is longer.

## Exclusions

**Normal Wear and Tear.** Periodic maintenance, repair and replacement of parts due to normal wear and tear are excluded from coverage.

**Batteries.** Only batteries whose fully charged capacity falls below 80% of their rated capacity and batteries that leak are covered by this limited warranty.

**Abuse & Misuse.** Defects or damage that result from: (a) improper operation, storage, misuse or abuse, accident or neglect, such as physical damage (cracks, scratches, etc.) to the surface of the product resulting from misuse; (b) contact with liquid, water, rain, extreme humidity or heavy perspiration, sand, dirt or the like, extreme heat, or food; (c) use of the Products or Accessories for commercial purposes or subjecting the Product or Accessory to abnormal usage or conditions; or (d) other acts which are not the fault of Motorola, are excluded from coverage.

**Use of Non-Motorola Products and Accessories.** Defects or damage that result from the use of Non-Motorola branded or certified Products, Accessories, Software or other peripheral equipment are excluded from coverage.

**Unauthorized Service or Modification.** Defects or damages resulting from service, testing, adjustment, installation, maintenance, alteration, or modification in any way by someone other than

Motorola, or its authorized service centers, are excluded from coverage.

**Altered Products.** Products or Accessories with (a) serial numbers or date tags that have been removed, altered or obliterated; (b) broken seals or that show evidence of tampering; (c) mismatched board serial numbers; or (d) nonconforming or non-Motorola housings, or parts, are excluded from coverage.

**Communication Services.** Defects, damages, or the failure of Products, Accessories or Software due to any communication service or signal you may subscribe to or use with the Products Accessories or Software is excluded from coverage.

## Software

Products Covered	Length of Coverage
<b>Software.</b> Applies only to physical defects in the media that embodies the copy of the software (e.g. CD-ROM, or floppy disk).	Ninety (90) days from the date of purchase.

## Exclusions

**Software Embodied in Physical Media.** No warranty is made that the software will meet your requirements or will work in combination with any hardware or software applications provided by third parties, that the operation of the software products will be uninterrupted or error free, or that all defects in the software products will be corrected.

**Software NOT Embodied in Physical Media.** Software that is not embodied in physical media (e.g. software that is downloaded from the internet), is provided “as is” and without warranty.

## Who Is Covered?

This warranty extends only to the first consumer purchaser, and is not transferable.

## What Will Motorola Do?

Motorola, at its option, will at no charge repair, replace or refund the purchase price of any Products, Accessories or Software that does not conform to this warranty. We may use functionally equivalent reconditioned/refurbished/pre-owned or new Products, Accessories or parts. No data, software or applications added to your Product, Accessory or Software, including but not limited to personal contacts, games and ringer tones, will be reinstalled. To avoid losing such data, software and applications please create a back up prior to requesting service.

## How to Obtain Warranty Service or Other Information

<b>USA</b>	<b>Phones</b> 1-800-734-5580 <b>Pagers</b> 1-800-548-9954 <b>Two-Way Radios and Messaging Devices</b> 1-800-353-2729
<b>Canada</b>	<b>All Products</b> 1-800-461-4575
<b>TTY</b>	1-888-390-6456
For Accessories and Software, please call the telephone number designated above for the product with which they are used.	

You will receive instructions on how to ship the Products, Accessories or Software, at your expense, to a Motorola Authorized Repair Center. To obtain service, you must include: (a) a copy of your receipt, bill of sale or other comparable proof of purchase; (b) a written description of the problem; (c) the name of your service provider, if applicable; (d) the name and location of the installation facility (if applicable) and, most importantly; (e) your address and telephone number.

## What Other Limitations Are There?

ANY IMPLIED WARRANTIES, INCLUDING WITHOUT LIMITATION THE IMPLIED WARRANTIES OF MERCHANTABILITY AND FITNESS FOR A PARTICULAR PURPOSE, SHALL BE LIMITED TO THE DURATION OF THIS LIMITED WARRANTY, OTHERWISE THE REPAIR, REPLACEMENT, OR REFUND AS PROVIDED UNDER THIS EXPRESS LIMITED WARRANTY IS THE EXCLUSIVE REMEDY OF THE CONSUMER, AND IS PROVIDED IN LIEU OF ALL OTHER WARRANTIES, EXPRESS OR IMPLIED. IN NO EVENT SHALL MOTOROLA BE LIABLE, WHETHER IN CONTRACT OR TORT (INCLUDING NEGLIGENCE) FOR DAMAGES IN EXCESS OF THE PURCHASE PRICE OF THE PRODUCT, ACCESSORY OR SOFTWARE, OR FOR ANY INDIRECT, INCIDENTAL, SPECIAL OR CONSEQUENTIAL DAMAGES OF ANY KIND, OR LOSS OF REVENUE OR PROFITS, LOSS OF BUSINESS, LOSS OF INFORMATION OR DATA, SOFTWARE OR APPLICATIONS OR OTHER FINANCIAL LOSS ARISING OUT OF OR IN CONNECTION WITH THE ABILITY OR INABILITY TO USE THE PRODUCTS, ACCESSORIES OR SOFTWARE TO THE FULL EXTENT THESE DAMAGES MAY BE DISCLAIMED BY LAW.

**Some states and jurisdictions do not allow the limitation or exclusion of incidental or consequential damages, or limitation on the length of an implied warranty, so the above limitations or exclusions may not apply to you. This warranty gives you specific legal rights, and you may also have other rights that vary from state to state or from one jurisdiction to another.**

Laws in the United States and other countries preserve for Motorola certain exclusive rights for copyrighted Motorola software such as the exclusive rights to reproduce and distribute copies of the Motorola software. Motorola software may only be copied into, used in, and redistributed with, the Products associated with such Motorola software. No other use, including without limitation disassembly of such Motorola software or exercise of the exclusive rights reserved for Motorola, is permitted.

## Service and Repairs

---

Go to [www.motorola.com/iden/support](http://www.motorola.com/iden/support), where you can select from a number of customer care options. You can also contact the Motorola Customer Support Center at 1-800-734-5580 (United States), 1-888-390-6456 (TTY/TDD United States for hearing impaired), or 1-800-461-4575 (Canada).

# Index

## A

- Abbreviated Dialing 45
- Accessories 30
  - Charger 30
  - Li-Ion Battery 30
- AglON antimicrobial 236
- Airplane Mode 84
- Alarm Clock 143
- Auto-Answer Mode 87

## B

- Backlight 76
- Battery 18–22
  - Capacity 18
  - Care 22
  - Charging 21
  - Installing 19
  - Removing 20
- Bluetooth 203–210

## C

- Calculator 144
- Calendar 140–142
- Call Alerts 66
  - Answer 67
  - Dismissing 67
  - Sending 66
  - Viewing 67
- Call Answer Mode 87
- Call Forwarding 226
- Call Guard 109
- Call History 111–119
  - Erasing 119
  - Making a Call 115
  - Making a Walkie-Talkie Call 118

- Prepending a Phone Number 116
- Saving a Phone Number 116
- Saving Walkie-Talkie Information 118
- Viewing Phone Calls 112
- Viewing Walkie-Talkie Calls 113

Call Waiting 224

Caller ID 224

Calling

- Abbreviated Dialing 45
- Emergency Numbers 40
- End-of-Call Options 42
- In-Call Options 41
- Keeping Track of Calls 68
- Missed 40
- Nextel Direct Talk Calls 60
- Nextel Group Walkie-Talkie Calls 53
- Nextel Walkie-Talkie Calls 48
- Phone 38
- Phone Numbers With Pauses 43
- Plus Code Dialing 44
- Roam Call 39
- Speed Dialing 47
- Talkgroup Calls 57, 59
- Types of Calls 37
- Using the Member ID 49
- Using WLK-TLK Contacts 50

Camera 177–195

Clock Display 77

Contacts 120–136

- Adding a Phone Number 125
- Adding an Entry 125
- Categories 132
- Creating An Entry 125
- Date 127
- Distribution Lists 128
- Editing an Entry 129
- Email Address 124, 127
- Entry Consists Of 121
- Erasing 102, 133
- Filtering 123
- Finding Entries 122
- Finding Names 122
- Importing from SIM Card 135
- Memory Status 133
- Picture 126
- Ringer 126
- Saving a Number 43
- Services 136
- Speed Dial Numbers 123, 126
- Talkgroup 131
- Walkie-Talkie Groups 129
- Web Address 127
- Currency Converter 147
- D**
- Data Roam Guard 110
- Data Services
  - Data Profile 104
- Direct Talk 60
  - Code 62
  - Private Only 63
  - Receiving All Calls On Channel 64
- Setting Up 61
- E**
- Entering Text
  - Numbers 34
  - Symbols 34
  - Word English Text Input 32
- F**
- File Manager 151
- G**
- Group Walkie-Talkie Calls 53
  - Details 55
- H**
- Hearing Aid Compatibility 246
- K**
- Key Functions 11
- Key Shortcuts 86
- Keypad Sensor 76
- L**
- Language 88
- Location Settings 79
- Lock Code
  - Changing 96
- Locking Your Phone 96
- M**
- Media Player 196–202
  - Playing Video and Audio Clips 199
- Menu iv
  - Navigating 28
  - Selecting 28
  - Style 77
- Messaging

- Setting Alerts 80
- Multimedia
  - Channel Listings 198
  - Channel Options 197
  - FAQs 200

## N

- Nextel Direct Talk, see Direct Talk
- Nextel Group Walkie-Talkie Calls, see Group Walkie-Talkie Calls
- Notepad 145

## P

- Phone
  - Antenna 14
  - Basic Features 24
  - Front View 9
  - Inside View 10
  - Key Functions 11
  - Limiting Use 98
  - On and Off 23
  - Resetting 102
  - Setting Up 15
  - Status Information 26
  - Your Numbers 23
- Phone Settings 71–88
  - Any Key 87
  - Auto-Answer Mode 87
  - Call Answer Mode 87
  - Display Settings 75–77
  - Location Settings 79
  - Messaging Settings 80
  - Open 87
  - Shortcut 86
  - Sound Settings 72–75
  - Talk Key 87

- TTY Use 85
- Plus Code Dialing 44

## R

- Radio Frequency 238
- Ringer Types 72
- Roaming 105–110
  - Setting Roam Mode 108

## S

- Safety
  - Medical Devices 242
  - Radio Frequency 238
- Screensaver 78
- Security 92–104
- Send via WLK-TLK 51
  - Send Contact Information 52
  - Send Own Info 52
  - Setup 51
  - Sharing Groups 56
- Service 411 7
  - Account Passwords 5
  - Activation 3
  - Automated Invoicing 6
  - Operator Services 7
  - Setting Up 2
  - Sprint 411 7
  - Sprint Customer Service 6
  - Voicemail 4
  - www.sprint.com 6
- Set Time/Date 78
- SIM Card
  - Copying 134
  - Importing Contacts 134
  - Inserting 16
  - Locating 15



- PIN 93
  - Removing 17
  - Security 93
  - SIM Manager 133
- SMS Text Messaging 219–220
- SMS Voice Messaging 221–223
- Special Numbers 97
- Speed Dialing 47
- Sprint 411 7
- Sprint Customer Service 6
- Sprint Power Picture Mail
  - Downloading Pictures 195
  - Password 192
  - Uploading Pictures 195
- Sprint Power Vision
  - Security Features 103
- Sprint Voice Command 228–232
  - Address Book 230
  - Making a Call 231
- Status Light 76
- Stop Watch 145
- Storing Pictures 182

## T

- Taking Pictures 178–181
- Talkgroup 57
  - Join 58
- Text Greeting 75
- Themes 78
- Three-Way Calling 225
- Tip Calculator 146
- TTY Use 85

## U

- Unit Converter 148
- Unlocking Your Phone 96

## V

- Videos
  - Recording 185
- Voice Services 157–167
- Voice-Activated Dialing 158–167
- Voicemail
  - Menu Key 218
  - Options 215
  - Retrieving 214
  - Setting Up 4, 213
- Volume 74

## W

- Walkie-Talkie Button Light 76
- Walkie-Talkie Numbers 48
- Warranty 261–267
- WLK-TLK Contacts 50
  - Creating A Group 54
- Word English Text Input 32
- World Clock 144

## Free Manuals Download Website

<http://myh66.com>

<http://usermanuals.us>

<http://www.somanuals.com>

<http://www.4manuals.cc>

<http://www.manual-lib.com>

<http://www.404manual.com>

<http://www.luxmanual.com>

<http://aubethermostatmanual.com>

Golf course search by state

<http://golfingnear.com>

Email search by domain

<http://emailbydomain.com>

Auto manuals search

<http://auto.somanuals.com>

TV manuals search

<http://tv.somanuals.com>